

# The *New* Three *R*<sub>s</sub>

- every one will have to learn after a Nuclear War -  
or other world-wide catastrophe

*(but that most people aren't yet ready to even think about)*

1. Reconstruction - of society
2. Recovery - of production
3. Renewal - of religion

And a fourth *R* for the present -

4. Resources - for nuclear war survival

by Bruce M. Beach

Radiological Scientific Officer

## The Purpose Of These Pages

Our goal is to put essential information for reorganization, recovery and renewal - after a catastrophe such as nuclear war - onto this web site and onto one or two CDs and to make free distribution of these CDs in such a manner that they will be available to survivors of the catastrophe that we feel is now inevitable. While we do not know what form a catastrophe may take, still with the number of nuclear weapons that there are in the world, there is the very great possibility that it may be nuclear. We also realise that in the immensity and intensity of Divine Retribution the very equilibrium of the planet itself may be disturbed.

In the past we have assisted many hundreds of people in obtaining thousands of pieces of radiation detection equipment and we have given away hundreds of pieces to those who could not afford them. We simply no longer have the time to do that but we have stockpiled, tested and labeled hundreds of radiation detection devices (currently worth tens of thousands of dollars) that we will give away to those people that we have to turn away from the door of the shelter.

At that time - the Resources for Survival information on this site will be of considerably less use because we will be past the time to prepare but we have assembled survival guidance material to handout at the

door of the shelter to people for whom we have insufficient room in the shelter to accommodate. In December 2001 we completed a series of 4 twenty-minute videos, on such subjects as building an expedient shelter, which we hope to be able to show to the same group of people.

The plan is to train Radiological Instructors while in the shelter so that they can go out afterwards and train monitoring teams. Equipment has also been stockpiled for these teams.

For over forty years my wife and I have made an intensive effort to alert people to the threat and to urge them to prepare for it. I could never have done alone all that we have done together. For weeks she stood at my side and helped load two printing presses for imprinting of over one-hundred thousand booklets which we gave away absolutely free. Since the advent of the Internet untold thousands more booklets have been downloaded in a printable format for printing and distribution by many other people.

We used many ways of getting the information out to the public. We sent out tens of thousands of pieces of literature through the mails. We set up booths at numerous fairs, I appeared on many dozens of TV and radio programs, many of national and international scope, and there were so many newspaper and magazine articles written about the Ark Two that we long ago lost count. Literally, multiple millions of people heard about our efforts. And we have never charged anyone a penny for any of the information.

Once the Internet became popular, it surpassed all our other efforts of informing people. The interest in our web pages grew to where we get thousands of hits each day. Sometimes, at a period of particular interest it can be tens of thousands. Once, during one three hour period there were over 85,000 hits which completely swamped the system and the server had to pull the plug. Within hours our webmaster had the url rerouted to a new dedicated server directly on the backbone and we were back up. The site was eventually mirrored at over 30 locations. We have no idea how many hits daily there are on all the sites combined.

All this pales, however, compared to our present goal of making recovery information available for the survivors. It is doubtful that the Internet will be working as it is today but if segments of it can be gotten back up then perhaps some of the information can eventually be distributed over more local areas. For this reason we are going to try to get copies of the CDs out to widely distributed ISPs and ask them to retain them for installation on their servers afterwards. Another thought is if people can find a quantity of blank CDs they can take and duplicate the master CDs and distribute them about their geographical area so that those who can get a computer going with local emergency power - will be able to access the information. Any other strategies or suggestions for distribution would be greatly appreciated. We would like for this information to be shared as broadly as possible.

## Recovery Information

Some of our key web pages deal with measuring radiation in food and strategies of dealing with radiation in the soil and food chain. There is information available here that I am not aware of being available anywhere else on the web. It spans from the practical "how to" to the highly theoretical necessary for

professionals to set up laboratories. I am a Radiological Scientific Officer and I can assure you that this is the necessary and correct information.

Many of our web pages deal with the technical aspects of small scale farming such as seed saving, fertilizers, crop management and so forth - and many others deal with alternate energy sources and still other subjects necessary to successful small farming, which will have to be a main focus of recovery.

A great many of our resources deal with old Pioneering skills. We cannot just go back to the old ways. We have lost many of the skills. No one had them all then and you would be hard put today to find a wheelwright, a miller, a tanner, a barrel maker. All those trades, like farming, have advanced into modern technology and the present experts seldom have used the old ways. Many of the old implements are no longer around and we certainly don't have the horses. Modern horses are neither bred nor conditioned to pull the plow. Still, in the skills of the past we may find solutions to the problems of the moment.

Beyond recovery there are many web pages, that are a part of this collection, that deal with the subject of the Reconstruction of Society and the Renewal of Religion. These are issues to which men's thought will have to eventually progress but I shall not belabor the point in this overview.

## Our Library

Our personal library is very extensive. At one time I counted 13 encyclopedias. These are mostly specialized - like a 14 volume set on gardening and another 16 volume set on do-it-yourself repairs. There are others on health and medicine and a variety of other subjects.

We have also acquired CDs with hundreds of books and one summer put a crew to work microfilming thousands of documents which we have on microfiche. These, plus many many books, are in just our own home but our Ark Two Community librarian is the real gatherer of information - he has many thousands of books, mostly on technology for recovery.

In the future, when people want it, we hope to be able to disseminate all this information widely. There are many blind spots in our library. We have little information on modern technology and almost no information on leading edge technology. Members of our Ark Two community are of far more than average knowledge about nuclear and computers but there are many, many fields such as in modern metallurgy, petroleum refining, hundreds of specialties in chemistry, medicine, and untold numbers of other areas that the expertise to re-establish them will have to survive with the experts - if they are going to be recovered in the immediate decades following.

One major focus of our library has been maps, in order to determine where that expertise may reside. We have thousands of maps. Local road maps. Topographical maps. More and more maps on an expanding scale. We have every map ever published by the National Geographic. We have CDs with map search programs. North American and World Atlases. The list goes on. One map set which we were very desirous of obtaining cost thousands of dollars (far beyond our budget) from the US government. It

comes with a subscription program for real-time updating and the printed book is reprinted annually. A marvelous tool for demographers tracking changing patterns - but one used copy would serve our purposes. Miraculously, on the Internet we found a library discard copy - at a fraction of the cost.

Other associates of ours are providing us with gigabytes of survival information on CDs. Our problem has not been so much one of obtaining information but determining on which to concentrate our limited resources for storing and cataloging. Tons of information is of no use, if you have no way of finding what you want in it. In early years we were given literally tons of new books by libraries and publishers. Expensive new technical volumes that often cost over a hundred dollars each - but we finally had to abandon that effort simply because of lack of storage space and manpower to handle it. Tons had to be destroyed simply because we could not, even with weeks of searching, find a way to transport them to Third World countries who were desirous of having them.

So the problem of the moment has not been getting information but one of determining which information is going to be most useful to survivors. What we offer in these pages, measuring radiation contamination in food, producing food without the modern technology and its skills, finding alternate sources of energy, recovering and repairing remaining machinery, creating the nucleus of an economic system and restoring the basis of functioning society - information on how to do these things - are what we feel will be most needed at the outset. It is our sincerest hope that we will be able to get it to the people who need it and that they will find it useful.

Click here to return to the [Top](#)

## 1. Reconstruction of Society after Nuclear War

Since most people think that all-out nuclear war is not survivable, either individually or for society, and since somehow most intellectuals feel that to make positive plans for its aftermath would seem to somehow advocate or condone it - there is absolutely no scholarly discussion on this subject. In these pages I give some direction for the

[Reconstruction of Society](#)

along with critiques of ideas on the

[New World Order](#)

and my personal predominant area of effort - which is the development of the

[World Language Process](#)

The "Reconstruction" Site Map

is immediately below

## **RECONSTRUCTION SITE MAP**

### **Reconstruction of Society After Nuclear War**

#### **Immediate Reconstruction of Local Society**

**Martial Law: Domestic Support Operations**

**Martial Law: Reconstruction of Social Order**

**Martial Law: Internment and Resettlement Operations**

**Camps: Standards for Building Refugee Camps**

**Health: Field Hygiene and Sanitation**

**Toilets: Unsewered Toilets**

**Rescue: Basic Rescue Skills**

**Death: Mass body disposal**

**Dead Animal Disposal**

**Animal Disposal During an Epidemic**

**How To Make A Fumigating Mask**

**How To Make An Emergency Gas Mask.pdf**

**Danger of Dog Packs**

**Medical: Emergency Medical Facilities**

**Medical: When There is No Doctor - Locked**

**Medical: When There is No Dentist - Locked**

**[LETS: Reconstruction of the Economic System](#)**

**[Carnegie: Management of Large Scale Enterprise - Table of Content](#)**

**[The Gospel of Wealth - A Baha'i Perspective](#)**

**[Introduction by Harvard Editor](#)**

**[Chronology of Carnegie's Life](#)**

**[Carnegie's Introduction](#)**

**[THE PROBLEM OF THE ADMINISTRATION OF WEALTH](#)**

**[THE BEST FIELDS FOR PHILANTHROPY](#)**

**[The Advantages of Poverty](#)**

**[Popular Illusions about Trusts](#)**

**[An Employer's View of the Labor Question](#)**

**[Results of the Labor Struggle](#)**

**[Distant Possessions: The Parting of the Ways](#)**

**[Americanism versus Imperialism - Part I](#)**

**[Americanism versus Imperialism - Part II](#)**

**[Democracy in England](#)**

**[Home Rule in America](#)**

**[Does America Hate England?](#)**

**[Imperial Federation](#)**

## [The New World Order - An Introduction](#)

[The New World Order - A Philosopher's View](#)

[Quotes by Presidents & Famous People](#)

[Quotes by Other Famous People](#)

[A Proposed New World Order Constitution](#)

[Opposition to the New World Order Constitution](#)

[History of The New World Order](#)

[Hoax regarding The New World Order](#)

## [The World Language Process](#)

[Mission of The World Language Process](#)

[History of The World Language Process](#)

[Projects of The World Language Process](#)

[Regularization of English Syntax](#)

[Angel Tongue Tutorial](#)

[Example of Angel Tongue](#)

[Anjel Arabic Representation](#)

[Inactive Webpal Example](#)

[344 Chess Games](#)

[Chancellors of the World Language Process](#)

[The ACCESS System](#)

[Criticisms of The World Language Process](#)

[Frequently Expressed Comments](#)

[Essays on Language](#)

[Lango](#)

[Lango - Introduction and Directory](#)

[The Origins and Spread of English](#)

[English as an Auxiliary Language](#)

[English as a Primary Language](#)

[English and Other Languages](#)

[The Constructed Languages](#)

[The International Auxiliary Language](#)

[The International Language Committee](#)

[Constructed and Organic Languages](#)

[Language in Education and the Media](#)

[Orthography and Orthoepy](#)

[The Language of Empire](#)

[Pidgins and Creoles](#)

[LANGO Grammar](#)



[LANGO Vocabulary](#)

[LANGO Phonology](#)

[LANGO Orthography](#)

[History of English Spelling Revision](#)

[A Suggestion Towards Orthographic Reform](#)

[International Pronunciation and Accent](#)

[Names and Organisation](#)

[Glossary](#)

[WLP proposal to the UHJ](#)

[Essay on Baha'i UAL Teachings](#)

[Short references in the essay](#)

[Bibliography used in the essay](#)

[Raw quotes used in the essay](#)

[Letter to the UHJ on the subject of gender](#)

[UHJ on the subject of gender](#)

[Essential World English](#)

[Prospects for the World Language Process](#)

[Picture Gallery](#)

[China Goals](#)

## [China and Volunteer Teachers](#)

### [2. Recovery from Nuclear War](#)

This is the page that I am currently trying hardest to interest people in. It has to do with *individual* recovery after a nuclear war and deals primarily with the subject of *agriculture*. For those who have prepared for nuclear survival this is the next level of thought.

The "Recovery" Site Map  
is immediately below

#### **RECOVERY SITE MAP**

### [Individual Agricultural Recovery After Nuclear Holocaust](#)

#### [Radiation in Food](#)

[Layman's overview on Radiation in Food](#)

[Shorter letter on radiation in Food.](#)

[Explanation by a microbiologist](#)

[Radiation Risk and Ethics](#)

[Manual of food quality control - radionuclides in food](#)

[Removal of Strontium 89 and 90 from milk](#)

#### [Farming After A Nuclear War](#)

[Gathering Information for Farming After A Nuclear War](#)

[Protection of Food and Agriculture From Nuclear Attack](#)

[Fallout on the Farm](#)

[The Have More Plan](#)

[Basic Seed Saving](#)

[Humanure Handbook](#)

[Humanure Handbook in .pdf format](#)

[The Organic Way to Mulching](#)

[Fence Planner for the Common Sense Fence](#)

[Pressing Oil from Seeds](#)

[Build Your Ark](#)

[The Farmstead Book](#)

[Grow Friuts & Vegetables The Way They Used To Taste](#)

[Advanced Seed Saving](#)

[Alternate Energy](#)

[Make Your Own Electricity](#)

[Overview of Making Your Own Electricity](#)

[Bicycle Power](#)

[David Butcher Pedal Powered Generator](#)

## [A Quick and Dirty Pedal Powered Generator](#)

### [How to make low RPM generators!](#)

#### [Comparison of Alternators and Generators](#)

#### [Wooden Low RPM Alternators](#)

#### [Alternator from Scratch](#)

#### [Making a generator/alternator from a brakedrum](#)

#### [Brakedrum update](#)

#### [Forcefield Low RPM Disk Alternator](#)

#### [Making a Volvo Front Brake Disk into a Generator](#)

#### [Wood Axe - A very simple wind generator](#)

#### [Homebrew Windgenerator](#)

#### [All the plans and information for another wooden one](#)

#### [A key set of plans to study](#)

#### [Additional Info on Coils](#)

#### [Making a Microwave Oven into a Generator](#)

#### [Testing your theories](#)

### [How to make a lawnmower into a generator.](#)

### [Windpowered Generators](#)

#### [Towers](#)

## [Tower Design](#)

### [Blades or Propellers & our own design sketches](#)

### [Technical Information on How to Build Blades](#)

### [Still More Information on How To Build Blades](#)

### [Some Neat Diagrams on Blade Design](#)

### [A Blade in One Hour](#)

## [Tails](#)

### [Some pictures of a tail mounting](#)

### [Overall Design Concepts that includes tails](#)

### [More Overall Design Concepts that includes tails](#)

## [Testing tails](#)

### [Building your own anemometer](#)

## [Waterpowered Generators](#)

### [The Large Waterfall at Ark Two](#)

### [The Smaller Waterfall at our Home & Theory of Systems](#)

### [Using Pumps as Turbines](#)

## [Making Motors into Electrical Generators](#)

## [Diesel and Gasoline Electrical Generators](#)

## [Batteries](#)

## **Bicycle Power**

### **Not Just For Riding**

## **Woodgas**

### **Woodgas pdf file**

## **Biofuel**

### **Make Your Own Biodiesel**

### **Make Your Own Biodiesel - Part 2**

### **Foolproof Way to Make Biodiesel**

### **Using Straight Vegetable Oil**

### **Separating Glycerine/FFAs**

### **From the Fryer to the Fuel Tank**

### **Pressing Oil from Seeds**

## **Stills**

### **How Distillation Works**

### **Building a home still**

### **Running on Alcohol**

### **Making it on the Farm**

### **Still Safety**

### **The Manual For the Home and Farm Production of Alcohol**

## Solar

[Overall Survey of Solar Cookers](#)

[Survey of Box Solar Cookers](#)

[A very simple solar cooker design](#)

[Make hotwater with the sun even in cold climates](#)

[Build Your Own Solar Water Heater](#)

[Solar Hotwater Heating - A DIY Guide](#)

## Simple Technology

[The Basic Principles of Machinery](#)

[Descriptions of Simple Machines](#)

[Patterns for Simple Farm Devices](#)

[The Scythe - A tool of the centuries](#)

[Blacksmithing - An essential technology](#)

[How to build your own alternator regulator](#)

[How to build a float switch](#)

[How to do a gas to propane conversion](#)

[How to convert flashlights to use LEDs](#)

## Pioneer Methods

[Making the Best of Basics](#)

## [Cloudburst - Handbook of Rural Skills and Technology](#)

### [Cloudburst Two](#)

### [Foxfire One](#)

### [Foxfire Two](#)

### [Foxfire Three](#)

### [Foxfire Four](#)

### [Foxfire Five](#)

### [Foxfire Six](#)

## [3. Renewal of Religion after Nuclear War](#)

Nothing occurs except by the Decisive or Permissive Will of God. Many will ask - if God is Good why did He permit a nuclear war? From the link in the above title I answer that question and present a number of short religious essays intended to help people fulfill God's Divine Purpose coming out of the nuclear war.

The "Renewal" Site Map  
is immediately below

**[RENEWAL SITE MAP](#)**  
**[Renewal of Religion](#)**

**[Why God Would Permit Nuclear War](#)**



## Essays on Religion - Premises

### Problems of Prophecy

Mother Shipton

Ouiji

Plants One

Plants One Two

Straight Arrow

The Iching

The Seeker

My Declaration

### Four Types of Souls - Content

Four Types of Souls - Introduction

The Soul of Self

The Soul of Love

The Soul of Reason

The Soul of Reason

### Four Paths to Truth

Authority

The Senses

[Reason](#)

[Intuition](#)

[The Most Clear Proof - Contents](#)

[The Most Clear Proof - Introduction](#)

[The Most Clear Proof - Numbers](#)

[Jesus](#)

[2300 Days](#)

[1844](#)

[Responses](#)

[Where](#)

[When](#)

[Manifestation](#)

[Revelation](#)

[First Step](#)

[Next Steps](#)

[Final Step](#)

[Final Analysis](#)

[The Seven Churches](#)

[Searching the OCEAN of God's Word](#)

[Meditation and the Path of Prayer](#)

[Prophecies in the Stars](#)

## [4. Resources for Survival of Nuclear War](#)

In recent years this subject has been the main entry page to this site. All the pages of survival material are still here and you can go to them by clicking on the above heading.

The "Resources" Site Map  
is immediately below

### **RESOURCES SITE MAP**

## [Resources for Survival of Nuclear Holocaust](#)

[State by State - Survival Information](#)

[Nuclear Power Plants](#)

[Links to Target Maps \(+ survival info\) of All 50 States](#)

[Target update information](#)

[The Ark Two Community](#)

[Map of the Interior of the Shelter](#)

[Map to the location of Ark Two](#)

[Pictures of the Inside of the Shelter](#)

[Pictures of the outside of the Shelter](#)

[Pictures of the Shelter Construction](#)

[Life in the Ark Two Community](#)

[Ark Two Programs](#)

[The Ark Two Community TEAM leaders](#)

[Radiation and Detectors](#)

[Official Government Detector Instructions](#)

[My explanation - with pictures](#)

[Understanding Radiation](#)

[How to build a KFM](#)

[Free Books for Downloading](#)

[You Will Survive Doomsday - HTML](#)

[You Will Survive Doomsday - .pdf](#)

[11 Steps To Survival - HTML](#)

[11 Steps To Survival - .pdf](#)

[Your Basement Fallout Shelter - .pdf](#)

[Fallout On The Farm - .pdf](#)

[Nuclear Weapons Defense Manual - .pdf](#)

[Nuclear Weapons Defense Manual - Tables - .pdf](#)

[Nuclear Weapons Effects - Radiological Scientific Officers Handbook - .pdf](#)

[Nuclear War Survival Skills - \(replica\)](#)

## [Ark Two Programs](#)

[Overall Purpose of the Programs](#)

[Survival Education](#)

[Agricultural Recovery](#)

[Radiological Monitoring Equipment](#)

[Economic recovery](#)

[KI Potassium Iodide](#)

[State by State Recovery](#)

[Family Registry](#)

[Information Broadcast](#)

[Social Reorganization](#)

## [Shelter Building \(+ offsite links\)](#)

[A two bus shelter for 24 people](#)

[Easy Printing Plans for a Basement Shelter](#)

[\(offsite links for bug out kits\)](#)

[\(offsite link for KI - Potassium Iodide\)](#)

**Filtering Air in a shelter**

**Kearny Air Pump**

**Ventilation**

**Free Consultation on Shelter Building**

**MENU: [HOME](#) » [Reconstruction](#) » [Recovery](#) » [Renewal](#) » [Survival](#)**

## World Language Process Home Page

[Join our mailing list!](#)

[Mission and Organization of  
The World Language Process](#)

[History of  
The World Language Process](#)

[Projects of  
The World Language Process](#)

[Directory  
of World Language Process  
Directors and Chancellors](#)

[The ACCESS System](#)

[Criticisms of the WLP & FEC](#)

[Our list of  
Language Essays](#)

[Photo Gallery!](#)

[Our CHINA GOALS](#)

[Volunteer Teachers  
wanted for China](#)

To reach us by email write:  
[coordinator@webpal.org](mailto:coordinator@webpal.org)

**MENU: [HOME](#) » [Reconstruction](#) » [Recovery](#) » [Renewal](#) » [Survival](#)**

**MENU: [HOME](#) » [Reconstruction](#) » [Recovery](#) » [Renewal](#) » [Language Main Page](#)**

## World Language Automated Mailing (discussion) List.

Take part in discussing the evolvement of the World Language Process!

The forum is moderated - which means all correspondence goes through the moderators so you won't be plagued with a volume of correspondence. The moderator tries to combine discussions and keep out redundancy so as to keep the correspondence brief.

This list is the place to keep informed of ongoing World Language Processes and to participate as a volunteer. It presently replaces our other discussion lists, volunteer lists, teacher lists, and participant lists until the program becomes further developed and implemented.

To join the list  
[CLICK HERE!](#)

[Return to World Language Process](#)

**MENU: [HOME](#) » [Reconstruction](#) » [Recovery](#) » [Renewal](#) » [Language Main Page](#)**

---

---



## Description of the World Language Process

**The primary mission statement of the World Language Process is:**

*To further world peace through the world understanding  
which will be achieved by having One World Language.*

The primary philosophical goal of the World Language Process is a Universal World Language. As a stage towards that goal it seeks to promote the concept of a Universal Auxiliary Language (AIL -Auxiliary International Language, IAL - International Auxiliary Language) that everyone would learn in addition to their mother tongue.

The concept or goal of a IAL has not yet reached a kindling point in the consciousness of humanity or its leaders. Until such a kindling point occurs, the World Language Process, in addition to trying to raise that consciousness, is trying to identify concepts, experiments, and efforts that are directed towards or supportive and compatible with the goal. These it tries to support and learn from. It is hoped that at not some too far off future day there will be broader desire for this information.

**The current secondary mission statement of the World Language Process is:**

*To further world literacy and communication through the ACCESS Project.*

To obtain experience in the methodology of developing an IAL, the World Language Process has put extensive effort into the the development of the ACCESS System (Auxiliary Closed Captioned English with Simplified Spelling) and its ANJeL Tun as described below. However, it should be emphasized that the World Language Process is in *NO* way 'solely committed' to the ANJeL Tun and that it will willing, happily and cheerfully support instead any IAL that humanity may select.

However, in the interim, with the ACCESS System we hope to provide economically deprived individuals in developing countries an opportunity to learn to speak English as a second language so that they may improve their economic situation.

## **Organization of the World Language Process**

The World Language Process is a non-profit organization with Chancellors in over 30 countries and hundreds of volunteers throughout the world. Its members are dedicated to furthering world peace through education, literacy and world understanding.

The World Language Process is neither officially or unofficially associated with any religious or political organization of any kind and has no hidden agenda. It is a program of UNKOMMON (UNiversala KOMmunikado por la MONdo-Esperanto for "Universal Communication for the World") Foundation, which is dedicated to supporting attempts towards a universal auxiliary language, and it is a project of the IAEWP (International Association of Educators for World Peace) which is an NGO to the United Nations since 1973 and UNESCO since 1975.

**MENU: [HOME](#) » [Reconstruction](#) » [Recovery](#) » [Renewal](#) » [Language Main Page](#)**

---

---

## History of the World Language Process and this IAL effort.

- Ten years of computer and language research by the vision holder starting at the
- 1964-** University of Oregon (**1964**) through a NUL Chevron Fellowship (**1966**) a NUL IBM  
**1974** Fellowship (**1968**) a Canadian Federal grant (**1971**) and an Ontario provincial grant (**1974**).
- 1975** Designation of the **Universal Language Institute** site as being **Bahji du Canada**.
- 1978** Formation of **UNCOMMAN Association** by 1978 Wintario grant.
- 1984** UNCOMMAN *incorporates federally* as **UNKOMMON Foundation**, a *non-profit organization*.
- 1985** Start of design of the building for the Universal Language Institute at Bahji du Canada.
- 1988** The Universal Language Institute design wins first place award for Canadian Architecture.
- 1989** The **ACCESS Project** begun by the **ACCESS Colloquium** which consisted of the President of The American Literacy Council, The Director of University Systems for Sperry Rand Corporation, The Director of the Modern Languages Department at the Ontario Institute for Studies in Education at the University of Toronto, The President of the Canadian National Captioning Centre for the deaf, and a number of university professors.
- 1990** The Canadian Federal Government gave the ACCESS Colloquium an initial grant. In order to cash the grant check the Colloquium had to incorporate and today operates under the style of **ACCESS Colloquium Incorporated**.
- 1991** Through the government grant and generous community support amounting to several hundred thousand dollars the ACCESS Project shot thirty hours of Betacam SP video tape.
- 1992** The ACCESS Project developed the first software for translating scripts into the FXNeTiK spelling used for captioning in the ACCESS System and analyzed and evaluated video editing equipment. The project was delayed by waiting for manufacturers to develop a promised Nonlinear Online Video Editing Lab (NOVEL) technology that was necessary for the completion of the project.
- 1993** The ACCESS Project obtained use of the first AVID Media Suite Pro sixty-field/thirty-frame per second NOVEL system installed in Canada. This system was installed at the **Canadian National Captioning Centre for the deaf**, for the purpose of working on the ACCESS Project, and this is where the work continued until May 1995. 1993 also saw the development of the **World Language Process** concept by the UNKOMMON Foundation and preparation for its decision to use the ACCESS system for this program.

**1994** The World Language Process was accepted as a *project* by the **IAEWP** (International Association of Educators for World Peace). The IAEWP has been an **NGO** of the **United Nations** since 1973 and of **UNESCO** since 1975.

Proposals were sent to twenty-seven provincial governors in Thailand. Each of these governors received a presentation on the World Language Process, under the aegis of the Royal Consulate of Thailand in Canada, while they were in Canada. By the end of 1994 eighteen teaching positions were available in Thailand for WLP teacher volunteers.

In December the first hour of the ACCESS videos, consisting of six lessons, along with a drill tape, was completed and delivered to the University of Kansas for evaluation. Also in December a letter was sent to each of the national chancellors in the ninety-one member countries of the IAEWP, inviting them to participate as chancellor for the World Language Process and by December 31st sixteen countries had World Language Process chancellors appointed.

**1995** The editing equipment was moved to a video school location and the World Language Process had assigned to it, by the Toronto Municipal Job Incentives Program, for six months, four full time editors. There was a considerable learning curve in learning to use the editing system, in the training of a half dozen editors, and in the development of the icons, formats and standards to be used in the videos.

By the end of the year, six hours of video had been edited and the project had trained over 60 people in non-linear editing, nine of which proved capable of actually doing the project. At this time the project lost access to the original editing equipment but the video digitizing boards for another system were donated to the WLP by the AVID Corporation.

**1996** There were over sixty volunteers for the overseas teaching program and a total of over 100 program volunteers. There were World Language Process Chancellors in 28 countries and over 100 teacher positions available in four countries. It had been demonstrated that both teacher volunteers and teaching positions were readily available.

- a. A 40,000 word simplified dictionary had been scanned in preparation for editing.
- b. Item selection had been made for a 4800 word picture dictionary.
- c. The first five of ten teacher correspondence lessons had been written.
- d. The first four of twenty student workbooks have been written.
- e. A layout mockup has been completed for the student workbooks.
- f. Arrangement had been made with Project Gutenberg to use its machine readable texts and to store the ACCESS dictionary on their system.

**1997** The World Language Process went on the World Wide Web.

Because of the Web, The World Language Process, for the first time, achieved a level of over 500 volunteers.

With Sally Ward doing most of the data entry, over 80 editors were able to create sentences for the 40,000 definitions in the dictionary and the dictionary data base was implemented.

Roz Rus edited the 44,000 words on the Angel spelling list.

David Hatch developed and installed the first web on-line Angel Translation program for the web.

In September of 1997, Shawn Beilfuss has taken over guidance of the Comic Book Project.

**1998** - In the early part of the year, Alex Nauda directed us to the Carnegie Mellon Institute word list, and by mid year there was completed the major effort of merging it with the Rondthaler/Lias list and converting them both to Angel FXNeTiK spelling.

By August of 1998 the World Language Process had chancellors in over 30 countries and Sally Ward became the Chancellor Administrator and editor of the Chancellor News letter.

In December the editors completed syllabifying 815 merged word list files of fifty words each.

**1999** By March of 1999 a number of translators, the world over, helped in translating the 18 languages that appear on the Web Pal pages at:

[Web Pal](#).

Brett Holt wrote an improved Windows 95 program for on-line ANJeL Tun translation which is able to translate to both Angel and NES (New English Spelling). The latter is under the guidance of Ron Footer in London England and is used by the ACCESS project as Bridge English. There were developed a suite of free analyses programs for researchers wishing to do research on the Angel and NES fonetic spelling lists.

We created our

[essays location](#)

on our website and archived (among others) LANGO by Robert Robert Craig & Antony Alexander of the Isle of Man.

Antony Alexander and Dr. Steve Bett, along with Roslyn Rus, Douglas Worthingham, and

some others started reviewing [Regularization](#) for the ACCESS System.

**2000** Almost the whole of the year 2000 was spent in a gigantic project of supplementing our definition data base with three more dictionaries, one of them being the unabridged Webster's International Dictionary. All three were digitized and checked for order and spelling.

A significant effort was made to become an independent NGO member of the United Nations. Our president submitted by the stated deadline the required application on our letterhead, but no response was obtained.

We also made a study into using [Arabic Characterization](#) for the ANJeL Tun.

In the fall of the year the Bahji Memorial was extensively landscape. The placing of the natural red stone was accompanied by a Metis Ceremony conducted by the National Chairman of the Southern Metis.

**2001** A follow up phone call regarding our United Nations application determined that it had been received but that because of limited resources due to lack of funding they had not been able to process all the applications.

The year 2001 saw a major effort to reorganize our web pages and move them to a new server.

The major task in 2001, was to merge all the dictionary data bases into one and to rationalize them with the word lists.

**2002** In 2002 at the future site of the Universal Language Institute we had the first annual World Language Process picnic with a tree planting activity to plant 88 new trees. There was attendance from 3 States in the US and 2 Provinces in Canada.

We once again did a major reorganization on the web pages and moved them to a still faster server.

The major task in 2002, continued to be to merge all the dictionary data bases into one and to rationalize them with the word lists. Two volunteer programmers worked on the project.

There was appointed a Chancellor for Japan and a professional paper was presented at the JALT Conference by Professor Jonathan Britten.

A major arrangement was made for the placing of volunteers into China and information about that program was incorporated into the web pages.

Video editing technology made a considerable advance during the year. Reasonably priced non-linear editing programs with much greater capability became much more available and new video cameras with direct DVD storage capabilities appeared to be on the verge of integration with them.

During the year we also began the study of animation capabilities.

**2003** In 2003, at the suggestion of Professor Britten, the name World Language Program was changed to the name World Language Process, as being actually more reflective of the process of investigation, research, development - and promotion - of the concept that there should be a universal language and what it should involve - and how it should evolve.

Application was made to the 2003 JALT conference for a second presentation about the World Language Process.

The ongoing study of animation processes, synthetic generation of voices, TTS (Text To Speech) technology, talking heads and so forth received the assistance of several notable experts.

The possibility of cooperation with AT&T in developing videos with VTTS (Visual Text to Speech) technology, for training Chinese personnel for the Olympics in China, was undertaken with the appropriate director at the AT&T Research Laboratories.

The World Language Process presence on the web was further extended with its being mirrored at two other North American locations. Both the present web site and one of the new sites has a T1 available and the second North American mirror site has dual T3s. The need for this massive amount of bandwidth was necessitated by the primary site being overwhelmed on two occasions because of demand in connection with catastrophic threats for which it also provides support and response materials. The one occasion saw over 85 thousand hits in less than 3 hours.

At the time of this writing, arrangements are being made for the distribution of the web site by CD to other parts of the world so that at a future time it may be implemented on websites there.

The major tasks being performed at this time are the further development of the elemental lists, the investigation of script theory, and the study of animation and voice synthesis technology.

With Thoughts and Efforts for Peace

Bruce Beach - Coordinator

language@webpal.org

February 11, 2003

**MENU:** [HOME](#) » [Reconstruction](#) » [Recovery](#) » [Renewal](#) » [Language Main Page](#)

---

---



**MENU:** [HOME](#) » [Reconstruction](#) » [Recovery](#) » [Renewal](#) » [Language Main Page](#)

From late 1998 through 2001 the many projects of the World Language Process have had to share time resources with other priorities of the World Language Process coordinator. Because of millennialist concerns and the worsening world geopolitical situation, particularly in the Middle East, a considerable portion of his time and effort has had to go into the Ark Two Project.

The world's inhabitants and their leaders have so far shown little (more truthfully - practically no interest so far) in the development of an IAL (International Auxiliary Language). Nevertheless, the World Language Process continues to devote what resources it can obtain - to the following projects.

## Projects of the World Language Process

<p><a href="#">Web Pal</a> (explained)</p> <p><a href="#">Example</a></p>	<p><a href="#">ACCESS System</a></p> <p><a href="#">Videos</a></p> <p><a href="#">Student Workbooks</a></p> <p><a href="#">Teaching Manuals</a></p> <p><a href="#">Teaching Kits</a></p>	<p><a href="#">ANJeL Tun</a></p> <p><a href="#">Tutorial</a></p> <p><a href="#">Online Translator</a></p> <p><a href="#">example</a></p>
<p><a href="#">Dictionary Project</a></p> <p><a href="#">Database</a></p> <p><a href="#">Search Programs</a></p> <p><a href="#">Spelling Converter</a></p>	<p><a href="#">Regularization Project</a></p>	<p><a href="#">Keyboard Project</a></p>
<p><a href="#">Script Project</a> (Arabic/ANJeL representation)</p>	<p><a href="#">Volunteer Program</a></p>	<p><a href="#">Teacher Program</a></p>

[Universal Language Institute](#)[Project Gutenberg](#)[Model Pictures](#)[Essays](#)[Comic Book Project](#)[Memorial](#)[Picture](#)

## Web Pal

Web Pal was a working system, but it is not currently. Someday, it will hopefully again be operative. Below is its history:

The definition of the Web Pal project has come full circle. Initially the concept was to match teachers and pupils for an IAL. Because no IAL officially exists, as yet, we thought to match teachers and students of English. This idea struck many as being too colonialistic or linguistically imperialistic so we enlarged upon it to match teachers and students in any language that they desired. The Web Pal idea is sort of a pen pal idea, but over the web. People would correspond with people in the language of interest and thereby learn the language.

While many hundreds of hours were put into this project, it proved too cumbersome to handle. There was lots of expressed interest, whole highschool classes from Japan for instance, and many North Americans who liked the idea of having web friends elsewhere in the world. However, the coordination of the project just became too cumbersome. We tried having sub-coordinators for various language groups and geographic areas. And we went through four overall coordinators - but it proved to be just too great a burden and we couldn't make it work.

We also tried to automate the process, with machine readable forms and a database program. Hundreds of hours went into that effort also. With our limited resources we had to just finally give up on it and chalk it up to a learning process. In the future, with just people interested in teaching or learning the ANJeL Tun,

or some universally accepted IAL, we hope to be able to use the experience that we have gained in again implementing an automated system.

You can look here at what

### [Web Pal](#)

looked like. The forms do not presently work but this will give you an idea of what we did in the past - and of what we hope to do in the future.

- Numbers of translators, the world over, have helped in translating the 18 languages that appear on the Web Pal pages but we would still like to translate the following languages:

Hindi, Hebrew, Bengali, Panjabi, Javanese, Bhari, Telugi, Marathi, Malay, Urdu, Turkish. They would then cover all the worlds most populous language groups.

### **ACCESS System**

The ACCESS (Auxiliary Closed Caption English with Simplified Spelling) System is described in more detail on [another page](#).

### **Videos**

18 one hour long videos are being made to teach the ANJeL Tun

### **Student Workbooks**

18 student workbooks are being prepared one for each of the 18 hours of video

### **Teaching Manuals**

18 teacher manuals are being prepared one for each of the 18 hours of video

## Teaching Kits

18 teaching kits are being prepared - one for each of the 18 hours of video. These are part of the ACCESS pedagogical method, that emphasizes a word/action relationship.

## ANJeL Tun

The ANJeL Tun is currently a part of the ACCESS Project and is described in some detail [there](#). There is also a [Tutorial](#) for anyone who like to actually be able to read the ANJeL Tun.

## Online Translator

There is also an Translator Program that we have had on line twice in the past, but which needs to re-installed. This program is actually capable of translating into any phonetic representation of English. Here is an [example](#) of a translation from one of the earlier versions of the translator program.

## Dictionary Project

The longest ongoing project of the World Language Process has been the that of developing the tools to create dictionaries. A number of different dictionaries are envisioned. A BASIC 8,000 word phonetic/pictorial dictionary and a more extended one of 40,000 words. The key concept behind both these dictionaries is that they use a very limited set of words in the definitions. Beyond these limited dictionaries, it is hoped then to make specialized dictionaries, still using phonetic spelling and the basic vocabulary, for specialties in science and the arts.

## Database

Developing the dictionary and spelling data bases has been the

most consuming activity. Four dictionaries and two phonetic spelling lists have been acquired and formatted and the final task of merging them into a single data base is under way.

## **Search Programs**

There are a variety of search programs that allow one to do a comparison of word lists, find out how often words are used in definitions, and to find words containing particular character string (and in particular positions such as prefixes and postfixes).

## **Spelling Converter**

The spelling converter works differently from the translator, in that it allows one to establish the rules by which phonetic conversion is to take place. Its output is actually the spelling database for the translator program. Where there are homographs of the word then it provides alternative targets.

## **Regularization Project**

The Regularization Project has been under the direction of Antony Alexander on the Isle of Man. It is an ongoing dialog which welcomes any knowledgeable participants. For a part of the discussion - look at:

### **[Regularization](#)**

## **Keyboard Project**

The Keyboard Project has been studied in depth and resolved in principle. Computer programs have been found that permit the assignment of any character to any key. The ANJEL Tug uses only 39 phonemic characters (compared to English which uses 52) and this permits a "shiftless" keyboard. Furthermore, using the Dvorak ergonomic principles we have done letter frequency and

adjacency studies to develop optimized layouts. Until there is a universal language and script selection such information and methodology, however, remains academic.

## **Script Project**

Even more academic than keyboard layout designs, has been the study of character representations themselves. One such effort has been an attempt to study the feasibility of English sounds with Arabic characters having the same phonetic target. If this interests you, You can view this attempt at:

[Arabic/ANJeL representation](#)

## **Volunteer Program**

The World Language Process has had a strong volunteer program with hundreds of volunteers. They have worked on many projects from making the videos to editing the dictionary database. All the World Language Projects are done by volunteers. To become more informed about our volunteer program and changes in it, as they take place, [please join our mailing list!](#)

## **Teacher Program**

The World Language Teacher program has already received hundreds of volunteers, along with requests for hundreds of teachers from many countries. Our goal is to make the ACCESS System available world wide but it has to first be further developed. In the interim we are doing a cooperative teacher placement program with CNteach in China. For more information about that look at [China Teach](#). To stay aware about the status of the program [please join our mailing list!](#)

## **Project Gutenberg**

Michael Hart at the University of Illinois has made one of the great contributions to the age with his Project Gutenberg. Through his complete dedication and the

monumental effort of a great many volunteers, much of the worlds classical English writings have been digitized and made available in the public domain. Michael has been a superb supporter of The World Language Process for many years and has said that he will arrange for translations from the World Language Process translator to be stored in the Project Gutenberg database.

## **Comic Book Project**

The comic book program has been under the direction of Shawn Beilfuss since September of 1997. Shawn has had extensive experience in the field and has traveled to Japan in his studies of comic books as an art, communications and education form. We have developed a number of scripts for a character called "Shoe Boy" and the intention is to reinforce the ANJeL Tun or an accepted IAL using this medium.

## **Universal Language Institute**

The Universal Language Institute of the UNKOMMON Foundation won the first prize for Canadian Architecture in 1988. Here you can see a [picture](#) of the model and the [Memorial](#) associated with it.

## **Essays**

The World Language Process has accumulated a few [essays](#) on the subject of IAL, but would like to store at this site any other contributions anyone would like to make along with any proposals for an IAL.

[Return to Main WLP Directory](#)

**MENU: [HOME](#) » [Reconstruction](#) » [Recovery](#) » [Renewal](#) » [Language Main Page](#)**

---

---

Web Pal is designed as a free service to match email pen pals throughout the world - but the service is NOT presently active.

# Web Pal

[World Language Program](#) is still under major development.

My language is:  
[English](#)

Ma langue est:  
[le Français](#)

Mi lengua es:  
[Español](#)

زبان من  
فارسی است

لغتي هي:  
العربية

МОЙ ЯЗЫК:  
РУССКИЙ

Mit sprog er:  
[dansk](#)

Moim językiem jest:  
[polski](#)

La mia lingua:  
[è italiano](#)

나의 언어는  
한국어

我的语言是:  
华语

ภาษาของฉันคือ  
ภาษาไทย

Meine Sprache ist:  
[Deutsches](#)

Ang aking lengguwahe:  
[Tagalog](#)

Minha língua:  
[é português.](#)

Ngôn ngữ của tôi là:  
Vietnamese

私の母国語は  
日本語です

Mitt språk är:  
[Svenska](#)

The language:  
[Hindi](#)

is not yet done.

The language:  
[Hebrew](#)

is not yet done.

The language:  
[Bengali](#)

is not yet done.

The language:  
[Panjabi](#)

is not yet done.

The language:  
[Javanese](#)

is not yet done.

The language:  
[Bhari](#)

is not yet done.



The language:

Telugi

is not yet done.

The language:

Marathi

is not yet done.

The language:

Malay

is not yet done.

The language:

Urdu

is not yet done.

The language:

Turkish

is not yet done.

Other:

Languages

need to be done.

**Web Page started January 1st, 1998**

**MENU: [HOME](#) » [Reconstruction](#) » [Recovery](#) » [Renewal](#) » [Language Main Page](#)**

---

---

**English**

**Web Pal**  
is a free service that matches email  
pen pals throughout the world so  
people can learn each others  
languages



Sponsored by

[World Language Process](#)

After you complete this form to become a Web Pal ...  
if you speak English like a native then **PLEASE** go to: [World Language Process](#)  
which **GREATLY** needs VOLUNTEERS!

If you speak English we will try to match you up as a Web Pal with someone who wishes to learn English.

If you do not speak English well and would like to learn English (or some other language) then why not ...

exchange email with a **Web Pal**?

We will try to match YOU with someone who does speak the language you want to learn. Just fill out this form:

**What is your Native Language?**

If you have selected "other" please enter your native language in the comment box at the bottom of the form.

Your title (Prof., Dr., Rev., Mr., Mrs., Ms., Miss, etc.)

Your last name

Your first name

Your middle name or initial

**Your email address**

=====

*OPTIONAL AREA OF FORM*

**What is your Country?**

**What is your age?**

**What Language  
Do You Want To Learn?**

Under 10

10-15

15-20

20-30

15-20

Over 50

*If you select "Other"  
please list in "Comments"*

*If you select "Other"  
please list in "Comments"*

**Male or Female?**

**Male**

**Female**

=====

Any key information you are willing to share such as experience, education, particular interests, etc.

The buttons do **NOT** work  
because this is just a demonstration of the way  
that Web Pal did work.

Return to: [World Language Process](#)

**French**

Traduction FRANCAISE par :  
**Marc-André Gagnon**  
**Montréal, Canada**  
**maggoo@videotron.ca**



**Il est IMPORTANT (nécessaire) que vous mettiez tous vos mots en Anglais.**

Si vous voulez apprendre l'anglais (ou quelqu'autres langue) alors ...

Échangez votre adresse E-mail avec un **WEB PAL** (correspondant).

Nous allons essayer de vous mettre en contact avec quelqu'un qui parle la langue que vous voulez apprendre.

Seulement entrer vos nom et informations sur ce questionnaire.

Votre situation (Professeur, Médecin, Monsieur, Madame, Mademoiselle, ...)

**Votre nom**

**Votre prénom**

Vos initiales

**Votre adresse E-mail**

=====

*PARTIE NON-OBLIGATOIRE*

**De quel pays êtes vous?**

**Quel est votre âge?**

MOINS DE 10

10-15

15-20

*Si vous choisissez "Autre"  
S'il vous plait inscrire le pays  
dans la case message en-bas.*

20-30

15-20

PLUS DE 50

**Quelle langue  
désirez-vous apprendre?**

*Si vous choisissez "Autre"  
S'il vous plait écrire la langue  
dans la case message en-bas .*

**Homme ou femme?**

Homme

Femme

=====  
**Message**

Autres caractéristiques, scolarité, travail, amitié, autres intérêts ...

The buttons do **NOT** work  
because this is just a demonstration of the way  
that Web Pal did work.

Return to: [World Language Process](#)

---

## ESPAÑOL

ESPAÑOL traducción por:  
**Prof. Carlos Inchaurrealde**  
**Chancellor of Spain**



**Cualquier contestación a este formulario debe ser en inglés**

Si Vd. quiere aprender inglés (o algún otro idioma), entonces ¿por qué no ...  
tener correspondencia electrónica (e-mail) con un **Web Pal** (Compañero en la red)?

Nosotros intentaremos encontrarle a alguien con quien pueda hablar en el idioma que Vd. quiere aprender.

Solamente hace falta completar este formulario:

Su prefijo (Prof., Dr., Rev., Sr., Sra., Ms., ...)

**Su apellido**

**Su nombre**

Segundo nombre

**Su direccion de correo electronico**

=====

*Parte del formulario no obligatoria*

**Su pais**

**¿Qué edad tiene?**

**¿Qué idioma  
quiere aprender?**

Menos de 10 años

10-15 años

15-20 años

20-30 años

30-50 años

Mas de 50 años

*Si ud. escoger "Otro"  
por-favor luego escribir  
en mensaje abajo debajo de*

*Si Vd. escoge "Otro"  
complete por favor  
el mensaje de abajo*

## ¿Hombre o Mujer?

Hombre

Mujer

=====  
Para cualquier tipo de datos que desee Vd. transmitirnos, tales como su educación, el tipo de trabajo que tiene, y sus intereses, escríbalo a continuación:

The buttons do **NOT** work  
because this is just a demonstration of the way  
that Web Pal did work.

Return to: [World Language Process](#)

Return to: [World Language Process](#)

## Persian

Persian translation by:  
**Radio Shack**  
Wellington, Kansas

کامپیوتر دوستانه

این خیلی مهم است که شما به زبان انگلیسی بنویسید

اگر شما می‌خواهید که زبان انگلیسی (یا زبان دیگر) می‌دانید  
بنویسید (نام کامپیوتری) (EMAIL) یا اینترنت .  
ما سعی می‌کنیم تا پیدا کنیم کب نفری را که بتواند انتخابی شما حرف بزند  
فقط اسمتان را نور ورقه بگذارید.



لقب (دکتر - آقا - ملا)

فامیل

اسم

آدرس کا میوٹر

لقبہ ابن ورقہ مهم نسبت

کشور

سما از خہ کشوری ہستہ

ایران

اگر کشوری فقیر از ایران انتخاب کردید  
کشورتان را در قسمت پایین بنویسید

آقا

خانم

کمتراز ۱۰

۱۰-۱۵

۱۶-۲۰

۲۱-۳۰

۳۱-۵۰

بالا ۵۰

چند سالنک است

چه زبانی شما می‌خواهید  
یاد بگیرید

ایتالیایی

زبان دیگر

اگر زبان دیگری بفرمایید انتخاب  
کردید در قسمت پایین بنویسید  
چه زبانی می‌خواهید یاد بگیرید

محل برای پیغام

اگر می‌خواهید می‌توانید بنویسید راجب  
به کار - مدرسه - هر چه علاقه دارید.

این جعبه تمام اطلاعات را به ما  
می‌فرستد. + + + + +

این جعبه وقت جدید برای  
کتاب نفر دیگر شروع می‌کند. 00000

The buttons do **NOT** work  
because this is just a demonstration of the way  
that Web Pal did work.

Return to: [World Language Process](#)



Arabic

الشبكة الالكترونية

انه (ضروري - مهم - مطلوب) ان تضع جميع الكلمات  
في النموذج بالانكليزية

اذا اردت تعلم الانكليزية او بعض لغات اخرى  
(تبادل - اكتب) البريد الالكتروني مع الشبكة الالكترونية  
سوف تحاول ان تفضل مع الشخص المناسب  
الذي يتكلم اللغة التي تريد ان تتعلم  
فقط ضع اسمك على النموذج

اللقب ( دكتور ، استاذ ، رجل دين ، سيد ، سيده ، آية )

الشهر :

الأسم :

العنوان الإلكتروني :

الجزء المقدم لهم في النموذج

ما هو بلدك ؟

بلد آخر

السعودية

اليمن

عصر

البحرين

الاردن

الكويت

لبنان

مراكش

فلسطين

قطر

سوريا

إذا أخذت بلد آخر الرجاء كتابة اسم البلد في مكان الكتابة أدناه

ذكر

انثى

ما هو عمرك؟

أقل من ١٠ سنوات

١٠ - ١٥

١٦ - ٢٠

٢١ - ٣٠

٣١ - ٥٠

أكثر من ٥٠

أي لغة تريد أن تتعلم؟

الانجليزية

لغة أخرى

إذا أخذت لغة أخرى

الرجاء كتابة اللغة في مكان الكتابة أدناه

مكان الكتابة

اي شيء سوف تشاؤون به كومت  
المدرسه ، جميعه العمل ورغبات اخرى

هذه النسخه سوف ترسل طيلك الكامل  
++++++

هذه النسخه سوف تبدأ بمجرداً عن شخص اخر  
oooooooooooo

The buttons do **NOT** work  
because this is just a demonstration of the way  
that Web Pal did work.

Return to: [World Language Process](#)

Return to: [World Language Process](#)

RUSSIAN

**Вэб друг**

**ПРОФЕССИОНАЛЬНЫЙ ПЕРЕВОД С РУССКОГО  
НА АНГЛИЙСКИЙ И ОБРАТНО;  
СОЗДАНИЕ ВЭБ СТРАНИЦ**

**PROFESSIONAL RUSSIAN TRANSLATION;  
WEB PAGE CREATION**

**CLICK HERE**

**НАЖМИТЕ ЗДЕСЬ**

**Очень важно, чтобы Вы заполнили эту форму ПО-АНГЛИЙСКИ!**

Титул /г-н, г-жа .../

ФАМИЛИЯ

ИМЯ

ОТЧЕСТВО

Адрес электрон. почты

СЛЕДУЮЩАЯ ЧАСТЬ ФОРМЫ НЕОБЯЗАТЕЛЬНА

**Из какой Вы страны?**

Россия-Russia  
Украина-Ukraine  
Белоруссия-Belarusia  
Казахстан-Kazakhstan  
США-USA  
Другая-Other



Если Вы выбрали вариант "Другая"  
страна, то напишите название Вашей  
страны ниже, в рамке для дополнительных  
заметок

ПОЛ: Мужской  
Женский

**Ваш возраст:**

Моложе 10  
10-15  
16-20  
21-30  
31-50  
Старше 50

**Какой язык Вы  
желаете выучить?**

АНГЛИЙСКИЙ  
Другой

Если Вы выбрали "Другой"  
язык, то напишите его в  
этой текстовой рамке:

**Дополнительные заметки:**

Если желаете, можете сообщить  
Ваше образование, профессию,  
интересы

Отправить нам заполненную форму +++++

Начать заполнение заново 0000000

The buttons do **NOT** work  
because this is just a demonstration of the way  
that Web Pal did work.

Return to: [World Language Process](#)

---

Если Вы желаете выучить английский или какой-нибудь другой язык, то мы можем найти для Вас Вэб друга, с которым Вы сможете переписываться по электронной почте.

Мы поможем Вам найти кого-нибудь, кто разговаривает на языке, который Вы желаете выучить.

Для этого Вам нужно просто заполнить следующую форму:

**Danish**

Danish Translator  
Eric Rosen

**Web Pal**

It is **important (necessary)** that you fill out the form in English.

Hvis du ønsker at lære engelsk (eller et andet sprog), eller ...

udveksle "e-mail" med en **Web Pal**

**Vi vil prøve på at finde en "Web Pal" de taler de sprog du ønsker at lære.**

**Simpelthen: udfyld denne form.**

**Progression (Prof., Dr., - Herr, Frue, Frøken, ...)**

**Dit efternavn**

**Dit fornavn**

**Mellempnavn eller begyndelsesbogstav.**

**Din "e-mail" adress.**

=====

**Fyld ud, hvis de ønsker**

**Din nationalitet?**

**Din alder?**

**Hvad sprog vil du lære?**

*Hvis du vælger "andre",  
venligst give lande  
unden "Note".*

- Under 10
- 11-15
- 16-20
- 21-30
- 31-50
- Over 50

*Hvis du vælger "andre",  
venligst give sproget  
under "Note".*

**Mand eller Kvinde?**

- Mand
- Kvinde



**Note**

**Har du erfaringer du vil dele med andre om uddannelse eller speciel interesse?**

The buttons do **NOT** work  
because this is just a demonstration of the way  
that Web Pal did work.

Return to: [World Language Process](#)

**POLSKI**

Tłumaczyła:  
**Alicja Piekarska**

# KK - Komputerowy Kumpel

**Ważne jest, żeby wszystkie informacje pisane w kwestionariuszu były po angielsku.**

KK-Komputerowy Kumpel jest bezpłatnym serwisem, który służy ludzi z całego świata zainteresowanych korespondencją przy użyciu poczty elektronicznej w celu nauzenia się języka.

Jeżeli nie mówisz po angielsku dobrze, a chciałbyś się w tym lub innym języku podszkolić.... czemu nie wymieniasz elektronicznych wiadomości z Komputerowym Kumplem?

Spróbujemy znaleźć dla Ciebie osobę mówiącą językiem, którego się chcesz uczyć.

Po prosu wypełnij kwestionariusz:

Jak Cię tytułować? (Prof., Dr., Ks. (Rev.) Pan (Mr.), Pani (Mrs.), Panna (Miss))

**Nazwisko**

**Imię**

Drugie imię

**Adres e-mailowy**

=====  
*Dodatkowe informacje- opcjonalnie*

**Skąd pochodzisz?**

**Wiek?**

**Jakiego języka się chcesz uczyć?**

*Jeżeli wybrałeś "inne", wpisz tę informację w miejscu na uwagi.*

Poniżej 10

10-15

16-20

21-30

31-50

Ponad 50

Płeć?

Mężczyzna

Kobieta

*Jeżeli wybrałeś "inne", wpisz tę informację w miejscu na uwagi.*

---

## Uwagi

Tu wpisz wszystkie inne ważne informacje o sobie, którymi chcesz się podzielić: doświadczenia zawodowe, wykształcenie, zainteresowania itp.

The buttons do **NOT** work  
because this is just a demonstration of the way  
that Web Pal did work.

Return to: [World Language Process](#)

Return to: [World Language Process](#)

Prima traduzione ITALIANA vicino:  
**SYSTRAN Software, Inc.**

# Web Pal

(Fotoricettore Pal)

**È importante (necessario) che avete messo tutta la parola nella forma in inglese.**

Se desiderate imparare l' inglese (o una certa altra lingua) allora...

scambiare (scrivere) il email (posta di calcolatore) con  
**Web Pal (un fotoricettore pal)**(amico del calcolatore).

Proveremo a abbinarli con qualcuno che parlano la lingua che desiderate imparare.

Mettere appena il vostri nome ed informazioni su questa forma:

il vostro prefisso (prof., Dott., invertitore, sig., sig.ra, sig.na, ms...)

**Il vostro ultimo nome**

**Il vostro nome**

il vostro secondo nome o lettera

**Il vostro indirizzo del email (posta di calcolatore)**

=====

*LA PARTE NON NECESSARIA DELLA FORMA*

**Che cosa è il vostro paese?**

*Se scegliete " altro "  
scrivere prego il paese  
nella zona di messaggio giù sotto.*

**Maschio o femmina?**

Maschio  
Femmina

**Che cosa è la vostra età?**

Più meno di 10  
10-15  
15-20  
20-30  
15-20  
Più di 50

**Quale lingua  
desiderate imparare?**

*Se scegliete " altro "  
scrivere prego la lingua  
nella zona di messaggio giù sotto.*

**Zona Di Messaggio**

Qualsiasi fatto che vi ripartirete quale la quantità di scuola, tipo di lavoro ed altri interessi.

The buttons do **NOT** work  
because this is just a demonstration of the way  
that Web Pal did work.

Return to: [World Language Process](#)



Return to: [World Language Process](#)

**Korean**

Korean translation by:

**Prof. Nolin Stratton**  
and  
**Tae Jin Yoon**

웹팔은 세계 도처에서 전자 우편 편팔을 짝지어 주어서 사람들이 서로 다른 언어를 배울수 있도록 하는 무료 서비스입니다.

당신은 영어로 서식을 작성할 필요가 있습니다.

만일 당신이 영어를 잘 말하지 못하고, 영어를(혹은 다른 언어를) 배우고 싶다면 웹팔로 전자 우편을 하는게 어떻겠습니까?

단지 이 서식을 작성해 주십시오.

당신의 직함

성

이름

전자우편 주소

선택사항

국적

다른나라

한국

성별

남성

여성

당신의 나이

10 미만

10 - 15

16 - 20

21 - 30

31 - 50

50 이상

당신은 어떤 언어를 배우고 싶습니까?

영어

다른언어

만일 당신이 "다른 언어"를 선택한다면 "비고"란에 작성해 주십시오.

경험, 교육, 특별한 관심 분야 등 당신이 나누고 싶은 모든 정보

비 고

이 버튼은 당신의 완성된 서식을 보냅니다.

이 버튼은 다른 사람을 다시 등록시킵니다.

The buttons do **NOT** work  
because this is just a demonstration of the way  
that Web Pal did work.

Return to: [World Language Process](#)

---

Return to: [World Language Process](#)

## Chinese

Chinese translation by:

**Thng YiXe**

唐一思

网友

您必须以英语填写以下表格。

若您想学习英语或者其他语言, 那么 .....  
与我们的网友交换电子信件。

我们会尽量为您安排一位  
使用您想学习的语言的网友。

请把您的姓名与资料填在表格上:

称号

姓名

电址

表格不重要的部分

您的国籍

其他

中国

台湾

香港

马来西亚

新加坡

若您选择'其他',  
请将国籍填在以下的'意见'处

男

女

年龄

10岁以下

10-15岁

16-20岁

21-30岁

31-50岁

50岁以上

您想学习什么语言?

英语

其他

若您选择'其他',请将所选的语言填在以下的'意见'处

意见

任何有关您的资料,譬如工作或者其他兴趣

这个按钮将送出您的表格

这个按钮让下一位用者填写表格

The buttons do **NOT** work  
because this is just a demonstration of the way  
that Web Pal did work.

Return to: [World Language Process](#)

---



อังกฤษ ถ้าคุณต้องการเรียนภาษาอังกฤษ  
หรือภาษาอื่น ๆ โดยวิธี

( การ แลกเปลี่ยน = จดหมาย),

(อีเมล = จดหมายตามเครือข่ายคอมพิวเตอร์)

รวมทั้ง เพื่อนและมิตรทางคอมพิวเตอร์

เราจะพยายามหาคนที่เหมาะสมที่พูดภาษา  
ที่คุณต้องการจะเรียน

โดยใส่ชื่อของคุณในแบบฟอร์มนี้ :

คำนำหน้าชื่อ

( ดร., ศจ., นาย, นาง, นางสาว)

นามสกุล

ชื่อจริง

ที่อยู่ อี - เมล





ระหว่าง ๑๐ - ๑๕ ปี

ระหว่าง ๑๖ - ๒๐ ปี

ระหว่าง ๒๑ - ๓๐ ปี

ระหว่าง ๓๑ - ๕๐ ปี

มากกว่า ๕๐ ปี

ภาษาอะไร ที่คุณต้องการเรียน

ภาษาอังกฤษ

อื่น ๆ (ระบุ) ภาษา

ถ้าคุณเลือก อื่น ๆ ข้างบน  
โปรดเขียนข้อความในภาษาของคุณข้างล่าง

ส่วนที่เขียนข้อความ

ความจริงทุกอย่างที่คุณต้องการแล้ว  
เช่น เกี่ยวกับโรงเรียน  
ชนิดของงานที่คุณทำ  
และเรื่องที่น่าสนใจอื่น ๆ

ส่วนนี้จะส่งให้คุณในรูปแบบฟอร์มที่สมบูรณ์

ส่วนนี้จะเริ่มใหม่สำหรับบุคคลต่อไป

The buttons do NOT work  
because this is just a demonstration of the way  
that Web Pal did work.

Return to: [World Language Process](#)

**German**

# SelennetzKamerad

**Es ist wichtig (notwendig) daß Sie das ganzes Wort in die Form auf englisch einsetzen.**

Wenn Sie Englisch (oder irgendeine andere Sprache) erlernen möchten dann...  
(schreiben), email (Computerpost) mit einem Selennetz **kameraden** ( Computerfreund) austauschen.

Wir versuchen, Sie mit jemand zusammenzubringen, die die Sprache sprechen, die, Sie erlernen möchten.

Ihren Namen und Informationen auf dieses Formular gerade setzen:

;

Ihr Präfix (Prof, Dr., Polwender, Herr, Mrs, Fräulein, Ms...)

**Ihr letzter Name**

**Ihr Vorname**

Ihr zweiter Name oder Brief

**Ihre Adresse des email (Computerpost)**

=====

*DAS NICHT NOTWENDIGE TEIL DES FORMULARS*

**Was ist Ihr Land?**

*Wenn Sie " anderes " wählen das Land bitte schreiben im Nachrichtenbereich unten.*

**Was ist Ihr Alter?**

- Weniger als 10
- 10-15
- 15-20
- 20-30
- 15-20
- Mehr als 50

**Welche Sprache möchten Sie erlernen?**

*Wenn Sie " anderes " wählen die Sprache bitte schreiben im Nachrichtenbereich unten.*

**Mann oder Frau?**

Mann

Frau



## Nachrichtenbereich

Irgendeine Tatsache, die Schule, Art der Arbeit und andere Interessen.

The buttons do **NOT** work  
because this is just a demonstration of the way  
that Web Pal did work.

Return to: [World Language Process](#)

## Tagalog

# Web Pal

Bahay-gagamba Kaibigan

Talagang **mahalagang (isulat)** mo ang lahat sa English.

Kung gusto mong matotong magsalita ang English (ibang lengguwahe,) ...

palitang email **Bahay-gagamba Kaibigan** (Computer Kaibigan).

Aming tutulongan kayong magpalitang sa manga taong maronong magsalita ng lengguwahe gusto ninyong malaman.

Basta sulat lang o pirmahan ninyong ito form:

Ang iyong pamagat tulad nang (Prof., Dr., Rev., Mr., Mrs., Miss, Ms., ...)

**Ang iyong huleng pangalan**

**Ang iyong unang pangalan**

Ang iyong gitnang pangalan o initial

**Ang email direksiyon**

=====  
*Kayo ang bahala kung gusto ninyong sagutin ang susunod ng tanong*

**Ano ang iyong bansa?**

**Ano ang idad mo?**

**Ano ang lengguwahe gusto mong mapagaralan?**

*Kung gusto mo ang ibang "Iba pang" paki sulat mo lang ang iyong nagustuhan ang nakasulat nasa sa ibaba.*

Mababa sa 10

10-15

15-20

20-30

15-20

Matangda 50

*Kung gusto mo ang ibang "Iba pang" paki sulat ang lengguwahe nasa sa ibaba.*

**Lalake o Babae?**

Lalake

Babae



## Kung Gusto Mo ng Iba Pa Pake Sulat Lang

Merong ka bang ibng gustong malaman o baka me rong kang karanasan o edukasyon o iba pang interes.

The buttons do **NOT** work  
because this is just a demonstration of the way  
that Web Pal did work.

Return to: [World Language Process](#)

Return to: [World Language Process](#)

**PORTUGUESE**

**Promovido por  
WEBPal**

**É importante que você preencha este formulário em inglês.**

Se você quer praticar o seu inglês (ou alguma outra língua) então...

se corresponda por e-mail com um

**Pen Pal (um novo amigo no exterior) .**

Nós tentaremos colocá-lo em contato com alguém que fale a língua que você quer aprender.

Escreva o seu nome e informações pessoais neste formulário:

seu título (prof., Dr., Rev., Sr., Sra., senhorita, ....)

**Seu último nome**

**Seu primeiro nome**

seu segundo nome ou iniciais

**Seu e-mail**

=====

*PARTE OPCIONAL DO FORMULÁRIO*



**Qual é seu país?**

*Se você escolher "outro"  
indique por favor o país  
no espaço abaixo.*

**Qual é a sua idade?**

- Menos de 10
- 10-15
- 16-20
- 21-30
- 31-50
- Mais de 50

**Que língua  
você quer aprender?**

*Se você escolher "outra"  
especifique por favor qual a língua no espaço  
abaixo.*

**Sexo Masculino ou Feminino?**

- Masculino
- Feminino

=====

Alguma informação pessoal que você queira adicionar? ( experiências, estudos, trabalho, e outros interesses.)

The buttons do **NOT** work  
because this is just a demonstration of the way  
that Web Pal did work.

Return to: [World Language Process](#)

Return to: [World Language Process](#)

Vietnamese

Người dịch là:  
Diệp Hồ  
Tazy Huỳnh

# Web Pal

Rất là cần thiết và quan trọng bạn nên dùng văn anh ngữ trong khi liên lạc.

Nếu quý bạn muốn học anh ngữ hay là những  
ngôn ngữ khác thì bạn nên  
dùng email với Web Pal

Chúng tôi rất cố gắng tìm cho quý bạn một  
người bạn nói tiếng mà, bạn muốn học.  
Bạn chỉ cần điền tên vào trong tờ đơn này:

Họ

tên

tên lót

địa chỉ E mail

Các bạn không cần  
những điều dưới đây

Ngôn ngữ nào bạn muốn học?

ngôn ngữ khác

Việtnam

Phái nam

Phái nữ

Bạn bao nhiêu tuổi

nhỏ hơn 10

10-15

16-20

21-30

31-50

lớn hơn 50

Ngôn ngữ nào bạn học?

Anh ngữ

Ngôn ngữ khác

Nếu bạn chọn được ngôn ngữ  
mà bạn muốn học xin vui lòng  
viết xuống

Xin để lại điện tín

Lời chia tâm sự của bạn  
như trường học việc làm  
hoặc những gì bạn thích thú

đây là nút sẽ gọi đơn này đến tận địa điểm

đây là nút sẽ cho bạn tìm lại từ đâu hoặc gặp thêm bạn mới

The buttons do **NOT** work  
because this is just a demonstration of the way  
that Web Pal did work.

Return to: [World Language Process](#)

Return to: [World Language Process](#)

## Japanese

Japanese translation by:

**Daiki Iga**

伊賀大記  
ウイノ州立大学  
日本人学生会会長

# Web Pal

ウェブパルは  
コンピュータ  
ネットワーク上  
の友達  
です

注意: 以下の項目には全て英語で記入して下さい

もしあなたが英語もしくは他の外国語を学ばれたら、  
雑誌の交換やe-mailのやり取りをインターネット上の友達  
とすることが出来ます。私達があなたの学ばれた言語  
を使う友達をあなたに紹介します  
あなたの名前をこのフォームに記入して下さい

苗字

名前

e-mail アドレス

以下は全ての項目に記入する必要はありません

国籍はどちらですか

その他

日本国

もし“その他”を選んだ場合は  
以下のメッセージエリア  
にあなたの国籍を記入  
して下さい

男性

女性

おいくつですか？

10歳以下

10-15

16-20

21-30

31-50

50歳以上

どの言語を学びたい  
ですか？

英語  
その他

もし"その他"を選んだ  
場合は以下のメッセージエリア  
にあなたの学びたい言語を  
記入して下さい

メッセージエリア

あなた自身のことを  
教えてください。  
通っている学校や仕事  
興味のあることなど"

このボタンを押すとあなたの  
フォームが送られます



このボタンを押すと次の人が始めること  
ができます

The buttons do **NOT** work  
because this is just a demonstration of the way  
that Web Pal did work.

Return to: [World Language Process](#)

---

## Swedish

Swedish translation by:  
**Heléne Wikström**  
Umeå Sweden  
heewim95@student.umu.se

# Nätkompis

### Det är viktigt att du skriver alla svar på engelska

Om du vill lära dig engelska (eller något annat språk) kan du brevväxla med en nätkompis.

Vi kommer att göra vårt bästa för att hitta någon som pratar det språk du vill lära dig.

Skriv bara ditt namn och övrig information i det här formuläret:

Titel (Prof., Dr., Rev., Mr., Mrs., Miss, Ms., ...)

**Efternamn**

**Förnamn**

Ev. mellannamn

**Email adress**

=====

*Icke nödvändig del av formuläret*

**Vilket är ditt land?**

**Ålder?**

**Vilket språk vill du lära dig?**

*Om du väljer "annat",  
skriv det landet i meddelanderutan  
nedan.*

Yngre än 10 år

11-15

16-20

21-30

31-50

Äldre än 50 år

*Om du väljer "annat",  
skriv språket i meddelanderutan.*

**Man eller Kvinna?**

Man

Female

=====

**Meddelanderuta**

Övrig information om skolor du gått i,

arbete, intressen mm

---

# A Tutorial for Traditional Orthography Readers

## Who Wish to Learn ANJeL

This is a tutorial for TO (Traditional Orthography) users on how to read ANJeL.

The Angel alphabet consists of 39 symbols, each of which represents a unique sound. Unlike the traditional English alphabet, there is no duplication whereby different letter combinations can sound alike. For example, in English "threw" and "through", "bough" and "bow", "blue" and "blew", "write" and "right" have identical sounds but varied spellings. In Angel, all identical sounds have identical spellings.

The Angel alphabet assigns a unique symbol to each unique vowel and consonant sound. The symbols used are similar to those of the traditional English alphabet, with one big difference: Upper case letters have one unique sound, and lower case letters have another. In addition, sounds composed of multiple letter groupings (such as "oo", "ow" and "oy") are represented by single symbols in the Angel alphabet.

Unlike traditional English, Angel has no "silent" letters that can change the pronunciation of other letters in the word. (In traditional English, silent letters often change "short" vowels to "long" vowels: "cut" becomes "cute" even though we never hear that "e" on the end). In Angel, every letter in a word is essential and is pronounced.

In short, Angel is CONSISTENT. Its purpose is to permit new English learners to "See what we Say" on captioned TV, using the closed captioning decoder standards imposed by the U.S. Congress. The assignment of symbols to sounds was dictated by the need to avoid letters with descenders because such letters are poorly represented by the pixel arrangement on the television screen. Angel will be used in the ACCESS (Auxiliary Closed Captioned English with Simplified Spelling) System of the World Language Process for teaching English in Third World Countries.

## Lesson 1

### The Letters of the Angel Alphabet

The ANJeL 39 letter alphabet is as follows:

**A a d**

**E e r**  
**I i b**  
**X x k**  
**U m n**

**c s t**  
**w z h**

**B D F**  
**G H J**  
**K L M**  
**N P R**  
**S T V**  
**W Y Z**

**The following explains how the ANJeL Alphabet is organized.**

The traditional English alphabet may be written as follows:

A B C D  
E F G H  
I J K L M N  
O P Q R S T  
U V W X Y Z

or

A -- B C D  
E -- F G H  
I -- J K L M N  
O -- P Q R S T  
U -- V W X Y Z

showing how we arrive at the order of the long vowels, AEIOU, when we recite them by giving them the letter's name.

In the ANJeL alphabet we use X for O, so that the letter will not be confused with a zero. Also we give the U the name and sound of the u in up. Therefore we get:

A -- the sound like in bay  
 E -- the sound like in bee  
 I -- the sound like in pie  
 X -- the sound like in go  
 U -- the sound like in up

In the ANJeL alphabet we use the lower case letter for the short vowels and write them adjacent to the long vowel arriving at the start of our 39 character alphabet written in the following format.

Note the sound assignment to "m". In ANJeL, some letters are assigned completely different names and sounds than in TO.

**A a** \_\_\_ a- the sound of a in cat  
**E e** \_\_\_ e- the sound of e in bed  
**I i** \_\_\_ i- the sound of i in sit  
**X x** \_\_\_ x- the sound of o in dog  
**U m** \_\_\_ m- the sound of oo in foot

\_\_\_

\_\_\_

\_\_\_

\_\_\_

\_\_\_

\_\_\_

\_\_\_

\_\_\_

As you see, this schema is composed of three blocks of letters. The upper block is vowels and the lower blocks are the consonants, the lower of which we shall fill in now.

**A a** \_\_\_  
**E e** \_\_\_  
**I i** \_\_\_  
**X x** \_\_\_  
**U m** \_\_\_

**B D F**  
**G H J**  
**K L M**  
**N P R**  
**S T V**  
**W Y Z**

The order of the consonants is the same as in the TO alphabet with simply the TO vowels and the X (and capital letters C, O and Q that ANJeL does not use at all) left out. As you will notice, all the letters in this block are capitals, which is why we call them the large consonant letters.

In the case of the vowels, which we covered a moment ago, the name of the vowel letter and the sound of the vowel letter are identical. A consonant, in the TO alphabet, is accompanied by a vowel (in front or behind) in order to be pronounced. The most commonly used vowel in traditional English is E. Thus in the alphabet of Traditional Orthography we have BE, DE, PE, TE, VE, and ZE ie. **B, D, P, T, V** and **Z** (forget the crazy Canadian zed). The names of these letters are the same in the ANJeL alphabet.

However, in ANJeL the other large consonant letter names are pronounced a little differently than in traditional English orthography. One of the main features of the ANJeL TUn is simplification through consistency. The ANJeL TUn large consonants have no exceptions. Therefore the letter **F** instead of having its vowel placed in front and being pronounced eF is named with the consistent long **E** afterwards (like FEE). **G** therefore becomes the mule skinnners GEE, ach (**H**) becomes HE, and jay (**J**) becomes JE (like in my wife's name Jean).

**B** (bee)  
**D** (dee)  
**F** (fee)  
**G** (gee)  
**H** (hee)  
**J** (jee)  
**K** (key)  
**L** (lee)  
**M** (me)  
**N** (knee)  
**P** (pea)  
**R** (re)

**S** (see)  
**T** (tea)  
**V** (vee)  
**W** (we)  
**Y** (ye)  
**Z** (ze)

While all of this is very simple, it still much more simply demonstrated with a video and of course its audio. But to continue, we will now fill in the rest of the vowel sounds.

**A** a \_\_\_\_  
**E** e \_\_\_\_  
**I** i \_\_\_\_  
**X** x \_\_\_\_  
**U** m \_\_\_\_

There are certain symbols on the traditional alphabetic typewriter keyboard that we have not used. We now use these for the sounds in the English language that have no letter.

For example ow, ou, ough which are all pronounced the same as in: owl, out, plough, are written in ANJeL using the **d** symbol which we have not previously used. Thus cow is written Kd, now Nd, out dT and plough PLd.

The **r** is somewhat of a special case. It is called a schwa. It is the sound heard very often at the end of words (and elsewhere) as in "mother", MUhr, "baker", BAKr, and at the beginning of "urgent", rJeNT.

The **b** is used for the oi, or oy sound. Like in oil and boy, which we would spell bL and Bb.

The **k** is used for the oo sound in tool.

The **n** is a particularly curious letter. It is NOT a vowel, but we put it at the end of the vowel block because it is the only consonant that cannot be pronounced with an **E** after it. We use **n** to represent the ng sound which is the sound we find at the end of the words like ring, rang and rung.

To remain as consistent as possible we pronounce the letter name **n** with the usual E as the preceding vowel. The sound is ng and therefore the vowel name is Eng (sort of like the ing in going but with a stronger E sound). **n** can be preceded by any vowel. That is why in ANJeL



"tongue" is TUn. It is a curiosity that English has this exceptional sound as its name.

These five letters now fill into our matrix in the following locations:

**A a d d**- the sound of ou in out and therefore dT

**E e r r**- the sound of r in sir and therefore Sr

**I i b b**- the sound of oy in boy and therefore Bb

**X x k k**- the sound of oo in tool and therefore TkL

**U m n n**- the sound of ng in ring and therefore Rin

The remaining set of letters are referred to as small consonants (as distinguished from the block of large consonants which were described earlier). They are called small consonants simply because they use what are lower case letters in traditional English orthography. The set is in the small consonant block.

**c s**

**w z**

These are named as:

chee she thee

whee zhe thee

Notice that each of these letters has the appearance of being associated with an h in TO. Like:

ch sh th

wh zh th

The zhe sound is rare in English but is found in words like garage (GaRxz in ANJeL) but I will dispense of the long orthological discussion of its defense.

Each of these small consonants can be followed by any of the vowels. It is more difficult to put a vowel in front of wh.

You will notice that there are two "thee" sounds in TO English. The first th is like in th in theology or thousand and the second th is like th in the or thou.

th is indiscriminate in traditional English orthography. How is "thou" pronounced?

Wilt thou loan me a thou (like in thousand)?

But ANJeL discriminates:

WiLT hd LXN ME A td?

So, now, we have the complete ANJeL alphabet which is read, memorized, recited (and yes sung as a memory device) in rows from left to right.

**A a d**

**E e r**

**I i b**

**X x k**

**U m n**

**c s t**

**w z h**

**B D F**

**G H J**

**K L M**

**N P R**

**S T V**

**W Y Z**

The full reasons for the selection of the letters involves considerable more detail about how descenders are represented in captioning on the video screen but this suffices to show the names of the letters in the Angel alphabet. In the next lesson we will deal further with the sounds of the letters.

## Lesson 2

### The Sound of the Angel Letters

We will now examine each of the Angel letters in the order that they are recited and examine the sound associated with each letter. The first examples will show the letter under discussion as a leading letter and the second three examples will show it as a trailing letter. The first row is the TO example, and the second row the Angel example.

<b>A</b>	- Abe,	able,	aid	- bay,	day,	may
	AB,	ABUL,	AD	- BA,	DA,	MA
<b>a</b>	- act,	apple,	approach	-		
	aKT,	aPUL,	aPRXc	-		

-----

There appear to be no words that end in the "a" sound.  
They all seem to get converted to U.

<b>d</b>	- ouch,	out,	owl	- bough,	cow,	plough
	dc,	dT,	dL,	- Bd,	Kd,	PLd
<b>E</b>	- each,	eat,	eek	- any,	bee,	collie
	Ec,	ET,	EK	- eNE,	BE,	KxLE
<b>e</b>	- echo,	edit,	etch	- bed,	feminine,	get
	eKX	eDiT,	eTc	- BeD,	FeMiNiN,	GeT

-----

(e often follows consonants but there do not appear to be any words which it ends)

<b>r</b>	- early,	earth,	urban	- acre,	copper,	mother
	rLE	rt,	rBan	- AkR,	KxPr,	MUhr
<b>I</b>	- eye,	I,	idol	- buy,	tie,	why
	I,	I,	IDxL	- BI,	TI,	wI
<b>i</b>	- idiot,	ill,	itch	- dish,	bill,	with
	iDiUT,	iL,	iTc	- Dis,	BiL,	Wit

-----

(i often follows consonants but there do not appear to be many words which it ends)

<b>b</b>	- oil,	ointment,	oyster	- boy,	joy,	toy
	bL,	bNTMeNT,	bSTr	- Bb,	Jb,	Tb
<b>X</b>	- obey,	oh,	old	- ago,	blow,	yellow
	XBA,	X,	XLD	- aGX,	BLX,	YeLX
<b>x</b>	- odd,	off,	on	- bra,	pa,	saw
	xD,	xF,	xN	- BRx,	Px,	Sx
<b>k</b>	- oodles,	oof,	oops	- blue,	shoe,	two
	kDLZ,	kF,	kPS	- BLk,	Sk,	Tk
<b>U</b>	- udder,	under,	up	- the,	bust,	butter

	UDr,	UNDr,	UP	- hU,	BUST,	BUTr
<b>m</b>	- _____	_____	_____	- book,	foot,	soot
	_____	_____	_____	- BmK,	FmT,	SmT

I have thought of no examples where the **m** begins or ends a word, but I know of no technical reason why it could not.

<b>n</b>	- _____	_____	_____	- bang,	bing,	bong
	_____	_____	_____	- Ban,	Bin,	Bxn

**n** is something of an anomaly in Angel (and TO) in that it never starts a word or syllable. One can't even say it that way. One of the few words in English that even has it near the start of the word is ingot (inGxT), except for the word English (EnLis) itself.

<b>c</b>	- chair,	check,	church	- beach,	ouch,	rich
	cAR,	ceK,	crc	- BEc,	dc,	Ric
<b>s</b>	- she,	ship,	show	- ash,	fish,	mush
	sE,	siP,	sX	- as,	Fis,	MUs
<b>t</b>	- thank,	theory,	thin	- bath,	oath,	teeth
	tanK,	tEXRE,	tiN	- Bat,	Xt,	TEt
<b>w</b>	- what,	where,	which	- _____,	_____,	_____
	wxT,	weR,	wic	- _____,	_____,	_____

**w** is something of an anomaly in Angel (and TO) in that it never ends a word or syllable.

<b>z</b>	- genre,	genres,	jabot	- beige,	garage,	rouge
	zxNRU,	zxNRUZ,	zaBX	- BAz,	GaRxz	Rkz
<b>h</b>	- that,	the,	then	- bathe,	lathe,	loath
	haT,	hu,	heN	- BAh,	LAh,	LXh
<b>B</b>	- babe,	ball,	bat	- Abe,	rob,	tube
	BAB,	BxL,	BaT	- AB,	RxB,	TkB
<b>D</b>	- dinner,	doubt,	dumb	- bed,	blood,	dude
	DiNr,	DdT,	DUM	- BeD,	BLUD,	DkD

The **D** on the end of words is something of a strange letter. Sometimes in TO it is sounded as a T. (See discussion under T). However, other times, TO words that end in ed do have a D sound

such as in "We polled the voters or we pulled the wagon". In Angel these become PXL D and PULD).

<b>F</b>	- fine,	fix,	funny	- chef,	chief,	half
	FIN,	FIKS,	FUNE	- seF,	cEF,	HaF
<b>G</b>	- go,	going,	gone	- bag,	dog,	pig
	GX,	GXin,	GxN	- BaG,	DxG,	PiG
<b>H</b>	- heavy,	how,	hump	- _____,	_____,	_____
	HeVE,	Hd,	HUMP	- _____,	_____,	_____

The **H**, **W**, and **Y** do not appear to end any words in Angel. This may be because that in TO they are in those positions what we call silent letters.

<b>J</b>	- jade,	jive,	jump	- badge,	edge,	ridge
	JAD,	JIV,	JUMP	- BaJ,	eJ,	RiJ
<b>K</b>	- cane,	key,	cap	- ache,	cook,	desk
	KAN,	KE,	KaP	- AK,	KmK,	DeSK
<b>L</b>	- lame,	last,	long	- ball,	pal,	tell
	LAM,	LaST,	Lxn	- BxL,	PaL,	TeL
<b>M</b>	- me,	more,	my	- bomb,	come,	name
	ME,	MXR,	MI	- BxM,	KUM,	NAM
<b>N</b>	- know,	never,	no	- on,	one,	sun
	NX,	NeVr,	NX	- xN,	WUN,	SUN
<b>P</b>	- pea,	pod,	please	- nap,	step,	up
	PE,	PxD,	PLEZ	- NaP,	STeP,	UP
<b>R</b>	- read,	read,	red	- bar,	bear,	boar
	RED,	ReD,	ReD	- BxR,	BeR,	BXR
<b>S</b>	- same,	seed,	some	- guess,	weakness,	horse
	SAM,	SED,	SUM	- GeS,	WEKNeS,	HXRS

The **S** is sometimes used as the sound of a TO plural but most often TO plurals actually end in a Z sound (see **Z**). Sh combinations, such as shout (sdT), of course have their own representation in ANJeL (see **s**).

<b>T</b>	- tag,	top,	two	- at,	cot,	worked
----------	--------	------	-----	-------	------	--------

TaG,

TxP,

Tk

- aT,

KxT,

WrKT

-----

Curiously, the ed sound at the end of words in TO often has the T sound in Angel. In old English the e in worked would have been sounded as work-ed. But not now.

<b>V</b>	- van,	vicious,	victory	- cave,	grieve,	love
	VaN,	VisUS,	ViKTXRE	- KAV,	GREV,	LUV
<b>W</b>	- wag,	we,	went	- _____,	_____,	_____
	WaG,	WE,	WeNT	- _____,	_____,	_____
<b>Y</b>	- yam,	year,	yes	- _____,	_____,	_____
	YaM,	YER,	YeS	- _____,	_____,	_____
<b>Z</b>	- zebra,	zip,	zoo	- buzz,	fez,	fizz
	ZEBRU,	ZiP,	Zk	- BUZ,	FeZ,	FiZ

-----

**Z** gets extensive other use in Angel as the plural at the end of TO words - WrDZ.

-----

In the next lesson we will get into actual practice in reading Angel words.

## Lesson 3

### Reading Angel Words

It has been said that anyone who can read TO can learn to read any English phonetic system in about two hours. Angel is a little more difficult than some phonetic systems that are specifically designed for ease of reading by TO readers. It is less difficult than some others like Deseret that are specifically designed as a code to discourage those who do not know the code. Angel is specifically designed to make the learning of English easy for those who do not know English at all. Still, the rule of thumb for most phonetic systems, about two hours, to become a fairly proficient reader in Angel, holds. Speed reading requires sight recognition of thousands of words, and combinations of words, and long periods of practice.

Because 40% of most English text is made up of about 50 words, a very big help in learning to read Angel is to be able to sight recognize 35 of those words, of that list of 50, that are less apparent in their translation to the TO reader. Here are those 35 words in the order of their approximate frequency of use.

1. the - hU
2. of - UV

3. to - Tk
4. that - haT
5. this - tiS
6. was - WxZ
7. as - aZ
8. with - Wit
9. his - HiZ
10. by - BI
11. are - xr
12. they - hA
13. one - WUN
14. were - Wr
15. all - xL
16. her - Hr
17. she - sE
18. would - WmD
19. there - hr
20. has - HaZ
21. been - BiN
22. their - hr
23. when - weN
24. what - wxT
25. which - wic
26. where - weR
27. why - wl
28. who - Hk
29. you - Yk
30. them - heM
31. about - aBdT
32. than - haN
33. how - Hd
34. now - Nd
35. going - GXin

Simply memorizing the above list and being able to easily recognize the above words will greatly facilitate the reading of Angel. However, it is probably best to go through the rest of this lesson for a better understanding of how come those words are translated into English in the manner in which they are. After finishing the lesson, it is well to then come back here and learn to sight recognize the above list. The fastest way, at that time, would be to write them out on a set of 35 flip cards and to repeatedly go through the cards until you can do so very quickly.

Now, let us do a little drill of the ANJeL large vowels.

Cover up the TO line and try to recognize the word in ANJeL before reading the TO line.

First **A**

BA, DA, SA, RA, MA, GA, HA, JA, LA, PA, WA

bay, day, say, ray, may, gay, hay, jay, lay, pay, way

Now for **E**

BE, FE, SE, HE, ME, GE, TE, LE, PE, WE

bee, fee, see, me, gee, tea, lea, pea, we

And **I**

BI, DI, SI, RI, MI, GI, HI, JIV, LI, PI

buy, die, sigh, rye, my, guy, high, jive, lie, pie

The TO is getting stranger and stranger, and more unpredictable isn't it? But still you can read the Angel just fine.

On to **X**

BX, DX, SX, RX, MX, GX, HX, JX, LX, PX, WX

bow, dough, sew, row, mow, go, hoe, joe, low, poe, woe

TO gets stranger and stranger. NX? BUT xN WE GX!

**U**

UP, UNDr, SUN, BUT, KUT

up, under, sun, but, cut

And now onward for a little practice with the first column of small vowels.

**a**

aD, DaD, FaT, SaT, KaT, RaT, MaT, SaT



add, dad, fat, sat, cat, rat, mat, sat

Vowels at the beginning, vowels in the middle, vowels at the end. You can handle them all. Much harder to teach to someone who does not speak English. If sometimes a word like aD surprises you because you do not know whether in TO it is going to be ad or add, that is because of the nature of TO. You can tell by the context that it is used in. In TO you do not know by itself whether read is RED or ReD. In Angel you likewise have to know the context, to know whether NO is no or know, but at least you will be able to read it correctly.

**e**

eKO, eDiBUL, MeDiKUL, FeD, HeD, ReD, DeD

echo, edible, medical, fed, head, red, dead

**i**

iD, iF, iL, iN, iT, iZ, DiP, DiM, TiP

id, if, ill, in, it, is, dip, dim, tip

**x**

DxG, HxG, FxG, DxN, LxN, FxN, KxT, SxD, xF

dog, hog, fog, dawn, lawn, fawn, cot, sod, off

**m**

KmKEZ, FmT, FmL, GmD, HmK, LmK, SmT

cookies, foot, full, good, hook, look, soot

Now, that you know the second column of small vowels, we will look at the last column of vowels, which to a TO reader are some of the strangest looking letters in words. First, there is:

**d**

dc, d, dR, TdL, Hd, Nd, BRdN, Kd

ouch, ow, hour, towel, how, now, brown, cow

You probably can't get any of the words in the vowels in the last column without looking at the prompt. But once you know the secret of each of the five letters you will be able to decipher future words. This is the same problem any new reader in any language has. It is almost like learning how to read again, but you already know the principles of reading. That is, the fact of the relationship of sounds to words, and the figuring out about words because of the context. So, you will catch on very quickly, while for someone who cannot read at all, or who cannot speak the language, it will take a little longer.

**r** aTrNE, aVreJ, BeTr, SrTeN, crc, LATr, NUMBr, Uhr, Wr, WrKr

attorney, average, better, certain, church, later, number, other, were, worker WrKr 33.....

**b**

bL, bNK, Bb, Bb, Tb, TbL, BbL, SbL

oil, oink, bouy, boy, toy, toil, boil, soil

Some people would pronounce bouy as BkE, but it is the nature of ANJeL that we select some one pronunciation, and then that becomes the ANJeL pronunciation. This applies particularly to words that are foreign to English and come into ANJeL. Often ANJeL does not have the accurate French sound, the trilled Spanish R, or some tonal expression of Chinese. The list goes on and on, but we simply Angelize the word. This also applies to some marginal U, ai, and aw sounds in English, and particularly to many schwa sounds. They simply become Angelized. The word angel itself is an example in its becoming ANJeL.

**k**

kZ, kPS, FkL, TkL, Tk, Tk, Tk, BLk, Yk

ooze, oops, fool, tool, to, two, too, blew, you

WE HaV Nd LmKT aT xL UV ANJeL VdLZ. NeKST WE WiL LmK aT hU SMxL KxNSXNaNTS.

**n**

Rin, Rxn, RUn, Ran, Ban, Sin

ring, wrong, rung, rang, bang, sing

**n** needs a preceeding vowel in order to be pronounced. You can't pronounce it with a vowel after it.

Yk KaN Nd RED MXST WrDZ aND SeNTeNSeZ RiTeN iN ANJeL SX I WiL BeGiN RiTin iN ANJeL.

**c**

cAR, cAN, cEP, cIM, ciN, cd, cb, ck

chair, chain, cheep, chime, chin, chow, choy, chew

**s**

sE, sk, siP, sxT, siN, sUN, skT

she, shoe, ship, shot, shine, shun, shoot

**t**

tExLXJE, tiN, tiSuL, tinK

theology, thin, thistle, think

**w**

weR, weN, wI, wxT

where, when, why, what

**z**

azkR, GaRxz, KXRsz, BAz, BeZk, DeSizUN, iNVAsUN, PLezr

azure, garage, corsage, beige, bijou, decision, invasion, pleasure

**z** iZ hU LEST YkZD UV eNE LeTr iN ANJeL.

**h**

hu, hA, heR, heR

the, they, their, there

**h** WxZ hU LaST DiFiKULT LeTr aND SdND FXR A "TX" REDr Tk LrN. **h** iZ eSPesiaLE  
DiFiKULT BEKxZ SUM LiSeNrZ KaNNxT HER hU DiFreNS aND SUM SPEKrZ WiL SA Wit  
aND tin aND uhrZ WiL SA Wih aND hin.

hU REMANin LeTrZ xR hU LxRJ KaPiTxLZ. hEZ xR xL PRiTE MUc SeLF eViDeNT aND Yk  
WiL JUST BREZ hRk heM. WE WiL YkZ heM iN SiLE SeNTeNSeZ hA xR aKckaLE MXR FUN  
Tk GeS aT FRUM FLiP KxRDZ.

## **B**

BaD Bb BxB BkKT hU BiG BXT.

Bad boy Bob booked the big boat.

## **D**

DdN hU DiRTE DUZeN DXV iN hU DEP DIV.

Down the dirty dozen dove in the deep dive.

## **F**

FE, FI, FX, FUM, FERLeS FReDE FkMD FkREUSLE.

Fee, fie, foe, fum, fearless Freddy fumed furiously.

## **G**

GX GeT GRaNDPx Tk Gahr hU GXTS FRUM hU GxRDeN.

Go get grandpa to gather the goats from the garden.

## **H**

Hd HaPE A HXM haT HaZ HxRMUNE.

How happy a home that has harmony.

## **J**

JUST JUDJeZ aND JUST JkREZ GiV JUSTiS.

Just judges and just juries give justice.

## K

KaN Yk KEP hU KxTAJ KLEN?

Can you keep the cottage clean?

## L

LeT xL hU LkS LaDZ LEV.

Let all the loose lads leave.

## M

MI MUhr MAD MeNE MXR.

My mother made many more.

## N

WE NeVr NED NIN NIVZ aT NkN.

We never need nine knives at noon.

## P

PLEZ PaS hU PePrD PETZU

Please pass the peppered pizza.

## R

RUN aRdND hU Rin Wit hU ReD RXZ.

Run around the ring with the red rose.

## S

SiMPUL SiLE SeNTeNSeZ xR skR SUMtin Tk SA.

Simple silly sentences are sure something to say.

**T**

tiS TxPS hU TdN FXR A TRUBULD TUn.

This tops the town for a troubled tongue.

**V**

VxLUMZ UV VbSeZ VxKULIZin VrBZ.

Volumes of voices vocalizing verbs.

**W**

iF Yk WxK xN hU WxTr, Yk WiL GeT WeT.

If you walk on the water, you will get wet.

**Y**

YeS, hU YUn YeLX DxG YaPT aT hU Ykt.

Yes, the young yellow dog yapped at the youth.

**Z**

HE ZaPT hU ZiPr aT hU Zk.

He zapped the zipper at the zoo.

**Yk HaV Nd KUMPLETeD LeSUN tRE. Nd, aFTUR MeMXRIZin hU  
MXST YkZD WrDZ aT hU BeGiNin UV hU LeSUN Yk XNLE NED  
PRaKTiS iN XRDr Tk BEKUM A RaPiD REDr UV ANJeL.**

## End of Tutorial

**MENU: [HOME](#) » [Reconstruction](#) » [Recovery](#) » [Renewal](#) » [Language Main Page](#)**



## hu ciLDReN uV hu NIT

### BI {Edwin} {Arlington} {Robinson} [{Maine} POeT -- 1869-1935.]

[hiS TeKST WoZ F'RST PuBLisT iN 1897, hiS {etext} WoZ TRaNSKRIBD FRuM a 1905 PRiNTig uV hu 1897 eDisuN.]

### hu ciLDReN uV hu NITa BxK uV POeMS BI {Edwin} {Arlington} {Robinson}

TX hu MeMORE uV MI Foh'R aND Muh'R

KoNTeNTS

[hu ciLDReN uV hu NIT](#)

[tRE {Quatrains}](#)

[hu W'RLD](#)

[aN OLD STORE](#)

[{Ballade} uV a siP](#)

[{Ballade} BI hu FIR](#)

[{Ballade} uV BROKeN {Flutes}](#)

[{Ballade} uV DeD FReNDZ](#)

[H'R IZ](#)

[TX MeN](#)

[{Villanelle} uV cANJ](#)

[{John} {Evereldown}](#)

[{Luke} {Havergal}](#)

[hu {HCS,HCZ} oN hu HiL](#)

[{Richard} {Cory}](#)

[TX oKTAVZ](#)

[{Calvary}](#)

[DER FReNDZ](#)



hu STORE uV hu aseZ aND hu FLAM  
FOR SuM POeMS BI {Matthew} {Arnold}  
{Amaryllis}  
{Kosmos}  
{Zola}  
hu PiTE uV hu LEVZ  
{Aaron} SToRK  
hu GoRDeN  
KLiF {Klingenhagen}  
{Charles} {Carville}S IZ  
hu DeD ViLeJ  
{Boston}  
TX SoNeTS  
hu KL'RKS  
{Fleming} {Helphenstine}  
FOR a BxK BI {Thomas} HoRDE  
{Thomas} HxD  
hu MiRaKL  
{Horace} TX {Leuconoe}  
{Reuben} BRIT  
hu oLT'R  
hu TaV'RN  
SoNeT  
{George} {Crabbe}  
KREDO  
oN hu NIT uV a FReNDS WeDig  
SoNeT  
{Verlaine}  
SoNeT  
SuPReMaSE  
hu NIT BeFOR  
{Walt} {Whitman}  
hu KORuS uV OLD MeN iN "{Aegeus}"  
hu WiLD'RNeS  
oKTAVZ  
TX {Quatrains}  
ROMaNS  
hu TOReNT

[{L'Envoi}](#)

hu ciLDReN uV hu NIT

FOR hOZ haT NeV'R NO hu LIT,  
hu DoRKNeS iZ a SuLeN tig;  
aND hA, hu ciLDReN uV hu NIT,  
SEM LoST iN FORcuNS {winnowing}.

BuT SuM oR STRog aND SuM oR {weak}, --  
aND heRS hu STORE. {HCS,HCZ} aND HOM  
oR suT FRuM KCNTLeS HoRTS haT SEK  
W'RLD-ReFUJ haT WiL NeV'R KuM.

aND iF heR BE NO uh'R LIF,  
aND iF heR BE NO uh'R caNS  
TX WA heR SoRRO aND heR STRIF  
haN iN hu SKALZ uV S'RKuMSTeNS,

'T W'R BeT'R, eR hu SuN GO DCN  
uPoN hu F'RST DA WE eMBoRK,  
iN LIFS {imbittered} SE TX DRCN,  
haN SAL FoReV'R iN hu DoRK.

BuT iF heR BE a SOL oN 'Rt  
SO BLINDeD Wit iTS ON {MiSUS,MiSUS}  
uV MaNS ReVELD, iNSeSeNT W'Rt,  
OR WORN Wit aNGGWis, haT iT VUS

NO LIT BuT FOR a MORTaL I,  
NO ReST BuT uV a MORTaL SLEP,  
NO GoD BuT iN a PRoFeTS LI,  
NO FAt FOR "oNeST DCT" TX KEP;

iF heR BE Nutig, GxD OR BaD,  
BuT KAoS FOR a SOL TX TRuST, --  
GoD KCNTS iT FOR a SOL GoN MaD,  
aND iF GoD BE GoD, HE iZ JuST.

aND iF GoD BE GoD, HE iZ LuV;  
aND hO hu DoN BE STiL SO DiM,  
iT sOS uS WE HaV PLAD eNuF

Wit KREDZ haT MAK a FEND uV HiM.

heR iZ WuN KRED, aND ONLE WuN,  
haT GLOREFIZ GoDS eKSSeLeNS;  
SO ceRis, haT HiZ WiL BE DuN,  
hu KoMoN KRED uV KoMoN SeNS.

iT iZ hu KRiMZoN, NoT hu GRA,  
haT coRMS hu TWILIT uV oL TIM;  
iT iZ hu PRoMiS uV hu DA  
haT MAKS hu {starry} SKI SuBLIM;

iT iZ hu FAt WitiN hu FER  
haT HOLDZ uS TX hu LIF WE K'RS; --  
SO LeT uS iN CRSeLVZ ReVER  
hu SeLF wic iZ hu UNiV'RS!

LeT uS, hu ciLDReN uV hu NIT,  
PxT oF hu KLOK haT HIDZ hu SKoR!  
LeT uS BE ciLDReN uV hu LIT,  
aND TeL hu AJeZ woT WE oR!

tRE {Quatrains}

I

aZ Log aZ FAMS iMPEREuS MUZiK RigS  
WiL POeTS MoK iT Wit KRCND W'RDZ oGuST;  
aND HaGoRD MeN WiL KLaMB'R TX BE KigS  
aZ Log aZ GLORE WAZ iTSeLF iN DuST.

{II}

DRigK TX hu SPLeND'R uV hu uNFuLFiLD,  
NOR suD'R FOR hu ReVeLZ haT oR DuN:  
hu WZENZ haT FLusT {Lucullus} oR oL SPiLD,  
hu STRigS haT {Nero} FigG'RD oR oL GoN.

{III}

WE KaNNoT KRCN CRSeLVZ Wit eVREtig,  
NOR KaN WE KOKS hu FATS FOR uS TX KWorReL:  
NO MaT'R woT WE oR, OR woT WE Sig,  
TIM FINDZ a Wih'RD LEF iN eVRE LOReL.

hu W'RLD

SuM oR hu BRuh'RZ uV oL HUMaN-KIND,  
aND ON heM, woT-SO-eV'R heR eSTAT;  
aND SuM, FOR SoRRO aND SeLF-SKORN, oR BLIND  
Wit eNMiTE FOR MaNS {unguarded} FAT.

FOR SuM heR iZ a MUZiK oL DA Log  
LIK {flutes} iN PeRaDIS, hA oR SO GLaD;  
aND heR iZ HeLS e'TRNaL uND'R-Sog  
uV K'RSeZ aND hu KRIZ uV MeN GoN MaD.

SuM SA hu SKEM Wit LuV STaNDZ LXMiNuS,  
SuM SA 'T W'R BeT'R BaK TX KAoS H'RLD;  
aND SO 'T iZ woT WE oR haT MAKS FOR uS  
hu Mez'R aND hu MENig uV hu W'RLD.

aN OLD STORE

STRANJ haT I DiD NoT NO HiM heN,  
haT FReND uV MIN!  
I DiD NoT EVeN sO HiM heN  
WuN FReNDLE SIN;

BuT K'RST HiM FOR hu WAZ HE HaD  
TX MAK ME SE  
MI eNVE uV hu PRAZ HE HaD  
FOR PRAZig ME.

I WxD HaV RiD hu 'Rt uV HiM  
WuNS, iN MI PRID! . . .  
I NeV'R NU hu W'Rt uV HiM  
uNTiL HE DID.

{Ballade} uV a siP

DCN BI hu FLas uV hu ReSTLeS WoT'R  
 hu DiM wIT siP LIK a wIT B'RD LA;  
 LaFig aT LIF aND hu W'RLD hA SoT H'R,  
 aND CT sE SWug TX hu {silvering} BA.  
 heN oF hA FLX oN heR {roystering} WA,  
 aND hu KEN MXN FIRD hu LIT FOM FLlig  
 uP FRuM hu FLuD weR hu FANT SToRZ PLA,  
 aND hu BONZ uV hu BRAV iN hu WAV oR Llig.

'T WoZ a KigS FeR SuN Wit a KigS FeR DoT'R,  
 aND FxL tRE HuNDReD BeSID, hA SA, --  
 ReVeLig oN FOR hu LON, KOLD SLoT'R  
 SO SXN TX SEZ heM aND HID heM FOR A;  
 BuT hA DaNST aND hA DRagK aND heR SOLZ GRX GA,  
 NOR eV'R hA NU uV a GXLS I SPlig  
 heR SPLeND'R a {flickering} FaNToM TX STRA  
 weR hu BONZ uV hu BRAV iN hu WAV oR Llig.

tRX hu MiST uV a DRugKeN DREM hA BRoT H'R  
 (hiS WILD wIT B'RD) FOR hu SE-FENDS PRA:  
 hu PiTELeS REF iN HiZ HoRD KLuc KoT H'R,  
 aND H'RLD H'R DCN weR hu DeD MeN STA.  
 a TORc'Rig SiLeNS uV WoN DiSMA --  
 {Shrieks} aND K'RSeZ uV MaD SOLZ Dlig --  
 heN DCN hA SagK TX SLuMB'R aND SWA  
 weR hu BONZ uV hu BRAV iN hu WAV oR Llig.

eNVQ

PRiNZ, DX U SLEP TX hu SCND {alway}  
 uV hu MORNFuL S'RJ aND hu SE-B'RDZ KRlig? --  
 OR DuZ LuV STiL suD'R aND STEL STiL SLA,  
 weR hu BONZ uV hu BRAV iN hu WAV oR Llig?

{Ballade} BI hu FIR

SLOLE I SMOK aND HuG MI NE,  
 hu wIL a {witless} MaSK'RAD  
 uV tigS haT ONLE ciLDReN SE  
 FLOTS iN a MiST uV LIT aND sAD:  
 hA PaS, a FLiMZE KaVaLKAD,  
 aND Wit a {weak}, {remindful} GLO,

hu FoLig eMB'RZ BRAK aND FAD,  
aZ WuN BI WuN hu {phantoms} GO.

heN, Wit a MeLaNKoLE GLE  
TX tigK weR WuNS MI FaNSE STRAD,  
I MUZ oN woT hu YERZ MA BE  
HXS KuMig TALZ oR oL uNSeD,  
TiL TogS aND suVeL, {snugly} LAD  
WitiN heR saDOD {niches}, GRO  
BI GRiM DeGREZ TX PiK aND SPAD,  
aZ WuN BI WuN hu {phantoms} GO.

BuT heN, woT hO hu MiSTiK tRE  
oRCND ME PLI heR MeRE TRAD? --  
aND {Charon} SXN MA KeRE ME  
aKRoS hu GLXME {Stygian} {glade}? --  
BE uP, MI SOL! NOR BE aFRAD  
uV woT SuM uNBORN YER MA sO;  
BuT MIND YXR HUMaN DeTS oR PAD,  
aZ WuN BI WuN hu {phantoms} GO.

eNVQ

LIF iZ hu GAM haT MuST BE PLAD:  
hiS TRXt aT LEST, GxD FReND, WE NO;  
SO {LIV,LiV} aND LaF, NOR BE DiSMAD  
aZ WuN BI WuN hu {phantoms} GO.

{Ballade} uV BROKeN {Flutes}

(TX a. T. {Schumann}.)

iN DREMS I KRoST a BeReN LaND,  
a LaND uV RXiN, FoR aWA;  
oRCND ME Hug oN eVRE HaND  
a {deathful} STiLNeS uV DeKA;  
aND SiLeNT, aZ iN BLEK DiSMA  
haT Sog sxD huS FORSAKeN BE,  
oN haT FORGoTeN GRCND heR LA  
hu BROKeN {flutes} uV {Arcady}.

hu FOReST haT WoZ oL SO GRaND

weN PIPS aND {tabors} HaD heR SWA  
STxD {leafless} NC, a GOSTLE BaND  
uV SKeLeTuNZ iN KOLD oRA.  
a LONLE S'RJ uV ANseNT SPRA  
TOLD uV aN {unforgetful} SE,  
BuT I'RN BLOS HaD HusT FOR A  
hu BROKeN {flutes} uV {Arcady}.

NO MOR BI SuM'R BREZeZ FaND,  
hu PLAS WoZ DeSoLeT aND GRA;  
BuT STiL MI DREM WoZ TX KoMaND  
NU LIF iNTO haT {shrunkn} KLA.  
I TRID iT. YeZ, U SKaN TX-DA,  
Wit {uncommiserating} GLE,  
hu SogS uV WuN HX STROV TX PLA  
hu BROKeN {flutes} uV {Arcady}.

eNVQ

SO, RoK, I JQN hu KoMoN FRA,  
TX FIT weR MaMoN MA DeKRE;  
aND LEV, TX KRuMBL aZ hA MA,  
hu BROKeN {flutes} uV {Arcady}.

{Ballade} uV DeD FReNDZ

aZ WE hu Wih'RD {ferns}  
BI hu RODWA Llig,  
TIM, hu JeST'R, SP'RNZ  
oL CR PReRS aND PRiig --  
oL CR {TeRZ,TERZ} aND Sliig,  
SoRRO, cANJ, aND WO --  
oL CR weR-aND-{whying}  
FOR FReNDZ haT KuM aND GO.

LIF {awakes} aND B'RNZ,  
AJ aND Det DeFliig,  
TiL aT LaST iT L'RNZ  
oL BuT LuV iZ Dliig;  
LuVS hu TRAD WER PLiig,  
GoD HaZ WiLD iT SO;  
{Shrouds} oR woT WER Bliig

FOR FReNDZ haT KuM aND GO.

MaN FOReV'R Y'RNZ  
FOR hu tig haTS FLIig.  
eVREweR HE T'RNZ,  
MeN TX DuST oR DRiig, --  
DuST haT {wanders}, Iig  
(Wit IZ haT HoRDLE GLO)  
NU FASeZ, DiMLE SPIig  
FOR FReNDZ haT KuM aND GO.

eNVQ

aND huS WE oL oR {nighing}  
hu TRXt WE FER TX NO:  
Det WiL eND CR KRiig  
FOR FReNDZ haT KuM aND GO.

H'R IZ

uP FRuM hu STRET aND hu KRCDZ haT WeNT,  
MORNig aND MiDNIT, TX aND {fro},  
STiL WoZ hu RXM weR HiZ DAZ HE SPeNT,  
aND hu SToRZ W'R BLEK, aND hu NITS W'R SLO.

YER aFT'R YER, Wit HiZ DREM suT FaST,  
HE SuFRD aND STROV TiL HiZ IZ W'R DiM,  
FOR hu LuV haT HiZ BRuseZ HaD 'RND aT LaST, --  
aND hu HOL W'RLD Rag Wit hu PRAZ uV HiM.

BuT HE {cloaked} HiZ TRIuMF, aND S'RcT, iNSTeD,  
TiL HiZ cEKs W'R {sere} aND HiZ HeRZ W'R GRA.  
"heR oR WiMeN eNuF, GoD NOS," HE SeD. . . .  
"heR oR SToRZ eNuF -- weN hu SuNS aWA."

heN HE WeNT BaK TX hu SAM STiL RXM  
haT HaD HeLD HiZ DREM iN hu Log aGO,  
weN HE BeRED HiZ DAZ iN a NAMLeS TXM,  
aND hu SToRZ W'R BLEK, aND hu NITS W'R SLO.

aND a PasuNeT HUMOR SEZD HiM heR --  
SEZD HiM aND HeLD HiM uNTiL heR GRX



LIK LIF oN HiZ KaNVaS, GLOig aND FeR,  
a PeRiLuS FAS -- aND aN ANJeLS, TX.

ANJeL aND MADeN, aND oL iN WuN, --  
oL BuT hu IZ. -- hA W'R heR, BuT YeT  
hA SEMD SuMHC LIK a SOL HaF DuN.  
woT WoZ hu MaT'R? DiD GoD FORGeT? . . .

BuT HE RoT heM aT LaST Wit a SKiL SO sUR  
haT H'R IZ W'R hu IZ uV a DetLeS WxMaN, --  
Wit a GLEM uV HeVeN TX MAK heM PUR,  
aND a GLiM'R uV HeL TX MAK heM HUMaN.

GoD NeV'R FORGeTS. -- aND HE {worships} H'R  
heR iN haT SAM STiL RXM uV HiZ,  
FOR HiZ WIF, aND HiZ KoNSTeNT oRBiT'R  
uV hu W'RLD haT WoZ aND hu W'RLD haT iZ.

aND HE WuND'RZ YeT woT H'R LuV KxD BE  
TX PuNis HiM aFT'R haT STRIF SO GRiM;  
BuT hu LogG'R HE {LIVZ,LiVZ} Wit H'R IZ TX SE,  
hu {plainer} iT oL KuMS BaK TX HiM.

TX MeN

heR BE TX MeN uV oL MaN-KIND  
haT I sxD LIK TX NO aBCT;  
BuT S'Rc aND KWeScuN weR I WiL,  
I KaNNoT eV'R FIND heM CT.

{Melchizedek} HE PRAZD hu LORD,  
aND GAV SuM WIN TX {Abraham};  
BuT HX KaN TeL woT eLZ HE DiD  
MuST BE MOR L'RND haN I aM.

{Ucalegon} HE LoST HiZ {HCS,HCZ}  
weN {Agamemnon} KAM TX {Troy};  
BuT HX KaN TeL ME HX HE WoZ --  
IL PRA hu GoDZ TX GiV HiM JQ.

heR BE TX MeN uV oL MaN-KIND  
haT IM FOReV'R tigKig oN:

hA cAS ME eVREweR I GO, --  
{Melchizedek}, {Ucalegon}.

{Villanelle} uV cANJ

SiNS {Persia} FeL aT MeRatoN,  
hu YeLO YERZ HaV Gah'RD FaST:  
Log SeNc'REZ HaV KuM aND GoN.

aND YeT (hA SA) hu PLAS WiL DoN  
a FaNToM FURE uV hu PaST,  
SiNS {Persia} FeL aT MeRatoN;

aND aZ uV OLD, weN {Helicon}  
TReMBLD aND SWAD Wit RaPc'R VaST  
(Log SeNc'REZ HaV KuM aND GoN),

hiS ANseNT PLAN, weN NIT KuMS oN,  
sAKS TX a GOSTLE BaTL-BLaST,  
SiNS {Persia} FeL aT MeRatoN.

BuT iNTO {soundless} {Acheron}  
hu GLORE uV {Greek} sAM WoZ KaST:  
Log SeNc'REZ HaV KuM aND GoN,

hu SuNZ uV {Hellas} HaV oL sON,  
hu F'RST HaZ FoLeN TX hu LaST: --  
SiNS {Persia} FeL aT MeRatoN,  
Log SeNc'REZ HaV KuM aND GoN.

{John} {Evereldown}

"weR oR U GXig TX-NIT, TX-NIT, --  
weR oR U GXig, {John} {Evereldown}?  
heRS NeV'R hu SIN uV a SToR iN SIT,  
NOR a LaMP haTS NER'R haN {Tilbury} TCN.  
wI DX U STeR aZ a DeD MaN MIT?  
weR oR U PQNTig aWA FRuM hu LIT?  
aND weR oR U GXig TX-NIT, TX-NIT, --  
weR oR U GXig, {John} {Evereldown}?"

"RIT tRX hu FoReST, weR NuN KaN SE,

heRS weR IM GXig, TX {Tilbury} TCN.  
 hu MeN oR aSLEP, -- OR aWAK, MA BE, --  
 BuT hu WiMeN oR KoLig {John} {Evereldown}.  
 eV'R aND eV'R hA KoL FOR ME,  
 aND wIL hA KoL KaN a MaN BE FRE?  
 SO RIT tRX hu FOReST, weR NuN KaN SE,  
 heRS weR IM GXig, TX {Tilbury} TCN."

"BuT wI oR U GXig SO LAT, SO LAT, --  
 wI oR U GXig, {John} {Evereldown}?  
 hO hu ROD BE SMXh aND hu Pat BE STRAT,  
 heR oR TX Log LEGZ TX {Tilbury} TCN.  
 KuM iN BI hu FIR, OLD MaN, aND WAT!  
 wI DX U caT'R CT heR BI hu GAT?  
 aND wI oR U GXig SO LAT, SO LAT, --  
 wI oR U GXig, {John} {Evereldown}?"

"I FoLO hu WiMeN weReV'R hA KoL, --  
 haTS wI IM GXig TX {Tilbury} TCN.  
 GoD NOS iF I PRA TX BE DuN Wit iT oL,  
 BuT GoD iZ NO FReND TX {John} {Evereldown}.  
 SO hu KLCDZ MA KuM aND hu RAN MA FoL,  
 hu saDOS MA KREP aND hu DeD MeN KRoL, --  
 BuT I FoLO hu WiMeN weReV'R hA KoL,  
 aND haTS wI IM GXig TX {Tilbury} TCN."

{Luke} {Havergal}

GO TX hu WeST'RN GAT, {Luke} {Havergal}, --  
 heR weR hu VZeNZ Klig KRiMZoN oN hu WoL, --  
 aND iN hu TWILIT WAT FOR woT WiL KuM.  
 hu {WiND,WIND} WiL MON, hu LEVZ WiL wiSP'R SuM --  
 wiSP'R uV H'R, aND STRIK U aZ hA FoL;  
 BuT GO, aND iF U TRuST H'R sE WiL KoL.  
 GO TX hu WeST'RN GAT, {Luke} {Havergal} --  
 {Luke} {Havergal}.

NO, heR iZ NoT a DoN iN EST'RN SKIZ  
 TX RiFT hu FIRE NIT haTS iN YXR IZ;  
 BuT heR, weR WeST'RN {glooms} oR Gah'Rig,  
 hu DoRK WiL eND hu DoRK, iF eNETig:  
 GoD {slays} HiMSeLF Wit eVRE LEF haT FLIZ,

aND HeL iZ MOR haN HaF uV PeRaDIS.  
NO, heR iZ NoT a DoN iN EST'RN SKIZ --  
iN EST'RN SKIZ.

CT uV a GRAV I KuM TX TeL U hiS, --  
CT uV a GRAV I KuM TX KWeNc hu KiS  
haT FLAMS uPoN YXR FORHeD Wit a GLO  
haT BLINDZ U TX hu WA haT U MuST GO.  
YeZ, heR iZ YeT WuN WA TX weR sE iZ, --  
BiT'R, BuT WuN haT FAt KaN NeV'R MiS.  
CT uV a GRAV I KuM TX TeL U hiS --  
TX TeL U hiS.

heR iZ hu WeST'RN GAT, {Luke} {Havergal},  
heR oR hu KRiMZoN LEVZ uPoN hu WoL.  
GO, -- FOR hu {WINDZ,WiNDZ} oR TeRig heM aWA, --  
NOR tigK TX RiDL hu DeD W'RDZ hA SA,  
NOR eNE MOR TX FEL heM aZ hA FoL;  
BuT GO! aND iF U TRuST H'R sE WiL KoL.  
heR iZ hu WeST'RN GAT, {Luke} {Havergal} --  
{Luke} {Havergal}.

hu {HCS,HCZ} oN hu HiL

hA oR oL GoN aWA,  
hu {HCS,HCZ} iZ suT aND STiL,  
heR iZ Nutig MOR TX SA.

tRX BROKeN WoLS aND GRA  
hu {WINDZ,WiNDZ} BLO BLEK aND sRiL:  
hA oR oL GoN aWA.

NOR iZ heR WuN TX-DA  
TX SPEK heM GxD OR iL:  
heR iZ Nutig MOR TX SA.

wI iZ iT heN WE STRA  
oRCND haT SugKeN SiL?  
hA oR oL GoN aWA,

aND CR PXR FaNSE-PLA  
FOR heM iZ WASTeD SKiL:

heR iZ Nutig MOR TX SA.

heR iZ RXiN aND DeKA  
iN hu {HCS,HCZ} oN hu HiL:  
hA oR oL GoN aWA,  
heR iZ Nutig MOR TX SA.

{Richard} {Cory}

weNeV'R {Richard} {Cory} WeNT DCN TCN,  
WE PEPL oN hu PAVMeNT LxKT aT HiM:  
HE WoZ a JeNTLMaN FRuM SOL TX KRCN,  
KLEN FAVORD, aND iMPEREaLE SLiM.

aND HE WoZ oLWAZ KWIEtLE oRAD,  
aND HE WoZ oLWAZ HUMaN weN HE ToKT;  
BuT STiL HE FLuT'RD PuLSeZ weN HE SeD,  
"GxD-MORNig," aND HE GLiT'RD weN HE WoKT.

aND HE WoZ Ric, -- YeZ, Ric'R haN a Kig, --  
aND aDM'RaBLE SKXLD iN eVRE GRAS:  
iN FIN, WE toT haT HE WoZ eVREtig  
TX MAK uS Wis haT WE W'R iN HiZ PLAS.

SO oN WE W'RKT, aND WATeD FOR hu LIT,  
aND WeNT WitCT hu MET, aND K'RST hu BReD;  
aND {Richard} {Cory}, WuN KoLM SuM'R NIT,  
WeNT HOM aND PxT a BxLeT tRX HiZ HeD.

TX oKTAVZ

I

NoT BI hu GREF haT {stuns} aND {overwhelms}  
oL CTWoRD ReKoGNisuN uV ReVELD  
aND RIcuS {omnipresence} oR hu DAZ  
uV MOST uV uS {affrighted} aND DiZEZD,  
BuT Rah'R BI hu KoMoN SNoRLZ uV LIF  
haT KuM TX TeST uS aND TX STRegteN uS  
iN hiS hu {prentice}-AJ uV DiSKoNTeNT,  
{Rebelliousness}, FANT-{heartedness}, aND sAM.

{II}

weN tRX HoT FoG hu {fulgid} SuN LxKS DCN  
 uPoN a STaGNeNT 'Rt weR LiSTLeS MeN  
 LaB'REuSLE DoDL, K'RS, aND SWeT,  
 DiSKWoLiFID, {unsatisfied}, iN'RT, --  
 iT SEMS TX ME SuMHC haT GoD HiMSeLF  
 SKaNZ Wit a {KLOS,KLOZ} RePROc woT I HaV DuN,  
 KCNTS Wit aN {unphrased} PAseNS MI oRERZ,  
 aND FahoMS MI uNPRoFiTaBL toTS.

{Calvary}

FRenDLeS aND FANT, Wit {martyred} STePS aND SLO,  
 FANT FOR hu FLes, BuT FOR hu SPiRiT FRE,  
 STug BI hu MoB haT KAM TX SE hu sO,  
 hu MaST'R TQLD aLog TX {Calvary};  
 WE JIBD HiM, aZ HE WeNT, Wit {houndish} GLE,  
 TiL HiZ DiMD IZ FOR uS DiD Ov'RFLO;  
 WE K'RST HiZ {vengeless} HaNDZ tRIS {wretchedly}, --  
 aND hiS WoZ NINTEN HuNDReD YERZ aGO.

BuT aFT'R NINTEN HuNDReD YERZ hu sAM  
 STiL KLiG'S, aND WE HaV NoT MAD GxD hu LoS  
 haT CTraJD FaT HaZ eNT'RD iN HiZ NAM.  
 o, weN saL KuM LuVS K'ReJ TX BE STRog!  
 TeL ME, O LORD -- TeL ME, O LORD, HC Log  
 oR WE TX KEP {Christ} RiTig oN hu KRoS!

DER FRENDZ

DER FRENDZ, RePROc ME NoT FOR woT I DX,  
 NOR KCNSeL ME, NOR PiTE ME; NOR SA  
 haT I aM WeRig HaF MI LIF aWA  
 FOR BuBL-W'RK haT ONLE FXLZ P'RSX.  
 aND iF MI BuBLZ BE TX SMoL FOR U,  
 BLO BiG'R heN YXR ON: hu GAMS WE PLA  
 TX FiL hu {frittered} MiNiTS uV a DA,  
 GxD GLaSeZ oR TX {ReD,RED} hu SPiRiT tRX.

aND {whoso} REDZ MA GeT HiM SuM sRXD SKiL;  
 aND SuM uNPRoFiTaBL SKORN ReZIN,

TX PRAZ hu VeRE tig haT HE DePLORZ;  
SO, FReNDZ (DER FReNDZ), ReMeMB'R, iF U WiL,  
hu sAM I WiN FOR Sigig iZ oL MIN,  
hu GOLD I MiS FOR DREMIg iZ oL YXRZ.

hu STORE uV hu aseZ aND hu FLAM

NO MaT'R wI, NOR weNS, NOR weN sE KAM,  
heR WoZ H'R PLAS. NO MaT'R woT MeN SeD,  
NO MaT'R woT sE WoZ; LiVig OR DeD,  
FAtFuL OR NoT, HE LuVD H'R oL hu SAM.  
hu STORE WoZ aZ OLD aZ HUMaN sAM,  
BuT eV'R SiNS haT LONLE NIT sE FLeD,  
Wit BxKS TX BLIND HiM, HE HaD ONLE {ReD,RED}  
hu STORE uV hu aseZ aND hu FLAM.

heR sE WoZ oLWAZ KuMig PRiTE SXN  
TX FXL HiM BaK, Wit PeNiTeNT SKeRD IZ  
haT HaD iN heM hu LaFT'R uV hu MXN  
FOR BaFLD LuV'RZ, aND TX MAK HiM tigK --  
BeFOR sE GAV HiM TIM eNuF TX WigK --  
SiNS KiSeZ W'R hu KEZ TX PeRaDIS.

FOR SuM POeMS BI {Matthew} {Arnold}

SWEPIg hu KORDZ uV {Hellas} Wit F'RM HaND,  
HE WAKS LoST eKOS FRuM SogS KLaSiK sOR,  
aND BRigS heR KRiSTaL KADeNS BaK WuNS MOR  
TX Tuc hu KLCDZ aND SoRROS uV a LaND  
weR GoDS TRXt, {cramped} aND {fettered} Wit a BaND  
uV I'RN KREDZ, HE cERZ Wit GOLDeN LOR  
uV HEROS aND hu MeN haT Log BeFOR  
RoT hu ROMaNS uV AJeZ YeT {unscanned}.

STiL DuZ a KRI tRX SaD {Valhalla} GO  
FOR {Balder}, PERST Wit {Lok}S uNHape SPRA --  
FOR {Balder}, oL BuT SPeRD BI {Frea}S coRMS;  
aND STiL DuZ oRTS iMPEREaL ViSTa sO,  
oN hu HusT SaNDZ uV {Oxus}, FoR aWA,  
Yug {Sohrab} Dlig iN HiZ Foh'RS oRMS.

{Amaryllis}

WuNS, weN I WoND'RD iN hu WxDZ aLON,  
aN OLD MaN ToT'RD uP TX ME aND SeD,  
"KuM, FReND, aND SE hu GRAV haT I HaV MAD  
FOR {Amaryllis}." heR WoZ iN hu TON  
uV HiZ KoMPLANT Suc KWAV'R aND Suc MON  
haT I TxK PiTE oN HiM aND OBAD,  
aND Log STxD LxKig weR HiZ HaNDZ HaD LAD  
aN ANseNT WxMaN, {shrunk} TX SKiN aND BON.

FoR CT BeYoND hu FoReST I KxD HER  
hu KoLig uV LCD PRoGReS, aND hu BOLD  
iNSeSeNT SKREM uV KoM'RZ Rigig KLER;  
BuT hO hu TRuMPeTS uV hu W'RLD W'R GLaD,  
iT MAD ME LONLE aND iT MAD ME SaD  
TX tigK haT {Amaryllis} HaD GRON OLD.

{Kosmos}

o, -- suD'Rig MeN haT FoLT'R aND sRigK SO  
TX LxK oN Det, -- woT W'R hu DAZ WE {LIV,LiV},  
weR LIF iZ HaF a STRuGL TX FORGiV,  
BuT FOR hu LuV haT FiNDZ uS weN WE GO?  
iZ GoD a JeST'R? DuZ HE LaF aND tRO  
PXR BRaNDeD {wretches} HER TX SWeT aND STRIV  
FOR SuM VAG eND haT NeV'R saL oRIV?  
aND iZ HE NoT YeT WERE uV hu sO?

tigK uV iT, oL YE MiLYuNZ haT HaV PLaND,  
aND ONLE PLaND, hu LoRJeS uV HoRD YXt!  
tigK uV iT, oL YE BiLD'RZ oN hu SaND,  
HXS W'RKS oR DCN! -- iZ LuV SO SMoL, FORSXt?  
BE BRAV! TX-MoRRO U WiL uND'RSTaND  
hu DCT, hu PAN, hu TRIuMF, aND hu TRXt!

{Zola}

BeKoZ HE PxTS hu KoMPRoMIZig coRT  
uV HeL BeFOR YXR IZ, U oR aFRAD;  
BeKoZ HE KCNTS hu PRIS haT U HaV PAD  
FOR iNoSeNS, aND KCNTS iT FRuM hu SToRT,  
U LOh HiM. BuT HE SEZ hu HUMAN HoRT  
uV GoD MENwIL, aND iN GoDS HaND HaZ WAD



YXR SKWEMis aND eMaSKULAT KRXSAD  
aGeNST hu GRiM DoMiNYoN uV HiZ oRT.

NeV'R uNTiL WE KogK'R hu uNKXt  
{Connivings} uV CR sAMD iNDiF'ReNS  
(WE KoL iT {Christian} FAt!) oR WE TX SKaN  
hu RaKT aND sREKig {hideousness} uV TRXt  
TX FIND, iN HATS PoLXTeD SeLF-{defence}  
tRoBig, hu PuLZ, hu DiVIN HoRT uV MaN.

hu PiTE uV hu LEVZ

VeNJFuL aKRoS hu KOLD {November} MXRZ,  
LCD Wit aNSeSTRaL sAM heR KAM hu BLEK  
SaD {WiND,WIND} haT sREKT, aND aNS'RD Wit a sREK,  
{Reverberant} tRX LONLE KORiDORZ.  
hu OLD MaN H'RD iT; aND HE H'RD, P'RFORS,  
W'RDZ CT uV LiPS haT W'R NO MOR TX SPEK --  
W'RDZ uV hu PaST haT sxK hu OLD MaNS cEK  
LIK DeD, ReMeMB'RD FxTSTePS oN OLD FLORZ.

aND heN heR W'R hu LEVZ haT PLAGD HiM SO!  
hu BRCN, tiN LEVZ haT oN hu STONZ CTSID  
SKiPT Wit a FREZig wiSP'R. NC aND heN  
hA STOPT, aND STAD heR -- JuST TX LeT HiM NO  
HC DeD hA W'R; BuT iF hu OLD MaN KRID,  
hA FLuT'RD oF LIK Wih'RD SOLZ uV MeN.

{Aaron} SToRK

{Withal} a {meagre} MaN WoZ {Aaron} SToRK, --  
K'RST aND uNKeMPT, sRXD, {shrivelled}, aND MOROS.  
a MIZ'R WoZ HE, Wit a MIZ'RS NOZ,  
aND IZ LIK LiTL DoL'RZ iN hu DoRK.  
HiZ tiN, PiNcT MCt WoZ Nutig BuT a MoRK;  
aND weN HE SPOK heR KAM LIK SuLeN BLOS  
tRX SKaT'RD FagS a FU SNoRLD W'RDZ aND {KLOS,KLOZ},  
aZ iF a K'R W'R {chary} uV iTS BoRK.

GLaD FOR hu M'RM'R uV HiZ HoRD ReNCN,  
YER aFT'R YER HE saMBLD tRX hu TCN, --  
a LuVLeS eKSIL MXVig Wit a STaF;

aND oFTeNTIMS heR KRePT iNTO HiZ ERZ  
a SCND uV ALEiN PiTE, TucT Wit {TeRZ,TERZ}, --  
aND heN (aND ONLE heN) DiD {Aaron} LaF.

hu GoRDeN

heR iZ a {fenceless} GoRDeN OV'RGRON  
Wit BuDZ aND BLoSoMS aND oL SORTS uV LEVZ;  
aND WuNS, aMug hu ROZeZ aND hu {sheaves},  
hu GoRDN'R aND I W'R heR aLON.  
HE LeD ME TX hu PLoT weR I HaD tRON  
hu FeNeL uV MI DAZ oN WASTeD GRCND,  
aND iN haT RiOT uV SaD WEDZ I FCND  
hu {fruitage} uV a LIF haT WoZ MI ON.

MI LIF! o, YeZ, heR WoZ MI LIF, iNDED!  
aND heR W'R oL hu {LIVZ,LiVZ} uV HUMaN-KIND;  
aND hA W'R LIK a BxK haT I KxD {ReD,RED},  
HXS eVRE LEF, MiRaKULuSLE SIND,  
{Outrolled} iTSeLF FRuM toTS eTRNaL SED,  
LuV-RXTeD iN GoDS GoRDeN uV hu MIND.

KLiF {Klingenhagen}

KLiF {Klingenhagen} HaD ME iN TX DIN  
Wit HiM WuN DA; aND aFT'R SXP aND MET,  
aND oL hu uh'R tigS heR W'R TX ET,  
KLiF TxK TX GLaSeZ aND FiLD WuN Wit WIN  
aND WuN Wit W'RMWxD. heN, WitCT a SIN  
FOR ME TX cXZ aT oL, HE TxK hu DRaFT  
uV BiTRNeS HiMSeLF, aND LITLe {quaffed}  
iT oF, aND SeD hu uh'R WuN WoZ MIN.

aND weN I aSKT HiM woT hu {deuce} HE MeNT  
BI DXig haT, HE ONLE LxKT aT ME  
aND GRiND, aND SeD iT WoZ a WA uV HiZ.  
aND hO I NO hu FeLO, I HaV SPeNT  
Log TIM a-WuND'Rig weN I saL BE  
aZ HaPE aZ KLiF {Klingenhagen} iZ.

{Charles} {Carville}S IZ

a MeLaNKoLE FAS {Charles} {Carville} HaD,  
BuT NoT SO MeLaNKoLE aZ iT SEMD, --  
weN WuNS U NU HiM, -- FOR HiZ MCt ReDEMD  
HiZ iNSuFiseNT IZ, FOReV'R SaD:  
iN heM heR WoZ NO LIF-GLiMPS, GxD OR BaD, --  
NOR JQ NOR PasuN iN heM eV'R GLEMD;  
HiZ MCt WoZ oL uV HiM haT eV'R BEMD,  
HiZ IZ W'R SoRRE, BuT HiZ MCt WoZ GLaD.

HE NeV'R WoZ a FeLO haT SeD Muc,  
aND HaF uV woT HE DiD SA WoZ NoT H'RD  
BI MeNE uV uS: WE W'R CT uV Tuc  
Wit oL HiZ wiMS aND oL HiZ tEOREZ  
TiL HE WoZ DeD, SO hoZ BLaGK IZ uV HiZ  
MIT SPEK heM. heN WE H'RD heM, eVRE W'RD.

hu DeD ViLeJ

HER heR iZ Det. BuT EVeN HER, hA SA, --  
HER weR hu DuL SuN sINZ hiS aFT'RNXN  
aZ DeSoLeT aZ eV'R hu DeD MXN  
DiD GLiM'R oN DeD {Sardis}, -- MeN W'R GA;  
aND heR W'R LiTL ciLDReN HER TX PLA,  
Wit SMoL SoFT HaNDZ haT WuNS DiD KEP iN TUN  
hu STRigS haT STRec FRuM HeVeN, TiL TX SXN  
hu cANJ KAM, aND hu MUZiK PaST aWA.

NC heR iZ Nutig BuT hu GOSTS uV tigS, --  
NO LIF, NO LuV, NO ciLDReN, aND NO MeN;  
aND Ov'R hu FORGoTeN PLAS heR KligS  
hu STRANJ aND {unrememberable} LIT  
haT iZ iN DREMS. hu MUZiK FALD, aND heN  
GoD FRCND, aND suT hu ViLeJ FRuM HiZ SIT.

{Boston}

MI NORh'RN PINZ oR GxD eNuF FOR ME,  
BuT heRS a TCN MI MeMORE {uprears} --  
a TCN haT oLWAZ LIK a FReND aPERZ,  
aND oLWAZ iN hu SuNRIZ BI hu SE.  
aND Ov'R iT, SuMHC, heR SEMS TX BE  
a DCNWoRD FLas uV SuMtig NU aND FERZ,

haT eV'R STRIVZ TX KLER, BuT NeV'R KLERZ  
hu {dimness} uV a coRMD aNTiKWITE.

TX SoNeTS

I

JuST aZ I WuND'R aT hu TXFOLD SKREN  
uV TWiSTeD iNoSeNS haT U WxD PLAT  
FOR IZ haT {uncourageously} aWAT  
hu KuMig uV a KigDoM haT HaZ BiN,  
SO DX I WuND'R woT GoDS LuV KaN MEN  
TX U haT oL SO STRANJLE {eSTiMAT,eSTiMeT}  
hu P'RPoS aND hu KoNSeKWeNT eSTAT  
uV WuN sORT suD'Rig STeP TX hu uNSEN.

NO, I HaV NoT YXR BaKWoRD FAt TX sRigK  
LON-FeRig FRuM hu DORWA uV GoDS HOM  
TX FIND HiM iN hu NAMS uV BeRED MeN;  
NOR YXR iNJENEuS {recreance} TX tigK  
WE ceRis, iN hu LIF haT iZ TX KuM,  
hu SKaT'RD FEc'RZ uV DeD FReNDZ aGeN.

{II}

NeV'R uNTiL CR SOLZ oR STRoG eNuF  
TX PLuNJ iNTO hu KRAT'R uV hu SKEM --  
TRiuMFeNT iN hu FLas heR TX ReDEM  
LuVS {handsel} aND FoReV'RMOR TX {SLC,SLuF},  
LIK {cerements} aT a PLAD-CT MaSK, hu RuF  
aND RePTIL SKiNZ uV uS weRoN WE SeT  
hu STiGMa uV SKeRD YERZ -- oR WE TX GeT  
weR aToMS aND hu AJeZ oR WuN STuF.

NOR eV'R saL WE NO hu K'RST WAST  
uV LIF iN hu BeNeFiSeNS DiVIN  
uV SToRLIT aND uV SuNLIT aND SOL-sIN  
haT WE HaV SKWoND'RD iN SiNS FRAL DiSTReS,  
TiL WE HaV DRugK, aND TReMBLD aT hu TAST,  
hu {mead} uV toTS PRoFeTiK {endlessness}.

hu KL'RKS

I DiD NoT tigK haT I sxD FIND heM heR  
 weN I KAM BaK aGeN; BuT heR hA STxD,  
 aZ iN hu DAZ hA DREMD uV weN Yug BLuD  
 WoZ iN heR cEKS aND WiMeN KoLD heM FeR.  
 BE sUR, hA MeT ME Wit aN ANseNT eR, --  
 aND YeZ, heR WoZ a soP-WORN BRuh'RHxD  
 aBCT heM; BuT hu MeN W'R JuST aZ GxD,  
 aND JuST aZ HUMaN aZ hA eV'R W'R.

aND U haT AK SO Muc TX BE SuBLIM,  
 aND U haT FED YXRSeLVZ Wit YXR DeSeNT,  
 woT KuMS uV oL YXR VizuNZ aND YXR FERZ?  
 POeTS aND KigS oR BuT hu KL'RKS uV TIM,  
 {Tiering} hu SAM DuL WeBZ uV DiSKoNTeNT,  
 KLiPig hu SAM SaD {alnage} uV hu YERZ.

{Fleming} {Helphenstine}

aT FRST I toT heR WoZ a {superfine}  
 P'RSWAzuN iN HiZ FAS; BuT hu FRE GLO  
 haT FiLD iT weN HE SToPT aND KRID, "{Hollo}!"  
 sON JQuSLE, aND SO I LeT iT sIN.  
 HE SeD HiZ NAM WoZ {Fleming} {Helphenstine},  
 BuT BE haT aZ iT MA; -- I ONLE NO  
 HE ToKT uV hiS aND haT aND SO-aND-SO,  
 aND LaFT aND {chaffed} LIK eNE FReND uV MIN.

BuT SXN, Wit a KWER, KWIK FRCN, HE LxKT aT ME,  
 aND I LxKT HoRD aT HiM; aND heR WE GAZD  
 Wit a STRAND sAM haT MAD uS KRiNJ aND {wince}:  
 heN, Wit a {wordless} KLoGD aPoLoJE  
 haT SCNDeD HaF KoNFUZD aND HaF aMAZD,  
 HE DoJD, -- aND I HaV NeV'R SEN HiM SiNS.

FOR a BxK BI {Thomas} HoRDE

Wit S'Rcig FET, tRX DoRK S'RKUiTUS WAZ,  
 I PLuNJD aND STuMBLD; RCND ME, FoR aND NER,  
 KWANT HORDZ uV {eyeless} {phantoms} DiD aPER,  
 TWiSTig aND TRNig iN a BXTLeS cAS, --  
 weN, LIK aN eKSIL GiVeN BI GoDS GRAS  
 TX FEL WuNS MOR a HUMaN aTMoSFER,

I KoT hu W'RLDS F'RST M'RM'R, LoRJ aND KLER,  
FLug FRuM a Sigig RiV'RS eNDLeS RAS.

heN, tRX a MaJiK TWILIT FRuM BeLO,  
I H'RD iTS GRaND SaD Sog aZ iN a DREM:  
LIFS WILD iNFiNiTE uV M'Rt aND WO  
iT Sag ME; aND, Wit MeNE a cANJig GLEM,  
aKRoS hu MUZiK uV iTS oNWoRD FLO  
I So hu KoTeJ LITS uV {Wessex} BEM.

{Thomas} HxD

hu MaN HX {cloaked} HiZ BiT'RNes WitiN  
hiS WINDig-sET uV PuNZ aND PLeZaNtREZ,  
GoD NeV'R GAV TX LxK Wit KoMoN IZ  
uPoN a W'RLD uV aNGGWis aND uV SiN:  
HiZ BRuh'R WoZ hu BRaNDed MaN uV {Lynn};  
aND heR oR WOVeN Wit HiZ {jollities}  
hu NAMLeS aND eTRNaL TRaJeDEZ  
haT ReND'R HOP aND HOPLeSNeS aKiN.

WE LaF, aND KRCN HiM; BuT {anon} WE FEL  
a STiL KORD SoRRo-SWePT, -- a WERD uNReST;  
aND tiN DiM saDOS HOM TX MiDNIT STEL,  
aZ iF hu VeRE GOST uV M'Rt W'R DeD --  
aZ iF hu JQZ uV TIM TX DREMS HaD FLeD,  
OR SALD aWA Wit {Ines} TX hu WeST.

hu MiRaKL

"DER BRuh'R, DEReST FReND, weN I aM DeD,  
aND U saL SE NO MOR hiS FAS uV MIN,  
LeT Nutig BuT ReD ROZeZ BE hu SIN  
uV hu wIT LIF I LoST FOR HiM," sE SeD;  
"NO, DX NoT K'RS HiM, -- PiTE HiM iNSteD;  
FORGiV HiM! -- FORGiV ME! . . GoDS aNoDIN  
FOR HUMaN HAT iZ PiTE; aND hu WIN  
haT MAKS MeN WIZ, FORGiVNeS. I HaV {ReD,RED}  
LuVS MeSeJ iN LuVS M'RD'R, aND I DI."  
aND SO hA LAD H'R JuST weR sE WxD LI, --  
uND'R ReD ROZeZ. ReD hA BLXMD aND FeL;  
BuT weN FLusT oTuM aND hu SNOS WeNT BI,

aND SPRig KAM, -- LO, FRuM eVRE BuDS GREn seL  
B'RST a wIT BLoSoM. -- KaN LuV REZON wI?

{Horace} TX {Leuconoe}

I PRA U NoT, {Leuconoe}, TX POR  
Wit {unpermitted} IZ oN woT MA BE  
aPQNTeD BI hu GoDZ FOR U aND ME,  
NOR oN {Chaldean} FiGURZ eNE MOR.  
'T W'R iNFInITLE BeT'R TX iMPLOR  
hu PReZeNT ONLE: -- weh'R {Jove} DeKRE  
MOR WiNT'RZ YeT TX KuM, OR weh'R HE  
MAK EVeN hiS, HXS HoRD, WAV-ETeN sOR  
saT'RZ hu {Tuscan} SEZ TX-DA, hu LaST --  
BE WIZ {withal}, aND RaK YXR WIN, NOR FiL  
YXR BxZoM Wit LoRJ HOPS; FOR wIL I Sig,  
hu eNVEuS {KLOS,KLOZ} uV TIM iZ NeROig; --  
SO SEZ hu DA, -- OR eV'R iT BE PaST, --  
aND LeT hu MoRRo KuM FOR woT iT WiL.

{Reuben} BRIT

BeKoZ HE WoZ a Bxc'R aND heRBI  
DiD 'RN aN oNeST LiVig (aND DiD RIT),  
I WxD NoT HaV U tigK haT {Reuben} BRIT  
WoZ eNE MOR a BRXT haN U OR I;  
FOR weN ha TOLD HiM haT HiZ WIF MuST DI,  
HE STeRD aT heM, aND sxK Wit GREF aND FRIT,  
aND KRID LIK a GRAT BABE HaF haT NIT,  
aND MAD hu WiMeN KRI TX SE HiM KRI.

aND aFT'R sE WoZ DeD, aND HE HaD PAD  
hu Sig'RZ aND hu {sexton} aND hu ReST,  
HE PaKT a LoT uV tigS haT sE HaD MAD  
MOST MORNFuLE aWA iN aN OLD ceST  
uV H'RZ, aND PxT SuM coPT-uP SED'R BCZ  
iN Wit heM, aND {tore} DCN hu SLoT'R-{HCS,HCZ}.

hu oLT'R

aLON, ReMOT, NOR {witting} weR I WeNT,  
I FCND aN oLT'R {builed} iN a DREM --

a FIRE PLAS, weRoF heR WoZ a GLEM  
SO SWiFT, SO S'Rcig, aND SO eLoKWeNT  
uV uPWoRD PRoMiS, haT LuVS M'RM'R, {blent}  
Wit SoRROS WORNig, GAV BuT a SuPREM  
uNeNDig iMPuLZ TX haT HUMaN STREM  
HXS FLuD WoZ oL FOR hu FLAMS FURE BeNT.

aLaS! I SeD, -- hu W'RLD iZ iN hu Rog.  
BuT hu SAM KWeNcLeS FEV'R uV uNReST  
haT tRiLD hu FORMOST uV haT {martyred} tRog  
tRiLD ME, aND I aWOK . . . aND WoZ hu SAM  
BeWiLD'RD iNSeKT PLuNJig FOR hu FLAM  
haT B'RNZ, aND MuST B'RN SuMHC FOR hu BeST.

hu TaV'RN

weNeV'R I GO BI heR NC-a-DAZ  
aND LxK aT hu RagK WEDZ aND hu STRANJ GRaS,  
hu TORN BLX K'RTeNZ aND hu BROKeN GLaS,  
I SEM TX BE aFRAD uV hu OLD PLAS;  
aND SuMtig STiFeNZ uP aND DCN MI FAS,  
FOR oL hu W'RLD aZ iF I So hu GOST  
uV OLD HaM {Amory}, hu M'RD'RD HOST,  
Wit HiZ DeD IZ TRND oN ME oL {aglaze}.

hu TaV'RN HaZ a STORE, BuT NO MaN  
KaN TeL uS woT iT iZ. WE ONLE NO  
haT WuNS Log aFT'R MiDNIT, YERZ aGO,  
a STRANJ'R GaLoPT uP FRuM {Tilbury} TCN,  
HX BRusT, aND SKeRD, aND oL BuT Ov'R-RaN  
haT SK'RT-KRAZD RePRoBAT, {John} {Evereldown}.

SoNeT

O FOR a POeT -- FOR a BEKoN BRIT  
TX RiFT hiS cANJLeS GLiM'R uV DeD GRA;  
TX SPiRiT BaK hu MUZeZ, Log aSTRA,  
aND FLus {Parnassus} Wit a NU'R LIT;  
TX PxT hEZ LiTL SoNeT-MeN TX FLIT  
HX FasuN, iN a sRXD, MeKaNiK WA,  
SogS WitCT SOLZ, haT FLiK'R FOR a DA,  
TX VaNis iN iRReVoKaBL NIT.



woT DuZ iT MEN, hiS BeReN AJ uV CRZ?  
HER oR hu MeN, hu WiMeN, aND hu FLC'RZ,  
hu SEZuNZ, aND hu SuNSeT, aZ BeFOR.  
woT DuZ iT MEN? saL NoT WuN BoRD oRIZ  
TX ReNc WuN BaN'R FRuM hu WeSTRN SKIZ,  
aND MoRK iT Wit HiZ NAM FoReV'RMOR?

{ George } { Crabbe }

GiV HiM hu DoRKeST iNc YXR seLF aLCZ,  
HID HiM iN LONLE GeReTS, iF U WiL, --  
BuT HiZ HoRD, HUMaN PuLZ iZ tRoBig STiL  
Wit hu sUR STRegt haT FERLeS TRXt eNDCS.  
iN SPIT uV oL FIN SIeNS {disavows},  
uV HiZ PLAN eKSSeLeNS aND STuBORN SKiL  
heR YeT ReMANZ woT FasuN KaNNoT KiL,  
hO YERZ HaV tiND hu LOReL FRuM HiZ BRCS.

weh'R OR NoT WE {ReD,RED} HiM, WE KaN FEL  
FRuM TIM TX TIM hu ViGOR uV HiZ NAM  
aGeNST uS LIK a FigG'R FOR hu sAM  
aND eMPTENeS uV woT CR SOLZ ReVEL  
iN BxKS haT oR aZ {altars} weR WE NEL  
TX KoNSeKRAT hu FLiK'R, NoT hu FLAM.

KREDO

I KaNNoT FIND MI WA: heR iZ NO SToR  
iN oL hu sRCDeD HeVeNZ eNEweR;  
aND heR iZ NoT a wiSP'R iN hu eR  
uV eNE LiVig VQS BuT WuN SO FoR  
haT I KaN HER iT ONLE aZ a BoR  
uV LoST, iMPEREaL MUZiK, PLAD weN FeR  
aND ANJeL FigG'RZ WOV, aND uNaWeR,  
DeD LEVZ TX {garlands} weR NO ROZeZ oR.

NO, heR iZ NoT a GLiM'R, NOR a KoL,  
FOR WuN haT WeLKuMS, WeLKuMS weN HE FERZ,  
hu BLaK aND oFuL KAoS uV hu NIT;  
FOR tRX iT oL, -- aBuV, BeYoND iT oL, --  
I NO hu FoR-SeNT MeSeJ uV hu YERZ,  
I FEL hu KuMig GLORE uV hu LIT!

oN hu NIT uV a FReNDS WeDig

iF eV'R I aM OLD, aND oL aLON,  
I saL HaV KiLD WuN GREF, aT eNE RAT;  
FOR heN, tagK GoD, I saL NoT HaV TX WAT  
Muc LogG'R FOR hu {sheaves} haT I HaV SON.  
hu DeViL ONLE NOS woT I HaV DuN,  
BuT HER I aM, aND HER oR SiKS OR AT  
GxD FReNDZ, HX MOST {ingenuously} PRAT  
aBCT MI SogS TX Suc aND Suc a WuN.

BuT eVREtig iZ oL aSKU TX-NIT, --  
aZ iF hu TIM W'R KuM, OR oLMOST KuM,  
FOR heR uNTeNaNTEd MiRoz uV ME  
TX LXZ iTSeLF aND KRuMBL CT uV SIT,  
LIK a ToL siP haT FLOTS aBuV hu FOM  
a LiTL wIL, aND heN BRAKS uT'RLE.

SoNeT

hu MaST'R aND hu SLAV GO HaND iN HaND,  
hO Tuc BE LoST. hu POeT iZ a SLAV,  
aND heR BE KigS DX {sorrowfully} KRAV  
hu {joyance} haT a SKuLYoN MA KoMaND.  
BuT, o, hu SoNeT-SLAV MuST uND'RSTaND  
hu MisuN uV HiZ BoNDeJ, OR hu GRAV  
MA KLaSP HiZ BONZ, OR eV'R HE saL SAV  
hu P'RFekT W'RD haT iZ hu POeTS WoND!

hu SoNeT iZ a KRCN, weRoF hu RIMS  
oR FOR toTS PUREST GOLD hu JXeL-STONZ;  
BuT sAPS aND eKOS haT oR NeV'R DuN  
WiL HoNT hu W'RKsoP, aZ ReGReT SuMTIMS  
WiL BRig Wit HUMaN Y'RNig TX SaD tRONZ  
hu KRas uV BaTLZ haT oR NeV'R WuN.

{ Verlaine }

wI DX U DiG LIK Log-KLoD SKaVeNJ'RZ  
TX Tuc hu KuV'RD KORPS uV HiM haT FLed  
hu uPLaNDZ FOR hu FeNZ, aND RIoTeD

LIK a SiK SAT'R Wit DXMS W'RsiP'RZ?  
KuM! LeT hu GRaS GRO heR; aND LEV HiZ V'RS  
TX TeL hu STORE uV hu LIF HE LeD.  
LeT hu MaN GO: LeT hu DeD FLes BE DeD,  
aND LeT hu W'RMS BE iTS BIoGRaF'RZ.

Sog {sloughs} aWA hu SiN TX FIND {redress}  
iN oRTS KoMPLET ReMeMBReNS: Nutig KLiGS  
FOR Log BuT LOReL TX hu STRiKeN BRC  
haT FeLT hu MUZS FigG'R; Nutig LeS  
haN HeLS {fulfilment} uV hu eND uV tigS  
KaN BLoT hu SToR haT sINZ oN {Paris} NC.

SoNeT

weN WE KaN oL SO eKSSeLeNTLE GiV  
hu Mez'R uV LuVS WiZDoM Wit a BLO, --  
wI KaN WE NoT iN T'RN ReSEV iT SO,  
aND eND hiS M'RM'R FOR hu LIF WE {LIV,LiV}?  
aND weN WE DX SO FRaNTiKaLE STRIV  
TX WiN STRANJ FAt, wI DX WE suN TX NO  
haT iN LuVS eLeMeNTaL OV'R-GLO  
GoDS HOLNeS {gleams} Wit LIT SuP'RLaTiV?

O, BRuh'R MeN, iF U HaV IZ aT oL,  
LxK aT a BRaNc, a B'RD, a cILD, a ROZ, --  
OR eNEtig GoD eV'R MAD haT GROS, --  
NOR LeT hu SMoLeST VizuN uV iT SLiP,  
TiL U KaN {ReD,RED}, aZ oN {Belshazzar}S WoL,  
hu GLORE uV e'T'RNAL PoRTN'RsiP!

SuPReMaSE

heR iZ a {drear} aND LONLE TRaKT uV HeL  
FRuM oL hu KoMoN GLXM ReMXVD aFoR:  
a FLaT, SaD LaND iT iZ, weR saDOS oR,  
HXS {lorn} eSTAT MI V'RS MA NeV'R TeL.  
I WoKT aMug heM aND I NU heM WeL:  
MeN I HaD {slandered} oN LIFS LiTL SToR  
FOR {churls} aND {sluggards}; aND I NU hu SKoR  
uPoN heR BRCS uV WO iNeFaBL.

BuT aZ I WeNT MaJeSTiK oN MI WA,  
 iNTO hu DoRK hA VaNisT, WuN BI WuN,  
 TiL, Wit a saFT uV GoDS eT'RNAL DA,  
 hu DREM uV oL MI GLORE WoZ uNDuN, --  
 aND, Wit a FXLS iMPORcuNeT DiSMA,  
 I H'RD hu DeD MeN Sigig iN hu SuN.

hu NIT BeFOR

LxK U, {Dominie}; LxK U, aND LiSeN!  
 LxK iN MI FAS, F'RST; S'Rc eVRE LIN heR;  
 MoRK eVRE FEc'R, -- ciN, LiP, aND FORHeD!  
 LxK iN MI IZ, aND TeL ME hu LeSoN  
 U {ReD,RED} heR; Mez'R MI NOZ, aND TeL ME  
 weR I aM WoNTig! a MaNS NOZ, {Dominie},  
 iZ oFeN hu KaST uV HiZ iNWoRD SPiRiT;  
 SO MoRK MIN WeL. BuT wI DX U SMIL SO?  
 PiTE, OR woT? iZ iT RiTeN oL OV'R,  
 hiS FAS uV MIN, Wit a BRXTS KoNFesuN?  
 Nutig BuT SiN heR? Nutig BuT HeL-SKoRZ?  
 OR iZ iT BeKoZ heR iZ SuMtig BeT'R --  
 a GLiM'R uV GxD, MABE -- OR a saDO  
 uV SuMtig haTS FoLOD ME DCN FRuM cILDHxD --  
 FoLOD ME oL hEZ YERZ aND KePT ME,  
 SPIT uV MI SLiPS aND SiNZ aND FoLEZ,  
 SPIT uV MI LaST ReD SiN, MI M'RD'R, --  
 JuST CT uV HeL? YeZ? SuMtig uV haT KIND?  
 aND U SMIL FOR haT? UR a GxD MaN, {Dominie},  
 hu WuN GxD MaN iN hu W'RLD HX NOS ME, --  
 MI WuN GxD FReND iN a W'RLD haT {mocks} ME,  
 HER iN hiS HoRD STON KAJ. BuT I LEV iT  
 TX-MoRRO. TX-MoRRO! MI GoD! aM I KRiig?  
 oR hEZ tigS {TeRZ,TERZ}? {TeRZ,TERZ}! woT! aM I FRITeND?  
 I, HX SWOR I sxD GO TX hu SKaFoLD  
 Wit BiG STRog STePS, aND -- NO MOR. I tagK U,  
 BuT NO -- I aM oL RIT NC! NO! -- LiSeN!  
 I aM HER TX BE HagD; TX BE HagD TX-MoRRO  
 aT SiKS OKLoK, weN hu SuN iZ RiZig.  
 aND wI aM I HER? NoT a SOL KaN TeL U  
 BuT hiS PXR siV'Rig tig BeFOR U,  
 hiS FLuT'Rig ReK uV hu MaN GoD MAD HiM,  
 FOR GoD NOS woT WILD REZoN. HER ME,  
 aND L'RN FRuM MI LiPS hu TRXt uV MI STORE.

heRS Nutig STRANJ iN woT I saL TeL U,  
 Nutig MiSTEREuS, Nutig uN'RtLE, --  
 BuT DaMNaBLE HUMaN, -- aND U saL HER iT.  
 NoT WuN uV hOZ LiTL BLaK LoY'RZ HaD GeST iT;  
 hu JuJ, Wit HiZ BiG BoLD HeD, NeV'R NU iT;  
 aND hu JXRE (GoD ReST heR PXR SOLZ!) NeV'R DREMD iT.  
 WuNS heR W'R tRE iN hu W'RLD HX KxD TeL iT;  
 NC heR oR TX. heRL BE TX TX-MoRRO, --  
 U, MI FReND, aND -- BuT heRS hu STORE: --

weN I WoZ a BQ hu W'RLD WoZ HeVeN.  
 I NeV'R NU heN haT hu MeN aND hu WiMeN  
 HX PeTeD aND KoLD ME a BRAV BiG FeLO  
 W'R eV'R LeS HaPE haN I; BuT WiZDoM --  
 wic KuMS Wit hu YERZ, U NO -- SXN sOD ME  
 hu SEKReT uV oL MI GLiT'Rig cILDHxD,  
 hu BROKeN KE TX hu FeREZ KaSL  
 haT HeLD MI LIF iN hu FRes, GLaD SEZoN  
 weN I WoZ hu Kig uV hu 'Rt. heN SLOLE --  
 aND YeT SO SWiFTLE! -- heR KAM hu NoLeJ  
 haT hu {marvellous} LIF I HaD LiVD WoZ MI LIF;  
 haT hu GLOREuS W'RLD I HaD LuVD WoZ MI W'RLD;  
 aND haT eVRE MaN, aND eVRE WxMaN,  
 aND eVRE cILD WoZ a DiF'ReNT BEig,  
 RoT Wit a DiF'ReNT HET, aND FIRd  
 Wit PasuNZ BORN uV a SigGL SPiRiT;  
 haT hu PLez'R I FeLT WoZ NoT heR PLez'R,  
 NOR MI SoRRO -- a KIND uV NAMLeS PiTE  
 FOR SuMtig, I NU NoT woT -- heR SoRRO.  
 aND huS WoZ I ToT MI F'RST HoRD LeSoN, --  
 hu LeSoN WE SuF'R hu MOST iN L'RNig:  
 haT a HaPE MaN iZ a MaN FORGeTFuL  
 uV oL hu TORc'Rig iLZ oRCND HiM.  
 weN OR weR I F'RST MeT hu WxMaN  
 I ceRisT aND MAD MI WIF, NO MaT'R.  
 eNuF TX SA haT I FCND H'R aND KePT H'R  
 HER iN MI HoRT Wit aZ PUR a DeVOsuN  
 aZ eV'R {Christ} FeLT FOR HiZ BRuh'RZ. FORGiV ME  
 FOR NAMig HiZ NAM iN YXR PAseNT PReZeNS;  
 BuT I FEL MI W'RDZ, aND hu TRXt I uT'R  
 iZ GoDS ON TRXt. I LuVD haT WxMaN, --  
 NoT FOR H'R FAS, BuT FOR SuMtig FeR'R,  
 SuMtig {diviner}, I toT, haN BUTE:

I LuVD hu SPiRiT -- hu HUMaN SuMtig  
 haT SEMD TX cIM Wit MI ON KoNDisuN,  
 aND MAK SOL-MUZiK weN WE W'R ToGeh'R;  
 aND WE W'R NeV'R aPoRT, FRuM hu MOMeNT  
 MI IZ FLasT iNTO H'R IZ hu MeSeJ  
 haT SWePT iTSeLF iN a KWiv'Rig aNS'R  
 BaK tRX MI STRANJ LoST BEig. MI PuLSeZ  
 LePT Wit aN AKig SPED; aND hu Mez'R  
 uV hiS GRAT W'RLD GRX SMoL aND SMoL'R,  
 TiL iT SEMD hu SKI aND hu LaND aND hu OseN  
 KLOZD aT LaST iN a MiST oL GOLDeN  
 oRCND uS TX. aND WE STxD FOR a SEZoN  
 LIK GoDZ {outflug} FRuM KAoS, DREMIg  
 haT WE W'R hu Kig aND hu KWEN uV hu FIR  
 haT ReDeND hu KLCDZ uV LuV haT HeLD uS  
 BLIND TX hu NU W'RLD SXN TX BE CRZ --  
 CRZ TX SEZ aND SWA. hu PasuN  
 uV haT GRAT LuV WoZ a NAMLeS PasuN,  
 BRIT aZ hu BLAZ uV hu SuN aT NXNDA,  
 WILD aZ hu FLAMS uV HeL; BuT, MoRK U,  
 NeV'R a wiT LeS PUR FOR iTS F'RVOR.  
 hu {baseness} iN ME (FOR I WoZ HUMaN)  
 B'RAND LIK a W'RM, aND PeRisT; aND Nutig  
 WoZ LeFT ME heN BuT a SOL haT MigGLD  
 iTSeLF Wit H'RZ, aND SWAD aND suD'RD  
 iN FERFuL TRIuMF. weN I KoNSid'R  
 haT HeLPLeS LuV aND hu K'RST FoLE  
 haT ReKT MI LIF FOR hu SAK uV a WxMaN  
 HX BROK Wit a LaF hu cANZ uV H'R MeReJ  
 (woTeV'R hu W'RD MA MEN), I WuND'R  
 iF oL hu WO WoZ H'R SiN, OR weh'R  
 hu cANZ heMSeLVZ W'R eNuF TX {LeD,LED} H'R  
 iN LuVS DeSPIT TX BRAK heM. . . . SiN'RZ  
 aND SANTS -- I SA -- oR RoKT iN hu KRADL,  
 BuT NeV'R oR NON TiL hu WiL WitiN heM  
 SPEKS iN iTS ON GxD TIM. SO I FoST'R  
 EVeN TX-NIT FOR hu WxMaN HX RogD ME,  
 Nutig uV HAT, NOR uV LuV, BuT a FELig  
 uV STiL ReGRet; FOR hu MaN -- BuT HER ME,  
 aND JuJ FOR YXRSeLF: --

FOR a TIM hu SEZuNZ  
 cANJD aND PaST iN a SWET SuKSesuN

haT SEMD TX ME LIK aN eNDLeS MUZiK:  
 LIF WoZ a ROLig {psalm}, aND hu KWIRZ  
 uV GoD W'R GLaD FOR CR LuV. I FaNSED  
 oL hiS, aND MOR haN I DeR TX TeL U  
 TX-NIT, -- YeZ, MOR haN I DeR TX ReMeMB'R;  
 aND heN -- WeL, hu MUZiK SToPT. heR oR MOMeNTS  
 iN oL MeNS {LIVZ,LiVZ} weN iT SToPS, I FaNSE, --  
 OR SEMS TX SToP, -- TiL iT KuMS TX cER heM  
 aGeN Wit a LoRJ'R SCND. hu K'RTeN  
 uV LIF JuST heN iZ LiFTeD a LiTL  
 TX GiV TX heR SIT NU JQZ -- NU SoRROS --  
 OR Nutig aT oL, SuMTIMS. I WoZ Wocig  
 hu SLO, SWET SENZ uV a GOLDeN PiKc'R,  
 FLusT aND aLIV Wit a Log DeLXzuN  
 haT MAD hu M'RM'R uV HOM, weN I suD'RD  
 aND FeLT LIK a NIF haT oFuL SiLeNS  
 haT KuMS weN hu MUZiK GOS -- FOReV'R.  
 hu TRXt KAM Ov'R MI LIF LIK a DoRKNeS  
 Ov'R a FOReST weR WuN MaN {wanders},  
 W'RS haN aLON. FOR a TIM I STaG'RD  
 aND STuMBLD oN Wit a {weak} P'RSiSTeNS  
 aFT'R hu FaNToM uV HOP haT DoRTeD  
 aND DoJD LIK a FRITeND tig BeFOR ME,  
 TX KWiT ME aT LaST, aND VaNis. Nutig  
 WoZ LeFT ME heN BuT hu K'RS uV LiVig  
 aND BeRig tRX oL MI DAZ hu FEV'R  
 aND t'RST uV a PQZOND LuV. W'R I STRogG'R,  
 OR WEK'R, P'RHAPS MI SKORN HaD SAVD ME,  
 GiVeN ME STRegt TX KRus MI SoRRO  
 Wit HAT FOR H'R aND hu W'RLD haT PRAZD H'R --  
 TX HaV LeFT H'R, heN aND heR -- TX HaV KogK'RD  
 haT OLD FoLTSZ LIF Wit a NU aND a WIZ'R, --  
 Suc tigS oR EZE iN W'RDZ. U LiSeN,  
 aND FRCN, I SuPOZ, haT I NeV'R MeNsuN  
 haT BUTeFuL W'RD, FORGiV! -- I FORGAV H'R  
 F'RST uV oL; aND I PRAZD KIND HeVeN  
 haT I WoZ a BRAV, KLEN MaN TX DX iT;  
 aND heN I TRID TX FORGeT. FORGiVNeS!  
 woT DuZ iT MEN weN hu WuN FORGiVeN  
 {Shivers} aND WEPS aND KLiGS aND KiSeZ  
 hu KReJuLuS FXL haT HOLDZ H'R, aND TeLZ HiM  
 a tCZaND tigS uV a GxD MaNS M'RSE,  
 aND heN SLiPS oF Wit a LaF aND PLuNJez

BaK TX hu SiN sE HaZ KWiT FOR a SEZoN,  
 TX TeL HiM haT HeL aND hu W'RLD oR BeT'R  
 FOR H'R haN a PRoFeTS HeVeN? BeLEV ME,  
 hu LuV haT DIZ eR iTS FLAMS oR WASTeD  
 iN S'Rc uV aN ALEiN SOL iZ BeT'R,  
 BeT'R BI FoR haN hu LONLE PasuN  
 haT B'RNZ BaK iNTO hu HoRT haT FEDZ iT.  
 FOR I LuVD H'R STiL, aND hu MOR sE MoKT ME, --  
 FXLD Wit H'R eNDLeS PLEDig PRoMiS  
 uV FUc'R FAt, -- hu MOR I BeLEVD H'R  
 hu PeNiTeNT tig sE SEMD; aND hu STRoG'R  
 H'R cOKig oRMS aND H'R SMoL HoT KiSeZ  
 BCND ME aND B'RND MI BRAN TX PiTE,  
 hu MOR sE GRX TX hu HeVeNLE KREc'R  
 haT BRITeND hu LIF I HaD LoST FoReV'R.  
 hu TRXt WoZ GoN SuMHC FOR hu MOMeNT;  
 hu K'RTeN FeL FOR a TIM; aND I FaNSED  
 WE W'R aGeN LIK GoDZ ToGeh'R,  
 LuVig aGeN Wit hu OLD GLaD RaPc'R.  
 BuT SENZ LIK hEZ, TX oFeN RePETeD,  
 FALD aT LaST, aND H'R GIL WoZ WASTeD.  
 I MAD aN eND uV H'R sRXD KoReSeZ  
 aND TOLD H'R a FU STRAT W'RDZ. sE TxK heM  
 FxL aT heR W'Rt -- aND hu FoRS WoZ Ov'R.

.....

aT F'RST MI DREMS uV hu PaST uPHeLD ME,  
 BuT hA W'R a sORT SuPORT: hu PReZeNT  
 PxsT heM aWA, aND I FeL. hu MisuN  
 uV LIF (woTeV'R iT WoZ) WoZ BLaSTeD;  
 MI GAM WoZ LoST. aND I MeT hu WiN'R  
 uV haT FCL DEL aZ a SiK SLAV Gad'RZ  
 HiZ PANFuL STRegt aT hu SIT uV HiZ MaST'R;  
 aND weN HE WoZ PaST I K'RST HiM, FERFuL  
 uV haT STRANJ caNS wic MAKS uS MITE  
 OR MEN, OR Bot. I K'RST HiM aND HATeD  
 hu STONZ HE PReST Wit HiZ HEL; I FoLOD  
 HiZ EZE MoRc Wit a BaKWorD eNVE,  
 aND K'RST MISELF FOR hu BEST WitiN ME.  
 BuT PRID iZ hu MaST'R uV LuV, aND hu VizUN  
 uV hOZ OLD DAZ GRX FANT aND {fainter}:  
 hu KCNT'RFiT WIF MI M'RSE seLT'RD  
 WoZ Nutig NC BuT a WxMaN, -- a WxMaN  
 CT uV MI WA aND CT uV MI NAc'R.



MI BaTL Wit BLINDeD LuV WoZ OV'R,  
 MI BaTL Wit AKig PRID BeGiNig.  
 iF I WoZ hu LXZ'R aT F'RST, I WuND'R  
 iF I aM hu WiN'R NC! . . . I DCT iT.  
 MI LIF iZ a LXZig GAM; aND TX-MoRRO --  
 TX-MoRRO! -- {Christ}! DiD I SA TX-MoRRO? . . .  
 iZ YXR BRANDE GxD FOR Det? . . . heR, -- LiSeN: --

weN LuV GOS CT, aND a MaN iZ DRiVeN  
 TX suN MaN-KIND FOR hu SKoRZ haT MAK HiM  
 a JOK FOR oL caT'Rig TugS, HE KeREZ  
 a DuBL B'RDEN. hu WOS I SuF'RD  
 aFT'R haT HoRD BeTRAAAL MAD ME  
 PiTE, aT F'RST, oL BREhig KREc'RZ  
 oN hiS BeWiLD'RD 'Rt. I STuDED  
 heR FASeZ aND MAD FOR MiSeLF hu STORE  
 uV oL heR SKaT'RD {LIVZ,LiVZ}. LIK BRuh'RZ  
 aND SiSTRZ hA SEMD TX ME heN; aND I N'RisT  
 a STRANJ'R FRenDsiP RoT iN MI FaNSE  
 BeTWEN hOZ PEPL aND ME. BuT SuMHC,  
 aZ TIM WeNT oN, heR KAM KWER GLaNSeZ  
 CT uV heR IZ, aND hu sAM haT STug ME  
 HeRaST MI PRID Wit a KRAZD iMPResuN  
 haT eVRE FAS iN hu S'RJig SiTE  
 WoZ TRND TX ME; aND I So SLI wiSP'RZ,  
 NC aND heN, aZ I WoKT aND WERED  
 MI WASTeD LIF TWIS OV'R iN BeRig  
 Wit oL MI SoRRO hu SoRROS uV uh'RZ, --  
 TiL I FCND MiSeLF heR FXL. heN I TRemBLD, --  
 a PXR SKeRD tig, -- aND heR PRIig FASeZ  
 TOLD ME hu GaSTLE TRXt: hA W'R LaFig  
 aT ME aND MI FAT. MI GoD, I KxD FEL iT --  
 haT LaFT'R! aND heN hu ciLDReN KoT iT;  
 aND I, LIK a STRuK DoG, KRePT aND LiSeND.  
 aND heN weN I MeT hu MaN HX HaD WEKeND  
 a WxMaNS LuV TX HiZ ON DeZIR,  
 iT SEMD TX ME haT oL HeL W'R LaFig  
 iN FENDis KoNS'RT! I WoZ heR ViKtiM --  
 aND HiZ, aND HATS. aND heR WoZ hu STRuGL!  
 aZ Log aZ hu 'Rt WE TReD HOLDZ SuMtig  
 a TORc'RD HoRT KaN LuV, hu MENig  
 uV LIF iZ NoT HOLE BL'RD; BuT aFT'R  
 hu LaST LuVD tig iN hu W'RLD HaZ LeFT uS,

WE NO hu TRIuMF uV HAT. hu GLORE  
 uV GxD GOS CT FOReV'R; hu BEKON  
 uV SiN iZ hu LIT haT {LEDZ,LeDZ} uS DCNWoRD --  
 DCN TX hu FIRE eND. hu ROD RuNZ  
 RIT tRX HeL; aND hu SOLZ haT FoLO  
 hu K'RST WAZ weR iTS {windings} {LeD,LED} heM  
 SuF'R eNuF, I SA, TX MeRiT  
 oL GRAS haT a GoD KaN GiV. -- hu Fasun  
 uV CR BeLEF iZ TX LiFT oL BEigS  
 BORN FOR a LIF haT NOS NO STRuGL  
 iN SiNS TIT {snares} TX e'TRNaL GLORE --  
 oL aPoRT FRuM hu BRANDeD MiLYuNZ  
 HX KeRE tRX LIF heR FASeZ GRAVeN  
 Wit sUR BRXT SKoRZ haT TeL hu STORE  
 uV heR FCL, FATeD PasuNZ. SiENS  
 HaZ YeT NO SaV TX SMXh OR SoFeN  
 hu KRADL-SKoRZ uV a TIRENTS ViZeJ;  
 NO DRuG TX P'RJ FRuM hu VITaL eSeNS  
 uV SOLZ hu SLEpig VeNoM. V'RcX  
 MA FLC'R iN HeL, weN iTS RXTS oR TWiSTeD  
 aND {WXND,WXND} Wit hu RXTS uV VIS; BuT hu STRogG'R  
 NeV'R iZ NON TiL heR KuMS haT BaTL  
 Wit SiN TX PRXV hu ViKTOR. PeRiLuS  
 tigS oR hEZ DEMuNZ WE KoL CR PasuNZ:  
 SLAVZ oR WE uV heR ROvig FaNSEZ,  
 FXLZ uV heR DeViLis GLE. -- U tigK ME,  
 I NO, iN hiS MoND'Rig WA DeZINig  
 TX {lighten} hu LOD uV MI GiLT aND KaST iT  
 HaF oN hu sOLD'RZ uV GoD. BuT HER ME!  
 IM PoRTLE a MaN, -- FOR oL MI WEKNeS, --  
 iF WEKNeS iT W'R TX STaND aND M'RD'R  
 BeFOR MeNS IZ hu MaN HX HaD M'RD'RD  
 ME, aND DRiVeN MI B'RNig FORHeD  
 Wit HORNZ FOR hu W'RLD TX LaF aT. TRuST ME!  
 aND TRI TX BeLEV MI W'RDZ BuT a PORsuN  
 uV woT GoDS P'RPoS MAD ME! hu KCoRD  
 WitiN ME KRIZ FOR hiS; aND I BeG U  
 NC, aZ I KuM TX hu eND, TX ReMeMB'R  
 haT WiMeN aND MeN oR oN 'Rt TX TRaVeL  
 oL oN a DiF'ReNT ROD. HERaFT'R  
 hu RODZ MA MET. . . . I TRuST iN SuMtig --  
 I NO NoT woT. . . .

WeL, hiS WoZ hu WA uV iT: --  
 STug Wit hu sAM aND hu SEKReT FURE  
 haT KuMS TX hu MaN HX HaZ tRON HiZ PiTaNS  
 uV SeLF aT a TRAT'RS FET, I WoND'RD  
 WEKS aND WEKS iN a BaFLD FRenZE,  
 TiL aT LaST hu DeViL SPOK. I H'RD HiM,  
 aND LaFT aT hu LuV haT STROV TX Tuc ME, --  
 hu DeD, LoST LuV; aND I GRiPT hu DEMoN  
 {KLOS,KLOZ} TX MI BRest, aND HeLD HiM, PRAZig  
 hu FATS aND hu {furies} haT GAV ME hu K'ReJ  
 TX FoLO HiZ WILD KoMaND. FORGeTFuL  
 uV oL TX KuM weN hu W'RK WoZ OVR, --  
 heR KAM TX ME heN NO STONE VizuN  
 uV hEZ tRE HuNDReD DAZ, -- I ceRisT  
 aN oFuL JQ iN MI BRAN. I PoND'RD  
 aND WAD hu tig iN MI MIND, aND {gloried}  
 iN LIF TX tigK haT I WoZ TX KogK'R  
 Det aT HiZ ON DoRK DOR, -- aND cuKLD  
 TX tigK uV iT DuN SO KLENLE. WuN EVNig  
 I NU haT MI TIM HaD KuM. I suD'RD  
 a LiTL, BuT Rah'R FOR DCT haN TeROR,  
 aND FoLOD HiM, -- LeD BI hu NAMLeS DeViL  
 I W'RsiPT aND KoLD MI BRuh'R. hu SiTE  
 sON LIK a DREM haT NIT; hu WiNDOS  
 FLasT Wit a PERSig FLAM, aND hu PAVMeNTS  
 PuLST aND SWAD Wit a WORMt -- OR SuMtig  
 haT SEMD SO heN TX MI FET -- aND tRiLD ME  
 Wit a KWiK, DiZE JQ; aND hu WiMeN  
 aND MeN, LIK {marvellous} tigS uV MaJiK,  
 FLOTeD aND LaFT aND Sag BI MI sOLD'R,  
 SeNT Wit a WiZoRD MOsuN. tRX iT  
 aND OVR aND uND'R iT oL heR SCNDeD  
 a M'RM'R uV LIF, LIK BEZ; aND I LiSeND  
 aND LaFT aGeN TX tigK uV hu FLC'R  
 haT GRX, BLuD-ReD, FOR ME! . . . hiS FeLO  
 WoZ WuN uV hu PoPUL'R SORT HX FL'Ris  
 uNRuFLD weR GoDZ WxD FoL. FOR a KoNseNS  
 HE KeRED a SNUG DeSET haT MAD HiM  
 hu MaN uV hu TIM aND hu PLAS, woTeV'R  
 hu TIM OR hu PLAS MIT BE. W'R HE SCNDig,  
 Wit a JENEaL KRaFT haT {cloaked} iTS P'RPoS,  
 NI TX iTSeLF, hu DePt uV a WxMaN  
 FXLD Wit HiZ {brainless} oRT, OR SeNDig

hu MiDNIT HOM Wit SogS aND BoTLZ, --  
 hu {cad} WoZ heR, aND HiZ EZ FoReV'R  
 sON Wit hu SMXh aND SLiP'RE PoLis  
 haT TeLZ hu SNAK. haT NIT HE DRiFTeD  
 iNTO aN uP-TCN HoNT aND ORD'RD --  
 woTeV'R iT WoZ -- Wit a SoFT asUReNS  
 haT MAD ME MaD aZ I STxD BeHIND HiM,  
 GRiPig HiZ Det, aND WATeD. KCoRD,  
 I tigK, iZ hu NAM hu W'RLD HaZ GiVeN  
 TX MeN LIK ME; BuT IL SWeR I NeV'R  
 toT uV MI ON DiSGRAS weN I soT HiM --  
 YeZ, iN hu BaK, -- I NO iT, I NO iT  
 NC; BuT woT iF I DX? . . . aZ I WocT HiM  
 LIig heR DeD iN hu SKaT'RD SoDuST,  
 WeT Wit a DAS BLON FRot, I NOTeD  
 haT tigS W'R STiL; haT hu WoLNUt TABLZ,  
 weR MeN BuT a MOMeNT BeFOR W'R SiTig,  
 W'R GoN; haT a SKREN uV SuMtig oRCND ME  
 suT heM CT uV MI SIT. BuT hu GiLDeD  
 SINZ uV a HuNDReD BERZ aND {whiskeys}  
 FLasT FRuM hu WoLS aBuV, aND hu MiRORZ  
 aND GLaSeZ BeHIND hu BoR W'R LiTeD  
 iN SuM STRANJ WA, aND iNTO MI SPiRiT  
 a tCZaND saFTS uV TeRiBL FIR  
 B'RNND LIK Det, aND I FeL. hu STORE  
 uV woT KAM heN, U NO.

BuT TeL ME,  
 woT DuZ hu HOL tig MEN? woT oR WE, --  
 SLAVZ uV aN oFuL iGNOReNS? PuPeTS  
 PxLD BI a FEND? OR GoDZ, WitCT NOig iT?  
 DX WE suT FRuM CRSeLVZ CR ON SaLVAsuN, --  
 OR woT DX WE DX! I TeL U, {Dominie},  
 heR oR TIMS iN hu {LIVZ,LiVZ} uV uS PXR DeViLZ  
 weN HeVeN aND HeL GeT MiKST. hO KoNseNS  
 MA KuM LIK a wiSP'R uV {Christ} TX WORN uS  
 aWA FRuM CR SiNZ, iT iZ LoST OR LaFT aT, --  
 aND heN WE FoL. aND FOR oL HX HaV FoLeN --  
 EVeN FOR HiM -- I HOLD NO MaLiS,  
 NOR Muc KoMPasuN: a {mightier} M'RSE  
 haN MIN MuST {shrive} HiM. -- aND I -- I aM GXig  
 iNTO hu LIT? -- OR iNTO hu DoRKNeS?  
 wI DX I SiT tRX hEZ SiKeNig CRZ,

aND HOP? GxD GoD! oR hA CRZ? -- CRZ?  
YeZ! I aM DuN Wit DAZ. aND TX-MoRRO --  
WE TX MA MET! TX-MoRRO! -- TX-MoRRO! . . .

{Walt} {Whitman}

hu MaST'R-SogS oR eNDeD, aND hu MaN  
haT Sag heM iZ a NAM. aND SO iZ GoD  
a NAM; aND SO iZ LuV, aND LIF, aND Det,  
aND eVREtig. BuT WE, HX oR TX BLIND  
TX {ReD,RED} woT WE HaV RiTeN, OR woT FAt  
HaZ RiTeN FOR uS, DX NoT uND'RSTaND:  
WE ONLE BLigK, aND WuND'R.

LaST NIT iT WoZ hu Sog haT WoZ hu MaN,  
BuT NC iT iZ hu MaN haT iZ hu Sog.  
WE DX NoT HER HiM VeRE Muc TX-DA:  
HiZ PERSig aND eTRNaL KADeNS RigS  
TX PUR FOR uS -- TX PC'RFuLE PUR,  
TX LuVigLE TRIuMFeNT, aND TX LoRJ;  
BuT heR oR SuM haT HER HiM, aND hA NO  
haT HE saL Sig TX-MoRRO FOR oL MeN,  
aND haT oL TIM saL LiSeN.

hu MaST'R-SogS oR eNDeD? Rah'R SA  
NO SogS oR eNDeD haT oR eV'R Sug,  
aND haT NO NAMS oR DeD NAMS. weN WE RIT  
MeNS LeT'RZ oN PRCD MoRBL OR oN SaND,  
WE RIT heM heR FoReV'R.

hu KORuS uV OLD MeN iN "{Aegeus}"

YE GoDZ haT HaV a HOM BeYoND hu W'RLD,  
YE haT HaV IZ FOR oL MaNS aGoNE,  
YE haT HaV SEN hiS WO haT WE HaV SEN, --  
LxK Wit a JuST ReGoRD,  
aND Wit aN EVeN GRAS,  
HER oN hu saT'RD KORPS uV a saT'RD Kig,  
HER oN a SuF'Rig W'RLD weR MeN GRO OLD  
aND WoND'R LIK SaD saDOS TiL, aT LaST,  
CT uV hu FLeR uV LIF,  
CT uV hu w'RL uV YERZ,

iNTO hu MiST hA GO,  
iNTO hu MiST uV Det.

O sADZ uV U haT LuVD HiM Log BeFOR  
hu KRXeL tReDZ uV haT BLaK SAL W'R SPuN,  
MA LQaL oRMS aND ANseNT {welcomings}  
ReSEV HiM WuNS aGeN  
HX NC NO LogG'R MXVZ  
HER iN hiS {flickering} DaNS uV cANJig DAZ,  
weR a BaTL iZ LoST aND WuN FOR a Wih'RD REt,  
aND hu BLaK MaST'R Det iZ OV'R oL,  
TX ciL Wit HiZ aPROc,  
TX LeVeL Wit HiZ Tuc,  
hu RANig STRegt uV YXt,  
hu FLuT'RD HoRT uV AJ.

WO FOR hu FATFuL DA weN {Delphi}S W'RD WoZ LoST --  
WO FOR hu LuVLeS PRiNZ uV {Aethra}S LIN!  
WO FOR a Foh'RS {TeRZ,TERZ} aND hu K'RS uV a KigS ReLES --  
WO FOR hu WigS uV PRID aND hu saFTS uV DXM! --  
aND hC, hu SaDeST {WiND,WIND}  
haT eV'R BLX FRuM {Crete},  
Sig hu FeL TiDigS BaK TX haT tRIS uNHape siP! --  
Sig TX hu WeST'RN FLAM,  
Sig TX hu DIig FOM,  
a D'RJ FOR hu {sundered} YERZ aND a D'RJ FOR hu YERZ TX BE!

BeT'R HiZ eND HaD BiN aZ hu eND uV a KLCDLeS DA,  
BRIT, BI hu W'RD uV {Zeus}, Wit a GOLDeN SToR,  
RoT uV a GOLDeN FAM, aND FLug TX hu SeNTRaL SKI,  
TX GLEM oN a {stormless} TXM FOR eV'RMOR: --  
weh'R OR NoT heR FeL  
TX hu Tuc uV aN ALEiN HaND  
hu sEN uV HiZ P'RPL ROB aND hu sIN uV HiZ DIaDeM,  
BeT'R HiZ eND HaD BiN  
TX DI aZ aN OLD MaN DIZ, --  
BuT hu FATS oR eV'R hu FATS, aND a KRCN iZ eV'R a KRCN.

hu WiLD'RNeS

KuM aWA! KuM aWA! heRS a FRoST aLog hu MoRseZ,  
aND a FROZeN {WiND,WIND} haT {skims} hu sOL weR iT sAKS hu DeD BLaK WoT'R;

heRS a MON aKRoS hu LOLaND aND a WALig tRX hu WxDLaND  
 uV a D'RJ haT SigS TX SeND uS BaK TX hu oRMS uV hOZ haT LuV uS.  
 heR iZ Nutig LeFT BuT aseZ NC weR hu KRiMZoN ciLZ uV oTuM  
 PxT oF hu SuM'RS LagG'R Wit a Tuc haT MAD uS GLaD  
 FOR hu GLORE haT iZ GoN FRuM uS, Wit a FLIT WE KaNNoT FoLO,  
 TX hu SLOPS uV uh'R VaLEZ aND hu SCNDZ uV uh'R sORZ.

KuM aWA! KuM aWA! U KaN HER heM KoLig, KoLig,  
 KoLig uS TX KuM TX heM, aND ROM NO MOR.  
 OV'R heR BeYoND hu RiJeZ aND hu LaND haT LIZ BeTWEN uS,  
 heRS aN OLD Sog KoLig uS TX KuM!

KuM aWA! KuM aWA! -- FOR hu SENZ WE LEV BeHIND uS  
 oR BeReN FOR hu LITS uV HOM aND a FLAM haTS Yug FOReV'R;  
 aND hu LONLE TREZ oRCND uS KREK hu WORNig uV hu NIT-{WiND,WIND},  
 haT LuV aND oL hu DREMS uV LuV oR aWA BeYoND hu MCNTeNZ.  
 hu SogS haT KoL FOR uS TX-NIT, hA HaV KoLD FOR MeN BeFOR uS,  
 aND hu {WINDZ,WiNDZ} haT BLO hu MeSeJ, hA HaV BLON TeN tCZaND YERZ;  
 BuT hiS WiL eND CR WoND'R-TIM, FOR WE NO hu JQ haT WATS uS  
 iN hu STRANJNeS uV HOM-KuMig, aND a FAtFuL WxMaNS IZ.

KuM aWA! KuM aWA! heR iZ Nutig NC TX cER uS --  
 Nutig NC TX KuMFORT uS, BuT LuVS ROD HOM: --  
 OV'R heR BeYoND hu DoRKNeS heRS a WiNDO {gleams} TX GRET uS,  
 aND a WORM HoRt WATS FOR uS WitiN.

KuM aWA! KuM aWA! -- OR hu ROVig-FEND WiL HOLD uS,  
 aND MAK uS oL TX DWEL Wit HiM TX hu eND uV HUMaN FeRig:  
 heR oR NO MeN YeT KaN LEV HiM weN HiZ HaNDZ oR KLucT uPoN heM,  
 heR oR NuN WiL ON HiZ eNMiTE, heR oR NuN WiL KoL HiM BRuh'R.  
 SO WEL BE uP aND oN hu WA, aND hu LeS WE BRaG hu BeT'R  
 FOR hu FREDoM haT GoD GAV uS aND hu DReD WE DX NoT NO: --  
 hu FRoST haT SKiPS hu WiLO-LEF WiL aGeN BE BaK TX BLIT iT,  
 aND hu DXM WE KaNNoT FLI FRuM iZ hu DXM WE DX NoT SE.

KuM aWA! KuM aWA! heR oR DeD MeN oL oRCND uS --  
 FROZeN MeN haT MoK uS Wit a WILD, HoRD LaF  
 haT {shrieks} aND SigKS aND wiMP'RZ iN hu sRiL {November} RuseZ,  
 aND hu Log FoL {WiND,WIND} oN hu LAK.

oKTAVZ

## I

TX GeT aT hu eT'RNAL STRegt uV tigS,  
 aND FERLeSLE TX MAK STRog SogS uV iT,  
 iZ, TX MI MIND, hu MisuN uV haT MaN  
 hu W'RLD WxD KoL a POeT. HE MA Sig  
 BuT RuFLE, aND {withal} uNGRASuSLE;  
 BuT iF HE Tuc TX LIF hu WuN RIT KORD  
 weRiN GoDS MUZiK {slumbers}, aND aWAK  
 TX TRXt WuN DRCZD aMBisuN, HE SigS WeL.

## {II}

WE tRiL TX STRANJLE aT hu MaST'RS Tuc;  
 WE sRigK TX SaDLE FRuM hu LoRJ'R SeLF  
 wic FOR iTS ON KoMPLETNeS {agitates}  
 aND {undetermines} uS; WE DX NoT FEL --  
 WE DeR NoT FEL iT YeT -- hu SPLeNDiD sAM  
 uV {uncreated} FALUR; WE FORGeT,  
 hu wIL WE GRON, haT GoDS aKoMPLisMeNT  
 iZ oLWAZ aND uNFALigLE aT HaND.

## {III}

TX MORTaL ERZ hu PLANeST W'RD MA Rig  
 FaNTaSTiK aND uNH'RD-uV, aND aZ FoLTSZ  
 aND CT uV TUN aZ eV'R TX CR ON  
 DiD Rig hu PReRS uV MaN-MAD MANEaKS;  
 BuT iF haT W'RD BE hu PLAN W'RD uV TRXt,  
 iT LEVZ aN eKO haT {begets} iTSeLF,  
 P'RSiStENT iN iTSeLF aND uV iTSeLF,  
 ReJeN'ReT, REiT'RAT, RePLET.

## {IV}

{Tumultuously} VQD uV a KLEN SKEM  
 weRoN TX BiLD, weRoF TX FORMULAT,  
 hu LEJoN LIF haT RiOTS iN MaN-KIND  
 GOS eV'R PLuNJig uPWorD, uP aND DCN,  
 MOST LIK SuM KRAZE ReJiMeNT aT oRMS,  
 uNDiSiPLiND uV oT BuT iGNOReNS,  
 aND eV'R LeD {resourcelessly} aLog



TX {brainless} KoRNeJ BI DRugK TRuMPeT'RZ.

V

TX ME hu GRONig uV W'RLD-W'RsiP'RZ  
RigS LIK a LONLE MUZiK PLAD iN HeL  
BI WuN Wit oRT eNuF TX {cleave} hu WoLS  
uV HeVeN Wit HiZ KADeNS, BuT WitCT  
hu WiZDoM OR hu WiL TX KoMPReHeND  
hu STRANJNeS uV HiZ ON P'RV'RSiTE,  
aND oL WitCT hu K'ReJ TX DeNI  
hu PRoFiT aND hu PRID uV HiZ DeFET.

{VI}

wIL WE oR DRiLD iN eROR, WE oR LoST  
aLIK TX TRXt aND USFuLNeS. WE tigK  
WE oR GRAT WORiORZ NC, aND WE KaN BRaG  
LIK {Titans}; BuT hu W'RLD iZ GROig Yug,  
aND WE, hu FXLZ uV TIM, oR GROig Wit iT: --  
WE DX NoT FIT TX-DA, WE ONLE DI;  
WE oR TX PRCD uV Det, aND TX asAMD  
uV GoD, TX NO eNuF TX BE aLIV.

{VII}

heR iZ WuN BaTL-FELD weRoN WE FoL  
TRiuMFeNT aND {unconquered}; BuT, aLaS!  
WE oR TX {fleshly} FERFuL uV CRSeLVZ  
TX FIT heR TiL CR DAZ oR w'RLD aND BL'RD  
BI SoRRO, aND hu MiNiST'Rig wELZ  
uV aNGGWis TAK uS ESTWoRD, weR hu KLCDZ  
uV HUMaN GLXM oR LoST aGeNST hu GLEM  
haT sINZ oN toTS iMPeNeTRaBL MAL.

{VIII}

weN WE saL HER NO MOR hu KRADL-SogS  
uV AJeZ -- weN hu TIMLeS HiMS uV LuV  
DeFET heM aND {outsound} heM -- WE saL NO  
hu RaPc'R uV haT LoRJ ReLES wic oL  
RIT SIeNS {comprehends}; aND WE saL {ReD,RED},

Wit {unoppressed} aND {unoffended} IZ,  
haT ReKORD uV oL-SOL weRoN GoD RITS  
iN eV'RLaSTig {runes} hu TRXt uV HiM.

{IX}

hu {guerdon} uV NU cILDHxD iZ RePOZ: --  
WuNS HE HaZ {ReD,RED} hu PRiM'R uV RIT toT,  
a MaN MA KLAM BeTWEN TX SMitE STROKS  
BeaTiTUD eNuF TX REaLIZ  
GoDS PeRaLeL KoMPLETNeS iN hu VAG  
aND {incommensurable} eKSSeLeNS  
haT eKWiTaBLE {uncreates} iTSeLF  
aND MAKS a w'RLWiND uV hu UNiV'RS.

KS

heR iZ NO LONLENeS: -- NO MaT'R weR  
WE GO, NOR weNS WE KuM, NOR woT GxD FReNDZ  
FORSAK uS iN hu SEMig, WE oR oL  
aT WuN Wit a KoMPLET KoMPaNYoNsiP;  
aND hO {forlornly} {joyless} BE hu WAZ  
WE TRaVeL, hu KoMPeNSAT SPiRiT- {gleams}  
uV WiZDoM saFT hu DoRKNeS HER aND heR,  
LIK SKaT'RD LaMPS iN {unfrequented} STRETS.

{XI}

weN WuN haT U aND I HaD oL BuT SWORN  
TX BE hu PReST tig GoD eV'R MAD  
BeWiLD'RZ uS uNTiL aT LaST iT SEMS  
aN ANJeL HaZ KuM BaK {restigmatized}, --  
FAt WAV'RZ, aND WE WuND'R woT heR iZ  
oN 'Rt TX MAK uS FAAtFuL eNE MOR,  
BuT NeV'R oR KWIT WIZ eNuF TX NO  
hu WiZDoM haT iZ iN haT WuND'RMeNT.

{XII}

weR DuZ a DeD MaN GO? -- hu DeD MaN DIZ;  
BuT hu FRE LIF haT WxD NO LogG'R FED  
oN {fagots} uV {outburned} aND saT'RD FLes

WAKS TX a tRiLD iNViSiBL aDVaNS,  
{Unchained} (OR {fettered} eLZ) uV MeMORE;  
aND weN hu DeD MaN GOS iT SEMS TX ME  
'T W'R BeT'R FOR uS oL TX DX aWA  
Wit WEpig, aND BE GLaD haT HE iZ GoN.

{XIII}

STiL tRX hu DuSK uV DeD, BLaGK-{legended},  
aND {unremunerative} YERZ WE S'Rc  
TX GeT weR LIF BeGiNZ, aND STiL WE GRON  
BeKoZ WE DX NoT FIND hu LiVig SPoRK  
weR NO SPoRK eV'R WoZ; aND huS WE DI,  
STiL S'Rcig, LIK PXR OLD {astronomers}  
HX ToT'R oF TX BeD aND GO TX SLEP,  
TX DREM uV {untriangulated} SToRZ.

{XIV}

Wit KoNsuS IZ NoT YeT SiNSER eNuF  
TX PERZ hu {glimmered} KLCD haT FLuKcuATS  
BeTWEN ME aND hu {glorifying} LIT  
haT SKRENZ iTSeLF Wit NoLeJ, I DiS'RN  
hu S'Rcig RAZ uV WiZDoM haT REc tRX  
hu MiST uV sAMS iNF'RM KReDULiTE,  
aND iNFiNiTLE WuND'R iF HoRD W'RDZ  
LIK MIN HaV eNE MeSeJ FOR hu DeD.

{XV}

I GRaNT U FReNDsiP iZ a RQaL tig,  
BuT NuN saL eV'R NO haT RQaLTE  
FOR woT iT iZ TiL HE HaZ REaLIZD  
HiZ BeST FReND iN HiMSeLF. 'T iZ heN, P'RFORS,  
haT MaNS uNFeT'RD FAt {indemnifies}  
uV iTS ON KoNsuS FReDoM hu OLD sAM,  
aND LuVS ReVELD iNFiNiTUD SuPLaNTS  
uV iTS ON WeLt aND WiZDoM hu OLD SKORN.

{XVI}

hO hu SiK BEST iNFeKT uS, WE oR FRoT

FOReV'R Wit iNDiSoLUBL TRXt,  
weRiN {redress} ReVELZ iTSeLF DiVIN,  
TRaNZisuNaL, TRaNSeNDeNT. GREF aND LoS,  
DiZEZ aND DeSoLAsuN, oR hu DREMS  
uV WASTeD eKSSeLeNS; aND eVRE DREM  
HaZ iN iT SuMtig uV aN AJLeS FaKT  
haT {flouts} DeFORMiTE aND LaFS aT YERZ.

{XVII}

WE LaK hu K'ReJ TX BE weR WE oR: --  
WE LuV TX Muc TX TRaVeL oN OLD RODZ,  
TX TRIuMF oN OLD FELDZ; WE LuV TX Muc  
TX KoNSeKRAT hu MaJiK uV DeD tigS,  
aND {yieldingly} TX LigG'R BI Log WoLS  
uV RXiN, weR hu RXiNuS MXNLIT  
haT seDZ a Llig GLORE oN OLD STONZ  
BeFReNDZ uS Wit a WiZoRDS eNMiTE.

{XVIII}

SuMtig aZ WuN Wit IZ haT LxK BeLO  
hu BaTL-SMOK TX GLiMPS hu {foeman}S coRJ,  
WE tRX hu DuST uV DCNWoRD YERZ MA SKaN  
hu oNSLoT haT aWATS hiS iDioT W'RLD  
weR BLuD PAZ BLuD FOR Nutig, aND weR LIF  
PAZ LIF TX MaDNeS, TiL aT LaST hu PORTS  
uV GiLDeD HeLPLeSNeS BE BaT'RD tRX  
BI hu STiL KRas uV {salvatory} STEL.

{XIX}

TX U haT SiT Wit SoRRO LIK {chained} SLAVZ,  
aND WuND'R iF hu NIT WiL eV'R KuM,  
I WxD SA hiS: hu NIT WiL NeV'R KuM,  
aND SoRRO iZ NoT oLWAZ. BuT MI W'RDZ  
oR NoT eNuF; YXR IZ oR NoT eNuF;  
hu SOL iTSeLF MuST iNSuLAT hu REaL,  
OR eV'R U DX ceRis iN hiS LIF --  
iN hiS LIF OR iN eNE LIF -- RePOZ.

{XX}

LIK a wIT WoL weRoN FOReV'R BRAKS  
 {Unsatisfied} hu TXMuLT uV GREN SEZ,  
 MaNS {unconjectured} GoDLeNeS ReBUKS  
 Wit iTS iMPEREaL SiLeNS hu LoST WAVZ  
 uV iNSuFiSeNT GREF. hiS MoRTaL S'RJ  
 haT BETS aGeNST uS NC iZ Nutig eLZ  
 haN PLaNJeNT iGNOReNS. TRXt NEh'R sAKS  
 NOR WAV'RZ; BuT hu W'RLD sAKS, aND WE sREK.

{XXI}

NOR JXeLD FRAZ NOR MER MeLiFLXuS RIM  
 {Reverberates} {aright}, OR eV'R saL,  
 WuN KADeNS uV haT iNFiNiT PLAN-Sog  
 wic iZ iTSeLF oL MUZiK. STRogG'R NOTS  
 haN eNE haT HaV eV'R TucT hu W'RLD  
 MuST Rig TX TeL iT -- Rig LIK HaM'R-BLOS,  
 RIT-eKOD uV a cIM PRIMORDEaL,  
 oN {anvils}, iN hu GLEMig uV GoDS FORJ.

{XXII}

hu PRoFeT uV DeD W'RDZ DeFETS HiMSeLF:  
 HXeV'R WxD aKNoleJ aND iNKLXD  
 hu {foregleam} aND hu GLORE uV hu REaL,  
 MuST W'RK Wit SuMtig eLZ haN PeN aND iNK  
 aND PANFuL PRePoRAsuN: HE MuST W'RK  
 Wit uNSEN iMPLeMeNTS haT HaV NO NAMS,  
 aND HE MuST WiN {withal}, TX DX haT W'RK,  
 GxD FoRTiTUD, KLEN WiZDoM, aND STRog SKiL.

{XXIII}

TX K'RS hu ciLD iNSiSTeNS uV hu DoN  
 BeKoZ hu FRE GLEM LigG'RZ; TX DeFRoD  
 hu KoNSTeNT oPORTUNiTE haT {LIVZ,LiVZ}  
 uNcaLeNJD iN oL SoRRO; TX FORGeT  
 FOR hiS LoRJ PRoDiGaLiTE uV GOLD  
 haT LoRJ'R JeN'RoSiTE uV toT, --  
 hEZ oR hu {fleshly} {clogs} uV HUMaN GRED,  
 hu FuNDaMeNTaL BLuND'RZ uV MaN-KIND.

{XXIV}

{Forebodings} oR hu FENDZ uV {Recreance};  
hu MaST'R uV hu MOMeNT, hu KLEN SE'R  
uV AJeZ, TX SeKURLE SKaNZ woT iZ,  
eV'R TX BE aPoLD aT woT iZ NoT;  
HE SEZ BeYoND hu GRONig B'RO LINZ  
uV HeL, GoDS HIWAZ GLEMig, aND HE NOS  
haT LuVS KoMPLET KoMUNYoN iZ hu eND  
uV aNGGWis TX hu LiB'RATeD MaN.

{XXV}

HER BI hu WiNDE DoKS I STaND aLON,  
BuT YeT {companied}. heR hu VeSeL GOS,  
aND heR MI FReND GOS Wit iT; BuT hu WAK  
haT {melts} aND eBZ BeTWEN haT FReND aND ME  
LuVS 'RNeST iZ uV LIFS oL-P'RPoSFuL  
aND oL-TRIuMFeNT SALig, weN hu siPS  
uV WiZDoM LXS heR FReTFuL cANZ aND SWig  
FOReV'R FRuM hu KRuMBLD wORVZ uV TIM.

TX {Quatrains}

I

UNiTE

aZ EoNZ uV iNKaLKULaBL STRIF  
oR iN hu VizuN uV WuN MOMeNT KoT,  
SO oR hu KoMoN, KoNKRET tigS uV LIF  
DiVINLE saDOD oN hu WoLS uV toT.

{II}

PeRaFRAZ

WE sREK TX {LIV,LiV}, BuT NO MaN eV'R {LIVZ,LiVZ}  
TiL HE HaZ RiD hu GOST uV HUMaN BRet;  
WE DREM TX DI, BuT NO MaN eV'R DIZ  
TiL HE HaZ KWiT hu ROD haT RuNZ TX Det.

## ROMaNS

I

BQZ

WE W'R oL BQZ, aND tRE uV uS W'R FReNDZ;  
aND WE W'R MOR haN FReNDZ, iT SEMD TX ME: --  
YeZ, WE W'R MOR haN BRuh'RZ heN, WE tRE. . . .  
BRuh'RZ? . . . BuT WE W'R BQZ, aND heR iT eNDZ.

{II}

{James} {Wetherell}

WE NeV'R HaF BeLEVD hu STuF  
hA TOLD aBCT {James} {Wetherell};  
WE oLWAZ LIKT HiM WeL eNuF,  
aND oLWAZ TRID TX {US,UZ} HiM WeL;  
BuT NC SuM tigS HaV KuM TX LIT,  
aND {James} HaZ VaNisT FRuM CR VU, --  
heR iZ {n't} VeRE Muc TX RIT,  
heR iZ {n't} VeRE Muc TX DX.

hu TOReNT

I FCND a TOReNT FoLig iN a GLeN  
weR hu SuNS LIT sON {silvered} aND LEF-SPLiT;  
hu BXM, hu FOM, aND hu MaD FLas uV iT  
oL MAD a MaJiK SiMFoNE; BuT weN  
I toT uPoN hu KuMig uV HoRD MeN  
TX KuT hOZ PATREoRKaL TREZ aWA,  
aND T'RN TX GOLD hu SiLV'R uV haT SPRA,  
I suD'RD. YeT a GLaDNeS NC aND heN  
DiD WAK ME TX MiSeLF TiL I WoZ GLaD  
iN 'RNeST, aND WoZ WeLKuMig hu TIM  
FOR SKREMiG SoZ TX SCND aBuV hu cIM  
uV IDL WoT'RZ, aND FOR ME TX NO  
hu JeLuS {visionings} haT I HaD HaD  
W'R STePS TX hu GRAT PLAS weR TREZ aND TOReNTS GO.

{L'Envoi}

NC iN a toT, NC iN a saDOD W'RD,  
NC iN a VQS haT tRiLZ eT'RNiTE,  
eV'R heR KuMS aN oNWoRD FRAZ TX ME  
uV SuM TRaNSeNDeNT MUZiK I HaV H'RD;  
NO PiTEuS tig BI SoFT HaNDZ {dulcimered},  
NO TRuMPeT KRas uV BLuD-SiK ViKTORE,  
BuT a GLaD STRAN uV SuM STiL SiMFoNE  
haT NO PRCD MORTaL Tuc HaZ eV'R ST'RD.

heR iZ NO MUZiK iN hu W'RLD LIK hiS,  
NO KeRaKT'R weRWit TX SeT iT DCN,  
NO KIND uV iNSTRuMeNT TX MAK iT Sig.  
NO KIND uV iNSTRuMeNT? o, YeZ, heR iZ!  
aND aFT'R TIM aND PLAS oR Ov'RtRON,  
GoDS Tuc WiL KEP iTS WuN KORD KWiv'Rig.

eND uV hiS PRoJeKT {Gutenberg} {Etext} uV hu ciLDReN uV hu NIT

**MENU:** [HOME](#) » [Reconstruction](#) » [Recovery](#) » [Renewal](#) » [Language Main Page](#)

---

---



## The ACCESS System

### [Description of the ACCESS System](#)

### [Theoretical Basis of the ANJeL Tun](#)

#### [Phonetization](#)

#### [Elementalization](#)

#### [Regularization](#)

### [Description of the System Development](#)

### [Teaching Principles](#)

### [Status and Completion Requirements of the ACCESS System](#)

## Description of the ACCESS System

To obtain experience in the methodology of developing an IAL, the World Language Process has put extensive effort into the the development of the ACCESS System (Auxiliary Closed Captioned English with Simplified Spelling) and its ANJeL Tun as described below. However, it should be emphasized that the UNKOMMON Foundation and the World Language Process is in *NO way* 'solely committed' to the ANJeL Tun and that they will willingly, happily and cheerfully support instead any IAL that humanity may select. In that regards it **MUST BE EMPHASIZED** that *wherever* in the outstanding projects for the ACCESS System or the World Language Process that we make mention of an English related project, that will *then instead* **AUTOMATICALLY** become an IAL project, of whatever the IAL language may be.

## Theoretical Basis of the ANJeL Tun

The ANJeL Tun is the most distinguishing feature of the ACCESS System. ANJeL Tun is sufficiently different to be classified as a separate language from English and while its present purpose is as an Intermediate Teaching Language it may properly be called a pidgin. The name Angel Tongue comes from the story reported in the Webster's International Dictionary that when St. Gregory first heard it being spoken he said that this is surely the lash (the tongue has often been referred to as a whip or lash) of the Angles or Anglash, which evolved into the word English.

ANJeL Tun is based upon three theoretical principles, phonetization, elementalization, and regularization. These technical names are the designation of the author and came from the analysis and study of the theories of a number of experts.

## Phonetization

Phonetization is the Simplified Spelling portion of the ACCESS System. There have been many attempts to develop an acceptable phonetical orthography for English. Historically, English was phonetic but because of the use of dictionaries as the authority for spelling the spelling did not change as the pronunciation did. Two of the best known present phonetic systems for English are WES (World English Spelling) and ITA (Intermediate Teaching Alphabet). In its development phase the ACCESS system has used the character set encoded in new television sets under the law of the U.S. Congress. This has the advantage of permitting materials to be developed anywhere there is type generating equipment that uses the standard English alphabet.

In future development, the ACCESS system would like to become more universal in its access. There may be difficulties to be overcome with the PAL and SECAM television systems used in other parts of the world. In reality, an even more foresighted solution may be necessary. What may actually be needed is an entirely new script because the Roman script is actually limited to 26 characters and it may be that 40 plus characters will be necessary to represent what will be finally accepted as a universal auxiliary language. Developments such as this, in the World Language Process, will probably have to wait upon social developments such as the formation of a world authorized committee with the authority to make such decisions.

The ANJeL Tun FXNeTiK builds upon the research of Dr. Rondthaler and Dr. Lias and a host of scholars that preceded them. Technically, it is possibly more correct to say that the ANJeL Tun is phonemic rather than phonetic. Rather than trying to represent existing speech it phonemically designates the sounds to be associated with its character set.

## Elementalization

Ogden and Richards discovered in their process of writing *The Meaning of Meaning* that there is much redundancy in English both as to words and syntax. Moreover, there are certain core words that are necessary to every English speaker but there are many others that are simply subject oriented. This concept was further developed by Noam Chomsky and found its implementation in what are called Basil texts for teaching English. Extensive use of computer generated word frequency lists have been made to select the actual words used.

Elementary or basic ANJeL Tun uses the Chomsky concept of the distinction between 'form' and 'function' words (the latter including what some people call 'glue' words) to determine those words which should be taught and learned first. The English language has hundreds of thousands of form words which designate both concrete (words like boat, house, hammer, nail) and abstract concepts (like boating, housing, hammering, nailing and more particularly love, truth, beauty and other 'spiritual' ideas).

English, however, has at most only a few hundred 'function' words. These are the words that glue and relate the form words together. They are words like (of, to, if, and, for) and include relational words like (above, below, next, after). The function words are necessary to any form or discussion or writing that arises above pointing and naming. If one were to examine two entirely different essays - one dealing with the activity in a classroom and the other on a farm they would find entirely different form words. In the one essay they would find words like teacher, desks, chairs, blackboards, students, books and so forth and in the other they would find words like barn, cows, chickens, farmer, fields, tractors and so forth. It is easy to distinguish here which would probably be in which essay. However, both essays could share equally well the function words.

The most Elementary or most basic level of ANJeL Tun therefore seeks to teach only the function words. When one knows all the function words (just the few hundred involved) then one can say that they know the language. Of course they could not talk about anything, because they would not have any form words about 'things'. But still, we could not say that they did not know the language. If a Ph.D. in literature or language were to have opened before them a modern computer, and if they knew nothing about computers they could only say that there are colored wires and objects and things of this shape or that but they would not be able to talk intelligibly about the computer any more than they could stand at the elbow of a brain surgeon during an operation and describe the parts of the brain with which the surgeon was dealing. This is not to say, the Ph.D. does not understand the language, they just do not know the words or concepts for those subjects.

Once one has learned the several hundred function words of the ANJeL Tun - then they know the language. But of course they still cannot talk about anything since they do not have the form words. But it is now simple to teach a person the form words for say their employment. A maid might learn the form words for a hotel room (towels, sheets, closet, mattress, bed, and another hundred words) and be able to communicate quite well about her work. Likewise a cook in the kitchen with a different set of words, or any trade such as carpenter, plumber, bricklayer, or electrician. There may be a culturally shared experience involving a set of form words that are understood by most 12 year olds of average brightness. To learn these words - would be a second level of accomplishment. Beyond that, the vocabulary for college admission or some particular profession may be still higher standards.

The size of one's vocabulary is reflective of their education and intellect. Intellectual growth is measured in the concepts and terms that one comprehends. Likewise spiritual growth may well be measured by the abstract terms, reflected in words, that one comprehends in that sphere, and for some this would be the mark of success in life. The concept here is that there can be ranks of elemental terms for any trade or profession - and indeed perhaps for general levels within various cultures themselves. One would build a vocabulary suited to their purpose upon a tree arrangement of the many available elemental lists.

## **Regularization**

English is a language of exceptions but the ANJeL Tun reduces the language as much as possible to a logical system of rules. Some of these concepts, but not nearly so extensively, were applied by Ogden

and Richards. In regards to using the ANJeL Tun as an Intermediate Teaching Method (ITM) the idea is that it is easier to first understand and learn a system of rules and then later to comprehend the exceptions. This conformity to rules is what makes the ANJeL Tun a pidgin.

## Description of the System Development

The ACCESS (Auxiliary Closed Captioned English with Simplified Spelling) system started from the foundation of research on the BASIC English system of C.K. Ogden of London England and Dr. I.A. Richards of Harvard University. The latter received a grant from the Carnegie Foundation to produce movies at Walt Disney Studio to teach the BASIC English system but the cell animation technique of the time proved prohibitively expensive. The BASIC English system initially received considerable personal support from Winston Churchill and Franklin Roosevelt but they both became preoccupied with the concerns of World War II and consequently the BASIC English movement lost its momentum with the death of Ogden.

George Bernard Shaw offered to leave Ogden his fortune if he would combine BASIC English with some form of phonetic spelling but Ogden was adamant in his refusal because of the historic opposition to such phonetic spelling. Ogden's system was used in twenty-two countries and proved extremely beneficial. The claim for the system was that it could teach a person to speak English in just thirty days. The Ogden/Richards system of BASIC English was based on a list of 850 words plus that they felt to be universally accepted. It also had some rules for simplified syntax. The ACCESS System uses the function versus form words insights of Noam Chomsky to further reduce this basic list.

The ACCESS system also adds further rules of syntax simplification, to such a degree that there are no exceptions, the language becomes a pidgin for the purpose of using it as an Intermediate Teaching Media (ITM) on the path to learning traditional English. The teaching language is combined with FXNeTiK spelling so there are no extra or silent letters and the learner can see on the video screen exactly what it is that they are supposed to be hearing.

At least *eleven* major technological advances have occurred in the fifty years since Ogden's and Richards' time that make the development, use and distribution of such a system as this much more feasible than it was in their time. Further specific beneficial developments are anticipated in the near future.

1. There has been the widespread implementation of television into people's homes.
2. There has been the development of home VCRs.
3. There has been the development of captioning technology.

4. There has been the development of large main frame computers for analysing word lists, which were used by the early spelling researchers.
5. There has been the development of the microprocessor and desk"TOP" computers for assisting individual communication and word processing.
6. There has been the key development of non-linear on-line video editing labs (NOVEL) for inexpensively developing and modifying the teaching programs.
7. There have been developed cable distribution systems to provide sufficient channels and efficient distribution of the material.
8. There is being implemented a world wide satellite system with sufficient channels for the efficient distribution of the material world wide.
9. Project Gutenberg has made available hundreds of volumes of classical literature in machine readable form.
10. The Internet has become available for world wide control of distribution of the project.

Most importantly, an *eleventh* reason makes the distribution of the ACCESS system much more feasible today, and that is the defacto acceptance of English as the world wide auxiliary language of business, air traffic control, sea communication, science, and tourism, and perhaps we could also say the world wide web. Over ninety-five percent of all scientific literature is originally written in or later translated into English. There are more movies, videos and other entertainment media originally published in English than in all other languages put together. English has become the Second Language of choice world wide.

While English has become, in the eyes of some, by default, the universal auxiliary language and with the spread of the Internet, and Hollywood videos and movies by satellite, is becoming more entrenched daily, the ACCESS system being used by the World Language Process gives English a number of additional advantages such as permitting traditional English to be machine translated into it untouched by human hands, while the spoken word remains understandable to any traditional English speaker.

While the ACCESS system requires high technology for its development, it has a low technology inexpensive delivery system, working out to a capital cost of less than \$20 per student as compared to the thousands of dollars it often costs to learn a language in North America. Moreover, the other attraction is its great efficiency, requiring only thirty days

to teach a person to speak English.

## Teaching Principles

The ACCESS presentation method of the language is also based upon certain specific pedagogical principles using the formula of listen, look, say, write and do which are tied to a particular theory regarding certain physiological processes of the brain as to learning a language.

The first basic teaching principle behind the ACCESS system is that it is easier for an Adult learner of a new language to see the language (captioning) than it is for them to hear it. With English the problem of using captioning to learn the language has been that since the orthography was not phonetic the learner still could not see what it was they were supposed to have heard.

The second basic teaching principle behind the ACCESS system is that a new English speaker needs only a few hundred words in order to be understood by someone who speaks English. The reciprocal, however, is not true because most native English speakers use a considerably larger vocabulary. Consequently, when the learner knows only a few hundred words they must use a sort of twenty questions game type of communication in order to comprehend what is being said to them.

The third basic teaching principle behind the ACCESS system is that while the learner initially learns a limited rationalized and logical syntactical system that sounds odd to the native speaker it still gives the learner very rapid access to communication and the incentive and confidence to go further.

The theory of the actual pedagogical method, such as "total physical response" will be explained in the teacher correspondence training course and the step by step procedures for applying the method will be outlined in the teacher guide that accompanies each lesson.

There is associated with the ACCESS system a bridge orthography that permits the learner to learn traditional orthography, if they so desire. The main thrust, however, because it is the most difficult learning problem, is to teach the individual to hear the language. This is done through the incentive of entertainment video which is phonetically captioned so that they can see what they are hearing and therefore painlessly practise their hearing skills while watching entertainment video.

However strange the ANJeL Tun may appear to the traditional English speaker and however unlikely it may seem to them that it could ever become a universal language the real issue here is its effectiveness as an ITM for teaching ESL. If the ANJeL Tun is widely accepted then a future committee of scholars may find within it a prototype upon which to build even more rigorously the reforms necessary to make it a universal auxiliary language.

It takes the average literate English speaking person only about two days to become proficient in learning to read and write the ANJeL Tun.

[Return to top](#)

## Status and Completion Requirements of the ACCESS System

- a. The completion of what appears now to be about 18 hours of edited video tape, six hours of which have been edited and for which all the remaining unedited material has already been shot on 30 hours of Betacam SP.
- b. The writing of a student workbook to go along with each of the estimated 18 hour long video tapes, of which four workbooks have been written.
- c. 4,800 illustrations (for which subjects have already been selected) need to be drawn to go into the workbooks and dictionary.
- d. The workbook pages need to be made up, typeset and laid out for printing.
- e. There needs to be a teacher's manual written to accompany each of the hour long videos.
- f. All the above material needs to be packaged.
- g. The system is to be tested among the Spanish speaking population in the prison system of Florida under an arrangement that has been made with the State of Florida.

### Additional projects include:

- h. The publishing of a 8,000 definition simplified phonetic and pictorial dictionary.
- i. The machine translation to simplified phonetic English of all the material on the Project Gutenberg files.
- j. The making available of automatic translation on the Internet of all English files to the simplified phonetic English.
- k. The making of a captioned simplified phonetic English animation series.
- l. The printing of comic books based on the same series.
- m. The publishing of a series of large type simplified phonetic English books of literature.
- n. The publishing of a comprehensive series of a simplified phonetic English books that are an introduction to the sciences.

### Future but more immediate to the World Language Process will be:

- q. The training and sending out of the first 1,000 teachers.
- r. The establishing of Internet procedures to coordinate the teachers' activities.
- s. The establishing of schools and classes throughout the world.

**And as real far out future dreams:**

- o. The publishing of an international newspaper or magazine in simplified phonetic English
- p. A world wide television network captioned in the simplified phonetic English.

**And longer term to the World Language Process:**

- t. The establishing of satellite World Language Institutes throughout the world for the training of teachers.
- u. The establishment of the institutions for further research and development and the establishing and maintaining of standards.

**MENU: [HOME](#) » [Reconstruction](#) » [Recovery](#) » [Renewal](#) » [Language Main Page](#)**

---

---



# Compendium of Ideas of the World Language Process Colloquium for the Regularization of English Syntax as of July 15, 1999 Latest Changes in Red

## Introduction:

The way this compendium works is that forum members submit ideas and discussion to the moderator.

- On the first following update the ideas and comments are added in RED.
- On the second subsequent update, the material is edited, and changed to BLUE.
- That material being considered for deletion will be marked in GREEN.
- On the third subsequent update the material is changed to BLACK.

To join the Colloquium so as to receive the inter-discussion of other members and to submit suggestions and comments for addition to this Compendium, email:

language@webpal.org

Because I am not as conversant, as the rest of you, with the technical terms for describing English grammar I hope that everyone will provide a simple example of what they are saying. Also, anyone who is willing to take over the **editing** of the Compendium, will be most welcomed.

The stage that we are at, at the moment, is to try to list all the possible syntactical reforms that we can suggest for English.

- Those suggestions, that we are considering to try to implement in the ITL (Intermediate Teaching Language) Angel are preceded by the word (ANJeL) in red.
- Those suggestions that have strong recommendation or consensus for inclusion in a reformed English syntax are preceded by the word (REFORM) in blue.
- The remaining ideas are simply present to indicate that they have been presented and have been or are being considered.

Three subjects have been added to this compendium:

- The ranking of the order in which syntactical forms should be taught. (Category 17)

- Discussion regarding the selection of words to be taught in an ITL. (Category 18)
- A list of Links that are beneficial to developing and understanding our cause. Contributions to this category will be appreciated. (Category # to be designated)

**Table of Contents**  
**(Suggestions for- the additions of categories,  
or the combining of categories  
will be very much appreciated)**

## Category 1. Plurals.

**Category 1a. Definition of the Problem with Plurals.**

**Category 1b. Suggestions for Regularization of Plurals.**

**Category 1b1. Consistently use an "s".**

**Category 1b2. Consistently use a "z".**

**Category 1b3. Create a new word for each plural (possibly) from some other language.**

**Category 1b4. Consistently use an additional particle "ZEE".**

**Category 1b5. Consistently use "-en" or "-(schwa symbol)n".**

**Category 1c. Suggestion for the Elimination of Plurals.**

## Category 2. Articles.

**Category 2a. Definition of the Problem with Articles.**

**Category 2b. Regularization of Articles**

**Category 2c. Elimination of Articles**

**Category 3 has been deleted**

## Category 4. Possessives

**Category 4a. Definition of the Problem of Possessives.**

**Category 4b. Alternate Proposals for Possessive**

## **Category 4c. Elimination of the Apostrophe**

**Category 5 has been deleted**

## **Category 6. Adverbs**

**Category 6a. Definition of the Problem of Adverbs.**

**Category 6b. Alternate Proposals for Adverbs**

## **Category 7. Superlatives.**

**Category 7a. Definition of the problem of Superlatives.**

**Category 7b. The use of er to indicate degree and est to to indicate maximum**

**Category 7c. The use of more to indicate degree and most to indicate maximum**

## **Category 8. Adjectives**

**Category 8a. The problem with Adjectives.**

**Category 8b. Alternate proposals for Adjectives**

## **Category 9. Regularization of personal pronouns**

**Category 9a. The Problems with Personal Pronouns**

**Category 9b. Use of "sheet" for third person indiscriminate**

**Category 9c. Elimination of the repeated pronoun**

**Category 9d. Examples of some other suggested remedies**

**Category 9e. Current Angel Inclinations**

## **Category 10. Verb Variations**

**Category 10a. Past Tense Problems**

**Category 10b. A separate word to denote the past tense**

**Category 10c. Elimination of the verb alteration for third person singular.**

**Category 10d. Elimination of the past tense**

**Category 10e. Other advantages to verb regularization**

## **Category 11. Courtesies**

**Category 12 has been deleted**

**Category 13 has been deleted**

## **Category 14. Regularisation of Grammar**

**Category 14a. According to the word-order principle**

**Category 14b. Elimination of the accusative**

**Category 14c. Simplification of end phrase interrogative**

**Category 15 has been deleted**

**Category 16 has been deleted**

## **Category 17. The order in which syntactical forms should be taught.**

## **Category 18. Reduction of word meanings in the elemental list.**

## **Category 19. A regularized number system**

## **Category 20. Philosophical Discussion**

---

## **Category 1. Plurals.**

### **Category 1a. Definition of the Problem with Plurals.**

The use of plurals provides additional information, ie. that there is more than one. A few languages are much more specific in that they use specific nouns and verbs to indicate specific numbers up to four. However, there are numbers of languages that do not indicate plurality at all. In this, English is inconsistent, and therein lies the

problem, since the goal of regularization is to make English consistent, therefore regular.

In English we oftentimes add an "s" to a word to make it plural. Therefore cat and cats. However, very often, the "s" is given a "z" sound. Thus, dog becomes dogs, but in a phonetic system this would be written dogz. This means that plurals would sometimes be presented with an "s" and sometimes with a "z". Nor is even this the extent of the problem because the plural is sometimes represented by es, such as in beach and beaches, or more correctly, phonetically, beach and beachez.

Nor does the above conclude the problem. For a number of words, there is a special word for the plural form. As an example, for man and mouse, we have men and mice. On the other hand there are words that have no plural. Such as sheep, elk, moose, and others. While these examples involve animals, there is no rule limiting it to animals, and no consistency about applying it to animals.

To summarize the five examples:

- cat - cats
- dog - dogz
- beach - beachez
- mouse - mice
- sheep - sheep

Perhaps we can answer this question by considering some English nouns that are invariant whether singular or plural: "deer, moose, elk, sheep, grouse, woodcock, salmon, cod". It is notable that these animals are all normally regarded as game or food.

[] Consistent with lack of a plural in othr nouns tht ar comnly referd to in terms of quantity rathr than number, e.g. grain, butter, wool, tar -- their plurals usually refer to 'varieties of...'

[Antony] Exactly so: "a bundle of wool" vs "a bundle of wools"; but if we abolish the plural affix we obviously cannot say "a bundle of varieties of wool" - and "a bundle of variety of wool" is not quite the same thing, is it?

[Doug] ....I've scant knowledge of (other) Eastern languages -- I suspect the normal practice is to let context indicate number / plurality, as in English "six deer"....

[Antony] You've probably more knowledge than I have. The most I've picked up is that many languages - including Chinese, Japanese and pidgins / creoles - do not normally employ plurals.

I can see how people cope quite well without a noun plural in traditional cultures: "I have five cow" - the meaning is normally clear enough: a cow is usually just a cow.

But in modern society, with its diversification, standardisation and mass production, the statement is more likely to require elaboration. I might well have a mixture of breeds.

Well, how about "I have five computer"? This statement definitely need qualification. Are the computers the same, or different?

I suggest we regularize the plural on the basis of current usage. For example, if a storeman orders "ten oil" we know he means "ten (identical units of) oil", but we understand an aromatherapist with "ten oils" to have "ten (different) oils".

The numeral is a quantifier; the plural is a diversifier. I think it might be an advance if we could say "I have five cow" or "I have five cows" - the difference between the statements being understood.

[Doug, May 3] The question arises then: What is a regular plural? The suffix '-(i)z' has points favoring it abuv '-(e)s':

1. Iz comnly so writn in advertizing matr, e.g. 'Beanz meanz Heinz', my neihrhood handiman servis 'Fixzit', as in other wordz with 's' as writn standard, e.g. a lubricant 'Ezy-Glide'.

2. Reflects actual sound after all wordz except folowing th soundz ov  $\text{€}$ ,  $\text{€h}$  (unvoist, tho some speakerz turn it to 'dh' before sufixt -s, analogous to change ov 'f' to 'v' sound in pluralz ov calf, hoof, leaf &s.),  $\text{€k}$ ,  $\text{€p}$ .

2. Cd b replaced by 's' where so sounded, just as we replace the word 'a' by 'an' where adjoining sounds require it; but even if -(i)z were made constant fr the plural sufix morfeme it wd automaticaly b red az 's' az it iz in 'Ritz, Fritz'.

3. It wil hasten th redundancy and so the removal of a second 's' in wurfdz tht uze it only t dstinguish them from wurdz with 's' sufix sounded 'z' e.g. 'needles(s).

It's noteworthy tht most French pluralz sound exzactly th same as their singulars, perhaps a major reason fr the wider use ov th definit articl (which indicates plurality) in French

[Robert] Oriental (and otder) languages kan individualise, e.g. "horse, a horse; man, a man". "A group of horse, a group of dog" etc. is not so strange.

Now let us contrast some concrete nouns which take either the singular or the plural form in the plural number: "lion\lions, tiger\tigers, elephant\elephants, partridge\partridges, horse\horses, grass\grasses, ivy\ivies, mistletoe\mistletoes". In each case the first is game, cannon-fodder, food or a parasite, and the second is a collection of individuals, whether in appearance, temperament or species.

[] -- i.e. they are countable (how meny) rather than quantifiable (how much).

It occurs to me that Eastern culture derogates plurals for the same reason it tends to believe that "the protruding nail should be hammered down". Western culture may tend towards excessive anthropomorphism and sentimentality but it would nevertheless probably resist referring to a group of dogs, cats or horses as "dog", "cat" or "horse".

[] Judging only by Melanesian Pidgin English (Pisin) -- I've scant knowledge of (other) eastern languages -- I suspect the normal practice is to let context indicate number/ plurality, as in English "six deer". There are Pisin plural pronouns but (as with English 'you') these are not all obligatory if context suffices. The occasionally

needed plural particle corresponds to the plural third person pronoun (ol). English resorts to an equivalent at times with 'you all' (dialectal 'y'all'), 'you lot/ mob' etc. I favorf 'lot' in general. Some ('subcultural'0 Australians use 'youse' as a plural.

## Category 1b. Suggestions for Regularization of Plurals.

### Category 1b1. Consistently use an "s".

Then sheep becomes sheeps.

However in a phonemic system it is difficult, if not impossible, to pronounce fish as fishs. We seem to wish to say fishes.

### Category 1b2. Consistently use a "z".

Then sheep becomes sheepz.

However, this too seems strained, in a phonemic system, when we try to pronounce cats as catz.

### Category 1b3. Create a new word for each plural (possibly) from some other language.

This would greatly expand the language and make it more complicated for anyone to learn. Every new noun would have to be created in two forms, sigular and plural.

### Category 1b4. Consistently use an additional particle "ZEE".

1. cat - catZEE
2. dog - dogZEE
3. beach - beachZEE
4. mouse - mouseZEE
5. sheep - sheepZEE

This appears to be a very workable solution. It means that the ITL learner has to learn only one additional rule. The format may be slightly grating (it will certainly be distinctive) to Traditional English listeners.

>[Robert] ...better (I think) would be "-ze": "cat-ze, dog-ze, beach-ze, >mouse-ze, sheep-ze". Native speakers could pronounce "catz, dogz, beach'z, >mouse'z, sheeps".

[] There ar 3 spoken regular pluralz in English: s, 'z, z (using ' for schwa):

[] 1. -s only suffixt to final voiceless consonant sound of ɸ (tho singular -fs is often replaced by 'irregular' plural -vz az in calves, hooves),

ɸk, ɸp, ɸt or

ɸh (tho -ths is sometimes replaced by 'irregular' -dhz sound e.g. in oaths, sheaths, and some 'substandard' speakers revert to -'z e.g. for paths)

[] 2. -'z suffixt to other voiceless sibilant (s,sh e.g. asses,ashes) and z, zh sounds (e.g. phases, edges).

[] 3. -z elsewhere (sofas, rays, ploughs, ebbs, abodes, ears, crows &s.)

[] This suggests that 'z or ez wd be mor lojicl than ze. If we recomend abreviatd formz fr comn wurdz (to unstrest = t , do = d, be = b , for = fr ) this particle/sufix cd bcum just z t suit mor peopl. It wd create new homofonez, not just th posesiv sufix mentiond blow (Ted's hat) bt unstrest as/ az (good z gold) and voiced 's v cloqial speech (Ted's here -- Tedz here or Ted z here)).

### **Category 1b5. Consistently use "-en" or "-(schwa symbol)n".**

Possibly worth discussing - a reversion to the original Teutonic form still found in German and in "oxen, men, child(r)en". That would allow the genitive/possessive to have the monopoly on "-z".

[] I prefer use ov -n as comn in coloqial English fr 'individual' e.g. young'n, good'n. It cn regularize - ((er)m)an, -ian, -eon, -ent, -(e)ant, -ar/er/or/ress/rix, -one fr 'agent' suffixz ov e.g. fisher(man), musician, surgeon, correspondent, sergeant, appellant, pedlar, cobbler, actor, actress, aviatrix, everyone.

### **Category 1c. Suggestion for the Elimination of Plurals.**

Plurals might also be eliminated, and since one consideration is that of simplification of the syntax in a way that permits one in an ITL to more easily learn the language this could be the easiest solution.

It would be one less rule for the learner to learn and it might be less grating to hear, for those used to Traditional English. As an example:

- a. There is a sheep in the road.
- b. There are sheep in the road.
- c. Sheep in road.
- d. Look out for the sheep.
- e. Look out for sheep.
- f. Look out for car.

[Robert] Tde Chinese du not regularli indikate plural: haw du tdei deal with tdi problem illustrated "Look out for cars"? (Tdere is much tu bi learned from China de grammar.)

In cases a and b there is the additional complication of making the verb agree with the singularity or plurality of the noun. If a passenger were issuing a warning to a driver, case c would be equally effective.

In cases d and e, does it really make any difference whether there is more than one sheep or not? As in case f wouldn't make any difference to warn a child about to cross the street to look out for one or more than one car.

In cases where number IS important one could say:

- "Look out for both car."
- "Look out for two car."
- "Look out for many car."



"Look out for some car."

"Look out for all car."

What interplay there might be between an ITL and an IAL in this regards, is a different matter. If an ITL were widely used, it might effect current practice in the IAL. On the other hand, if the IAL maintains a strong historical relationship to Traditional English, then all the rules and exceptions listed at the outset of this category, would remain, and would remain to be assimilated by anyone making the transition to Traditional English.

Click here to return to the  
[Table of Contents](#)

---

## Category 2. Articles.

### Category 2a. Definition of the Problem with Articles.

Articles (a, an, the, this, that, etc) are part of the glue words of the English language. There are definite and indefinite articles. There is little distinction between

"Bring me any dog" and "Bring me a dog"

and these may even be understood as being the same as "Bring me one dog",

but "Bring me the dog" means a specific dog.

"This dog" can also be distinguished from "That dog",

as well as can "These" from "Those", (a subject of plurals)

so the article provides a very useful purpose.

### Category 2b. Regularization of Articles

One of the inconsistencies of articles in English is that between the use of "a" and "an". "A dog" and "an apple" still mean one of each. The rule simply being to precede those words which begin with a vowel by the use of "an" rather than "a" so that two vowels will not be adjacent. This may have some phonemic merit but it does make one more rule for the new learner, and this may be unnecessary at the outset.

[Robert] "Since artikles are kynds of adjektives riplace "a/an" bi (i) and "the" bi (thi) (sii proposal in Categori 8b)".

[] Indef. art. in most languages is (for French, German &s.) an extant or (for English) eroded form of the numeral one . This alreedy gainz a sufixt -i sound in 'any' & if chanjed to i wd lose its conexion w th articl (no weeping fr that, since most users probaly learn it as a separat entity), bt I se som valu in keeping a link btween th abuv -n, -'n, -one suffixz wth th articl pronounst normally one ov 4 way: like a(n) in sofa, ape, organ or began. Mor t th point, I think most v us 'feel' an identity of th articl with the alternativ expression 'one' so ofn rzortd to by newcommerz t our languaj. "may I by wun apl?" &such.

[] 'The' iz a diferent proposition. It haz 2 standard pronounciationz, th/' thee, larjli (like thozv v a(n)) dependent on hwethr th next sound aftr it iz a vowel. I think th lojicl (and in th long term, i.e. hwen current/ sE spelingz no longr inhibit rform, the eziest) option iz t hav 2 spelingz (th('), thi/the) az in sE fr a(n) .

### Category 2c. Elimination of Articles

Articles are eliminated in many Pidgins as well as in a number of languages like Russian and Latin. "Bring me dog", would possibly be more meaningful in context of the moment, than in some literary sense. Indeed, since Pidgins are generally spoken, rather than written, this may be a consideration for the formation of an ITL.

Since articles are not present in many languages, it is perhaps best to leave them out of the ITL as it involves teaching an unfamiliar concept. Indeed this may be a principle for Pidginizing a number of matters of syntax in the ITL.

[Robert] "Major languages such as Chinese, Hindi, Japanese, Malay and Russian do not employ articles (a fact which might apply to the majority of languages)."

[Antony] Against this might be set the possibility that the predominance of English as a world language is connected with the fact that it employs articles. There is no question but that English-speakers love to use articles. Frequency Analysis of top words in English (Johansson & Hofland 1989): "the 68315, of 35716, and 27856, to 26760, a 22744, in 21108, that 11188, is 10978, etc. etc." - "the" is by far the most popular word in English, and "a" is fifth on the list.

[] The label 'definite' applied to this article 'indicates' that it is an 'indicative'/ definitiv adjectiv like that/ this, ov wich it is historikli n eroded form, az in most European languajz and I think Arabic. It's populr bcauz it indicates tht th next wurd/ fraze is nounal, &/or th preseding wurd/ fraze is not part v it; tht th foloing noun is identifiable az distinct from such entitiz in jenral and iz a unique individual/ item, dstinct from th same expression with indef. art. -- a mor clearly indicativ adjectiv function, beyond a mere partitioning or 'particle article'..

[Robert] The correct use of articles is difficult for non-native speakers of English.

[Antony] I suggest that "1" and the indefinite article be merged. "A, two, three"?

Click here to return to the [Table of Contents](#)

---

## Category 4. Possessives

### Category 4a. Definition of the Problem of Possessives.

Possession in Traditional English is indicated in writing by use of an apostrophe. Audibly, however, the word sounds just like a plural. For example, when we speak of "cars" (plural) or a "car's window" in both instances, "cars" sounds the same. The distinction is based upon context.

### Category 4b. Alternate Proposals for Possessive

In some languages and pidgins, possession is shown simply by juxtaposition of words. Therefore "John's book" is simply "John Book".

Another alternate proposal is to use some sort of verbal marker. For example, "Book John de" where de sort of stands for "of" and the meaning would be "The book of John". The "de" would, however, always follow the possessor. This technique of the following modifier would parallel its use in some other examples.

[Robert] "Empti" word "de" is taken from Chinese, where tdi word order bi "John de book"; ratder tdan "John book de".

[] This z a postposition az distinct from a preposition. Som prepositions cn b postpositions in sE e.g. 'Clues to the contrary NOTWITHSTANDING, this z hwat I bcame aware OF'.

## Category 4c. Elimination of the Apostrophe

Because the apostrophe is not pronounced it does not belong in a phonemic system. One could continue to use the "s" sound for possession, without conflict with plurals, if one were to use some other marker for plurals such as the ZEE sound which has been mentioned above. However, there would still remain an inconsistency in the use of s or z such as in "The cat's box" and "In the dog'z box".

[me] If "-en" were used for plurals, and "-z" exclusively for the genitive/possessive, then the apostrophe might be dropped. As a long-term aim, words ending "-en" in the singular and "-s" or "-z" in the nominative might be replaced by alternatives from other languages. This would not be unprecedented: for instance, tens if not hundreds of verbs denoting repetitive action "handle, swivel, ladle, feel, amble, mangle etc." end in /l/.

[] I'm al fr adopting (hav recmended in IngLingo) -l but rathr as an abbreviation of TOOL (/ INSTRUMENT) than as a sign of repetitiveness, e.g. handl pedal swivel swizzle toggle ladle label bottle kettle shovel mangle gavel level chisel medal model castle needle throttle cradle saddle/settle table trestle wistle axle &s. (possibly fable, riddle?). Admittedly it also functions as an indicator of repetitiveness but perhaps less frequently e.g. amble, waddle, wiggle, waggle, wriggle, battle, dabble, gabble, gobble, double/treble/triple &s., dribble, dapple, quibble, rubble, tipple, (possibly addle grovel cuddle fuddle huddle muddle settle?); fiddle, rattle and grapple seem to have both senses or either; riddle, runnel, fabl, offal, maple, apple, petal, sepal, nettle and others seem to fit neither. I don't see great strength in the case for a possessive form. French (except for some pronouns) and others dispensed with it long ago. Pidgins use a particle e.g. Pisin: hat blong mi = my hat. Several substandard English speakers make no spoken distinction between the objective case pronoun and possessive pronoun in some cases (me hat) and sE in some cases (her hat). If there ar eny examplz v importing a foreign wurd to improv regularity I can't think v one, and I'm inclined to think it unlikely to catch on for several generations.

[Robert] Use of the Chinese "empti" word "de" would eliminate the apostrophe: "The man I saw yesterday's daughter" = "The man I saw yesterday de daughter".

Click here to return to the  
[Table of Contents](#)

---

## Category 6. Adverbs

### Category 6a. Definition of the Problem of Adverbs.

Adverbs are sometimes called the dustbin of the parts of speech. Many times we think of creating an adverb by adding "ly" to an adjective, such as "likely", "darkly" and so forth. However, in Traditional English grammar the words "tomorrow, very, no, however, when, not, just, the" have all been classified as adverbs. "The" in "The more the merrier."

The words in the latter example have not become an adverb by adding ly to an adjective. Moreover, there is an additional problem of inconsistency. Adjectives ending in "y" have the "y" changed to "i" before the adding of "ly" to make them an adverb (happy - happily).

While it may not be important for a language learner to know the names of the various parts of grammar, still the more rules that there are for them to learn or patterns for them to assimilate, the harder it will be to learn the language, and this difficulty reduces their confidence and retards their progress. Therefore it is our desire to make the rules as few and as consistent as possible.

## **Category 6b. Alternate Proposals for Adverbs**

One suggestion has been that the "de" proposed earlier for the possessive would work equally well in creating what are now "ly" adverbs.

e.g. "rapidly rising tide" ~  
"rapidly rising tide" ~ ("rapid rise de tide")  
although it might be almost as clear and certainly more simple just to say  
"It is rapid rise tide".

It appears to be largely a function of word order.  
"It appears to be large function of word order",  
would seem to mean something different in that this sentence would seem to imply that one of the main functions of word order is create the effect of adverbs.

This whole subject is something that I do not have a grasp of, as yet.

Click here to return to the  
[Table of Contents](#)

---

## **Category 7. Superlatives.**

### **Category 7a. Definition of the problem of Superlatives.**

This being a relative world, much that we try to communicate has to do with the matter of degree. (no, not, non, none, one, couple, few, some, many, much, more, most, full, all). The greater difficulty still, comes when we try to apply many of these, which are often abstract terms in themselves, to concepts that are abstract (such as truth, love, and beauty).

In order to modify words in terms of degree we often use prefixes and suffixes. However, the problem is that

there is no consistent form for doing this. This subject may really need to be more generalized under the heading of morphology which is said to be the study of how words are structured.

## **Category 7b. The use of er to indicate degree and est to indicate maximum**

We can see, by looking at the prefixes and suffixes, how they have developed from other words. No, not, non, none, are all related. None, and non, appear as contractions of "not one" or "no one". Words that are used as prefixes often start out in a hyphenated form. (Non-sense thus becomes nonsense and non-liquid can become nonliquid). Since, in a phonetic representation of speech, the hyphen is not pronounced, it is not necessary.

In similar manner the words more and most may have become postfixes.

More as "er" and most as "est".  
More great is therefore greater.  
Most great is therefore greatest.  
More small is therefore smaller.  
Most small is therefore smallest.

While this presents some difficulty with some words  
More little becoming littler is grating to some ears,  
but it is correct and applies to size,  
whereas more less becomes lesser  
and applies to quantity.

How far one may want or be willing to go with establishing a fixed rule may get into philosophical issues. Some terms may be considered superlatives within themselves. Therefore some persons would not accept the expressions gooder, goodest, or badder, baddest, or virginer, virginest. While philosophically one may have difficulty with such terms there is no gramatical reason why they should not be acceptable.

## **Category 7c. The use of more to indicate degree and most to indicate maximum**

Whatever one's philosophical concerns about the application of superlatives to certain abstract concepts it may be that the simplest solution in a pidgin is to simply eliminate the use of prefixes and suffixes and to use the full word itself. This approach also eliminates a conflict with another use of "er". We add the "er" sound to words to indicate someone or something that performs an action. (Baker, Waterer, Carrier).

Within an ITL pidgin, we could perhaps take further this principle of eliminating suffixes. In Traditional English the postfix "ness" is add to words to denote the presence of a "quality" (Highness, Goodness, Darkness). In idealist philosophy this can apply not only to abstract qualities but to concrete objects itself. Socrates would have argued for "chairness", that quality which distinguishes a chair from a stool, seat, sofa, table, or other object.

There may be still others. Full for example. Beautiful is that which is full of beauty and awful was something that originally meant that it was full of awe or caused awe. There are still others, (-ous, -ose, -oid, ish, -y, (or ie), -ize, -like, -shaped, -ly, -fashion). Just how far we might want to go with this principle in an ITL pidgin, in either formalizing their use, or eliminating them, is a subject that should be examined. Many, many words have an etymological history as being the combination of concepts. Some-thing, any-thing, no-thing, and many others

could possibly be reduced back to their original meanings.

That we might try to simplify an ITL by selecting a single syntactical method from among many in an extended language does not mean that an extended IAL could not have for variety a greater number of acceptable syntactical structures. These might be used for variety as well as might be numbers of synonyms.

Click here to return to the  
[Table of Contents](#)

---

## Category 8. Adjectives

### Category 8a. The problems with Adjectives

One of the curiosities of English is that many words can be used in different grammatical forms. The same word may be used as a noun, verb or adjective. For example. One may sit in a chair when they chair a meeting. And we may refer to a particular type of seat as a chair seat.

This free form of construction is very different from those languages which require that nouns, verbs and adjectives all agree, in tense and other syntactical endings including perhaps even gender. One wonders then, if proposals specify adjectival endings is not a step back from this advantage of English.

On the other hand there has been the suggestion that all adjectives should end in some one form (-i -ic -ig -al -ive -ing) instead of the listed variety since all sometimes have the sense of 'involved in the action/state of' whatever the word stem refers to.

### Category 8b. Alternate Proposals for Adjectives

There are also opposite proposals for adjective endings to indicate different meanings:

o'pi (=open), o'po (=public, frankovert, obvious, 'transparent';  
chairopi seat - an open chair like seat. A park chair or bench could be a chairopi seat.

shuti = enclosing (shutting);  
chairshuti seat - an enclosed chair like seat. A chair in a steam cabinet could be a chairshuti seat.

shuto = private, secret(ive), seclusive, exclusive, covert (closed);  
chairshuto seat - a hidden chair like seat. A chair in a confessional could be a chairshuto seat.

waido = general, widespred, non-specific (wide);  
chairwaido seat - an indefinite chair like situation. A long divided bench like sometimes found in an airport could be a chairwaido seat.

narro(id) = special, restricted;  
chairnarro seat - a special seat. The chair in a court witness box could be a chairnarro seat. Also that

occupied by the judge.

airni = ferri-, ferric -- trivalent iron compound prefix or adjective;  
chairairni seat - an iron seat. The unpadded seat in a fighter plane, or some ornamental iron lawn furniture could be a chairairni seat.

raoni = circular, spherical, globoid;  
chairaoni seat - a spherical seat - A hanging basket type of seat could be a chairaoni seat.

raono = roundish, surrounding, (a)round, encompassing, re, spheroidal,  
chairaono seat - a round seat. The circular seat sometimes found in a hotel lobby or surrounding a fountain might be a charaono seat.

These few examples are but part of what could be a very long list. It is said that the Eskimos have over a hundred words for snow, but we are talking about something more generalized than specific words. We are talking about specific endings that can be added to any adjective (that is to any word being used as an adjective) in order to add to that adjective some generalized concept.

While an approach of this sort could be developed, possibly better over time, in a very advanced language, even if, or especially if, that language were an IAL, it seems questionable that a very elaborate approach of this sort should be used in an ITL.

There may also be a need to distinguish adjectives referring to completed, and potential/projected action, as distinct from -i, -o which in general relate to continuing/occasional action. These could be standardized as follows:

'tense-/aspect-/mood-related' adjectival endings for the completed as  
-t (burnt, lurnt, spelt, ment etc.)

'tense-/aspect-/mood-related' adjectival endings for continuing  
-bl (i'tbl = edible, du'bl = doable/agendum, hapbl = possible, solbl = soluble, etc.)

[Robert] "<-i> commonly indicates adjectives in Slavic languages" (Ruby Olive Foulk might have been on to something [me])

Ameri(can), Australi(an), Engli(sh), (H)indi(an), Irani(an), Iraqi, Iri(sh), Israeli, Maori, Russi(an), Turki(sh) {turki-fowl}. Since articles are a kind of adjective: the ~ thi, a/an ~ i.

[] Wun coment on my use v -i az th main adj. ending (usuali = -y, -ic(al), -ive) in IngLingo wz: It is too short - how about -ic or -ish? Az I propose an alternativ -o (usuali = -ous, -ose, -oid, -some, -like, -shaped) with a slightly diferent emfasis (aftr wurd stem ending -e/i; or tu emfasize adverbial rathr than adj. function; or especially t diferentiate somthing a bit mor abstract/ metaphorical, e.g. fiti = fitting/ suitable; fito = fit, sound, helthy; ferri = ferric, fero = ferrous; ringi = ringing, surrounding; ringo = ring-like, ring-shaped, cycloid.) I'm inclined to opt fr options, e.g. -i(c), -o(id).

[Antony] I'm presently inclined to think that Doug is on the right lines here. There are a limited number of suffixes that can be used universally without wrecking the concept of orthographic regularity, and "-i"

and "-o" are among them (cf. the "-ed" and "-s" inflections in English - as in "talked, banned, landed, cats, dogs, foxes").

Where a word is used exclusively as an adjective, e.g. "hot, bold", it shouldn't take an affix because there is no need to differentiate its use in different word classes (cf. "hand, to hand, handy, handily")

It's right that adjectives and adverbs should take the suffixes because, where a word falls into different classes or parts of speech, it is the adjectives and adverbs that qualify the nouns and verbs (respectively) and not vice-versa.

It's always possible to distinguish the noun from the verb, whether by context, word order, noun or pronoun number or case, or the use of verb auxiliary/inflection.

I think Esperanto went astray here. The word class or part of speech should serve the word, not vice-versa.

[Doug May 3] I agree

Half-baked, definitely, and the claim that "hot" and bold" are used exclusively as adjectives is absurd: "hotly, boldly, boldness" etc..

However, I'm not yet convinced that it's all nonsense. It doesn't seem to be necessary to differentiate the noun from the verb by means of a suffix. Nouns derived through adjectives don't seem to be used as verbs; verbs derived through adverbs don't appear to be used as nouns. I mean the same word + suffix. Could someone put me right on this?

Esperanto puts a suffix on all the main word classes, but what is the problem with using bare word-roots, where one can get away with them? Perhaps descriptive suffixes might develop on or in word-roots in the absence of grammatical suffixes - as in many words ending in //.

All this might be of marginal relevance to an ITM strategy, but is central to an IAL strategy. Response(s) welcomed - however negative!

I understand that some languages don't bother with nouns and adjectives: they use pronouns, verbs and adverbs, e.g. "it houses whitely" ("a white house"). How about that?

Not greatly different from English and Chinese because 1. all things are also events or processes. An atom is a dance of electrons and liable to change if electromagnetic waves or subatomic particles collide or combine chemically with it.

2. We use the same word as noun, verb, adjective, adverb and preposition without ambiguity if context is clear, e.g. round balls are used in a round of golf, round a course and a winner may treat his opponent or a round dozen of the players to a round of drinks when they finish going round.

3. Many languages use adjectives as adverbs, including English at times: the VERY day I saw you I took very ill (from French adjective vrai=true, not vraiment=truly). He runs FAST. Less standard expression: I



felt proper/ real proud.

Click here to return to the  
[Table of Contents](#)

---

## Category 9. Personal pronouns

### Category 9a. The Problems with Personal Pronouns

Traditional English has a number of irregularities in regards to personal pronouns and their relationship to verbs. One of the marks of English education is how well one has mastered the exceptions to what would otherwise appear logical. Children, foreigners, and the poorly educated often make the mistake of using logic in their constructs of syntax. This sometimes is seen as humorous in the speech of children, but in the case of foreigners it often subjects them to ridicule and an inclination to classify them with the ignorant.

An example would have been the southern black mammy of some decades past who would have said, "He is going to town, she is going to town, and I is going to town". Syntactically, such a construct follows completely logically, and it is not only symptomatic of the problem but a model for one of the recommended types of solutions.

Another obvious shortcoming of English pronouns is that they do not include a neutral or inclusive word for he/she. One must use a cumbersome circumlocution such as "he or she" or "the person".

In the following subcategories we will present some of the suggested remedies one by one.

### Category 9b. Use of "sheet" for indiscriminate sexual definition

The word "sheet" is a combination of she, he, it and in Angel it would be written sET. The words he, she, and it would continue to be used. sET would be used in only in those cases which are indiscriminate. If the Angel ITL were to contain no plurals then sET would also replace the present indiscriminate they. (Only by context in present Traditional English can one know whether "they" is men, women, a combination thereof, or some combination of more than one it). On the other hand, if Angel were to adopt the ZEE form for plurals then they would be replaced by SETZE.

[Robert] "She - he - it" is ingenious but I don't like it. Too long to start with (Zipf's Law).

### Category 9c. Elimination of the repeated pronoun

A second problem with Traditional English is that it inconsistently uses a repeated pronoun. The pidgin, "I go town" is expanded to "I am going to town", by adding "am", modifying "go" to a gerund and supplementing it with "to". 'Am' is an irregular form of 'be' which has its own gerund form of "being" and in the past tense becomes been.

The elimination of the "be" verb could reduce more indefinite syntactical expressions in the following manner:

I will be walking. (I will walk)  
 I may be walking. (I may walk)  
 I have been walking. (I did walk)  
 I should be walking. (I should walk)  
 I could be walking. (I could walk)

Further verb reduction would come by the removal of the further supplementary "to":

I will be walking to town. (I will walk town)  
 I may be walking to town. (I may walk town)  
 I have been walking to town. (I did walk town)  
 I should be walking to town. (I should walk town)  
 I could be to walking. (I could walk town)

As in Traditional English, additional verbage can be added to sentences for clarification or emphasis. Where needed or desired one could add to, from, in, about, and other terms.

[Robert] Regularisation of personal pronouns: "myself ~ me self ~ self" etc. has been lost. Could it be restored?

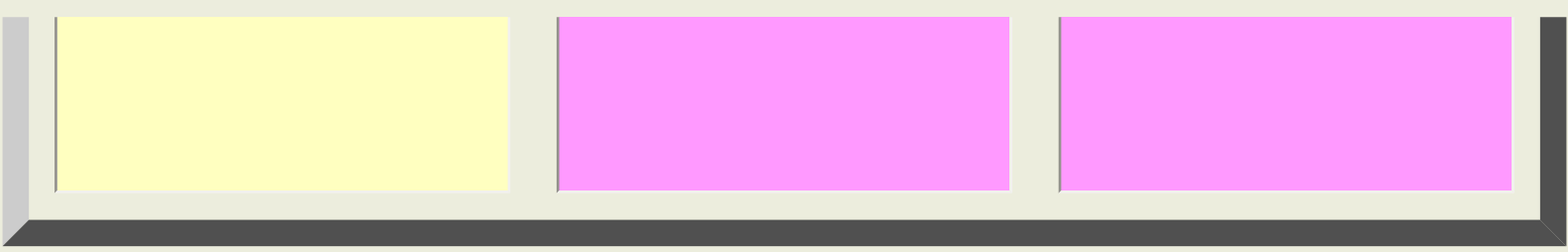
[Antony] Shouldn't the current contents of 9c be in 10?

### Category 9d. Examples of some other suggested remedies

There follow examples of some alternate suggested remedies. If they have not been fairly presented here, or the presentation can be improved, please inform me.

#### Active (Robert)

<p>1st person          2nd person          3rd person</p>	<p>Singular</p> <p>We ( I )          ye (you)          the (he\she\it)</p>	<p>Plural</p> <p>wem (we)          yem (you)          them (they)</p>
---	--	---



**Possessive (Robert)**

1st person 2nd person 3rd person	<b>Singular</b>  We de (my) ye de (your) the de (his\her\its)	<b>Plural</b>  wem de (our) yem de (your) them de (their)
--	---	---

\* "the" rather than "they" \*

**Doug**

1st person  
2nd person  
3rd person

**Singular**

I/me we/us  
you  
he/him she/her they/them  
(s)he/h-er/-im/it/the-y/-m

**Plural**

mi  
'u, yu'mi, 'u lot  
herm, em  
em, it

[Robert] cf. Chinese (Putonghua)

wo de (my) women de (our)  
ni de (your) nimen de (your)  
ta de (his/her/its) tamen de (their)

**Category 9e. Current Angel Inclinations**

Traditional English:

(I, We, You (Sing./Plural) want to walk.  
(He, She, It) wants to walk

Proposed Angel:

(Me, We, You, You all, He, She, Sheet) want walk.

Or possibly even (Me, MeZee, You, YouZee, Sheet, SheetZee)

The thing that I notice here is that the proposed modications  
are two syllables whereas the traditional was one.  
SheetZee would replace 'they', 'them' and 'those'

Traditional English:

I walk or I (will, do, should, can, may) walk

Proposed Angel:

Me (will, do, did, should, can, may) walk (time - place)

(time - now, everyday, always, seldom, sometime, before, at night, in morning, yesterday, etc)

(place- to work, in park, on street)

Traditional English:

(My, Our, Your (Sing./Plural) apple.

(His, Hers, Its, Their) apple

Proposed Angel:

(Me, We, You, You all, Sheet, SheetZee) apple.

If the ZEE convention for plurals were to be adopted then the plural "you all" would be "youzee".

Click here to return to the  
[Table of Contents](#)

---

## Category 10. Verb Variations

### Category 10a. Past Tense Problems

In Traditional English, past tense is dealt with in several ways. Oftentimes by adding "ed" which, however, is often pronounced as a 't' such as in "I walked". Sometimes, the past tense is actually spelled with a "t" such as "I sleep", "I slept". Some verbs have an entirely different form for the past tenses such as "I eat", "I ate", "I have eaten", and one could also use the extended phrase, "I did eat".

This variety and inconsistency of rules is of course confusing to the learner.

### Category 10b. A separate word to denote the past tense:

Ogden suggested "he did cut". This is an emphatic tense.

"He has cut" is closer to the aorist.

However, the names don't really matter:

"he cut" ~

"he has cut" or

"he did cut", if the latter is closer to the meaning.

There may be some historical or etymological justification for this approach. One can see how the 'did' could be looked upon as having been simply transferred to the end of the phrase. "I sleep did", "I walk did", and then shortened to "I walkdid or walkid or walked".

Thus, there could also be a logical pidginic approach to the past tense by simply adding the full past tense

expression to the phrase. Therefore, "I walk did", "I sleep did", and so forth.

Indeed this appears to be the approach of some other languages. Some languages, such as Chinese, place the tense at the end of the action.

He dived\dove in the water. ~ He dive in the water, la.

It snuck\sneaked by. ~ It sneak by, la. (a Chinese type)

One of the great advantages of the Chinese "empty" words "ma, la, de": would be a reduced dictionary, because this would eliminate the additional forms of verbs. It is also pointed out that this eliminates the homonyms "ate/eight" and "one/won".

"He ate lunch"=

"He eat did lunch"

"He won the race"=

He win did race

Again it should be noted that oftentimes the solutions suggested for regularizing syntax actually makes it longer. There may be at work here some inverse variant of Zipf's Law, as applied to syntax that says since custom and hence rules, worked in the past to simplify expressions, that to regularize them we must often lengthen them. There is probably no real advantage in changing the word order, so we would then be back to Ogden's suggestion.

In Traditional English, for some verbs, we can only separate the present tense from the past tense by the context.

"What do you do in the factory?"

"I cut the wood."

"Who cut the wood?"

"I cut the wood."

While one can say, "I did cut the wood", there is no "I cutted the wood".

### **Category 10c. Elimination of the verb alteration for third person singular.**

Some of the verb variation could be reduced by just eliminating the alteration for the third person singular.

In Traditional English, "I eat" becomes "He, She, It eats"  
but could be reduced to:

"I, He, She, It eat".

### **Category 10d. Elimination of the past tense**

One recommend solution is the elimination of the past tense altogether but this seems to too drastically reduce meaning.

## Category 10e. Other advantages to verb regularization

By removing or regularizing verb variants we will also regularize some adverbs, nouns and adjectives.

For example where eat, ate, eaten presently has associated with it "edible" this could become "eat, did eat, eatable".

Traditional English changes the sound (and sometimes the spelling) of nouns

sheath, bre(a)th, cloth

to verbs sheathe, breathe, clothe

These could be regularized by simply using the noun pronunciation, but in actuality there are probably many verbs with etymological roots in nouns for which we no longer see a clear association. The use of phonetic spellings further distorts these apparant relationships, so how far one might wish to go down a path of regularization in this regard, is problematical, as this latter word itself demonstrates.

Verb variants also affect the spelling of grammatical variants ending in "-ly" and "-y"

The substitution of tenses by variable auxiliary\auxiliaries + an invariant verb-stem might render their traditional names more or less irrelevant. As the number of actual and potential auxiliaries is large, so is the number of tenses.

Chapter 13 of LANGO - also refers to the creole usage of serial verbs, e.g. "she go try find it, he start run escape", rather than the infinitive - and to the negation of verbs using "no", e.g. "He no work today."

the participle\gerund "-ing" suffix is already eliminated in sentences such as "The man was at work (working) in the garden".

"As wel as saying "at", Irish uses "in". This, i.e. "in", is invariable in Welsh. From English: in flower (flowering); in song (singing); in flight (fleeing or flying); in doubt (doubting). The 'nakk wil bi tu kriate more noun-verbs, e.g. "He was in entry thru the door." ~ "He was entering thru the door."

As a result of parallel usage the phrase and the participle are very often not quite equivalent, but it does show that the auxiliary\auxiliaries + invariant verb-stem model might become universal.

the kind of expression used by non-native speakers, e.g. "If it will be that...."

"talking" ~ "at talk" (cf. the Irish preposition "ag") also the English "on" = "about" ~ the Dutch "om", which is used in the same way as the German "um" and the Welsh "am"

"He will be talking on China."

"He will be ag talk om China."

"He was talking on China."

"He ag talk om China, la."

[Robert] Doug misses the point of "I am walk". "Am" is intended as an indicator of the continuous tense, i.e. "am" is equivalent to "ag, at, in". "I am/ag/at/in walk" = "I am walking". It is just a matter of which turns out to be the most euphonic. Also, Somerset dialect is not "he be" but "er be", where "er" = "he" or "she".

[Antony] "Er" sounds like a better alternative to "sheet". (see 9b)

[Robert] I prefer "I sing" to "I be sing" for the simple present and "I be sing" to "I will sing" for the future (i.e. as in B.E.V.), Doug's preferences being "I be sing" and "I will sing".

[Doug May 3]. I would omit the 'be' or 'wil' or 'did' (or 'am') when the tense (and/or aspect/ continuity) iz clear from context: I (usually) sing here yesterday/ today/ tomorrow/ often

Click here to return to the  
[Table of Contents](#)

---

## Category 11. Courtesies

The use of courtesies, while not essential, change the tone and to some extent the meaning of communication. Some languages involve courtesies to a much greater extent than does English. All verb expressions in some languages are determined by courtesies. The way the verb is used can change between male and female, young and old, blood relationship, age, and other denominations of cultural rank.

The main courtesies in English are 'please' and 'thank you' with some usage in respect to titles. While it may not be absolutely necessary to teach courtesies in the first level of an ITL they should have some priority.

Click here to return to the  
[Table of Contents](#)

---

## Category 14. Regularisation of Grammar

### Category 14a. According to the word-order principle

In Traditional English, meaning is affected by word order.

Traditional English generally uses a SVO (subject - verb - object) word order. HOWEVER it can use any order:

SVO - the boy saw the man



OVS - Jones I invited - not Smith  
VSO - govern thou my song (Milton)  
SOV - pensive poets painful vigils keep (Pope)  
OSV - strange fits of passion have I known (Woodsworth)  
(and also the Jedi Master Yoda)

It is probably best in an ITL to restrict the syntax to SVO.

## Category 14b. Elimination of the Accusative

Madhukar notes: "English is free of liaison and many odd features. That does not mean English is quite logical. (cat kills rat) changes meaning if word sequence is altered to (rat kills cat). But Marathi inflection- postposition is helpful there. laa = accusative. Using English words, cat kills ratlaa.

Now interchange words. ratlaa kills cat, kills cat ratlaa, etc. The meaning is not altered.

Everingham responds: "I prefer word order to accusative suffixes which correspond in English only to accusative forms me, us, her, him which are irregular and abandoned in most natural interlanguages, e.g. Melanesian pidgin has mi = I/me, mipela/yumi = we/us, em = he/him/she/her/it, ol = they/them."

[Robert] English moved on from such inflections 1000 years ago - word order preferred.

## Category 14c. Simplification of end phrase interrogative

Antony says, " We know that the interrogative end-phrases, used in English to turn statements into questions, are unnecessarily complex - not to mention the difficulty for learners. Other languages have proven that a single invariant phrase, or word, is sufficient.

For example, where English has "won't I? can't you? don't we? aren't they? etc. etc.", French makes do with "n'est-ce pas?" and Esperanto has the interrogative marker "Cu" at the beginning of the sentence

Robert proposes the use of the Chinese interrogative marker "ma", e.g.

"You're Robert, ma?"  
Cf. Canadian "You Robert, éh?"  
Nice one, eh?  
Or, how about "eh", eh?

Click here to return to the  
[Table of Contents](#)

---

## Category 18. Reduction of word meanings in the elemental list.

While meaning is affected by word order it is also affected by word usage itself. In their important book on the subject,

### **The Meaning of Meaning (1923)**

C.K. Ogden and I.A. Richards

listed 16 different meanings of the word 'mean/meaning' some of which were:

- John means to write. (intends)
- A green light means go. (indicates)
- Health means everything. (has importance)
- His look was full of meaning. (special import)
- What is the meaning of life. (point, purpose)
- What does 'capitalist' mean to you. (convey)
- What does 'cornea' mean. (refer to in the world)

To this we could add many other meanings of mean

- What is the mean temperature. (A measurement of average)
- He is a mean boss. (unpleasant)
- What does the boss mean? (want to communicate)

The purpose of language is to communicate meaning. But there are various levels of meaning. Perhaps because of what Noam Chomsky refers to as "surface" and "deep" levels of grammatical structure.

The mark of intelligence, particularly in reading poetry, imaginative literature, scripture and so forth, is to be able to see deep meaning. In fact, we can almost say that this is the way that language marks progression in life.

Still, in the development of an ITL our thrust needs to be in the other direction. That of limiting the possibilities of meaning. This same standard has other applications also. In contract language and in scientific technological explanation. At the other end of the scale, in pure scientific research, there may need to be freer coinage of meaning in order to develop new ideas. But, as these are brought back down to technological application, then the words need to be more closely defined.

One interesting concept would be that of the development of Speed Words. The idea is to reduce the basic ITL word to the least number of phonemes. The purpose for doing this is many fold:

- That it makes less for the learner to learn.
- That it makes less for the learner to write.
- That shorter words add to rapidity of thought.
- That shorter words add to rapidity of speech.
- That it is more economical for printed materials.

The above does not begin to exhaust the list of Speed Word benefits, but it gives one the general idea. Such an

idea might be more suited to a new IAL, and an associated ITL, than to an ITL that has as its target Traditional English because the speakers of Traditional English would not know the ITL vocabulary when they heard it, although the change could be minimized by judicious use of existing Traditional English root words. Although presently impractical this is still an interesting idea and we might say that it takes Zipf's law to the extreme.

Some proposals for speed words have advocated increasing the number of phonemes to 100, thus allowing for more 1 and 2 phoneme words. However, the trend in Traditional English (at least in North America) has been towards phoneme reduction, which is itself further language simplification. With the 39 phonemes of Angel it is possible to present 684 one and two phoneme words. This should be sufficient for an ITL.

A close relation to speed words is speed writing. Historically, lower case letters were themselves developed for cursive writing. Today, with the disappearance of penmanship, the predominance of keyboards, and the trend towards word processor speech recognition, and the presence of minaturized voice recorders, how critical this may continue to be, is as yet undetermined.

Further discussion on Elementalization

(Madhukar) For instance, changing chairman to chairperson; changing term "Christian" name to "first" name or "personal" name, when thousands of non-Christians accepted English language.

These ar trendz also in Australia but old usajz hav not disapeard here and there may b lots ov uthr cultural quirks slower t chanje, e.g. humankind for mankind where it is not contrsted with womankind.

[Robert] British English uses "first name" and "family name" ratder tdan "Christian name" and "surname", also "chair", "chairperson", "madam chairman".

[Antony] Madhukar raised the important question of ambiguous words in his email of 26 April. The mass of exact synonyms is probably an even greater problem. Which word to choose? It's not always obvious.

[Doug May 3] Hogben tackled this problem -- I did a précis:

[ESSENTIAL WORLD ENGLISH \[ewE\]](#)

Click here to return to the  
[Table of Contents](#)

---

## Category 19. A regularized number system

0 zero

1 one

2 duo

3 three

4 quatro

5 five

6 six  
7 seven  
8 octo  
9 nine  
10 ten  
11 ten one  
12 ten duo  
13 ten three  
14 ten quatro  
15 ten five  
16 ten six  
17 ten seven  
18 ten octo  
19 ten nine  
20 duo ten  
21 duo ten one  
22 duo ten duo  
-----  
29 duo ten nine  
30 three ten  
-----  
40 quatro ten -----  
50 five ten  
-----  
100 one hundred  
111 one hundred ten one  
121 one hundred duo ten duo

The logic behind this is:

a. it eliminates the words with competition for double meaning such as to, for, and ate

It is a more logical organization of numbers

ten and one instead of eleven  
ten and two instead of twelve

The teens are probably a transposition of this system anyway

fourteen is four and and ten  
but still illogical  
compared to the expression  
in the twenties, thirties and so forth.

There has been one suggestion that  
"seven" ~ "sem"

(because it is so often so pronounced in the U.S. and Britain - and because of Slavic forms)."

Also it has been suggested that Spanish numbers could be adopted in their entirety.

[DE: IngLing compromises for now with 'wun tu thri for faiv siks sevn e't nain ten/te hunrt ki'lo mion/meg mu maikro'. 'te' = -teen/-ty thus ten = wun te, 11 = (wun) te wun, 13= (wun) te thri, 20= tu te. I'm concerned here to preserve terms compatible with the International Communications Alphabet (alfa braavo charli delta eko fokstrot golf ho'tel indya ju'lyet ki'lo li'ma maik nvembr oskr ppa qbek ro'myo syera tango 'un'form viktr wiski xre yangki zu'lu) and numbers used in traffic control radio using the international language prescribed, English. I have tried with no success so far to track down on the internet a publication outlining Seaspeak, which I understand was an attempt to compile a simplified core vocabulary/ phrase book etc. for such purposes. Can eny ov 'u direct me to such a source please? -- DE]

[Robert] Tde niw Welsh numbering system:

un, dau, tri, pedwar, pump, chwech, saith, wyth, naw, deg undegun, undegdau, undegtri, undegpedwar, undegpump, undegchwech, undegsaith, undegwyth, undegnau, dauddeg, dauddegun, dauddegdau etc.

earlier, 11 = un-ar-ddeg, 12 = deuddeg, 13 = tri-ar-ddeg, 14 = pedwar-ar-ddeg, 15 = pymtheg, 16 = chwech-ar-ddeg, 17 = saith-ar-ddeg, 18 = dau-naw, 19 = naw-ar-ddeg, 20 = ugain, 21 = un-ar-hugain etc.

If Welsh cn do it, English can. One ov my teacherz deliberately pronounst th 'ty' suffix for 20,30,40,50,60,70,80,90 as in 'tying' t avoid cnfuzion with '-teen'. Foloing th Welsh exampl we'd rplase th -teen with 'wunten-' prefix, but both -teen and -ty are derivativz ov 'ten' and on Zipf's principle we ouht t uze th shortest unambiguous form which may be 'ti' [(wun)tiwun = 11, tuwtiwun = 21, forti= 40, &s.]

Research in the U.S. shows tdat tde proposed new arangement (based on oriental systems) has advantageous inplikations for impruving standards of numeraci. (Sugestion about Spanish numbers - at bottom of p.16 - was not intended as a serious proposal.)

Click here to return to the [Table of Contents](#)

---

## Category 20. Philosophical Discussion

For years, I have referred to this subject as Rationalization, but Antony has now chosen what is undoubtedly the better term of Regularization. (Roz now informs me that I picked up the term "rationalization" from Ogden, but that she agrees that Antony's term is better.)

Everingham says that it is his hope, "that among us some consensus may arise, as in the drafting of international treaties/conventions in multinational forums. They often start with a small drafting group, then add inside square brackets the amendments moved by individual nations but not supported by all. The next stage tries to change the form of words till brackets are removed or included in optional protocols that some signatories will endorse. Language change is by nature piecemeal and erratic, often with several new coinages vying for general acceptance for a new concept or categorization till one or a few dominate.

(Bruce replies) I would be happy for Doug or anyone else, to take over the effort of maintaining this compendium and I feel sure that there are others who can do it much better than I.

However, my format at the moment, is to revise, and re-revise, each of categories both as to title and content as each of you give me suggestions that I can assimilate.

I feel that it would be too awkward, clumsy and bulky, to try to retain each of the comments and counter comments. Consequently, the Compendium is a dynamic work.

If some comment, or concept, falls out of the compendium you simply need to restate it and PLEASE tell me WHICH category to put it under and I will try to re-insert it.

I will PARTICULARLY appreciate any help in refinement of the categories.

### **So, what is it that we are trying to do?**

We are trying to simplify English as to its syntax.

Robert requests a call for papers on the optimum phonemic inventory

Bruce replies:

In the development of Angel, we have now passed beyond the subject of phonemic inventory. I recognize the philosophy of those who would like to see a system that permitted the representation of up to fifty some + sounds, and it may well be that some future IAL committee will wish to consider and implement such a philosophy, but for Angel we have passed beyond that point and have created a phonemic word list of over 40,000 words based upon 39 sounds.

However, as regards the matter of symbols, we have also provided the tools to any researchers to represent that word list in any ASCII compatible system that they wish, along with a Translation program that will translate present English Text files into their symbolism.

This particular Compendium is mainly limited to the discussion of Regularization. Another time and another place will need to be more fully devoted to Elementalization. While Phonetics/Phonemics are a subject near and dear to the hearts of many who are participating in this forum, however, there are other times and places for that subject and it should not be a central part of this discussion.

[DE: I wonder have you seen Rondthaler & Lias "Dictionary of simplified American spelling - An ALTERNATIVE spelling for English"

(Bruce replies) Drs. Rondthaler and Lias have been most generous in their assistance in the development of Angel. In the early years I fear that I bothered Dr. Rondthaler, by phone, rather incessantly. Dr. Lias has more than once provided me with copies of the sound speller. I do not know that I ever had the source code but perhaps someday we can embody the principles in a real time translator of Angel. Drs. Rondthaler and Lias did provide me with machine readable copies of their "Dictionary of simplified American spelling - An ALTERNATIVE spelling for English" and extensive usage was made of it, as well as of the Carnegie Mellon Institute Phonetic Spelling Word List, in Developing the Angel Phonetic Word list.

### **What is our reason for considering Regularization?**

- a. To make English easier to learn by adults
- b. To create a more logical and comprehensible Pidgin

### **How would it be used?**

In two ways:

#### **a. As an ITL (Intermediate Teaching Language) for teaching English.**

This is controversial in that some pedagogs would say that one should teach the "correct" formulations from the beginning.

They would say that, while the learner may simplify syntax in logical ways they should only hear the correct formulations. And that learning the "wrong" way is simply learning formulations that must then be unlearned.

Still, there must be some intellectual effort in trying to comprehend in what ways the "correct" formulations differ from logical formulations.

Beyond the ITP one would then teach the exceptions to the logical formulations and the learner could then learn all the present "correct" formulations.

If the ITP is sufficiently logical and consistent, and designed for the pedagogical purpose of being a path towards the exceptions of Traditional English then it could be easier to understand and learn the exceptions.

#### **b. As a proposal for an IAL (International Auxiliary Language).**

In this regards ALL ideas for Regularization should be listed and considered but we may implement MOSTLY those ideas which are compatible with category A immediately above. The question remaining, how useful a Pidgin would be as an ITL.

Still we may decide to implement some radical items. If the IAL was accepted then its forms might come to be accepted as "correct" forms, even in Traditional English and could be further supplemented by other new "correct" formulations by whatever body authorizes the IAL.

The relationship that might exist between any English based IAL (if some English based IAL were accepted as such) and the present full Traditional English language is another subject. There would then be, as there are now, more or less formal styles and levels of writing. So nothing that radical is being proposed in that regard.

### **FURTHER DISCUSSION on the usefulness of a Pidgin.**

(Antony) "this woman child" is ambiguous. The Internet is about as far as one can get from the normal pidgin\creole environment whose visual\tactile\sensual immediacy practically dispenses with the need for grammar. There is an inverse relationship between grammar and context (which is why, as it seems to me, there needs to be a continuum between simple and complex grammar).

(Bruce) This matter of continuity between the simple and the complex will certainly be a major issue when we go to make any selections for the ITL.

(Bruce) It may also be a matter of what I understand Noam Chomsky to mean by surface meanings versus deep meanings of language

(Antony) we should concentrate on those aspects of grammar that directly affect the operation of a rationalised orthography - or, in other words, where the principles of grammatical and orthographical regularity are in conflict. Prominent among these are verb inflections (particularly "-ed", "-t" and "-s" suffixes on the verb-stem).

(Bruce) this is a point well taken, and one of the prime motivators behind the present activity.

(Antony) Actually I am more doubtful than ever about the universal applicability of pidgin/creole usages. They certainly work in real-time situations where the context itself provides the meaning, but reduced grammar tends to be ambiguous at second-hand - hence the circumlocution characteristic of reports in pidgins/creoles.

A particular source of potential ambiguity in pidgins/creoles is the lack of differentiation between word classes (parts of speech). Esperanto goes to the other extreme - universally defining a word as noun, pronoun or correlative, verb, adjective, adverb or preposition/conjunction/interjection according to the affix.

English takes a half-way house: many words are invariant whether used as noun, adjective or verb (and sometimes adverb and/or preposition too), but most are exclusive to a particular word class. Examples of the former are "head, arm, dog, right". So far as I know there are hundreds if not thousands of invariants covering three or four word classes, and a few e.g. "under" in at least five (someone might like to correct me here). Examples of the latter (the "exclusives") are "gratitude, bold, survive".

(Doug Everingham). A pidgin-like simplification of sE which would provide ? a 'core' vocabulary of under 2000 word, based on English but following Zipf's principles of least effort, i.e. pursuing the natural trend of language development by broadening the senses of simple words, simplifying forms of frequently recurring concepts, and finding simple compound terms to increase precision when necessary to offset a broadening range of meanings



of a simple term.

- a restricted range of affixes and grammar rules,
- flexible transfer of core terms from one part of speech to another
- logical and simple substitutes for abstruse idioms peculiar to English
- an indication of gradations to the above two sE simplification projects suggesting an order of preference and possible evolution for each listed word.

This is the sort of thing I've been pursuing under the current term 'IngLingo' with invaluable suggestions from some other reform planners.

(Bruce) Rather than using the expression sE in this Compendium, the convention here will be to change it to Traditional English. The reason is that we are working towards the goal of an IAL that would become the STANDARD, while present sE would then become the historical, traditional, or classical English. It is too early and presumptuous to use the phrase 'historical' and the term 'classical' is already used in other contexts, hence the selection of 'Traditional'.

[Robert] Learning vocabulary is a major task for those trying to acquire a new language. We should seek to develop an international lexicon of most widely acceptable words, e.g. soldier ~ soldat, editor ~ redactor, sailor ~ matrose; also place names, Macedonia ~ Makedonia, Russia ~ Rossia, (as per UNGEGN - "UN Group of Experts on Geographical Names"). Words like "soldat, redactor, matrose" may not have much resonance for speakers of non-European languages, but the numbers of people speaking European languages is vast, and many of these words have been adopted into non-European languages where countries were either colonies, e.g. Indonesia, or influenced, e.g. Japan. Also, European languages have taken root in the Third World, e.g. Latin America.

[Doug May 3] I like the UNGEGN suggestion -- new to me -- but not sure that e.g. 'matrose' is more widely understood than 'sailor' or some more basic term like perhaps 'ship worker'.

[Robert] I suggest "interlingua" rather than "pidgin". Learner's language ~ interlingua ~ Traditional English. (There will obviously be things to be learned from pidgins which can be applied to the interlingua.

[Doug May3] Interlingua is a generic term for pidgins, creoles and other bilingually perhaps including patois, but 'Interlingua' is already in use for the constructed interlinguaj, earlier (originally called 'Latino sine flexione') by Peano of Turin, 1903, later (and perhaps still currently) the system adopted in 1951 after 26 years of research to compile the most common European word roots by New York's International Auxiliary Language Association, compiled by Dr Alexander Gode and co-workers. [See Dr M. Monnedrot-Dumaine's 'Précis d'Interlinguistique Générale et Spéciale, published 1960 by Librairie Maloine, Société anonyme d'Éditions Médicales et Scientifiques, 27, Rue de l'École-de-Médecine, Paris] IALA published through Storm Publishers, New York an Interlingua-English dictionary, 1951, (480 pp.) and Grammar (1951, 2nd edition copyrighted by Science Service, Inc., 1955, 128 pp.). Several international journals on spectroscopy were published in Interlingua, and a handful of medical journals included précis of each article in Interlingua. Alfandari's 'Neo' (1965) is one of the best improved systems based on Esperanto, Ido Interlingua-IALA and de Wahl's Interlingue.

Click here to return to the  
[Table of Contents](#)

end of Compendium

**MENU:** [HOME](#) » [Reconstruction](#) » [Recovery](#) » [Renewal](#) » [Language Main Page](#)

---

---

June 13, 2000

# Angel / Arabic Font

The following are what we call the vowel set in Angel  
(but it also contains "ing" and "er")

آي <sup>s</sup>	آه	او
A as in bay	a as in cat	d (ou) as in out
اي <sup>s</sup>	اه <sup>s</sup>	ار
E as in bee	e as in bed	r as in sir or baker
اي <sup>o</sup>	ايه <sup>s</sup>	اوي <sup>s</sup>
I as in pie	i as in sit	b (oy or oi) as boy or oil
اوه <sup>s</sup>	اه	اوه
X (0) as in go	x(o) as in dog	k (oo) as in tool
اه <sup>s</sup>	اوه <sup>s</sup>	نج
U as in up	m (oo) as in foot	n (ng) as in ring

The following are what we call the small Consonants  
(because they are lowercase - small letters in the Angel/English Font)

<p>تند</p> <p>w [wh] like in wheel</p>	<p>ش</p> <p>s [sh] like in sheep</p>	<p>شي</p> <p>t [th] like thousand</p>
<p>و</p> <p>w [wh] like in when</p>	<p>جـه</p> <p>z [zh] like in garage</p>	<p>زه</p> <p>t [th] like in thee or the</p>

The following are what we call the Large Consonants  
(because they are uppercase - capital letters in the Angel/English Font)

ب	د	ف
B [bee]	D [dee]	F [fee]
ج	هـ	جـ
G [gee]	H [hee]	J [jee]
ك	ل	م
K [kee]	L [lee]	M [mee]
ن	پ	ر
N [nee]	P [pee]	R [ree]
س	ت	فـ
S [see]	T [tee]	V [vee]
و	ي	ز
W [wee]	Y [yee]	Z [zee]

**This is an attempt to analyze the use of Arabic as an**

# Angel Script.

A. The idea to use Arabic was prompted by the fact that the current Angel characters have the following deficiencies.

1. unaesthetic
2. difficult to scan
3. disturbing to people acquainted with Traditional Orthography
4. too similar to English for those who have an anti-English cultural bias
5. impossible to write cursively
6. detracts from Angel as being a separate language.

B. It was felt that Arabic would be a possible choice because

1. It is the language of Revelation
2. It is recognized and admired in Moslem cultures throughout the world.
3. It has a long calligraphic history and many established styles.
4. It is used phonetically.
5. It can be written rapidly - (cursively?)
6. It has a deep linguistic tradition, like Arabic numerals.

C. Further investigation of Arabic has disclosed that it too has the following deficiencies.

1. While it is said to be phonetic, it really does not have a much stronger claim to that than T.O. English.
2. There is no single Arabic letter representation for each phoneme.
3. Some of the Arabic letters are use in combination to create a variety of phonemes. The Aleph alone appears in 13 Angel phonemes.
4. There are only 29 letters in Arabic whereas Angel has 39 phonemes.
5. There are about one third of the Arabic phonemes (as represented by Arabic letters) that do not have an equivalent phoneme in Angel.
6. While English uses two cases (Upper and lower).
  - a. The upper case being used to start sentences and proper nouns

and sometimes for emphasis.

b. The lower case being used for body text.

Arabic has four cases.

a. A stand alone character.

b. A beginning of word character

c. A middle of the word character

d. An end of the word character

D. Given all these deficiencies I am continuing an examination of Arabic for the following reasons.

1. It remains the language of Revelation and for this reason its used should be encouraged so that the world's population will more easily make the transition to studying the texts of Revelation in their original form.

2. It might attract support for Angel (as an IAL) from the world's geographically distributed Moslem population.

3. It might serve as some sort of Bridge annotation for those from a Moslem background who would be learning Angel.

E. The obvious problems at the moment are:

1. The problem of display and printing of the characters.

While I have not yet seen them I have however seen intimations that there are word processors for this purpose and that some web browsers such IE 4.0 have versions that can display the existing text.

2. Whether even the above browsers and word processors could display what I will call the Angel/Arabic font is questionable.

3. Keyboard entry of the Angel/Arabic font would be another problem although this might be overcome in two manners that I know of.

a. The re-assignment of the keys as we do for a Dvorak keyboard or

b. A translation program that would take Roman Character entry and convert it for display in an Angel/Arabic TrueType format.

The beauty of the present system is that one can write in traditional English and the Angel Translator Program will put the text into the present Angel Font.

A second translator program could then put into Angel/Arabic with right to left printing. Except for the character representation itself, this would not be an arduous task to program.

The difficulty comes in developing a word processor that would display in Angel/Arabic font and format.

4. As per C (2,3 and 4) if we are to represent the Angel phonemes we must use an Arabic technique similar to what we would call a diphthong in English.

AND

if we are going to have a single letter to represent a single sound (which is an INVIOABLE Angel Principle) then we must create new Angel/Arabic letters.

5. The new letters in 4 above will be used in a typesetting rather than a calligraphic fashion.

6. The new Angel letters need to be created in an aesthetic fashion that still retains the Arabic identity so that they can be used in transition to Arabic.

Link here for the website for the [Angel Tutor](#)

Peace and love,

[Bruce Beach](#)

**MENU: [HOME](#) » [Reconstruction](#) » [Recovery](#) » [Renewal](#) » [Language Main Page](#)**

---

---

**MENU: [HOME](#) » [Reconstruction](#) » [Recovery](#) » [Renewal](#) » [Language Main Page](#)**

# ESSAYS

**If you have an essay or proposal about Universal Auxiliary Language that you would like to post here, please contact:**

[language@webpal.org](mailto:language@webpal.org)

[LANGO](#) Is a book about Language Organization. A very scholarly and informative study about possible solutions to the need for a universal auxiliary language.

[A WLP proposal](#) that was submitted to the UHJ. It contains a study about the Baha'i teachings and Universal Auxiliary Language

[Letter to the UHJ on the subject of gender](#)

[UHJ on the subject of gender](#)

[A Description of Essential World English](#)

[Prospects for the World Language Process](#) This is a paper presented by Jonathan B. Britten of Nakamura University, Japan, at the JALT (Japan Association of Language Teachers) conference in November, 2002 and submitted for publication in their proceedings.

**MENU: [HOME](#) » [Reconstruction](#) » [Recovery](#) » [Renewal](#) » [Language Main Page](#)**

---

---



**MENU: [HOME](#) » [Reconstruction](#) » [Recovery](#) » [Renewal](#) » [Language Main Page](#)**

# LANGO

[LANGO](#) Is a book about Language Organization. A very scholarly and informative study about possible solutions to the need for a universal auxiliary language.

The 2001 edition of LANGO - with extensive appendices and an "Introduction for Baha'is" - is at <http://bahai-library.org/books/lango/>

**MENU: [HOME](#) » [Reconstruction](#) » [Recovery](#) » [Renewal](#) » [Language Main Page](#)**

---

---

# L \_ A \_ N \_ G \_ O

## "Language Organisation"

L angue	L anguage	L engua
A uxiliaire	A uxiliary	A uxiliar
N eutre	N eutral	N eutral
G lobale	G lobal	G lobal
O rganique	O rganic	O rganica

A\_FULLY\_DEMOCRATIC\_APPROACH\_TOWARDS  
 AN\_INTERNATIONAL\_AUXILIARY\_LANGUAGE  
 INITIALLY\_BASED\_ON\_REFORMED\_ENGLISH

by

Robert Craig & Antony Alexander

\*\*\*\*\*  
 "E PLURIBUS UNUM"  
 \*\*\*\*\*

First published 1996 by:  
 LANGO, PO Box 141, Douglas, Isle of Man,  
 IM99 1ZQ, U.K.  
 All Rights Reserved  
 ISBN 0-9529446-0-X  
 Published on these web pages by permission

Revised 1997, 1998

### KEY

This publication is principally aimed at the general reader who may be unacquainted with basic linguistic terminology and symbols. For this reason, references, footnotes and the International Phonetic Alphabet are omitted and a glossary is included at the back.

[ ] identifies letters on the page.  
 // indicates their pronunciation.

For example, [sc] = /sh/ (near the middle of page 5) means that the digraph "sc" (in Old English) is pronounced "sh" as

\* \* \* \* \*

Click here to return to [World Language Process Home Page](#)

## CONTENTS

Click on Chapter Name  
 to go directly to chapter

CHAPTER		PAGE
	<a href="#">Preface</a>	5
	<a href="#">INTRODUCTION</a>	7
1	<a href="#">The Origins and Spread of English</a>	9
2	<a href="#">English as an Auxiliary Language</a>	11
3	<a href="#">English as a Primary Language</a>	16
4	<a href="#">English and Other Languages</a>	19
5	<a href="#">The Constructed Languages</a>	23
6	<a href="#">The International Auxiliary Language</a>	26
7	<a href="#">The International Language Committee</a>	29
8	<a href="#">Constructed and Organic Languages</a>	31
9	<a href="#">Language in Education and the Media</a>	34
10	<a href="#">Orthography and Orthoepy</a>	38
11	<a href="#">The Language of Empire</a>	40
12	<a href="#">Pidgins and Creoles</a>	43
13	<a href="#">LANGO Grammar</a>	47
14	<a href="#">LANGO Vocabulary</a>	55
15	<a href="#">LANGO Phonology</a>	58
16	<a href="#">LANGO Orthography</a>	60
17	<a href="#">History of English Spelling Revision</a>	63
18	<a href="#">A Suggestion Towards Orthographic Reform</a>	69

19	<a href="#">International Pronunciation and Accent</a>	75
20	<a href="#">Names and Organisation</a>	79
	<a href="#">Glossary</a>	82

## Preface

The Biblical story of the Tower of Babel reminds us that the notion of a universal language has existed for a very long time. There have been numerous candidates including Sumerian, Akkadian, Hittite, Babylonian, Persian, Aramaic, Greek and Latin in the West; and Sanskrit, Pali and Chinese in the East.

The motto of the U.S.A. is reproduced on the first page to signify the goal of global language unification - which no doubt will be ultimately realised through an international auxiliary language. The authors of the Constitution of the United States would have been mindful of Latin as the most successful universal language when they chose this aphorism - linking what would become the foremost English-speaking country with the Roman civilisation of antiquity.

For almost two thousand years Latin had played the role of common language to the known world, but the founders of the American Republic would have known it as a long-unchanged predominately written language used by scholars. At that time, French was still the accepted universal language of culture and diplomacy, but subsequent events, influenced by the failure of the 1745 Jacobite rebellion in Scotland, conspired to pass the mantle of the international auxiliary language on to English - which still retains it, though with less than wholehearted support from other language groups.

Indeed, the unwillingness of the great powers to agree upon one of their own languages for use as a common tongue led to the concept of a politically neutral and orthographically consistent artificial language. The past 150 years have seen numerous attempts to construct such a language from familiar elements like common word-roots. Esperanto has remained pre-eminent among these constructed languages but has failed to correct serious defects of grammar and vocabulary.

As we have seen in Northern Ireland and former Yugoslavia, a shared language is no guarantor of peace; but it does allow a wider understanding of the issues, so that the cause of problems may be identified and rooted out. With the world facing an unprecedented range of potential disasters, from terrorism to ecological breakdown, the need for a universal language to facilitate co-operation has never been greater.

Moreover, unmistakable signs of progress towards a lasting peace and harmonious civilisation are evident throughout the world, inseparable from the remarkable 20th Century advances in standardisation, in all branches of arts and sciences, in religious understanding, and in education. This outpouring of knowledge, though pictured by a global media, can really only be shared through the use of language. A common tongue may not be the whole answer, but is certainly part of it.

Click here to return to [Lango Directory](#)

## Introduction

The present account attempts to promote our belief that a reformed version of the English language, prepared according to democratic procedures, would now be the best starting-point for a planned international auxiliary language.

In theory there are two strands of thought here: the concept of an international auxiliary language, and the idea of English spelling reform. Hitherto, these causes have usually been treated separately - an artificial auxiliary language on one hand, and proposals to improve English for use within the English-speaking world on the other - but in practice they are already inseparably combined in the form of the pre-eminent multinational status of the English language.

The following 20 chapters build upon this realisation by advocating the orthographic reform of an offspring of English to an international standard, the substitution of words from other languages, and the possible incorporation of certain rationalised grammatical forms pioneered by the creoles. The intention is to initiate an empirical process of reform towards a revised version of English, not only for everyday usage, but also for the attention of the globally representative committee of linguists that will eventually be appointed to choose the international auxiliary language.

The cost of translation between increasingly interdependent language groups might well force the convention of this body of experts sooner rather than later. Currently it would have to choose between a traditional, organic, "natural" language such as English, Spanish, Russian, Arabic or Farsi, and one of the rationalised but limited constructed languages such as Esperanto or Glosa. We are offering proposals towards a third alternative which would incorporate and harmonise the essential qualities of both national and artificial tongues.

The suggestions in Chapters 18 & 19 are offered as concrete examples in the hope of stimulating discussion. The result of such schemes would be perfectly comprehensible to English speakers, at least for a considerable period of time, though the spelling would be different from the start. Moreover, a language so revised would always be an auxiliary - at least in name - so traditional varieties of English could remain in their present roles as long as demand for them continued.

It is all very well to set out the linguistic requirements of a world language, and project a path from an existing tongue towards it, but the exercise is merely academic unless various cultural phenomena expressed through language are taken into consideration. One of these is the now well-established democratic point of view which would challenge the primacy, though not at all the validity, of "autocratic" and "objective scientific" approaches to language reform.

Click here to return to [Lango Directory](#)

**MENU:** [HOME](#) » [Reconstruction](#) » [Recovery](#) » [Renewal](#) » [Language Main Page](#)

---

---

Click here to return to [Lango Directory](#)

## Chapter\_One: "The\_Origins\_and\_Spread\_of\_English"

Original English was a Germanic language closely related to Friese. The Germanic group of languages came into being as a result of trade between speakers of the expanding Indo-European languages and the native peoples of the Baltic. Slightly more than 2,000 years ago Germanic-speaking tribes began to expand from their homeland, moving southwards towards the Rhine. As a result, the Celtic speech of these areas was replaced by Germanic dialects. Germanic was already a mixed language containing elements which were not Indo-European.

By the 4th Century, the Roman Army in the West was largely recruited from these German tribes, so Britain was full of various German soldiers: Bavarians, Allemanns, Franks, Swabians, Frisians, and, most commonly, Saxons. As these soldiers were pensioned off they settled down in Roman colonies, and married local British women. Lowland Britain was, therefore, trilingual, with a Latin-speaking administration, a Germanic-speaking army, and a Brittonic-speaking populace.

After the withdrawal of the Roman administration in the 5th Century, Britain was left with a considerable population which was Celtic in race but Germanic in language. Brittonic-speaking Picts from what is now called Scotland were starting to raid south along the east coast and Goidelic-speaking Scots from Ireland (Scotia) were invading and occupying Argyll and also Dyfed, Gwynedd and Cornwall.

It was not long before an even wilder tribe was settling uninvited along the north-east coast. These were the Angles ("Engle" in Old English) from the area of Schleswig near Flensburg still known as Angeln. Whether or not the Angles dominated a larger area than the nominally Saxon bands which had established sovereignty further south, their dialect "englisc" ([sc] = /sh/ in O.E.) which was closely related to the Germanic lingua franca of the old Roman army of occupation, became the name of the popular language which was emerging from the coalescence of all these influences. The Angles also gave their name to the country which came to be identified with this common tongue.

By the Middle Ages, English had displaced Brittonic from most of England - apart from Yorkshire (Elmet), Hereford and Shropshire, the Chilterns, Kent, Gloucestershire, Dorset and Somerset, Lancashire and Cumberland. Pockets of Brittonic speech persisted here for shorter or longer periods, while English incorporated Scandinavian dialects, and a large amount of Norman and Central French from 1066 A.D. onwards.

As a result of these influences English emerged in the 12th Century as a new hybrid language bridging northern and southern Europe. Later, neologists referring directly back to Latin further modified English,

so that it has ended up closer to Italian than to French. Moreover, English might now be better identified as a Romance rather than as a Germanic language, although the adjective precedes the noun - as in four out of the world's five leading languages: Chinese (Putonghua), Hindi, English and Russian. The exception is Spanish - which is a Romance language.

Meanwhile Ireland had been annexed by Henry II - since when Irish idioms have played a part in shaping the increasingly heterogenous English language. Brittonic continued to be spoken for a long time in Cumbria, and until the 18th Century in Cornwall, but was long ago replaced by Irish in Pictland (most of modern Scotland) and the Isle of Man.

By reason of long association, the senior or intrinsic tongue intimately linked with Great Britain might be said to be Brittonic rather than English. The descendant of this original language of the Britons (including the "English") is, of course, still found in Wales - with a Gaulish-influenced variant in Brittany. The remarkable endurance of these two Brittonic-derived tongues can largely be ascribed to the diverse and mainly alien origins of both English and French which, although formed within the British Isles and France, have never really been national tongues, in the sense of being identified with the whole or a part of a country, or with any single country.

Thus English and French have both been, to some extent, international languages from the start: a role which they have continued to perform in different areas, though English has obviously replaced French as the leading world language. As English has spread throughout the world it has drawn in elements from numerous languages, including Latin, Greek, Hindi, Malay, the Amerindian tongues, Maori, Chinese, Zulu etc.. The map of "World English" embraces varieties in Africa, North America, the Caribbean, Australasia, India, Malaysia, the Philippines, Polynesia and Melanesia.

Most estimates put the number of idiomatic English-speakers, mostly from mother-tongue countries, at around 370 million. Second or auxiliary language speakers, i.e. those for whom English is not the primary language or mother-tongue, may be divided between fluent speakers, reckoned at about 100 million, and less than fluent speakers - but with some knowledge of the language - who are counted between 300 and 700 million, depending upon where the line is drawn between what is "English" and what is not. Another commonly quoted statistic is that a quarter of the world's population (of nearly 6 billion) speaks some English. It is also reported that about 80% of the world's electronically-stored verbal information is in English. Such estimates are necessarily rough and somewhat speculative, but they indicate the approximate size of the numbers involved.

Click here to return to [Lango Directory](#)

**MENU: [HOME](#) » [Reconstruction](#) » [Recovery](#) » [Renewal](#) » [Language Main Page](#)**



Click here to return to [Lango Directory](#)

## Chapter\_Two: "English\_as\_an\_Auxiliary\_Language"

The great common languages of humankind arose, not by planning, but rather by accompanying civilisations of historic significance. Thus Greek became the language of learning for centuries as a direct result of the outstanding pre-Roman civilisation of Greece which produced scientists and philosophers like Pythagoras, Hippocrates, Socrates and Plato; and writers like Homer and Euripides. Following the conversion of the Roman emperor Constantine, Latin became the lingua franca of the Christian church in Europe; and then, after Muhammad, Arabic was the common tongue of the Islamic civilisation which stretched at its height from Spain to China - and gave the rest of the world so many branches of knowledge. French was later the language of the international culture which, coeval with and in reaction to the turbulence of the Reformation, identified itself with French style and humanist philosophy.

Similarly, the rise of the English language mirrored the fortune of the English-speaking world as it diversified through a variety of commercial enterprises, military campaigns, cultural activities and missionary endeavours into the largest political combination the world has ever seen. Moreover, an overall reputation for administrative justice, and for upholding the right to life and faith, held English in good stead, long after the end of Empire, a tradition maintained to a great extent through various international agencies with close links to the best aspects of Anglophone civilisation. However, there are now signs that the relative influence of the English-speaking peoples is waning, whether in the commercial or cultural spheres. The inexorable lesson of history is that the decline of the English language should follow.

But a world awakening to consciousness of itself need not be determined by historical precedent. Even supposing two centuries of Anglo-American hegemony were bought out by Chinese economic success, English might still surpass Chinese as a basis for the international auxiliary language: not only due to its spread and status, but also by virtue of its inherent qualities. Hence one point of view that merits consideration is that an internationally determined, but orthographically unreformed, version of the English language would adequately fill this role. Could a modern version of English be formally adopted by the U.N., taught to children in schools all over the world, and used for all international purposes?

This certainly remains a possibility: for English retains a high profile as an international auxiliary. The large number of schools and institutes continuing to teach English to foreign students; its use in information technology, air and maritime telecommunications, publishing, international scientific and medical terminology, global conferences and, of course, popular music; the co-status of English and French as the two "working languages" among the six used at the United Nations - all these things attest to the continued health and vibrancy of English as an international auxiliary language.

The relative neutrality of English, compared with other ethnic and national tongues, also allows it a greater role as an international auxiliary. For example, books by Palestinians are currently being translated into English, and then from English into Hebrew (i.e. not directly from Arabic to Hebrew). Likewise, in Belgium many nationals choose to address one another in English rather than use the language of the other community; and there are even calls for a Flemish capital city because of the dominance of French in Brussels. A similar situation exists in South Africa, where languages such as Afrikaans and Xhosa are identified with national groups, but English is seen as neutral. This feeling about English is also a factor in its success in India and many African countries.

However, in spite of these recommendations, we find not only chauvinism from within other language communities, and historical resentment from within ex-colonies, but also thoughtful lines of argument which question the fundamental suitability of any national or otherwise partial language for the demanding role of international auxiliary. One criticism is that such languages always have features which are linguistically difficult for people from different speech areas: for example, the common English phonemes /dh/ and /th/ would be included in this category; another would remind us that native speakers have an advantage when using their mother-tongue with those for whom it is an imperfectly absorbed second or auxiliary language: since the latter have to struggle with the language as well as with the ideas under discussion. It is thus claimed with no little justification that diplomatic, commercial and ideological advantages would accrue to those countries where the chosen international language was spoken as a mother-tongue.

Only a minority of people are perfectly bilingual, so this is a real problem, and one for which translation is an inadequate solution. Proper translation is inconvenient and expensive because it requires an excellent knowledge of two or more languages. (Fluent speakers of second languages may appear to be competent, but can cause misunderstandings by missing idiomatic meanings or misusing words, e.g. "demand" for "ask for".) Most of us have a far from perfect command of even one language. Some idioms can be difficult for the average translator to understand, much less correctly translate, and many words, e.g. "fun, pet, get; demi-tasse, éclat (Fr.); Gemütlichkeit, Weltanschauung (Ger.)", often have no exact equivalents in other languages. Numerous are the gaffes and misunderstandings, with occasional disasters, which have resulted from mistranslation.

A common source of amusement has been trade names which have unintended meanings in other languages: such as the "Nova" car that "doesn't go" in Spanish. Diplomatic gaffes like President Kennedy's "Ich bin ein Berliner!" are from the same vein of humour. (The two expressions are now equivalent in German - perhaps too many foreigners were calling themselves frankfurters and hamburgers - but in the early 1960s inclusion of the little word "ein" - in direct translation from the English - changed the meaning from "I am a Berliner!" to "I am a jam doughnut!")

The absence of an international language can also have tragic consequences. It is widely reported that the atomic bomb was dropped on Hiroshima at least partly because of a mistranslated reply from the Japanese. At another time many died in Spain when bread was made from imported grain. Nobody could read the labels which identified it as mercury-treated seed-corn. More recently a World Health

Organisation report warned about the dangers of countries donating drugs and medicines. For example, some pregnant women in Latvia were given cattle worming medicine which caused them to go temporarily blind. Doctors had guessed at what the medicine was by comparing labels. Mediators in international crises regard lack of a common language as a major complication. For instance, this view was expressed on BBC Radio 4 after the recent (August 1996) hijacking of a plane containing 199 passengers from Khartoum to Stansted (London) via Cyprus.

The failure, in 1919, of the Conference of Paris and Treaty of Versailles has been partly attributed to the inherent deficiencies of translation. It has been suggested that the fact that Clemenceau spoke both French and English, but that Lloyd George and Woodrow Wilson spoke only English, gave an undue advantage to the French on their home ground. Thus, whereas Anglo-American intentions were transparent to the French, the heads of the British and American delegations had to understand the French position through the medium of translators and Francophone (almost certainly Francophile) officials. This tended to ensure that the French and Belgian demands for excessive reparations against Germany prevailed.

Such objections to translation and the international use of national tongues were the motivation behind the idea of an international auxiliary language: which every child would learn at school in addition to the mother tongue. Esperanto has been the most successful attempt to create such a "neutral" language. It continues to set the standard in various ways, even while remaining an essentially European concept with certain unrevised defects which now limit its international viability.

Moreover, the same objections continue to militate against English: which cannot but be classed as a national language to some extent, in spite of its present international roles. Indeed, such is the level of feeling about the issue, that not only is English unlikely to be adopted as the international auxiliary language in its present form, but a reformed version would have to consciously move from the English-speaking world to the whole world: whether in orthography, phonology, vocabulary or grammatical structure.

A name change would also be necessary, as pointed out by Hans Lunder of Oslo, Norway, in letters to the "European" (30/5 & 4/7/96): "...Seventy per cent of those Europeans earning double or more the average income are able to read English newspapers or watch TV news in English.

I propose that we make English the main European language for communication, conferences and international events. The world is getting smaller but has too many languages. These mean unnecessary expense and time in translation, wasted time learning other languages, poor communication, cultural polarisation and conflict.

Nationalism is the main problem. The French, for example, fiercely guard all aspects of their language. "English" is both the name of a country and a language. This problem can be solved by calling the international English "Globish" the global or world language. Then everybody could talk and write Globish without thinking about nationalism..."

"...I propose Globish - "the global language based on English" - because it is simple to grasp and express. I do not propose that Globish should take the place of national languages but that everyone could use it as a supplementary or auxiliary language."

We would endorse Mr Lunder's concept of "the global language based on English" with a new name (which might be "Globish" or something else - the name doesn't really matter) because the present status of English as an auxiliary language is equivocal: businessmen, politicians, scientists and even language researchers from the English-speaking countries have evidently greatly overestimated its penetration as a second language. In 1989 a study conducted in Belgium, France, Germany, Italy, the Netherlands and Spain concluded: "The real correct understanding of English in all the countries studied is notably inferior to the most pessimistic existing evaluations and our own guesstimates" Van de Sandt, Report in "Initiative Media News Bulletin" (London: Lintas Worldwide, January 1989).

In 1990 Sir (now Lord) Randolph Quirk, Professor of English at University College in London, put it thus: "Despite the persistent and glib assumptions in Britain and America, we are witnessing a significant relative decline (perhaps even an absolute decline) in the currency of English worldwide. This may come as a surprise to those who think of English as the medium of high-tech skills, international conferences, and professional journals: here indeed continued growth is doubtless the order of the day. But these are relatively slim and specialized lines of communication."

In 1991 Richard Bailey, Professor of English Language and Literature at the University of Michigan and Associate Editor of the "Oxford Companion to the English Language", was even more specific: "The proportion of the world's population who regularly use English is 15% - and falling." It appears that, although mass travel, media and communications within the English-speaking world have continued to iron out extremes of accent and dialect, preventing mutual unintelligibility between indigenised varieties, the burgeoning of these very connections has also exposed the comparative economic decline and moral uncertainty at the heart of the English-speaking world. Thus the appurtenances of modern civilisation may well have had the reverse effect of lowering the prestige of English and turning the masses in various ex-colonies towards other cultures and languages.

Moreover, English can be difficult; many who are not natural linguists have failed to master it, in spite of intensive study. Stress and intonation present particular problems. Idiomatic expressions can be confusing or misleading. Uncertain syllabification, irregular and phrasal verbs, the vast range of tenses and compound nouns are among the features of English that cause headaches for its students. Even the so-called simple grammar itself, based on prepositions and word order rather than inflections, is very vulnerable to the bad writing which stems from muddled or disordered thinking. In such a case the efficient but rather fragile syntax breaks down and the meaning becomes ambiguous or impenetrable even to native speakers. Worst of all is the notorious dissonance between spelling and pronunciation.

The official use of English in aircraft telecommunications, to which most countries and airlines have signed up, is contentious for the same reason. A number of horrific air crashes have been directly related to the difficulties of English when used for this purpose. For example, in 1977 two 747s collided at Tenerife, with a death toll of 582. The Dutch pilot had apparently misunderstood the English of the

Spanish air traffic controller. Similarly, the Russian pilot's poor understanding of English (far from untypical according to Indian officials) was blamed as a significant factor in the very recent (12/11/96) mid-air plane crash over Northern India, which killed 351. Moreover, the British Airline Pilots' Association reports that, contrary to the official agreement, French and Spanish aircrews use their own languages in the air. Also, local languages are used to gain advantages over English-speaking crews, e.g. precedence in landing. A rational, consciously internationalist language, that crews would take pride in speaking correctly, would go a long way towards eliminating these infringements.

Finally, since language is an organic phenomenon, English has sometimes been characterised as reaching that proverbial "middle-aged" condition where, in contrast to the lean and questioning period of youth, the mind tends to narrow whilst the body enlarges. During a century and a half from the beginning of the 16th Century, between 10,000 and 12,000 words were introduced into English, of which half still exist. Shakespeare coined about 1,700. Also, a measure of orthographic and grammatical reform accompanied the new words. But since that time, although the English language has been distended by the addition of thousands of new words, they have been mainly in narrow or specialised areas, especially those concerned with science, technology and commerce. The fact that English has developed in this narrow-minded way (as has every other "national" tongue to a greater or lesser extent after its own fashion) seriously limits its capability as an international auxiliary.

In particular, the historical connection between the English language and Judaeo-Christian civilisation has allowed a cultural gap to develop between English and Eastern tongues with very different political and religious traditions. As a result, English is not the ideal medium for use as an international language in these societies, and holds the status largely for lack of an alternative. One problem is that English has few words for many concepts that exist in Eastern tongues. For example, the words "knowledge" and "love" are used in English to cover different categories of meaning that are separately defined even in Ancient Greek; much more so in Arabic, Farsi and other modern languages. Such deficiencies make English an inadequate vehicle for both speech and translation in the eyes of some cultures.

Click here to return to [Lango Directory](#)

**MENU: [HOME](#) » [Reconstruction](#) » [Recovery](#) » [Renewal](#) » [Language Main Page](#)**

---

---

Click here to return to [Lango Directory](#)

## Chapter\_Three: "English\_as\_a\_Primary\_Language"

National languages tend towards exclusivity. The purist movement in Iceland, supreme for about 200 years, has kept Icelandic notably free of foreign vocabulary and grammar. When Norway achieved independence it began to develop a Norwegian language purged of "Danishisms"; and similarly when Romania became a nation it set about replacing Slavic elements. Purifying the national language is something that nations try to do. International languages on the other hand tend to be inclusive. Spanish has been very influenced by Arabic, and by the languages of South America; and Persian also absorbed huge quantities of Arabic when it became an international language. Russian has likewise been ready to admit foreign elements, receiving words from all quarters, in contrast to the majority of Slavic languages (e.g. Czech and Slovak which are rooting out words of German origin).

It would be almost impossible to "purify" English in this way. Most of the vocabulary is from other languages and the grammar has drawn in elements from around world for centuries. The attempts in Scotland to establish Scottish English suffer from the same problem since Scottish English is shot through with foreign influences from the same sources. Whereas languages obviously limited to a national role, like Welsh and Irish, are amenable to "purification", it would make no sense for varieties of English, all of which have departed from the "national" type. English has apparently been abandoned to internationalism: no language, including Latin, has been so separated from its roots. This means that an offspring from English might be consciously developed as a basis for an orthographically-regular international auxiliary language, while the rest of the English language continued in its present national and international roles.

Although English has gone well beyond the boundaries of national exclusivity, it is far from culturally neutral. Its pre-eminence as an auxiliary is very much a result of the former political and commercial dominance of the English speaking peoples. But it is also seen to be the best, or the least bad, existing language for international purposes from the linguistic point of view: a state which it has achieved by incorporating a greater variety of words from diverse languages, by disposing of genders and other superfluous or non-essential parts of speech, and by avoiding the kind of "national" linguistic reform which would have made English less appealing at the international level - the consequent incongruity of T.O. with any known speech has given English the benefit of a measure of cultural neutrality.

These relative advantages, compared with other languages, have allowed English to function as a second language for necessary communications, but the heart of the language is still fixed in the English-speaking world, which limits its creative usefulness for speakers and writers from other cultures. Such

internationally-acclaimed authors as Professors Chinua Achebe and Wole Solinka still value English as an auxiliary language, but for essentially this reason do not write in it as much as before. They now have serious reservations about English as a literary medium for African expression. Other writers resent the pervasive implication in Anglo-American culture, often explicit in the mass-media, that the typical African lifestyle is inferior. Consequently they refuse to use English, and propose Hausa or kiSwahili as the pan-African language. A similar attitude is widespread in various ex-colonies of the U.K. and U.S.A.

The difficult question is how English might become a distinctly idiomatic language without, as Achebe put it, losing its "value as a medium of international exchange". Unfortunately, what tends to happen at present is the worst of both worlds, for whatever the historical assimilative capacity of English, the sclerotising combination of businesspeak culture and spellchecker orthography is now stifling its capacity to adapt to, or represent, varieties of ethnicity. Moreover, much if not most of the English in many of these countries is more or less suffused with the characteristic stress-patterns, rhythms and intonations of indigenous languages, and is infused with elements of their grammars and vocabularies. For example, in India, the West Indies and West Africa, the English spoken tends to be timed by individual syllables rather than by stressed syllables, as in British and American English. The result is that, although these indigenised varieties of English may function efficiently as lingua francas between or within these countries, they may be sometimes difficult to comprehend when used in international circumstances.

The tendency of the English-speaking world to overestimate the global use of the language is largely due to colonial legacies, such as the third-world élites at American and British universities and military colleges who subsequently maintain the profile of English through commercial contacts and domination of the local media. This English-speaking leadership may have come into existence partly because the colonial administration was ambivalent about native peoples learning English since, as a common tongue, opposition to Empire spread through it; but, for whatever reason, such prominent figures are wholly unrepresentative of the penetration of English into the general population of these countries. The international usage of English is actually quite precarious; but by the same token it is well positioned for a thorough revision.

English is the sole or joint official language in about forty-five nations; but in most of these countries, and especially in Africa and Asia, it is the native tongue of no more than a small minority. Moreover, the desire to affirm national cultural identities is beginning to promote indigenous languages in the education system and elsewhere at the expense of English, not least through television. Thus English is gradually losing even more of its limited influence on the masses; and is becoming almost exclusively the auxiliary language for international communication.

But that is not necessarily a great honour either, for an exclusively auxiliary status might threaten the long-term survival of English in these countries, since it would no longer be used as a primary language. Moreover, the international focus in these parts is moving away from the English-speaking world, and more towards regional economic communities which favour other languages.

On the other hand it must be admitted that, although the English-speakers in these nations are numerically small, some of them exert an influence far beyond their numbers by reason of international relationships or links - whether in administration, commerce, literature, the arts, science or religion. This is the point of view from which the prospect for English looks hopeful. For were its orthography to be entirely reformed and its name changed, so that it became politically and linguistically acceptable to many more progressive thinkers within these nations, primary status as the living world language - the growing conduit for global culture - might well be realised.

Click here to return to [Lango Directory](#)

**MENU: [HOME](#) » [Reconstruction](#) » [Recovery](#) » [Renewal](#) » [Language Main Page](#)**

---

---



Click here to return to [Lango Directory](#)

## Chapter\_Four: "English\_and\_Other\_Languages"

Languages are continually in a process of transformation. A primary language or mother-tongue might become extinct, or turn into an auxiliary elsewhere. Equally, a second language might become a primary tongue through relexification. Thus Cornish borrowed so much vocabulary from English that it became thoroughly "Englished". This continued until the majority of speakers decided that they might as well be speaking English: so they abandoned Cornish.

In America the first wave of immigrant tongues, e.g. German, Italian and Japanese, disappeared in this way. The same is already happening to mostly second-wave languages such as Russian, Korean and Vietnamese, though the process may take longer given the greater dissimilarity between most of these languages and English. Even indigenous Amerindian tongues, before which English is an immigrant language, are gradually fading for the same reason. Decreolisation has occurred in a similar manner, as in Hawai'i, where the original indentured labourers from Japan, the Philippines, China etc. used Pidgin English, their children developed Hawaiian Creole, the next generation used Hawaiian English, and many of their descendants are now speaking General American English.

Most minority tongues, having found themselves isolated in the midst of a major language area, have eventually vanished likewise. The process has appeared to be impervious to both herculean effort and generous funding. The classic example within the British Isles is the Irish language. In spite of, or perhaps partly because of, seventy-five years of Irish Government endorsement, the primary language community of mother-tongue users of Irish has continued a long historical shrinkage to its present level of about 10,000 speakers. The obvious reason for this process has not changed over time: a knowledge of English gives access to an incomparably greater range of literature, television, radio programmes, domestic employment opportunities in an increasingly international market, foreign travel, and so on. Conversely, Irish is a difficult language for those outside of a mother-tongue family to learn to speak properly: largely due to a marked discrepancy between the spoken tongue with its 60 phonemes and the historic Irish spelling system.

Those who are concerned with the future of Irish recognise that the size of the primary language community is crucial because any tongue will only develop organically, or in a genuine rather than a prescribed manner, when it is used creatively as a primary language. From this point of view the large number of people who speak Irish even quite fluently, but as a second language, do not really count because the predominance of their thought, and hence of their linguistic innovation, tends to take place in English. Similarly, the fact that the number of native Welsh speakers may currently be increasing should

not necessarily be seen as significant, so far as the future of this language is concerned. For Welsh is much easier to learn than Irish, and is also more important symbolically, in the absence of other tokens of statehood. The salient fact from the linguistic or long-term political viewpoint is that the increase is of those who continue to value and speak English for the access it gives to a wider international culture.

But English-speakers should not be complacent. The status of their language largely rests upon a past greatness, and currently favourable political conditions; whilst these minority tongues are being revived (or resurrected in the case of Manx and Cornish) more thoroughly and systematically than in the past, with Government assistance, and particular concentration upon pre-school children. The tide of opinion could turn, to leave English high and dry, if it was felt that these tongues were easier to learn than English, and offered more in the form of creative expression.

The use of English as a media language, including in recorded items such as audio and video tapes and discs, has been a central part of its success during this century. So much so that some promoters of minority tongues see media saturation, even to the extent of suppressing all other languages on local radio and T.V., as the only route to survival. The plethora of broadcasts in English across the expanses of the U.S.A. earlier this century was indubitably one of the main factors in the decline of other languages. More generally, the electronic media have provided an incentive to learn one of the major languages - in order to be able to follow the maximum number of broadcasts. This is at least part of the reason why over half the world speaks just five major languages: Putonghua (the official language of China), Spanish, Hindi, English and/or Russian. Nine tenths of the rest of humanity use no more than 95 languages, and only 77 of the thousands of remaining tongues have more than 1 million speakers. It is notably countries still largely unpenetrated by the electronic media, or mountainous and with consequent poor reception for land-based signals (e.g. in the Caucasus), that have the largest number of languages (which are often phonetically precise and hence "media unfriendly").

In America, and much of the rest of the world, the dominant media language is of course English. But one language which English will not necessarily be able to displace from the U.S.A. by this means is Spanish: which is very widely used as a media language in its own right. In the U.S.A. as a whole there are over 200 radio and 300 television stations broadcasting in Spanish, as well as 200 Spanish-language newspapers. Moreover, English might lose an audiovisual war with Spanish because the orthographic relationship between the spoken and written language is much closer in Spanish. Consequently, since the acquisition of literacy in Spanish does not depend so much upon the visual impression of the written word, the electronic media are more profitably used for educational purposes in Spanish than in English.

Another modern development of linguistic significance is the growing power of the Spanish-speaking bloc beyond the U.S. southern border. The North American Free Trade Agreement, inexorably leading to the formation of a political union throughout the Americas, will not necessarily operate to the immediate economic advantage of the North. Not only has a great deal of U.S. industry been copied or transferred to low-wage parts of Central or South America (or elsewhere in the world) but a lot of once exclusive knowledge and expertise has gone with it.

At present, linguistic integration is following the standard pattern: most second-generation Spanish-speaking immigrants speak English, and about half speak only English. However, the situation could change: in Los Angeles, Miami, and many towns near the Mexican border more than half the population speaks Spanish and there are large areas where community facilities and essential services operate in that language. Moreover, illegal immigration continues apace, and there seems to be a new mood of militancy: commentators have observed that, compared with a generation ago, immigrant New York taxi-drivers are often reluctant to speak English. English is still the nominal language of American education, but practice very often dictates otherwise. (The fact that English is now the "official language" in a number of states is hardly significant, considering the number of countries where English is the official language but relatively few people actually speak it.)

In a similar way, Quebec has been buttressed by considerable moral support from France over the centuries, but for which French would have disappeared from this part of Canada in the same manner as other minority tongues in North America. Moreover, the relatively high birthrate both here and in the Spanish-speaking countries has helped to move the linguistic balance away from English. This is a worldwide phenomenon. Not so many years ago the global native English-speaking community was second only to that of Putonghua in size; but now, by some estimates, it is overtaken by native populations speaking Spanish and Hindi. These demographic changes obviously concern mother-tongue speakers only, so they affect the primary rather than the auxiliary status of English. However, since creative renewal mostly proceeds through first rather than second languages, an actual or potential reduction in the strength of English as a primary tongue eventually weakens its role as an auxiliary language too. A predominantly second language role is eventually fatal to a language, because the incorporation of "ethnic" words and expressions effectively ceases; rather is the second language plundered to strengthen the "mother tongue".

This process is the norm because the latter remains the primary vehicle of thought and feeling: the language most people hear within their own heads. Conversely the second language tends to be used for second-hand thoughts, the stuff of business transactions and formal conversation, rather than for the creative imagination that gives the impetus to transliteration and neologism. Any second language gives more to the primary tongue than it receives back. Here is an obvious danger to a second language which is not being recreated as a primary tongue elsewhere. Hence, the continuing pre-eminence of English as a second language should be regarded as a temporary reform opportunity towards the international auxiliary language, rather than as a reason for optimism.

The relationship between first and second languages is crucially dependent upon the relative prestige of the associated communities as cultural or economic entities. Often it is difficult to tell whether a language is first or second, and even speakers themselves may be unsure, until they have decided which language is going to bring most practical benefit. Statistics showing the worldwide distribution of English reflect this confusion with widely varying estimates of mother-tongue speakers - e.g. two 1997 reference books, the Cambridge Encyclopaedia of Language (2nd edition) and the 1997 Encyclopaedia Britannica Yearbook, give very different figures, 70,600 and 8,000 respectively, for the number of mother-tongue English speakers in Malta out of a total population of about 373,000.

Ultimately there is only one solution to the dilemma of first and second languages: a single universal auxiliary language which can act as both. It might be asserted that this language already exists embryonically: a still rather nebulous and obscure entity which is growing and forming through the internationalisation of vocabulary, phonology and script. One tremendous impetus in this direction is the transliteration of supranational scientific and religious neologisms into different languages - mainly through the pervasive media culture which is replicating famous names and replaying slogans and soundbites around the planet.

Click here to return to [Lango Directory](#)

**MENU: [HOME](#) » [Reconstruction](#) » [Recovery](#) » [Renewal](#) » [Language Main Page](#)**

---

---

Click here to return to [Lango Directory](#)

## Chapter\_Five: "The\_Constructed\_Languages"

Over the centuries at least 200 attempts have been made to construct a language which consciously reflected this universalising tendency: endeavours which have successively marked the expansion of linguistic theory and political understanding. The movement reached its zenith before the First World War, but has since declined due to certain inherent limitations. Nevertheless, it has greatly advanced the cause by empirically demonstrating the theoretical possibility of consistent grammar, regular orthography and cultural neutrality within a single language - though the combination has not yet been fully realised in practice.

The languages which have been devised for this purpose may be divided into two types: "a priori" and "a posteriori". The former attempted to classify ideas and were unrelated to actual languages. These were pioneered by Wilkins in his "Universal Character" (1668), and by Leibnitz with his projected "characteristica universalis". A later example was Ro: which had some success at the beginning of this century. However it is now generally accepted that any practical solution must be "a posteriori" i.e. drawing on existing tongues. Proponents of the latter prefer the adjective "constructed", since they argue that these languages are made from "organic" elements such as common word-roots.

The first truly successful "a posteriori" language was Volapük ("World Speech"), published by Schleyer, a polyglot German priest. Although 40% based on English, it was complicated by an array of grammatical rules, and an expanded range of vowels. A few years later, in 1887, Dr Ludwik Zamenhof, alias "Dr Esperanto", introduced a language which used fewer vowels and had a much simpler grammar than Volapük. (On the other hand it employed a greater number of consonants identified by diacritics.)

Zamenhof was born and brought up in Poland near the Russian border: a place of diverse ethnic groups divided by language. At home he spoke Russian and studied Latin, Greek, German and French. Hebrew was spoken at the synagogue. Somewhat later he encountered English at school. This may be significant because his "attempt towards an international language" contained several grammatical structures which English manages without: e.g. distinct transitive and intransitive verb forms, separate reflexive pronouns, plural adjectives and the accusative case.

Despite these, and other especial difficulties for certain nationalities, Esperanto entirely supplanted Volapük and went on to a far greater influence. In particular the humanitarian ("homaranismo") movement which Zamenhof explicitly associated with the language exactly caught the spirit of the times. Realising that a consciously internationalist language required an ethic to sustain its ideal, Zamenhof

created a humanitarian morality, or set of principles, subsequently put it into practice in various ways, including through a culture of hospitable exchange. Although such schemes have probably benefited international relations, an unintended side-effect may have been to reinforce the cult of Zamenhof as linguistic genius - which has hindered a rational approach to the reform of Esperanto.

It wasn't long before Zamenhof began to receive extensive correspondence about his language. Amid the general praise he was also offered a number of suggestions as to how the language might be improved. He reacted to the latter by including a questionnaire listing six proposed reforms, with a detachable ballot, in the back of a later edition of his booklet. Of the low percentage of ballots remitted the great majority rejected all six suggested revisions.

However, in spite of this apparent endorsement of his original scheme, certain prominent supporters continued to be dissatisfied: so at the first Esperanto conference, at Boulogne-sur-Mer in 1905, Zamenhof announced a plan to restore unanimity. Citing the paramount need to preserve the unity of the language, he decreed that nobody, himself included, henceforth had the right to alter the basic grammar ("fundamento") of Esperanto until after it had been officially adopted as the international auxiliary language.

Since the near realisation of the latter was expected by many in those idealistic times, before the world was sundered by national, racial, class and religious conflict, Zamenhof had raised a hope ("Esperanto" = "one who hopes") which allowed the movement to progress rapidly for two or three decades. By the late 1920s Esperanto was a household name, 44 radio stations were putting out broadcasts in the language, and it was being taught in the commercial schools of London and Paris. It also had the support of the League of Nations.

The perception that the influence of Esperanto has declined since those days is not confined to the English-speaking world - where Esperanto never really took hold for obvious reasons. Esperanto was very much a product of its time: it displays a 19th Century belief in an objective "mechanistic" approach which runs counter to modern convictions about the organic process of language development. This is epitomised by the exclusive "auxiliary" role Zamenhof ascribed to his language. Although such a status may have made Esperanto more politically acceptable heretofore, it now prevents it from developing organically as a primary language.

Moreover, a letter from a member of "...the "Akademio de Esperanto" the organisation which indeed is responsible for the language itself" explains why the particular linguistic difficulties for some language groups remain unrevised: "...no one, repeat no one, now can possibly propose changes in Esperanto which would have the slightest effect on the use of the language all over the world." "We are constantly receiving proposals from old and new Esperantists for "improvements" to the language, any of which would have as much chance of success as trying to improve the English language - of which there have been many projects, all of which have been, and will always be, ineffective."

Thus the Esperanto Academy, while claiming responsibility for the language, declares itself unable to

exert any influence - as though it could not use its authority to initiate steps towards fundamental revision. Orwell, who grimly satirised the centrally-controlled artificial languages Esperanto, Interglossa and Basic English as "Newspeak" in his famous novel "1984", would have identified this as "doublethink". It is perhaps fitting that Esperanto has latterly found its greatest support in totalitarian states - last refuge of the personality cult.

By mortgaging the future of Esperanto in this way, though with the best of intentions, Zamenhof created a double-bind which prevented the fundamental revisions that might have brought the popular success that would have ensured official endorsement - and subsequent adoption as the world auxiliary language. Another unfortunate effect was to provoke the formation of rivals, the first of which was the openly-derivative Ido ("Birthling"), published in 1907.

Other new constructed languages sought to build on Latin or Greek rather than the European tongues used by Esperanto. For example, Interlingua was based on Latin, and Interglossa on both Latin and Greek. It is noteworthy that some such artificial languages have an even simpler grammar than English - with no verb inflections and very few tenses.

That Esperanto remains pre-eminent among constructed languages, in spite of the many imitators that have set themselves up as rivals, is a tribute to Zamenhof's genius. There is no doubt that the best features of Esperanto, including the concepts of cultural neutrality, rationalised orthography, regularised grammar and global organisation, will live on - though not necessarily under that banner.

The aims of the Esperanto movement were recently endorsed by 183 British MPs in the "Esperanto Parliamentary Group". However, very few of the listed MPs actually speak much Esperanto, and neither do their constituents. Many have made an attempt but have found it too difficult (considering the relatively insignificant size of the world speech-community after a century). It is rather the idea of Esperanto which accounts for its appeal to these MPs: the notion of a "politically correct" international auxiliary language with a simplified and easy-to-learn grammar and orthography. Such is the importance of these populist political aspects that no international language which fails to heed them is likely to succeed.

Click here to return to [Lango Directory](#)

**MENU:** [HOME](#) » [Reconstruction](#) » [Recovery](#) » [Renewal](#) » [Language Main Page](#)

---

---

Click here to return to [Lango Directory](#)

## Chapter\_Six: "The\_International\_Auxiliary\_Language"

The constructed languages have provided a paradigm, if not a realisation, as the strengthening bonds and links between the whole of humanity - whether forged through religion, science, commerce, tourism, sport, the media or in any other way - have increasingly exposed the expense and inefficiency of speaking about common purposes with a multitude of tongues.

But strong opposition to the concept of an international auxiliary language remains, in spite of this powerful testimony. Militant nationalists naturally anathematises the idea - and would proscribe any viable language in the same way that the Nazis banned the teaching of Esperanto in 1935. Such may well have had their day, but opposition is still likely from moderate nationalists who may well be concerned that the international auxiliary will imperceptibly suppress and eventually extinguish their treasured national tongues.

However, unless the constructors of the international auxiliary choose to learn nothing from history, they will refrain from repeating the mistakes of the past. For every tongue forced into silence later shouts out twice as loudly. Basque is but one prominent example. Every minority language has reacted in the same way to the extent that attempts have been made to extirpate it. But within other minority ethnic groups, which have not been linguistically oppressed, there is an even stronger appreciation of the educational, economic or political advantages of belonging to a wider speech-community. This is the dynamic, two-way but unequal, which is allowing many of the minority ethnic tongues to be absorbed by creoles; or by the great "national" languages.

But although most of the speakers of these tongues are persuaded that they are willingly abandoning old-fashioned and limited languages, with which the desire to remain is essentially retrogressive and nostalgic, the alternative viewpoint, which insists that neither the creoles nor the national languages can adequately represent the phonology or vocabulary of the speech that is lost, is still a force to be reckoned with. Emboldened by the long-term political trend towards global subsidiarity, which is encouraging former regions to express an historic "national" identity, this ideological position argues that, since minority languages were formerly obscured by foreign rulers who were hostile to any tongues which might rival their own, the original tongues should therefore be reinstated and restored as symbols and vehicles of cultural independence.

This interpretation appears to be becoming the fashionable orthodoxy. For example, a report in the "Times" (1/5/96) which mentioned the revival of the Manx language and culture in passing, began with



the apocryphal sentence: "A hundred years ago, any child who dared to speak Manx Gaelic in the school playgrounds of the Isle of Man would have a noose tied round their neck." No attempt was made to disabuse the uninformed reader of the implication that it was through political and linguistic oppression, rather than with parental approval, that the Manx language was killed off.

The phenomenon of minority ethnic languages is extremely complex because two separate issues are involved. One is the essentially political view that a major national language such as English, French or Russian, cannot express sentimental attachment to a distinct geographical area with a unique history; or, at least, it cannot when compared with a minority ethnic tongue which has evolved in the place for centuries and supports a personal sense of identity.

The other is a subtler argument, which is essentially linguistic, but also cultural in the patriotic sense of diversity within the body of nations. This asserts that, since any national language, however large the area it may represent, is by definition less than universal in scope, it cannot do full justice to the speech and thought of an area with a different outlook, sense of history, and cultural and religious experience, as expressed through language.

The minority language phenomenon has become one of those issues, like atmospheric pollution or disputed borders, which require a solution beyond the national level: for since the decline of religion as a metacultural bond, the connection between language and politics has been emphasised to the extent that it has become very difficult to hold together a modern nation formed out of old language groups - as Belgium, Canada, and many recent ex-colonies have found. These countries have also demonstrated that bilingualism (or multilingualism), however necessary in practice, is highly unsatisfactory and expensive - and is not a proper solution anyway since everyone always prefers one tongue to another.

The concept of an international auxiliary language addresses the minority language (or multilingual) problem from both the political and the linguistic standpoints. Those nations choosing to be an integral part of the civilised world could retain their mother-tongues for domestic purposes while employing the designated "neutral" international language for all communications outside of the indigenous culture. Every child would learn this specified auxiliary language at school as well as the mother-tongue. Thus it would no longer be necessary for everyone dealing with the wider world to waste time and resources learning several languages; nobody would need to learn more than two.

But this is not the end of the story: such an arrangement would have inexorable linguistic repercussions. The nations of the world are becoming more and more interdependent every day; the notion of self-sufficient or autonomous entities communicating indefinitely on a second-hand basis is no longer credible. Although everyone might learn two languages at school for decades or centuries to come, it is inconceivable that the auxiliary would not take on a life of its own - as a result of authors, advertisers, film-makers etc. writing in it directly to access the global market.

Assuming this came to pass, the relationship between the international auxiliary language and every national tongue would be comparable to that which presently exists, or has existed, between the minority

ethnic tongues and the great national languages which entirely surround them. Thus, even as islands of minority ethnic tongues have been surrounded by a sea of English, every language would eventually find itself within the matrix of the international auxiliary language. And correspondingly, even as English has diluted and absorbed minority ethnic tongues in its midst, it would itself be absorbed, along with all other languages, into one universal tongue of enormous capacity and subtlety.

The history of the dogged survival of certain minority ethnic tongues clearly shows that such a process would never be achieved by force, rather would it happen for cultural and economic reasons. Thus, if speakers and writers were to deliberately use the international auxiliary language to reach the widest possible audience or readership, and listeners were to learn it - and tune into it - to keep up with the latest news and newest thought from anywhere in the world, there is little doubt that this common language would develop its own character as a truly global tongue, even as primary creative impetus went into it. If this did indeed happen - whether through neologism, transliteration, or other aspects of linguistic development - the national languages of the world could be expected to successively abandon their separate identities, over a period of centuries, in order to become part of it: in the same way that some minority ethnic tongues have hitherto become submerged in national languages.

Thus there is no reason to suppose that an international auxiliary consciously developed for creative usage would not gradually obtain the linguistic and euphonic capacity to incorporate all useful features, whether structural or decorative, from both "national" and constructed languages. Indeed, it might well display these assets more precisely and harmoniously than their own more or less irregular grammars, partial phonologies and ramshackle orthographies. In such a scenario the mother-tongues would continue to be preserved in written and recorded form, but ultimately for sentimental value rather than linguistic information.

Click here to return to [Lango Directory](#)

**MENU: [HOME](#) » [Reconstruction](#) » [Recovery](#) » [Renewal](#) » [Language Main Page](#)**

---

---

Click here to return to [Lango Directory](#)

## Chapter\_Seven: "The International Language Committee"

If language were a purely scientific phenomenon, it would be judged according to strictly dispassionate criteria, and endorsement by social groups would be irrelevant. But language is partly subjective and a matter of opinion: it is notable for not always behaving in an objectively rational manner. It is qualitative as much as quantitative: the fact that the majority of languages, or most speakers, use a certain construction is no guarantee that linguistic development is moving in that direction. It is an art as much as a science: which is why a democratic mandate would not be enough in itself, and why it would be ultimately futile to proceed with a scheme, however popular, however apparently coherent and complete, which did not accord with the fundamental views and meet with the basic approval of society as a whole.

This is why the final choice of international auxiliary language is much too important a subject to be determined except through the widest possible consultation. In practice this means that all interested parties must have the chance to be represented or involved, and that any exclusively private or public enterprise, no matter how popular, far-reaching or well-funded, would ultimately fail to thrive without universal endorsement and confirmation. For the international auxiliary language will have to satisfy a variety of political imperatives, financial targets, cultural requirements and philosophical and religious ends.

However, all these interests will need to find a common active focus, lest they be dissipated, and the best instrument would appear to be an international language committee with close links to government, to the scientific realm, and to all parts of society. By the same token, it would be the common responsibility to ensure that this committee were not co-opted by any national or ideological group, which might wish to swing the development of the international auxiliary language in its direction.

Although the responsible international committee would be eminently qualified, the inherently subjective aspect of language would always introduce an element of fallibility into its decision-making. It would therefore be wise to consult widely with concerned groups and knowledgeable individuals, lest expensive mistakes be made. Conferences are proliferating between a growing number of language groups - as in the European Union - so exorbitant commercial translation costs, currently estimated at a minimum of 25p (38¢) per word, will eventually force the adoption of a common language. A hasty or putative choice, driven by political expediency, would inevitably do more harm than good: merely inflaming those national, racial or religious suspicions that act as figleaves to sectional interests.

The responsible international committee convened to form the language would no doubt be aware of

these dangers. No longer might an autodidact, or body of linguists, pluck a language out of the air, or develop one from scratch, when so much has happened already to indicate the limitations of the theoretical approach. So many prescribed rule systems and defined lexicons have failed already that the committee would be flying in the face of all experience were they to create yet another artificial vocabulary and grammar.

Esperanto itself has served to demonstrate that even an excellent linguistic phenomenon is not a language. Zamenhof failed to recognise that a language springs from the people using it. New linguistic modes are constantly coming into being, but in a very disparate fashion, due to the enormous diversity of national and regional speech communities worldwide. This produces the never-ending state of flux which distinguishes a living language from a constructed language, the rules and character of which are fixed.

In any case, there is now such a vast process of interactive research that it would be hard for the said committee to impose a language without due consultation - through which means alone the considerable fund of linguistic knowledge accumulated over the centuries in every culture would become available, to guide and inform their deliberations, and ensure that the chosen tongue be as free as possible from cultural bias - whether in script, vocabulary, grammar, or phonology. The same criterion of practical experience also demands that the selected language be already spoken by a large community: in order to prove that all its various aspects work in everyday speech.

Thus the international committee is most likely to form a new language out of an existing language which already possesses the necessary attributes of speech-community, cultural neutrality, rationalised orthography and transformability to a requisite degree. From these various diverse premises proceeds the logic of a language proposal that would meet the eventual arbiters of the international auxiliary language halfway - or even three quarters or nine tenths of the way. Zamenhof had much the same in mind when he made the revision of Esperanto's "Fundamento" conditional upon official endorsement, although he went only a quarter or a third of the distance before putting a freeze on further development. Had Zamenhof known about 20th Century linguistic insights like Zipf's Law he might have hesitated to take this decision, but he was primarily concerned about preserving the unity of the Esperanto movement, in view of the parlous situation prevailing at the time. Nowadays the better understanding of consultation and the democratic process will make it possible for the heirs of Zamenhof's valued linguistic endeavours to unitedly take the difficult and potentially divisive decisions involved in language formation - towards a successful and unified conclusion.

Click here to return to [Lango Directory](#)

**MENU: [HOME](#) » [Reconstruction](#) » [Recovery](#) » [Renewal](#) » [Language Main Page](#)**

---

---

Click here to return to [Lango Directory](#)

## Chapter\_Eight: "Constructed\_and\_Organic\_Languages"

At first sight these two practical qualifications of the coming international auxiliary language, that it be politically neutral as well as spoken by a large community, appear to be mutually exclusive. For although the constructed languages, and Esperanto in particular, have been spoken by idealistic internationalists from all over the world, nothing like a genuine, organic, linguistically-developing speech community has yet emerged within the constructed language movement - in spite of every advantage from a regularised orthography and grammar.

An explanation of why the constructed language movement has failed to produce a serious rival to the national or ethnic tongues was presciently and cogently given by Edward Sapir in 1933: "Any consciously constructed international language has to deal with the great difficulty of not being felt to represent a distinct people or culture. Hence the learning of it is of very little symbolic significance for the average person, who remains blind to the fact that such a language, easy and regular as it inevitably must be, would solve many of his educational and practical difficulties at a single blow. The future alone will tell whether the logical advantages and theoretical necessity of an international language can overcome the largely symbolic opposition which it has to meet. In any event it is at least conceivable that one of the great languages of modern times, such as English, or Spanish, or Russian, may in due course find itself in the position of the de facto international language without any conscious effort having been made to put it there."

Sapir's prediction has come to pass for the very reason he gave. All languages, whether constructed or organic, rise and fall according to the popularity of the culture they represent. For instance, a constructed language would need the backing of a thriving global speech community in order to prevail. Moreover, when Sapir mentioned Russian as a possible international language it was associated not only with a huge transnational state, but also with a successful political system with ambitions to take over the world.

After the Second World War Soviet influence spread even further, but the realities of communism were reaching a climacteric, and in the 1980s the whole system collapsed. All of a sudden Russian ceased to be the common language of the Soviet Union and its satellites. To some extent English entered the resultant auxiliary language vacuum; but across Central Asia Turkish and other languages reasserted themselves; in Europe, Hungarian and various Slavic tongues re-emerged to reclaim their areas of influence; and in the West of the former U.S.S.R. Ukrainian, Belorussian, Lithuanian, Latvian and Estonian were re-established.

Now that Russia has lost its former superpower status, the notorious linguistic difficulties in the Russian language, such as the numerous irregular verbs, are no longer overlooked for political and economic reasons, but correspondingly are open to further reform. It may happen that revision of a second or auxiliary language is only considered when the dominance of the associated culture begins to falter. For example, part of the resistance to the orthographic reform of English has been a complacent assumption within the English-speaking world that the language will triumph anyway due to the innate excellence, or even superiority, of the associated pattern of civilisation enjoyed by the English-speaking peoples.

Anyway it looks most unlikely, at this juncture in world history, that an international language will prevail through the extension of national sovereignty across the planet. However enlightened certain empires of the past, or even imperialist powers of the 19th Century, might have been; the unfettered state, whether communist, racist, nationalist or nominally theocratic, has evidently turned malignant during this 20th Century, causing so much grief that nations have been effectively forced into confederation for the sake of collective security. Regional economic communities and various political associations under the aegis of the U.N., though not yet formalised on a global scale, have already begun to impede or frustrate the languages through which these national or otherwise partial aspirations or ambitions are inherently expressed. For example, the European Union has rejected English as its official working language; legitimate orthographic reasons are given, but additional factors such as that the political capitals of the E.U. - Brussels, Strasbourg and Luxembourg - are predominately Francophone, should not be considered irrelevant.

Briefly, a world order may have already arrived in which no language will be accepted for international auxiliary purposes simply because its associated nation, class or ideology happens to be more powerful or influential than others at the time. Moreover, the same scrutiny must be given to the constructed languages, which are not without political or ideological baggage - even if it is wholly unconscious and inherent. But nevertheless, in the more equitable cultural and linguistic ethos which is fast approaching, the valuable work put into the constructed languages promises to be realised, not least in view of certain practical considerations; one being that, although great multinational tongues - with millions of native speakers - have revised their spelling, none have approached anywhere near the standard of orthographic regularity set by Esperanto and the constructed languages. Orthographic consistency is also of increasing importance due to the rapidly expanding role of I.T. machinery including voice-recognition software.

However, for equally pragmatic reasons the logistics of the situation will continue to favour a language which has developed organically in preference to an artificial language, even one which is much better from a theoretical linguistic standpoint. The former will have hundreds of millions of speakers and millions of teachers; but the latter, perhaps Esperanto or a similar language, will have, at the most, millions or hundreds of thousands of speakers and thousands of teachers. It is obvious which language would be simpler to graft on to the world for mass usage even in a substantially revised form.

It follows that the optimum language which might now be prepared, in anticipation of the future formation of the international language committee, would probably be an organic tongue combined with the ideal qualities of the constructed languages. All the indications are that language is gradually moving in this direction anyway: for instance, the major organic tongues are being greatly influenced by

universalism and regularity, those signal features of the constructed languages. One facet of this universalism is that vocabularies are converging; many modern expressions including personal, place and brand names, scientific and religious terms and "buzz-words" are the same or similar in different tongues. An international language is thus forming obliquely through global neologism.

The regularising and print-saving tendency associated with the constructed languages also seems to be occurring spontaneously, particularly in commercial areas of English-speaking culture which the sharp eye of the literary-educational culture has disdained to regard, e.g. spellings such as "Kall-Kwik, Def Leppard, Sun-Lite, Lo Kost, All-Nite, U Haul, Spud U Like, Toys R Us" - and the abbreviated headlines characteristic of tabloid newspapers. Moreover, as we show in the next chapter, infants naturally use rational forms until they are "corrected". We also investigate why older students, increasingly living in the aural world of the electronic media, have more difficulty than ever with an irregular spelling which requires the constant impression of the written word. Can orthography resist the trend towards global standardisation which has informed more and more aspects of life, including the electronic media themselves?

All organic languages, having developed in a more or less haphazard manner, contain shibboleths and irregularities despite the operation of this tendency towards rationalisation. The constructed languages on the other hand, while limited by the restricted size and virtual nature of their speech communities, have been able to keep sight of the fact that language and script should be rational phenomena. The international committee which forms the revised language will be well aware of this dual imperative for it to be theoretically consistent while being accepted, nay welcomed, by the wider speech-community.

Click here to return to [Lango Directory](#)

**MENU: [HOME](#) » [Reconstruction](#) » [Recovery](#) » [Renewal](#) » [Language Main Page](#)**

---

---

## Chapter\_Nine:

# "Language\_in\_Education\_and\_the\_Media"

Great power accrued, in preliterate societies, to those who could read and write. Everyone else may have been spared reading nonsense in books, and lies in newspapers, but the consequent limited opportunity for objective investigation, and reporting of events, gave succour to the plots and shady dealings of princes and kings, to extraordinary theological claims, and to numerous wild exaggerations and inaccuracies - which all too often led to strife and armed conflict.

The introduction of the printing press to London, by Caxton in 1476, opened the book on the new scientific age in the English-speaking world. Whereas previously the interest of both rulers and scribes had ensured that the connection between language and script remained mysterious and obscure, the market for printed books demanded a more rational orthographic link. In particular there was a pent-up demand for an accessible translation of the Bible. Consequently Caxton and other London-based printers, using the "East Midlands" dialect typified by Court circles and educated speakers in London, Oxford, Cambridge and central England, rationalised both language and script to some extent.

In retrospect it might be asked why the process did not continue until a common orthographic standard was reached. One answer is that there was simply a lack of demand. The classroom situation of children learning to read provides a useful analogy. Those children who benefit from an intensive education, and/or parental diligence, become literate largely through the habituation of constant exposure to the written word: an osmotic process of memorisation which effectively offsets the partial operation of the orthographic principle in English. Likewise, centuries ago, a tiny educated class, mainly selected from wealthy families which could provide books, and generally having the additional advantage of a knowledge of Greek, Latin and French, had little problem with English spelling.

In fact it is notable that the first concerted attempts at spelling reform did not start until after the middle of the 19th Century - when universal primary education was beginning to become a reality in both the U.S.A. and the British Isles. For the first time, schools were being attended by a significant proportion of pupils for whom the osmotic methods of acquiring literacy were inappropriate, since they had little or no opportunity to read at home. Thus, for want of an alternative, these children had to rely on the phonic or orthoepic method, which incidentally served to highlight the inconsistency of traditional orthography. Spelling reformers, invariably promoters of education for all, were reluctant to see a large section of the population cowed into functional illiteracy by this incongruity.

These facts have taken a long time to permeate the political consciousness for various reasons essentially connected with the particular experiences and prejudices of those who have been setting the educational agenda. However, the evidence is conclusive that whole-word methods are inappropriate for those pupils



not encouraged to read at home. An orthographic reform of English would enormously facilitate literacy by building upon the inherent advantages of the phonic method.

The greatly superior reading skills of Italian compared with English children prove the point. With the benefit of a mostly predictable orthography, young Italians can normally read words whose English translations would often leave equivalent English children guessing. In languages which are even more orthographically regular than Italian, such as Hungarian or Finnish, a small child might read out a page of difficult text, hardly comprehending a word, while being understood by an adult audience.

Children respond to a logical orthography because of an inborn sense that language has laws. Both experience and experiment have long shown that the concept of regular and rational language is innate in young minds. For instance, deaf children may spontaneously develop sign language between themselves, even when they have not been taught it; and many English-speaking children naturally use rule-based words. For example, they tend to regularise plurals into words like "mouses, deers, dices", and turn strong verbs into weak forms, such as "rised, teached, bringed, swimmmed, eated". Scientific studies have confirmed that children prefer to use regular and consistent grammatical forms, even at the expense of brevity and simplicity: a consistent conclusion if the primary purpose of language is to communicate knowledge accurately. A full realisation of its many other powers, mainly associated with brevity, exclusion or wit (including metaphor, metonymy, ellipsis, synecdoche, jargon, in-words and code-words, acronyms, puns, euphemisms, argot and foreign expressions) normally comes later.

The main problem with regard to children is not illiteracy so much as sub-literacy: a condition which can be associated with some aspects of late 20th Century civilisation. The difficulty of English spelling should not take more than part of the blame: another share should go to motivational and social factors. The success of high-profile intensive reading courses, using the phonic method, attests to this. For example "The Independent" on 16/9/96 included a report about a government-funded reading scheme in Bradford, West Yorkshire, which had brought childrens' reading-age on by 6 months in 10 weeks. According to researchers, the childrens' school-work had improved, they were much less likely to play truant, the burglary rate had dropped to less than half of its 1992 level on the housing estates where the scheme was held, and those who had taken part were still well ahead of their classmates three months later.

Such results are impressive enough, but allowance must be made for extraneous factors before conclusions are drawn, not least the quality and motivation of both teachers and students in a showcase scheme. Moreover, some families are very amenable to education as a means of social mobility, particularly immigrants, middle-class incomers and/or those who by reason of religious belief are not bound into local class-systems and attitudes; the corollary being that a similar success would not necessarily be achieved elsewhere.

Indeed, experience has shown that significant sections of the population are resistant to both education and literacy. Successive governments are partly responsible for this. By orienting the state education system towards "white-collar" employment, they have alienated those whose vocation is manual rather

than cerebral, and for whom an academic curriculum is mostly irrelevant. (The over-mechanisation of work which has led to the decline of craftsmanship, mass unemployment, global warming, soil erosion, the marginalising of the animal kingdom and various other ills is part of the same mindset.) All these things will take time to change, but meanwhile a reformed orthography would make literacy more accessible.

Another important factor is that modern media devices, such as the telephone, gramophone, radio, television, and tape and video recorder, have compounded the difficulties of current English spelling by seducing many people, whether literate or not, into an audio-visual environment where they barely read. Since proficiency in English spelling is hard to maintain without the constant visual impression of the written word, especially since the irreversible abandonment of Latin and Greek in the majority of schools, it isn't surprising that the standard of literacy has deteriorated during the latter part of this century, even as these new media have contrived to replace print with images. A British survey in 1996 showed that 65% of 16-24 year olds misspelled "occasionally" and over half of all graduates misspelled "accommodation".

A vicious circle has developed, with children spending more and more time watching television, partly because they find reading difficult. It isn't coincidental that the English-speaking countries lag behind others, both in literacy and educational achievement generally. Moreover, inability to read and write appears to be a factor in a range of social problems which particularly affect the English-speaking countries. For example, it was estimated in 1996 that about half the relatively high U.K. prison population of 54,000 was functionally illiterate.

Recorded programmes, whether sent out through radio, tape, T.V. or video, are an excellent source of learning; but the relative absence of script creates a particular problem in English, since education must depend to a large extent upon written examination. The solution is not to restrict the use of these appliances, but rather to establish congruence between language and script, so that learning aids work with rather than against the examination system.

Computer technology poses a challenge to the English language from the other direction - by providing script without language. There is no sound to give a guide to the meaning of unfamiliar words and idioms - and "netiquette" forbids the correction of spelling mistakes! Users of the Internet in various countries must normally use English because it is the established lingua franca of the medium - to the irritation of many speakers of other languages. Nana Mouskouri, the European Union Commissioner for Culture, has been charged with combating the spread of English through the Internet. This is one of many circumstances crying out for the establishment of a simple and orthographically-rational official international auxiliary language; another is international drivers' documents - which Spain has turned into an issue by insisting upon Spanish translation.

The Internet is certain to become an important phenomenon in the future, although less than 5% of the world's population presently has access. English predominates in the medium for reasons connected with its pre- eminent international status; but the outdated and biased orthography of English is wholly

inadequate for the Internet's exacting demands. The right linguistic vehicle has yet to be found: meanwhile English is the least bad language in terms of global comprehensibility.

The demand for an Internet language with a predictable orthography will grow because, in a silent medium, those with limited command of English can only discern the sound of words orthoepically from the script. But if they cannot do this to the extent of reading words with confidence, due to English orthographic irregularity, they will start looking for a language which is written as it is spoken and spoken as it is written. Moreover, as increasing numbers of people get "wired", there will be more and more who can read and write some English, but cannot speak it well enough to hold an extempore conversation. But the desire to do just this is demonstrated by the growing demand for "netphones": simply computers with an integral telephone, which is used ordinarily as a telephone, or as an adjunct to script on the Internet (the addition of a video camera permits video conferencing). If English does not rise to the challenge of these modern inventions, with reforms leading to orthoepic predictability, another language is likely to replace it.

The Internet has encouraged abbreviations like "imo" = "in my opinion" and "re-hi" = "hullo again" (it may not be long before such words creep into speech.) Orthographic reform would likewise tend to reduce the size of words by omitting silent letters and replacing common digraphs. For example replacing "th" (/dh/) in English by a single letter would mean an approximate 3% print saving. Thus orthographic reform would reduce the space required by words, whether on the page or the screen - which would consequently reduce the relative cost of literature, and hence encourage literacy.

Click here to return to [Lango Directory](#)

**MENU:** [HOME](#) » [Reconstruction](#) » [Recovery](#) » [Renewal](#) » [Language Main Page](#)

---

---

Click here to return to [Lango Directory](#)

## Chapter\_Ten: "Orthography\_and\_Orthoepy"

Only within the last 1% of recorded history has the majority of people become literate. Most people, for most of the time, have used language without script. Moreover, when languages with scripts are compared to those without, there is no essential difference as regards structure, pronunciation and complexity of vocabulary. Languages with scripts naturally have a more extensive vocabulary; but not necessarily a more useful and subtle one. No wonder it is called "language" rather than "script".

Likewise, in the life of the individual, language always precedes script - and has greater influence. Language encompasses the euphony of speech, the levels of meaning within words, and the power and mystery of names; whereas script, however attractive on the page, has no function except to represent language. This dominance of language over script means that the primacy of the orthographic ("correct writing") principle over the recessive, but still operational, orthoepic ("correct speaking") principle is the consequence of the natural order of priorities.

Obviously there are advantages in having a script to accompany language; but a script, by itself, does nothing to mitigate, and may even multiply, the "Chinese whisper" effect inherent in speech. The legend of the dragon's teeth which, when buried in the soil spring up later into soldiers, was reputedly a comment on the invention of script - with its ability to rend apart languages, and hence cultures and nations, when interred in books - separate from the continuous development of language. Likewise, the story of the Tower of Babel (Genesis 11) tells of a disintegration into a multiplicity of tongues. One might speculate whether a disinclination among the hierarchy for face-to-face meetings concerning the building of the tower led to the introduction of a chain of command through hieroglyphics on papyri or clay tablets - which worked well until there was a breakdown in the correspondence between speech and script.

In less colourful terminology it might be said that problems are created when someone who recognises a script attempts to read it without fully understanding the significance of the symbol-system to the person who wrote it. This is because (alphabetic) script has an innate orthoepic ("correct speaking") function which evokes speech-sounds corresponding to the ascribed symbolism of individual letters. A doubling of confusion tends to occur because a spoken word takes different forms when written down on the page according to different orthographic ("correct writing") systems (whether they use the same alphabet or not), while a single word on the page is read in different ways when different education systems ascribe different orthoepic values to the letters.

In this way the orthographies or spelling systems based on local dialects which were devised in Scotland and the Isle of Man had the effect of breaking up the Common Irish language. Religious differences were also undoubtedly a provoking factor in this area. The Roman Catholic Church had seen Ireland as a springboard for the conversion of England, but considered the native language of Ireland an irrelevance, or even a hindrance. However the Protestant churches historically associated the Irish language with Catholicism and, when evangelising in Scotland, modified Common Irish according to the Protestant translation of the Bible published in 1801. (The Latinate neologism "Gaelic", often pronounced "Gahlic", is proper to a Scottish form of the language which in earlier times would have been known in Scotland as "Erse" i.e. Irish.)

This attitude was most radically displayed in the Isle of Man where a peculiar spelling system, using mainly English conventions, originates from Bishop Philips' translation, completed in around 1610, of the 1604 edition of the Book of Common Prayer. The first printed book in Manx, dated 1707, was a tract on Christian duties; and the entire Bible, published 1771-3 and since taken as the literary standard, confirmed the separation between Manx spelling and the Common Irish spelling employed at that time in Scotland and Ireland. Essentially the Common Irish orthography is still used in Ireland, apart from a few reforms introduced by the Oireachtas in 1948, and the substitution of modern script for the old half-uncials.

In Scandinavia, Norwegians, Swedes and Danes still speak much the same language; but less so than before, partly due to the introduction of differing orthographies. Norway had been ruled by Denmark for centuries, and then by Sweden for decades, when in 1853 Ivar Aasen constructed a Norwegian language, with its own orthography, from the rural western dialects of the country. After Norwegian independence in 1905 this language "Nynorsk" became the focus of cultural self-determination; but was resisted by the urban majority in Norway who regarded Nynorsk as rustic and preferred a dialect closer to the Danish of the old ruling élite. Although Norwegian is west Scandinavian, and Danish and Swedish are east Scandinavian, the resulting compromise between Nynorsk and Dano-Norwegian has produced a language which slots in between Danish and Swedish, which themselves have drifted apart over time.

Orthoepic divergence tends to be even greater where a single language is orthographically written down in two scripts. Before the recent conflict in former Yugoslavia, Serbo-Croat was much the same language everywhere it was spoken, despite being transcribed into Cyrillic and Roman script in Serbia and Croatia respectively. However the religious and national polarisation accompanying the war has separated the spoken language to a greater extent by introducing partisan religious terminology, and also by fracturing the integrity of the former Serbo-Croat speech community, thus giving more scope to foreign orthoepic interpretations of the language. Reportedly, the Croats are bringing in words from other languages and coining neologisms, in a deliberate attempt to create a distinct Croat language.

A similar division has taken place between Urdu and Hindi. These two literary languages were derived from colloquial Hindustani and published by the British in Calcutta at the beginning of the 19th Century. Devised for predominately Moslem and Hindu readerships respectively, they were written in Arabic/Persian script with a Persianised vocabulary and Devanagari script with Sanskrit/Prakrit loan words. Hindustani continued as the lingua franca of India, and was promoted as a simplified Hindi-Urdu

by Mahatma Gandhi. However, since partition in 1947, the termination of the common national culture has allowed this common spoken tongue to be defined ever more by Moslem and Hindu terminology in Pakistan and India respectively. The situation of an integral speech area being gradually sundered apart as a consequence of the introduction of the same script with different orthographies, or different scripts with the same orthography (or a combination of the two), is one that has occurred many times. The divided parts normally merge themselves into other language groups, unless they themselves become dominant. The ideal compromise of a new shared standard orthography does not seem to have happened much - if at all. However, valuable though such regional affiliations would undoubtedly be, the wider question of integration of all the world's languages is incomparably more important, since the advantage of the part is best served through the advantage of the whole.

Click here to return to [Lango Directory](#)

**MENU: [HOME](#) » [Reconstruction](#) » [Recovery](#) » [Renewal](#) » [Language Main Page](#)**

---

---

## Chapter\_Eleven: "The\_Language\_of\_Empire"

An alternative situation also exists where, instead of a single speech community being divided by two scripts, a single script area contains a number of speech communities. The former pertains to smaller countries and nations; whereas the latter is found in empires, or former empires, where the necessity of keeping together peoples with wholly different patterns of speech has been paramount.

For example, an entirely ideogrammatic script has enabled China to remain a united country despite the difference in language between provinces: the Chinese script does not relate at all closely to any of the language varieties in China, so it serves them all. This means in practice that, when people from different parts of China meet, their speech is often mutually unintelligible - though they can of course understand one another's ideograms. The Chinese Government has been attempting to remedy this state of affairs by promoting Putonghua: the "national language" based on the Beijing pronunciation of the northern dialect. This official language was first introduced in 1955 along with the Pinyin system of transliteration into Roman script - which is now used for proper nouns. Putonghua has since been given a simplified script and is taught in every school in China.

This promotion through the national education system has ensured that the Chinese are already well on the way towards creating a unified language and script. Other factors are conducive to the same end: the large number of workers on the move since economic liberalisation, the compulsory use of Putonghua at international conferences within China, and centralised radio and television broadcasts - to which the geography of China is well adapted. However, the problem is entirely different for English and French, the only "empire" languages which, by geographical spread, are seriously regarded as international languages; they are now the property of so many diverse nations and interests that reform in the Chinese manner is practically impossible.

Under the circumstances it may be considered surprising that English and French have survived at all as reasonably homogenous international entities. The former recognisably "international" pronunciation of both tongues has lost the respect of the political establishment within both homelands, to the extent of being deliberately subverted by the domestic broadcasting services, and the opposition in ex-colonies continues. However, the nationalism motivating these trends is not necessarily a bad thing, provided it is kept with reasonable limits. Protest that local phonologies do not relate to the orthographies of former imperial languages is by no means illegitimate. The worldwide spread of the great national languages has always had as much to do with political sovereignty as with any intrinsic linguistic merit, though the two are of course intimately connected.

In spite of all these drawbacks; the one advantage these two languages enjoy - an international status - is

at least equal to all the benefits accruing to Putonghua as a great national tongue. Whether as the two "working languages" of the United Nations, or as the literary recipients of some of the world's brightest talents, they are the palpable beneficiaries of the need for an international auxiliary language. The honour accruing to a principal focus of this need, the B.B.C. World Service, explains the extraordinary dedication of its staff, including many "stringers" or foreign correspondents who are prepared to work for it for nothing or next to nothing, and why its English is still of a high broadcast quality (though not nearly as high as it was), in contrast to much of the B.B.C. domestic output.

Nevertheless, it is evident that the U.K. alone is no longer prepared to bear the cost of such an institution, and that the World Service will have to come under the aegis, or at least share facilities, with the national service: with all the potential for a parochial British attitude that entails. Many commentators have expressed misgivings at the prospect. This is yet another evidence that the writing may be on the wall for present-day English as an international language. American world service broadcasts are likewise excellent; but the limited output suggests a similar lack of funding.

The experience of these major colonial tongues is directly relevant to the coming international auxiliary language. It too will be the lingua franca of a kind of empire: the coming world federal system, even now being constructed behind the scenes, largely in response to new kinds of economic inequity produced by the instant operation of market forces among peoples at such different stages of social and political development that more than half the world's population has never even used a telephone; while small sections elsewhere, who often but not always lack the moral counterpart to their material civilisation, live in a state of affluence which is largely dependent upon access to the latest technology. This is an old problem, but the simplistic solution of redistribution by force has arguably made the situation worse. A change of attitude by all parties is the fundamental requirement: a vast educative process in which the international language will be central.

Computerisation has given wings to Marx's dictum that "capital breaks down all Chinese walls". The multinationals now largely exist within a global cyberspace that transcends every nation state: rapidly moving resources to where they can obtain the best financial return. The global superstate is coming into being on the same level in order to counter the social and ecological disruption produced by this economic activity. It will also have the task of maintaining peace and establishing global equity through an agreed and enforced code of laws: inevitably placing some limitations on national sovereignty in favour of world unity. However, although the necessity for such a planetary federation has often been advanced, nobody would be so bold as to assert that it would always operate perfectly - even though it might be an improvement on some the empires of old.

Similarly, the international auxiliary language is unlikely to be used in the right way, and in due measure, everywhere it is introduced. In such circumstances, all the tendencies that bedevil present tongues, such as towards orthographic irregularity and fossilisation, will no doubt threaten its integrity. However, moderation in matters of vocabulary, phonology and script will minimise these dangers. Another safeguard would be the creation of an international speech standard upon which to base a unified orthography.



Click here to return to [Lango Directory](#)

**MENU:** [HOME](#) » [Reconstruction](#) » [Recovery](#) » [Renewal](#) » [Language Main Page](#)

---

---

Click here to return to [Lango Directory](#)

## Chapter\_Twelve: "Pidgins\_and\_Creoles"

Anyone who has found themselves off the tourist trail in a foreign country, with whose inhabitants they share no common tongue, may have witnessed the first stage of a contact language in action. Although basic requirements in such a situation may be communicated via sign language, a few words representing relatively complex ideas, not quite so easily gestured, are already so ubiquitous that those who have the means to travel abroad may gain a helpful response by uttering them even in provincial areas of almost any nation: these magic words include: "otel, taksi, telefon, banko".

This contact language is the beginnings of an international auxiliary language, which is emerging unofficially through the commercial world ahead of official endorsement, such is the demand for it. Such contact languages appear through necessity. Grammar is superfluous, given the immediacy of the context, and so is linguistic purity. Moreover, whether or not the affix pertains to a particular language is irrelevant, so long as the word-root conveys meaning: e.g. "bank, banque, banco, banko" - any such word will suffice.

Today the contact language phenomenon, like everything else, takes place on a world stage - such is the power of the mass media. But these most rudimentary of tongues are not a new invention; they have appeared throughout history wherever international communication has been essential: thus war zones, e.g. Vietnam, have provided a number of examples. Likewise "Russonorsk", a primitive Russian/Norwegian hybrid tongue, developed between whalers from these countries based on the inhospitable Svalbard archipelago and Kola peninsula in pre-Soviet times.

Such auxiliary languages have naturally come to an end with the circumstances which produced them. However, another kind of situation exists where contact is long-term, but neither party wishes to learn the other language. Typically this has been because both sides are more interested in trade than fraternisation. Thus the contact language has remained an auxiliary, but used and elaborated so much over time that it has developed structure and grammatical rules.

This type of auxiliary language is called a pidgin for a reason which is no longer obvious. The most popular explanation points to Chinese Pidgin English where "pidgin" means "business"; but about six other possible derivations for the word have been advanced. One theory suggests encounters with the Pidian Indians in Venezuela as the source; another harks back to the merchant adventurers who set sail from Southern European ports such as Genoa and Lisbon in the 14th and 15th Centuries, initially in an attempt to secure the spice trade by sea routes, since the land route had been cut by the westward thrust

of the Turks.

A prominent member of the crew in these sailing ships was the translator. Who would such a figure have been? As often as not, he came from that race of scholars - the Jews. He would have spoken Ladino - the Mediterranean Yiddish. Thus it might be supposed that the word pidgin comes, via Ladino, from the Hebrew word for barter - "pidjom".

Some details concerning the origins of pidgins are still disputed, but the central facts correspond in broad outline with the general development of language in communities and individuals. This topic might be approached by considering the following example in the development of an international vocabulary: although underground railways began in London, the word "underground" has not travelled in this connection, nor has the New York word "subway" - which in Britain rather means an underground tunnel for pedestrians. The word for "underground railway" which has prevailed internationally, even within the English-speaking world, is "metro", and it is not difficult to see why: the word is short (Zipf's Law), its phonemes are both common and easy, and it has the right associations in various ways - e.g. with "metropolis".

Briefly, the word "metro" has the right resonance in many cultures. Similarly it seems that indigenous peoples, approached by seafarers bearing goods which they wished to barter, but speaking a language quite unlike their own, seized upon certain of the words being enunciated in connection with these goods, and signified affirmation of a proposed exchange by repeating these words, perhaps in a modified form, with appropriate expressions and gestures.

Had the merchantmen been linguists they would have found that the words thus emerging with cross-cultural resonance were nearly all short and simple, with perhaps only four or five vowels, and no phonemic difficulties like consonant clusters. In any case, when they discovered which words were acceptable and could be readily understood, they proceeded to teach and use them as a business or barter contact language wherever they went. After a number of such trading encounters, this contact language of appropriate words began to arrange itself according to the bare minimum of syntax and grammar required by a strictly commercial language, i.e. it became what would now be defined as a pidgin.

Once a pidgin was successfully formed in one place, it was apparently considered expedient to try it elsewhere; there is evidence that the Portuguese-based pidgin spoken in West Africa around 1500 AD was actually taught by the Portuguese. Moreover, the fact that many pidgins around the world contain words of Portuguese origin such as "savvy, save" etc. from Portuguese "saber" ("know") and "pikin, pikinini, pickaninny, piccanin" etc. ("child") from "pequenino", the diminutive of Portuguese "pequeno" ("little"), is a further indication that pidgins were taught by these pioneers of global exploration and trade.

The many pidgins based upon reductions of French, Spanish, English and other languages, e.g. Sango - an African tongue, seem to have appeared in a similar way. The first pidginised English arose between American Indians and settlers at the beginning of the 17th Century. The activities of British seafarers

gave rise later the same century to Pidgin English on the Chinese coast and also to the West African English-based pidgins. By the end of the 19th Century, English-based pidgins had come into existence in various parts of the world, but principally in West Africa, the Caribbean area, S.E. Asia and the South Seas.

Some pidgins share some words or word-roots, but the lexical differences between these tongues are still great, mostly as a result of originating from different base languages. However, the pidgins also share a universal characteristic called "transparency", which is simply a receptiveness to linguistic innovation. This can be difficult to see, due to the obtrusion of base languages, but the same concern for the mundane efficiencies of life which has mostly eliminated from the pidgins grammatical categories such as number, gender, case, person, tense, mood and voice, is always on the lookout for new economies of expression.

The signal result of this transparency is that, even if a useful linguistic feature is rare in the world's literary languages, it is likely to appear sooner rather than later in the pidgins. For example, subject-verb-object syntax along with the associated jettisoning of inflections, first appeared in the Indo-European language group around 1000 AD. This innovation has been slow or unsuccessful in penetrating literary languages, but entered the pidgins immediately. The coming international auxiliary language has a lot to learn from the pidgins: for to begin with it too will be mostly concerned with the groundwork of international communication - rights, laws, rules and agreements. Much of the linguistic superstructure will probably have to come later.

A creole is a pidgin which children have learned as a mother-tongue, while elaborating it according to inherent linguistic rules, and adding words from different sources. In practice the distinction between creoles and pidgins is not clear-cut; a pidgin may become a mother-tongue for some and yet remain an auxiliary for others. Hence "pidgins" may be partially or almost wholly creolised. Another factor which should be mentioned is that some pidgins and creoles are closer to the base language than are others. For example some West Indian creoles are, depending on the speaker and the circumstances, more or less accessible to English speakers from elsewhere; whereas other English-based creoles will always be completely incomprehensible to outsiders.

In many countries of the world creoles are growing at the expense of indigenous tongues and borrowing freely from the major languages; in this way, English and French are being effectively marginalised in former colonies where they are still the official languages. A not atypical example is Mauritius, where English is the official language, but hardly anyone speaks it, and very few speak French. Nearly everyone speaks creole. Like an egg sucked dry by a weasel, English may appear to be unaffected by the burgeoning of these creoles; but the very fact that primary creative activity is going into other languages is depriving English of vitality and impetus: starving it of development except in narrow and specialised areas such as are found within commerce and science. That languages like Tagalog, Malay and even Korean are becoming anglicised is not necessarily indicative of the triumph of English; it could rather be a sign of it being devoured.

The simple grammar and phonology of the creoles, and the transcultural resonance of their vocabulary,

allows them to become common languages for the speakers of diverse minority ethnic tongues: a feat which linguistic remoteness prevents great European languages from fully achieving. For example, although Cameroon was divided (in an approximate 4:1 ratio) between French and British colonial administrations in 1919, under 20% of the population speaks French or English (the two official languages) in contrast to the 50% who now speak creole - which has become a vital lingua franca between Cameroon's 24 major African languages and more than 220 minority tongues. Likewise the exclusive or auxiliary use of creole is expanding in both Nigeria and Papua New Guinea which have over 400 and 860 minority tongues respectively.

However, the role of pidgins and creoles should not be over emphasised. Popular they might be; but they are still phonetically restricted, lexically utilitarian and grammatically reduced languages which have to struggle to express complicated or abstract concepts by using unwieldy circumlocutions or inelegant grammatical bolt-ons. Whether in words, speech or grammar, the pidgins and creoles dominate the mass-market - as it were; but the major languages are ahead of them in range and flexibility.

The quality of creoles is as tongues which have developed entirely orally, and specifically as trading languages, primarily concerned with sounding good, and being as comprehensible as possible to a wide variety of peoples. Thus any "threat" which the pidgins and creoles present to the great national languages is only because the dead hand of literary orthodoxy has stopped the orthographic revision which would allow the popular sounds, words, speech-patterns and grammatical short-cuts developed by the creoles to be incorporated or transliterated. Such beneficial linguistic innovations will no doubt figure strongly in the forefront of the minds of those who construct the international auxiliary language, whether or not they are heeded by the guardians of the great national languages.

Click here to return to [Lango Directory](#)

**MENU: [HOME](#) » [Reconstruction](#) » [Recovery](#) » [Renewal](#) » [Language Main Page](#)**

---

---

Click here to return to [Lango Directory](#)

## Chapter\_Thirteen: "LANGO\_Grammar"

In theory the international auxiliary might begin from any language: its appearance centuries hence after incorporating the best features from every tongue, living or dead, would be much the same whatever the starting-point. However, the right inaugural language would greatly speed and facilitate the process; and we are proposing that a reformed version of English would be ideal for the role. For example, those who learned it would be using their time profitably, even should the projected purpose fail to be realised; the mastery of one of the world's major spoken languages would guarantee a return on their investment. They would be able to go to any English-speaking country and be perfectly well understood, since the reforms would affect the script rather than the language - at least for a considerable time to come.

There would also be a distinct advantage in beginning with a language whose particular irregularity lies in the script rather than in speech, for language is normally more spoken than written. The spoken word always precedes and usually outweighs the written, whether in the life of the individual or of society, and consequently is more ingrained and less amenable to change. Script revision is not easy, but changing a spoken tongue is so hard that it is probably best accomplished through the orthoepic effect of script reform.

The relatively simple grammar of English came into existence precisely because popular speech threw off superfluous grammatical constructions while aristocratic and learned circles were using French and Latin. Moreover, English is part of the Indo-European family of languages, which is twice as large as any other, and where the dominant trend for 1000 years has been towards subject-verb-object rather than subject-object-verb syntax, and the use of word order rather than inflections.

Languages tend to fall into three grammatical types: synthetic - case endings and inflections - as in Russian; agglutinative - compound words with prefixes, suffixes and infixes - as in Turkish; and isolating - bare word roots without inflections or affixes - as in Chinese. English grammar developed into a form that does not fit exclusively into any of these camps but, partaking of all three, allows at the one extreme for elementary prosaic communication, using just the present tense and simple nouns with short sentences and, at the other, for complex expressions employing the full range of a grammar which contains these three characteristics: a wealth of inflected pronouns, verb tenses and moods; a variety of compounds - such as constitute many nouns, verbs, participles, adjectives and even adverbs; and isolates - typically the prepositions and conjunctions which hold English together with the aid of pronouns, punctuation and word order. This gear-changing capacity of the language may be seen by comparing typical tabloid journalism with the finest philosophical exegesis.

A measure of flexibility in grammatical style is necessary if linguistic unity is to be maintained in the face of a wide variety of cultures. The previous chapter showed how pidgins happened upon the minimal grammatical, lexical and phonological requirements of speech. However, although these tongues are relatively accessible by virtue of their simple grammar and basic phonology, they are severely limited, for the same reason, when it comes to prosaic discussion of complex and abstract subjects. Conversely, the great literary languages have preserved an advanced grammatical and lexical capacity, though at the expense of penetration throughout society and across cultural boundaries.

The essential feature of pidgins is their mundane genesis as contact languages: hence minimal grammar, with juxtaposed one-clause sentences, suffices for straightforward subject-matter: e.g. "Man plough. He my brother." English typically embeds the second clause into a complex sentence: "The man [who is] ploughing is my brother." The strength of the English construction, with its relative pronoun, is that it contains an element of transcendence or ambiguity (ploughing what?); but this is also its weakness. Comparing a religious saying in these two styles might show this: "All men are equal before God. He is no respecter of persons." "All men are equal before God, Who is no respecter of persons." The former is the original or authentic version.

Potentially, there is a gulf between these two kinds of language. The pidgin or tabloid type needs less grammar, because the meaning lies less in the sentence than in the word, whether it describes an entity or a situation. This kind of speech, which is essentially focused upon a material object, runs through picture story-books and propaganda posters into its modern home: the television set. Among the constructed languages it is exemplified by Glosa - which has only four tenses (as in "mi sedi [I sit], mi nu sedi [I am sitting], mi pa sedi [I sat], mi fu sedi [I will sit]") and no inflections, i.e. practically all its words can be used interchangeably as noun, adjective or verb. Glosa is a slightly modified update of Interglossa, the international language invented by Lancelot Hogben, humanist and polymath.

The basic unit of pidgin-grammar is the clause, but complex language also derives meaning to a great extent from the tension between clauses embedded in a sentence, and from the dynamic between adjacent sentences, and the contrast between paragraphs; its grammar, whether expressed through pronoun, inflection or tense, is the fulcrum for the shaft of understanding thus formed. This kind of language is still found in newspapers, but more usually in journals and books.

The constructed language Volapük exemplified this literary type of grammar. By the time of the third congress, in Paris in 1889, Volapük had 200,000 adherents in 300 societies and about two dozen publications; but the attempt to conduct the congress entirely in Volapük proved that a language which worked on the page could nevertheless be unsuited to general conversation. Volapük subsequently faded away after author Schleyer, priest and polyglot, refused to simplify it.

Any discussion of this subject would be incomplete without mention of the Canadian media philosopher Marshall McLuhan (1911-80 - he appears in Woody Allen's multi-media comedy film "Annie Hall"). By his aphorism "the medium is the message" McLuhan was essentially describing the qualitative difference between a human conversation, in which there is the possibility of dialogue (in spite of the prevalence of

boring monologues!), and interaction between human and machine, where dialogue is once-removed, if it exists at all. By their very nature, the voices of the media talk at us rather than to us, and do not particularly want a reply: a tendency that has become ever more so as these organs have consolidated into centralised ownership, and have moved from print into more expensive and elaborate electronic imagery.

McLuhan thus perceived a relationship between the providers and consumers of electronic media analogous to that between the oligarchy - tribal chief, witch-doctor etc. - and the mass of the people in indigenous cultures; that whereas traditional tribal societies are enthralled by magical artefacts and ceremonies, the tribes of the late 20th Century are spellbound by totems from lifestyle features and advertisements in tabloid newspapers, magazines, cinema, radio, television etc.: new packaging for old products and ideas sold by advertising shamans and political spin-doctors - the revenant Portuguese adventurers bearing glittering wares. And we are the natives who must weigh the values, for they also bring valuable stuff amid the dross (McLuhan would have been the first to admit this), and their globalising pidgin carries new scientific and religious concepts amidst the slogans and brand names.

The language of course is very often the predominant world auxiliary, namely English - or is it? Typical mediaspeak is not noted for its similarity to the language of Shakespeare, Emerson and Tennyson, and closely matches the voice of no writer from the pre-electronic age. Moreover, the new speech has accompanied a profound cultural shift from imagination to imagery: it is hardly surprising that sheltered modern children adjusted to the televisual realisation of fantasy should prefer Roald Dahl to the literary classics. A great part of the population generally is in thrall to television, when as much topical information can be gained from a decent daily newspaper in a fraction of the time. How many now read the great poets, philosophers and novelists, or the world's seminal religious works - such as the Bhagavad-gita, the Bible, the Qur'an or the Bahá'í Writings? McLuhan, in a letter to a fellow Catholic (20/2/70), put it thus: "I have spent a good many years in studying the cultural effects of print and in proclaiming the alphabet in its printed form as the sole basis of civilisation. The electro-technical forms do not foster civilisation but tribal culture."

From a linguistic viewpoint, at least, these questions are very relevant because an equilibrium between different grammatical styles is impossible to retain in the long run; every partial language - not excepting English - follows the trend of one cultural tendency or another. For instance, many traditional languages have preserved a "correct" literary usage, whereas the creoles cater for a mass market which requires no more than a minimal grammar. The standing of English as an international language has largely been due to its capacity to contain these two grammatical styles.

But this potential may have weakened as the pidginised style has gained the ascendant. It might be asked whether this represents a degeneration of the language, or why a meagre fare should be preferred when the linguistic heritage is so rich. The answer to such questions again derives from the pre-eminent international role of English. The advertising and propaganda industries which cohabit the mass-media and its offshoots, with their remit to maximise the market at all costs, have encouraged a certain style in imagery and language which, by aiming for the universally familiar, effectively crosses many cultural and linguistic barriers. Moreover, the pictures of war, poverty and environmental degradation, and expositions of ecology and macroeconomics, emanating from the same media, have encouraged the formation of a



number of international charities, causes and movements, much of whose discussion has perforce taken place through a simplified or pidginised version of English - both because English is the leading international language, and because proper simultaneous translation is extremely expensive.

In such ways, through the dynamics of the mass-market and of global accessibility, the focus of English use has gradually shifted from a literary to a pidginised form. The frontier of this kind of language is found above all where access to less-educated or second-language speakers is the priority, whether the products on offer be jejune ephemera or matters of great import. In some respects, the English so produced approaches the distinctive qualities required by the coming world auxiliary language. Will it now take the next step?

In all these ruminations it is essential to maintain a proper perspective. Although the common international tongue will be instrumental in promoting understanding and fellow feeling between all the nations presently separated by their languages, its influence will be severely limited without collective action to confront and resolve those spiritual exclusions, moral prejudices, legal inequities and practical difficulties, too numerous to mention, which tend to keep the peoples of the world apart, and hinder the free and voluntary association which is a precondition of dialogue.

Since the international auxiliary language will be taught to children in every school of the world, the difficulties of grammatical redundancy and irregularity will have to be addressed. This is because, as researchers have discovered (and experience shows), children prefer a certain level of grammar to a minimal grammar; and they tend to spontaneously regularise grammar where it is irregular. Thus creoles are essentially created by children who, learning pidgins as mother-tongues, gradually elaborate them by the addition of grammar and vocabulary.

The reason for this tendency is evident. Pidgins developed to facilitate transactions exclusively between adults. In a context where the ground rules of social interaction are mostly understood, and the purpose is mundane rather than transcendent, no more than a minimal grammar is necessary. But children are primarily concerned to orient themselves in an unfamiliar world, and to establish the precise meaning of a situation - as indicated by the syntax, tense, mood, voice and inflections of speech.

The corollary of this finding is that children are deterred less by complex grammar than by redundancy and irregularity. For example, the Turkish inflectional system is fairly intricate, but Turkish children normally master it well before the age of two because it is completely regular and straightforward. An oft-quoted illustration combines the noun "el" ("hand") with the inflections "-im" (first person possessive), "-ler" (plural) and "-de" (locative):

elim "my hand"  
 elde "in hand"  
 eller "hands"  
 elimde "in my hand"  
 ellerim "my hands"  
 ellerimde "in my hands"

Similarly, relative clauses (i.e. those beginning "who, which or that" in English) are so straightforward in SerboCroat that most Serbian and Croatian children have likewise mastered them by the age of two. Other languages also have grammatical features of exemplary regularity which children learn to use without difficulty. The international language committee will no doubt look at all such instances in order to assemble the best grammar from all sources.

An interesting fact about the above two examples is that their converse shows some of the worst grammatical practice. Both Turkish relative clauses and Serbo-Croat inflections are incoherent and excessively complicated. The children of these nations struggle to make sense of them, and do not normally use them competently until about the age of five. This conjunction between the regular and straightforward and the confusing and opaque is typical of national languages. For instance, in English we see a relatively simple grammar conjoined with a relatively difficult orthography, and in Finnish and Hungarian the reverse. There appears to be an inherent shibboleth function in national tongues, seemingly designed to identify foreigners and/or those who have not mastered the language properly.

The same psychological constraints will inevitably apply within the international auxiliary language, so any reforms will have to take cognizance of conflicting considerations: firstly, that the international pre-eminence of English is related to its current level of grammar, and secondly that English-speakers who use a rather different grammar should be represented or catered for as far as possible (according to the wisdom of Webster's dictum "Grammar should derive from language, rather than language from grammar").

The present controversy about black American English or "Ebonics" illustrates this tension. Defining Ebonics as a separate language solves nothing, but neither does the non accommodating status quo. Sensible grammatical reform would align itself with such dialects as far as mainstream opinion and historical continuity allowed. Moreover, grammatical irregularities which presently cause children problems might be rationalised by adopting the best practice elsewhere.

The English-based creoles provide some ideas in these simplifying and rationalising directions. The operation of the word-order principle in English has rendered superfluous all noun cases except the genitive, as well as adjectival agreement etc.. However, the creoles have pushed the principle harder in order to achieve further economies, including the abolition of the genitive. Some of the more promising creole constructions, with reference to their possible use in the revision of English, include the following (in order to illustrate the grammatical point they are artificially written in Standard English - in practice an orthographic rendering of creole speech should be spelt very differently [e.g. "the" would normally be "de" etc.]):

(1) The third person singular does not alter verb declension in the present tense: e.g. "he run, she sing". (It is difficult to find grounds for objecting to this one.)

(2) Possession may be denoted by juxtaposing nouns rather than using the genitive with the apostrophe: e.g. "this woman child, that man field". (The context normally distinguishes the genitive from the

adjective; the more rigorous use of hyphens and compound words would help to distinguish them on the page. Other languages dispense with the genitive, e.g. Welsh: "llyfr John, llyfr coch" "John's book, red book".)

(3) A plural is often not marked by an [s]: e.g. "two house, them rabbit". (Determining whether "sheep, deer, fish, cod, grouse, Portuguese, Swiss, Maori" etc. are single or plural is hardly a problem in English. Chinese usually does without plurals. Eliminating the plural would abolish irregular forms like man/men, child/children, mouse/mice etc.. Plurals can often be identified by numerals or pronouns; a plural definite article like the French "les" [the plural "the"], or the Chinese plural marker "xie" ["some"], might help.

(4) Verbs are negated by the word "no": e.g. "he no work today". (Old English used the same construction with the prefix "ne-" for "no", exactly as in Scottish English, Russian, and other languages. Also "ne-" might replace "un-"/"in-". English already uses "never" in a similar way.)

(5) Adjectives are used as adverbs: e.g. "he walk silent, she sing soft". (Word order allows this. Words are entities which may often be used interchangeably as noun, verb, adjective or even adverb: e.g. arm, foot, back, up, right, top, shine, love, dog, plant, air, etc., etc.)

(6) Auxiliary verbs like "be" or "do" are often omitted: e.g. "the sun hot, he old man, them hungry, why you bring this?". (There seems to be little problem with this one if the omitted auxiliary or copula is understood to be in the present tense. Russian also does without the copula in the present tense e.g. "he engineer".)

(7) Serial verbs are commonly used in creoles: e.g. "she go try find it, he start run escape". (This would be a most useful reform if it could be done without introducing ambiguity between the infinitive ("to" escape) and the noun. In English the "to" is sometimes omitted from the infinitive as being understood. The infinitive is essentially a self-directed imperative.)

As previously emphasised, no more than an offspring or copy of English would be reformed: a refraction which might then proceed to change the main body of the language - though perhaps in conservative directions. Moreover, it is likely that the pidginising influence of the global media would be transferred on to this grammatically-simplified and orthographically regular language. For the dynamics of the market economy, and the high capital cost of launching any new media product, whether an advertisement, film, TV show, pop record, computer game or other fashion item, are such that the multinationals are concerned above all to maximise global access. A pidginised international language might well be irresistible for this very reason. Thus English, and the other mother tongues, might be freed from the trivialising influence of these things.

It is probable, then, that the international auxiliary language, towards which LANGO is proposed as an initial stage, will have a grammar of the utmost simplicity so that it might permeate everywhere with the aid of the mass-media. But what will happen to the mother-tongues meantime? It is certain that they will continue, for a very long time, as custodians of speech and grammar. For instance, the English-speaking

peoples, with their tradition of individual purposefulness, have a grammar replete with tenses, moods and voices (though poor in inflected nouns and adjectives). Conversely the Finns, that poised and musical race, have a language which is very emotionally expressive in its wealth of noun cases denoting different states of being. (Finnish also possesses a useful personal pronoun which denotes either sex.) Briefly, the grammar and vocabulary of every tongue reflect the characteristics of its native speakers.

A complex grammar has as many advantages, for philosophical or literary purposes, as has a simple and straightforward grammar for universal access. An increased grammatical range would give every national tongue greater logical capacity, and better receptiveness to translation and transliteration. For example, a third-person reflexive pronoun for English, as in Esperanto and many other languages, would prevent the ambiguity in sentences like "Eric told Mark about his wife". However, it is unlikely that there will be any more direct transfer of grammar between developed national tongues than there has been in the past. Creoles and languages at early stages of development can do this, but every partial tongue reaches a point at which it resists change.

However, it is certain that the grammatical level of the international pidgin would be gradually raised, once it had an established status world-wide. This would have to be done with the greatest care: the timing of any change closely related to the general level of literacy, and nothing that had not been exhaustively tested in one language or another. Thus, in the distant future, having developed an unsurpassed grammatical, lexical and phonological capacity, there is no reason why the international auxiliary language should not absorb all other languages.

The advantage of a complex grammar for elucidating abstruse subjects on the intellectual level is essentially that of economy: not the simplicity of the pidgins, but the brief representation of a phrase or a clause in the same way that the right word might encapsulate a circumlocution. For example, the use of the gerund in English often obviates a pronoun and predicate, or noun and preposition. In view of the proliferation of knowledge currently taking place in the world, brevity and concision are vital.

However it can be argued that a still more advanced grammar is that of poetry, where understanding exists "between the lines" in the ratiocination of images and thoughts, as well as from words themselves and the tension between grammatical structures. Moreover, the alienation between simple and complex grammar is inherent to prose: at the level of poetry it disappears along with the innate distinction between words and their groupings. For this reason poetry will expand greatly in influence, reciprocally with the global tongue. This is yet another matter which, although of great import to the international language, is mostly dependent upon factors outside its sphere of influence.

Click here to return to [Lango Directory](#)

**MENU: [HOME](#) » [Reconstruction](#) » [Recovery](#) » [Renewal](#) » [Language Main Page](#)**

Click here to return to [Lango Directory](#)

## Chapter\_Fourteen: "LANGO\_Vocabulary"

The constructed languages have proved the futility of attempting to mint vocabulary on the grand scale from familiar word-roots, not only because of the failure of these languages as independent entities, but also because the ethnic tongues have rejected the new words. The demise of many English neologisms of perfectly rational provenance confirms the point. Euphonic considerations must prevail alongside the rational: the neologism must sound right as well as look right. Just because a word is constructed from an impeccable Latin or Greek root, or from the most common root extant in European languages, does not mean that the ear will accept it. Inspired word-coiners like Shakespeare always paid as much attention to euphony as to etymology, but even then their neologisms did not always stick.

But although a group of experts, however well-qualified for the task, may not necessarily succeed in creating a popularly-acceptable lexicon; it is incontrovertible that words with the right pedigree are more likely to prevail. Thus the English language like the great common tongues of history has addressed the vocabulary problem by incorporating those words which have stood the test of time in former and current languages. In this way inspired wordsmiths, whether great authors or academics, successfully introduced many thousands of words into English from Greek, Latin and the Romance languages. Neologists following this method helped English to emerge from the shadow of Latin and French during the 16th and 17th Centuries when the printing presses were busy churning out translations of the Ancients.

This might be confirmed by choosing one word at random from every page of a standard dictionary. The percentages of words from different origins might be: Romance languages 54%, Teutonic languages (mostly pre-1066 AD) 31%, Greek 11%. English has acquired these words whole, or by direct transliteration, or through careful modification when necessary; but never after the manner of the constructed languages with their instant vocabularies. The apparent failure of the artificial tongues as vital, rather than theoretical or philosophical, entities would seem to indicate that language, like any other organic process, can only assimilate the new in measured proportion.

Moreover, a defined lexicon may not give an adequate choice of synonyms. A single word might be sufficient to convey meaning, and quite adequate for many; but language is more than logic for those who wish it to be so. Any speaker or writer who seeks to create poetic speech may require stress, rhyme, alliteration, metre, cadence, resonance, contrast, variety or emphasis within a single word. This is why synonyms may be preferred - even though they all mean practically the same thing. In addition, English is full of near-synonyms from different languages e.g. "rear/raise, weak/frail/fragile", which not only give it subtlety, but lower the "vocabulary barrier" for many nationalities. No other tongue, least of all among the constructed languages, displays this degree of flexibility. It is difficult to imagine that any constructed

language could be designed with such a feature - which means that, when people from diverse linguistic backgrounds use English, they can employ the synonym nearest to the word in their first language. It might not be quite right; but they will be understood.

A degree of freedom in grammar and choice in vocabulary is as essential as standardisation in script elements and spelling. As we have seen, English has drawn heavily from both Germanic and Romance sources in its choice of vocabulary. Hence a greater proportion of its words are readily accessible to Europeans, North and South, than are those of more specifically national languages such as French and German. English also compares favourably with other tongues in the absorption of words from the widest international sources. Since the learning of vocabulary is the most demanding part of acquiring proficiency in any language, English begins with a great advantage in terms of the international acceptability of its vocabulary.

However, it is also true that some nations and peoples find many English words difficult due to unfamiliar phonology, consonant clusters and the like. At this point the pidgins and creoles might be as great an assistance to lexical reform as to grammatical revision. For instance, they have largely eliminated the consonant clusters that many language groups find difficult: e.g. "want, must" are "wan', mus'". Any vocabulary problem caused to an English-based international auxiliary language by these omissions would soon be rectified. It is not as though there is a shortage of alternative words in other languages!

Selecting words from different languages will also solve the question of homonyms. Traditional English orthography contains a vast number of homophones and homographs; and a consistent orthographic reform, based on the international standard pronunciation described in Chapter 19, would produce very many more. An idea of the current situation in English might be had by glancing at a standard dictionary. A few common English words, taken at random, are defined in the following approximate numbers of different ways, whether as substantives, verbs, or adjectives, on about the following number of pages of the Oxford English Dictionary:

Word	free	keep	line	make	mark	point	post	run	set	take	turn
Defs.	34	48	46	87	43	41	46	91	172	63	88
Pages	3	5	8	9	6	6	5	10	15	8	8

Not all of these separate definitions are distinct homonyms, but a large number of them are. Hence an orthographic reform would not only produce more definitions in the O.E.D., but more homonyms too. For example, "plain" has approximately 40 definitions on 4 pages of the O.E.D., and "plane" about 16 on 2 pages. Thus a reformed spelling might produce "plän" with 56 definitions. The sensible policy of replacing most of these homonyms with words from other languages would not only greatly increase the scope and precision of the language, but would also make it incomparably more acceptable as an international auxiliary language.

An additional factor, relating to the international currency of word-roots, might make it desirable to substitute some English words by those from other languages - even where there are no homonyms. For

example, the English words "soldier, editor" are not typical; the French equivalents "soldat, rédacteur" have a wider international currency. Zamenhof recognised the essential importance of this principle. Here he used the words "soldato, redaktisto", and likewise tended to base his vocabulary upon predominant word-roots, (though he sometimes flouted the principle as in "lernejo" for "school").

The question of vocabulary is one of the most challenging that the constructors of the international auxiliary language will have to face. They will have to be concerned, not only to reflect popular usage, but also to refrain from bias towards any part of the world. However, although it will be necessary to make compromises, there are mitigating factors. Firstly, it will often be possible to list several words from different languages as near-synonyms, since they are not exact equivalents. And secondly, there is the advantage that different cultures and their languages have tended to specialise in diverse areas of experience. For this reason, a lot of metaphysical words might be introduced from Arabic and Farsi, philosophical words from Indian languages, political ones from Chinese and Russian, and so on. The trend of these things is already extant in English.

Moreover, mathematical words might be introduced from East Asian languages. Irene Miura and Yukari Okamoto have established that number values in Chinese, Japanese and Korean are better understood, because the counting system relates directly to the meaning of numbers: hence, eleven in Japanese is "ten-one", twenty is "two-ten", thirty-one is "three-ten-one". The language is also better at explaining fractions: e.g. in Japanese one third is "san bun no iti" meaning "of three parts one". It is well known that East Asian students consistently surpass their British and American counterparts at maths. The difference is so great that it cannot solely be the result of superior discipline, motivation or teaching; it must also reflect the nature of their languages. The vocabulary of the international language will no doubt be influenced by such findings.

Click here to return to [Lango Directory](#)

**MENU: [HOME](#) » [Reconstruction](#) » [Recovery](#) » [Renewal](#) » [Language Main Page](#)**

---

---

Click here to return to [Lango Directory](#)

## Chapter\_Fifteen: "LANGO\_Phonology"

A revised version of English would capitalise on both the global dominance of the left to right horizontal Roman script, and also on the present position of English as the leading international language: for whereas English has fewer speakers than Putonghua, and perhaps two or three other tongues, both its primary and secondary users are more widely distributed around the world - and with fewer political and cultural ties than other more strictly "national" tongues. Moreover, English has a relatively simple and flexible grammar, an extremely mixed vocabulary, and allows for a wide range of accent and intonation to shade meaning. It is also, of course, the leading language of commerce and diplomacy, and the lingua franca of information technology and international telecommunications.

But, in the case of the latter, we have seen how the poor orthography and extensive phonology of English can combine disadvantageously. Every nationality tends to experience phoneme difficulties - perhaps with consonants like /dh, th, z/, or /dzh, tsh, zh/, or /p, f/, or /r, l/, or with certain vowels, depending upon whether they occur in their own language: the Japanese substitute /r/ for /l/, whereas the Irish have ten variants of these liquids in their tongue, but struggle to pronounce the /dh, th, z/ sounds of English.

In the same way, English-speakers are likely to have difficulty with many of the sounds in Russian. And nonstandard dialect speakers in Great Britain and the U.S.A. may employ only a proportion of the vowel sounds in Standard English, which itself uses just two of them - the schwa as in "the" and the short [i] as in "it" - nearly half the time but most of the others infrequently or rarely: e.g. the four vowel sounds as in "bird, care, deer, boy", added together, only about 3% of the time. Hence a reasonable objection to an international auxiliary language based on English might be that the standard phonology is dauntingly extensive.

One response might be that, since the international auxiliary language would presumably be introduced into schools around the world more or less simultaneously, it would be entirely feasible to start with an orthographically reformed English - together with its present vocabulary and phonological range, and that this approach is possible because children have a natural capacity for language learning; whereas adults generally find it very difficult if not impossible to master a new range of speech sounds.

Moreover, it might be asserted that, since the international auxiliary would be the only language children anywhere in the world would need to learn in addition to their mother-tongue, enough time might be devoted to it to master difficulties like unfamiliar phonemes, which should not present too much of a problem if introduced to children at a young enough age. An extended range of phonemes might thus be



inducted into every population by means of child education. Another argument which might well be advanced is that, if the auxiliary is to be truly international with words from different languages, there is ultimately no alternative to a comprehensive range of phonemes.

However, present social conditions would present a fatal drawback to this idea. For although most children may well develop an inherent capacity to differentiate and articulate phonemes, so that by a certain age they have the theoretical ability to speak any language with an extensive range of difficult speech sounds, the capability is gradually lost through childhood as the process of ethnic acculturation reinforces some phonemes but entirely neglects others. New speech sounds are not normally heard, i.e. distinguished from familiar phonemes, except by those who have learned to say them; but when the speech sounds corresponding to the "missing" phonemes are seldom if ever heard, the child's confidence and ability to say them tends to atrophy, as eventually does the capacity to even hear them.

This shows that using education alone to transform the phonology of a society would be as useless as similarly attempting to promote morality or religious revival. The willingness of children to learn, and to actually use, unfamiliar phonemes in everyday speech must also depend upon the confirmation of a global society that still does not exist for the great majority. It is for this reason that confident expansion of the global auxiliary language requires the reinforcement of a world civilisation: final consummation of the same process whereby an increasing majority have chosen to live and express themselves in "national" rather than "minority ethnic" cultures.

This global civilisation, prophesied by the great religions of the world and projected by communists and materialists, should not be regarded as chimerical. However it is clearly not here yet, unless in an embryonic stage, so the communal endorsement necessary for the introduction of an extended range of phonemes is still more or less absent.

Consequently an international auxiliary language based on reformed English might have to change its core vocabulary by replacing some common words, which have relatively difficult phonemes, with easier words from other languages. Many tongues have fewer phonemes than English. Spanish has only five vowels; some languages have only three (one is said to have only two). Likewise there are tongues with nine consonants or less. Some have /l, m, n, r/ and then /b, d, v, g, z/ or /p, t, f, k, s/; depending on the cultural preference for voiced or voiceless speech sounds.

Modern research in the University of California Phonological Segment Database shows that the most commonly used consonant segments are:

p, b	t, d	ty	k, g	'
f	s	sh		(glottal stop)
m	n	ny	ng	
w	l, r	y		h

As well as having fewer consonants, many languages also use them more sparingly than English, usually one per syllable. Consonant clusters, especially those like "twelfths, strengths", are another feature of English which is not typical of other languages; though there are notable exceptions, including among minority ethnic tongues (mostly in the Caucasus), some of which have strong and complex consonant sounds with few vowels. However, on balance, a number of common and essential words in a reformed version of English for international usage, such as prepositions and conjunctions, might have to be replaced by alternative words from other languages - so as to avoid those phonemes and consonant clusters that are particularly difficult for the majority of nationalities. By making its phonology as palatable and digestible as possible for the greatest number of language groups the international auxiliary language might be enabled to get off to a flying start.

Present-day English forms would continue for those who wished to carry on using them. Moreover, as the phonological capacity of the culture associated with the international auxiliary increased, it would be possible for it to gradually "take back" from English and other mother tongues the full range of former phonemes and other desirable linguistic features.

Click here to return to [Lango Directory](#)

**MENU: [HOME](#) » [Reconstruction](#) » [Recovery](#) » [Renewal](#) » [Language Main Page](#)**

---

---

Click here to return to [Lango Directory](#)

## Chapter\_Sixteen: "LANGO\_Orthography"

Orthographic reform is especially difficult because it deals with letters, the building blocks of words, as well as with words themselves. Neologisms and grammatical innovations are continually introduced, sometimes successfully, by writers and editors; but a change to the orthography of a language is much too important and fundamental to take place informally. Moreover, an organised orthographic reform of the English language, for the direct benefit of the whole English-speaking world, is unlikely to happen, for reasons which are explored in the next chapter. The most that could now be expected, realistically, is the revision of an offspring of English towards a rational foundation for the coming international auxiliary language.

Although this common tongue might start from a point close to contemporary English, at least in sound, it would necessarily lose all but traces of this origin as it evolved into a medium with the capacity to express or reflect a global culture. Its linguistic and euphonic centre of gravity would likewise move from the English-speaking world to the whole world, even as it has already shifted from the British Isles. The task of entirely constructing a new language would be beyond any individual or group - however well qualified. It would have to be carried out, via a comprehensive process of consultation, by an internationally representative panel of expert linguists. A democratically determined global standard accent, as explained in Chapter 19, would act both as reinforcement and failsafe mechanism.

Such a reform would bring into focus linguistic problems which T.O. deals with in an essentially negative way; the conventionalised spelling of T.O. avoids giving precedence to any of the accents in the English-speaking world and distinguishes homophones like "peak, peek, pique" on the page by the same means. As an alternative to T.O. we propose an international standard pronunciation and the introduction of many words from other languages. But a third negative argument for T.O. is more difficult to answer. This claims that fundamental spelling reform is practically impossible in English due to the limitations of an alphabet with only 26 letters - which must be retained for practical reasons.

It is a relevant point because the letters of the English alphabet must represent over 40 speech sounds or phonemes. In particular, the 5 vowels and 4 semi-vowels signify 18 or more sounds between them. These are, at a minimum, the 12 monophthongs in "sat bet bit fog the car bee low soon saw fir put", and the 6 diphthongs in "care deer lie day boy how". (It might be claimed that English needs at least 20 vowels: that the [u]s in "sun" and "put" are both categorically different from the schwa in "the": that the vowel in "poor" is a diphthong distinct from the monophthong in "paw", and that the vowel in "low, go" is a diphthong.) The 21 consonants must likewise signify a greater number of sounds; 24 consonant phonemes are normally listed as "English", approximately /b, tsh "chin, church", d, dh "the, that", f, g "go, get", dzh

"gem, jar", h, k, l, m, n, ng "young, singer", p, r, s, sh "she", t, th "theatre, thin", v, w, y, z, zh "measure, beige"/. Others like /ts "mezzo, pizza, pretzel", kh "loch, Bach" and ny "Enya, manana, union, canyon"/ are endemic through transliteration.

The result of this imbalance is that three quarters of the vowel sounds must be represented by digraphs like "ie, ea, ou" etc., rather than by single letters, and the consonants are likewise too few for a useful one-to-one correspondence. However, changing the English alphabet (e.g. to introduce extra diacritics and/or characters from the Russian, Greek or Hebrew alphabets) is not such a straightforward step as might be supposed: billions of pounds worth of hardware - not just manual typewriters but also a great deal of computerised equipment - would become redundant overnight; moreover, millions of touch-typists are psychologically imprinted on the QWERTY layout and would find it hard to readjust. More advanced I.T. machinery can easily switch to another alphabet, or to a layout such as Dvorak: which permits over a third less finger travel when typing English. However, the difficulty of mental adjustment probably explains why the ergonomic Dvorak keyboard has not prevailed even after 60 years. New letters and diacritics would no doubt be resisted for the same reason.

Every would-be reformer agrees that the present alphabet contains duplicated and redundant letters: [c] represents different phonemes, as in "cut cell once ocean luscious scene", only one of which, /ts/, as in some pronunciations of "once, dance, wince", is not duplicated by another letter; [g] and [j] are also duplicated, as in "judge", [q] and [x] are more or less redundant, and other letters are often used inappropriately, e.g. [f] for [v], and [s] for [z]. Consonant digraphs in English are even more irregular than individual letters. /Sh/, for instance, is spelt no less than 15 different ways, including [ce] "ocean", [ci] "facial", [ti] "nation", [si] "mansion", [s] "sure" and [sci] "conscience". Moreover, the following table of the (approximate) relative frequency of letters in the Cambridge Encyclopaedia, computer-counted, and based on q = 1, shows that several consonants are used so rarely in English as to be practically redundant:

e = 89	a = 67	t = 61	i = 61	n = 58	o = 54	r = 51	s = 50		
l = 33	h = 33	d = 30	c = 29	m = 21	u = 21	f = 18	p = 17		
g = 15	b = 12	y = 12	w = 11	v = 8	k = 4	x = 2	j = 1	z = 1	q = 1

However, there would be enormous difficulties in recasting the alphabet on a rational basis for an orthographic reform of English even within the English-speaking world, much more so towards a basis for the international language. The next chapters touch on some of the issues connected with an attempt to promote the latter.

The principle of orthographic regularity is important, but should not be taken to excess. In any case it will have to be approached gradually and carefully. The letters of the English alphabet represent phonemes, or narrow ranges of speech sounds, which are often different from those which are most common in other parts of the world. Moreover, users of ideogrammatic and syllabic scripts have coped for aeons without an alphabetic orthography: there is no reason why they should adopt one unless it were clearly beneficial.

Click here to return to [Lango Directory](#)

**MENU: [HOME](#) » [Reconstruction](#) » [Recovery](#) » [Renewal](#) » [Language Main Page](#)**

---

---

## Chapter\_Seventeen:

# "A\_History\_of\_English\_Spelling\_Revision"

Idiosyncratic English spellings arose in the 12th Century from the difficulty of trying to reconcile the very different orthographic conventions of England and France. The introduction of printing from the Netherlands in the 15th Century promoted new orthographic practices; but spelling became even more according to the fancy of authors, influenced by the phenomenon of "line justification", which encouraged compositors to vary the length of words, or adopt alternative spellings, so as to fill out the text to the right-hand margin. Another theory is that printers often preferred to use longer words, e.g. "delight" for "delite", because they were paid for linage. During the "English Civil War" from 1642-9 the propaganda machines on both sides turned out broadsheets at an enormous rate. There was no time for line justification; but this mass-production effectively standardised many irrational spellings which had been perpetuated by its requirements, or for other arbitrary reasons, just at a time when English pronunciation underwent considerable changes, especially in its vowels (the "Great Vowel Shift"). Dictionaries from Dr Johnson's onwards have perpetuated or even compounded these errors.

Most other major languages have undergone official revisions to remedy this problem of irrational spellings becoming immortalised in print. Thus, spellings like "ch" in "chasm", "ph" in "phantom" and "ps" as in "psalm" are notorious in English, but were replaced by "c", "f" and "s" in Spanish and Italian centuries ago. However, from the international point of view, the absence of a thoroughgoing reform during the history of the English language should not necessarily be seen as a bad thing because, although such rationalisations tend to iron out extreme discrepancies, the employment of national norms can militate against international acceptability.

Spanish and Italian are also among that group of languages, headed by Finnish and including Hungarian and Malay, which are relatively straightforward to spell from speech, or vice versa. This is because a simple phonology, especially in the case of vowel sounds, allows phonemic spelling i.e. close correspondence between phonemes and letters of the alphabet. English, on the other hand, has the problem of attempting to cram over 40 phonemes into 26 letters - a few of which, like [q], [x] and [j], are greatly underused. This undercapacity has partly arisen because, unlike most other tongues using Roman script, English does not employ diacritics to increase phonemic representation. English has also suffered from the tendency of neologists to incorporate etymology into words, influenced by a French Academy which has vacillated between etymology - laying claim to the glories of Rome - and logic. For example, a [b] was restored in "debt" and "doubt" to show the derivation from the Latin "debitum" and "dubitare".

In the absence of effective official action to remove such redundant features, there have been numerous private attempts since the 16th Century to set in motion a process of English reform. A representative early figure was James Elphinston (1721-1809), who drew attention to the link between the international dominance of French and reforms previously instituted by the French Academy. To the scorn of critics,

and amused tolerance of friends like Dr Johnson, he sought to advance English by the same means: publishing a number of books in his phonetic spelling system including eight volumes of correspondence "between Geniuses ov boath Sexes and James Elphinston".

Noah Webster (1758-1843), the patriotic publisher of the "American Dictionary", is widely regarded as the most effective of the early reformers; but most of the spellings associated with him were current in Britain at the time. However, because of Webster's success in establishing them as "American", many logical spellings ceased to be extant in Britain. In this way, Webster's dictionary established the original Latin "-or" ending in words like "colour, labour, authour and mirroure"; the reversal of the last two letters in words like "centre" and "metre" (as in "enter"); the elimination of the final [k] from words like "musick and logick"; and the substitution of [k] in "risque" and all but one kind of "cheque". Dr Johnson expressed his "horror" at such barbarities as "author and music".

Organisations for the improvement of English spelling have existed for at least four hundred years. In the 16th Century the Royal Society investigated the need for orthographic reform, and eventually formed a committee which included the poet John Dryden. In 1869 the Philological Society endorsed the cause; and the British Spelling Reform Association, which included famous writers like Tennyson and Darwin as well as philologists, was founded in 1879. The Simplified Spelling Society, which had links with an American counterpart, was inaugurated in 1908. In its earlier days the S.S.S. attempted to unite behind a single scheme of reform, but in recent years it has turned more to providing an educative forum for various viewpoints. These range from corrections of only the most extreme inconsistencies in English orthography to radical reforms which attempt to phonemically rationalise the alphabet.

In 1984 the S.S.S. published a moderate list of suggested reform proposals which had some qualified support within the society. (1) short [e] as in: "eny, meny, frend, hed, etc." (2) replace [ph] with [f] as in: "foto, telefone" (3) delete [gh] as in: "caut, dauter, bou, drou, plou" (4) replace [ugh] with [f] as in: "laff, draft, cof, troff" (5) drop redundant final [e] as in: "hav, giv, relativ, opposit".

However, as anyone concerned with the problem may discover for themselves, at least four fundamental difficulties arise with any reform of English. The first is that almost any disturbance of traditional orthography immediately throws other discrepancies into relief. For example, however reasonable they might appear at first glance, four of the five proposed revisions listed above raise as many questions as they answer:

(1) "eny, meny" or "enny, menny" and, if "eny", why not "peny"?

(2) "saffire, saffire or safire"; "fotografy or fotograffy"?

(3) Why not "cawt, dawter, bow, drowt, plow" or something else?

(4) Why not "laff, cawf, troff"?

Likewise, substituting other short vowels where appropriate may seem like a positive step; but if "plait, women" becomes "plat, wimmin", then "plaited" must become "platted", and we are immediately up against not only homographs but also the modernising tendency to use single rather than double consonants as in "enrol, skilful, fulfil" (British) and "traveled, marvelous, woolen, worshiper, carbureted" (U.S.). Similarly, the question arises whether short [u] should signify the vowel as in "put, foot", or that as in "putt, flood, bud, run". (Standard English differentiates these from the schwa as in "random, element, infant": a tripartite distinction which is not recognised by Welsh and other languages.) Numerous other examples might be given; all demonstrating that English has developed into a precarious edifice which it would now be practically impossible to repair without destabilising the entire structure.

A second difficulty concerns homonyms. Most reformers would see the eventual deletion of extra or silent letters to be desirable; but although the initial letter might simply be dropped from "knife", "knock" or "gnat", omitting it from "know", "knit" or "write" would produce homographs: and to delete the one but not the other would be widely regarded as inconsistent. Any thorough programme of orthographic reform would turn numerous homophones e.g. "ate, eight" or "rain, reign, rein" into homographs. It would be difficult to solve this problem of homonyms without introducing a large number of substitute words from other languages: in which case it would cease to be a recognisably "English" reform.

A third major problem with English reform has simply been a shortage of symbols to represent all the phonemes. For eminently sensible reasons the S.S.S. has mostly been against extending the alphabet or using diacritics; but the result has been a lot of words that are longer or less elegant than the originals. Thus, in "New Spelling 90", "almost, paper, motion, accumulation" become "aulmoest, paeper, moeshen, akuemuelaeshen". Moreover, none of the S.S.S. schemes are entirely orthographic: "New Spelling" (1948) often refrained from distinguishing the schwa, and "New Spelling 90" usually employs [e]: both use several words like "the, to, so, be, he" and the affixes "re-, -ful" conventionally, i.e. without regular orthographic spellings.

Attempts have been made to reduce the length of these regularised spellings by employing under-used letters, e.g. [x] for /sh/, /th/ or /kh/ as in other languages; but there are not really enough spare letters to go round. Another response has been "Cut Spelling": which is presented by the S.S.S. as an alternative to "New Spelling 90". Cut Spelling is more regularised than T.O., but is still conventional rather than orthographically consistent, as the following sentence shows: "As yet, th question of english spelng reform, tho ocasionly atractng public atention, has not convinced th relevnt authoritis that it requires serius, informd considration." Cut Spelling represents a 10% print saving, but its conventionalised forms necessarily appeal more to the present than to the future users who are, by definition, the greater constituency of any major language. For instance, one problem with Cut Spelling is that children learning to read must place the missing schwas correctly.

However, the fundamental problem for spelling reformers has never been wholly dependent upon QWERTY keyboard limitations which might be entirely removed by extensive computerisation anyway; public attitude has always been equally fundamental. There is probably just as much chance of the present arbiters of the English language adopting Kingsley Read's radical new alphabet (which won G B Shaw's competition in 1958) as any modest reforms. Even piecemeal alterations are always going to be



impossible so long as there is an unwritten contract by the already-literate to maintain traditional orthography at the expense of future generations and foreign learners. In such a climate the most unambiguously useful revisions, e.g. of = ov, off = of, are pounced on as "spelling mistakes", and the most arcane usages, which have long ceased to relate to any known orthography, are perversely valued since they reinforce the cultural shibboleth. It would be difficult to change this attitude except in a new internationalist context.

A fourth difficulty is that the principles of orthographic and grammatical regularity are often in conflict. For example, "talked, edited, banned, landed" are grammatically regular on the page, but in speech they tend to be "torkt, editid, band, landed"; likewise "banks, cats, dogs, foxes" usually become "banks, kats, dogz, foksiz". Inevitably, the sound of an inflection is changed by the nature of the adjacent phoneme: a tendency which even the recorder of the international standard accent might not be able to resist, without making the word sound artificial and unreal.

One response to this problem would be to reduce grammatical inflections to a minimum. As we have seen, the creoles have shown the way here, by greater use of the word-order principle; but beyond a certain point there is an inevitable loss of semantic capacity. An artificial language like Glosa may be potentially 100% orthographically regular, which is an advantage, but one which must be traded against the value of inflections. Another possible solution would be to change either the vocabulary or the nature of the inflections. For example, inflections like short [a] or [i], or long [o], tend to sound the same, whichever word they are attached to. No doubt they are found in many languages for this reason.

A fifth reason why English reform has not proceeded since Webster is the variety of pronunciations worldwide. There are numerous words, like "vase, clerk, potato, tomato, harass, genuine, fertile, schedule, simultaneous", which are normally pronounced differently across the Atlantic. Millions of English speakers do not differentiate between /w/ and /wh/ in words like "which, when, what"; but many others use the aspirated pronunciation /wh/. Likewise, the English-speaking world divides between those who pronounce the /r/ in words like "word, bird" (generally the U.S.A., Canada, Ireland and the Philippines), and those who do not (usually the rest of the English-speaking world). For every word the question might be asked: upon which variety of pronunciation should an orthographic spelling be based?

Merely substituting words from other languages would not solve this problem because accent differences affect vowel sounds, and to a lesser degree consonant sounds, in so many words that "culturally impervious" alternatives would not readily be found. This is the very situation which the notional pronunciation and standard accent described in Chapter 19 are designed to address. The creation of a single international standard accent, unified but not uniform, is absolutely vital because English orthographic reform depends upon the close definition of vowel sounds. This would allow the reallocation of symbols or redefinition of the semivowels (l, r, w, y), the substitution of single for double consonants, and the removal of many superfluous letters.

It becomes apparent that a proper reform of English could not take place without a comprehensive overhaul of the alphabet, which would in turn necessitate an international standard pronunciation, as an

orthographic benchmark, and also the incorporation of numerous words from other languages to replace all the consequent homonyms. The language undergoing such a process would soon pass a point at which it was no longer "English" according to any objective standard, so it might as well change its name to one signifying "international auxiliary language".

Endeavours to reform English on less than a global scale failed earlier this century when a "national" outlook was still the norm, and would be even less likely to succeed now. In 1949, and again in 1953, an attempt to get a scheme for English reform through the House of Commons was defeated: extraordinary luck having twice permitted a Member of Parliament to present a Private Member's Bill on the subject. The second bill actually passed its second reading; but further progress was halted by the implacable opposition of the Ministry of Education.

This was a historic missed opportunity because, at the time, British Received Pronunciation was still more or less the accepted standard accent throughout the English-speaking world. It was the front-of-house accent favoured by large corporations in America, diplomatic circles in various countries, and educational institutions everywhere. Such a bill would not even pass its first reading today. The notion of reforming British English apart from the other "national" varieties of the language would now be totally unacceptable.

An enormous amount of money has been thrown at the cause of English reform, but with very little result. Andrew Carnegie donated nearly \$300,000, and there have been other substantial legacies. Another sign of enthusiasm early this century was the petition to set up a Royal Commission, which attracted around 15,000 signatures, including those of many prominent academics. Why has it all come to nothing apart from a few minor revisions in America?

Firstly, English reform is unlikely as long as the language still largely centres upon a country whose social order is greatly influenced by class, as well as wealth, religion etc.. Thus the divergence between spelling and pronunciation functions as an educational and cultural shibboleth, to the despair of students from societies where such a device is irrelevant, and the difficulty of children learning to read. This observation is equally valid if the upper-middle class accent is deprecated and proletarian ones are fashionable.

Secondly, the social forces which have been transforming the English-speaking world since the 1960s, shaking many ancient institutions, customs, mores and beliefs to the foundations, dispossessing much of the old aristocracy and middle-class, and raising up previously disadvantaged sections of society along with new media interests and extensions to state sovereignty, have not operated primarily through the traditional rational arguments of literary culture. Rather have they fashioned their emotional appeals into images, focused via the new electronic media directly into the heart, using the spoken form of language about which rational orthography has very little to say.

Thirdly, the majority of people are simply not interested in spelling reform, because there is nothing in it for them. Since the advent of mass electronic entertainment most people seldom read anything much

other than magazines and tabloid newspapers anyway. They had difficulty learning to read at school; but it never did them any harm - so their children might as well experience the same! In fact, within the English-speaking world, the idea of language reform is inconvenient or irrelevant to nearly everyone except primary schoolteachers and the organised English Language Teaching (E L T) industry, with its T E F L (Teaching of English as a Foreign Language) and T E S O L (Teaching English to Speakers of Other Languages) qualifications.

However, the same people who are totally unmoved by the idea of the reform of English for use within the English-speaking world, may be enthused by the prospect of an international auxiliary language - because it stands to benefit them personally. Their children would only have to learn one "foreign" language at school: and it is one they would be likely to actually use afterwards! All free peoples would have access to a world-wide literature and media. When "abroad", a concept that would cease to have much meaning, since the world would become as one country through the common language, everyone would be able to talk to the locals, read the press, and listen to the news.

And last, but not least, we would all spend less in taxes through an international language. In a world which is becoming more and more united every day, whether by desire or necessity, the consequently increasing number and scale of international conferences, simultaneously translated into several languages, is not taking place without exorbitantly rising costs. The European Parliament and other agencies now spend most of their budgets on translation. For example, in 1994 (even before Austria, Sweden and Finland joined), the European Union spent £1,200,000,000 on 72 translations.

Click here to return to [Lango Directory](#)

**MENU: [HOME](#) » [Reconstruction](#) » [Recovery](#) » [Renewal](#) » [Language Main Page](#)**

---

---

Click here to return to [Lango Directory](#)

## Chapter\_Eighteen:

# "A\_Suggestion\_Towards\_Orthographic\_Reform"

Spelling reformers, including the S.S.S., have hitherto been constrained by the premise that the current English alphabet should be retained. It may be that computerisation will advance at such a rate, throughout the English-speaking world, that such a limitation becomes irrelevant: but that stage is still a long way off. The manual typewriter is far from extinct; and demand for cheap word-processors and other kinds of low-level I.T. equipment with no choice of typefaces etc. may well continue into the distant future. This point has been repeatedly emphasised because it is the very crux of English spelling reform. Its relaxation to the extent of using even one diacritic, like the circumflex (as on ê), would remove the phonemic barrier to a rational orthography at a stroke.

For example, although the Esperanto alphabet has only 22 letters, lacking the symbols [q, w, x & y] (the English /w/ and /y/ are represented by other letters), the optional accentuation of [c, g, h, j, s & u] effectively increases its alphabet to 28 letters. Using diacritics likewise in the English alphabet would certainly solve all the problems of representing its range of phonemes, though it would make a great deal of QWERTY hardware redundant in the process.

We have examined the consequences of this limitation in some detail, showing that phonetic spellings using the existing alphabet are prolix, but that there are not enough underused letters such as [q] and [x] to represent even consonant digraphs economically - much less vowels. The fundamentals of the problem are twofold: firstly an alphabet which could exist within the existing QWERTY machinery, and secondly an alphabet which could orthographically represent at least 27 consonant phonemes and 18 vowel phonemes.

In order to accommodate these constraints, we suggest that the capacity of the alphabet might be doubled by severing the phonemic identity between lower case letters and their upper case equivalents. Operation of the shift-key would thus allow no less than 52 phonemes to be independently symbolised. But then initial capitals on names and sentences would have to be denoted differently: we suggest the use of an initial stop instead, e.g. "David Lovel in yon abbey." = "..david .lovel in yon abbey."

One variation on this idea would use the upper-case letters exclusively to represent vowels - an arrangement of possible long-term potential for a type of usage which might be best understood by considering Hebrew, the ancient language of Israel, revised for modern use. As an entirely consonantal script, Hebrew had always relied on memory to provide sound and context to distinguish homographs, but the Nikud system essentially uses two scripts: one with diacritics - which are used to signify vowels; and one without - for those who are so familiar with the appearance of words that the diacritics may be

omitted. A somewhat similar system is used to a lesser extent in other Middle-Eastern languages.

The first script is printed in school primers, textbooks for language students, and where an exact orthographic rendition is required - as in certain religious passages. This script is normally handwritten, since it is predominately used by children and students. The second script, which consists of consonants only, is printed in books and newspapers - where the mass of the population, which has mastered the first script to the extent of being able to recognise words without diacritics, can read it with little difficulty.

The objection will soon be raised that such a dual system is wholly unsuitable for English words, which are often short and full of vowels, including diphthongs and triphthongs. (There is an approximate 2:1 ratio between consonant and vowel sounds in English.) The objection is valid. If used in present-day English, or practically any of the world's languages for that matter, there would be an immoderate number of consonantal homographs in the second script. For example: "rat, writ, rot, rut, rate, rete, rote, root, rite, rout and wrought" would all become "rt"! Moreover, words like "a, I, eye, owe, ewe" would disappear entirely.

However, this second abbreviated script might be introduced decades or centuries hence, when a very different vocabulary from a wide range of international sources allowed it to work. (The phonemes would perhaps need to be redefined at the same time as they moved from an "English" towards a more international currency.) When this happened every child would learn the first script: meanwhile consciously learning to recognise words by their appearance - as is done in the case of East Asian ideograms - to the extent of being able to miss off the vowel representations (i.e. the capitals) at some stage. That would leave the second script - which could be none other than the present alphabet as found on the QWERTY keyboard. This follows the normal pattern of development wherein children and students use handwriting, and typing is a skill which may be acquired later.

However, such considerations are for the future; the present concern would be to choose symbols to facilitate a rational spelling. We could start with the consonants, which are more straightforward: seventeen of them might as well be the same as in English. Some rationale might be given for the ten alterations: [c] = /ts/ in German and many other languages, also some pronunciations of words like "once, mince, city" give this sound; [c] = /tsh/ would also make sense, given imports like "cello, ciao", but morphically the stroke on [e] might signify the /ts/ modification; [g] = /dzh/ in many English words already, e.g. "gel, gender, gesture, giant, gist"; [i] = /ng/ might be appropriate in view of the very common suffix "-ing"; [j] = /zh/ as in French, this phoneme is heard increasingly in English through imports, e.g. "beige, bijou, azure, Zhivago, Siobhan"; [o] = /th/ as in Greek "theta"; [q] = [g] (plosive or "hard"), unprecedented but fits morphologically, [q] is easily substituted by [kw] or [k] ("queen, queue"); [x] = /sh/ as in Portuguese, Basque, Maltese and Catalan, [x] is also readily replaced, by [gz], [ks] or [gzh/ksh] ("examine, exit, luxury").

Moreover, the apostrophe might be used to represent a 27th consonant: the glottal stop or alif, which is found in Hebrew, other Middle-Eastern languages, Amerindian tongues, and elsewhere. As the world contracts, the glottal stop is being increasingly required for accurate transliteration into English. De facto, it is the 27th letter of the English alphabet already - used for transcribing names, and also dialect or argot

expressions, e.g. "bu'er" or "go'a lo'a bo'le". In addition, the apostrophe is now used to denote missing letters, e.g. "fo'c'sle, haven't, Scarboro'", and also the genitive case, e.g. "Susan's". Orthographic reform would make the former unnecessary - since words would be spelt as they sounded - and the genitive could be abolished if the simple creole usage became current. Alternatively, a convention could be established that all plurals ended in [z], and all genitives in [s], e.g. "Londons taksiz, artists artistz" - which is more or less the standard orthographic spelling anyway.

These consonants may be tabulated thus:

a = /dh/	j = /zh/	s
b	k	t
c = /ts/	l	u = /ny/
d	m	v
e = /tsh/	n	w
f	o = /th/	x = /sh/
g = /dzh/	p	y
h	q = /g/	z
i = /ng/	r	'

The number and specification of the vowels varies between languages, and also between dialects within languages, much more than in the case of consonants. With that proviso, Table 1 lists 18 vowels previously shown to have a wide currency in English, and also the irregularity of traditional orthography when it comes to representing them. According to this system, vowel digraphs ending in [e] and [u] are considered to be monophthongs, and those ending in [a], [i] and [o] are diphthongs.

Table 2 matches 18 capital letters to these vowels: an allocation which is even more arbitrary than in the case of consonants. Six capitals [C, O, S, V, W & Z] are not used because the upper-case and lower-case symbols are normally similar. This could cause confusion when using computerised equipment with the ability to reduce the font size when touching the shift-key. [Q] and [P], the top-corner letters on the keyboard, might be added if 20 vowels were employed. The vowels and their symbols are also tabulated below:

a	A	e	E	i	I
o	D	u	U	ea	R
ia	H	ae	M	ie	N
oe	G	ue	X	ai	Y
ei	K	oi	T	ao	B
au	L	eu	F	ou	J

The Lord's Prayer, transcribed from a non-rhotic speech into this orthography, demonstrates both regularity and print saving. Improvements to this spelling system might include the conventionalising of some common words and inflections.

"Our Father, which art in heaven, hallowed be Thy Name. Thy Kingdom come, Thy Will be done, in earth as it is in heaven. Give us this day our daily bread, and forgive us our trespasses, as we forgive them that trespass against us. And lead us not into temptation, but deliver us from evil. Amen.

".BU .fMaU, wle Mt In hEvUn, hAIGd bN .aY .nKm. .aY .klidUm kUm, .aY .wll bl dUn, In Fo Az It lz In hEvUn. .qlv Us als dK BU dKll brEd, And fLqlv Us BU trEspAslz, Az wN fLqlv aEm aAt trEspMs UqKnst Us. .And INd Us nDt IntX tEmptKxUn, bUt dNllvU Us frDm Nvll. .MmEn."

Table\_1

(m = monophthong, d = diphthong)

bid  
writ  
gin  
dear  
seer  
weir  
bee  
key  
pizza

a	bad	e	bed	i	o	pod	u	bud
(m)	lack	(m)	well	(m)	(m)	frost	(m)	worry
	chat		nyet			thong		jug
aa		ea	fair	ia	oa		ua	
		(d)	wear	(d)				
			mare	(d)				
ae	car	ee		ie	oe	foe	ue	flue
(m)	rather			(m)	(m)	know	(m)	do
	path					no		boot

ai (d)	lie why knight	ei (d)	veil day raid	ii	oi (d)	boil toy koi	ui
ao (d)	bout now crown	eo		io	oo		uo
au (m)	oar auk talk	eu (m)	fern bird purr	iu	ou (m)	put book bull	uu

Table\_2  
(corresponding to Table 1)

e  
bId  
[E]  
rIt  
gIn  
ea  
dH  
[R]  
sH  
wH  
ee  
bN  
kN  
pNcU  
ei  
[K]  
eo  
eu  
[F]  
a      bAd      bEd      i      o      pDd      u      bUd



[A]	IAk eAt	wEl uEt	[I]	[D]	frDst		[U]	wUrI		gUq
aa		fR wR mR	ia [H]	oa			ua			
ae [M]	kM rMaU pMo		ie [N]	oe	fG [G]		ue	fIX [X]		dX bXt
ai [Y]	IY wY nYt	vKI dK dK	ii		oi [T]	bTI tT tT		ui		
ao [B]	bBt nB krBn		io		oo			uo		
au [L]	L Lk tLk	fFn bFd bFd	iu		ou [J]	pJt bJk bJK		uu		

Another variation on the same idea (using a mixture of upper and lower case letters) would be statistically based. According to this system, sounds which occur most frequently in current English, i.e. in more than 1.5% of text, would be allocated to lower case letters and the remaining sounds, i.e. those occurring in less than 1.5% of current English text, would be signified by upper case letters, irrespective of whether they were vowels or consonants.

Although this system does not have the long-term possibility of the previously described scheme, i.e. that of dispensing with the vowels (and thus of the upper case letters representing them) in text used by the already literate, it has a significant advantage in the short and medium

term - which is that, since the upper case letters symbolise the less frequent sounds, the use of the shift-key on the usual QWERTY keyboard would be minimised. A suggested system is as follows (the proposed use of letters is illustrated where appropriate by the word before the slash):

Sounds occurring in over 1.5% of current English text (all the consonants except those signified would retain their present usage):

a = opan / open	j = fjl / feel	s
b	k	t
c = c / the	l	u = up / up
d	m	v
e = pen / pen	n	w
f	o = hop / hope	x = hxt / hat
g = get / get	p	y = ply / ply
h	q = mqk / make	z
i = pin / pin	r	

Sounds occurring in less than 1.5% of current English text (a rhotic pronunciation would be represented by this scheme in order to maintain a visual link with T.O.):

A = Art / art	I = let / yet	Q = nQ / now
B = bBk / book	J = viJan / vision	R = fRr / for
D = hDt / hot	K = Kin / chin	T = Tin / thin
E = bErd / bird	L = uLan / onion	U = Uz / use
F = Fen / when	M = Mip / ship	Y = rYl / rule
G = Gel / gel	N = siN / sing	! = glottal stop
H = HAn / khan	P = bP / boy	

Below is the Lord's Prayer translated into this orthography:

".Qr .fAcar, FiK Art in hevan, hxlod bj .cy nqm. .cy kiNdam kum, .cy .wil bj dun, in ErT xz it iz in hevan. .giv us cis dq Qr dqli bred, xnd fRrgiv us Qr trespAsiz, xz wj fRrgiv cem cxt trespAs agenst us. .xnd ljd us nDt intY temptqMan, but dilivar us frDm jvil. .Amen."

Click here to return to [Lango Directory](#)

**MENU: [HOME](#) » [Reconstruction](#) » [Recovery](#) » [Renewal](#) » [Language Main Page](#)**



Click here to return to [Lango Directory](#)

## Chapter\_Nineteen:

# "International\_Pronunciation\_and\_Accent"

The disintegration of empires, the movement of nation-states towards confederation, the rise of transnational corporations and global institutions, and the proliferation of electronic media, have also brought the unifying process to bear upon language. Firstly, half a millennium of printing has harmonised different dialects within primary language areas until there are now few verbal expressions, apart from regional or national token-words or phrases, which are not the common currency of all. Moreover, in this age of the electronic media the speech coming from all parts of the world is challenging the value of former standard pronunciations and accents. For example, the images of wealth and status crowding the T.V. screen from America and Australia have undoubtedly had an effect on British English, if only by diluting its affective value.

Indeed, the very accessibility of radio and T.V. as passive entertainment is altering the perception of modern peoples to language itself, compared to earlier print-oriented generations. Thus, even as the printing-press, through the circulation of books of international interest, such as the Bible, scientific works, great novels etc., embraced most dialect variations within the English-speaking world, the electronic media have contributed to the harmonisation or internationalisation of pronunciation: in other words, to an utterance that is globally acceptable as a result of its clarity, euphony and general comprehensibility. One evidence of this trend may be heard by comparing old films with modern ones of an equivalent quality. The clipped British accents of yesteryear have obviously absorbed international tonal elements. It has also been observed that young people in Britain are now more inclined to end sentences with the interrogative intonation characteristic of Australians.

But demonstrating that the best "national" pronunciation is clearly internationally comprehensible is quite different from claiming that it also represents a suitable standard pronunciation upon which to base a unified global spelling. Distinct national variations in pronunciation obviously remain, even within speech of the highest broadcast quality. It is evident that another means for determining a standard pronunciation for the orthography will have to be found.

The traditional method employed by nations which have decided to reform the orthography of their language has been to appoint a panel of experts, who have used statistics to obtain a closer match between spelling and an established national norm. This is the way in which language planning has progressed in Ireland, Norway, Russia, China, and other countries during the past hundred years. Even in the case of national languages, where publishers and lexicographers are closely associated with media/literary/educational establishments, the method is difficult enough; any attempt to repeat it on the

global scale would of course be considerably more so.

Within a national language area it is usually fairly evident what the normalised or "notional" pronunciation should be; but a more scientific, statistically-based procedure would have to be used internationally for the same purpose. Thus the representative panel of linguists officially selected to construct the language, having access to all the statistics concerning the global distribution of preferred diaphones for the standard phonemes, would be able to derive and ascribe a "notional pronunciation" for the international standard, based upon a precise allocation of phonemes to letters of the alphabet. This phonemic representation would be abstract, rather than exemplified by a given speaker, though a voice actor might be found to portray it.

Attempts have already been made to define this standard speech. The late Professor A C Gimson suggested a decreolised but rhotic Caribbean speech for the role within the English-speaking world. South African speech, in which the [r] has a rolled or trilled pronunciation, has also been advocated. To mention a few verbal examples, a suitable pronunciation according to international norms might have "vee-uh" rather than "vie-uh" for "via"; likewise "fin-ance" rather than "fie-nance"; "dee-alect" rather than "die-alect"; "anti-bee-otic" rather than "anti-bie-otic"; "Iran-ian" rather than "Eye-rayn-ian" etc.. Words with "long vowels" might have two pronunciations - current English, and a normalised "continental type" associated with the international dialect e.g. "make" might be pronounced as "maak": closer to the spelling (and an older pronunciation). Consonants [c, g, j] might be "hard", i.e. "okean, gem (not /dzhem/), yoint". These sounds might be brought about by the orthoepic effect of the written form.

Suitably qualified linguistic experts for the international language committee would really need an actual mastery of the entire global phonology, an equal regard for different national vocabularies, an understanding of the logic behind every grammar, and an aesthetic appreciation of the various kinds of script. No single individual could be expected to possess this degree of knowledge, or to be entirely free of linguistic presuppositions, but a properly-constituted and well-chosen committee, acting in consultation with all interested parties, would command the necessary expertise.

Many linguists around the world are already studying and codifying morphemes and phonemes, the building-blocks of language, with the idea of an international auxiliary very much in mind. Computer-linked, and with huge databases of information, they are more or less abreast of language development - and are keenly aware of the linguistic imperative of a global tongue: the need to harmonise vast differences in both phonology and script. The inauguration of the international language committee would inevitably catalyse a vigorous interaction between ideas for orthographic reform and a mass of research data.

But there is a drawback inherent in the essentially reactive nature of the scientific method. This could easily be seen in the past when the manual collection and collation of data could scarcely keep up with linguistic change. However, although modern recording and I.T. equipment may reduce the time-lag, e.g. by using phoneme-recognition programs on a population pro rata basis, the result will always be a step behind events. The safety-first objective approach avoids being bound by the dubious prognostications of

experts, but also loses the inspired predictions. A related problem is that of data selectivity: in this case concerning the types of "national" speech chosen to go into the computer.

Another problem with theoretical speech, formed by computer modelling, is that it might resemble no known pronunciation. In view of this, one suggested programme of English reform would be both orthoepic and minimalist, with spellings kept much the same as T.O. while international pronunciations according to this spelling became established. Listening to radio or television interviews from around the world, it is obvious that interviewees often pronounce words as they are written according to international norms, rather than like Britons or Americans: e.g. "the house in Austria" might well be said as "tea hoce in Owstria". Likewise, it is evident that Russians, Germans and Japanese speak Russian, German and Japanese English, respectively. These Englishes have their own national characteristics, but they also share features of syntax, pronunciation and vocabulary which do not derive from the English of Britain and America. Such varieties of linguistic preference would have to be accommodated in the fabric of the coming common language.

One advantage of the latter approach is that it would allow the notional pronunciation to gradually take concrete shape. But the world would wait a long time for a consensus to establish itself through this process. The accents in the media might well be converging, as might be discovered by comparing sound recordings from different decades and places, but it is happening so slowly that the demand for a common orthographic standard might not wait for it. Hence an alternative would be to anticipate the convergence of accent in some way. For instance, most people are quite capable of differentiating a "national" accent from a "regional" one; indeed, this is generally regarded as much easier than distinguishing a regional accent from a local one within that region. But this capability has only arisen due to the emergence and partial realisation of the national or racial idea, expressed through national politics and broadcasting institutions, and consolidated in reaction to other states.

In the same way, significant developments in international co-operation during the latter part of this century (such as the publication of "Agenda 21" in 1992), by demonstrating the possibility of global initiatives supported by the great majority of nations, have testified to the dawning awareness of humanity as a single society which is accountable for the interests of all its peoples. As with the development of the national idea, there is every reason to suppose that this global consciousness will be expressed by a corresponding fusion of speech elements, if such is not happening already. Thus, an attempt to determine the most internationally acceptable accent, as embodied by an individual on hand to record it, might become increasingly feasible. Such an enterprise might well reinforce the notional pronunciation which itself could never be more than an approximation due to the inherent limitations of the scientific method.

The standard accent might be determined by the official auxiliary language committee drawing up a sizeable shortlist of internationally-known public personalities and media figures from different parts of the world - any one of whom would be a suitable exponent of it - Sir Peter Ustinov is a contemporary example. The standard speaker would then be elected from this shortlist, perhaps by a world-wide telephone poll, or an extra ballot at elections.

By personalising the issue, this kind of election would be excellent publicity for the international auxiliary language, and would also be a realistic prospect since media broadcasts are beginning to span the globe. International satellite T.V. is well-established and trans-continental optical-fibre connections are gradually being laid, which also mean that the vagaries of short-wave radio reception can theoretically be replaced by crystal-clear sound coming from the other side of the world by satellite or cable. The practical facilities are thus being set in place for what could become a periodic election of the best, clearest, and most internationally- comprehensible English-speaker.

Briefly, the chosen speaker would read a list of words or a text containing the full range of phonemes, and would be carefully recorded doing so. The script would then exactly describe the accent portrayed by the selected speaker. This would be the global standard accent upon which, when beneficially combined with the international notional pronunciation, the comprehensive orthography/orthoepy would be based: a standard that would be referred to for a designated number of years - until change in the linguistic centre of gravity demanded a new election.

This exercise should produce a result very close if not identical to the notional pronunciation formulated by the language committee; and if not, the enquiry into the discrepancy might well perform the service of revealing a procedural inadequacy on either side, if not both. Taken together, these two approaches should powerfully reinforce and complement one another. In fact they should permit a speech/script relationship for orthographic purposes to be established with such exactitude that almost any kind of speech, e.g. authentic dialogue in plays or novels, might be precisely signified on the page. It is conceivable that this phonemic alphabet would replace the International Phonetic Alphabet (unusual consonants and vowels might be represented by standard digraphs) apart from the diacritics (only used in special circumstances) indicating nasalisation, stress, pitch, tone etc.. An author writing dialogue would simply need to check an aural copy of the global standard accent against its transcript, and vary his own script accordingly.

Such a thing would be impossible in Chinese, and hardly less so in English, as G B Shaw and other playwrights and writers of dialogue have testified; an orthographic link scarcely exists between the script and even one of the variations of Standard English like British Received Pronunciation. Ironically, it couldn't even happen in Esperanto because, as a consciously international auxiliary language, there are no non-standard accents and dialects by definition - since they would betray a sub-international mentality!

It must be firmly emphasised that the international standard would exist solely for the purpose of allowing various accents, dialects, and even foreign languages, to be represented orthographically on the page; in other words, to permit the operation of both the orthographic and orthoepic principles on a unified global scale around a single script. It should not be regarded as an "elocution standard", or as any indication as to how people should speak.

Click here to return to [Lango Directory](#)

**MENU: [HOME](#) » [Reconstruction](#) » [Recovery](#) » [Renewal](#) » [Language Main Page](#)**

---

---



Click here to return to [Lango Directory](#)

## Chapter\_Twenty: "Names\_and\_Organisation"

The approach of an international language committee towards questions of orthography and script should be modified where names are concerned because words and names are two different things. Words are inclusive but names are exclusive - as in the distinction between common and proper nouns. Names always contain an element of privacy - including the subjective definition of correct pronunciation. This is especially true of personal names; it is up to the owners of personal names to give them up for orthographic revision if and when they are ready; anything else is a kind of violation.

However, place names have a wider currency than personal names, and might be standardised via proper consultation with all interested parties. Lancelot Hogben in his book "Essential World English" suggested that local forms of place names should replace "English" versions. This is already happening - e.g. Ceylon, Leghorn, Moldavia, Andalusia have become Sri Lanka, Livorno, Moldova, Andalucia - but the process is not always straightforward. The ownership or validity of a name can be disputed: e.g. most of the citizens of a great Indian city call it Mumbai, but a substantial and influential minority prefers the "English" name Bombay. Homonymous villages, towns and regions are normally harmless enough, but not so in ethnic hot-spots such as Macedonia. Variant names for famous places become established by long and frequent usage. Thus the city the Italians call "Roma" has been "Rome" in English for hundreds of years and "(An) Róimh" in Irish for over a thousand; "Beijing" is now largely accepted, but "Peking" - which derived from the 17th Century French Romanisation system in which [k] was used for the "j" sound /dzh/ - is still preferred by some publishers. Sometimes a name cannot be universally adopted due to the script, or the presence of diacritics, yet an old transliteration is inexact: e.g. "Cologne, Copenhagen" for "Köln, Køberhavn". Many place names have a traditional spelling which hardly corresponds to the spoken version, and many others have distinct local and national pronunciations - raising the question of which should be used as the basis of an orthographic change.

The 1967 decision by the United Nations Organisation to standardise geographical names worldwide in Roman script may be seen as yet another indicator that the coming international auxiliary language is likely to be English-based. The United Nations Group of Experts on Geographical Names (UNGEGN), which meets biennially, is concerned not only to promote particular names but also to discourage the production of additional variant names. This disapproval of so-called "exonyms" challenges the desires of nations whose people are strongly conscious of the value of language as an aid to independent political existence.

The question of a name for an initially English-based international auxiliary language would have to be

determined democratically: a provisional suggestion we have come up with, until or unless something better emerges, is LANGO - which would have far-flung linguistic resonance, yet without a current meaning as in the case of LINGO or LINGUA. Moreover, LANGO is a handy acronym in English, French and Spanish, among other languages, (as shown on the first page - also, "LANGuage Organisation", as on the front cover). LANGO also happens to be the name of an important African tribe divided linguistically by two dialects and politically by the Sudan/Uganda border. Other names for the language that have occurred to us include:

LIBRE "Language Initially Based on Reformed English"

REFIC ("Refits") "Reformed English For International Communication"

ALIEB "Auxiliary Language Initially English Based"

GABIEL "Global Auxiliary Based Initially on the English Language"

KABARE "Kommon Auxiliary Beginning As Reformed English"

LUA "Langue Universelle Auxiliaire"

UNAL "Universal Neutral Auxiliary Language"

IDEAL "Initially Derived from English Auxiliary Language"

RENUAL "Reformed English Neutral Universal Auxiliary Language"

SABIR "Shared Auxiliary Based on International Roots"

SABIRE "Shared Auxiliary Based Initially on Reformed English"

REGAL "Reformed English Global Auxiliary Language"

REAL "Reformed English Auxiliary Language"

EMESAL "English Made Easy Shared Auxiliary Language"

LINK "Language for Inter-National Kommunikation"

KENGA "Kommon ENGLISH Auxiliary"

KELBA "Kommon English-Language Based Auxiliary"

KEBA "Kommon English-Based Auxiliary"

KEBIT "Kommon English-Based International Tongue"

KOREA "Kommon Orthographically-Regularised English Auxiliary"

RENGO "Reformed English with Normalised Global Orthography"

SOLE "Second Language English" or "Speakers of Other Languages' English"

BETIC "Better International Communication" or "Basic English Tongue for International Communication"

KIT(EB) "Kommon International Tongue (English-Based)"

KIBAT "Kommon International Brito-American Tongue"

KEBARO "Kommon English-Based Auxiliary Reformed Orthographically"

KOINE "KOMmon INternational English" orig. "lingua franca"

MON "Modern Orthographic Norms"

BUSA "Britain/USA language" or "BUSiness Auxiliary"

SHENGIL "Shared English International Language"

MUNDISH "Mundo" - "world" (Romance); "Mund" - "mouth" (Ger.)

GENLISH "General English" or "Genesis in English"

WoLa "World Language"

Most of us are trained throughout our formative years to regard the slightest variation to T.O. as a "mistake" rather than as a simplification or useful innovation: and the valid reason for this constraint - that unity must take precedence over regularity in matters of orthography - has tended to develop into a fetishistic or shibbolethic attachment to T.O. which scorns attempts to construct a universal and rational alternative. Thus the psychological aftermath of early conditioning has figured largely in the failure of attempts, whether gradualist or revolutionary, to influence the English language directly.

Ingrained attitudes of this kind can be difficult to change, but have yet been shown to respond to determined campaigns of public education, which brings us to the thought that we haven't yet considered the role of publishers and propagandists in the orthographic reform of English. Could influential newspaper and media magnates extend their worthy contributions in the fields of grammar and neologism to the realm of English spelling reform? They would seem to be ideal agents of change - conscious as they must be of the benefits of print-saving, of the needs of second-language speakers, and of the value to the bottom line of reaching the widest possible readership for their products.

Indeed, it might be supposed that the transnational character of major English-language publishers was an advantage in this respect. So it might be, but the maintenance of orthographic unity within the peculiarly decentralised English-speaking world depends upon an agreement which is all the more powerful for being informal, with no obvious centre to define itself against; and although publishing and media interests may be merging and consolidating, there is still sufficient diversity of ownership that no publisher or lexicographer is likely to independently introduce substantial reforms for fear of being left out on a limb.

The experience of the "Chicago Tribune" provides a telling illustration. Towards the end of the last century Joseph Medill, owner and editor of this leading American newspaper and member of the Council of the Spelling Reform Association introduced a number of orthographic spellings, most of which were gradually abandoned. However, the enterprise was revived in 1934 by Medill's grandson, with the support of readers who voted 3 to 1 in favour of "short spelling". Thus the "Tribune" once again started using words such as "bazar, burocrat, catalog, crum, glamor, harth, herse, iland, jaz, rime, sherif, staf, subpena, tarif and trafic".

Other spellings, including "tho, altho, thru, thoro, frate, fotograf, filosofy" were subsequently added, though some of the 1934 originals were already being discontinued. During the 50s and 60s no new words appeared, and most of the remaining orthographic spellings were dropped, including "tarif" and "frate". By the 70s only "thru", "tho" and "catalog" etc. survived, and even these were soon to disappear from the "Tribune's" columns.

Likewise "The Times" abandoned more orthographic spellings such as "Jugoslavia, baptize, colonize" etc. after a fairly recent change of ownership. All the evidence goes to show that an orthographic reform will only occur collectively, and in an organised manner; the gradualist approach, hitherto endorsed by many workers in the field, has manifestly failed. Although it might be rational to introduce a number of revised spellings it might be still more rational not to break the unwritten consensus.

In view of this fact, which has become apparent over a long period of time, enthusiasts for spelling reform have had to content themselves by inventing a variety of orthographies and writing numerous articles about the subject. But these theoretical considerations have done very little to advance the cause; praxis is an essential ingredient of language development. In Esperanto and other constructed languages we already have enough negative examples of the purely academic approach. It is now time for a coherent and co-ordinated initiative in which reforms might be assessed pragmatically.

As is well known, the democratic process demands that, after a due period of consultation and reflection, a single united programme be adopted, and then continued for a set period of time; the central principle being, not so much that the popularly chosen manifesto should be correct in all its aspects, as that everyone should endorse and uphold it for a trial period until the next election. In this way an incorrect policy or decision might be modified as a result of experience; without a run out in practice, there is no way of telling whether or not a theory is workable.

The international stage is now set for the redevelopment of a language which has redefined itself at roughly 200 year intervals since the 10th Century. In King Alfred's time there was a somewhat artificial standard national language based on the Wessex dialect. In the 12th Century the Chancery made the English of London standard and determined the orthography. Many neologists, grammarians, orthoepists and lexicographers later made important contributions. The language today known as English was quite different in the past, even as recently as the 18th Century, and it has been pointed out how much it has changed in our own lifetimes.

It is a myth that English, like Topsy, "just grewed". There has been a good deal of planning in the development of English, but it has taken place in an atmosphere of goodwill and consultation that would now be difficult to replicate, either in or between the diverse political systems of the English-speaking world. The forces of creativity have moved on to the international arena, as all the great movements of the late 20th Century testify, and it is within that matrix of modern idealism, the international auxiliary language, that the transformation of English must take place.

Click here to return to [Lango Directory](#)

**MENU: [HOME](#) » [Reconstruction](#) » [Recovery](#) » [Renewal](#) » [Language Main Page](#)**

---

---

Click here to return to [Lango Directory](#)

## Glossary

**Accent** The mode of utterance or pronunciation peculiar to an individual or locality, including stress, tone and pitch.

**Accusative** The grammatical case which expresses the destination of the action signified by a verb.

**Angles** A Northern European people from the Jutland peninsula speaking a West Germanic dialect of the proto-English type; known to themselves as "Engle". They gave their name to the English language.

**Argot** The jargon, slang or peculiar phraseology of a class; originally that of thieves and vagabonds.

**Aspirated** The manner of articulation of a consonant whereby an audible rush of air accompanies the production of the consonant.

**Auxiliary language** A third language used as a means of communication by speakers from two different language groups (see Lingua Franca).

**Brittonic** The earlier language of lowland Britain: its descendents being Welsh, Breton, Cornish and Cumbric. Often referred to less correctly as Brythonic.

**Celt or Kelt** The generic name of a people, the bulk of whom lived in the central and western part of Europe. Ancient writers applied the term Celt to folk of great stature, with fair hair and blue or grey eyes. Queen Boadicea, strictly "Boudicca", said to have been a red-headed six footer, is representative. In Britain the most Celtic type is to be found in the South of England.

**Celtic** The languages and cultures of the continental Celts and related peoples in Britain and Ireland.

**Conventional Spelling** One established by the need for grammatical consistency rather than by orthography.

**Colloquial** Pertaining to or used in common conversation.

**Common-Irish** The shared literary language used by educated people in Scotland and Ireland prior to the evangelising of the Highlands at the end of the 18th Century.

**Consonant Cluster** e.g. "strengths, twelfths".

**Copula** The word that unites the subject and the predicate of a sentence.

**Creole** A pidgin which has been adopted as a mother tongue. New Guinea pidgin English is the best known example.

**Diacritic** A mark added to a letter or symbol indicating a change in its usual pronunciation, e.g. á, ê, ü.

**Dialect** Any variety of a language including the standard or literary form.

**Diaphone** All the different forms of a phoneme that collectively occur in all the dialects of a language.

**Digraph** Two letters denoting one sound: /ph/ in "digraph".

**Diphthong** A union of two vowels pronounced in one syllable.

**Dvorak Keyboard Layout** Designed in 1936 by August Dvorak and William Dealey.

" , . P Y F G C R L / =  
A O E U I D H T N S  
; Q J K X B M W V Z

**Ellipsis** The omission of a word, or part of a sentence, as being understood by the reader.

**Engle** See Angles

**Erse** An early Scottish variant of the word "Irish".

**Esperanto** See Chapter 5 for main reference.

**Etymology** The facts relating to the formation or derivation of a word.

**Euphony** Phonetic tendency towards ease of pronunciation and a pleasing acoustic effect.

**Farsi** Modern Persian - the official language of Iran.

**Friese** A language of about 300,000 speakers in Northern Holland, Schleswig, Jutland and over 20 islands in the North Sea. Mutually intelligible with English until the 15th Century. Gives some indication of what a pure form of English would have been like.

**Genitive** Noun case expressing origin or possession, e.g. "Rome's citizens, John's book".

- Glosa** An update of "Interglossa" - the elementary Greek and Latin based constructed language invented by Hogben.
- Goidelic** The earlier language of Ireland: its descendants being Modern Irish, Scottish Gaelic and Manx.
- Grammar** A system of principles for speaking and writing.
- Homonyms** Words with different meanings looking and sounding the same.
- Homographs** Words with different meanings looking the same.
- Homophones** Words with different meanings sounding the same.
- Ideogram, Ideograph** A symbol signifying meaning directly and visually, e.g. a Chinese character.
- Ideogrammatic, Ideographic** Conveying meaning rather than sound. English spelling is perhaps more ideogrammatic than phonemic - making minimal reference to the parallel phonetic system of speech.
- Idiom** The language of a particular nation or region; or a mode of expression peculiar to a nation or region. An expression characteristic of a particular language which is not logically or grammatically explicable.
- Idiomatic** Mother-tongue competence, whether or not it is the speaker's first language.
- Indo-European** A family of languages characteristic of Europe and India. English and Hindi belong to it. Finnish and Tamil do not. Latin, Greek and Persian were descended from it.
- Inflection** The modification of the form of a word including the declension of nouns, adjectives and pronouns, and the conjugation of verbs.
- International Phonetic Alphabet (I P A)** A set of phonetic symbols for international use introduced in the late 19th Century, constructed on the basis of the Roman and Greek alphabets with the addition of special symbols and diacritics to indicate fine distinctions in sounds, e.g. nasalisation of vowels, lengths, stress and tones.
- Intonation** Modulation, or the rise and fall in pitch of the voice.
- Ladino** An old-fashioned form of Spanish spoken by Sephardic Jews.
- Lexicon** A word-book or dictionary. A vocabulary of terms used in connection with a particular subject.



**Lingua franca** A language used as a means of communication by speakers who do not have a native language in common (see Auxiliary Language).

**Linguistic** Pertaining to languages.

**Metonym** A word used in a transferred sense, e.g. "the bottle" for "drink".

**Monophthong** A single vowel sound.

**Mood** A variable verb function expressing predication (indicative), command (imperative), potential or volition (subjunctive) or will (infinitive).

**Morphemes** Parts of a word which singly or together convey meaning.

**Neologism** A new word, or an old word used in a new sense.

**Normalise** To bring within normal or intermediate standards.

**Notional** Existing only as a concept.

**Notional Pronunciation** A pronunciation conceived as a compromise to reconcile a range of diverse accents in order to act as a model for spellings which would find the widest degree of acceptance.

**Number** Singular or plural.

**Old-English (englisc)** A West Germanic language almost identical to Old-Friese. Probably the lingua franca of the Roman Army in Britain. Named after the Engle.

**Orthoepy** The part of grammar that treats of the way a given language is spoken.

**Orthography** The part of grammar that treats of the way a given language is written.

**Pali** A Prakrit vernacular which became the sacred language of Buddhism.

**Phoneme** A notional phonological unit of language, which conveys meaning, and which cannot be analysed into smaller meaningful units.

**Phonemic** Symbols etc. representing particular phonemes.

**Phonetic** Representing vocal sounds.

- Phonic** Concerning speech sounds, esp. the orthoepic interpretation of words when reading aloud.
- Phonology** The study of the sound system of a particular language.
- Phrasal Verb** A verb and one or more additional words, having the function of a verb, e.g. "put down, put up, chop down, chop up"
- Picts** An earlier name of the inhabitants of Scotland. They disappeared from history when they united with the Irish-speaking Scots in the 9th Century.
- Pidgin** A linguistically simplified, mixed and restricted language used in limited contact situations between people who have no common language.
- Pitch** The degree of acuteness of sound.
- Prakrit** One of the "natural" languages of later schismatic Hindu scripts. Three have been used by the Jains.
- Pronunciation** The action of speaking or articulating.
- Received Pronunciation (R.P.)** The pronunciation of that variety of British English widely considered to be the least regional, being originally that used by educated speakers in Southern England.
- Received Standard** The spoken language of a linguistic area in its traditionally most correct and acceptable form.
- Reflexive Pronoun** A pronoun that relates back to the subject in a sentence.
- Relexification** Direct substitution of vocabulary: the process of replacing a word or group of words in one language with a corresponding word or group of words from another language but without adjusting the grammar.
- Rhotic** A dialect or accent in which [r] is pronounced when it occurs before a consonant or a pause.
- Romance** A general name for the vernaculars which developed out of popular Latin - French, Provencal, Italian, Spanish, Portuguese, Romanian, Romansch, with their various dialects.
- Sanskrit** The "perfected/purified" language of the ancient Hindu religious scripts.
- Saxons** A Northern European people from Northern Germany speaking a West Germanic dialect. The name was generalised to include all Northern Germans. In Britain, used for the Romano-British majority

which had adopted Saxon language and ways.

**Schwa** A short indeterminate vowel, like that at the end of "sofa". By far the commonest vowel sound in English.

**Scot** The usual name for the Irish in the early Middle Ages. Scots from Dalriada in Northern Ireland took the Irish language to Northern Britain in the 6th Century. Scotland takes its name from them.

**Scotia** One of the names for Ireland in the early medieval period.

**Script** A kind of writing, or a system of alphabetical or other written characters.

**Semantic** Relating to meaning, especially of words.

**Shibboleth** A word or pronunciation used to distinguish outsiders: originates from the incident described in the Bible - Judges 12: 4-6 (see also Zephaniah 3: 8-9).

**Stress** Relative loudness or force of vocal utterance through a syllable in a word or a word in a sentence.

**Syllabification** To divide a word or passage into syllables.

**Synecdoche** A figure of speech putting part for the whole, or the whole for part.

**Syntax** The orderly or systematic arrangement of the parts of speech in a sentence.

**Tense** The form of a verb which indicates the time of the action.

**T.O.** "Traditional Orthography": the present spelling of the English language, which is not really orthographic at all, by any current standard.

**Tone** The quality of sound, usually with reference to pitch: high, low, rising, falling, level etc..

**Transliteration** The action of rendering the letters or characters of one alphabet into those of another.

**Verbal** Pertaining to or concerned with words, especially in speech.

**Vernacular** A native or indigenous language. The idiom of the region.

**Voice** One of two verb forms: active (the object acts) or passive (the object is acted upon).

**Voiced** A sound whose production involves vibration of the vocal chords, as in [b, d, g, v, z].

**Voiceless** A sound whose production does not involve vibration of the vocal chords, as in [p, t, k, f, s].

**Volapük** An artificial language, chiefly composed of materials from European tongues, invented in 1879 by a German priest, Johann M Schleyer, as a means of international communication.

**Welsh** A name derived from the continental Volcae, which came to be applied indiscriminately to all Western European inhabitants of the Roman Empire. In Britain the word Welsh was probably first applied to speakers of Latin; on the Continent, variants such as Walloon, Wallon, Waalsch, Welsch, Velsk, and Vlach are still applied to the French, the Italians and the Romanians.

**Zipf's Law** The length of a word tends to decrease as its relative frequency of use increases: i.e. one can generally determine the relative age of a word or phrase by how short it has become.

Click here to return to [Lango Directory](#)

**MENU:** [HOME](#) » [Reconstruction](#) » [Recovery](#) » [Renewal](#) » [Language Main Page](#)

---

---

**MENU:** [HOME](#) » [Reconstruction](#) » [Recovery](#) » [Renewal](#) » [Language Main Page](#)

# WLP Proposal to UHJ

The follow links are to part of a WLP proposal (without the financials and other details) that was submitted to the UHJ. It contains a study about the Baha'i teachings and Universal Auxiliary Language

[An essay on Baha'i Universal Auxiliary Language Institutes](#)

[Short References to the essay on Baha'i Universal Auxiliary Language Institutes](#)

[Bibliography for the Baha'i Universal Auxiliary Language Essay](#)

[Raw references for the Baha'i Universal Auxiliary Language Essay](#)

**MENU:** [HOME](#) » [Reconstruction](#) » [Recovery](#) » [Renewal](#) » [Language Main Page](#)

---

---

## WLP Proposal

This essay is from a proposal that was sent to the Universal House of Justice with the commitment that there would be no request for funds from any Baha'i institutions so as not to detract from any other priorities that they might have.

The response from the Universal House of Justice included the following statement:

*"Your research into the development of a common language and your vision for the language institutes, undertaken to promote one of the important teachings of the Cause, are much appreciated. The time, however, is not propitious for the House of Justice to endorse, formally or otherwise, any project in this field of endeavor. Naturally, you are free to pursue this initiative as a private venture...."*

The proposal contained considerable more material than repeated here, however the relevant Baha'i quotes are to be found in the following essay.

## Why Baha'i Universal Auxiliary Language Institutes

*(The numbers in the [square brackets] refer to both the attached references and the complete raw notes in the following Appendix A)*

### Universal Language is the Second Incumbency Upon Universal House of Justice

Universal auxiliary language concepts are a matter of global purview and a responsibility assigned by Baha'u'llah, directly to the Universal House of Justice. Baha'u'llah said, "It is incumbent upon the Trustees of the House of Justice to take counsel together regarding those things which have not outwardly been revealed in the Book, ... (regarding ) languages, ... efforts must be made to reduce them to one,..." [1] He further says regarding that which "constitute(s) the fundamental principles for the administration of the affairs of men: **First:** It is incumbent upon the ministers of the House of Justice to promote the Lesser Peace .... **Second:** Languages must be reduced to one..." [2] and further that "We have enjoined upon the Trustees of the House of Justice ... to choose ... This ... is accounted as part of the Most Holy Book: The men of God's House of Justice have been charged with the affairs of the people. [3]

'Abdu'l-Baha further reinforced this point, saying, "Questions not treated of are left to the civil law of

each country, and to the decisions of the Bait-ul-Adl, or House of Justice, instituted by Baha'o'llah (sic). ... A universal language, and the creation of tribunals of arbitration between nations, are to suppress wars." [41]

### **Universal Language also Responsibility of Governments and *Individuals***

The call for a universal auxiliary language figured prominently in many of the presentations and interests of Baha'u'llah [4,5,6,7,8], 'Abdu'l-Baha [14,15,16,17,18,19,20, 22, 24,25,26,27,28, 29,30,31,32,33,34,35, 42,43], and Shoghi Effendi [44,45,46,47,48,49,50, 52,53,54,55, 57,58,59, 62]. Baha'u'llah placed the responsibility of establishing a universal language not only upon the Universal House of Justice but also upon "the sovereigns of the world" [4], "the ministers of the earth" [4], and the "members of parliaments throughout the world" [8], saying that it is "incumbent upon all nations" [5], and the "officials and ministers of the Government" [7]. He wrote individually "to the kings and rulers of the various nations, recommending that one language should be sanctioned and adopted by all governments" [29], even hoping that "the Persian Government" [7] would carry it out. In fact, He said that, "*It is incumbent upon every man of insight and understanding to strive to translate that which hath been written into reality and action....*" [6]

'Abdu'l-Baha has said that a universal language will be accomplished through "A committee appointed by national bodies" [15], "the matter to be determined by a confederation met for the purpose which shall represent all tribes and nations." [16] He has said that "the servants of humanity should meet together," [24] and that "An international Congress should be formed, consisting of delegates from every nation in the world, Eastern as well as Western." [24] That "It must be made by a Council representing all countries," [26] He said that it was His "hope that it may be perfected through the bounties of God and that intelligent men may be selected from the various countries of the world to organise an international congress whose chief aim will be the promotion of this universal medium of speech." [27] and that "Ere long significant and scientific discussions concerning this matter will arise among the people of discernment and insight and it will produce the desired result." [42]

Baha'u'llah's "injunction to the members of parliaments throughout the world, urging the adoption of a universal script and language;" [45] along with His exhortation that "the legislators to 'take counsel together,'" [44] is of course confirmed by Shoghi Effendi.

### **Universal Language is the Greatest Means for Promoting Unity**

Baha'u'llah has stated that "the greatest means for the promotion of ... unity is for the peoples of the world to understand one another's writing and speech. ... Thus will the earth be regarded as one country and one home." [3] He says to the leaders of the world that a universal language is "that which shall profit you and enable you to be independent of others. ... This will be the cause of unity, ... and the greatest instrument for promoting harmony and civilization" [8] He repeatedly states that it is what will cause "the whole earth ... to be regarded as one city and one land. [1] or "as one country", [4,5,7] saying that, "When this is achieved, to whatsoever city a man may journey, it shall be as if he were entering his

own home. [6]

'Abdu'l-Baha has said that, " the question of an auxiliary international tongue has the utmost importance." [27] He adds that it is, "Through this means international education and training become possible;" [27] and that , "The explanation of divine teachings can only be through this medium." [27] He says therefore, "the very first service to the world of man is to establish this auxiliary international means of communication. It will become the cause of the tranquillity of the human commonwealth. Through it sciences and arts will be spread among the nations, and it will prove to be the means of the progress and development of all races." [27] He further points out that, "The causes of dispute among different nations are always due to one of the following classes of prejudice: racial, lingual, theological, personal, and prejudices of custom and tradition .... The differences in language cause disunion between nations. There must be one universal language." 25]

Today we realise that communication builds community and world wide communication will build world wide community so that as Baha'u'llah says, "...this ... is the means of the reconstruction of the world and the unity of nations." [3] Likewise, 'Abdu'l-Baha says, "the brightest ray is the coming of the universal language. Its achievement is the greatest virtue of the age ... and when the international auxiliary tongue becomes universal it is easily conceivable that the acquirement of knowledge and instruction will likewise become universal.

Today one of the chief causes of the differences in Europe is the diversity of languages. ...The greatest working basis for bringing about unity and harmony amongst the nations is the teaching of a universal tongue... His Holiness BAHÁ'O'LLAH declared that complete union between the various nations of the world would remain an unrealized dream until an international language was established.

Misunderstandings keep people from mutual association and these misunderstandings will not be dispelled except through the medium of a common ground of communication. A mutual language will become the mightiest means toward universal progress, for it will cement the east and the west. It will make the world one home and become the divine impulse for human advancement." [18]

### **Baha'u'llah, 'Abdu'l-Baha and Shoghi Effendi actively promoted Universal Language**

Baha'u'llah's, 'Abdu'l-Baha's and Shoghi Effendi's interest and commitment to the development of a universal language were not limited to prophecies about the future or mere statements about the cultural and sociological benefits to be associated with such an ideal. They each and every one actively made positive efforts, in keeping with the circumstances of their times, to further the language cause.

Baha'u'llah offered to teach an inquirer a suitable international language. [7] Taherzadeh [83] speculates that this may have been Esperanto but this may be questioned because Baha'u'llah says that it also involved a new script, something which is not generally contributed to Esperanto. Anyway, as Marzieh Gail, states, "The language and script .. were never communicated to anyone by Baha'u'llah." Baha'u'llah actually would have preferred that Arabic become the universal language [79] but, as described above, he



has left the choice to mankind. Baha'u'llah also revealed a rather mystical language called Badi' [13] 'Abdu'l-Baha made reference to the same or a similar language. [36] 'Abdu'l-Baha also recommended the learning of Persian [40], but not specifically as a universal language.

While, as shown earlier, both Baha'u'llah and 'Abdu'l-Baha directly encouraged world leaders to immediately take action on the language issue, 'Abdu'l-Baha went much further in directly supporting Esperanto. [55] Although He acknowledged that Esperanto had many deficiencies, and His list of requirements for a universal language was in many ways a list of the deficiencies of Esperanto, [26,23] and although He emphasised that "no one person can construct a Universal Language", still He said, "Praise be to God, that Dr. Zamenhof has constructed the Esperanto language. It has all the potential qualities of universal adoption. All of us must be grateful and thankful to him for his noble effort, for in this matter he has served his fellow-man well. He has done a service which will bestow divine benefits on all peoples. With untiring effort and self-sacrifice on the part of its devotees it holds a promise of universal acceptance. Therefore every one of us must study this language and make every effort to spread it, so that each day it may receive a wider recognition, be accepted by all nations and governments of the world and become a part of the curriculum of all the public schools..." [18]

'Abdu'l-Baha concluded that, " Esperanto ...is a fine invention and a splendid piece of work, but it needs perfecting. Esperanto as it stands is very difficult for some people. [24] He further said, "This language will be spread and universalized to a certain degree, but later on a language more complete than this, or the same language will undergo some changes and alterations and will be adopted and become universal." [43] While pointing out Esperanto's deficiencies He nevertheless encouraged people to "strive untiringly to spread this language." [19] He, Himself inviting teachers of the language to go to Persia and asking Persians to go to Paris to study it. [18] He said, "Therefore appreciate 'Esperanto', for it is the beginning of the carrying out of one of the most important of the Laws of Baha'u'llah, and it must continue to be improved and perfected." [24] and assured that , "The love and effort put into Esperanto will not be lost," [26] in the hope "that Dr. Zamenhof, (would) become assisted by the invisible confirmation and do a great service to the world of humanity." [43]

Shoghi Effendi was also a major supporter of Esperanto, "invariably encouraging the believers, both in the East and in the West, to make an intensive study of that language," [54] pointing out that "the teaching of that language has been repeatedly encouraged by 'Abdu'l-Baha," [55] although further stating, "there is no reference either from Him or from Baha'u'llah that can make us believe that it will necessarily develop into the international auxiliary language of the future." [55] and that "Neither Baha'u'llah, nor even 'Abdu'l-Baha, ever stated that Esperanto will be the international auxiliary language." [54] so only "encouraging the Baha'is to learn it, if they wish to." [58] In fact, there were cases where, "He would not advise ... to teach ...Esperanto, as we have no way of knowing whether it will ultimately be chosen as the auxiliary language of the world." [59]

Still, Ruhiyyih Rabbani informs us that, "Shoghi Effendi had far more contact with certain non-Baha'i organizations than is commonly supposed. ... particularly ... the Esperantists, ..." That he "often took the initiative himself in sending Baha'i representatives, chosen by him, to various conferences ...", addressing them as his "'dear fellow workers in the service of humanity, ..." whom he reminded of the "'repeated

and emphatic admonitions of 'Abdu'l-Baha (to) His many followers ...(who were) strenuously and enthusiastically engaged in the study and teaching of Esperanto," [63] Indeed, the enthusiasm, interest and support of Baha'is for the language movement, just those few short decades ago, were amazing, It received not just a cursory mention in a listing of the principles of the Faith, nor the pious futuristic expectation presently about equally attributed to vegetarianism, but a predominance that might be properly associated with one of the seven candles of unity [20] and one of the "two signs for the coming of age of the human race". [8,9,10] In those days there were even Baha'i International Auxiliary Language Committees [48] and Baha'i international language study days. [49]

### **Present Day Baha'is are relatively inactive in promoting Universal Language Solutions**

Today, among most Baha'is, any expression of interest in working on the language problem is met with the easy formulation that it is something for the future. That it is not an individual's concern, and indeed not even properly a present concern of the Universal House of Justice because, "The first stage will be the adoption of a universal language by the governments, while the second will have to wait until such time that the Universal House of Justice has emerged as the supreme institution of the World Order of Baha'u'llah and its authority is recognized. It is only then that it can possibly reconsider the choice of the language so as to either retain the one chosen by the governments or alter it altogether." [78] For this reason it is felt that a person devoted to this seemingly Quixotic language cause is really tilting with windmills and diverting energies from the present pressing needs for the expansion of the Faith. However, Baha'u'llah states in regard to our subject that, "These things are obligatory and absolutely essential" [6]. Moreover, He says, "It is incumbent upon every man of insight and understanding to strive to translate that which hath been written into reality and action...." [6] And, as the Universal House of Justice has pointed out in its letter of May 15, 1994, "The power of action in the believers is unlocked at the level of individual initiative...".

Indeed, far from diverting energies from the expansion of the Faith, the language issue may be central to its success. Aside from being referred to as, "The seventh candle ...(of) unity" [20], and one of the "two signs for the coming of age of the human race", [8,9,10] 'Abdu'l-Baha says that, "The explanation of divine teachings can only be through this medium. As long as diversity of tongues and lack of comprehension of other languages continue, these glorious aims cannot be realized." [27] In this connection Baha'u'llah has said, "Every age hath its own problem, ... The remedy the world needeth in its present-day afflictions can never be the same as that which a subsequent age may require. Be anxiously concerned with the needs of the age ye live in, and centre your deliberations on its exigencies and requirements." [6] "The All-Knowing Physician hath His finger on the pulse of mankind. He perceiveth the disease, and prescribeth, in His unerring wisdom, the remedy." [6]

### **The Possible Future Role of English as the Universal Language**

Still, some persons have doubts about supporting the goal of the World Language Program. For instance, there are raised accusations of cultural imperialism when in fact there are more persons today who speak English as a Second Language than those who speak it as their mother tongue. Indeed, when 'Abdu'l-

Baha and Shoghi Effendi supported [62] the spread of the Romance Language culturally based Esperanto there were numerous contenders for an international language. French was still on the rise and recognised as the language of diplomacy, German was the recognised language of science, Latin was the language of law and medicine and Italian of music. 'Abdu'l-Baha and Shoghi Effendi made it very clear that they recognised the limitations of Esperanto and the unlikelyhood of its success, yet they gave it immense support.

Mario Pei, without question the world's foremost secular authority on universal languages, states that there have been over 650 attempts to develop a suitable solution. Notable attempts contiguous with Esperanto in the time of 'Abdu'l-Baha and Shoghi Effendi were Ido and Interlingua. The World Language Process may be simply a 651st+ attempt, but perhaps the important thing is to keep trying. In any case the World Language Program does not force English on anyone but only offers its ITM (Intermediate Teaching Method) as a service to the members of mankind who would like to learn English as a Second Language.

English, as it stands today, is deficient in a number of ways in meeting the standards established by Baha'u'llah and 'Abdu'l-Baha for a universal language. 'Abdu'l-Baha spelled out many technical details regarding a universal language, stating that it must:

- a. "... contain words from different languages." [26]
- b. "... be governed by the simplest rules ..." [26]
- c. "... there will be no exceptions..." [26]
- d. "... neither will there be gender..." [26]
- e. "... nor extra and silent letters." [26]
- f. "...Everything indicated will have but one name." [26]

The system used by the World Language Process meets all these requirements.

### **The Distinguishably Separate Call for a Common Script**

Baha'u'llah, in combination (but distinguishably separate) with his call for a universal language also called for a "common script" [1,3,4,5,6,7,7,8,10], a call which was of course reiterated in the writings of Shoghi Effendi [44,45,46,52,53] but strangely not in those of 'Abdu'l-Baha.

Baha'u'llah's father was famed for his calligraphy, [94] knowing many scripts, but we are told that while Baha'u'llah's favourite script was shitastih-nasta'liq [95,94] the Revelation Writing of His amanuensis was in Khatt-i-tazili. [96] although Browne says the Babi's created a new writing called Khatt-i-Badi, possibly related to the Badi language [13] mentioned above.. The recognition of the significance of a common script is a subject within itself. Without belabouring the difference between scripts, fonts and faces, English commonly uses the Roman script but there have been others proposed and used.. For example the Mormon Deseret by Brigham Young, WES (World English Spelling), ITA (International

Teaching Alphabet), Pitman and other shorthands, to name just a few. Khatt-i-tazili could perhaps be compared in function to the latter.

Baha'u'llah stated that, "... before Adam. There was ... a system entirely different from the one which they now use. For a proper exposition of this an elaborate explanation would be required." [12], He was perhaps intimating that technologies previously existed beyond the comprehension of his contemporary audience. Today, electronic technology for digital storage and a law passed in 1994 by the U.S. Congress regarding the required inclusion of captioning decoders in all future home television receivers has dictated the design of the ANJeL Tug to conform with both the U.S. and 'Abdu'l-Baha's standards. To properly explain this to Baha'u'llah's contemporary audience would certainly have required an elaborate explanation.

### **Other Issues In the Development of a Universal Language**

As 'Abdu'l-Baha was well aware, there were many other technical issues when He stated, "...Ere long significant and scientific discussions concerning this matter will arise among the people of discernment and insight and it will produce the desired result." [42] And indeed, as Esselmont stated, "Baha'u'llah commanded the adoption of a universal auxiliary language, and Dr. Zamenhof and others[39] obeyed His call by devoting their lives and genius to this great task and opportunity." [86], although as he also noted, their contributions have not always been willingly received. [85] The development of the ANJeL Tug stands upon the backs of giants too numerous to list but including Zamenhof, C.K Ogden, I.A. Richards and Mario Pei to name but four. These scholars, and many others, devoted their lives to developing principles that we discover in retrospect were already delineated in the Baha'i Scriptures, if we had but the wisdom to recognise them. A listing here of the principles, and their ramifications, would border on pedantry and would only be of interest to the technically inclined. Just as Baha'i spiritual economic principles find their fulfilment in the work of technical economists so also are the linguistic principles being implemented by technical linguists.

There are also many issues other than those which are technical. The question of universality [1,2,3,4,5,6,8,9,10,15,20, 22,24,26,28,31,32,33,34,41,42,43,44,45,46,50, 57,75,79,80, 81,82,88,93] versus auxiliary[7,14,16,18,19,27,29,30,35,47,48,53,54,55,57,58,59,63,64,75, 76,77,78,86,87], the subject of unity and diversity [51,74], the role of secular organisations [4,5,7,8] versus that of the Universal House of Justice [1,2,3,41], and even that of individuals [6,18,27,90]. The means of spread of the universal language through schools [2,3,4,5,6,7,15,18,26,29,53,75,87], and other means [8,16,45,24,28,30,31,32,55,93], the translation of Scripture [21,56,69,70,71,72,73] and its use for Baha'i publication [68], to name just a few. The purpose here, however, has not been to exhaustively examine any of these issues, technical or otherwise, but simply to demonstrate how regardless of the effort being spent or not spent on the language problem by Baha'is, the Divine Destiny still moves forward.

### **The Present Opportunity is Much Greater than those of the Past**

The Divine Destiny has unfurled numerous technological advances (eleven of which are discussed

elsewhere in these pages) that have made both the necessity and possibility of a universal language infinitely more apparent. Although no human organisations are actively pressing for its realisation these Divine Destinies will, in the words of 'Abdu'l-Baha, "inevitably come to pass, inasmuch as the power of the Kingdom of God will aid and assist in their realization." [20] Still, does this relieve us individually from making an effort? Especially since Baha'u'llah has said that, "These things are obligatory and essential.", and "It is incumbent upon every man of insight and understanding to strive to translate that which hath been written into reality and action...." [6] Are not the technological changes of the last several decades simply a sign of the Divine Assistance towards our achieving the Divine Decree? Should we not, having the greater resources and opportunity, now press on even more eagerly than did those early pioneers under the guidance of 'Abdu'l-Baha and Shoghi Effendi?

Since 'Abdu'l-Baha has said that "it matters not what language man speaks or employs" [29] and that no matter which universal language is chosen it will be "revised" [26], for the time being does it hurt to teach that language which is most universally popular as a second language? He, Himself said that He would have learned Esperanto, had it been more universally accepted, [18] but, For Shoghi Effendi, [60] and others, [37,38] He required the learning of english which He considered to be a "world language". [60] Admittedly, it may not be officially called a universal language until decreed as such by those mechanisms designated by Baha'u'llah and 'Abdu'l-Baha and admittedly the ANJeL Tug prototype even if accepted through those mechanisms would be subject to those same revision procedures. Still, today, the ANJeL Tug is only being presented as a revolutionary ITM (Intermediate Teaching Method) that reduces the learning of english from years to a single month. Can we not say then that this would be a service to mankind?

This is an attempt, as Baha'u'llah says, "to translate that which hath been written into reality and action... That one indeed is a man who, today, dedicateth himself to the service of the entire human race. The Great Being saith: Blessed and happy is he that ariseth to promote the best interests of the peoples and kindreds of the earth." [6] Is it not obedient to the instructions of 'Abdu'l-Baha to make the effort to perform "the very first service to the world of man (which) is to establish this auxiliary international means of communication."? [27]

## **The Possible Role of North America**

One cannot say definitively what the future holds but it would not be surprising, based upon the United States past record of non-support for the League of Nations and an effective United Nations, and as the last major bastion against the international metric system of weights and measures, but that the American people might be the last to willingly accept any modifications to the english language. Although, given world antipathy to American causes this too might work for the good of goal. However, 'Abdu'l-Baha says that He finds, "these two great American nations highly capable and advanced in all that appertains to progress and civilization. These governments are fair and equitable. The motives and purposes of these people are lofty and inspiring. Therefore, it is my hope that these revered nations may become prominent factors in the establishment of international peace and the oneness of the world of humanity; that they may lay the foundations of equality and spiritual brotherhood among mankind; that they may manifest the highest virtues of the human world, revere the divine lights of the Prophets of God and establish the

reality of unity so necessary today in the affairs of nations." [31]

In the Tablets of the Divine Plan, 'Abdu'l-Baha repeatedly told these two great American nations to "send to (the East and the West)... fluent speakers" [98] and teachers throughout the world. Particularly in the Tablet in which Kansas was addressed He says that it is, "like unto the heart of America, and the heart is connected with all the parts of man. If the heart is strengthened, all the organs of the body are reinforced, ..." [99] Moreover, He says in the same Tablet, America will assuredly evolve into a center from which waves of spiritual power will emanate... [100] How fitting then that Kansas should be one of the locations for one of the two proposed universal language institutes. How essential and favourable this location might be as a centre from which to institute mass teaching in the period of reconstruction after the universal great catastrophe.

### **The Possible Role of Baha'i Institutes**

The Universal House of Justice has told us that, "institutes should not only be seats of Baha'i learning but also centres from which mass teaching and consolidation work over a large area must be inspired and conducted." [89] The goals, both of the Institutes themselves, and of the teachers that they would produce, would be to:

#### **Category I.**

- " \* Encourage individual believers to adopt teaching goals for themselves.
- \* Carry out activities designed to deepen the believers in both a spiritual and intellectual understanding of the Cause.
- \* Encourage the believers to make greater use of Baha'i literature.
- \* Encourage the believers to enhance their command of language to assist them to understand the Baha'i writings ever more clearly." [90]

These foregoing are surely worthwhile Institute and mass teaching goals but the specific goals of these Institutes would also include:

#### **Category II.**

- the encouragement of:                   \* "the adoption of a world auxiliary language" [91],
- the advocacy of :                       \* "the establishment of world government" [91],
- \* "the promotion of education" [91],

\* "the extension of social and economic development" [91],

and the mounting of a publicity  
campaign for :

\* "world peace through world language" [91].

Many of the Institutes goals may be accomplished through developing and administering

\* "correspondence courses for teaching and deepening" [91]

particularly towards the goal of

\* "teaching the concept of world citizenship" [92].

The above Category II goals, universalist and ambitious as they may be, are intentionally selective from the tasks commended to the Institutes by the Universal House of Justice. The reason for this is the unique relationship which these two initial Institutes, and the offspring which they would spawn, would have to the World Language Process. While the Baha'i Institutes would seek to inspire and deepen Baha'i teachers, and teachers of Baha'i teachers, the vehicle of service to humanity which they would be using, namely the World Language Process, remains much more narrowly focused and identifies itself with no sectarian religious or nationalistic or otherwise limited political agendas.

**MENU: [HOME](#) » [Reconstruction](#) » [Recovery](#) » [Renewal](#) » [Language Main Page](#)**

---

---

Short form of references for  
**Why Baha'i Universal Auxiliary Language Institutes**

- [1] eighth leaf in the Kalimat-i-Firdawsiyyih (Words of Paradise) in Tablets of Baha'u'llah, Page 68
- [2] Lawh-i-Dunya (Tablet of the World) in Tablets of Baha'u'llah, Page 89
- [3] Ishraqat (Splendours) in Tablets of Baha'u'llah, Pages 127-128
- [4] Bisharat (Glad-Tidings) in Tablets of Baha'u'llah, Page 22
- [5] Lawh-i-Maqsud (Tablet of Maqsud) in Tablets of Baha'u'llah, Pages 165-166
- [6] Lawh-i-Maqsud (Tablet of Maqsud) in Tablets of Baha'u'llah, Page 166 (also in The Proclamation of Baha'u'llah, Pages 115-116) (also in Gleanings from the Writings of Baha'u'llah, Pages 249-250)
- [7] Epistle to the Son of the Wolf, Pages 137-139
- [8] v.189. The Kitab-i-Aqdas, Page 88
- [9] 9. Notes: The Kitab-i-Aqdas, Page 163
- [10] 194. (Notes: The Kitab-i-Aqdas, Page 250
- [11] v.118. The Kitab-i-Aqdas, Page 62
- [12] Gleanings, Pages 172-174
- [13] Baha'u'llah, The King of Glory, Pages 113-114
- [14] 'Abdu'l-Baha on Divine Philosophy, Page 25
- [15] 'Abdu'l-Baha on Divine Philosophy, Page 27
- [16] 'Abdu'l-Baha on Divine Philosophy, Page 84
- [17] 'Abdu'l-Baha on Divine Philosophy, Page 141



- [18] 'Abdu'l-Baha on Divine Philosophy, Pages 143-145
- [19] 'Abdu'l-Baha on Divine Philosophy, Page 172
- [20] Selections From The Writings of 'Abdu'l-Baha, Page 32 (also in The World Order of Baha'u'llah, Page 39:2)
- [21] Selections From The Writings of 'Abdu'l-Baha, Page 66
- [22] Selections From The Writings of 'Abdu'l-Baha, Page 301 (also in Foundations of World Unity, Page 29:4)
- [23] Selections From The Writings of 'Abdu'l-Baha, Page 308:2
- [24] Paris Talks, Page 155:3-157:1
- [25] 'Abdu'l-Baha in London, Page 60
- [26] 'Abdu'l-Baha in London, Page 94
- [27] 25 April 1912, Message to Esperantists, Home of Mr. and Mrs. Arthur J. Parsons, 1700 Eighteenth Street, NW, Washington, D.C., Notes by Joseph H. Hannen, in The Promulgation of Universal Peace, Pages 60-61
- [28] 9 June 1912, Talk at Baptist Temple, Broad and Berks Streets, Philadelphia, Pennsylvania, Notes by Edna McKinney, in The Promulgation of Universal Peace, Page 182
- [29] 14 July 1912, Talk at All Souls Unitarian Church, Fourth Avenue and Twentieth Street, New York, Notes by John G. Grundy and Howard MacNutt, in The Promulgation of Universal Peace, Page 232
- [30] 1 September 1912, Talk at Church of the Messiah, Montreal, Canada, From Stenographic Notes, The Promulgation of Universal Peace, Page 300
- [31] 5 September 1912, Talk at St. James Methodist Church, Montreal, Canada, From Stenographic Notes, The Promulgation of Universal Peace, Page 318
- [32] 15 November 1912, Talk at Home of Juliet Thompson, 48 West Tenth Street, New York, Notes by Hooper Harris, in The Promulgation of Universal Peace, Page 434
- [33] 17 November 1912, Talk at Genealogical Hall, 252 West Fifty-eighth Street, New York, Notes by Edna McKinney, in The Promulgation of Universal Peace, Page 440

- [34] 'Abdu'l-Baha, HMB, Page 330
- [35] 'Abdu'l-Baha, HMB, Page 364
- [36] Tablet of 'Abdu'l-Baha to Mr. Kanithi Yamamoto January 1903 in Japan Will Turn Ablaze! Page 14 ( also in Tablets of 'Abdu'l-Baha Abbas, Vol. III, Page 559)
- [37] 'Abdu'l-Baha to Kanichi Yamamoto, Date not known in Japan Will Turn Ablaze! Page 16
- [38] To Mrs. J. D. Brittingham, October 18, 1906 in (Japan Will Turn Ablaze! Page 17
- [39] To Sensui Saiki, October 15, 1920 in Japan Will Turn Ablaze! Page 30
- [40] Tablets of 'Abdu'l-Baha, Vol. II, p. 306 (also #1143 Lights of Guidance, Page 341)
- [41] quoted from Nouveau Larousse Illustre, supplement, p. 66 in Tablets of 'Abdu'l-Baha Abbas, Vol. I., Page viii
- [42] Tablets of 'Abdu'l-Baha Abbas, Vol. III, Page 596
- [43] Tablets of 'Abdu'l-Baha, Vol. III, Page 692 (also partly in Lights of Guidance, Page 340)
- [44] God Passes By, Page 211
- [45] God Passes By, Page 215:1 (also in The Kitab-i-Aqdas, Page 15) (also in King of Glory, HMB, Page 352)
- [46] God Passes By, Pages 218:3-219
- [47] God Passes By, Page 281:1
- [48] God Passes By, Pages 333:1-334
- [49] God Passes By, Page 341:1
- God Passes By, Page 375:2
- [51] The World Order of Baha'u'llah, Page 41:3
- [52] The World Order of Baha'u'llah, Page 43:1-2

- [53] The World Order of Baha'u'llah, Page 203
- [54] 24 December 1935 in Lights of Divine Guidance, Pages 36-37
- [55] (From letter written on behalf of the Guardian to the National Spiritual Assembly of the United States and Canada, June 4, 1937: Baha'i News, No. 109, July 1937, p. 1), republished in #1140 Lights of Guidance, Page 341
- [56] (From a letter written on behalf of Shoghi Effendi to an individual believer, January 23, 1945), republished in #2033 Lights of Guidance, Pages 600-601
- [57] (From a letter written on behalf of Shoghi Effendi to an individual believer, March 16, 1946) (republished in #1141 Lights of Guidance, Page 341
- [58] (to Dr. Hermann Grossmann 29 July 1946), republished in # Lights of Divine Guidance, Vol 2, Page 53
- [58] (a letter dated December 12, 1942) in High Endeavors, Page 6
- [60] The Priceless Pearl, Page 13
- [61] The Priceless Pearl, Page 37-38 (also partly in The Guardian of the Baha'i, Page 12) [62] The Priceless Pearl, Page 207
- [63] The Priceless Pearl, Pages 271-272 (also in The Guardian of the Baha'i Faith, Page 124-125)
- [64] The Promise of World Peace, Page 106
- [65] The Promise of World Peace, Page 102
- [66] The Promise of World Peace, Page 110
- [67] Developing Distinctive Baha'i Communities, Pages 13.15-14.1
- [68] (The Universal House of Justice: From Memorandum on Baha'i Publishing -- Ridvan 1971), #348 in Lights of Guidance, Page 101
- [69] (From a letter dated 7 October 1973, written by the Universal House of Justice to a National Spiritual Assembly), #370 in Lights of Guidance, Page 108

- [70] (From a letter dated 20 September 1973 written on behalf of the Universal House of Justice to a National Spiritual Assembly), #370 in Lights of Guidance, Pages 108-109
- [71] (From a letter dated 13 March 1969 written on behalf of the Universal House of Justice to a National Spiritual Assembly), #370 in Lights of Guidance, Page 109
- [72] (From a letter written on behalf of the Universal House of Justice to the National Spiritual Assembly of Taiwan, May 22, 1984) #371 in Lights of Guidance, Page 108
- [73] (From a letter written on behalf of the Universal House of Justice to the Spiritual Assembly of Guadeloupe, May 13, 1986), #367 in Lights of Guidance, Pages 106-107
- [74] The Promise of World Peace, Pages 120-126
- [75] 193. Notes: Kitabi-Aqdas, Page 250
- [76] The Revelation of Baha'u'llah, Volume 3, Page 157
- [77] The Revelation of Baha'u'llah, Volume 4, Page 159
- [78] The Revelation of Baha'u'llah, Vol 4, Pages 159-160
- [79] The Revelation of Baha'u'llah, Vol 4, Page 160
- [80] The Revelation of Baha'u'llah, Vol 4, Page 161-162
- [81] Kalimat-i-Firdawsiyyih- in Tablets of Baha'u'llah 57-80 (also in The Revelation of Baha'u'llah, Vol 4, Page 215
- [82] The Revelation of Baha'u'llah, Vol 4, Page 341
- [83] The Revelation of Baha'u'llah, Vol 4, Page 437
- [84] Marzieh Gail in preface to Epistle to the Son of the Wolf, Page xvi
- [85] Baha'u'llah and the New Era, Page 199
- [86] Baha'u'llah and the New Era, Page 236
- [87] Baha'u'llah and the New Era, Page 280

- [88] (December 9, 1920 Tablet of 'Abdu'l-Baha to Miss Yuri Mochizuki (later Mrs. Furukawa), the first Japanese woman to become a Baha'i) in (Japan Turn Ablaze! Page 27
- [89] (From letter of the Universal House of Justice to the National Spiritual Assembly of India: June 23, 1966) (#1909 in Lights of Guidance, Page 564
- [90] Six Year Plan 143-149, 1986-1992, Universal House of Justice, February 25, 1986, Page 17 [91] A Wider Horizon, Pages 31-32
- [92] Six Year Plan 143-149, 1986-1992, Universal House of Justice, February 25, 1986, Page 16
- [93] At ST. James Church, September 5th, 'Abdu'l-Baha In Canada, Page 42
- [94] The Bab, HMB, Page 54
- [95] The Dawn-Breakers, Page 106
- [96] A Year Amongst the Persians, Page 359
- [97] Selections from the Writings of E.G. Browne, The Babi's of Persia, Page 158
- [98] Tablets of the Divine Plan, Tablet to the Baha'is of the United States and Canada, Page 31
- [98] Tablets of the Divine Plan, Tablet to the Baha'is of the Central States, Page 71
- [100] Tablets of the Divine Plan, Tablet to the Baha'is of the Central States, Page 73

**MENU:** [HOME](#) » [Reconstruction](#) » [Recovery](#) » [Renewal](#) » [Language Main Page](#)

---

---

Bibliography of Sources Used for  
**Why Baha'i Universal Auxiliary Language Institutes**

'Abdu'l-Baha In Canada, Forest Free Press, Forest, Ontario, 1962

'Abdu'l-Baha in London, *Addresses and notes of Conversations*, Baha'i Publishing Trust, London, 1982

'Abdu'l-Baha on Divine Philosophy, compiled by Isabel Fraser Chamberlain, Tudor Press, Boston, Massachusetts, 1918

'Abdu'l-Baha, The Centre of the Covenant of Baha'u'llah, by H.M. Balyuzi, George Ronald, London, 1971

The Bab: The Herald of the Day of Days, H.M. Balyuzi, George Ronald, Oxford, 1973

Baha'u'llah and the New Era, *An Introduction to the Baha'i Faith*, by J. E. Esslemont, Baha'i Publishing Trust, Wilmette, Illinois, 1980

Baha'u'llah, The King of Glory, by H.M. Balyuzi, George Ronald, Oxford, 1980

The Dawn-Breakers, *Nabil's Narrative of the Early Days of the Baha'i Revelation*, Translated from the original Persian and edited by Shoghi Effendi, Baha'i Publishing Committee, New York, 1932, 1953

Developing Distinctive Baha'i Communities, *Guidelines for Spiritual Assemblies*, Baha'i Publishing Trust, Wilmette, Illinois, 1989

Epistle to the Son of the Wolf, Translated by Shoghi Effendi, Baha'i Publishing Trust, Wilmette, Illinois, 1941

Foundations of World Unity, *Compiled from addresses and Tablets of 'Abdu'l-Baha*, Baha'i Publishing Trust, Wilmette, Illinois, 1945

Gleanings from the Writings of Baha'u'llah, Translated by Shoghi Effendi, Baha'i Publishing Trust, Wilmette, Illinois, Second Revised Edition 1976

God Passes By, by Shoghi Effendi, Baha'i Publishing Trust, Wilmette, Illinois, Seventh Printing 1974

The Guardian of the Baha'i Faith, by Ruhyyih Rabbani, Baha'i Publishing Trust, London, 1988

- High Endeavors, Messages to Alaska from Shoghi Effendi, National Assembly of the Baha'is of Alaska, 1976
- Japan Will Turn Ablaze! Tablets of 'Abdu'l-Baha, Letters of Shoghi Effendi And Historical Notes About Japan, Baha'i Publishing Trust, Japan 1974
- The Kitab-i-Aqdas, The Most Holy Book of Baha'u'llah, Baha'i World Centre, Haifa, 1992
- Lights of Divine Guidance, Baha'i-Verlag GMBH, Germany, 1985, Vol 2
- Lights of Guidance, A Baha'i Reference File, Originally compiled by Helen Bassett Hornby, copyright held by the National Spiritual Assembly of the Baha'is of Ecuador, revised post-humously, Baha'i Publishing Trust, New Delhi, India, Third Revised Edition 1994
- Paris Talks (published in the U.S. under the title The Wisdom of 'Abdu'l-Baha), Addresses given by 'Abdu'l-Baha in Paris in 1911-1912, Baha'i Publishing Trust, London, Eleventh Edition 1971
- The Priceless Pearl, by Ruhiiyyih Rabbani, Baha'i Publishing Trust, London, 1969
- The Proclamation of Baha'u'llah, Baha'i World Centre, Haifa, 1967
- The Promise of World Peace, by The Universal House of Justice, Oneworld Publications, Limassol, Cyprus, 1986
- The Promulgation of Universal Peace, Talks Delivered by 'Abdu'l-Baha: during His Visit to the United States and Canada in 1912, Compiled by Howard MacNutt, Baha'i Publishing Trust, Wilmette, Illinois, Second Edition 1982
- The Revelation of Baha'u'llah, Volume 3, Akka, The Early Years 1868-77, Adib Taherzadeh,, George Ronald, Oxford, 1983
- The Revelation of Baha'u'llah, Volume 4, Mazra'ih & Bahji 1877-92, Adib Taherzadeh,, George Ronald, Oxford, 1987
- Selections From The Writings of 'Abdu'l-Baha, Compiled by the Research Department of the Universal House of Justice, Translated by a Committee at the Baha'i World Centre and by Marzieh Gail, Baha'i World Centre, Haifa, First Edition 1978
- Selections from the Writings of E.G. Browne on the Babi and Baha'i Religions, Edited by Moojan Momen, George Ronald, Oxford, 1987

Six Year Plan 143-149, 1986-1992, of *The Universal House of Justice*, February 25, 1986

Tablets of 'Abdu'l-Baha Abbas, Baha'i Publishing Trust, Chicago, Illinois, 1909, Vol. I.-III.

Tablets of Baha'u'llah revealed after the Kitabi-i-Aqdas - Compiled by the Research Department of the Universal House of Justice and translated by Dabib Taherzadeh with the assistance of a committee at the Baha'i World Centre- Baha'i World Centre Haifa , printed in Great Britain, 1978

Tablets of the Divine Plan, *Revealed to the North American Baha'is*, Baha'i Publishing Trust, Wilmette, Illinois, 1977

A Wider Horizon, *Selected Messages of the Universal House of Justice 1983-1992*, Message of The Universal House of Justice, January 23, 1985, Palabra Publications, Compiled by Paul Lampe, Rivera Beach, Florida 1992

The World Order of Baha'u'llah, by Shoghi Effendi, Baha'i Publishing Trust, Wilmette, Illinois, 1955

A Year Amongst the Persians, *Impressions As to the Life, Character, & Thought of The People of Persia, Received during Twelve Month's Residence in that Country in the Year 1887-1888* by Edward Granville Browne, Cambridge University Press, New Edition 1926

**MENU: [HOME](#) » [Reconstruction](#) » [Recovery](#) » [Renewal](#) » [Language Main Page](#)**

---

---



Raw quotes from the Baha'i Literature for  
**Why Baha'i Universal Auxiliary Language Institutes**

[1] It is incumbent upon the Trustees of the House of Justice to take counsel together regarding those things which have not outwardly been revealed in the Book, and to enforce that which is agreeable to them. God will verily inspire them with whatsoever He willeth, and He, verily, is the Provider, the Omniscient. We have formerly ordained that people should converse in two languages, yet efforts must be made to reduce them to one, likewise the scripts of the world, that men's lives may not be dissipated and wasted in learning divers languages. Thus the whole earth would come to be regarded as one city and one land. (eighth leaf in the Kalimat-i-Firdawsiyyih (Words of Paradise) in Tablets of Baha'u'llah, Page 68)

[2] The utterances set forth therein by the Pen of the Lord of creation include the following which constitute the fundamental principles for the administration of the affairs of men: First: It is incumbent upon the ministers of the House of Justice to promote the Lesser Peace so that the people of the earth may be relieved from the burden of exorbitant expenditures. This matter is imperative and absolutely essential, inasmuch as hostilities and conflict lie at the root of affliction and calamity. Second: Languages must be reduced to one common language to be taught in all the schools of the world. (Lawh-i-Dunya (Tablet of the World) in Tablets of Baha'u'llah, Page 89)

[3] The sixth Ishraq is union and concord amongst the children of men. From the beginning of time the light of unity hath shed its divine radiance upon the world, and the greatest means for the promotion of that unity is for the peoples of the world to understand one another's writing and speech. In former Epistles We have enjoined upon the Trustees of the House of Justice either to choose one language from among those now existing or to adopt a new one, and in like manner to select a common script, both of which should be taught in all the schools of the world. Thus will the earth be regarded as one country and one home. The most glorious fruit of the tree of knowledge is this exalted word: Of one tree are all ye the fruit, and of one bough the leaves. Let not man glory in this that he loveth his country, let him rather glory in this that he loveth his kind. Concerning this We have previously revealed that which is the means of the reconstruction of the world and the unity of nations. Blessed are they that attain thereunto. Blessed are they that act accordingly. The seventh Ishraq The Pen of Glory counseleth everyone regarding the instruction and education of children. Behold that which the Will of God hath revealed upon Our arrival in the Prison City and recorded in the Most Holy Book. Unto every father hath been enjoined the instruction of his son and daughter in the art of reading and writing and in all that hath been laid down in the Holy Tablet. He that putteth away that which is commanded unto him, the Trustees are then to take from him that which is required for their instruction, if he be wealthy, and if not the matter devolveth upon the House of Justice. Verily, have We made it a shelter for the poor and needy. He that bringeth up his son or the son of another, it is as though he hath brought up a son of Mine; upon him rest My Glory, My Loving-Kindness, My Mercy, that have compassed the world. The eighth Ishraq This passage, now written by the Pen of Glory, is accounted as part of the Most Holy Book: The men of God's House of

Justice have been charged with the affairs of the people. (Ishraqat (Splendours) in Tablets of Baha'u'llah, Pages 127-128)

[4] The third Glad-Tidings concerneth the study of divers languages. This decree hath formerly streamed forth from the Pen of the Most High: It behoveth the sovereigns of the world - may God assist them - or the ministers of the earth to take counsel together and to adopt one of the existing languages or a new one to be taught to children in schools throughout the world, and likewise one script. Thus the whole earth will come to be regarded as one country. Well is it with him who hearkeneth unto His Call and observeth that whereunto he is bidden by God, the Lord of the Mighty Throne. (Bisharat (Glad-Tidings) in Tablets of Baha'u'llah, Page 22)

[5] Likewise He saith: Among the things which are conducive to unity and concord and will cause the whole earth to be regarded as one country is that the divers languages be reduced to one language and in like manner the scripts used in the world be confined to a single script. It is incumbent upon all nations to appoint some men of understanding and erudition to convene a gathering and through joint consultation choose one language from among the varied existing languages, or create a new one, to be taught to the children in all the schools of the world. (Lawh-i-Maqsud (Tablet of Maqsud) Tablets of Baha'u'llah, Pages 165-166)

[6] The day is approaching when all the peoples of the world will have adopted one universal language and one common script. When this is achieved, to whatsoever city a man may journey, it shall be as if he were entering his own home. These things are obligatory and essential. It is incumbent upon every man of insight and understanding to strive to translate that which hath been written into reality and action.... That one indeed is a man who, today, dedicateth himself to the service of the entire human race. The Great Being saith: Blessed and happy is he that ariseth to promote the best interests of the peoples and kindreds of the earth. In another passage He hath proclaimed: It is not for him to pride himself who loveth his own country, but rather for him who loveth the whole world. The earth is but one country, and mankind its citizens. The All-Knowing Physician hath His finger on the pulse of mankind. He perceiveth the disease, and prescribeth, in His unerring wisdom, the remedy. Every age hath its own problem, and every soul its particular aspiration. The remedy the world needeth in its present-day afflictions can never be the same as that which a subsequent age may require. Be anxiously concerned with the needs of the age ye live in, and centre your deliberations on its exigencies and requirements. (Lawh-i-Maqsud (Tablet of Maqsud) in Tablets of Baha'u'llah, Pages 166-167) (also partially in The Proclamation of Baha'u'llah, Pages 249-250)

[7] Our conversation turned to topics profitable to man. He said that he had learned several languages. In reply We observed: "You have wasted your life. It beseemeth you and the other officials of the Government to convene a gathering and choose one of the divers languages, and likewise one of the existing scripts, or else to create a new language and a new script to be taught children in schools throughout the world. They would, in this way, be acquiring only two languages, one their own native tongue, the other the language in which all the peoples of the world would converse. Were men to take fast hold on that which hath been mentioned, the whole earth would come to be regarded as one country, and the people would be relieved and freed from the necessity of acquiring and teaching different

languages." When in Our presence, he acquiesced, and even evinced great joy and complete satisfaction. We then told him to lay this matter before the officials and ministers of the Government, in order that it might be put into effect throughout the different countries. However, although he often returned to see Us after this, he never again referred to this subject, although that which had been suggested is conducive to the concord and the unity of the peoples of the world. We fain would hope that the Persian Government will adopt it and carry it out. At present, a new language and a new script have been devised. If thou desirest, We will communicate them to thee. Our purpose is that all men may cleave unto that which will reduce unnecessary labor and exertion, so that their days may be befittingly spent and ended. God, verily, is the Helper, the Knower, the Ordainer, the Omniscient. (Epistle to the Son of the Wolf, Pages 137-139)

[8] 189. O members of parliaments throughout the world! Select ye a single language for the use of all on earth, and adopt ye likewise a common script. God, verily, maketh plain for you that which shall profit you and enable you to be independent of others. He, of a truth, is the Most Bountiful, the All-Knowing, the All-Informed. This will be the cause of unity, could ye but comprehend it, and the greatest instrument for promoting harmony and civilization, would that ye might understand! We have appointed two signs for the coming of age of the human race: the first, which is the most firm foundation, We have set down in other of Our Tablets, while the second hath been revealed in this wondrous Book. (The Kitab-i-Aqdas, Page 88)

[9] 9. The selection of a single language and the adoption of a common script for all on earth to use: one of two signs of the maturity of the human race (Notes: The Kitab-i-Aqdas, Page 163)

[10]194. We have appointed two signs for the coming of age of the human race :PP189 The first sign of the coming of age of humanity referred to in the Writings of Baha'u'llah is the emergence of a science which is described as that "divine philosophy" which will include the discovery of a radical approach to the transmutation of elements. This is an indication of the splendours of the future stupendous expansion of knowledge. Concerning the "second" sign which Baha'u'llah indicates to have been revealed in the Kitab-i-Aqdas, Shoghi Effendi states that Baha'u'llah, ". . . in His Most Holy Book, has enjoined the selection of a single language and the adoption of a common script for all on earth to use, an injunction which, when carried out, would, as He Himself affirms in that Book, be one of the signs of the 'coming of age of the human race'". .. (Notes: The Kitab-i-Aqdas, Page 250)

[11]118. The Lord hath granted leave to whosoever desireth it that he be instructed in the divers tongues of the world that he may deliver the Message of the Cause of God throughout the East and throughout the West, that he make mention of Him amidst the kindreds and peoples of the world in such wise that hearts may revive and the mouldering bone be quickened. (The Kitab-i-Aqdas, Page 62)

[12] Moreover such forms and modes of writing as are now current amongst men were unknown to the generations that were before Adam. There was even a time when men were wholly ignorant of the art of writing, and had adopted a system entirely different from the one which they now use. For a proper exposition of this an elaborate explanation would be required. Consider the differences that have arisen since the days of Adam. The divers and widely-known languages now spoken by the peoples of the earth

were originally unknown, as were the varied rules and customs now prevailing amongst them. The people of those times spoke a language different from those now known. Diversities of language arose in a later age, in a land known as Babel. It was given the name Babel, because the term signifieth "the place where the confusion of tongues arose." Subsequently Syriac became prominent among the existing languages. The Sacred Scriptures of former times were revealed in that tongue. Later, Abraham, the Friend of God, appeared and shed upon the world the light of Divine Revelation. The language He spoke while He crossed the Jordan became known as Hebrew ('Ibrani), which meaneth "the language of the crossing." The Books of God and the Sacred Scriptures were then revealed in that tongue, and not until after a considerable lapse of time did Arabic become the language of Revelation... Witness, therefore, how numerous and far-reaching have been the changes in language, speech, and writing since the days of Adam. How much greater must have been the changes before Him! (Gleanings, Pages 172-174)

[13] Mirza Aqa Jan further related to Nabil that, one day in Kazimayn, when both he and Aqa Muhammad-Hasan-i-Isfahani were in the presence of Baha'u'llah, in the house of Haji 'Abdu'l-Majid-i-Shirazi, He asked the host whether he wished to hear the Badi' (Unique) language, which, He said, was the language used by the denizens of one of the worlds of God. He then proceeded to chant in that language. Mirza Aqa Jan said that hearing this language had a wonderful effect on the listener. One day, Mirza Aqa Jan related, Baha'u'llah said to Haji 'Abdu'l-Majid: 'Haji, you have heard the Badi' language, and witnessed God's supremacy over His worlds. Render thanks for this bounty and appreciate its worth.' (Baha'u'llah, The King of Glory, Page 113-114)

[14] The sixth is the universal auxiliary language. ('Abdu'l-Baha on Divine Philosophy, Page 25)

[15] 6. A UNIVERSAL LANGUAGE A universal language shall be adopted and taught in the schools and academies of the world. A committee appointed by national bodies shall select a suitable language to be used as a means of international communication. Every one will need but two languages, his national tongue and the universal language. All will acquire the international language. ('Abdu'l-Baha on Divine Philosophy, Page 27)

[16] "In order to facilitate complete understanding between all people, a universal auxiliary language will be adopted and in the schools of the future two languages will be taught--the mother tongue and this international auxiliary tongue which will be either one of the existing languages, or a new language made up of words from all the languages--the matter to be determined by a confederation met for the purpose which shall represent all tribes and nations. This international tongue will be used in the work of the parliament of man--a supreme tribunal of the world which will be permanently established in order to arbitrate international questions. . ('Abdu'l-Baha on Divine Philosophy, Page 84)

[17] His Excellency ABDUL BAHHA, addressed the Paris Esperanto group on February 12, 1913, at a banquet which was accorded him at the Hotel Moderne in that city. M. Bourlet, President of the Paris Esperanto Society, in introducing Abdul Baha, said that one of the principles of the great world religion which he was promulgating, was the establishment of a universal language. ('Abdu'l-Baha on Divine Philosophy, Page 141)

[18] The universal light for this planet is from the sun and the special electric ray which to-night illumines this banquet hall appears through the invention of man. In like manner the activities which are trying to establish solidarity between the nations and infuse the spirit of universalism in the hearts of the children of men are like unto divine rays from the sun of reality and the brightest ray is the coming of the universal language. Its achievement is the greatest virtue of the age for such an instrument will remove misunderstandings from amongst the peoples of the earth and will cement their hearts together. This medium will enable each individual member of the human family to be informed of the scientific accomplishments of all. The basis of knowledge and the excellencies of endeavor in this world are to teach and to be taught. To acquire sciences, and to teach them in turn, depends upon language, and when the international auxiliary tongue becomes universal it is easily conceivable that the acquirement of knowledge and instruction will likewise become universal. No doubt you are aware that in the past ages a common language shared by various nations created a spirit of solidarity amongst them. For instance, thirteen hundred years ago there were many divergent nationalities in the Orient. There were Copts in Egypt, Syrians in Syria, Assyrians and Babylonians in Bagdad and along the rivers of Mesopotamia. There existed among these peoples rank hatred; but as they were gradually brought nearer through common protection and common interests, the Arabic language grew to be the means of intercommunication and they became as one nation. They all speak Arabic to this day. In Syria, if you ask any one of them, he will say, "I am an Arab," though he be a Greek, an Egyptian, Syrian or Jew. Today one of the chief causes of the differences in Europe is the diversity of languages. We say "this man is a German, the other an Italian, a Frenchman, an Englishman," etc. All belong to the great human family yet language is the barrier between them. The greatest working basis for bringing about unity and harmony amongst the nations is the teaching of a universal tongue. Writing on this subject fifty years ago, His Holiness BAHÁ'O'LLAH declared that complete union between the various nations of the world would remain an unrealized dream until an international language was established. Misunderstandings keep people from mutual association and these misunderstandings will not be dispelled except through the medium of a common ground of communication. Every intelligent man will bear testimony to this. The people of the Orient are not fully informed of the events in the west and the west cannot put itself into sympathetic touch with the east. Their thoughts are enclosed in a casket. The universal language will be the master key to open it. Western books will be translated into that language and the east will become informed of the contents; likewise eastern lore will become the property of the west. Thus also will those misunderstandings which exist between the different religions be dispersed. Religious prejudices play havoc among the peoples and bring about warfare and strife and it is impossible to remove them without a common medium. I am an Oriental and on this account I am shut out from your thoughts and you likewise from mine. A mutual language will become the mightiest means toward universal progress, for it will cement the east and the west. It will make the world one home and become the divine impulse for human advancement. It will upraise the standard of oneness of the world of humanity and make the earth a universal commonwealth. It will create love between the children of men and good fellowship between the various creeds. Praise be to God, that Dr. Zamenhof has constructed the Esperanto language. It has all the potential qualities of universal adoption. All of us must be grateful and thankful to him for his noble effort, for in this matter he has served his fellow-man well. He has done a service which will bestow divine benefits on all peoples. With untiring effort and self-sacrifice on the part of its devotees it holds a promise of universal acceptance. Therefore every one of us must study this language and make every effort to spread it, so that each day it may receive a wider recognition, be accepted by all nations

and governments of the world and become a part of the curriculum of all the public schools. I hope that the business of the future international conferences and congresses will be carried on in Esperanto. In the coming ages, two languages will be taught in the schools, one the native tongue, the other an international auxiliary language. Consider today how difficult is human communication. One may study fifty languages and travel through a country and still be at a loss. I myself speak several Oriental languages, but know no western tongue. Had this universal language pervaded the globe, I should have studied it and you would have been directly informed of my thoughts and I of yours and a special friendship would have been established between us. Please send some teachers to Persia so that they may teach Esperanto to the younger generation. I have written asking some of them to come here to study it. May it be promulgated rapidly; then the world of humanity will find eternal peace; all the nations will associate with one another like mothers and sisters, fathers and brothers, and each individual member of the community will be fully informed of the thoughts of all. I am extremely grateful to you and thank you for these lofty efforts, for you have gathered at this banquet in a selfless endeavor to further this great end. Your hope is to render a mighty service to the world of humanity and for this exalted aim I congratulate you from the depths of my heart. ( 'Abdu'l-Baha on Divine Philosophy, Pages 143-145)

[19] One sign of unity is the construction of an international auxiliary language, Esperanto. Let us strive untiringly to spread this language. ( 'Abdu'l-Baha on Divine Philosophy, Page 172)

[20] The seventh candle is unity of language, i.e., the choice of a universal tongue in which all peoples will be instructed and converse. Each and every one of these will inevitably come to pass, inasmuch as the power of the Kingdom of God will aid and assist in their realization. (Selections From The Writings of 'Abdu'l-Baha, Page 32) (also in The World Order of Baha'u'llah, Page 39:2)

[21] Regarding the translation of the Books and Tablets of the Blessed Beauty, ere long will translations be made into every tongue, with power, clarity and grace. At such time as they are translated, conformably to the originals, and with power and grace of style, the splendours of their inner meanings will be shed abroad, and will illumine the eyes of all mankind. Do thy very best to ensure that the translation is in conformity with the original. (Selections From The Writings of 'Abdu'l-Baha, Page 66)

[22] And among the teachings of His Holiness Baha'u'llah is the origination of one language that may be spread universally among the people. This teaching was revealed from the pen of Baha'u'llah in order that this universal language may eliminate misunderstandings from among mankind. (Selections From The Writings of 'Abdu'l-Baha, Page 301) (also in Foundations of World Unity, Page 29:4)

[23] As to the Esperantists, associate with them. ... It is evident that the Esperantists are receptive and thou art familiar with and expert in their language. Communicate also with the Esperantists of Germany and other places. The literature which thou circulatest should deal only with the teachings. The dissemination of other literature is at present not advisable. My hope is that the divine confirmations may continually assist thee.... Grieve not over the apathy and coldness of the Hague meeting. Put thy trust in God. Our hope is that among the people the Esperanto language may hereafter have a powerful effect. Thou hast now sown the seed. Assuredly it will grow. Its growth dependeth upon God. (Selections From The Writings of 'Abdu'l-Baha, Page 308:2)

[24] One of the great steps towards universal peace would be the establishment of a universal language. Baha'u'llah commands that the servants of humanity should meet together, and either choose a language which now exists, or form a new one. This was revealed in the Kitab-i-Aqdas forty years ago. It is there pointed out that the question of diversity of tongues is a very difficult one. There are more than eight hundred languages in the world, and no person could acquire them all. The races of mankind are not isolated as in former days. Now, in order to be in close relationship with all countries it is necessary to be able to speak their tongues. A universal language would make intercourse possible with every nation. Thus it would be needful to know two languages only, the mother tongue and the universal speech. The latter would enable a man to communicate with any and every man in the world! A third language would not be needed. To be able to talk with a member of any race and country without requiring an interpreter, how helpful and restful to all! Esperanto has been drawn up with this end in view: it is a fine invention and a splendid piece of work, but it needs perfecting. Esperanto as it stands is very difficult for some people. An international Congress should be formed, consisting of delegates from every nation in the world, Eastern as well as Western. This Congress should form a language that could be acquired by all, and every country would thereby reap great benefit. Until such a language is in use, the world will continue to feel the vast need of this means of intercourse. Difference of speech is one of the most fruitful causes of dislike and distrust that exists between nations, which are kept apart by their inability to understand each other's language more than by any other reason. If everybody could speak one language, how much more easy would it be to serve humanity! Therefore appreciate 'Esperanto', for it is the beginning of the carrying out of one of the most important of the Laws of Baha'u'llah, and it must continue to be improved and perfected. (Paris Talks, Pages 155:3-157:1)

[25] The causes of dispute among different nations are always due to one of the following classes of prejudice: racial, lingual, theological, personal, and prejudices of custom and tradition.... The differences in language cause disunion between nations. There must be one universal language. (Abdu'l-Baha in London, Page 60)

[26] A friend enquired concerning Baha'u'llah's prophecy in the Words of Paradise, that a universal language would be formed, and desired to know if Esperanto would be the language chosen. "The love and effort put into Esperanto will not be lost," he answered, "but no one person can construct a Universal Language. It must be made by a Council representing all countries, and must contain words from different languages. It will be governed by the simplest rules, and there will be no exceptions; neither will there be gender, nor extra and silent letters. Everything indicated will have but one name. In Arabic there are hundreds of names for the camel! In the schools of each nation the mother tongue will be taught, as well as the revised Universal Language." ('Abdu'l-Baha in London, Page 94)

[27] TODAY the greatest need of the world of humanity is discontinuance of the existing misunderstandings among nations. This can be accomplished through the unity of language. Unless the unity of languages is realized, the Most Great Peace and the oneness of the human world cannot be effectively organized and established because the function of language is to portray the mysteries and secrets of human hearts. The heart is like a box, and language is the key. Only by using the key can we open the box and observe the gems it contains. Therefore, the question of an auxiliary international tongue

has the utmost importance. Through this means international education and training become possible; the evidence and history of the past can be acquired. The spread of the known facts of the human world depends upon language. The explanation of divine teachings can only be through this medium. As long as diversity of tongues and lack of comprehension of other languages continue, these glorious aims cannot be realized. Therefore, the very first service to the world of man is to establish this auxiliary international means of communication. It will become the cause of the tranquility of the human commonwealth. Through it sciences and arts will be spread among the nations, and it will prove to be the means of the progress and development of all races. We must endeavor with all our powers to establish this international auxiliary language throughout the world. It is my hope that it may be perfected through the bounties of God and that intelligent men may be selected from the various countries of the world to organize an international congress whose chief aim will be the promotion of this universal medium of speech. (The Promulgation of Universal Peace, Pages 60-61) (also partially in #1138 Lights of Guidance, Page 340)

[28] Eighth, education is essential, and all standards of training and teaching throughout the world of mankind should be brought into conformity and agreement; a universal curriculum should be established, and the basis of ethics be the same. Ninth, a universal language shall be adopted and be taught by all the schools and institutions of the world. A committee appointed by national bodies of learning shall select a suitable language to be used as a medium of international communication. All must acquire it. This is one of the great factors in the unification of man. (The Promulgation of Universal Peace, Page 182)

[29] Diversity of languages has been a fruitful cause of discord. The function of language is to convey the thought and purpose of one to another. Therefore, it matters not what language man speaks or employs. Sixty years ago Baha'u'llah advocated one language as the greatest means of unity and the basis of international conference. He wrote to the kings and rulers of the various nations, recommending that one language should be sanctioned and adopted by all governments. According to this each nation should acquire the universal language in addition to its native tongue. The world would then be in close communication, consultation would become general, and dissensions due to diversity of speech would be removed. (The Promulgation of Universal Peace, Page 232)

[30] Baha'u'llah has proclaimed the adoption of a universal language. A language shall be agreed upon by which unity will be established in the world. Each person will require training in two languages: his native tongue and the universal auxiliary form of speech. This will facilitate intercommunication and dispel the misunderstandings which the barriers of language have occasioned in the world. All people worship the same God and are alike His servants. When they are able to communicate freely, they will associate in friendship and concord, entertain the greatest love and fellowship for each other, and in reality the Orient and Occident will embrace in unity and agreement. The world is in greatest need of international peace. Until it is established, mankind will not attain composure and tranquility. (The Promulgation of Universal Peace, Page 300)

[31] Eleventh, one language must be selected as an international medium of speech and communication. Through this means misunderstandings will be lessened, fellowship established and unity assured. These are a few of the principles proclaimed by Baha'u'llah. He has provided the remedy for the ailments which



now afflict the human world, solved the difficult problems of individual, social, national and universal welfare and laid the foundation of divine reality upon which material and spiritual civilization are to be founded throughout the centuries before us. Praise be to God ! I find these two great American nations highly capable and advanced in all that appertains to progress and civilization. These governments are fair and equitable. The motives and purposes of these people are lofty and inspiring. Therefore, it is my hope that these revered nations may become prominent factors in the establishment of international peace and the oneness of the world of humanity; that they may lay the foundations of equality and spiritual brotherhood among mankind; that they may manifest the highest virtues of the human world, revere the divine lights of the Prophets of God and establish the reality of unity so necessary today in the affairs of nations. (The Promulgation of Universal Peace, Page 318)

[32] Baha'u'llah has announced the necessity for a universal language which shall serve as a means of International communication and thus remove misunderstandings and difficulties. This teaching is set forth in the Kitab-i-Aqdas ("Most Holy Book") published fifty years ago. He has also proclaimed the principle that all mankind shall be educated and that no illiteracy be allowed to remain. This practical remedy for the need of the world cannot be found in the text of any other sacred Books. He teaches that it is incumbent upon all mankind to become fitted for some useful trade, craft or profession by which subsistence may be assured, and this efficiency is to be considered as an act of worship. The teachings of Baha'u'llah are boundless and without end in their far-reaching benefit to mankind. The point and purpose of our statement today is that they are new and that they are not found in any of the religious Books of the past. This is in answer to the question, "What has Baha'u'llah brought that we have not heard before?" Therefore, it is conclusive and evident that the Manifestation of God in this day is distinguished from all former appearances and revelations by His majesty, His power and the efficacy and application of His Word. (The Promulgation of Universal Peace, Page 434)

[33] His teachings, which embody the divine spirit of the age and are applicable to this period of maturity in the life of the human world, are: The oneness of the world of humanity The protection and guidance of the Holy Spirit The foundation of all religion is one Religion must be the cause of unity Religion must accord with science and reason Independent investigation of truth Equality between men and women The abandoning of all prejudices among mankind Universal peace Universal education A universal language Solution of the economic problem An international tribunal. Everyone who truly seeks and justly reflects will admit that the teachings of the present day emanating from mere human sources and authority are the cause of difficulty and disagreement amongst mankind, the very destroyers of humanity, whereas the teachings of Baha'u'llah are the very healing of the sick world, the remedy for every need and condition. In them may be found the realization of every desire and aspiration, the cause of the happiness of the world of humanity, the stimulus and illumination of mentality, the impulse for advancement and uplift, the basis of unity for all nations, the fountain source of love amongst mankind, the center of agreement, the means of peace and harmony, the one bond which will unite the East and the West. After every night there is a morn. (The Promulgation of Universal Peace, Page 440)

[34] Religion must be the cause of unity. Religion must accord with science and reason. Independent investigation of truth. Equality between men and women. The abandoning of all prejudices among mankind. Universal peace. Universal education. A universal language. Solution of the economic

problem. An international tribunal. ('Abdu'l-Baha, HMB, Page 330)

[35] 'Abdu'l-Baha's address was chiefly concerned with an auxiliary international language. Sir Patrick Geddes spoke afterwards to propose a vote of thanks. ('Abdu'l-Baha, HMB Page 364)

[36] Verily, I pray my Lord to teach thee a language and writing of the Kingdom which will satisfy thee, so as to dispense with all things; for that spiritual writing and instructive tongue are eloquent, clear, laudable, legible, read by the tongue and preserved in the heart. Blessed is he who knows it in the world of man! (Tablet of Abdu'l-Baha to Mr. Kanithi Yamamoto January 1903 in Japan Will Turn Ablaze! Page 14) (also in Tablets of 'Abdu'l-Baha Abbas, Vol. III Page 559)

[37] Endeavor as much as thou canst to acquire the English language with the utmost eloquence and excellence, so that thou mayest be enabled to translate the Tablets into the Japanese tongue. This is my advice. Certainly exert thy utmost endeavor to attain this bounty. (To Kanichi Yamamoto, Date not known in Japan Will Turn Ablaze! Page 16)

[38] The Japanese youth, K. Yamamoto ... must acquire the English language well, so as to enable him to translate the Divine Tablets into the Japanese language. (To Mrs. J. D. Brittingham, October 18, 1906 in Japan Will Turn Ablaze! Page 17)

[39] Thou hast taken much pain in inventing the new Japanese writing. Thou hast rendered a service to the world of humanity -- May God reward thee! Today, however, there exist many kinds of writing. That which is more necessary and is assisted by divine confirmations is the propagation of the heavenly Call. It is this which bestoweth life unto the dead souls, which refresheth the dried tree and ornamenteth it with leaves, blossoms and fruits. Concentrate all thine energy in this that thou mayest make heavenly progress, that thou mayest attain to the light of the Sun of Reality... This is most important! (To Sensui Saiki, October 15, 1920 in Japan Will Turn Ablaze! Page 30)

[40] "Acquire the Persian tongue, so as to learn of the meanings of the Divine words and to know the Divine mysteries, to develop an eloquent speech and to translate the blessed Tablets of Baha'u'llah. The Persian language shall become noteworthy in this cycle; nay, rather, the people shall study it in all the world." (Tablets of 'Abdu'l-Baha, Vol. II, Page 306) (also in Lights of Guidance, Page 340-341)

[41] Questions not treated of are left to the civil law of each country, and to the decisions of the Bait-ul-Adl, or House of Justice, instituted by Baha'o'llah. Respect toward the head of the State is part of respect toward God. A universal language, and the creation of tribunals of arbitration between nations, are to suppress wars. "You are all leaves of the same tree, and drops of the same sea," Baha'o'llah has said. Briefly, it is not so much a new religion as Religion renewed and unified, which is directed today by Abdul-Baha.-- (quoted from Nouveau Larousse Illustré, supplement, p. 66 in Tablets of 'Abdu'l-Baha Abbas, Vol. I. Page viii)

[42] But regarding the universal language: Ere long significant and scientific discussions concerning this

matter will arise among the people of discernment and insight and it will produce the desired result. (Tablets of 'Abdu'l-Baha Vol. III Page 596)

[43] "Thou hast written regarding to language of Esperanto. This language will be spread and universalized to a certain degree, but later on a language more complete than this, or the same language will undergo some changes and alterations and will be adopted and become universal. I hope that Dr, Zamenhof, become assisted by the invisible confirmation and do a great service to the world of humanity." (Tablets of 'Abdu'l-Baha, Vol. III Page. 692)

[44] Some of the weightiest passages of His Epistle to Queen Victoria are addressed to the members of the British Legislature, the Mother of Parliaments, as well as to the elected representatives of the peoples in other lands. In these He asserts that His purpose is to quicken the world and unite its peoples; refers to the treatment meted out to Him by His enemies; exhorts the legislators to "take counsel together," and to concern themselves only "with that which profiteth mankind"; and affirms that the "sovereign remedy" for the "healing of all the world" is the "union of all its peoples in one universal Cause, one common Faith," which can "in no wise be achieved except through the power of a skilled and all-powerful and inspired Physician." He, moreover, in His Most Holy Book, has enjoined the selection of a single language and the adoption of a common script for all on earth to use, an injunction which, when carried out, would, as He Himself affirms in that Book, be one of the signs of the "coming of age of the human race." (God Passes By, Page 211)

[45] The significant summons issued to the Presidents of the Republics of the American continent to seize their opportunity in the Day of God and to champion the cause of justice; the injunction to the members of parliaments throughout the world, urging the adoption of a universal script and language; (God Passes By, Page 215:1) (The Kitab-i-Aqdas, Page 15) (King of Glory, by HMB Page 352)

[46] The injunction to "consort with all men in a spirit of friendliness and fellowship" He further emphasizes, and recognizes such association to be conducive to "union and concord," which, He affirms, are the establishers of order in the world and the quickeners of nations. The necessity of adopting a universal tongue and script He repeatedly stresses; deplores the waste of time involved in the study of divers languages; affirms that with the adoption of such a language and script the whole earth will be considered as "one city and one land"; and claims to be possessed to the knowledge of both, and ready to impart it to any one who might seek it from Him. To the trustees of the House of Justice He assigns the duty of legislating on matters not expressly provided in His writings, and promises that God will "inspire them with whatsoever He willeth." (God Passes By, Pages 218:3-219)

[47] ... that `Abdu'l-Baha expounded, with brilliant simplicity, with persuasiveness and force, and for the first time in His ministry, those basic and distinguishing principles of His Father's Faith, which together with the laws and ordinances revealed in the Kitab-i-Aqdas constitute the bed-rock of God's latest Revelation to mankind. ...the adoption of a universal auxiliary language; (God Passes By, Page 281:1)

[48] The mere enumeration of the national committees which, originating mostly in the West and functioning with exemplary efficiency in the United States and Canada, now carry on their activities with

a vigor and a unity of purpose which sharply contrast with the effete institutions of a moribund civilization, would suffice to reveal the scope of these auxiliary institutions which an evolving Administrative Order, still in the secondary stage of its development, has set in motion:... the International Auxiliary Language Committee; (God Passes By, Pages 333:1-334)

[49] They include, moreover, "study days" held in Baha'i homes and centers, classes for the study of Esperanto and other languages, ... (God Passes By, Page 341:1)

[50] In 1920," is the declaration made in his testament by the distinguished Swiss scientist and psychiatrist, Doctor Auguste Forel, "I learned at Karlsruhe of the supraconfessional world religion of the Baha'is founded in the Orient seventy years ago by a Persian, Baha'u'llah. This is the real religion of 'Social Welfare' without dogmas or priests, binding together all men of this small terrestrial globe of ours. I have become a Baha'i. May this religion live and prosper for the good of humanity! This is my most ardent desire." "There is bound to be a world state, a universal language, and a universal religion," he, moreover has stated, "The Baha'i Movement for the oneness of mankind is, in my estimation, the greatest movement today working for universal peace and brotherhood." (God Passes By, Page 375:2)

[51] This Faith, Shoghi Effendi wrote, "does not ignore, nor does it attempt to suppress, the diversity of ethnical origins, of climate, of history, of language and tradition, of thought and habit, that differentiate the peoples and nations of the world." (The World Order of Baha'u'llah, Page 41:3)

[52] It calls for no less than the reconstruction and the demilitarization of the whole civilized world--a world organically unified in all the essential aspects of its life, its political machinery, its spiritual aspiration, its trade and finance, its script and language, and yet infinite in the diversity of the national characteristics of its federated units. It represents the consummation of human evolution--an evolution that has had its earliest beginnings in the birth of family life, its subsequent development in the achievement of tribal solidarity, leading in turn to the constitution of the city-state, and expanding later into the institution of independent and sovereign nations. (The World Order of Baha'u'llah, Page 43:1-2)

[53] A world metropolis will act as the nerve center of a world civilization, the focus towards which the unifying forces of life will converge and from which its energizing influences will radiate. A world language will either be invented or chosen from among the existing languages and will be taught in the schools of all the federated nations as an auxiliary to their mother tongue. A world script, a world literature, a uniform and universal system of currency, of weights and measures, will simplify and facilitate intercourse and understanding among the nations and races of mankind. In such a world society, (The World Order of Baha'u'llah, Page 203)

[54] As to your suggestion regarding a more widespread use of the Esperanto among the Baha'is as a medium of correspondence. Shoghi Effendi, as you know, has been invariably encouraging the believers, both in the East and in the West, to make an intensive study of that language, and to consider it as an important medium for the spread of the Cause in international circles. He has been specially urging the friends to have the Cause well represented in all Esperanto Congresses and associations, and by this

means cultivate greater friendship and cooperation between them and the Esperantists. But in this connection, he feels, he must make it clear that although the Cause views with much sympathy and appreciation the activities which the Esperantists are increasingly initiating for the spread of their language, yet it considers that the adoption of the Esperanto by the entire world is by no means an inevitable fact. Neither Baha'u'llah, nor even 'Abdu'l-Baha, ever stated that Esperanto will be the international auxiliary language. The Master simply expressed the hope that it may, provided certain conditions were fulfilled, develop into such a medium. 24 December 1935 ( Lights of Divine Guidance, Vol 2 Pages 36-37)

[55] #1140. "Regarding the subject of Esperanto; it should be made clear to the believers that while the teaching of that language has been repeatedly encouraged by 'Abdu'l-Baha, there is no reference either from Him or from Baha'u'llah that can make us believe that it will necessarily develop into the international auxiliary language of the future. Baha'u'llah has specified in His writing that such a language will have either to be chosen from one of the existing languages, or an entirely new one should be created to serve as a medium of exchange between nations and peoples of the world. Pending this final choice, the Baha'is are advised to study Esperanto only in consideration of the fact that the learning of this language can facilitate inter-communication between individuals, groups and Assemblies throughout the Baha'i world in the present stage of the evolution of the Faith." (From letter written on behalf of the Guardian to the National Spiritual Assembly of the United States and Canada, June 4, 1937: Baha'i News, No. 109, July 1937, Page. 1) (republished in Lights of Guidance, Page 341)

[56] #2033. The Teacher Should Use Whatever Method of Expression That Will Attract the Listener "English is, compared to Latin and oriental languages, lacking (as spoken in daily use) in flowery terms, and the Guardian feels that in teaching you should always use whatever method will most attract your hearers. If such term as 'The Glory of god' are not suited to certain individuals' mentality you should refrain from using them until they draw really close to the spirit of the Cause. The teaching is of primary, the words of secondary importance." (From a letter written on behalf of Shoghi Effendi to an individual believer, January 23, 1945) (Lights of Guidance, Pages 600-601)

[57] #1141. The Present Need of An Auxiliary Language "What Baha'u'llah is referring to in the Eighth Leaf of the Exalted Paradise is a far distant time, when the world is really one country, and one language would be a sensible possibility. It does not contradict His instruction as to the need immediately for an auxiliary language. (From a letter written on behalf of Shoghi Effendi to an individual believer, March 16, 1946) (Lights of Guidance, Page 341 )

[58] 29 July 1946 - He feels that the subject of the Baha'i work in Esperanto in Germany is a matter for you to take up with the National Spiritual Assembly; we Baha'is do not claim Esperanto will be the auxiliary language of the future--but as we firmly believe in the necessity of an auxiliary language we are glad to support this work by publishing books in Esperanto and encouraging the Baha'is to learn it, if they wish to. Cooperation with this society is an excellent means of spreading the Cause, as Martha Root demonstrated in her travels. However, all details in this matter must be decided by the N.S.A. You can contact Baha'i Esperantists in England and the U.S.A. through their respective N.S.A.s. (to Dr. Hermann Grossmann 29 July 1946, in Lights of Divine Guidance, Vol 2 Page 53)

[59] He would not advise you to teach them Esperanto, as we have no way of knowing whether it will ultimately be chosen as the auxiliary language of the world. He thinks the most direct and quickest way of communicating with them in a common tongue should be chosen; in other words either you should learn their language or they yours, whichever will yield the quickest results. (a letter dated December 12, 1942) (High Endeavors, Page 6)

[60] There followed another long pause, then the Master turned again to me and said: "At the present time the British Empire is the greatest and is still expanding and its language is a world language. (The Priceless Pearl, Page 12)

[61] From his Beirut days until practically the end of his life Shoghi Effendi had the habit of writing vocabularies and typical English phrases in notebooks. Hundreds of words and sentences have been recorded and these clearly indicate the years of careful study and he put into mastering a language he loved and revelled in. For him there was no second to English. He was a great reader of King James version of the Bible, and of the historians Carlyle and Gibbon, whose style he greatly admired, particularly that of Gibbon whose Decline and Fall of the Roman Empire Shoghi Effendi was so fond of that I never remember his not having a volume of it near him in his small room and usually with him when he travelled. There was a small Everyman's copy of part of it next to his bed when he died. It was his own pet bible of the English language and often he would read to me excerpts from it, interrupting himself with exclamations such as "Oh what style; what a command of English; what rolling sentences; listen to this." With his beautiful voice and pronunciation - in the direction of what we call an "Oxford accent", but no exaggeratedly so - the words fairly glowed with colour and their value and meaning came out like shining jewels. (The Priceless Pearl, Page 37-38) Also partly in (The Guardian, Page 12)

[62] In addition to this he devoted much attention, during the early years of his Guardianship, when Esperanto was rapidly spreading, particularly in Europe, to encouraging the publication of a Baha'i Esperanto Gazette, explaining to its editor that his interest was due to "my great desire to promote in such parts of the Baha'i world as present circumstances permit the study of an international language". (The Priceless Pearl, Page 207)

[63] In addition to these personal relationships Shoghi Effendi had far more contact with certain non-Baha'i organizations than is commonly supposed. This was particularly true of the Esperantists, whose whole object was to bring about the fulfilment of the Baha'i principle that a universal auxiliary language must be adopted in the interests of World Peace. We have copies of his personal messages to the Universal Congress of Esperantists held in 1927, 1928, 1929, 1930 and 1931, and he no doubt sent many messages of a similar nature at other times. Shoghi Effendi not only responded warmly when there was any overture made to him, but often took the initiative himself in sending Baha'i representatives, chosen by him, to various conferences whose interests coincided with those of the Baha'is. We thus find him writing to the Universal Esperantist Association, in 1927, that Martha Root and Julia Goldman will attend their Danzig Congress as official Baha'i representatives, and that he trusts "will serve to strengthen the ties of fellowship that bind the Esperantists and the followers of Baha'u'llah, one of whose cardinal principles . . . is the adoption of an international auxiliary language for all humanity." In his letter

addressed to the delegates and friends attending this nineteenth Universal Congress of Esperantists he writes: My dear fellow workers in the service of humanity, I take great pleasure in addressing you and wishing you . . . from all my heart the fullest success in the work you are doing for the promotion of the good of humanity. It will interest you, I am sure, to learn that as the result of the repeated and emphatic admonitions of 'Abdu'l-Baha His many followers even in the most distant villages and hamlets of Persia, where the light of Western civilization has hardly penetrated as yet, as well as in other lands throughout the East, are strenuously and enthusiastically engaged in the study and teaching of Esperanto, for whose future they cherish the highest hopes . . . (The Priceless Pearl, Pages 271-272) also in (The Guardian, Pages 124-125)

[64] A fundamental lack of communication between peoples seriously undermines efforts towards world peace. Adopting an international auxiliary language would go far to resolving this problem and necessitates the most urgent attention. (The Promise of World Peace, Page 106)

[65] In keeping with the requirements of the times, consideration should also be given to teaching the concept of world citizenship as part of the standard education of every child. (The Promise of World Peace, Page 102)

[66] Two points bear emphasizing in all these issues. One is that the abolition of war is not simply a matter of signing treaties and protocols; it is a complex task requiring a new level of commitment to resolving issues not customarily associated with the pursuit of peace. (The Promise of World Peace, Page 110)

[67] One out of every five adult Americans is functionally illiterate, meaning that they cannot read newspapers, recipes or fill out job applications. There are literacy councils and community colleges which will send literacy teachers to classes organized by the Baha'is. (Developing Distinctive Baha'i Communities, Pages 13.15-14.1)

[68] #348 ... "Baha'i authors may submit their works for review to any National Spiritual Assembly, and may send their works, once approved, to any publisher they like, Baha'i or non-Baha'i, at home or abroad. It should be remembered, however, that the approval should be given by the National Spiritual Assembly of the country where the work is to be first published. And in the case of a nonBaha'i publisher the author should insist on use of the system of transliteration at present used by the Faith for languages employing the Roman alphabet. "It is hoped that Baha'i authors will provide a constant stream of new works. Introductory books, commentaries, dissertations on various aspects of the Revelation, text books, histories, reviews, audio-visual material are all needed to stimulate study of the Faith and to promote the vital teaching work." (The Universal House of Justice: From Memorandum on Baha'i Publishing -- Ridvan 1971) (Lights of Guidance, Page 101)

[69] The Universal House of Justice, in response to your letter of 20 April concerning translations into French or Creole using simpler words than the original text, has requested us to send the following three quotations. These make it clear that a quotation in English may be rendered into simple English in order to facilitate its translation into another language or dialect. However, it is not permissible to publish

simplifications and paraphrased extracts of Baha'i Writings as Baha'i Scripture. "We have noticed a tendency in a number of countries to attempt to translate Baha'i literature into the current, easy, everyday language of the country. This, however, should not be an overriding consideration. Many of the Tablets of Baha'u'llah and 'Abdu'l-Baha are in exalted and highly poetic language in the original Persian and Arabic and you will see, for example, that when translating Baha'u'llah's Writings into English the beloved Guardian did not use present-day colloquial English but evolved a highly poetic and beautiful style, using numbers of archaic expressions reminiscent of the translations of the Bible." (From a letter dated 7 October 1973, written by the Universal House of Justice to a National Spiritual Assembly) (#370 Lights of Guidance, Page 108)

[70] "Obviously teaching literature and books about the Faith can be written in Simple English. However, we feel that when the Sacred Writings are published the standard English translation should be used, but there would be no objection to printing alongside it the translation into Simple English which should be described as a paraphrase of the Holy Word. Thus, for the people of ... who have difficulty in comprehending standard English, the simple English version would be in the nature of an explanation of the Writings which they could understand. In the case of teaching literature in which quotations from the Writings appear, these could either be paraphrased or a simple English version could be used with the standard version printed as a footnote. This method would also provide a means whereby the people of ... could improve their knowledge and understanding of the English language." (From a letter dated 20 September 1973 written on behalf of the Universal House of Justice to a National Spiritual Assembly) (#370 Lights of Guidance, Pages 108-109 )

[71] "...It is, of course, permissible to translate Baha'i Writings into other languages and dialects of languages. It is also possible to simplify or paraphrase the Baha'i Writings in order to facilitate their translation into languages and dialects having small vocabularies. However, it is not permissible to publish simplifications and paraphrases of Baha'i Writings as Baha'i Scripture." (From a letter dated 13 March 1969 written on behalf of the Universal House of Justice to a National Spiritual Assembly) (#370 Lights of Guidance, Page 109)

[72] "The Universal House of Justice has requested us to advise you to base your translations on current editions of all the books referred to, if translation is involved. In each instance you should consult the original publisher and obtain a copy of the latest printing or edition to ensure that all approved corrections are embodied in your translation." (From a letter written on behalf of the Universal House of Justice to the National Spiritual Assembly of Taiwan, May 22, 1984) (#371 Lights of Guidance, Page 109)

[73] "The National Spiritual Assembly which undertake the translation, usually through a committee of Baha'i translators, is the body which "authorizes" the translation, if it is approved. In some instances, if there are no Baha'i translators available, there is no objection, in principle, to employing non-Baha'is for this purpose. It is usual for the National Spiritual Assembly to appoint a Reviewing Committee, or establish some means of providing review of the completed translation. You will note from the enclosed memorandum that, with the exceptions enumerated therein, new translations of the Sacred Text into languages other than English must be made from the Guardian's English translation where it exists; and when no such translation exists, advice should be sought from the Universal House of Justice. (From a



letter written on behalf of the Universal House of Justice to the Spiritual Assembly of Guadeloupe, May 13, 1986) (#367 Lights of Guidance, Pages 106-107)

[74] In the Baha'i view, recognition of the oneness of mankind "calls for no less than the reconstruction and the demilitarization of the whole civilized world--a world organically unified in all the essential aspects of its life, its political machinery, its spiritual aspiration, its trade and finance, its script and language, and yet infinite in the diversity of the national characteristics of its federated units." Elaborating the implications of this pivotal principle, Shoghi Effendi, the Guardian of the Baha'i Faith, commented in 1931 that: "Far from aiming at the subversion of the existing foundations of society, it seeks to broaden its basis, to remold its institutions in a manner consonant with the needs of an ever-changing world. It can conflict with no legitimate allegiances, nor can it undermine essential loyalties. Its purpose is neither to stifle the flame of a sane and intelligent patriotism in men's hearts, nor to abolish the system of national autonomy so essential if the evils of excessive centralization are to be avoided. It does not ignore, nor does it attempt to suppress, the diversity of ethnical origins, of climate, of history, of language and tradition, of thought and habit, that differentiate the peoples and nations of the world. It calls for a wider loyalty, for a larger aspiration than any that has animated the human race. It insists upon the subordination of national impulses and interests to the imperative claims of a unified world. It repudiates excessive centralization on one hand, and disclaims all attempts at uniformity on the other. Its watchword is unity in diversity. . . ." (The Promise of World Peace, Pages 120-126)

[75] 193. Select ye a single language . . . adopt ye . . . a common script. v.189 Baha'u'llah enjoins the adoption of a universal language and script. His Writings envisage two stages in this process. The first stage is to consist of the selection of an existing language or an invented one which would then be taught in all the schools of the world as an auxiliary to the mother tongues. The governments of the world through their parliaments are called upon to effect this momentous enactment. The second stage, in the distant future, would be the eventual adoption of one single language and common script for all on earth. (Notes: Kitabi-Aqdas, Page 250)

[76] In His Writings, Baha'u'llah has given three signs for the maturity of mankind. One is the above statement concerning the decline in the fortunes of kings. Another, to which we have made a reference in the previous volume, is the transmuting of elements, the achievement of alchemy. The third, mentioned in the Kitab-i-Aqdas, is the adoption of an international auxiliary language. (The Revelation of Baha'u'llah, Volume 3, Page 157)

[77] In each Ishraq of the Tablet of Ishraqat Baha'u'llah reveals some of His weighty counsels to mankind in general and to His followers in particular. He enjoins upon all mankind to establish the Lesser Peace, urges His followers to 'observe God's holy commandments', reminds them that the Cause of God will become victorious through 'praiseworthy deeds and upright character', addresses special counsels to the Universal House of Justice (the supreme body ordained by Baha'u'llah which came into being in 1963), affirms that its members 'have been charged with the affairs of the people', refers to it 'all matters of state', and asserts that this instruction is to be considered as 'part of the Most Holy Book'. He moreover affirms that justice is 'upheld by two pillars, reward and punishment', counsels 'everyone regarding the instruction and education of children', announces the purpose of religion to be the establishment of 'unity and concord

amongst the peoples of the world', forbids His followers to make religion the cause of dissension and strife, advocates the adoption of a universal auxiliary language, and enjoins upon the Trustees of the House of Justice 'either to choose one language from among those now existing or to adopt a new one'. (The Revelation of Baha'u'llah, Volume 4, Page 159)

[78] It is interesting to note that in the Tablet of Bisharat Baha'u'llah enjoins upon the governments of the world to adopt the international language. These two statements, which seem to be contradictory, may be regarded as two different stages in bringing about a world auxiliary language. The first stage will be the adoption of a universal language by the governments, while the second will have to wait until such time that the Universal House of Justice has emerged as the supreme institution of the World Order of Baha'u'llah and its authority is recognized. It is only then that it can possibly reconsider the choice of the language so as to either retain the one chosen by the governments or alter it altogether. In one of His Tablets (Nafahat-i-Quds) revealed in 'Akka, Baha'u'llah emphasizes the importance of adopting the auxiliary international language ordained in the Kitab-i-Aqdas. He states that its implementation will provide a means for safeguarding the unity of the human race and will facilitate intercourse and understanding among the peoples of the world. (The Revelation of Baha'u'llah, Vol 4, Pages 159-160)

[79] In this Tablet Baha'u'llah praises the Arabic language for its expressiveness and eloquence, and remarks that no other language can match its vast possibilities. He further states that God would be pleased if all the peoples of the world were to speak the Arabic language. But He does not require humanity necessarily to adopt it as the international language; rather He leaves the choice to the appropriate institutions. (The Revelation of Baha'u'llah, Vol 4, Page 160)

[80] It has not been possible so far to identify the person for whom the Tablet of Bisharat (Glad-Tidings) was revealed... On the other hand, Baha'u'llah after the preamble, addresses the peoples of the world. ... In this Tablet Baha'u'llah advocates the adoption of a universal language, advises the sovereigns of the world or their ministers... to choose a new or an existing; language for the purpose,... (The Revelation of Baha'u'llah, Vol 4, Pages 161-162)

[81] (Kalimat-i-Firdawsiiyyih- in Tablets of Baha'u'llah 57-80) urges the establishment of a universal language; (The Revelation of Baha'u'llah, Vol 4, Page 215)

[82] In this Tablet (Lawh-i-Dunya, Tablet of the World, in Tablets of Baha'u'llah, Pages 83-97) Baha'u'llah promulgates some of His Teachings aimed at the reconstruction of human society. These mostly reiterate teachings previously revealed, such as the establishment of an international language, (The Revelation of Baha'u'llah, Vol 4, Page 341)

[83] At present, a new language and a new script have been devised.' This is possibly a reference to Esperanto which was invented about four years before Baha'u'llah wrote this Epistle. (The Revelation of Baha'u'llah, Vol 4, Page 437)

[84] The language and script referred to on p. 138 were never communicated to anyone by Baha'u'llah. (Marzieh Gail, in preface to Epistle to the Son of the Wolf, Page xvi)

[85] When Stephenson invented his locomotive engine, European mathematicians of the time, instead of opening their eyes and studying the facts, continued for years to prove to their own satisfaction that an engine on smooth rails could never pull a load, as the wheels would simply slip round and round and the train make no progress. To examples like these one might add indefinitely, both from ancient and modern history, and even from our own times. Dr. Zamenhof, the inventor of Esperanto, had to battle for his wonderful international language against the same sort of ridicule, contempt, and stupid opposition which greeted Columbus, Galvani, and Stephenson. Even Esperanto, which was given to the world so recently as 1887, has had its martyrs. (Baha'u'llah and the New Era, Page 199)

[86] Baha'u'llah commanded the adoption of a universal auxiliary language, and Dr. Zamenhof and others obeyed His call by devoting their lives and genius to this great task and opportunity. (Baha'u'llah and the New Era, Page 236)

[87] A world language will either be invented or chosen from among the existing languages and will be taught in the schools of all the federated nations as an auxiliary to their mother tongue. A world script, a world literature, (Baha'u'llah and the New Era, Page 280)

[88] Other examples are: The equality of men and women; the universalization of knowledge (education); the creation of one universal language; (December 9, 1920 Tablet of 'Abdu'l-Baha to Miss Yuri Mochizuki (later Mrs. Furukawa), the first Japanese woman to become a Baha'i) (Japan Turn Ablaze! Page 27)

[89] "Your institutes should not only be seats of Baha'i learning but also centres from which mass teaching and consolidation work over a large area must be inspired and conducted. The Institute is not merely a building, nor solely a place where Baha'i classes can be held for a few days. It should be the centre of complex activities which systematically assist your Assembly in the achievement of its goal in teaching and consolidation." (From letter of the Universal House of Justice to the National Spiritual Assembly of India: June 23, 1966) (#1909 Lights of Guidance, Page 564)

[90] \* Encourage individual believers to adopt teaching goals for themselves. \* Carry out activities designed to deepen the believers in both a spiritual and intellectual understanding of the Cause. \* Encourage the believers to make greater use of Baha'i literature. \* Encourage the believers to enhance their command of language to assist them to understand the Baha'i writings ever more clearly. \* Develop and foster Baha'i scholarship and lend support to the Associations for Baha'i Studies. (Six Year Plan 143-149, 1986-1992, of The Universal House of Justice, February 25, 1986, Page 17)

[91] In addition to projects to be initiated at the World Centre, these ideas include: ù Calling upon local and national Baha'i communities to sponsor a wide range of activities which will engage the attention of people from all walks of life to various topics relevant to peace, such as: the role of women, the elimination of racism, the eradication of prejudice, the promotion of education, the extension of social and economic development, the adoption of a world auxiliary language, the establishment of world

government; ù Mounting a publicity campaign which will make use of such themes as "world peace through world religion," "world peace through world education," "world peace through world language," "world peace through world law"--a campaign which could lead to discussion of these subjects in small or large gatherings, at local or national levels, and perhaps in collaboration with organizations promoting such ideas; ù Urging the publishing within and without the Baha'i community of a wide assortment of literature, posters and other graphic materials on peace; (A Wider Horizon, Pages 31-32)

[92] Develop and administer correspondence courses for teaching and deepening. (Six Year Plan 143-149, Page 16)

[93] Eleventh- One language must be selected as an international medium of speech and communication. Through this means mis-understandings will be lessened, fellowship established and unity assured. ('Abdu'l-Baha In Canada, Page 42)

**MENU: [HOME](#) » [Reconstruction](#) » [Recovery](#) » [Renewal](#) » [Language Main Page](#)**

---

---

The Universal House of Justice  
Bahá'í World Centre  
Haifa, Israel  
June 22, 2002

Dear Respected Friends,

I am writing to you with questions that I have been researching for some months and for which I have not yet found conclusive answers. In the meantime, my proposal for a paper on the subjects outlined below was accepted by the Association for Bahá'í Studies conference at the end of August. My plans are to present it in Toronto at that time. I would be very grateful for your response to my inquiry.

My questions center on the image of God as “Father,” masculine pronouns used in reference to the Divinity, and the use of “man” to represent humanity as well as individuals – usage that is standard in the authorized English translations of the Bahá'í scriptures as well as the English writings of the Guardian and, most often, the Universal House of Justice. My understanding from the Teachings is that this usage is a product of convention and the images are generic and intended to be inclusive. While I don't doubt that intention, these practices nevertheless raise certain questions because of the importance of language in the formation of worldview.

To my knowledge, Bahá'u'lláh and the Báb abided by the conventions of Arabic and Persian regarding these matters, as did 'Abdu'l-Bahá. Shoghi Effendi translated their Writings into an English that was also faithful to conventions of the time. All of these languages utilize the masculine when referring to God. It appears that Shoghi Effendi often chose to translate words that referred to the generality of humankind as “man” per the standard. None of them chose to create new forms by which to render either “God” or “humanity” differently or opted to

use alternatives, and so masculine is the norm when referring to God in Bahá'í literature.

Of course, any language is inadequate to express the Divine, and both the Revealed Word and the translations are of singular quality, but the Word of God was revealed in language from the nineteenth-century Middle East, and the translations by the Guardian, the Expounder, were into a form of English characteristic of a time that preceded even his own. Language, however, changes to reflect the realities of the age; for example, it would seem unlikely that, were the Guardian writing and translating today, he would use “colored” or “Negro,” which were legitimate during his life, but in the short time since have come to be regarded as archaic, even offensive.

According to my understanding, two important spiritual features of this age will be the deanthropomorphization of God in the minds of human beings and the equality of the sexes. The language of the Bahá'í scriptures, however, can be seen to repeat and reinforce the sense that the Divine is somehow male. This concept characterized previous religions with many cumulative, undesirable consequences, which our Faith addresses. Similarly, the consistent use of “man” and masculine pronouns in the Writings to represent humanity and individuals contributes to an image that the human archetype is male, particularly when even in private personal prayer, the gender of pronouns -- overwhelmingly masculine -- is not to be changed, no matter who is praying or for whom, with the exception of the prayer for the dead.

My specific questions to you are:

§ Since the selection of words were divinely-inspired in the case of the Central Figures and consciously made choices by the Guardian, does that mean that in order to preserve faithfulness to their intent, Bahá'í English with regard to gender was crystallized at the point of the Guardian's translations?

§ Will his specific use of gender in the language serve as the model

for translations henceforth?

§ Will all references to God and human beings throughout this dispensation be masculine?

§ Is this the image translators should endeavor to replicate, even in languages whose constructs regarding gender and the Divine may pose no such dilemmas or different ones?

§ Will the universal auxiliary language need to retain masculine imagery in order to be true to the message or will it be able to establish new forms?

§ Are there spiritual implications to sex-specific imagery -- which the Faith's own teachings seem to indicate is not correct -- being fixed in holy Scriptures for all time or at least until the end of this dispensation?

I deeply appreciate your attention to my questions. I request your guidance regarding my sharing the response with the audience at the Association for Bahá'í Studies Conference, should it come in time to be incorporated as part of my presentation, and later with interested Bahá'ís and the general public.

With deepest respect and love,

Nancy Branham Songer  
Columbia, SC

**MENU:** [HOME](#) » [Reconstruction](#) » [Recovery](#) » [Renewal](#) » [Language Main Page](#)

---

---

Materials Provided by the Baha'i World Centre on Gender in the Writings,  
Translation, Universal Languages

**Contents**

Contents.....1

Attachment #1 - From the Universal House of Justice, Department of the Secretariat,  
25 July 2002 email to Nancy Branham Songer.....2

Attachment #2 - Use of Masculine Pronouns and Images.....3

Attachment #3 - The Use of the Masculine Gender in the Bahá'í Writings Extracts  
from Letters Written By and on Behalf of the Universal House of Justice.....6

Attachment #4 - Literary Style –  
Translation.....12

Attachment #5 - The Difficult Art of Translation – Selected Extracts From Letters  
Written By and On Behalf of the Universal House of Justice Concerning the  
Translations of Shoghi  
Effendi.....17

Attachment #6 - Importance of and Guidance on Translating the Bahá'í Writings into  
Indigenous and Other  
Languages.....21

\*\*\*

Attachment #1 - Department of the Secretariat, 15 August 2002, email to  
Nancy Branham Songer, re: universal auxiliary language and universal  
language.....26



Attachment #2 - Extract from a Research Department memorandum dated 7 July 1994.....27

Attachment #3 – The Principle of an International Auxiliary Language.....30

Attachment #4 – International Auxiliary Language.....38

Attachment #5 – Baha’i World Centre Library A Partial Bibliography of Published Works on an Auxiliary Language 3 September 1991.....39

THE UNIVERSAL HOUSE OF JUSTICE  
DEPARTMENT OF THE SECRETARIAT

Bahá’í World Centre • P.O. Box 155 • 31 001 Haifa, Israel

Tel: 972 (4) 835 8358 • Fax: 972 (4) 835 8280 • Email: [secretariat@bwc.org](mailto:secretariat@bwc.org)

25 July 2002

Transmitted by email: [nsonger@sc.rr.com](mailto:nsonger@sc.rr.com)

Mrs. Nancy Branham Songer  
U.S.A.

Dear Bahá'í Friend,

The Universal House of Justice referred your emailed letter dated 22 June 2002 to its Research Department for comments, and it commends to your study the enclosed memorandum prepared in response to your queries concerning the use of masculine pronouns and images in the Sacred Writings of the Faith. We hope this information will prove useful to your endeavors, and you are free to use any of the contents in your presentation at the Association for Bahá'í Studies conference.

With loving Bahá'í greetings,

Department of the Secretariat

Enclosure with four attachments

## M E M O R A N D U M

To: The Universal House of Justice

Date: 25 July 2002

From: Research Department

### Use of Masculine Pronouns and Images

The Research Department has studied the questions on the above-mentioned subject raised by Mrs. Nancy Branham Songer in her emailed letter dated 22 June 2002 to the Universal House of Justice. Mrs. Songer observes that in the authorized English translations of the Bahá'í Scriptures and in the English writings of the Guardian, God is invariably termed “Father”, masculine pronouns are used in reference to the Divinity, and the term “man” is used to represent humanity as well as individuals. From her study of the Bahá'í teachings Mrs. Songer is aware that “this usage is a product of convention and the images are generic and intended to be inclusive”. She is also cognizant of the fact that “these practices nevertheless raise certain questions because of the importance of language in the formation of worldview”. In this regard she states that “according to [her] understanding, two important spiritual features of this age will be the deanthropomorphization of God in the minds of human beings and the equality of the sexes”. However, it is her view that the present “language of the Bahá'í scriptures ... can be seen to repeat and reinforce the sense that the Divine is somehow male”, and the “consistent use of ‘man’ and masculine pronouns in the Writings to represent humanity and individuals contributes to an image that the human archetype is male”. In light of these observations, Mrs. Songer poses a number of detailed questions concerning the work of translation—the implications of present practice for future translations, whether “Bahá'í English with regard to gender was crystallized at the point of the Guardian’s translations”, whether the universal auxiliary language will need “to retain masculine imagery in order to be true to the message or will it be able to establish new forms”, and whether “there are spiritual implications to sex-specific imagery ... being fixed in holy Scriptures for all time or at least until the end of this dispensation”. We provide the following comment.

By way of introduction, we wish to note that the Research Department has not, to date, been able to locate detailed guidance concerning the specific technical issues raised by Mrs. Songer about the practical implications of present translation practices for the future work of translation, especially as they relate to gender issues. To assist Mrs. Songer in

thinking about the questions she poses, we attach the following four compilations:

q “The Use of the Masculine Gender in the Bahá’í Writings”, a compilation of extracts from letters written by and on behalf of the Universal House of Justice. The extracts in the compilation set out a number of general principles in relation to this subject and the Bahá’í perspective on it. We note, for example, the House of Justice indicates that:

§ “In many languages the use of the masculine gender, unless intended specifically to denote masculinity, is generic” (extract 1, see also extracts 2 and 6).

§ “The translation of the Writings of the Central Figures of the Faith must of necessity agree in full detail with the original in conveying the exact meaning of the Words as

## **The Use of Masculine Pronouns and Images**

25 July 2002

Page 2

they have been revealed” (extracts 2, 8 and 9). In addition, the Universal House of Justice indicates that it “does not feel it appropriate to change Shoghi Effendi’s usage of certain nouns in his translations” (extract 8). Indeed, “The style of translation into English was set by Shoghi Effendi” (extract 10).

- “... the Sacred Writings of the Faith and those of the Guardian do not use the ‘gender inclusive language’ now in vogue...” (extract 7).
- In relation to images of God, while using “conventional wording” Bahá’u’lláh “devoted vast numbers of Tablets to conveying the truth that God is not only neither male nor female, but is far above all human understanding” (extracts 8 and 10).
- With regard to the English language, “the issue of gender-specific nouns may be resolved either by changing the usage of nouns, or by permitting the consciousness of sexual equality to modify the meaning of nouns as they are now used. No doubt both courses will be followed in the evolution of the language. It is generally considered preferable to permit the change of consciousness to change the meaning that people attribute to words, rather than to press the use of forms of words, which may seem

contrived” (extract 8).

§ “The challenge ... is to accept the use of pronouns in their generic sense, which will lead one to view the matter in terms of a spiritual response, rather than one of semantics” (extracts 8 and 10).

q “Literary Style—Translation”, a compilation of materials that was prepared some time ago. The compilation includes a statement from ‘Abdu’l-Bahá about translation, extracts from letters written on behalf of Shoghi Effendi and the Universal House of Justice, and a description of the writings of Shoghi Effendi excerpted from RúHíyyih Rabbani’s “The Priceless Pearl” (London: Bahá’í Publishing Trust, 1969), pages 196–204.

q “The Difficult Art of Translation—Selected Extracts from Letters Written By and on Behalf of the Universal House of Justice Concerning the Translations of Shoghi Effendi”. Extracts in the compilation address such issues as:

§ The status of Shoghi Effendi’s translations (extracts 1 and 6). The importance of his translations as a starting point for translations into other European languages (extract 1).

§ The Guardian’s approach to translation (extracts 2, 4, and 7).

§ The interpretative aspect to Shoghi Effendi’s translations (extracts 1, 5, and 6).

§ Translators are encouraged to “strive to render the words of the Báb, Bahá’u’lláh and ‘Abdu’l-Bahá into English in a way that reproduces as accurately as possible the meaning of the originals, that is as beautiful as possible, and that harmonizes closely with the style used by Shoghi Effendi” (extract 4).

q “Importance of and Guidance on Translating the Bahá’í Writings into Indigenous and Other Languages”. This compilation, consisting mostly of the correspondence of the Universal House of Justice, was prepared some time ago. Despite the fact that there is a degree of

**The Use of Masculine Pronouns and Images**

25 July 2002

Page 3

repetition in the content, it is included because of Mrs. Songer's interest in the importance and use of language.

As to Mrs. Songer's question concerning whether "the universal auxiliary language needs to retain masculine imagery in order to be true to the message or will it be able to establish new forms", the Research Department has not, to date, been able to locate any references to this subject in the authoritative literature of the Faith. However, we call attention to the following statement of the Universal House of Justice in a letter dated 8 December 1964, which is included in extract 1 of the attached document "The Difficult Art of Translation":

We also feel that it is still premature to decide upon the question of the International Auxiliary Language. It is quite clear from the Texts that any living or invented language may be chosen, but the time and manner of its choosing and propagation are not yet decided.

Attachments 4

## **The Use of the Masculine Gender in the Bahá'í Writings**

### **Extracts from Letters Written By and on Behalf of the Universal House of Justice**

In many languages the use of the masculine gender, unless intended specifically to denote masculinity, is generic. For instance, in English we speak of the race of man, or mankind, in both instances meaning every member of the human race—men, women and children. There would be no reason to interpret “O Son of Being”, or “O Son of Man” as addressed only to males. It is the same with pronouns.

(5 April 1981, written on behalf of the Universal House of Justice to an individual believer) [1]

The principle of the equality of men and women which is firmly established by the Author of the Faith and forms one of the basic tenets of our belief will be fully realized as the human race matures in its understanding of the significance of Bahá'u'lláh's Revelation. Equality will be achieved as a direct result of the adjustments the friends are required to make in their attitude towards this fundamental issue so essential to the establishment of the unity of mankind, and despite the exigencies of the languages in which the revealed Words have been received and in which they have been translated. ‘Abdu’l-Bahá says: “...in His estimate there is no question of sex.” “In the estimation of God there is no gender.”<sup>1</sup>...

The translation of the Writings of the Central Figures of the Faith must of necessity agree in full detail with the original in conveying the exact meaning of the Words as they have

been revealed. The Guardian did not even approve the changing of pronouns in Bahá'í prayers when they are read. Therefore, no deviation in translation from the actual meaning of the words, to accommodate the general trend of thought and behaviour affecting a language, is conceivable, unless, of course, the equivalent of the original word does not exist in a given language. In one of His talks quoted in "The Promulgation of Universal Peace", page 76, 'Abdu'l-Bahá says:

The truth is that all mankind are the creatures and servants of one God, and in His estimate all are human. "Man" is a generic term applying to all humanity. The biblical statement "Let us make man in our image, after our likeness" does not mean that woman was not created. The image and likeness of God apply to her as well. In Persian and Arabic there are two distinct words translated into English as man: one meaning man and woman collectively, the other distinguishing man as male from woman the female. The first word and its pronoun are generic, collective; the other is restricted to the male. This is the same in Hebrew.

Concerning the English language, it is interesting that the 1983 edition of the Concise Oxford English Dictionary gives "human being" as the first meaning of "man"; and only as the fourth meaning "adult human male, opp. to woman, boy, or both." Therefore, the use of "man" or "men" in translating the intent of the Revealer of the Words to embrace all humankind seems a good choice.

(20 May 1984, written on behalf of the Universal House of Justice to an individual believer) [2]

1 "The Promulgation of Universal Peace: Talks Delivered by 'Abdu'l-Bahá during His Visit to the United States and Canada in 1912", rev. ed. (Wilmette: Bahá'í Publishing Trust, 1995), pp. 174 and 374.



We have considered your memorandum of 6 June 1989 and appreciate the points you have raised concerning the sensitivity of women, both Bahá'í and non-Bahá'í, to the use of what are construed to be exclusively masculine words in the Sacred Writings of the Bahá'í Faith.

While we recognize that the problem of gender in language presents difficulties at the present time, we must also recognize that the problem varies considerably from language to language, depending on the number of grammatical genders that each language uses.

Since the immediate concern in the translations ... centres on usage in English, we shall concentrate on the problem as it exists in that language. English is fortunate in having a common gender. The problem of gender-specific nouns is, therefore, susceptible of two lines of solution. One is to change the usage of nouns, the other is to permit the consciousness of sexual equality to modify the meaning of nouns as now used. Undoubtedly both courses will be followed in the evolution of the language. The word "doctor" for example, is now clearly of common gender in English, although originally masculine. Our feeling is that, in general, it is preferable to permit the change of consciousness to change the meaning that people attribute to the words, rather than to press the use of forms of words that seem contrived and, to many people, ridiculous—a reaction that does not help the advancement of the cause of the equality of the sexes. Following this reasoning, as you will have noted, we used the word "chairman" in relation to the sessions of the International Convention, although all were women.

In respect to the Sacred Writings, the originals, clearly, cannot be changed, and we do not feel at liberty to change Shoghi Effendi's usage of "man" or "mankind" to "humanity" or "humankind".

(27 November 1989, from a memorandum from the Universal House of Justice to a Bahá'í Office of Public Information) [3]

There are, as you indicate, many conventions of expression in use at the present time which reflect the male dominance of human society in the past. We must hope that as the

consciousness of human beings changes and as the equality of the sexes comes to be accepted in theory and in practice throughout the world, the meanings attached to certain words will change accordingly, as will the usage of words. Language is a living thing and changes as the culture which it reflects changes....

The important point here is that one will not persuade people to change their usage of language until one has convinced them of the true understanding of the reality of things; but when they once understand the truth, the meaning that they attach to words changes, and thus a change in usage becomes much less important, if not irrelevant. (8 March 1990, written on behalf of the Universal House of Justice to an individual) [4]

... the House of Justice is well aware that, at various times, the meaning attached to certain words becomes influenced by emotions and can assume overtones which are offensive to some segments of the population. In the case of the generic terms in the English translations of the Bahá'í Writings, the tendency to take such terms as being applicable only to males is a reflection of the male-dominated society which has prevailed for so long, and to which there is

**The Use of the Masculine Gender in the Bahá'í Writings**  
2002

25 July

Page 3

a reaction from women who are seeking legitimate recognition and equality. Bahá'ís can well sympathize with such concerns, while pointing out that language is a living thing and that the intended meaning of the generic terms will doubtless become more readily apparent as the influence of the Bahá'í commitment to equality of the sexes permeates human society more fully.

It is understandable that some non-Bahá'ís are initially disturbed by the use of those terms in our Writings which are associated conventionally with a male orientation. Seekers

after truth should be assisted to determine the intended meaning of such terms through reference to the Bahá'í Teachings, rather than through assuming that these terms have the meaning now prevalent in the world; thus they will find that they should seek that meaning which is consistent with equality of men and women, and which also happens to be the primary meaning associated with classical usage of the English language to convey spiritual truths. A similar approach is called for when a seeker encounters a number of other terms and phrases in the Writings.

Members of the Bahá'í community should not fall unconsciously into the error of labelling the Bahá'í Writings as being “sexist” or “discriminatory”, or of feeling a need to apologize to non-Bahá'ís for the terms used. Such an attitude would be indicative of a lack of understanding of the Bahá'í approach to this issue, and a lack of confidence in the position adopted by the Faith in regard to use of generic terms.

(26 September 1993, written on behalf of the Universal House of Justice to a National Spiritual Assembly) [5]

We regret the very long delay in responding to your request ... for help in locating something in print regarding the use of the male pronoun in the Bahá'í Writings. In this regard we are enclosing a copy of extracts from letters written on behalf of the Universal House of Justice to individual believers regarding the use of the masculine gender in the Writings. Related to this subject is the reference on page seven in the introduction to “The Kitáb-i-Aqdas” where it is stated that it is apparent from the writings of the Guardian that “where Bahá'u'lláh has given a law as between a man and a woman, it applies ‘mutatis mutandis’ between a woman and a man unless the context makes this impossible”.

(26 June 1994, written on behalf of the Universal House of Justice to an individual believer) [6]

In relating the Teachings of the Faith to the discussion of contemporary social issues, Bahá'í publications are challenged by the need to adapt editorial policies to the ever-changing public perceptions of those issues, without compromising the fundamental Bahá'í principles

and concepts involved. The question of “gender inclusive language” guidelines is a case in point. The editors of a publication like the Journal will certainly have acquainted themselves with the various points of view on the subject current among the readership which they and their authors are addressing, together with prevailing modes of expression. These factors will exercise an influence on Bahá’í editorial policy, but must do so within the context of the Teachings.

Clearly, the Scriptures of the Faith, as revealed by the Founders and interpreted by ‘Abdu’l-Bahá and the Guardian, impose their own requirements on Bahá’í authors and editors

**The Use of the Masculine Gender in the Bahá’í Writings**  
2002

25 July

Page 4

alike. On the one hand, an editorial board will quite properly be concerned to take into account the preferences and convictions common to the great majority of the intended readers of its publication. On the other, Bahá’í authors must be left entirely free to discuss the Revelation of Bahá’u’lláh in its own terms and language as set out in the Bahá’í Scriptures themselves and in their authorized interpretations, irrespective of current fashions in academic and other public discourse. That is to say: the Sacred Writings of the Faith and those of the Guardian do not use the “gender inclusive language” now in vogue, and it would therefore not be appropriate for the Editorial Board to impose such current standards on Bahá’í authors.  
(26 July 1996, written on behalf of the Universal House of Justice to a National Spiritual Assembly) [7]

Your letter of 19 September 1996 expressing your concern regarding the use of inclusive masculine terms in the Sacred Writings has been received by the Universal House of Justice, and we have been asked to reply.

The point you have raised regarding the sensitivity of women, both Bahá’í and non-Bahá’í, to the use of masculine nouns and pronouns when referring to God is noted and your

concern appreciated. It is recognized that the question of gender in language presents difficulties at this time; however, it must also be recognized that the problem varies considerably from language to language, depending on the number of grammatical genders that each language uses.

English is fortunate in having a common gender. Therefore, the issue of gender-specific nouns may be resolved either by changing the usage of nouns, or by permitting the consciousness of sexual equality to modify the meaning of nouns as they are now used. No doubt both courses will be followed in the evolution of the language. It is generally considered preferable to permit the change of consciousness to change the meaning that people attribute to words, rather than to press the use of forms of words, which may seem contrived.

Likewise, when considering the manner in which masculine nouns and pronouns are used to refer to God, it is important to bear in mind that when Bahá'u'lláh was revealing His Scriptures He had to use language and forms of expression which could be understood by those whom He was addressing. This is the case with every Prophet; He is compelled to use old forms through which He will raise humanity to a new level of understanding. In Arabic and Persian, as in English and most European languages, it has been customary to refer to God as "Lord" and "Father", rather than "Lady" and "Mother". While using the conventional wording Bahá'u'lláh approached the matter on two levels. In relation to God He devoted vast numbers of Tablets to conveying the truth that God is not only neither male nor female, but is far above all human understanding. If you study deeply the Writings of Bahá'u'lláh that portray both the transcendence and immanence of God you will find that the entire question of sex in this context falls into total insignificance.

On the human level, the Bahá'í Teachings stress again and again the equality of men and women. They do not ignore the differences between the sexes, but repeatedly emphasize their equality. This is a universal concept, irrespective of the language in which it is expressed. Regarding the pronouns which refer to the Deity, in Arabic there is a distinction between

the masculine and feminine; however, the Persian language does not make such a distinction in pronouns between the sexes. As you have noted in your letter, the style of translation into

**The Use of the Masculine Gender in the Bahá'í Writings**  
2002

25 July

Page 5

English was set by Shoghi Effendi. In respect to the Sacred Writings, the originals clearly cannot be changed, and the House of Justice does not feel it appropriate to change Shoghi Effendi's usage of certain nouns in his translations. The Guardian did not even approve the changing of pronouns in Bahá'í prayers when they are read. Therefore, no deviation in translation from the actual meaning of the words, to accommodate the general trend of thought

and behavior affecting a language, is permissible, unless, of course, the equivalent of the original word does not exist in a given language.

‘Abdu’l-Bahá says: “...in His estimate there is no question of sex.” “In the estimation of God there is no gender.”

The challenge, therefore, is to accept the use of pronouns in their generic sense, which will lead one to view the matter in terms of a spiritual response, rather than one of semantics.

The principle of the equality of men and women, which is firmly established by Bahá'u'lláh and forms one of the basic tenets of our Faith, will be fully realized as the human race matures in its understanding of the significance of His Revelation. Equality will be achieved as a direct result of the transformations the believers make in their attitudes toward this fundamental issue, and despite the exigencies of the languages in which the revealed Words have been received and translated.

(24 October 1996, written on behalf of the Universal House of Justice to an individual believer) [8]

In response to your email of 21 August 1998 requesting guidance concerning the use of “gender-sensitive language” for use in your “discussions with potential authors and in the editing of their work”, we are able to provide the following comments.

The Universal House of Justice has previously stated in response to a similar query that the use of “gender inclusive language” is one of the many contemporary issues which challenge Bahá’í publications to adapt editorial policies to the ever-changing public perceptions without compromising the fundamental Bahá’í principles and concepts involved. It is the responsibility of authors and editors to acquaint themselves with the various points of view on the subject current among the readership which they are addressing, together with the prevailing modes of expression. These factors will exercise an influence on Bahá’í editorial policy, but must do so within the context of the Teachings.

Clearly, the Scriptures of the Faith, as revealed by the Founders and interpreted by ‘Abdu’l-Bahá and the Guardian, impose their own requirements on Bahá’í authors and editors alike. On the one hand, an editorial board will quite properly be concerned to take into account the preferences and convictions common to the great majority of the intended readers of its publication. On the other, Bahá’í authors must be left entirely free to discuss the Revelation of Bahá’u’lláh in its own terms and language as set out in the Bahá’í Scriptures themselves and in their authorized interpretations, irrespective of current fashions in academic and other public discourse.

It is not surprising that the struggle to achieve such a balance during an era of unprecedented social and intellectual turmoil is very challenging to Bahá’í publishers. Inevitably, there will be certain segments of the public who will object in some degree to

**The Use of the Masculine Gender in the Bahá’í Writings**  
2002

25 July

Page 6

whatever resolution is arrived at in any given case, but this should not unduly distress either Bahá’í authors or Bahá’í editors.

(16 September 1998, written on behalf of the Universal House of Justice to a

Bahá'í Publisher) [9]

The Universal House of Justice has received your email message of 17 September 1999 requesting guidance on the question of gender as it relates to the Deity and the use of gender specific pronouns when referring to God.

When considering the manner in which masculine pronouns are used to refer to God, it is important to bear in mind that when Bahá'u'lláh was revealing His Scriptures He had to use language and forms of expression which could be understood by those whom He was addressing. This is the case with every Prophet; He is compelled to use old forms through which He will raise humanity to a new level of understanding. In Arabic and Persian, as in English and most European languages, it has been customary to refer to God as "Lord" and "Father", rather than "Lady" and "Mother". While using the conventional wording, Bahá'u'lláh devoted vast numbers of Tablets to conveying the truth that God is not only neither male nor female, but also is far above all human understanding. If one studies deeply the Writings of Bahá'u'lláh that portray both the transcendence and immanence of God it becomes clear that the entire subject of sex in this context is essentially irrelevant....

The style of translation into English was set by Shoghi Effendi, and in respect to the Sacred Writings the originals clearly cannot be changed. The Guardian did not even approve the changing of pronouns in Bahá'í prayers when they are read. Therefore, when translating the Sacred Writings it is not possible to alter the actual meaning of the words to accommodate the general trend of thought and behavior affecting a language.

The challenge, therefore, is to accept the use of pronouns in their generic rather than gender sense, which will lead one to view issues in terms of a spiritual response, rather than one of semantics. The Bahá'í Teachings stress again and again the equality of men and women. They do not ignore the differences between the sexes, but repeatedly emphasize their equality.

This is a universal principle of the Faith, irrespective of the language in which it is expressed.

(7 October 1999, written on behalf of the Universal House of Justice to a National Spiritual Assembly) [10]



## LITERARY STYLE—TRANSLATION

### From the Writings of ‘Abdu’l-Bahá

Regarding the translation of the Books and Tablets of the Blessed Beauty, ere long will translations be made into every tongue, with power, clarity and grace. At such time as they are translated, conformably to the originals, and with power and grace of style, the splendours of their inner meanings will be shed abroad, and will illumine the eyes of all mankind. Do thy very best to ensure that the translation is in conformity with the original. (“Selections from the Writings of ‘Abdu’l-Bahá”, number 31.13)

### From the writings of Shoghi Effendi and letters written on his behalf

This is one more attempt to introduce to the West, in language however inadequate, this book of unsurpassed pre-eminence among the writings of the Author of the Bahá’í Revelation. The hope is that it may assist others in their efforts to approach what must always be regarded as the unattainable goal—a befitting rendering of Bahá’u’lláh’s matchless utterance.

(Shoghi Effendi, Foreword to “The Kitáb-i-Iqán” (Wilmette: Bahá’í Publishing Trust, 1985)

It must have been very distasteful to you to read some of the off-hand and ungrammatical

translations that more out of necessity than choice won circulation and were even published. Furthermore, it was always the expressed wish and desire of 'Abdu'l-Bahá to have proper and adequate translations that would not only convey the true spirit of the original but also possess some literary merit. And for this he emphasized the necessity of a board of translators. Such a board it has unfortunately been impossible to form as yet.  
(28 March 1926 to an individual believer)

Shoghi Effendi hopes that before long we will obtain a group of competent English and Persian scholars who would devote their whole time and energy to the translation of the Words and bring out things that are really deserving. For whatever we have at present, even the very best, is only a mediocre rendering of the Persian or Arabic beauty of style and fertility of language that we find in the original.  
(4 July 1929 to an individual believer)

Shoghi Effendi wishes me also to express his deep-felt appreciation of your intention to study the Qur'án. The knowledge of this revealed holy Book is, indeed, indispensable to every Bahá'í who wishes to adequately understand the writings of Bahá'u'lláh. And in view of that the Guardian has been invariably encouraging the friends to make as thorough a study of this Book as possible, particularly in their Summer Schools. Sale's translation is the most scholarly we have, but Rodwell's version is more literary, and hence easier for reading.  
(23 November 1934 to an individual believer)

-2-

He feels the highest literary standard possible should be maintained in any future translations of Bahá'í writings into Spanish, and for this reason he heartily welcomes the suggestion to refer such work to Spanish professors....  
(14 December 1938 to an individual believer)

There is no objection to using, in translations of the Master's words, a uniform style such as

“he does” or “he doeth”. It certainly creates a ridiculous impression to use both. One or the other may be chosen.

In Persian it is impolite not to use the word “FaGrat” before the name of the Prophet, so that strictly speaking a proper translation should always have “His Holiness Moses” etc.; however, as this seems peculiar in English, and not in the best usage of our language, he feels it can be dispensed with. Pronouns referring to the Manifestation, or the Master, should, however, invariably be capitalized.

(8 November 1948 to a National Spiritual Assembly)

Shoghi Effendi himself uses the King James version of the Bible, both because it is an authoritative one and in beautiful English.

(28 October 1949 to an individual believer)

He is interested in accomplishing two things—he would like in the European languages to have as much uniformity with the English translations as possible; he does not wish the Bahá’í translations to be in any way a flagrant violation of the rules of the language into which our literature is being translated.

Your Committee must conscientiously study this question, and then do the best you can to have the Bahá’í literature in French meet the high standards of the French language and grammar.

If the possessive and demonstrative adjectives and pronouns in French are never capitalized where they stand for “God”, then this should not be done in the Bahá’í literature. If there is a precedent for doing so in the French language, however, they should be. The same is true of the attributes of God.

(15 February 1957 to the National Translation and Publication Committee of France)

From letters written by the Universal House of Justice

We realise that translation is a very difficult task and that however good a translation is there are always differences of opinion, both as to accuracy and style. However, in translating

Bahá’í Scripture it is important to remember that the style in the original is an exalted one and this aspect should not be lost when it is translated into other languages. It can be noted, for example, that when the beloved Guardian was making his translations into English he

used a style that is far from being that of modern English usage but is admirably suited to the richness and imagery of the original.

(12 August 1973 to a National Spiritual Assembly)

-3-

A translation should of course be as true as possible to the original while being in the best possible style of the language into which it is being translated. However, you should realize that it will not be possible to translate the Tablets adequately into easy, modern Dutch. Many of the original Writings of Bahá'u'lláh and 'Abdu'l-Bahá are written in very exalted and poetic Persian and Arabic and therefore a similar flavour should be attempted in the language into which it is translated. You will see, for example, that in translating the Tablets of Bahá'u'lláh into English the beloved Guardian has created a very beautiful and poetic style in English using many words which might be considered archaic and are reminiscent of the English used by the translators of the King James version of the Bible.

As you point out, a literal translation is often a bad one because it can produce a phraseology or imagery that would convey the wrong impression, thus a translator is at times compelled to convey the meaning of the original by means of a form of words suited to the language. However, a person translating the Bahá'í Writings must always bear in mind that he or she is dealing with the Word of God, and, when striving to convey the meaning of the original, he should exert his utmost to make his rendering both faithful and befitting.

(29 October 1973 to an individual believer)

#### From letters written on behalf of the Universal House of Justice

Those who are entrusted with the task of translating the Sacred Writings from the original into English should study the original very closely, and then attempt to express as accurately and as beautifully as possible in English that which the original conveys. To do this they frequently have to use various different synonyms in English to give the best translation of the same Arabic or Persian word when it appears in different contexts. Conversely, they may have to use the same English word in different contexts to translate various different words in the original. In doing this they attempt to follow the example set by Shoghi Effendi in his magnificent translations.

(31 May 1981 to a National Translation and Revision Committee of a National

## Spiritual Assembly)

Translation is a very difficult art—an art in which absolute perfection is unattainable. However good a translation, there will always be those who would have preferred it otherwise, for taste, which is undefinable, plays such a large part in such judgements. (20 September 1982 to an individual believer)

### From memoranda prepared by the Research Department at the instruction of the Universal House of Justice

The question of which style of Swedish should be used for the translation of Bahá'í Writings is one that, we feel, must be decided by the National Assembly of Sweden after considering the views of those who are expert both in translation and in Swedish literary style. While it is not obligatory for them to follow the practice that the beloved Guardian adopted in English, it would be useful for them to bear in mind certain aspects of the problem which have been solved in English by Shoghi Effendi.

-4-

The originals of the Bahá'í Writings are not only in three different languages (Arabic, Persian and a few in Turkish), which have very different characteristics, but are also in a number of different styles. Some are highly poetic and metaphorical, others more precise and specific. In English-speaking countries, as in most others, religion and spirituality are in a phase of eclipse; therefore the vocabulary used to convey many profound religious concepts has fallen into disuse. To attempt to express the highly poetic and allusive terminology of the Bahá'í Writings in plain, modern English would either be banal or would make the passages sound very strange and foreign. The Guardian's use of a style of English that is slightly archaic, a style in which there is an abundance of spiritual and poetic terminology, acts as a bridge between the English of today and the style of the Persian and Arabic Writings of the Founders of the Faith.

(1 July 1985 to the House of Justice from the Research Department for the Swedish Publishing Trust)

Those devoted believers who are currently engaged in translation work have a difficult task, for the originals of the Bahá'í Writings are not only in three different languages (Arabic, Persian, and a few in Turkish) but are also composed in a number of different styles. Some are highly poetic and metaphorical, others more precise and specific. The translators must study the original closely in order to attempt an accurate and beautiful rendition in English suitable for the style and language of the original text.

(27 May 1987 to an individual believer)

From "The Priceless Pearl"

## **THE WRITINGS OF THE GUARDIAN**

In an age when people play football with words, kicking them right and left indiscriminately with no respect for either their meaning or correct usage, the style of Shoghi Effendi stands out in dazzling beauty. His joy in words was one of his strongest personal characteristics, whether he wrote in English—the language he had given his heart to—or in the mixture of Persian and Arabic he used in his general letters to the East. Although he was so simple in his personal tastes he had an innate love of richness which is manifest in the way he arranged and decorated various Bahá'í Holy Places, in the style of the Shrine of the Báb, in his preferences in architecture, and in his choice and combination of words. Of him it could be said, in the words of another great writer, Macaulay, that "he wrote in language ... precise and luminous." Unlike so many people Shoghi Effendi wrote what he meant and meant exactly what he wrote. It is impossible to eliminate any word from one of his sentences without sacrificing part of the meaning, so concise, so pithy is his style....

The language in which Shoghi Effendi wrote, whether for the Bahá'ís of the West or of the East, has set a standard which should effectively prevent them from descending to the level of illiterate literates which often so sadly characterizes the present generation as far as the use and appreciation of words are concerned. He never compromised with the ignorance of his readers but expected them, in their thirst for knowledge, to overcome their ignorance. Shoghi Effendi chose, to the best of his great ability, the right vehicle for his thought and it made no difference to him whether the average person was going to know the word he used or not. After all, what one does not know one can find out. Although he had such a brilliant command of language he frequently reinforced his knowledge by certainty through looking up the word he

planned to use in Webster's big dictionary. Often one of my functions was to hand it to him and it was a weighty tome indeed! Not infrequently his choice would be the third or fourth usage of the word, sometimes bordering on the archaic, but it was the exact word that conveyed his meaning and so he used it. I remember my mother once saying that to become a Bahá'í was like entering a university, only one never finished learning, never graduated. In his translations of the Bahá'í writings, and above all in his own compositions, Shoghi Effendi set a standard that educates and raises the cultural level of the reader at the same time that it feeds his mind and soul with thoughts and truth....

The supreme importance of Shoghi Effendi's English translations and communications can never be sufficiently stressed because of his function as sole and authoritative interpreter of the Sacred Writings, appointed as such by 'Abdu'l-Bahá in His Will. There are many instances when, owing to the looseness of construction in Persian sentences, there could be an ambiguity in the mind of the reader regarding the meaning. Careful and correct English, not lending itself to ambiguity in the first place, became, when coupled with Shoghi Effendi's brilliant mind and his power as interpreter of the Holy Word, what we might well call the crystallizing vehicle of the teachings. Often by referring to Shoghi Effendi's translation into English the original meaning of the Báb, Bahá'u'lláh, or 'Abdu'l-Bahá becomes clear and is thus safeguarded against misinterpretation in the future. He was meticulous in translating and made absolutely sure that the words he was using in English conveyed and did not depart from the original thought or the original words. One would have to have a mastery of Persian and Arabic to correctly understand what he did....

The Guardian was exceedingly cautious in everything that concerned the original Word and would never explain or comment on a text submitted to him in English (when it was not his own translation) until he had verified it with the original.

(Rúhíyyih Rabbani, *The Priceless Pearl* (London: Bahá'í Publishing Trust, 1969), pp. 196–204)

**The Difficult Art of Translation—Selected Extracts  
From Letters Written By and On Behalf of the Universal House of Justice  
Concerning the Translations of Shoghi Effendi**

The matter of translation is a major problem. As you yourself know only too well, to convey exactly the meaning and flavour of a passage from one language to another is often impossible and one can but labour to approach as near as possible to the unattainable perfection.

Even our beloved Guardian, whose skill in this art amounted to genius, characterized his translation of the “Kitáb-i-Iqán” as “one more attempt to introduce to the West, in language however inadequate, this book of unsurpassed pre-eminence among the writings of the Author of the Bahá’í Revelation” and he expressed the hope “that it may assist others in their efforts to approach what must always be regarded as the unattainable goal—a befitting rendering of Bahá’u’lláh’s matchless utterance.”

The difficulty of translation increases when two languages express the thoughts and metaphors of widely differing cultures; thus, it is infinitely more difficult for a European to conceive the thought patterns expressed in Arabic or Persian than to understand a passage written in English. Moreover, the beloved Guardian was not only a translator but the inspired Interpreter of the Holy Writings; thus, where a passage in Persian or Arabic could give rise to two different expressions in English he would know which one to convey. Similarly he



would  
 be much better equipped than an average translator to know which metaphor to employ in English to express a Persian metaphor which might be meaningless in literal translation.

Thus, in general, speakers of other European tongues will obtain a more accurate translation by following the Guardian's English translation than by attempting at this stage in Bahá'í history to translate directly from the original.

This does not mean, however, that the translators should not also check their translations with the original texts if they are familiar with Persian or Arabic. There may be many instances where the exact meaning of the English text is unclear to them and this can be made evident by comparison with the original....

We also feel that it is still premature to decide upon the question of the International Auxiliary Language. It is quite clear from the Texts that any living or invented language may be chosen, but the time and manner of its choosing and propagation are not yet decided. (8 December 1964, from a letter of the Universal House of Justice to an individual believer) [1]

A translation should of course be as true as possible to the original while being in the best possible style of the language into which it is being translated. However, you should realize that it will not be possible to translate the Tablets adequately into easy, modern Dutch. Many of the original Writings of Bahá'u'lláh and 'Abdu'l-Bahá are written in very exalted and poetic Persian and Arabic and therefore a similar flavour should be attempted in the language into which it is translated. You will see, for example, that in translating the Tablets of Bahá'u'lláh into English the beloved Guardian has created a very beautiful and poetic style in English using many words which might be considered archaic and are reminiscent of the English used by the translators of the King James version of the Bible.

**The Difficult Art of Translation – Selected Extracts...**

25 July 2002

Page 2

As you point out, a literal translation is often a bad one because it can produce a phraseology of imagery that would convey the wrong impression; thus, a translator is at times compelled to convey the meaning of the original by means of a form of words suited to the language. However, a person translating the Bahá'í Writings must always bear in mind that he or she is dealing with the Word of God, and, when striving to convey the meaning of the original, he should exert his utmost to make his rendering both faithful and befitting. (29 October 1973, from a letter of the Universal House of Justice to an individual believer) [2]

Translation is, indeed, a very difficult art, and 'Abdu'l-Bahá has explained that, ideally, all translations of the Sacred Texts should be made by competent committees, rather than by individuals. At the present time, unfortunately, there is seldom in any country a large enough number of sufficiently skilled persons who can be called upon to constitute such committees, and the institutions of the Faith have to rely on the services of such individuals as they can find with adequate time and skill to undertake the arduous work of translation.

The Writings of the Faith are not in the nature of scientific treatises. One must remember that the Manifestation of God is using the inadequate instrument of human language to convey truths and guidance which can raise mankind high above its present level of development and understanding. He makes extensive use, therefore, of metaphor and simile, and often approaches a subject from several different points of view so that its various facets and implications can be better understood. It would not be possible, therefore, to compile a list of meanings for specific symbols, expressions and words, since they may vary in their implication from passage to passage.

The translation of a passage can seldom be an entirely faithful rendering of the original—one just has to strive to make it as faithful and befitting as possible. At the present time many of the translations of the Writings fall far below the desirable standard, especially in those

languages spoken by a relatively small number of Bahá'ís, but time and an increase in the number of Bahá'ís who have a profound understanding of the Teachings as well as an exemplary command of the languages concerned will enable new and improved translations to be produced. For the time being we must do what we can with what we have. (8 September 1985, written on behalf of the Universal House of Justice to an individual) [3]

With regard to your question about the style of English used in the translation of Bahá'í prayers, we are asked to point out that finding an adequate style in English for expressing beautifully the poetic, metaphorical and allusive style of many of the Bahá'í Scriptures is not easy. The Persian and Arabic of the Bahá'í Writings are themselves considerably different from the current styles and usages in those languages. Shoghi Effendi's solution of using a slightly archaic form of English, which is somewhat equivalent to the use in the original languages, makes possible the use of images and metaphors that might seem strange if expressed in modern English.

Furthermore, styles of writing are changing comparatively rapidly. If it were already found necessary to use a style different from that used for translations fifty years ago, one can estimate that a further change would be called for fifty years hence. One merely has to consider the large number of new translations of the Bible that have appeared, and are still appearing, and yet many English-speaking Christians prefer to continue using the Authorized Version in

**The Difficult Art of Translation – Selected Extracts...**

25 July 2002

Page 3

spite of its proven inaccuracies. Holy Scriptures have a profound meaning for their readers, and to change the familiar words too often can be gravely disturbing.

Books of Scripture themselves mould the language in which they are written. The House of Justice believes that if translators strive to render the words of the Báb, Bahá'u'lláh and 'Abdu'l-Bahá into English in a way that reproduces as accurately as possible the meaning of the

originals, that is as beautiful as possible, and that harmonizes closely with the style used by Shoghi Effendi, these Writings themselves will have a far-reaching effect on the ability of Bahá'ís, and especially Bahá'í children and youth, to use the English language effectively for thought and for expression.

(3 February 1988, written on behalf of the Universal House of Justice to an individual believer) [4]

It must be remembered that Shoghi Effendi's translations carry with them a large measure of interpretation of the intent and purpose of the Author of the text he set about to translate—an interpretation which he, as Interpreter of the Sacred Text, could alone authoritatively provide.

(27 February 1989, written on behalf of the Universal House of Justice to a National Spiritual Assembly) [5]

You ask whether the translations of Shoghi Effendi should be considered as the “standard” and whether, because of his function as infallible interpreter, the Guardian's translations provide “the true interpretation of the Writings”. We are asked to call attention to the Introduction to “The Kitáb-i-Aqdas” where the Universal House of Justice describes the essential qualities of the Guardian's translations and the fact that they “are illumined by his uniquely inspired understanding of the purport and implications of the originals”.

(15 December 1994, written on behalf of the Universal House of Justice to an individual believer) [6]

The Universal House of Justice has received your letter dated 9 August 1999 in which you seek to know how soon will the Writings of Bahá'u'lláh be published in “the common language of standard English to facilitate teaching”. We have been asked to respond as follows.

The House of Justice appreciates your desire to make the Writings of Bahá'u'lláh accessible to your relatives and others who may dismiss them as illogical because of the style in which they are written. Nevertheless, to attempt to express the highly poetic, metaphorical and allusive terminology of the Bahá'í Writings in plain, modern English would either be banal or would render many of the passages strange and foreign. The Guardian's use of a style of

English that is slightly archaic, a style in which there is an abundance of spiritual and poetic terminology, acts as a bridge between the English of today and the style of the Persian and Arabic Writings of the Founders of our Faith.

In comparing the translation of the Bible with that of Bahá'í Texts, you may realize that the Hebrew of the Old Testament is far more blunt and straightforward than the Persian and Arabic of the Bahá'í Writings. Additionally, the koine Greek of most of the New Testament is the everyday speech of that time. The challenges posed to translators of the Bahá'í Writings are much more exacting than those that confront translators of the Bible. It is therefore not advisable to use one kind of translation as a standard for the other.

**The Difficult Art of Translation – Selected Extracts...**

25 July 2002

Page 4

Finally, although it is not possible to translate the Writings in a manner that brings them in conformity with the standards of common English, you may be confident that if the hearts of those to whom you present the Writings are ready, the style of the Sacred Texts will not stand as a barrier to their understanding and accepting the teachings.

(2 September 1999, written on behalf of the Universal House of Justice to an individual believer) [7]

## **Importance of and Guidance on Translating the Bahá'í Writings into Indigenous and Other Languages**

### **From the Writings of 'Abdu'l-Bahá**

Regarding the translation of the Books and Tablets of the Blessed Beauty, ere long will translations be made into every tongue, with power, clarity and grace. At such time as they

are translated, conformably to the originals, and with power and grace of style, the splendours of their inner meanings will be shed abroad, and will illumine the eyes of all mankind. Do thy very best to ensure that the translation is in conformity with the original. (“Selections from the Writings of ‘Abdu’l-Bahá”, number 31.13) [1]

### **From Letters written by the Universal House of Justice**

It is, of course, permissible to translate Bahá’í writings into other languages and dialects of languages. It is also possible to simplify or paraphrase the Bahá’í writings in order to facilitate their translation into languages and dialects having small vocabularies. However, it is not permissible to publish simplifications and paraphrases of Bahá’í writings as Bahá’í Scripture.

(13 March 1969 to a National Spiritual Assembly) [2]

With the exception of certain oriental languages such as Turkish, Arabic and Urdu, which are related to the original Persian or Arabic, new translations of the Sacred Text into languages

other than English must be made from the Guardian’s English translation where it exists.

When there is no translation into English by Shoghi Effendi of a particular passage, the National Spiritual Assembly concerned should seek the advice of the Universal House of Justice.

When translations already exist, which are not made from the Guardian’s English text, but have been

published and approved, they may be used.

(28 March 1971 to all National Spiritual Assemblies) [3]

The point is well taken that it would unduly delay fundamental Bahá’í teachings being published in a number of languages if we were to await the availability of Bahá’ís competent to

make the translations. Summaries, commentaries and simple re-statements of the Guardian’s writings, provided the text itself is not attributed to the Guardian, are to be encouraged.

(13 August 1972 to the Hands of the Cause of God in the Holy Land) [4]

We realise that translation is a very difficult task and that however good a translation is there are always differences of opinion, both as to accuracy and style. However, in

translating

Bahá'í Scripture it is important to remember that the style in the original is an exalted one and

this aspect should not be lost when it is translated into other languages. It can be noted, for example, that when the beloved Guardian was making his translations into English he used a style that is far from being that of modern English usage but is admirably suited to the richness

and imagery of the original.

(12 August 1973 to a National Spiritual Assembly) [5]

We have noticed a tendency in a number of countries to attempt to translate Bahá'í literature into the current, easy, everyday language of the country. This, however, should not be

## **Importance of and Guidance on Translating the Bahá'í Writings into Indigenous and Other Languages**

Page 2

an overriding consideration. Many of the Tablets of Bahá'u'lláh and 'Abdu'l-Bahá are in exalted and highly poetic language in the original Persian and Arabic and you will see, for example, that when translating Bahá'u'lláh's Writings into English the beloved Guardian did not use present-day colloquial English but evolved a highly poetic and beautiful style, using numbers of archaic expressions reminiscent of the translations of the Bible.

(7 October 1973 to a National Spiritual Assembly) [6]

As to Counsellor ...'s question in his letter of January 22, it may be pointed out to him that the translation and recording of some of the Holy Writings into native dialects not only helps the teaching work and pays honour to the native languages, but also provides the way to achieve an objective established by the Master and the beloved Guardian. Both 'Abdu'l-Bahá and Shoghi

Effendi often encouraged the friends to memorize passages from the Writings and such a practice acquires added importance in areas where there is a shortage of printed literature or a

high degree of illiteracy. Consequently, availability of passages from the Holy Writings in native dialects is an important aspect of a successful deepening programme.

(19 February 1975 memorandum to the International Teaching Centre) [7]

## **From Letters written on behalf of the Universal House of Justice**



In most languages each word has a range of meanings and also a penumbra of connotations. Certain of these overlap, giving rise to synonyms which are interchangeable in some contexts but not in others. It is seldom that there is an exact correspondence between the range of meanings and connotations of a word in one language and those of its nearest equivalent in another language. This lack of correspondence is particularly evident between the words of languages used in widely separate parts of the world or in very different cultures.

The House of Justice feels, therefore, that to construct a rigid list of Dutch words which are always used to translate certain other English words would not only be unnecessary but definitely misleading. As the beloved Guardian pointed out, the word “Bahá” signifies at once the “Glory”, the “Splendour” and the “Light” of God; there is no single word in English which can express all these. Thus, as you have noted, it is translated as “Glory” in the use “Bahá’u’lláh”, while in the list of the months, where “Jalál”, the second month, is translated “Glory”, “Bahá” is translated “Splendour”. All translations are, to some degree, inadequate.

Those who are entrusted with the task of translating the Sacred Writings from the original into English should study the original very closely, and then attempt to express as accurately and as beautifully as possible in English that which the original conveys. To do this they frequently have to use various different synonyms in English to give the best translation of the same Arabic or Persian word when it appears in different contexts. Conversely, they may have to use the same English word in different contexts to translate various different words in the original. In doing this they attempt to follow the example set by Shoghi Effendi in his magnificent translations.

The House of Justice suggests that, although your committee should, of course, follow the instruction of the Guardian to make your translations into Dutch from the English translations rather than from the original Persian or Arabic, you may find it helpful to consult Persian believers who are well-versed in Dutch and who could check with the original Texts for

## **Importance of and Guidance on Translating the Bahá’í**

## Writings into Indigenous and Other Languages

you. This could help you to make the correct choice of word in Dutch when the English wording seems ambiguous.

(31 May 1981 to a National Translation and Revision Committee) [8]

Translation is, indeed, a very difficult art, and ‘Abdu’l-Bahá has explained that, ideally, all translations of the Sacred Texts should be made by competent committees, rather than by individuals. At the present time, unfortunately, there is seldom in any country a large enough number of sufficiently skilled persons who can be called upon to constitute such committees, and the institutions of the Faith have to rely on the services of such individuals as they can find with adequate time and skill to undertake the arduous work of translation.

The Writings of the Faith are not in the nature of scientific treatises. One must remember that the Manifestation of God is using the inadequate instrument of human language to convey truths and guidance which can raise mankind high above its present level of development and understanding. He makes extensive use, therefore, of metaphor and simile, and often approaches a subject from several different points of view so that its various facets and implications can be better understood. It would not be possible, therefore, to compile a list of meanings for specific symbols, expressions and words, since they may vary in their implication from passage to passage.

The translation of a passage can seldom be an entirely faithful rendering of the original—one just has to strive to make it as faithful and befitting as possible. At the present time many of the translations of the Writings fall far below the desirable standard, especially in those languages spoken by a relatively small number of Bahá’ís, but time and an increase in the number of Bahá’ís who have a profound understanding of the Teachings as well as an exemplary command of the languages concerned will enable new and improved translations to be produced. For the time being we must do what we can with what we have.

(8 September 1985 to an individual) [9]

With regard to your question about the style of English used in the translation of Bahá’í prayers, we are asked to point out that finding an adequate style in English for expressing

beautifully the poetic, metaphorical and allusive style of many of the Bahá'í Scriptures is not easy. The Persian and Arabic of the Bahá'í Writings are themselves considerably different from the current styles and usages in those languages. Shoghi Effendi's solution of using a slightly archaic form of English, which is somewhat equivalent to the use in the original languages, makes possible the use of images and metaphors that might seem strange if expressed in modern English....

Books of Scripture themselves mould the language in which they are written. The House of Justice believes that if translators strive to render the words of the Báb, Bahá'u'lláh and 'Abdu'l-Bahá into English in a way that reproduces as accurately as possible the meaning of the originals, that is as beautiful as possible, and that harmonizes closely with the style used by

## **Importance of and Guidance on Translating the Bahá'í Writings into Indigenous and Other Languages**

Page 4

Shoghi Effendi, these Writings themselves will have a far-reaching effect on the ability of Bahá'ís, and especially Bahá'í children and youth, to use the English language effectively for thought and for expression.

(3 February 1988 to an individual) [10]

Of course the most fundamental requirement for the attainment of a good translation is the availability of a translator who has not only a thorough understanding of the original language, but also is able to write in clear and beautiful French, so that he can re-express in French not only the true meaning of the original, but can clothe it in language which appropriately reproduces in the French idiom the beauty of style of the original. While a literal translation is almost inevitably a bad translation, the translator must guard against departing from or adding to the meaning of the original even though he may have to use a phrase to translate a word, or reduce a phrase in the original to one word in the French, or recast the order

of a sentence, or replace a metaphor which would be meaningless if translated literally by an equivalent one which conveys the same meaning. In translating Shoghi Effendi's writings in particular you may find that many of his long sentences, which are perfectly clear in English, are impossible in French and must be divided into shorter ones.

If there is no French-speaking Bahá'í with the requisite command of both English and French, or if such friends are over-burdened, you may most certainly employ non-Bahá'í translators. Here, however, you may face another problem, that of the translator's understanding of the Bahá'í teachings which underlie the words. It would be essential for you to have such translations carefully checked by knowledgeable Bahá'ís, who can raise with the translator any passages which they feel convey the wrong meaning.

When you are having any of the Sacred Texts translated on the basis of authorized English translations, you should involve in the work one or more Bahá'ís who are fluent in French and are also familiar with the original Arabic or Persian. Thus, when the translator finds he is unable to grasp the exact meaning of the English words, his understanding can be illuminated by reference to the original texts.  
(2 December 1988 to a Bahá'í Publishing Trust) [11]

Translation is indeed a difficult issue, and it is for this reason that the official version of the messages and letters of the Universal House of Justice are sent in the original English. Any translation offered is unofficial and simply intended as an assistance to those who might wish to avail themselves of it, and National Spiritual Assemblies are free to make their own translation in accordance with local language needs. This also applies to the statement on Bahá'u'lláh which the House of Justice requested you to translate into Chinese.  
(7 August 1991 to an individual) [12]

You ask what is the purpose and wisdom of the translation of the Bahá'í Writings, and what is the philosophy behind it.

As you know, one of the principles of the Bahá'í Faith is for a single language to be adopted as the universal auxiliary language of mankind, to be taught in the schools of all the

nations. When that time comes, the need for so many translations will be greatly reduced, since there will be one common medium of communication for all who dwell on earth. Alas, however, it will take some time yet for the governments of the world to adopt such a far-reaching and fundamental measure.

### **Importance of and Guidance on Translating the Bahá'í Writings into Indigenous and Other Languages**

Page 5

In the meantime it is essential for the Bahá'ís to convey the Word of God to all the peoples of the world, as quickly and as completely as possible. For this, translation is essential.

The Writings of the Báb and Bahá'u'lláh are, as you know, in Arabic and Persian, as are those of 'Abdu'l-Bahá Who also wrote some Tablets in Turkish. Shoghi Effendi, for his part, wrote

many of his most important works in English. To expect the Japanese Bahá'ís to learn Arabic,

Persian and English sufficiently well to really understand the Bahá'í literature in those three tongues would be too great a demand. Fortunately, there is already a wealth of the Arabic and

Persian Writings translated into English, but even if the friends' command of English is sufficiently good for them to fully comprehend such Writings, there is an important emotional

and psychological advantage to their being able to read the Word of God in their own mothertongue. Thus we engage in translating the Writings into even tribal languages which have quite a small number of native speakers.

(14 December 1992 to an individual) [13]

Your letter of 9 May concerning the translation of Bahá'í literature into Georgian has been received and we have been instructed to reply as follows.

You have asked whether Bahá'í literature should be translated from English or Russian.

In principle, the desirable course is to translate from English, as the English translations have been made by the Guardian or authorized by the Bahá'í World Centre. If this is not practical at

the moment, then provisional translations can be made from Russian until such time as proper

translations from English can be prepared. Such a solution is far better than waiting and

being

without Bahá'í literature in the native tongue of your region.

(23 May 1995 to a National Spiritual Assembly) [14]

Equally important is the right of the members of indigenous populations to learn, speak, write and communicate in their native tongue, if they so wish, in addition to the official language of the country in which they reside, for language is the expression of the spirit of a people and the vehicle of its cohesive and inspiring traditions. Facility in one's native language

in addition to the official language of one's country can produce an enrichment of the heritage

of the entire people and can act as a stabilizing influence in society, while the cultural oppression which seeks to obliterate minority languages can have a deracinating and demoralizing effect that will be very difficult to correct. Furthermore, Bahá'ís advocate the development or adoption of an international auxiliary language by which all the peoples of all

countries and cultural backgrounds will be able to communicate.

(25 July 1995 to an individual) [15]

THE UNIVERSAL HOUSE OF JUSTICE  
DEPARTMENT OF THE SECRETARIAT

Bahá'í World Centre • P.O. Box 155 • 31 001 Haifa, Israel

Tel: 972 (4) 835 8358 • Fax: 972 (4) 835 8280 • Email: [secretariat@bwc.org](mailto:secretariat@bwc.org)

15 August 2002

Transmitted by email: nsonger@sc.rr.com  
Mrs. Nancy Branham Songer  
U.S.A.

Dear Bahá'í Friend,

The Universal House of Justice has received your email dated 28 July 2002, and referred it to our Department for response. In answer to your request for materials on universal auxiliary language and universal language, we are providing for your use two documents which address these general concepts, namely, an extract from a Research Department memorandum dated 7 July 1994, and its attachment entitled "The Principle of an International Auxiliary Language". You may also find of interest the enclosed documents "International Auxiliary Language", providing references to this topic in the Bahá'í writings, and "Bahá'í World Centre Library: A Partial Bibliography of Published Works on an Auxiliary Language", which lists some papers by Bahá'ís on this subject.

Regarding your request for guidance on translating the Bahá'í Writings, we trust that the Research Department's memorandum dated 25 July 2002, and its accompanying enclosures, which were previously sent to you by email, will provide ample information on this topic.

You have asked that email attachments be sent to you in a form other than Portable Document Format (PDF), such as Microsoft Word format. As it is the practice for communications from the Bahá'í World Centre to be sent in only two formats, namely, plain text (ASCII) and PDF, we regret that we are unable to provide electronic copies of the above documents in any other form.

We hope that you will be able to glean adequate information from these materials to assist you in your endeavors to make a presentation at the upcoming Association for Bahá'í Studies conference.

With loving Bahá'í greetings,  
Department of the Secretariat

Enclosures

**Extract from a Research Department memorandum dated 7 July 1994**

The Research Department has studied the questions concerning an international auxiliary language raised by.... He expresses the view that there is an urgent need for the world to adopt an international auxiliary language and for the Bahá'ís to be in the forefront of helping to make this a reality. He indicates a willingness to spend time researching and promoting this undertaking, and to this end, he raises a number of issues about the nature of such a language, its promotion and its relationship to the Lesser Peace....

1. An International Auxiliary Language

-  
We attach a compilation of extracts entitled "The Principle of an International Auxiliary Language" which addresses, in broad terms, the issues raised by Mr. ... and which serves as the basis for the comments which follow. There are, of course, many other references in the published Writings and in the talks given by 'Abdu'l-Bahá during His travels in the West, many of which were collected in Paris Talks and The Promulgation of Universal Peace. Additional talks on this subject can be found in a number of the volumes of Star of the West, for example:



volume III, no. 3, pp. 23-24

volume III, no. 19, p. 5

volume IV, no. 2, pp. 34-37

In addition, there is a chapter on the universal language in Payám-i-Malakút, a compilation prepared by Mr. Ishráq-Khávarí. Some of the Persian friends living in ... would, undoubtedly, have a copy of this book.

### 1.1 Degree of Priority?

With regard to the role of the Bahá'ís in promoting an international auxiliary language, Mr. ... enquires about the degree of priority that the believers should give to this activity at this point in time. We call attention to the following points, gleaned from the attached compilation:

- Shoghi Effendi underlines the importance of an international auxiliary language. In a letter dated 24 April 1939, written on his behalf, he refers to it as “an indispensable element in the upbuilding of the coming New World Order”.

- The Guardian summarizes the “whole question of an international language and its relation to the Faith” in the following extract from a letter dated 17 October 1944, written on his behalf to an individual believer:

We, as Bahá'ís, are very anxious to see a universal auxiliary tongue adopted as soon as possible; we are not the protagonists of any one language to fill this post. If the Governments of the world should agree on an existing language, or a constructed, new tongue, to be used internationally, we would heartily support it because we desire to see this step in the unification of the human race take place as soon as possible.

- The Universal House of Justice in a letter dated 2 June 1982 written on its behalf indicated that “the important thing now ... is for the Bahá'ís to promote the principle” of an international auxiliary language. It invited individual believers, who have “a particular

interest in this subject” and who feel so inclined, to study Esperanto.

- With regard to overall priorities, in a letter dated 2 March 1976 written on its behalf, the Universal House of Justice stressed the importance of “teaching the Cause and winning the goals of the ... Plan”.

## 1.2 The Nature of an International Auxiliary Language

Mr. ... enquires whether the Universal House of Justice sees the immediate need for creating or adopting a complex language, suited to “the exchange of ideas and the advancement of understanding at scientific, technological, commercial, literary and translation levels,” or the development of “truly a universal ‘second language’” that would enable people “to communicate on a merely social level”. We wish to note that, in the first instance, the governments of the world will select the international auxiliary language. See section 1.3 below for a discussion of the timing of the adoption of an international language.

In a more general sense, Mr . ...’s question impinges on the subject of the nature of an international auxiliary language. Though the extracts contained in the attached compilation deal mostly with Esperanto, they appear to shed some light on the potential complexity of and the functions which such a language might be expected to serve. For example:

- Shoghi Effendi, in letters written on his behalf, appears to have regarded Esperanto as a vehicle for “introducing the Teachings into important social and intellectual circles” (28 May 1937). He called upon the believers “to learn it and to translate Bahá’í literature into it” (17 October 1944), and he recognized its value in fostering “unity and understanding” (5 April 1947).

- ‘Abdu’l-Bahá envisaged the development of a language “more complete” than Esperanto, as it existed at that time. The Guardian indicated that the international language of the future was to serve as “an international medium of communication” (26 December 1936), as “a medium of exchange between the nations and peoples of the world” (4 June 1937). And, the Universal House of Justice indicated that it would “be used in all international commerce” (8 June 1980).

The following two extracts from letters written on behalf of Shoghi Effendi ... are also of

interest as they were responses to questions from individuals about the suitability of specific languages to serve as an auxiliary language. The final sentence of the first excerpt appears to contain a general principle to guide the selection of an international language:

He was interested in your efforts to make the English language, which undoubtedly is the most generally spoken and widely understood, the world's auxiliary language, and we must wait and see how other European nations receive it. Of course as you had well put it, the mere existence of prejudice is no argument against the possibility of making an existing language universal. The world must try to overcome its many defects and not reinforce it. Perhaps the main consideration in future will be the specific qualities of a language as being exact, rich and easy to learn for both East and West.  
(18 May 1928 to an individual believer)

Regarding your question of "Basic English's" usefulness as an international language: He is not very familiar with it, as he is too preoccupied with the tremendous amount of work he has to do here. But what little he has read about it makes him doubt whether it would ever be adequate to meet the requirements of an auxiliary tongue.  
(30 June 1944 to an individual believer)

### **1.3 Relationship to the Lesser Peace**

Mr. ... asks whether the adoption of an international auxiliary language will be one of "the most important steps that needs to be taken to bring about the Lesser Peace" or whether it will be adopted "as a result of the process of establishing such a political peace". Before addressing this issue it is important to consider the way in which the international auxiliary language will be adopted. In a letter dated 8 June 1980 written on its behalf to an individual believer ... the Universal House of Justice calls attention to two stages in this process:

...there are two different provisions in the Sacred Texts for the selection of an International Auxiliary Language. On the one hand, this task is given to the governments of the world, on the other it is given to the House of Justice. It is not possible now to foresee exactly how this will come about, but it would seem reasonable to suppose that, long before the Bahá'í community is large enough or can exercise the authority to produce such a world-embracing change, events will compel the governments, either progressively or all in concert, to select an International Auxiliary Language to be taught

as a second language in all schools and to be used in all international commerce. At a much later stage, possibly at the time of the Bahá'í World Commonwealth, the Universal House of Justice may well decide to review the situation and either confirm the decision that the governments had made, or change the choice to a more suitable language.

As to whether the adoption of an international auxiliary language is a prerequisite to the Lesser Peace, the Research Department has not been able to locate any clear statement in the Bahá'í Writings that relates specifically to this question. It is, however, interesting to note that

the Universal House of Justice in the Peace Statement identifies a “fundamental lack of communication between peoples” as a factor which “seriously undermines efforts towards world peace”. And the House of Justice indicates that the adoption of an international auxiliary language “would go far to resolving this problem and necessitates the most urgent attention”.

## **THE PRINCIPLE OF AN INTERNATIONAL AUXILIARY LANGUAGE**

The difficulties of international communication in a polyglot world are strikingly evident to any Bahá'í who has gone travel teaching to foreign lands or has attended international conferences. The Universal House of Justice feels that for it to choose any language for the Bahá'ís to use as an international auxiliary language would give rise to greater difficulties

than  
 would thereby be solved at the present time. The friends, however, remembering that this is one of the very important principles of the Faith, would do well to support the concept whenever possible, and to pray that the time is not far removed when the governments of the nations will adopt a single language to be taught in all the schools of the world as an auxiliary  
 to the pupils' mother-tongue. This compilation has been prepared at the World Centre of the Faith, on instruction of the Universal House of Justice, to assist the friends everywhere to arrive  
 at a greater understanding of this principle, to which 'Abdu'l-Bahá addressed Himself in a number of His talks in the West.

### **From the Writings of 'Abdu'l-Bahá**

Thou hast written regarding the language of Esperanto. This language will be spread and universalized to a certain degree, but later on a language more complete than this, or the same  
 language will undergo some changes and alterations and will be adopted and become universal.

I hope that Dr. Zamenhof may become assisted by the invisible confirmation and do a great service to the world of humanity.

(Tablets of Abdul-Baha Abbas, vol. 3 (Chicago: Bahá'í Publishing Committee, 1930 printing), p. 692) [1]

As to the Esperantists, associate with them. Whenever you find one with capacity, convey to him the fragrances of Life.... It is evident that the Esperantists are receptive and thou  
 art familiar with and expert in their language. Communicate also with the Esperantists of Germany and other places.... Grieve not over the apathy and coldness of the Hague meeting. Put thy trust in God. Our hope is that among the people the Esperanto language may hereafter  
 have a powerful effect. Thou hast now sown the seed. Assuredly it will grow. Its growth dependeth upon God.

(Selections from the Writings of 'Abdu'l-Bahá (Haifa: Bahá'í World Centre, 1982), sec. 228, p. 308) [2]

### **From letters written on behalf of Shoghi Effendi**

What Bahá'u'lláh says is that the Supreme House of Justice will appoint a committee that will study the whole matter and then either choose one of the existing languages or create a new one, to function as an international language. The Master never went beyond that, i.e. He never tried to solve the problem Himself and choose that language. He still leaves it to the Supreme House of Justice. But He says that Esperanto will spread and even went so far as to encourage all the friends who possibly can to study it. In fact the knowledge of Esperanto has proven very useful for one who tries to teach in different countries of the world. But whether Esperanto will become the international language which is to be a part of our religious and social duties to

## **THE PRINCIPLE OF AN INTERNATIONAL AUXILIARY LANGUAGE** Page 2

study, no one knows, and we have no evidence that the Master made any definite statement along that line. The Master has scarcely ever assumed the solution of a problem that Bahá'u'lláh has referred to the Supreme House of Justice. Esperanto may become an international language, but it depends upon the House of Justice to choose it as the international language. And no one is in a position to foretell.  
(30 August 1928 to an individual believer) [3]

As to your suggestion regarding a more widespread use of Esperanto among the Bahá'ís as a medium of correspondence, Shoghi Effendi, as you know, has been invariably encouraging the believers, both in the East and in the West, to make an intensive study of that language, and to consider it as an important medium for the spread of the Cause in international circles. He has been specially urging the friends to have the Cause well represented in all Esperanto

Congresses and associations, and by this means cultivate greater friendship and co-operation between them and the Esperantists.

But in this connection, he feels, he must make it clear that although the Cause views with much sympathy and appreciation the activities which the Esperantists are increasingly initiating for the spread of their language, yet it considers that the adoption of Esperanto by the entire world is by no means an inevitable fact. Neither Bahá'u'lláh, nor even 'Abdu'l-Bahá, ever stated that Esperanto will be the international auxiliary language. The Master simply expressed the hope that it may, provided certain conditions were fulfilled, develop into such a medium. (3 August 1935 to an individual believer) [4]

Concerning your study of Esperanto: the Guardian does not feel it advisable that you get too busy introducing any changes in that language, as this is not only a type of activity for which you are not qualified, but is also void of any use or advantage as far as your Bahá'í work is concerned, in view of the fact that it is by no means certain that Esperanto will necessarily develop into the world auxiliary language referred to by Bahá'u'lláh in His writings. (17 April 1936 to an individual believer) [5]

Regarding the teaching of Esperanto: the Guardian thoroughly appreciates the efforts you are exerting for the spread of this language, and fully realizes that through them you can find many openings for teaching the Cause. He wishes me, however, to bring to your attention the fact that neither Bahá'u'lláh nor 'Abdu'l-Bahá did specifically state that Esperanto would certainly become the international auxiliary language of the future. Neither did they enjoin its teaching upon the believers. What 'Abdu'l-Bahá chiefly did was to highly praise it, and to reveal its possibilities. The teaching of Esperanto is, therefore, not a command or an obligation in the sense that praying is for instance. What is enjoined by Bahá'u'lláh is either the creation of a new language, or the adoption of one of the existing languages for use as an international medium of communication. Let us hope that Esperanto may some day develop into such a medium. (26 December 1936 to an individual believer) [6]

As to your question as to what constitutes indirect teaching: it essentially consists in presenting some of the humanitarian or social teachings of the Cause which are shared by those whom we are teaching, as a means of attracting them to those aspects of the Faith which are

### **THE PRINCIPLE OF AN INTERNATIONAL AUXILIARY LANGUAGE** Page 3

more challenging in character, and are specifically and solely Bahá'í. The teaching of Esperanto, for instance, has been a very useful way of presenting the Cause indirectly to many people. It has opened many doors of contact for the believers, and has lately proved to be of tremendous help in introducing the Teachings into important social and intellectual circles. (28 May 1937 to an individual believer) [7]

Regarding the subject of Esperanto: it should be made clear to the believers that while the teaching of that language has been repeatedly encouraged by 'Abdu'l-Bahá there is no reference either from Him or from Bahá'u'lláh that can make us believe that it will necessarily develop into the international auxiliary language of the future. Bahá'u'lláh has specified in His Writings that such a language will have either to be chosen from one of the existing languages, or an entirely new one should be created to serve as a medium of exchange between the nations and peoples of the world. Pending this final choice, the Bahá'ís are advised to study Esperanto only in consideration of the fact that the learning of this language can considerably facilitate intercommunication between individuals, groups and Assemblies throughout the Bahá'í world in the present stage of the evolution of the Faith. (4 June 1937 to a National Spiritual Assembly) [8]

One thing, however, the Guardian feels the believers should be very careful to avoid in all such contacts with the Esperantists: namely that of giving them the impression that they consider Esperanto as necessarily constituting that international auxiliary language of the



future  
referred to by Bahá'u'lláh and stressed by Him as an indispensable element in the upbuilding  
of  
the coming New World Order.

To give them such a false conception of the true Bahá'í attitude regarding the choice of  
the future world international language would not only be an act of dishonesty and disloyalty  
towards the Cause, but would lead to serious misunderstandings and misapprehensions, and  
eventually result in counteracting the effect of any temporary gains or advantages which may  
accrue to the Faith through such association and contacts with the Esperantists.

It is not so much that language as the central idea it embodies and inculcates which the  
Bahá'ís endorse, and only through keeping firm to such an attitude can they hope to establish  
any fruitful and enduring contacts with various Esperanto groups and associations  
throughout  
the world.

(24 April 1939 to an individual believer)

[9]

He feels that this is a very important opportunity which you have now obtained of  
teaching the Faith to the Eskimo people, and he hopes your efforts will be crowned with  
success.

He would not advise you to teach them Esperanto, as we have no way of knowing  
whether it will ultimately be chosen as the auxiliary language of the world. He thinks the  
most  
direct and quickest way of communicating with them in a common tongue should be chosen;  
in  
other words either you should learn their language or they yours, whichever will yield the  
quickest results.

(12 December 1942 to an individual believer)

[10]

We have no authentic record of ‘Abdu’l-Bahá’s in which He states that Esperanto will be the universal language of the future. It may be Esperanto, it may be some other language, we do not know; but as we believe so firmly in the necessity of an international language, we are always eager to co-operate with the Esperantists.

The thing of primary importance at present, especially in America, is the teaching of the Cause. With good will and determination an auxiliary language—especially one of the nature of Esperanto—can easily, and relatively quickly, be learned; whereas the Cause requires that people change not only certain ideas but their very characters and habits, and this is much harder to do and often takes a long time!  
(25 January 1943 to an individual believer) [11]

Regarding the whole question of an international language and its relation to the Faith: We, as Bahá’ís, are very anxious to see a universal auxiliary tongue adopted as soon as possible; we are not the protagonists of any one language to fill this post. If the Governments of the world should agree on an existing language, or a constructed, new tongue, to be used internationally, we would heartily support it because we desire to see this step in the unification of the human race take place as soon as possible.

Esperanto has been in wide use, more so than any similar language, all over the world, and the Bahá’ís have been encouraged by both the Master and the Guardian to learn it and to translate Bahá’í literature into it. We cannot be sure it will be the chosen international language of the future; but as it is the one which has spread most, both East and West, we should certainly continue to co-operate with its members, learn to speak it and translate Bahá’í literature into it.

He feels you can rest assured that ‘Abdu’l-Bahá’s statement, made in Paris, was prompted by His insight and wisdom and not due to the opinions of anyone else. Naturally the money of the Cause should not be spent on translating and publishing literature in international languages that have no following worth mentioning!  
(17 October 1944 to an individual believer) [12]

He feels that the subject of the Bahá’í work in Esperanto in Germany is a matter for you to take up with the National Spiritual Assembly; we Bahá’ís do not claim Esperanto will be

the  
 auxiliary language of the future—but, as we firmly believe in the necessity of an auxiliary  
 language, we are glad to support this work by publishing books in Esperanto and  
 encouraging  
 the Bahá'ís to learn it, if they wish to. Co-operation with this society is an excellent means of  
 spreading the Cause, as Martha Root demonstrated in her travels. However, all details in this  
 matter must be decided by the National Spiritual Assembly. You can contact Bahá'í  
 Esperantists in England and the U.S.A. through their respective National Spiritual  
 Assemblies.

(29 July 1946 to an individual believer)

[13]

Regarding your question about the Esperantists: for many years they have been one of  
 our closest contacts in Europe, and many of them have become believers. They are working  
 for  
 one of our greatest principles, and we certainly should associate with them. In Germany the

## **THE PRINCIPLE OF AN INTERNATIONAL AUXILIARY LANGUAGE** Page 5

Bahá'ís published an Esperanto magazine, and Martha Root represented the Cause at  
 Esperanto  
 congresses. We cannot say we are sure this language will be the international one, but we are  
 anxious to see it spread as it fosters unity and understanding. By all means foster your  
 contact  
 with them. Whether Esperanto will be chosen as the international language or not we cannot  
 say, but we can say we hope it will spread because it nearly fulfils such a noble purpose.

(5 April 1947 to an individual believer)

[14]

He was also very pleased to see the contact with the Esperantists is being maintained.  
 This friendly co-operation with them, and attendance at their Congresses, is very good, and  
 will  
 no doubt bring the Bahá'í Cause to many of their members' attention. Also, he hopes, it will  
 lead to many of them becoming Bahá'ís in the future.

(24 March 1949 to an individual believer)

[15]

## From letters written by or on behalf of the Universal House of Justice

Your letter of 9 'Aimat, 128 expressing your feeling that the endorsement by the Universal House of Justice of an international auxiliary language for Bahá'í conventions would not prejudice any future World Government in its choice of world-wide tongue for official use, and that Esperanto is widely used by clerical, businessmen's and scientific conventions, has been received.

Regarding your first comment, inasmuch as Bahá'u'lláh has said that the Supreme House of Justice will appoint a committee that will study the whole matter and then either choose one of the existing languages or create a new one to function as an international language, when such a choice shall have been made the action will automatically constitute an endorsement of the chosen auxiliary language.

With reference to Esperanto, we share with you an excerpt from a letter written on behalf of the beloved Guardian by his secretary to an individual in 1937:

The interest which the Bahá'ís have and should have in this language is essentially because of the vital significance of the idea it represents rather than the belief in its inherent worth as a suitable and adequate international medium of expression.

The Bahá'ís indeed welcome Esperanto as the first experiment of its kind in modern times. They are in full sympathy with the Esperantists in so far as they stress the absolute necessity for the creation of an international language to be studied by all the peoples of the world in addition to their respective national languages.

As to the most propitious time for the choosing of an international auxiliary language, we feel that it is not feasible for the House of Justice to make the choice at this time.  
(8 June 1971 to an individual believer) [16]

We have consulted about your joint proposal for the formation of a League of Bahá'í Esperantists, a "Bahá'í Esperantista Ligo" (BEL), and have sought the advice of the Hand of the Cause Adelbert Mühlischlegel because of his long interest in Esperanto as an approach to

overcoming the language obstacles which confront the world. He is enthusiastic. And we

## **THE PRINCIPLE OF AN INTERNATIONAL AUXILIARY LANGUAGE** Page 6

concur that such a League would be helpful to the Faith as well as providing a useful channel for teaching Esperantists the world over.

1. You are free to name the League as you have suggested. The significance of the initials is a happy sign.
2. Responsibility for the League will be exercised by the National Spiritual Assembly of the country in which the secretariat is established. You have suggested that, at the outset, the secretariat of the new League might be in Brazil, under Professor Paul Amorim Cardoso as Secretary. In that case the National Spiritual Assembly of Brazil will assume jurisdiction of the League in whatever ways may be required during Professor Cardoso's tenure.
3. Whenever there are Esperantist events, congresses and the like, in various lands, the National Assemblies of those countries should be informed of the prospective Bahá'í participation, their permission requested and their instructions followed with respect to any Bahá'í activities at the congresses. For example, for the forthcoming *Universala Esperanto-Kongreso* in Belgrade, you should seek the advice and follow the guidance of the National Spiritual Assembly of the Bahá'ís of Austria, which has jurisdiction over Bahá'í activities in Yugoslavia, as well as in Hungary and Czechoslovakia.
4. You may, of course, publish whatever literature in Esperanto the League will be able to afford, remembering that each publication must be reviewed and approved by the National Spiritual Assembly in whose area it is to be published. Such an Assembly may well, of course, use members of the League to review the translations. We ourselves shall bear in mind the need for increased literature in Esperanto, but the needs for literature in so many languages is pressing and we cannot hold out hope of providing any considerable amount of financial assistance at this time.
5. A request for special messages by National Assemblies or by the Universal House of Justice may be made by the League as a part of its function of dissemination of the name and principles of the Faith.

Your zeal on behalf of Esperanto as a functional international language will, we feel, be well rewarded by the entry into the Faith of many of your Esperantist associates who will thus take the step from universality in language to the greater universalities of one religion and one mankind. We assure you of our prayers for your labors on behalf of our matchless Cause. (19 March 1973 to a group of Bahá'í Esperantists) [17]

As English and Persian are the two official languages of the Universal House of Justice we regret that we cannot write to you in Esperanto but we will be glad to enclose an Esperanto translation of our letter for you in view of the fact that you do not understand English well. We hope that it will be possible for Mr. Habibullah Taherzadeh to make such translations if his time allows.

With regard to the enquiry in your letter of 11 Jalál, our understanding of the aim of the Bahaa Esperanto-Ligo when we agreed to its formation was that it was to be an official nonneutral department of the Universal Esperanto Association comprising those Esperantists who are also Bahá'ís with the aim of encouraging collaboration among such friends and promoting the Bahá'í teachings among their fellow Esperantists.

## **THE PRINCIPLE OF AN INTERNATIONAL AUXILIARY LANGUAGE** Page 7

While individual Bahá'í Esperantists are, of course, free to encourage their fellow Bahá'ís to study Esperanto this should not be an activity of the Bahaa Esperanto-Ligo and it should be borne in mind that whereas it is clear that the Bahá'í Faith upholds the principle of an international auxiliary language no decision as to which language this shall be has yet been made.

(10 May 1974 to the Secretary of the Bahaa Esperanto-Ligo) [18]

Further to our letter to you of 2 December 1974, and with reference to your question on the world language, the Universal House of Justice has asked us to draw your attention to the

statement of Bahá'u'lláh in the Eighth Leaf of the Exalted Paradise (see Bahá'í World Faith, p. 182): “We have formerly declared that speech was decreed to be in two languages, and that there should be an effort to reduce it into one.”

When the beloved Guardian was asked by an individual believer about the meaning of this passage, his secretary gave the following reply on his behalf:

What Bahá'u'lláh is referring to in the Eighth Leaf of the Exalted Paradise is a far distant time, when the world is really one country, and one language would be a sensible possibility. It does not contradict His instructions as to the need immediately for an auxiliary language.

(29 December 1974 to a National Spiritual Assembly)

[19]

The House of Justice instructs us to say in reply to Mr. ...’s letter to the Local Spiritual Assembly of ... that he should be advised that the time has not yet come for the Universal House of Justice to take any such step as he suggests. There is no doubt of the vital importance

of the establishment of a universal language and it will inevitably come about but the believers

have more urgent matters to attend to at the present and are asked to concentrate on teaching the

Cause and winning the goals of the Five Year Plan.

(2 March 1976 to a National Spiritual Assembly)

[20]

The House of Justice realizes that you must sometimes be faced with somewhat embarrassing situations in relation to your fellow-Esperantists since, as Bahá'ís, you are fully

aware that, for all its undoubted qualities, Esperanto may well not be the international language

that is ultimately chosen, and that it is the concept of an international language that the Bahá'ís

are enthusiastic in supporting rather than any particular solution to the problem.

The Guardian’s advice that Bahá'ís must be entirely open about this matter in relation to Esperantists so as to avoid serious misunderstandings and misapprehensions in the future will

no doubt be of great assistance to you in your work and enable you to forge ahead with full

enthusiasm without, in any way, appearing to sail under false colors.

(6 October 1976 to the Bahaa Esperanto-Ligo)

[21]

You are quite correct in stating that there are two different provisions in the Sacred Texts for the selection of an International Auxiliary Language. On the one hand, this task is given to the governments of the world, on the other it is given to the House of Justice. It is not possible

## **THE PRINCIPLE OF AN INTERNATIONAL AUXILIARY LANGUAGE** Page 8

now to foresee exactly how this will come about, but it would seem reasonable to suppose that, long before the Bahá'í community is large enough or can exercise the authority to produce such a world-embracing change, events will compel the governments, either progressively or all in concert, to select an International Auxiliary Language to be taught as a second language in all schools and to be used in all international commerce. At a much later stage, possibly at the time of the Bahá'í World Commonwealth, the Universal House of Justice may well decide to review the situation and either confirm the decision that the governments had made, or change the choice to a more suitable language.

Of course, conditions may produce a development very different from the one just outlined. One of the characteristics of Bahá'í Administration is its flexibility which enables it to deal with unforeseen developments and continually changing conditions. The one certain thing about the choice of an International Auxiliary Language is that the Universal House of Justice does not judge the present time propitious for it to take any action in this regard.  
(8 June 1980 to an individual believer)

[22]



It is not yet timely for the House of Justice to make a pronouncement in favour of any particular language—the important thing now, in this particular field, is for Bahá'ís to promote the principle. Learning Esperanto, or one of the other proposed auxiliary languages, brings one into touch with people all over the world who are conscious of the need, who are internationally minded, and who may well be attracted to the Faith. Therefore, if you have a particular interest in this subject and an inclination to study Esperanto, you should feel no inhibitions about doing so.  
(2 June 1982 to an individual believer) [23]

## INTERNATIONAL AUXILIARY LANGUAGE

‘Abdu’l-Bahá’s talks on this subject are found as follows:

Paris Talks	pp. 155–157
Promulgation of Universal Peace (1982 ed.)	60–61, 182, 232–233, 300, 318, 434–435
Star of the West	
Vol. III, no. 3, pp. 23–24	Message to the Esperantists, 25 April 1912 Also vol. XI, no. 18, p. 304
Vol. III, no. 19, p. 5	Report of comments made to the president of the Esperantists of England
Vol. IV, no. 2, pp. 34–36	Address delivered in Edinburgh on 7 January 1913
Vol. IV, no. 2, pp. 36–37	Address delivered in Paris on 12 February 1912

The following references are to be found in other Bahá’í Writings:

Gleanings (U.S. ed.)	pp. 249–250
Epistle to the Son of the Wolf	138
Tablets of Bahá’u’lláh	22, 68, 89, 127, 165–166
Bahá’í World Faith	288
Tablets of ‘Abdu’l-Bahá, Vol. III	596
God Passes By	211, 218
World Order of Bahá’u’lláh	203

BAHA'I WORLD CENTRE LIBRARY  
A PARTIAL BIBLIOGRAPHY OF PUBLISHED WORKS  
ON AN AUXILIARY LANGUAGE

3 September 1991

Bahaa Esperanto-Ligo. Ask a question, get an answer, about the world inter-language Esperanto. —[Rotterdam, Netherlands] : Bahaa Esperanto Ligo, [1988]—[3] leaves.

Conference on Language in Religion (1987 : Paramus, N.J.) Language in religion / papers from  
from  
a conference sponsored by the Center for Research and Documentation on World Language  
Problems (Rotterdam and New York) ; edited by Humphrey Tonkin and Allison Keef.  
—New  
York : Center for Research and Documentation on World Language Problems, 1988—[2],  
141  
leaves.

Dale, John. Unity and a universal language : world means to world peace / by John Dale.—  
Ceará Brazilo : Eldono de Bahaa Esperanto-Ligo, 1976—30 p.

Dale, John. Unueco kaj universala lingvo : mondrimedoj al monpaco / de John Dale ; trduko  
de Roan Orloff Stone. —Ceará, Brazil : Eldono de la Bahaa Esperanto-Ligo, 1976—29 p.  
[Unity and a universal language. Esperanto]

Davidson, John A. World peace through world language / by John A. Davidson. --In: Bahá'í Studies Conference (6th : Brisbane, Qld.). Proceedings of the Bahá'í Studies Conference, 1987 : [Willeton, W.A.] : The Association for Bahá'í Studies (Australian Committee), 1987—  
153 p.

Esperanto language and the Bahá'í Faith / compiled by Habib'u'llah Zabihian. —Espoo, Finland : [Zabihian], 1983—3 leaves.

Esslemont, Peter. Wanted, universal language : the story of Esperanto.  
-- In: Outlook, the voice of the Brotherhood Movement, (Apr. 1956), pp. 3–4.

Esslemont, Peter. Zamenhof and Esperanto / by Peter Esslemont. --Sandgate, U.K. : Edmund Ward Pub. Ltd., [between 1945 and 1960]—[16] p.

Gaskell, R.F. The International auxiliary language situation / by R.F. Gaskell.—In: Bahá'í Studies Conference (5th : Yerrinbool, N.S.W.). Proceedings of the Bahá'í Studies Conference, 1986 : [Willeton, W.A.] : The Association for Bahá'í Studies (Australian Committee), [1987]—122 p.

Heller, Wendy, 1949-. Universal language, a Baha'i perspective / Wendy Heller. —[United States : Heller, 1987]—10 leaves.

National Spiritual Assembly of the Bahá'ís of Tonga. The Baha'i viewpoint - a universal language = Ko e vakai 'a e tui Baha'i : lea 'e taha ma'a mamani. —Nuku'alofa : National Spiritual Assembly of the Bahá'ís of Tonga, [1988]—[2] p.

Pettersen, Arild. The Baha'i Faith and universal language. —[Brooklyn, N.Y. : Pettersen], 1987—15 leaves.

### Published Works on an Auxiliary Language

Semple, Ian, 1928-. An International auxiliary language / Ian Semple. --In : English today (Cambridge, U.K.), no.9 (Jan. 1987), pp. 18–19.

Shahrokh, Roya June. Proposal for the Bahá'ís to initiate the process for the selection of the international auxiliary language by the governments of the world / Ms. Roya June Shahrokh. —Fair Oaks, Calif. : Shahrokh, 1989 --14, [2] p.

Symposium on Bahá'í Education (Birmingham, U.K.), 2nd. Trends in Bahá'í education : proceedings of the second symposium on Bahá'í education, Birmingham 1989 / edited by Hooshang Nikjoo. —London : Bahá'í Publishing Trust, c1990—vii, 238 p. ; 24 cm.

Witzel, Donald R. The Movement towards a universal auxiliary language, 1532-1977 / by Donald R. Witzel. —Maracaibo, Venezuela : Witzel, 1977 --i-ii, 46, iii-iv leaves.

**MENU:** [HOME](#) » [Reconstruction](#) » [Recovery](#) » [Renewal](#) » [Language Main Page](#)

---

---

# ESSENTIAL WORLD ENGLISH [ewE]

Being a preliminary mnemotechnic programme]  
for proficiency in English self-expression]  
for international use,]  
based on semantic principles

© by

Lancelot Hogben FRS, Honorary Senior Fellow in Linguistics,  
Birmingham University  
with the assistance of Jane Hogben and Maureen Cartwright  
London. Michael Joseph. 1963

Précis by Doug Everingham 1997.

## **SR1 [Lindgren's Spelling Reform step One] used:**

Thus any clear short vowel used as that in hemorrhage and led may here be read as e instead of any spellings wider spread, as approved by a Sydney Morning Herald Education Supplement, a Teachers' Federation and other journals and Australia's two Nobel laureate Fellows of the Royal Society: Sir Mark Oliphant, Sir Macfarlane Burnet.

## **The aim:**

decimate social costs (illiteracy &c.) of old spellings by reviving their prime purpose: recording sound categories as pronouncing dictionaries do despite local brogue etc. versions of the tongue. English spelling lags centuries behind language merger and change, and anglophone resistance to scriptage debate is increasing anglophone illiteracy, already four times that of Finnish and other updated scriptages.

[J Simpl'd Spel'g Soc 1995 #1, 7-18,37-44]

## **The Argument**

English is the language most in use for 'communication' in what we hope will be the One World of tomorrow.' The written word is still the main medium used for international communication for those who most seek such a medium. At least 30 000 dictionary items are needed for wide reading or sophisticated conversation. The 1500 words most frequently used

- (a) include no more than 300 of the less than 1500 needed for self expression and
- (b) are in nearly all cases the words most liable to semantic erosion (widening of meanings with frequent use; cf. Zipf).

C K Ogden's Basic English was among early acknowledgments of this. Basic enables clear expression within the limit of 850 words plus some technical terms, in a style consistent with the 'Authorized Version (of the English Bible) or of Winston Churchill at his best'. The main defects of the word list are

- (a) Many of the words have each several different meanings (with several 'different words in any other language').
- (b) Basic requires many idioms using particles with no intrinsic semantic sanction. It is probably as hard to learn several meanings of a word as 'to learn the same number of different words, each with a clear-cut' meaning, e.g. 'put up with' for 'tolerate' or 'forbear'.
- (c) This requirement could prompt 'not easily broken habits of unacceptable usage' for learners 'with no native knowledge of English'. [Perhaps like 'he scratched them till they died' an official interpreter's version of 'they were tickled to death'.]

ewE provides LESU (a list of 1300 essential semantic units, esu's) to replace Ogden's 850 words.

An esu is

- (a) a word and where necessary
- (b) a particle or
- (c) other usage to accompany the word.

Compare

- (a) laugh atŠ: contrastŠwith Š: the sameŠasŠ and
- (b) to do not always interchangeable with doing or for doing as object of a transitive verb, e.g. cease/ finish doing = cease (NOT finish) to do.

Fewer than half a dozen esus (with, to, that, have, be) each has more than one (unequivocal) reference, subject to readily recognizable metaphorical extension e.g. Holy Father, Mother Superior But several esus have in standard English (sE) more than one meaning, so our LESU restricts them to one meaning each. This prevents the usual vicious circle of dictionary definitions, repeating forever. We can use (for the ultimate meaning constituents) pictorial or other non-verbal or internationally current usage e.g. =, 5, Homo sapiens, diphtheria.

The rest have paronymic specification (a nexus of non-esu words which share a common semantic territory, e.g. state and condition, each with more than one other unrelated meaning). A bilingual dictionary listing the paronyms can then guide the beginner to the appropriate distinct meaning. Paronyms are added even to terms definable by terms listed earlier in LESU. This broadens the range of recognizable terms for readers and listeners, and reiterates previous esu items for rote learning.

Henceforth esu items are in UPPER CASE and paronymic or recognition aids in italics. Ogden's The General Basic English Dictionary with [primarily 'standard', mainly southern British] pronunciations shown in International Phonetic script, and Linguaphone type records, serve to indicate pronunciation.

[Other regional pronunciations differ from sE mainly in consistent ways, with sound shifts among regions but fewer phoneme categories differing from each other. A phoneme is a category or range of speech sound units that distinguishes spoken words from each other within a speech community. Thus pronouncing dictionary versions of a word are sounded differently from region to region but the words distinct in the dictionary's

phonetic respellings remain generally just as distinct from each other in speech within each regional usage -- DE].

We list homonyms in a separate glossary. Some have the same spelling but come from different word roots e.g. base = bad or bottom.

## Ch. 1 The Need for a Global Auxiliary

In the mid seventeenth century the British Royal Society and French Academy each followed the lead of Italy's Lincei by adopting the national vernacular for learned communication. The Latin lingua franca was lost. In 1664 the Royal Society commissioned an inaugural member, Bishop Wilkins, to seek a remedy. Leibniz devoted his leisure in later years to this end. Their published efforts were harder to learn than Latin and less flexible to later development. Linnaeus, Lavoisier and scientists generally for 200 years produced only piecemeal moves toward a world language of science. The vast growth of mails and movements in the 19th century increased the need for a global code. Leibniz proposed comparative language study as a useful next step. Several schemes emerged. Pirro devised Universal-Sprache before German Catholic priest Schleier produced Volapük that was actually spoken and promoted by scientists and societies. Zamenhof's 1887 Esperanto soon eclipsed it, and several schools taught it briefly after World War 1. More than 300 alternative schemes have been published since but none with such broad and persistent following as Esperanto. All are put forward as a second, bridging, helping/ auxiliary, not a dominant or sole language or replacement for mother tongues. Only after World War 1 did the US emerge as predominant in science and technology developments. Proposed auxiliaries then took words from predominant technical speech communities, mostly Romance and Teutonic. They discarded irregularities and grammatical quirks (as e.g. English, alone among Indo-European and Semitic languages, has discarded grammatical gender).

Phonetics pioneer Alexander Melville Bell in 1888 published World English, the universal language. He lectured in Edinburgh and London before migrating to the US where he devoted his talents to instruction of deafmutes. He died in 1905.

English excels Esperanto for the East in

(1) grammatical simplicity. [Like Chinese, English relies on word order rather than affixes to convey inter-word relationships]. (Peano's flexionless Latin [and many later schemes] are even less inflected, but Esperanto relies heavily on inflections).

(2) access to books, and probably to

(3) global forms of technical terms. English distorts less than most

languages [including Esperanto] the growing global technical terminology.

The post-World-War-2 Bandung conference of 29 Asian and African nations speaking over 100 tongues, none of them anglophonic, chose English as their prime official language even for the Red Chinese, although the conference opposed colonialism, east and west, cultural and military. The only plausible alternative is a number of zonal auxiliaries of which English would be one.

As English becomes a more widespread global medium it may risk even faster semantic erosion at a time when



classic language studies and etymology are declining. Historically oriented literati and critics, however, cannot formulate the desiderata of a global auxiliary without reorientation of habitual attitudes to language uses.

In 1932, after ten years' work with help, C K Ogden compiled Basic English. His 850-word list on a sheet of note paper avoids the need for scores of verbs. This word economy eased the memorizing (mnemotechnic) load, and ewE carries this relief further. Ogden edited the internationalist Cambridge Magazine during World War 1 and later was a leader in the new powerful semantic movement in philosophy. Basic's main drawbacks are

- (a) orthographic burdens [whimsical spellings],
- (b) complex verb/ particle syntax idioms and
- (c) a huge vocabulary of multivalent and homophonic terms. Also,
- (d) Basic became tagged as an Anglo-American cultural weapon in the Cold War when Churchill [and Roosevelt] embraced it as such. [With its translingual semantics ewE should be less prone to this drawback].

ewE, like Basic, is no pidgin [or creole --DE]. It is a program for learning standard English (sE) with a better semantic basis than Basic. It marries Ogden's philosophical semantics with his vocabulary economy. It should be a better introduction to the English than Basic is, and may lead to an auxiliary better than the more than 300 predecessors. Semantics in ewE prompts native speakers to think first and talk later. This cannot exclude emotive content, but on the other hand parochial poetry or the sentiments of vernacular idioms must not veto clear expression or the breakdown of cultural prejudices.

I discount the childhood 'osmosis' approach to learning a global auxiliary. The current trend to teach foreign languages first by the spoken word overlooks the prime need of a global auxiliary to convey the written word.

## Ch. 2 Principles and Definitions

We define TERM as a dictionary headword and probably its flexional or paradigmatic derivatives. A term may be multivalent (with several homonymous meanings) or eunymic (with one characteristic meaning e.g. numerals, with comparatively clear distinguishability of metaphorical senses). Translation sometimes helps distinguish multiple senses of a word, e.g. always = at each time or ceaselessly. The meaning of one eunym may embrace several others, e.g. cook (poach, broil etc.), container (urn, vase etc.)

Where there is no single term for a concept one may use two overlapping terms to identify the sense intended. Such couples we call paronyms\* e.g. government = STATE = CONDITION = prerequisite. Verbal or social context gives paronym senses by etiquette, syntax, taxonomy or arbitrary limits thus:

Etiquette. 'Pardon' is more formal than 'forgive'. This follows the general rule that Romance-derived words tend to be more formal than Anglo-Saxon near-synonyms. The Romance elements also usually have a wider international currency. This tends to make them more suitable for a (most usually formal) auxiliary.

Syntax. During, while, meanwhile are different syntactic, but not semantic, elements. Sometimes very, too require a following much, sometimes not.

Taxonomy. tall/ high and thick/ fat are interchangeable with some referents but not with man.

Arbitrary limits are those where the formula for distinguishing appropriateness is difficult.

Synonyms with subtle dictionary distinctions help poetry, variety to avoid monotony, and word games among literati and pedants but put no restraint on the seemingly accelerating semantic erosion in English.

Definitions for an esu can be non-circular if we use

- (a) pictures of things, time/ space relations, actions, processes and attributes,
- (b) international signs like 5, O<sub>2</sub>, Fe,
- (c) science terms (Homo sapiens, theobroma, cacao, sucrose, vertebrae etc.), international roots that are both widely current and semantically consistent,
- (d) combinations of these,
- (e) for about 300 highly eunymic terms by listing its paronyms and using a bilingual dictionary\*
- (f) idioms (or more specifically word clusters that do not reflect the usual meanings of each word < holophrases). These are needed perhaps most in French and least in English among major European languages. Some use particles that are often elsewhere eunymic (to, at, from, in, for etc.) where an 'empty particle of unspecified relationship' (of) would suffice (for e.g. turning an intransitive verb into a transitive couplet like laugh at, or for copulative empty words as in be in good health, different from.). Similarly arbitrary rules make to [vb] and for [ing] interchangeable (in a purposive context) and [ing] can replace to as a 'verb noun object of a transitive verb', thus cease working/ to work but finish work(ing), be in (not with &c.) good health, use it for cleaning/ to clean (with usually added). So Basic's word list needs to become a holophrase list (LESU).

But definitions are not always needed. An adequate replacement formula (rf) suffices with parenthetical phrases omitted in miss = (1) feel (unhappy because of) the loss of, (2) (aim at but) fail to hit.

Basic's word economy includes oligolexics (few terms to learn) and oligology (minimizing the need for circumlocutions that waste time and space, e.g. even = contrasted with what one knows or would deem likely from what was said before this. Ogden therefore sought

- (a) highly multivalent (with multiple meanings) terms, e.g. fair = equitable; pale; pretty < this involves use of scores of abstract nouns, a construction that tempts users to think in terms of Plato's universals, a perennial philosophic superstition (that an abstraction is a 'real' thing etc.)
- (b) utmost use of holophrases, e.g. go on = fit; act; continue, mount; prosper; and put off = remove;

delay &c. This involves ambiguities due to multivalence of get, put, on = ewE on or sE onward, off = away; from..

Basic's limiting verbs to 18 illustrates overlaps among them, as ask = put a question (to), make a request (of), give an invitation (to). 'The mnemonic load of learning n totally different meanings of one item of a word list is no less than that of learning n terms each with a clearly defined reference'. (Hogben 'dogma'. Neither grammar texts nor dictionaries define enough the role of holophrase and arbitrary restrictions of context in socially acceptable communication. See jargon (p. 49 footnote and later).

---

\*This trick occurs in Chinese pidgin English, e.g. look-SEE makes clear that sea is not indicated.

Dictionary get away with circular definitions because few educated people so far realize the irrelevance of the simple dichotomies of Aristotle's (or Boole's) binary logic to biological taxonomy, and the overriding importance for that taxonomy of the definitive principle of the identity parade. E.g. a farmer could recognize a starling in a line-up of museum exhibits of birds of his country, but not one in 1000 could frame a verbal definition to distinguish it.

### Ch. 3 Mnemotechnics of Language Learning

Writing, reading, speaking and interpreting speech are skills that may be separately lost in local brain damage but are not always all addressed by language teachers. The 'transmitter' (writer or speaker) needs a limited (recall) vocabulary and grammar knowledge. The 'receiver'/ decoder (reader or listener) needs a wider (but only nodding) acquaintance with more (recognition) vocables and grammar rules. The LESU covers the former. Orthography is more necessary for reading, phonetics for listening. For years to come a global auxiliary will be useful primarily to people who will rarely meet in domestic surrounds, will communicate mainly in writing and print, especially about international concerns. Poetry may emerge later. Casual contact by tourists and traders may roam erratically around a few dozen set phrases, not necessarily contributing to more serious conflicts or cooperation. Reading has advantages over radio communication. One can

- (a) skim over less crucial written parts,
- (b) retrace and compare earlier and later parts,
- (c) check a dictionary at any stage,
- (d) learn more systematically,

reversing the order of natural (native tongue) learning. Decoding speech is harder than encoding it and so appropriately it should be the last of the four skills to be learned.

We prefer semantic comprehensiveness before vernacular (including some school) usage, to encourage a sense of early completed achievement with comparatively little effort. This 'recall first' approach need not delay 'recognition' skills.

Writers can rearrange and revise, take time for recall Traditional teaching tends to emphasize first skill in

reading plus parrot learning. This may suit technicians seeking mainly access to technical data in languages related to their own. Pen-friendship movements combine writing training with incentive to expand recognition skills.

Most-used words are also most multivalent/ semantically eroded. LESU omits specific fruits (apple, orange of Basic) but keeps imported world trade items (wheat, rice, tobacco, tea, coffee, cocoa). We need no technical nautical terms but do need technical legal terms (verdict, customs, arbitration ) in a world striving for unity, a peaceful order under law as in speech. We can use terms already international for species, anatomy, diseases, substances, and the local names for countries and cities.

We can omit eponyms, mythological terms, terms for animal cries or movements in different species (bray, caw, hiss; flit, toddle, gallop etc.) and terms intelligible only in the context of 'western' philosophies, and terms expressing gradations of personal value judgments. We similarly prefer general terms like vehicle, tool, device, machine, container, fastener.

Short words are simple in structure but are likely to be those most semantically eroded or overloaded with emotive associations. LESU seeks single items for commonly used and useful terms, by choice highly eunymic in everyday speech or defined as such by semantic prescription. We seek too all terms other than common nouns recognizable in meaning by most educated adult English-speakers, or a replacement formula made up of other most highly multivalent LESU items (3000 adjectives or particles, 4000 verbs, 1500 abstract nouns).

So we collate highly eunymic terms other than common nouns, then explore semantic restrictions on more multivalent terms, then see how far these include or provide adequate substitutes or not too prolix replacement formulae for all terms in a recognition vocabulary of anglophone adults (and Basic's list with its holophrastic extensions). We avoid more than a minimum of terms for personal value-judgments, e.g. too, very, high, not un-, not very, un-, not, very un- , not sufficiently with pleasing (to the eye), daring, worthy (of esteem), etc. for e.g. valiant, reckless, rash, brave, bold, intrepid, valorous, timid, cowardly, craven etc. We separate definitive and derivative terms, thereby imposing opportunities for automatic revision by 'transmitters'. We help learners and especially receivers using ewE glossaries to build recognition vocabulary beside recall vocab. 'Cement' words can be learnt in 4 weeks at 50 per week but to do so using (250) common nouns for context we allow 9 weeks. Then we give priority to adjectives, but with them need many verbs for replacement formulae (e.g. lazy = unwilling to work, eager to avoid work). We use Graeco-Latin derived technical terms, not to press for general knowledge of these but because they may provide mnemonic aids in relating a group of terms, familiar or not, but with some interest with the common origin, rather than learning a lifeless label.

We aim in LESU to provide adequate self-expression, not possible with the 2000 most essential words based on frequency in the Interim Report on Vocabulary Selection for the Teaching of English as a foreign language sponsored by the Carnegie Corp., NY. Multivalency gives these word (4000 semantic units by their count, 6000 by our not excessive estimate, with no comprehensive tool for self-expression.

#### **Ch. 4 Criteria of Word Choice**

In compiling LESU, unlike Hogben's list, we use terms

(a) eunymic by custom or restriction, not overloaded unless a definitive alternative would be unwieldy circumlocution, not multivalent/ semantically eroded

(b) paronymic,

(c) definitive in terms previously chosen; or replacing a prolix holophrase.

(d) specifying arbitrary restrictions imposed by context, and used only if no term is available with a wider contextual range of admissibility. We list speaker with talk because talker has a derogatory nuance.

(e) demanding (an) arbitrary accompanying particle(s). These must occupy a niche accommodating the partner terms, or

(f) more taxonomic rather than those less so, especially if reducing need for quasi-technical terms.

(g) more formative preferred ceteris paribus (derivatives formed by affixes of a dominant grammatical pattern, e.g. start(ed) preferred to begin etc. even tho less eunymic.

(h) common and 'highly' eunymic (less multivalent/ semantically eroded) e.g. again tho replaceable by once more or a second time.

(i) common nouns if interesting for persons that seek world-wide cultural collaboration. More international terms e.g. commence may be less semantically eroded than e.g. start, begin but less formative (compare starter &c.). Abstract nouns are attractive here if identical with verb forms. Thus Ogden's keep gives way to (cause to) remain, retain = continue to have, not give back; take, get give way to procure, receive, become &c.

(j) affixes: un-/in- &c, -ly, a,i-ble (like Latin gerundive passive = able, fit to be Šed), -er active or subject thing/ person, -less with noun or -ing form of verb which is also an abstract noun = without

(k) particles: (preposition, conjunction, simple adverb). since (not in the sense of because), while (not in the sense of though), if AND whether; just, quite are superfluous AND multivalent. We find too multivalent eny, some, only, ever.

(l) auxiliaries: shall/ should dispensable, will preferred to be going to e.g. in complex tense/ aspect phrases like they'll've been working six hours; would for conditional clauses, can/ could displaces may/ might = is able/ free/ allowed/ knows how to; permit displaces let; is/ has/ ought / needs to, (certainly) is/ will displaces must; at one time/ usually displaces used to.

(m) verbs with adjectival predicates: be(come), keep, feel, remain, seem, deem (it) Š

(n) adjectives: meny dispensable from Ogden's list by

€allowing verb status to 300 of his abstract nouns (3d sing -s, Aorist -ed).

€verbs like contain, fasten with Basic -er added give coverage of vessel, reservoir, box, chest, can &c., button, clip, latch, bolt, lock &c., lov|er,ing,less,ed,able, un-.

€about 75 LESU verbs + -less and another 25 LESU verbs are adjective forms, another 50 with -able ±un-/in-, in all 300 adjectives, more than half of these tallying with substantives.

There remain about 200 adjective entries. right <> left preclude other senses of these two words (true, fitting, ethical, privilege, remaining &c.)

## Ch. 5 The Mnemotechnics of Spelling

Substantial reform would temporarily increase costs of publications so should await (as it can't promote) acceptance of English as a global auxiliary. Homophones from diverse source languages discourage unitary phoneticizing of English but there is a case for reversing counter-etymological changes e.g. Middle English/Anglo-Saxon s for current French c in once, ice, mice, hence, pence, cinder, since or false analogy with Teutonic light, naughty in delight, haughty, sprightly from Old French. "Errors of poets, schools and master printers have saddled English orthography with anomalies which prevent us from fully exploiting so great an advantage" (the ability of Romanced or Teutonic speakers to recognize English words by spelling with a knowledge of sound shifts in derivation of English words from Romance or Teutonic sources).

In ewE, IPA symbol q is shown by th, for the sound as in thin,  
 IPA symbol like ʔ (or rather • with ~ overwritten) is shown by dh for the sound as in then,  
 IPA c is shown by kh for the sound as in Scots loch,  
 IPA symbol like n with lower half of j overwritten is shown by nh for the sound as in linking, linger,  
 IPA ʃ or s is shown by sh for the sound as in ash, tʃ by tsh for the sound as in each,  
 IPA ʒ is shown by zh for the sound as in fusion, dʒ by dzh for the sound as in judge.

### Etymology indicators:

An English word is usually Teutonic in origin if it contains ng for the nh sound, th for the dh sound, kn (Old English cn) or sh at the start of a word, w(h) for the w sound (and wh still fully aspirated by Scots), th for the th sound except in scholarly words where th represents Greek theta, and faith derived from the Old French feid; gh silent or sounded as f records a ded aspirated guttural in Old and Scots English.

Norman French is indicated by j with the zh sound, c sounded s before e or i, French by ch with sh sound, French or Latin by ti or ssi with sh sound. Greek origin words have ph sounded f, ch sounded k, and words starting ps, pt, rh or mn.

We gain from having a single form for differently sounded affixes -ed, -s sometimes sounded t, z. There is no prospect of forcing the same vowel values on immensely varied dialects, so 'Sprinting consistently phonetic English spelling is a hoax, as anyone who has tried to teach shorthand to a Yorkshire pitboy will have found out.'

We accept some Americanisms, e.g. classic [Latin form] odor, color before Norman-British -our but not -ic for -ical in historic(al).

## Ch. 6 Pathology of Grammar

> Inessentials include genitive form of nouns [?and pronouns?], old second person pronouns (thou thee thy thine singular, ye plural), indirect objects (gave him this), and conditional inversion (were I to do so). -ing is an abstract noun (gerund), periphrastic aspect-tense tag and adjective (gerundive).

do takes over inflectional functions for interrogative, negative and continuous[/ repetitive] or emphatic affirmative. Subject-verb inversion is no longer needed when there is an initial qualifier.

-ly is adverbial, formerly adjectival only (kingly, monthly, earthly &c. Existential be (there is/ are/ was &c.) is holophrastic.

## Ch. 7 Essential English Grammar

Disappearance of grammatical gender is 'one of the indisputable merits of English'.

The genitive case is now optional.

Personal pronouns have two(it, you, she) or three (I, we, they) case forms, interrogative and relative pronouns two (who(se), that/ whose) demonstratives one (this, that and plurals).

Other adjectives are invariant in number, gender and case. Most monosyllabic adjectives (and disyllabic ones in -y, changing to -i ) add -er, -est for comparative and superlative forms.

Adjectives except with -ly (daily &c.) add -ly for adverb, plus -ier, -iest affixing as for adjectives and monosyllabic adjectives.

Plurals are regular (-es after ch, sh, x, s, ss, -y changes to -ie, f to v) except for 7 native words (wo)man, child, ox, sheep, tooth, foot) and recent imports (axis, synopsis &c.)[but see Cambridge -DE].

Word order. (Pro)noun subject, verb, direct (primary) object, particle connecting secondary object.

Single term precedes one it qualifies. Phrase qualifier follows it. SE exceptions:

(a) eliminate particle, put secondary before primary object (gave him the book),

> (b) conditional inversion omitting if were I to do this)

(c) emphasis inversion (never shall I forget) < the 3 above not needed in ewE

(d) direct or secondary object may precede subject in relative clause (the man I had it from) but retain whose for e.g. the man whose house I purchased.

Negations put particle not right after helper verb and

Questions put subject right after a helper verb (and not in a negative question) with subject (next) before main verb.

Interrogative pronoun, pronoun couplet or adverb (whose hat, which book did he use?) comes first in a question followed by be, have, can, will, do &c. then the subject (where can he be?) if the interrogative is the object of the verb or of a preposition, but if it is the subject or complement of be/ become it comes

first without a do(es)/, did construction (who made it? &c.)

Beginners for safety should give subordinate clauses and phrases precedence in the sequence, e.g. avoid the buildings, few of which remain, were once admired greatly.

In interrogation pronouns I he she we they that follow the verb, otherwise precede it; me him her us them follow it. In interrogation who?, what? precede the verb.

EwE replaces Chaucer's relative pronouns who, whose, which by earlier Teutonic that. It may be omitted in initial teaching on introducing a noun clause.

Impersonal pronoun one(s), one's is preferred to you and common gender pronoun they, them, their(s) paralleled in Scandinavian den = (s)he, him, her, dens = his/ her(s).

Articles are degenerate forms of the numeral one (Scots ane) and demonstrative that, not so separately developed in several languages.

Verbs (excluding derivatives with -er, -able, -ment, -ation &c.) have not more than 5 forms except be (8 forms). Some have only 3 (cut, hit, put, shut, split &c.) Each of the 5 forms except -s has more than one use. We classify the 5 forms as L(exicon) form e.g. give

-s Š gives

-ing Š giving

4th Š gave } most verbs (weak or regular)

5th Š given } combine these 2 forms with -ed. -s form is used with (s)he, it, one, that or a noun) and indicates continuing or habitual action, process, state or sentiment &c.

4th form when distinct from L and 5th forms indicates a happening in the historic past or in a clause starting if to imply doubt or conjecture (exceptions: were, was).

5th form serves as

(a) perfective with has/ had.

(b) passive after be &c.

(c) passive adjective, often in effect a contraction of a relative clause

(d) occasionally active (fallen tree, dear departed &c.) with intransitive verb.

-ing form as

€an abstract noun may displace to + L form, employable with an object like Latin gerund.

€abstract noun or gerund following ('in apposition to') the object of a verb of perception (he saw me reading the book) like Latin accusative and infinitive construction, commonly interchangeable with sole L-form

€adjectivally, so comparable to active present participle of Latin and Greek; active meaning not always clear (hanging lump = suspended lump).

€with be, active periphrastic: he is, will/would be, can/could be, ought/has/had to be,



was/has/had been &c. going. L-form

€ s- form but when subject is I, we, you, they, this/ that/ these/ those one(s) or a plural noun.

€ imperative, softened by kindly Š for polite usage.

€ interrogative and/or negative periphrases and negative imperative (kindly do not read this).

€ after auxiliaries can/ could (not), will/ would (not), ought (not) to.

€ like second use of -ing form and with make (make it go faster).

L-form with preposited to particle in next 6 cases:

€ with be and have for future &/or compulsive [SEE Table 1, 2 below]

€ to Š = for Šing or abstract noun, as direct object of transitive verb (to please her = for her pleasure).

€ after we, him, her, it, one, us, you, them or sing. noun or plural + to, after verbs of counsel, compulsion, cognition, desire, assistance, permission and request in a construction replaceable by a substantival clause [Latin accusative + infinitive] < and if transitive may then directly precede a noun object, demonstrative, or one of the preceding object pronouns as in they helped / forced him to do it.

€ after noun + to, a non-purposive passive adjectival value like Latin gerundive: a woman to fear = to be feared. Not always clearly distinct from purposive, e.g. bre(a)d to eat = bre(a)d for food or fit to be eaten = fitting for food.

€ after to = Šing as abstract noun which may have an object, e.g. to do/ doing that is not easy. }

Not easy to € after adjective + to like Latin supine: eager to work = industrious; impossible to believe = incredible; eager to be successful = ambitious. } distinguish if } is inverted: to do that is not easy = that is not easy to do.

The last three cases are not easy for beginners, e.g. to distinguish a grammatically predicative it is bad to be without food from a factually predicative statement it is eager to feed. If we reverse order for rhetoric or scansion, one it disappears as it has no semantic reference, just a courtesy to grammatical habits: eager for food it is; to be without food is bad < or replace to + L-form by -ing form: being without food is bad. SE it is/ was may be omitted in learning self-expression when it has no factual reference except in climatology e.g. it is hot there. Note: to fear = to be feared (conveys passive content in adjectival construction) but this is dispensable by use of impersonal relative: a man to fear = a man one fears/ has to fear.

The last usage can be split as

(a) if adjective to + verb intransitive (e.g. to come) no ambiguity if adjective is prone, eager, (un)re(a)dy, (un)willing, (un)likely;

(b) if verb transitive with such qualifiers meaning is active, differs from that of a construction invoking an adverbial derivative of adjective and 5-form, e.g. eagerly re(a)d;

(c) if adjective is difficult or easy, passive substitution noted doesn't essentially change meaning: a window easy to break = a window easily broken.. With easy &c. set we rule out the option easy to be broken but with eager we have 3 choices:

eager to select, to be selected, -ly selected.

Table 1 (with set 01) HAVE and BE

1. L -forms | 2. -ing forms | 3. Fifth forms

HAVE | BE | HAVING | BEING | HAD | BEEN

Simple tense forms: n is noun object of possessive sense HAVE, a noun (n) or adjectival (a) complement.

Preceded by | 4. Indef. & Present | 5. Simple past | 6. Hypothetical Protasis

(S)HE, IT ONE | HAS n | IS a | | |

| or\_sing.\_noun

| WAS a | | \_\_\_!\_\_\_

|\_AM\_a\_| HAD n | HAD n | WERE a WE, YOU, THEY | HAVE n |

| | | |

| or plural noun |

| ARE a | | WERE a | |

| HAS HE | AM I | HAD HE | WAS I | | Interrogative | (NO)n ? | (NOT)a ? | (NO)n ? | (NOT)a ? | Š | Š

| &c | &c | &c | &c |

Negative | I HAVE | I AM | HE HAD | I WAS | IF I HAD | IF I WERE

| NO n &c | NOT a &c | NO n &c | NOT a &c | NO n &c | NOT a

&c

Table 2 (with set 02) PLANT and GIVE

1. L -forms | 2. -ing forms | 3. Fifth forms

PLANT | GIVE | PLANT ING | GIVING | PLANTED | GIVEN

Simple tense forms: +Š+ indicates assertion, ¿Š? question and -Š- denial

Preceded by | 4. Indefinite | 5. Simple past and Hypothetical

I, |+PLANT n + |+GIVE n + |  
 WE, YOU, THEY |¿DO [WE&c] |¿DO [WE&c] |+PLANTED n + |+GAVE n +  
 or plural noun| PLANT n ? | GIVE n ? | | |-[WE&c] DO |-[WE&c] DO | | |NOT PLANT n |NOT GIVE n -  
 |¿DID [HE/WE&c.] |¿DID [HE/WE&c.]

(S)HE, IT, ONE|+PLANTS n + |+GIVES n + | PLANT n ? | GIVE n ?

or sing. noun

|¿DOES [HE &c] |¿DOES [HE&c] | | |PLANT n ? | GIVE n ? | | |-[HE&c]DOES |-[HE&c] DOES |-[HEŠ]  
 DID |-[HE&c] DID |NOT PLANT n -| NOT GIVE n -|NOT PLANT n - | NOT GIVE n -

Table 3 (with set 05) Imperfect and Perfect Periphrastic Constructions

1. L -forms | 2. -ing forms |  
 3. Fifth forms

BE | HAVE | PLANT | GIVE|BE/HAV/PLANT/GIV~ING |BEEN,HAD.PLANTED,GIVEN

Pres. & weak fut. |Continuous past |Simple perfect |Past perf. |Perf. habitual|Past perf. hab'ual

+AM/IS/ARE BEING|+W'S/WERE BEING|+HA~S,VE BE |+HAD BEEN a,|+HA~S,VE BEEN |+HAD  
 BEEN a,HAV,PLANT,GIV~| a, HAV,PLANT, |a,HAD/PLANT-| HAD/PLANT |HAV,PLANT, |HAV,PLANT,  
 ING n + | GIV~ING n + |ED/GIVEN n + | ED/GIVEN n+|GIV~ING n + |GIV~ING n + ¿[AM I &c]BEING  
 a,|¿[W'S I &c] BEING |¿[HAVE I &c] |¿HAD[I &c] |¿HAV[I &c]BEEN|¿HAD[I&c]BEEN HAV,PLANT,GIV~  
 | a, HAV,PLANT, | BEEN a, HAD/ |BEEN a,HAD/ | HAV,PLANT, | HAV,PLANT, ING n ? | GIV~ING n ?  
 |P'TED/GIVN n?|P'TED/G'N n?| GIV~ING n ? | GIV~ING n ? - [I AM &c] NOT |-[WAS I &c] NOT |-[HAV  
 I&c]NOT|-[I &c]HAD |-[I HAVE&c] NOT|-[I &c]HAD N'T BEING a, HAV, | BEING a, HAV, | BEEN a, HAD/  
 | NOT BEEN a,| BEEN HAV, | BEEN HAV, PLANT,GIV~ING n- |P'T,GIV~ING n - | P'TED/GIV'Nn-  
 |H'D/P'D/GNn-|P'T,GIV~ING n-| P'T,GIV~ING n-

Table 4 (with set 09) Explicit Future Constructions

Basic forms (WOULD, CAN, COULD, OUGHT [NOT] TO may replace WILL)

+ s WILL +, ¿ WILL s ?, - s WILL NOT - + BE a HAVE BEEN a Š Š HAVE n HAVE HAD n BE HAVING n  
 HAVE BEEN HAVING n PLANT n HAVE PLANTED n BE PLANTING n HAVE BEEN PLANTING n  
 GIVE n HAVE GIVEN n BE GIVING n HAVE BEEN GIVING n

Orthography: -ie replaces cons.+y before -s affix in s form, -es replaces -s after -o, sh, ch, ss, x.

Terminal n. t, p, m, b after a short vowel is doubled, terminal e is dropped, -ie becomes y, before -ing.

Other irregularities as in LESU.

## Ch. 8 Syntax of verb.

Be €inks different names for the same thing or creature €inks attribute or class specification for thing or person Only Dutch among related languages has a term comparable to there is etc. (existential

holophrase).

Have overlaps be (compare French j'ai faim, c'est à moi) and own of LESU.

He goes (indefinite), will go to London the month after this. I don't know when he will come (temporal=may, substantival=may be willing to).

4-form in protasis (if clause) when appropriate form in apodosis (main clause) is would + verb (e.g. if he came they would know). Corresponding form of be is were. When apodosis has would have + 5-form, have + 5-form replaces 4-form (if he had come they would have known).

Otherwise 'preterite, aorist, past indefinite' etc. is narrative past form Was with singular subject, otherwise were are forms of be prescribed. 4-form is neither perfect nor imperfect per se (he helped her) but meaning of verb may be inconsistent with continuity, e.g. he ceased willingly.

'Perfect' with have is redundant where completion of the event is explicit by context, e.g. have you been, were you, in London during the week? 'Pluperfect' is redundant when context dates completion: she (hads) helped him till then.

Imperfect with was/ were is redundant when context safeguards duration in a sequence such as while he was reading it = while he read it. But we don't yet accept 4-form went in while he was going to London < similarly for come, make. We can dismiss one use of sE be toŠ[vb] if we keep have/ had to + verb as compulsive auxiliary. Similarly would have + 5-form covers hypothetical was/were to have; he was to have come, but he had too much work to do = if he had not had too much work to do, he would have come.

Auxiliary be and have. [p.135-6].

(1) be have break procure } am, is, are, was, were, to be

(2) be being be having be breaking be procuring } may replace be

(3) have been have had have broken have procured } has, had, to have

(4) have been having have been breaking have been procuring } may replace have.

In the last column having may replace have in sE but ewE does not need it, e.g. having been broken, the container was useless = the container was useless because it was broken.

In all rows toŠ form (as earlier noted for first row forms) can be replaced by to + L-form, e.g. it would have been useless to have helped him = to help him would have been useless. All items can follow auxiliaries: With (1) (2) (3) (4)

€will indicates continuing future completed future event previously continuing event indefinite future completed at future date shown by context

€can indicates immediate present completed event event that went on to date possibility possibility shown by context

€would like can but indicates unfulfilled condition or intention (whence a suggestion of doubt)

€could has both uses of the ordinary 4-form. In utterance expressing

doubt or main clause of conditional utterance it conveys possibility &c.

Before (1) it can also express possibility in the past, equivalent to sEused to be able/ permitted to.

€have to, ought to have time, continuity, completion restrictions as for can, expressing respectively necessity, obligation. Subject and negative particle in question and denial are fixed by treating to as a link to following L-form.

Immediate present is ordinary use of [be] Šing ( now is then redundant), sE uses this form also in a future context (I am going to town tomorrow).

Past is shown by was/ were breaking, have/ has / hadbroken/ (been breaking), broke. Context can help decide tense, aspect &c.: during the time, while. Implications from a connected clause may make clear the temporal or circumstantial context in a 'compound' sentence. The other clause(s) then use(s) the simple past form. Thus While/ because he was dying, he gave all his goods to the poor. When he gave all his goods to the poor, he was dying. He was reading this while he was on the train. Before he started to read it, the train had ceased to move. While she was singing, he made it differs from While she sang, he was making it. Thus make and verbs implying motion are restricted in use of the simple verb form more than verbs like sing

Where the essential meaning of a main verb is consistent with persistence or repetition (continuing, repeated) we interpret its -ing form so, (I have been breaking stones the whole day = I was breaking stones during today. I had been brteaking stones the whole day = I was breaking stones during that day etc.) otherwise we substitute the conceptpremonitory as inwas/ were, has/ have been dying. The forms without -ing signify completed events with no notion of duration.

The have + 5-form construction is preferred to the simpler form if the circumstantial or temporal context is recent or there is no reference to the date or circumstances in the context. I have broken my leg. I have broken six cups during this week.

To make clear that the event came before a past date or event not specified in the context, we use had as in he had died when she was married, otherwise we can use he died before she was married.

When a situation continues throughout some past period of time (not necessarily yet terminated) we use the form was/ were dying. When we need to emphasize that this period has ended, we use the form he has been dying = he was dying till now.

Recent past may be shown by be rather than have as in They were married yesterday. Otherwise be has a passive connotation. Sometimes changing this to an active form makes it longer, e.g. This window

is broken. Someone has broken this window. We advise beginners to use the 'perfect participle' only when it works like a simple predicative adjective as wet in The window is wet.

Another passive construction It has frequently been stated by other writers is more succinct in the active form Other writers have frequently stated

Existential there is/ are/ was/ were/ have,has,hadbeen/ will/ would/can/ could/ ought to/ have to be, will/ would have been is dispensable. There are no snakes in Iceland= one can meet/ see/ locate/ detect no snakes in Iceland or No snakes live in Iceland. A singular noun with or without an indefinite article follows the forms with is, was, has and a plural noun with or without a preceding no (preferred to not) follows the are, were, have forms. The others can precede a singular or plural noun.

## Ch. 9 LESU

Internationally current terms and affixes \_abdomen aeroplane(s) agenda alcohol aluminium area atom autotobus(es) automobile(s) axis, axes bacteria ballet bomb bureau(x) cabaret(s) camera(s) canal(s) carbon casino(s) centre chocolate(s) cigar(ette)(s) cinema(s) coitus conference congress crisis, crises datum, data debris detente diploma(s) dynamo(s) embryo(s) faeces focus, foci foetus formula(e) hotel(s) hypothesis-is,es international kerosene latitude longitude major metro minor minus opera(s) orchestra(s) petroleum piano(s) plastic(s) plus potato(es) programme(s) propaganda protocol radio radium radi-us,i ratio(s) reflex(es) restaurant(s) saliva sepsis spectrum,a sport(s) stimulus,i strat-um,a tax(es) tea/ the telegram(s) telephone(s) theatre(s) tobacco toilet(s) tomato(es) toxin trauma uranium uterus valuta veto virus(es) wagon(s)-lit zero

CGS (metric) units: ampere, atmo, calorie, metre, dyne, erg, gram, litre, joule, second, volt, watt, henry, ohm, faraday, decibel.

Chemical terms, elements &c.: hydrogen, nitrogen, oxygen.

Diseases in the WHO list. Binomial names of organisms.

Anatomical terms of Greek and Latin origin (plant & animal): cerebrum, testis, vertebra &c.

Affixes: anti-, ex-, extra-, infra-, inter-, intra-, pan-, post-, pre-,\*quasi-, supra-, trans-, ultra-, vice-.

Ogden adds to above (A Short Guide to Basic English, 1937):

\*alien \*alliance asbestos bank bar beef beer \*buddhist cafe calendar champagne chauffeur chemist cheque chorus \*christian \*church circus citron club cocktail coffee cognac colony dance dynamite \*employee encyclopaedia engineer gas glycerine \*Greek hygiene hysteria inferno jazz lava liqueur macaroni madam \*moslem/ muslim \*muscle olive omelette opium \*orthodox paradise park passport patent phonograph police post pyjamas pyramid quinine referendum \*refugee rheumatism \*Roman rum salad sardine sir tapioca terrace toast torpedo university vanilla violin visa vodka whisky

\*in Hogben's, not Ogden's list

26 sets of 50 + supplementary sets 27, 28.

ICR= internationally current root

## SET 1

1 A Definitive terms

(i) Particles (ii) Auxiliary verb (vi) Aj & Vb

1 a(n) 14 be being am is are was were been 25 own(s,ing,ed) v.t.=possess,

2 and have ICR proprio-, idio-

3 but (iii) Weak verbs own aj.=owned personal, private

4 or 15 live(s) living lived v.i. my own=mine, your own=yours

5 eitherŠor living alive ICR bio- vivi- owner proprietor, possessor

6 if 16 marr~y,ies,ying,ied + to espouse, wed

7 no aj. + interj. unmarried single.

8 not (un-, in-) ICR non- ICR gam-

9 neitherŠnor

10 of (iv) Names aj. & n.

11 to ICR ad- 17 adult(s) aj. grown-up,mature

12 from ICR ex- 18 thing(s) object

13 with a.

having no thing nothing  
b. in company of ICR syn/sym-.

19 animal(s) ICR zoo-  
c. by means of

20 parent(s) father, mother

21 offspring (s. & pl.) progeny, spawn, issue. ICR fili-

22 sex

\_1 B Terms Definable by Recourse to International Current Signs or Terms \_(i) Names

26 male(s) = K or K K [astrological &c. MARS symbol]

As aj. masculine

ICR andro-

27 female(s) = • or •• [astrological &c. VENUS symbol]

As aj. feminine

ICR gyn-

28 person(s) = Homo sapiens

human being

ICR anthrop-

(ii) Pronoun-Numeral

29 one(s, 1s) first once

ICR mono-, uni-

no(t) one = no person. none

no thing. nothing

\_1 C Picturable Name and Verb

30 plant(s) planting planted (v.t.) ICR phyt-. unplanted = not planted uncultivated, wild. planter tiller  
gardener farmer cultivator

1 D Derivative terms

\_(i) Particle

31 without = with no ICR a- or an-, or sine- without offspring childless, barren

(ii) Auxiliary & v.t.

32 have, has, having, had As v.t. = be with have no = be without want, lack

\_(iii) Names

33 man, men = adult male person ICR andro-

34 wom~an.en = adult female person ICR gyn-



35 spouse (of n ) = person married (to n ) male spouse husband female spouse wife

36 young (s. & pl.) = not adult. ICR hebe- As aj. juvenile, immature female young person girl, maiden, lass male young person boy, lad, youth, stripling

37 child(ren) = young person(s) bairn. ICR paedi-

38 son(s) = male offspring ICR fili-

39 daughter(s) = female offspring

40 father = male parent ICR patri-

41 mother = female parent ICR matri-

42 sib(s) = offspring of one father and one mother

43 brother(s) = male sib(s) ICR adelphi-, frat-, frstern-

44 sister(s) = female sib(s) ICR soror-\_(iv) Pronouns

45 he, him, his = a male

46 she, her = a female her own hers

47 it(s) = a thing or being neither male nor female

48 the~y,m,ir = persons or things but neither you nor I. their own theirs

49 we, us, our = (a) I and he, she or they but not you

(b) you and I with or without him, her, them

(v) Affix

50 n- less = without n. motherless and/or fatherless person orphan. childless barren, sterile

\_1 E The Grammatical Paradigm of the Pronoun Cases

Subject: I you one he she it they we

=====

[This book is out of print. Please ask if you want fuller lists -- DE.]

**MENU: [HOME](#) » [Reconstruction](#) » [Recovery](#) » [Renewal](#) » [Language Main Page](#)**

---

---

# Prospects for The World Language Process

Jonathan B. Britten  
*Nakamura University*  
*Japan Chancellor, World Language Process*

Nakamura University  
5-7-1 Befu, Jonan-ku  
Fukuoka, 814-0104  
jbritten@cc.nakamura-u.ac.jp

## **(Abstract)**

The World Language Process (WLP) is a potentially important "wave of the future" in language education. Becoming better known since the advent of widespread Internet access, the decades-old WLP is rooted in the much older quest for a true International Auxiliary Language (IAL). The author introduces the WLP's essential characteristics in light of JALT members' needs and interests. The author points out the dubious status of "Global English" in view of multiple World Englishes, ever-increasing billions of non-English-speakers, and widespread illiteracy in any language. He then clarifies the need for alternatives to English in light of these facts. He finally introduces the WLP's innovate ACCESS method of teaching the ANJeL Tun (Angel Tongue) pidgin.

## **Prospects for The World Language Process**

The World Language Process (WLP) may represent a powerful "wave of the future" in language education. Increasingly well-known since the advent of the Internet's world wide web, this decades-old program is the crest of an old, long-building wave - the tidal movement toward an International Auxiliary Language. This essay introduces the program's essential characteristics in light of JALT members' needs and interests. Persons wanting more detailed information about the theoretical basis of the WLP may consult the extensive web site. (World Language Process.)

Before describing the WLP, this essay outlines the status of "Global English" so that readers may better appreciate arguments for the utility and merit of the WLP. Although English is sometimes spoken of as "the world language," or as "the global lingua franca," the present and future role of English remains both ambiguous and controversial. Not only must we consider the existence of various "World Englishes," 1 we must also weigh other factors working against "Global English" : more than four billion persons worldwide who do not speak English at all,

(WLP web site) and the harsh reality of widespread illiteracy in any language (Wallraff, 2000). Moreover, the population of poor and poorly educated persons in non-English-speaking countries is rising more rapidly than that of affluent, educated groups, thus disproportionately increasing the number of non-English-speakers. For these and other reasons, it seems likely that "Global English" will be restricted to a minority of well-educated persons who travel or communicate around the globe in relatively high-level professions.

Readers interested in English's prospects will appreciate Barbara Wallraff's excellent essay, "What Global Language?" The author's essential point is this: "English isn't managing to sweep all else before it - and if it ever does become the universal language, many of those who speak it won't understand each other . . . we monolingual English-speakers may never be able to communicate fluently with everyone, everywhere. If we want to exchange anything beyond rudimentary messages with many of our future fellow English-speakers, we may well need help from something other than English." (Wallraff, 2000, p. 52-54.)

If Wallraff's view is correct -- and I think it is -- the WLP may offer precisely the "something else" lying outside the scope of her essay. The WLP may provide an International Auxiliary Language (IAL) for global mutual intelligibility not only among elites, but also among the general populace. To achieve this goal, of course, the WLP would need to be acceptable -- and widely accepted -- as a second/auxiliary language by native speakers of English. I believe such acceptance is plausible, given the essentially English foundation of the WLP. Whether or not all this comes to pass depends on the success of the WLP in the global intellectual marketplace, as well as the future role of "standard" English.

Given the central role of English in JALT conferences and publications, I want to emphasize the uncertainties about the future of "Global English.". Wallraff (58) points out that even basic facts about the present role of English are hard to ascertain. For example, estimates of the number of speakers of English as a Second Language (ESL) are remarkably imprecise, dependent on varying definitions of a "speaker" as well as other ambiguous variables. Citing scholars including David Graddol and David Crystal, Wallraff shows estimates of ESL speakers stretching from 98 million to 518 million, and estimates of speakers of English as a Foreign Language (EFL) ranging from 100 million to 1,000 million. In Wallraff's summation: "No one is arguing that English is not widely spoken and taught. But the vast numbers that are often repeated - a billion English-speakers, a billion and half - have only tenuous grounding in reality." (Wallraff 2000, p. 56)

Walraff explores many other impediments to the spread of English. Other evidence comes from the United Nations, which shows most educational funding going to affluent groups, with poorer persons receiving inferior schooling or none at all (UN Population Fund. 2002). This bodes poorly for English. Worse, in many countries, a dismaying large number of men and women are entirely illiterate in any language. (Walraff, 2000, UN Population Fund 2002 ) Such persons are highly unlikely to receive English language education, and it is among such persons that the most rapid population increases are occurring. This makes "Global English" seem quite

unlikely, particularly in view of the intricacies, irregularities, idioms, and irrationalities of , say, standard American English; the concomitant expense of long-term schooling needed to produce competency, let alone fluency, is very high. The outlook for the WLP, with its innovative, low-cost, and rapid teaching methodology, is quite different; competency reportedly comes with only 30 days of study, with costs of about US \$20.00 per learner.

The WLP aims at reaching educationally marginalized persons through an innovative, well-developed, "each-one-teach one" volunteer methodology based on Auxiliary Closed Captioned English with Simplified Spelling (ACCESS). ACCESS is the methodology WLP volunteers use to teach ANJeL Tun (Pronounced Angel Tongue), which by a strict definition is a Pidgin based on "phonetization," "elementalization," (both terms neologisms) and "regularization." I will define these three terms below, albeit briefly. This point here is that using ACCESS to teach ANJeL Tun is reputedly inexpensive, fast, and effective. If successful, ANJeL Tun via ACCESS, or some variation on the WLP language and methodology, may provide a basis for a true world language studied by all the members of the world community. Students would include today's "native speakers" of English. I will suggest several reasons for considering this outcome credible.

The first reason is that the WLP emphasis on English as the foundation affords powerful advantages. As Walraff makes clear, despite the dubious status of "Global English," English is widely taught and clearly does have an important status in the world. A simplified, rationalized version of English -- the current core of the WLP -- exploits the indisputable strengths of English's status, while avoiding, or at least ameliorating some of the well-known weaknesses inherent to the language. For many English learners in classrooms around the world, "standard" English (i.e., American or British) may seem arbitrary, difficult, expensive, excessively idiomatic, culturally intrusive, and much too time-consuming. In contrast, the WLP may seem relatively easy, fast, and inexpensive, comparatively culturally neutral, and evidently designed with the long-term needs and benefits of worldwide users foremost in mind. If learners see the WLP in this light, it may spread steadily.

The merits of the WLP's English foundation are threefold. First, the WLP bypasses the towering obstacles to fully artificial or "constructed" languages: more than 650 such efforts have failed (WLP web site); and "all such attempts are now considered linguistic esoterica, mere symbols of the desire for universalist thinkers for a code of communication that would cut across cultures." ( Kacuhu, 1992, p.2 ) Arguably, only Esperanto still manages to muddle along in the modern world, with almost no prospect for growth. Second, the WLP can thus serve as a springboard to those who may later want to learn the demanding variety of English used for communication between international businesspersons, educators, scientists, and other professionals. This dual role of the WLP overcomes objections that it's better to study English from the beginning -- no matter how difficult, time-consuming, and costly --- than to master the essential elements of the WLP, no matter how easy, quick, and cheap. Finally, and I think crucially, because the WLP is rooted in English, native speakers and current non-native speakers of English can very easily adapt to this proposed IAL, with minimal investment of time

and effort. Most can learn the ANJeL orthography with just a few days of memorization.

Advocates of the WLP are prepared to evolve from the existing ANJeL Tun model in future, a laudable posture based on a willingness to go with the flow - - a very useful metaphor when we think about "waves of the future." Certainly, some persons object to an alleged "linguistic imperialism" inherent in the English roots of ANJeL Tun, and other philosophical and practical impediments to the current WLP model will emerge as the program evolves. Nevertheless, the WLP's strong initial emphasis on English seems eminently pragmatic to me. Indeed, the pragmatism and flexibility of the WLP are key reasons for my own participation. In my mind, the "P" in WLP can be read as "Proposal," "Project," and "Process" -- a long-term, co-evolutionary process characterized by a wonderfully flexible attitude needed to help the WLP succeed. For this reason, I believe that volunteers can make very important and creative contributions to the WLP. The web site makes this clear:

. . . the World Language Process is in NO way 'solely committed' to the ANJeL Tun and . . . will willingly, happily and cheerfully support instead any IAL that humanity may select . . . in the interim, with the ACCESS System we hope to provide economically deprived individuals in developing countries an opportunity to learn to speak English as a second language so that they may improve their economic situation. " (WLP web site)

Thus, even after decades of steady progress and remarkable achievements -- the ACCESS system with videos and textbooks; ANJeL Tun with online translator and tutorial; extensive dictionary projects in multiple languages; teacher training programs, and much more -- the WLP remains open to innovation, and a great deal of important work remains to be done. Thus, the WLP may attract many creative and active members of groups such as JALT. Moreover, the pending designation of the WLP as a United Nations NGO, if granted, may greatly enhance the prestige of the program, and make more rapid progress possible. The WLP is already a project of a separate, independent UN NGO, the International Association of Educators for World Peace (IAEWP), and the WLP enjoys other important professional affiliations, including strong support by the admirable Project Gutenberg. (Project Gutenberg web site.) Recently, WLP volunteers began a training program in China, an important breakthrough for the program, and perhaps the first step in the global spread of a true International Auxiliary Language.

At last I will briefly outline some essential components of the ANJeL Tun system. What follow are slightly edited web site definitions of the ANJeL Tun phonetic system, followed by explanations of the three characteristics mentioned above: phonetization, elementalization, and regularization. The WLP web site includes a complete online tutorial for persons wishing to learn ANJeL Tun, which English speakers can master in about two days.

## The ANJeL Tun Orthography

The Angel alphabet consists of 39 symbols, each of which represents a unique sound. Unlike the traditional English alphabet, there is no duplication whereby different letter combinations can sound alike. For example, in English "threw" and "through", "bough" and "bow", "blue" and "blew", "write" and "right" have identical sounds but varied spellings. In Angel, all identical sounds have identical spellings.

The Angel alphabet assigns a unique symbol to each unique vowel and consonant sound. The symbols used are similar to those of the traditional English alphabet, with one big difference: Upper case letters have one unique sound, and lower case letters have another. In addition, sounds composed of multiple letter groupings (such as "oo", "ow" and "oy") are represented by single symbols in the Angel alphabet.

Unlike traditional English, Angel has no "silent" letters that can change the pronunciation of other letters in the word. (In traditional English, silent letters often change "short" vowels to "long" vowels: "cut" becomes "cute" even though we never hear that "e" on the end). In Angel, every letter in a word is essential and is pronounced.

In short, Angel is CONSISTENT. Its purpose is to permit new English learners to "See what we Say" on captioned TV, using the closed captioning decoder standards imposed by the U.S. Congress.

### Phonetization

Phonetization is the Simplified Spelling portion of the ACCESS System . . . Because the ACCESS system is tied to the character set encoded in new television sets under the law of the U.S. Congress we must use only the Roman Characters presented there. This, however, has the additional advantage of permitting materials to be developed anywhere there is type-generating

equipment that uses the standard English alphabet. . . .

## Elementalization

Elementary or basic ANJeL Tun uses Chomsky's concept of the distinction between 'form' and 'function' words (the latter including what some people call 'glue' words) to determine those words which should be taught and learned first. The English language has hundreds of thousands of form words which designate both concrete (words like boat, house, hammer, nail) and abstract concepts (like boating, housing, hammering, nailing and more particularly love, truth, beauty and other 'spiritual' ideas). . . . English, however, has at most only a few hundred 'function' words. These are the words that glue and relate the form words together. They are words like (of, to, if, and, for) and include relational words like (above, below, next, after). The function words are necessary to any form or discussion or writing that arises above pointing and naming. . . The most Elementary or most basic level of ANJeL Tun therefore seeks to teach only the function words . . .

*Once persons have learned the several hundred function words of the ANJeL Tun, they know the language. But of course they still cannot talk about anything since they do not have the form words. But it is now simple to teach persons the form words for, say, their employment. . . (After that) there may be (learning involving) a culturally shared experience involving a set of form words that are understood by most 12 year olds of average brightness. To learn these words would be a second level of accomplishment. Beyond that, the vocabulary for college admission or some particular profession may be still higher standards . . .*

## Regularization



English is a language of exceptions but the ANJeL Tun reduces the language as much as possible to a logical system of rules. Some of these concepts, but not nearly so extensively, were applied by Ogden and Richards. In regards to using the ANJeL Tun as an Intermediate Teaching Method (ITM) the idea is that it is easier to first understand and learn a system of rules and then later to comprehend the exceptions. This conformity to rules is what makes the ANJeL Tun a pidgin.

The essential aspects of the WLP are easy to understand. Although sensible persons avoid emphatic predictions, it seems reasonable to claim that the WLP can help advance the goal of an International Auxiliary Language, and in the interim provide a means of thinking more clearly about the roles of English and World Englishes. Given the stated pragmatism and flexibility of the WLP's goals, volunteers may be able to overcome obstacles and objections that their efforts may meet. Ongoing efforts in China will offer some of the first glimpses into the future prospect of the WLP.

Jonathan B. Britten has been employed at Nakamura University since 1992 and in Japan since 1989. He is currently the Japan Chancellor of the World Language Process.

### **Notes**

1. Space limitations regrettably prohibit even a brief discussion of World Englishes (WE), even though the topic is very pertinent to prospects for the WLP. The key issue in the relationship between English, World Englishes, and the World Language Process is that of mutual intelligibility. The WLP might someday provide the most-acceptable global standard for worldwide communication, particularly if varieties of English diverge greatly in future, as some scholars anticipate.

Information about WE is available from the web site of the International Association for World Englishes (IAWE) from <http://www.we.pdx.edu/conf.html>

Another useful starting point is: Kachru, B. B. (1986) *The Alchemy of English: The Spread, Functions, and Models of Non-native Englishes*. Urbana and Chicago, University of Illinois Press.

### **References**

Kachru, B, Editor, 1992, *The other tongue: English across cultures*. Urbana and Chicago, University of Illinois Press.

Project Gutenberg. Various online references retrieved 5 December , 2002 from <http://promo.net/pg/>

United Nations Population Fund, State of World Population 2002: Poverty and Education, Adobe Acrobat Document retrieved December 5, 2002, from <http://www.unfpa.org/swp/swpmain.htm>

Wallraff, B (2000). What global language? Don't bet on the triumph of English. The Atlantic Monthly, November 2000, 52-66. See also the online version and discussion at <http://www.theatlantic.com/issues/2000/11/wallraff.htm>

World Language Process. Various online references retrieved 5 December , 2002 from [http://www.webpal.org/webpal/a\\_reconstruction/language/](http://www.webpal.org/webpal/a_reconstruction/language/)

**MENU: [HOME](#) » [Reconstruction](#) » [Recovery](#) » [Renewal](#) » [Language Main Page](#)**

---

---

# Officers of the UNKOMMON Foundation as of November 15, 2002

[President](#)

[Secretary](#)

[1st Vice-president](#)

[2nd Vice-president](#)

**Liason with the IAEWP**

**[United Nations Special Envoy \(International Association of Educators for World Peace\)](#)**

**World Language Process Appointees  
as of November 15, 2002**

[Theory Coordinator](#)

[WLP Coordinator](#)

[Chancellor Coordinator](#)

[Regularization Coordinator](#)

[Graphics Coordinator](#)

## **32 Countries (Alphabetically) with WLP Chancellors as of November 15, 2002**

- |   |                                      |                                |                              |
|---|--------------------------------------|--------------------------------|------------------------------|
| 1 <a href="#">Abidjan</a> (Ivory Coast) | 2 <a href="#">Azerbaijan</a>         | 3 <a href="#">Bangladesh</a>   | 4 <a href="#">Botswana</a>   |
| 5 <a href="#">Brazil</a>                | 6 <a href="#">Burkina Faso</a>       | 7 <a href="#">Canada</a>       | 8 <a href="#">China</a>      |
| 9 <a href="#">Costa Rica</a>            | 10 <a href="#">Egypt</a>             | 11 <a href="#">El Salvador</a> | 12 <a href="#">France</a>    |
| 13 <a href="#">Ghana</a>                | 14 <a href="#">Guinea Equatorial</a> | 15 <a href="#">India</a>       | 16 <a href="#">Japan</a>     |
| 17 <a href="#">Kenya</a>                | 18 <a href="#">Korea</a>             | 19 <a href="#">Mauritius</a>   | 20 <a href="#">Morocco</a>   |
| 21 <a href="#">Netherlands</a>          | 22 <a href="#">Panama</a>            | 23 <a href="#">Philippines</a> | 24 <a href="#">Russia</a>    |
| 25 <a href="#">Sierra Leone</a>         | 26 <a href="#">South Africa</a>      | 27 <a href="#">Spain</a>       | 28 <a href="#">Sri Lanka</a> |
| 29 <a href="#">Suriname</a>             | 30 <a href="#">Syria</a>             | 31 <a href="#">Tanzania</a>    | 32 <a href="#">U.S.A</a>     |

[return to WLP home page](#)

## Abidjan (Ivory Coast)

Mrs. Adjaratou Delphine Traore,  
05 B.P. 330  
Abidjan 05 (Ivory Coast)

[return to directory of Chancellors](#)

2

## Azerbaijan

Dr. Alec Rasizade  
National Chancellor of Azerbaijan  
for the World Language Process  
Vice President for Academic Affairs  
American University - Baku  
Iskenderov Street, 1-16  
370004 Baku-4, Azerbaijan

[return to directory of Chancellors](#)

3

## Bangladesh

Dr. Abul Kalam, Professor  
Department of International Relations  
University of Dhaka  
Dhaka 1000, Bangladesh  
Phone: 505180 / 50038

[return to directory of Chancellors](#)

4

## **Botswana**

Mr. Diamond M. Selema  
National Chancellor of Botswana  
for the World Language Process  
Botswana Distance Education College  
P.O. Box 343  
Selebi-Phikwe, Botswana

[return to directory of Chancellors](#)

5

## **Brazil**

**(requests Spanish correspondence)**

Professor Dr. Wilson de Almeida Ribeiro  
National Chancellor of Brazil  
for the World Language Process  
Caixa Postal 2806  
Sao Paulo 01060-970, Brazil  
Phone: (011) 261-3856

[return to directory of Chancellors](#)

6

## **Burkina Faso**

**(requests French correspondence)**

Professor Dr. Amade Badini  
National Chancellor of Burkina Faso  
for the World Language Process  
05 BP 6080  
Ouagadougou 05

Burkina Faso  
Phone D: 30 42 92  
office: 36 25 38

[return to directory of Chancellors](#)

7

## Canada (contact World Language Process Coordinator)

[return to directory of Chancellors](#)

8

## China

(Chancellor) Professor Zhang Huixin  
and  
(Vice Chancellor) Professor Li Deyu

Shandong Polytechnic University  
Jinan, Shandong 250014  
PR China

techlaw@shell.sdcmt.co.cn  
Phone 86- 531- 2953- 900

Jack LIU  
World Language Process Chancellor and  
CNteach Coordinator at  
Yantai Jianwen College

25-2-2, Siyanqiao St.,  
Zhifu District,  
Yantai, Shandong,

China 264000

Tel/Fax: 86-535-6625534

Email: sinoteach@yahoo.com.cn

sinoteach@hotmail.com

Mobile:13053517477

[return to directory of Chancellors](#)

**9**

## Costa Rica

Dr. Rodrigo Carazo Odio

National Chancellor of Costa Rica

for the World Language Process

Apartado 247-1250

Escazu, Costa Rica

[return to directory of Chancellors](#)

**10**

## Egypt

Professor Dr. Mohammed Elbakry

I.A.E.W.P. Vice President for the Arab States

National Chancellor of Egypt

for the World Language Program

P.O. Box 167, Assiut Egypt

Fax (20) 2-760-874

[return to directory of Chancellors](#)

**11**

## El Salvador

## (Spanish Communication)

Dr. Sergio A. Carranza, Administrator  
National Chancellor of El Salvador  
for the World Language Process  
Universidad Nacional Auton. de Santa Ana  
3a C. Pte. Edif. La Curacao  
Santa Ana, El Salvador  
Phone: 503-40-7031, Fax 503-41-2575

[return to directory of Chancellors](#)

# 12

## France

Dr. Rodny Daniel, Professor  
National Chancellor of France  
for the World Language Process  
President, Institut des Affaires Internationales  
United Nations Department for Public Information  
F-9, Place de Peupleraie  
94470 Boissy St. Leger, France  
Ph: (33-1)45.98.11.10  
Fax: (33-1)45.86.24.79

[return to directory of Chancellors](#)

# 13

## Ghana

Dr. Kwesi Gyan-Ainuson  
National Chancellor of Ghana  
for the World Language Process  
Commission on Human Rights and  
Administrative Justice  
Old Parliament House



Aecra, Ghana

[return to directory of Chancellors](#)

**14**

## **Guinea Equatorial (requests Spanish correspondence)**

Mr. Nemesio Ntogo Nguema Nvoe  
National Chancellor of Guinea Ecuatorial  
for the World Language Process  
Director General de Juventud  
Ministerio de Educacion y Ciencia  
Malabo, Guinea Ecuatorial

[return to directory of Chancellors](#)

**15**

## **India**

Professor Dr. Venkat Ramana Janapareddi  
National Chancellor of India  
for the World Language Process  
108,arihantha apts.  
Visakhapatnamv  
Andhra pradesh 530 003  
India  
email [rmolleti@usa.net](mailto:rmolleti@usa.net)  
Phone 91 0891 5655 08 108

[return to directory of Chancellors](#)

**16**

## Japan

Professor Jonathan B. Britten  
National Chancellor of Japan  
for the World Language Process  
Nakamura University  
5-7-1 Befu, Jonan-ku  
Fukuoka, 814-0104 Japan  
jbritten@cc.nakamura-u.ac.jp

[return to directory of Chancellors](#)

17

## Kenya

Professor George Godia  
National Chancellor of Kenya  
for the World Language Process  
Department of Educational Foundations  
Moi University, P.O. Box 3900  
Eldoret, Kenya  
Phone: 0321-61221

[return to directory of Chancellors](#)

18

## Korea

Professor Nolin Stratton  
National Chancellor of Korea  
for the World Language Process  
Seoul City University  
90 Junnong-dong, Dongdaemoon-Gu  
Seoul 130-740 Korea

[return to directory of Chancellors](#)

**19**

## **Mauritius**

Mr. Jayraj Pahladi, FIBA  
National Chancellor of Mauritius  
for the World Language Process  
Royal Road Valetta Dagotiere  
Verdun, Mauritius  
Phone: 433-4900

[return to directory of Chancellors](#)

**20**

## **Morocco**

Lahcen Laabid  
Secretary General of the I.A.E.W.P. (Moroccan Chapter)  
Centre UNESCO  
Khemisset 15000, Morocco recommended by: Professor Dr. Abdelkader Naimi  
I.A.E.W.P. National Chancellor of Morocco  
B.P. 633, Khemisset, Morocco

[return to directory of Chancellors](#)

**21**

## **Netherlands**

Dr. B.J. in den Bosch  
National Chancellor of Netherlands  
for the World Language Process  
Hermelijnstraat 4,6562 LM Groesbeek  
The Netherlands  
Phone: 8891-76854

[return to directory of Chancellors](#)

**22**

## **Panama**

Dr. Ricardo Velasquez L.  
National Chancellor of Panama  
for the World Language Process  
Apartado 6-1367  
Estafeta El Dorado, Panama  
Phone: 507-60-6752, Fax: 507-27-4119

[return to directory of Chancellors](#)

**23**

## **Philippines**

Dr. Jaime B. Ramirez  
National Chancellor of Philippines  
for the World Language Process  
P.O. Box 1703  
Manila, Philippine

[return to directory of Chancellors](#)

**24**

## Russia

Dr. Elena Andreeva  
World Language Process  
National Chancellor of Russia  
Ul. Mozhajsкая  
g. 73, kv. 45  
Tver 10043, Russia

[return to directory of Chancellors](#)

25

## Sierra Leone

Mr. Salu B. Conteh  
National Chancellor of Sierra Leone  
for the World Language Process  
World Language Process (IAEWP)  
Sierra Leone National Office  
10 First Street  
P.O. 1086  
Freetown, Sierra Leone

[return to directory of Chancellors](#)

26

## South Africa

Professor Dr. A.M. Sadek  
National Chancellor of South Africa  
for the World Language Process  
P.O. Box 9472  
Azaadville 1750, South Africa  
Telefax: 413-2706

[return to directory of Chancellors](#)

**27**

## **Spain**

Professor Dr. Carlos Inchaurrealde  
National Chancellor of Spain  
for the World Language Process  
University of Zaragoza  
Zaragoza Spain E - 50009  
inchaurrealde@posta.unizar.es

[return to directory of Chancellors](#)

**28**

## **Sri Lanka**

Professor Dr. Sir Anto Jayasuriya  
National Chancellor of Sri Lanka  
for the World Language Process  
28, International Buddhist Centre Road  
Colombo 6, Sri Lanka  
Phone: 585242 / Telex: 22727

[return to directory of Chancellors](#)

**29**

## **Suriname**

Dr. Jnan H. Adhin  
National Chancellor of Suriname  
for the World Language Process  
Anand Nivas, Soelastraar 2, Z&H  
Paramaribo-Z, Suriname

[return to directory of Chancellors](#)

**30**

## Syria

Dr. George Jabbour  
National Chancellor of Syria  
for the World Language Process  
B.P. 9877, Damascus, Syria  
Phone: 214255 / 664656

[return to directory of Chancellors](#)

**31**

## Tanzania

Rev. Reward DM. Simbeye, Ph.D.  
National Chancellor of Tanzania  
for the World Language Process  
P.O. Box 3561 Mwanjelwa  
Mbeye, Tanzania  
Phone: 0255-65-3410 / 2875

[return to directory of Chancellors](#)

**32**

## U.S.A.

Dr. Mario Tabone  
National Chancellor of U.S.A.  
for the World Language Process  
P.O. Box 250196  
Franklin, MI 48025  
U.S.A.  
Phone: 517-349-4325

[return to directory of Chancellors](#)

**President of the UNKOMMON Foundation**

Ray Leibl  
99 Broadway Avenue  
Toronto Ontario Canada M4P 1V2 CANADA  
(416)487-2810 Fax:480-0679 rd.leibl@utoronto.ca

**Secretary of the UNKOMMON Foundation**

Wilfrid F. Olin  
2-5250A  
Yonge St.  
N. York, Ontario M2N 5P6  
(416) 512-2206 wilfeop@yahoo.ca

**Vice-President of the UNKOMMON Foundation**

Dr. A.T. (Toni) Sheehan  
St Joseph's College School  
74 Wellesley St. W. Toronto Ontario Canada M5S 1C4  
(416) 921-7129 direct  
484-6600 tonisheehan@hotmail.com

**Vice-President of the UNKOMMON Foundation**

Rae Smith  
55 Fiddlers Green Road  
Unit 28  
London, Ontario N6H 4T8  
(519) 641-4844  
raesmith95@hotmail.com

**Coordinator of World Language Process**

Bruce Beach



161 Main St.  
Horning's Mills, Ontario Canada L0N 1J0  
(519) 925-6035 language@webpal.org

**Chancellor Coordinator of World Language Process**

Mrs. Sally A. Ward  
Sally A. Ward  
339 North Granados Ave.  
Solana Beach, CA 92075

wardsa@juno.com

**Regularization Coordinator of World Language Process**

Antony Alexander  
c/o LANGO  
P.O. Box 141  
Douglas, Isle of Man  
IM99 1ZQ, U.K.  
Tel 44-1624-677-517 aitalexander@yahoo.co.uk

**Coordinator of Theorists of World Language Process**

Steve T. Bett, Ph.D.  
Consultant, Telecommunications  
and Learning Technologies  
114 Starlight Drive  
Natchitoches, LA 71457 U.S.A.  
318-356-8944 sbett@lycos.com

**Graphics Coordinator of World Language Process**

Warren Search  
92 Cedarwood Crescent  
Brampton Ontario Canada L6X 4K2  
(905) 460-1149 wsearch@triad-graphics.com

**Liason with IAEWP**

Mitch Gold G.A.  
Vice President of North American Affairs

International Association of Educators for World Peace  
and  
Vice President International Affairs / UN Special Envoy  
Tel : 416-924-4449 Fax: 416-924-4094  
Website: [www.homeplanet.org](http://www.homeplanet.org)

[return to directory of Chancellors](#)

**MENU: [HOME](#) » [Reconstruction](#) » [Recovery](#) » [Renewal](#) » [Language Main Page](#)**

---

---

**Criticisms of the World Language Process.**

There have been many criticisms of the World Language Process. The following attempts to answer the most frequent.

[Return to Main WLP Directory](#)

<b>Criticism #1:</b>	<i>The World Language Process is culturally imperialistic since it is promoting English as the universal auxiliary language.</i> <a href="#"><u>Go to Response #1</u></a>
<b>Criticism #2:</b>	<i>If you are committed to world literacy would it not be better to teach people to read and write in their native tongue, so that they may preserve their independent cultures, and find more usefulness in their immediate surroundings?</i> <a href="#"><u>Go to Response #2</u></a>
<b>Criticism #3:</b>	<i>There is already a universal auxiliary language. It is called Esperanto.</i> <a href="#"><u>Go to Response #3</u></a>
<b>Criticism #4:</b>	<i>The World Language Process is a plot towards the one world government to be run by the Anti-Christ. God did not mean for men to all speak one language or He would not have destroyed the Tower of Babel. The World Language Process is a humanistic anti-religious plot that is part of the satanist world conspiracy.</i> <a href="#"><u>Go to Response #4</u></a>
<b>Criticism #5:</b>	<i>The teacher requirements of the World Language Process do not conform to recognised educational standards for the profession.</i> <a href="#"><u>Go to Response #5</u></a>
<b>Criticism #6:</b>	<i>The World Language Process does not use recognised pedagogical methods, that is to say a method that is accepted and taught in academically accredited ESL teacher training schools in North America.</i> <a href="#"><u>Go to Response #6</u></a>
<b>Criticism #7:</b>	<i>The World Language Process creates or at least reinforces class differences.</i> <a href="#"><u>Go to Response #7</u></a>
<b>Criticism #8:</b>	<i>The World Language Process teaches people to speak and read a pidgin rather than traditional English with traditional English orthography.</i> <a href="#"><u>Go to Response #8</u></a>

**Criticism #9:**

*The World Language Process is entirely impractical because it does not have sufficient funding or the sufficient backing of any large government organization.*

[Go to Response #9](#)

[Return to Main WLP Directory](#)

**Criticism #1:** *The World Language Process is culturally imperialistic since it is promoting English as the universal auxiliary language.*

Actually, the UNKOMMON Foundation, of which the World Language Process is a program, does not at this point advocate English, or any other language, as being a universal auxiliary language. The Foundation's official position is that in the natural progress of humanity some still undetermined world authorized administrative body will in the future select an official universal auxiliary language. Until that time the World Language Process is responding to the international need that has manifested itself in the following facts:

- a. English is the language of choice by more people, to learn as a second language, than any other language in the world.
- b. There are now more people in the world who speak English as a second or foreign language than there are people who speak it as their mother tongue.
- c. Over ninety-five percent of all scientific literature is now originally written in English or is translated into it.
- d. English is the official language of air traffic control and maritime communication.
- e. English is the defacto international language of much of the business communication in the world. If in the common market a Frenchman, an Italian and a German were to meet they would be most likely to conduct their discussion in English.
- f. A 1994 national medical conference in China, which has fourteen official chinese dialects, was conducted in English.
- g. Over ninety-five percent of the material on the World Wide Web is in English.
- h. By learning English many economically deprived individuals in developing countries can obtain jobs in the tourist industry or with foreign employers.

- i. Most parents when asked which language they would prefer their children learn as a second language reply, "English". If your children's first language was not English, which language would you prefer that they learn as a second language if you only had a choice of one?

[Return to List of Criticisms](#)

**Criticism #2:** *If you are committed to world literacy would it not be better to teach people to read and write in their native tongue, so that they may preserve their independent cultures, and find more usefulness in their immediate surroundings?*

- a. There are over 3,500 languages in the world that are spoken by over ten thousand people. There are many more if we include the dialects spoken by numerous small tribes. Many of these have no script or only have had one devised in recent decades by someone like Bible missionaries. These latter often have no written tradition and very little scientific literature, if any at all.
- b. There are a number of historical world languages that are the source for broad historical traditions (such as Sanskrit, Hebrew, classical Chinese, Arabic, Greek, Latin and so forth) but the teaching of these is useful mostly to scholars.
- c. There are a number of modern world languages that contribute to modern science and culture (such as Japanese, German, French, Italian, Spanish and some Russian and Chinese dialects) but a large percentage of the intelligentsia and leaders of thought in those languages already speak English.
- d. The countries in the world which are technologically advanced generally already have widespread literacy programs and many of these countries (such as France, Chile, Japan and many others) already require their advanced students to learn English. The World Language Process is devised to reach the socially and economically deprived classes throughout the world.
- e. The cost of developing a single literacy program in a language with which we are familiar is over two million dollars. We cannot imagine how we could obtain the funding to develop thousands of such programs. If, one were to say, "then just select a few", which one would they suggest that would be more beneficial than English?

[Return to List of Criticisms](#)

**Criticism #3:** *There is already a universal auxiliary language. It is called Esperanto.*

- a. Yes, and a very noble and inspirational attempt it was but it never quite caught on. For one thing it may have been too Romance language oriented. For whatever reason, it and over 650 other attempts (according to the People's Encyclopedia) have not yet been successful. This may be just one more such attempt but we must keep trying. There were many unsuccessful attempts at heavier-than-air flying machines before the Wright Brothers were successful at Kitty Hawk.
- b. Fifty years ago there were a number of contenders for the universal language. Besides Esperanto there was Interlingua and Ido. French was also very much on the rise and was considered the language of diplomacy. German, however, was the language of science and without which one could hardly get an advanced degree in science. Latin, however, was the language of medicine and the law, not to mention the Catholic church. Greek, Hebrew and Arabic all had their place among Western scholars and there were other languages popular among the orientalist. Italian, of course, was the language of music. Today, however, they have all descended, or at least have nowhere near ascended in popularity as much as English.

[Return to List of Criticisms](#)

**Criticism #4:** *The World Language Program is a plot towards the one world government to be run by the Anti-Christ. God did not mean for men to all speak one language or He would not have destroyed the Tower of Babel. The World Language Process is a humanistic anti-religious plot that is part of the satanist world conspiracy. Or something to that effect.*

Please!! While the World Language Process is neither officially or unofficially associated with any religious or political organization of any kind and has no hidden agenda it is neither anti-religious or opposed to the just aspirations (religious, political, nationalistic, or cultural) of any group. In point of fact, the founder and the vision holder of the World Language Process feels himself to be a very religiously motivated individual wishing the spiritual unity of all the world's religions and working for a world peace that will result in the unification of all humankind. What more can be said that will satisfy these questioners?

[Return to List of Criticisms](#)

**Criticism #5:** *The teacher requirements of the World Language Process do not conform to recognised educational standards for the profession.*

- a. While many professional teachers feel that only people with their qualifications should be allowed to teach ESL, in fact most people who learn English do so from supposedly entirely unqualified persons, their mothers. Just as the medical profession in North America would have us believe that only M.D. obstetricians can deliver a baby although most babies in history have been delivered by midwives, much of the ESL profession would have us believe they are the only ones qualified to teach English as a Second or Foreign Language. The World Language Process might be considered as being the mid-wifery program of ESL.
- b. The World Language Process is designed more along the lines of an Each One Teach One type of program. We hope that the teachers that we train will teach other teachers, and so forth. The World Language Process is not aimed at the professional although any one is welcome to use it. Let the professional teachers teach in the Universities, this program is dedicated to those who cannot find or afford a teacher otherwise.

Many of the World Language Process teachers that we first send out might be looked upon as teacher interns, getting their first experience in the teaching field by giving a year of voluntary service. This puts their services within a range that many secondary schools and other establishments that could not otherwise have the benefit of a trained native English speaker will now be able to have a teacher in their school or other organization.

- c. There are almost four billion people in the world today who do not speak English. If English, or any other language, were to be taught to four billion people in the next twenty years (and at the present rate there will be well over two billion more people born in that time) then 300 million people have to be taught each year, which is more than twenty million people per month, assuming that it only takes a month to teach a person English.

Many people will think such a goal is hopeless, and it certainly is under present teaching methods. Today, many people in non-English speaking countries learn English in a university where it is taught by a professional individual who most usually holds a special graduate certificate in teaching ESL. The current teaching methods are such that it usually takes several years to learn to speak well enough to be able to travel to a different country and go into a restaurant and sit down and order a meal.

[Return to List of Criticisms](#)

**Criticism #6:** *The World Language Program does not use recognised pedagogical methods, that is to say a method that is accepted and taught in academically accredited ESL teacher training schools in North America*

- a. It is true that the system being used by the World Language Process, is a radically different system that seeks to teach the learner to speak in just thirty days with only three hours per day involvement. The nature of this system is so radically different that it is very unlikely that it will be accepted by the present ESL establishment. What this system is designed for is the ordinary individual rather than the scholar, scientist or professional. Someone who is perhaps going to meet tourists in a hotel, or while driving a cab, or in a retail shop. This system is meant to be ideal for someone needing to read specially translated technical manuals in a factory or communicate with English speaking business people or technicians.
- b. World Language Process Teacher volunteers will receive, through a correspondence course, a thorough explanation of the pedagogical methods used in the ACCESS system. The ACCESS system uses a variety of techniques that have been tested individually. It is the manner of their combination in this system that is unique.

[Return to List of Criticisms](#)

**Criticism #7:** *The World Language Program creates or at least reinforces class differences.*

The World Language Process is meant as a grassroots program. It is language sharing by ordinary people with ordinary people, rather than a rarefied university level linguistic and scholarly exchange. For this reason it is intended to be the effort of thousands of ordinary but dedicated individuals rather than that of a select and chosen and highly credentialed few. The typical teacher would be either a recent university graduate or student, or retired individual, who is willing to get some life experience by spending a year teaching ESL in another culture. It is the simplicity of the designed program that is supposed to assure their success, rather than extensive previous credentials.

[Return to List of Criticisms](#)



**Criticism #8:** *The World Language Program teaches people to speak and read a pidgin rather than traditional English with traditional English orthography.*

- a. It is true that the World Language Process seeks in less than a thirty day period to teach the learner to speak, read and write a simplified form of English that may be properly called a pidgin. However:
  1. any English speaking person will be able to understand them
  2. they may then be sufficiently encouraged that they will go ahead and learn traditional English syntax and orthography
  3. they will be able to read any of the English classics because these are all machine translatable into their simplified spelling
  4. they will be able to read any of the files on the Internet because these are all machine translatable into their simplified spelling
  
- b. Please note, however, that we have not said that within thirty days they will be able to:
  5. to understand the rapid speech, extensive vocabulary, or convoluted syntax of every English speaker that they meet
  6. to understand the sophisticated concepts of all the English classical literature and scientific journals that they will be able to read.
  7. or be able to speak English like an Oxford scholar.

[Return to List of Criticisms](#)

**Criticism #9:** *The World Language Program is entirely impractical because it does not have sufficient funding or the sufficient backing of any large government organisation.*

The World Language Process is a grass roots program of people to people. Hundreds of volunteers have supported it in the past and it will hopefully have the assistance of thousands - even millions in the future. At the moment it is still in a development phase but time and circumstances change in this world, and if its timing is right then it will be able to fulfill the destiny of its vision.

[Return to List of Criticisms](#)

[Return to Main WLP Directory](#)

**MENU: [HOME](#) » [Reconstruction](#) » [Recovery](#) » [Renewal](#) » [Language Main Page](#)**

---

---

## Questions and Comments about the World Language Process

Replies on behalf of the World Language Process by Antony Alexander ([aitalexander@yahoo.co.uk](mailto:aitalexander@yahoo.co.uk))  
<http://www.alexander.iofm.net>

[Return to Main WLP Directory](#)

<b>1:</b>	<i>What is the World Language Process?</i> <a href="#">Go to Response #1</a>
<b>2:</b>	<i>Assuming a globally representative congress or committee could agree on an IAL, wouldn't it be an unwieldy compromise? Wouldn't a functionable language require the coherent vision that only an inspired individual could provide?</i> <a href="#">Go to Response #2</a>
<b>3:</b>	<i>Wouldn't each member of the international committee seek only that the IAL conformed as far as possible to their own language, in whose favour they were likely to be prejudiced, albeit unconsciously?</i> <a href="#">Go to Response #3</a>
<b>4:</b>	<i>Isn't English already the international auxiliary language for all practical purposes?</i> <a href="#">Go to Response #4</a>
<b>5:</b>	<i>Esperanto is a perfectly adequate IAL which only needs support. Esperanto's official adoption and consequent implementation through educational systems worldwide would be hastened if sites such as this promoted it.</i> <a href="#">Go to Response #5</a>
<b>6:</b>	<i>"East is East and West is West and never the twain shall meet!" Kipling's sentiment remains as true today: cultures are essentially self-contained and will remain so; no more than the most basic IAL will ever be required.</i> <a href="#">Go to Response #6</a>
<b>7:</b>	<i>Shouldn't the international committee choose an entirely neutral language, equally easy or difficult for all nationalities?</i> <a href="#">Go to Response #7</a>
<b>8:</b>	<i>Would it be possible to guess what kind of IAL the international committee might select?</i> <a href="#">Go to Response #8</a>
<b>9:</b>	<i>Does the World Language Process have any additional preferences?</i> <a href="#">Go to Response #9</a>

[Return to Main WLP Directory](#)

**1: *What is the World Language Process?***

The World Language Process promotes the selection or formation of an international auxiliary language and script (IAL) according to scientific criteria by a globally representative congress or committee. We envisage the IAL as the first step towards a single world language and script in the distant future. The World Language Process is also pursuing a number of related projects including online translation and electronic databases.

[Return to List of Questions and Comments](#)

**2: *Assuming a globally representative congress or committee could agree on an IAL, wouldn't it be an unwieldy compromise? Wouldn't a functionable language require the coherent vision that only an inspired individual could provide?***

No single person can possibly know enough to construct the IAL. The history of the movement has demonstrated this, though Schleyer, Zamenhof and others deserve every plaudit for their valiant attempts. Informal collaborations have fared no better: they have always split on controversial issues.

A congress or committee solves these problems by vesting authority in its unanimous or majority opinion. Of course there is a danger in this too, so a properly constituted arrangement is necessary - one which incorporates systematic consultation with all interested parties into the decision-making process. There is no reason, in fact, why the official committee and their consultees should not collaborate for the benefit all concerned.

[Return to List of Questions and Comments](#)

**3: *Wouldn't each member of the international committee seek only that the IAL conformed as far as possible to their own language, in whose favour they were likely to be prejudiced, albeit unconsciously?***

The common language question has returned to the fore as rising international tensions have raised the tempo and importance of communications. The deepening global recession has also served to move the IAL question up the political agenda. In the context of straitened economic circumstances the increasing cost of translation (and mistranslation) in the world's expanding unions of nation states has come into focus, as has the cost of foreign language teaching in state education systems. International agencies are becoming ever more receptive to the idea that an IAL would begin to eliminate these costs. At some stage in the not-so-distant future an international committee is likely to be appointed and told to get on

with it - and its members may have no choice but to give at least as much weight to facility of global communication as to sectional familiarity, i.e. "user-friendliness" for various peoples .

The advance of scientific linguistics is another factor that will help to maintain a proper balance with political interests. A great deal of high-quality research now exists concerning subjects which might be expected to inform and influence the course of IAL discussion and decision-making: comparative grammar and phonology, childhood speech and literacy acquisition etc..

### [Return to List of Questions and Comments](#)

#### **4: *Isn't English already the international auxiliary language for all practical purposes?***

Not really, though some of its proponents in the media might convey that impression. English does have semi-official status in a few specialised fields, including air and maritime telecommunications, but even there its use is far from universal. Having said that, it's undoubtedly true that English is the leading auxiliary language in the world today, and will continue as such for a long time to come - whatever is decided concerning the IAL. As for English itself being officially selected, we think it most unlikely - for historical political reasons, and because of an irregular spelling system which has proved highly resistant to reform.

Moreover, as has often been pointed out, the pre-eminence of the English language relates more to the current status of English-speaking civilisation than to its inherent qualities. If the dominance of the English-speaking countries - which has arguably lasted from 1815 to the present - were to be superseded, the English language might consequently be expected to go the way of Ancient Greek, Latin, Arabic and French. The demise of the British Empire, the relative economic decline of America, the reversion of several ex-colonies to native languages, the establishment of rival languages in former English-speaking heartlands, and the continued political and cultural opposition to the English language from various quarters in several countries - all these are indications that the dethronement of English might already be proceeding.

The following statements are pertinent in this regard, though over a decade old:

....."In 1989 a study conducted in Belgium, France, Germany, Italy, the Netherlands and Spain concluded: "The real correct understanding of English in all the countries studied is notably inferior to the most pessimistic existing evaluations and our own guesstimates" Van de Sandt, Report in "Initiative Media News Bulletin" (London: Lintas Worldwide, January 1989)

.....In 1990 Sir (now Lord) Randolph Quirk, Professor of English at University College in London, put it thus: "Despite the persistent and glib assumptions in Britain and America, we are witnessing a significant relative decline (perhaps even an absolute decline) in the currency of English worldwide. This may come as a surprise to those who think of English as the medium of high-tech skills, international conferences, and professional journals: here indeed continued growth is doubtless the order of the day. But these are relatively slim and specialized lines of communication."

.....In 1991 Richard Bailey, Professor of English Language and Literature at the the University of Michigan and Associate Editor of the "Oxford Companion to the English Language" was even more specific: "The proportion of the world's population who regularly use English is 15% - and falling".

[Return to List of Questions and Comments](#)

**5:** *Esperanto is a perfectly adequate IAL which only needs support. Esperanto's official adoption and consequent implementation through educational systems worldwide would be hastened if sites such as this promoted it.*

We believe that the international congress or committee which chooses or forms the IAL will in effect be revising Esperanto. The love and effort put into Esperanto will be realised in the coming IAL, which will be constructed very much upon its basis and inspired by its continuing influence. However, Esperanto as presently constituted looks most unlikely to gain the popular support necessary to become de facto IAL, or even to be officially appointed for the role. The absence of a thorough reform to make Esperanto more globally acceptable must be partly responsible: for instance, Esperanto's grammar is especially difficult for various peoples. There are a number of criticisms of Esperanto on the Internet, including <http://www.xibalba.demon.co.uk/jbr/ranto.html> .

[Return to List of Questions and Comments](#)

**6:** *"East is East and West is West and never the twain shall meet!" Kipling's sentiment remains as true today: cultures are essentially self-contained and will remain so; no more than the most basic IAL will ever be required.*

There are two schools of thought here. On the one hand, there are those who believe that, after the IAL is officially instituted, everyone will always and for all time speak at least two languages - the various mother-tongues for domestic consumption and the IAL for international communication. These hold that the primary focus of culture is national or ethnic, but that international agencies are necessary in order to support the requisite level of material civilisation - through trade, tourism, transport, communications, science, peace-keeping and the like. In other words, the international agencies deal in mundanities, whereas the more spiritual side of life - whether found through historic religions, secular philosophies, national treasuries of literature etc. - is not "global" or "international" in any real sense, since it is always linked to a particular culture or tradition.

On the other hand are those who discount the possibility of self-sufficient or autonomous entities communicating indefinitely on a second-hand basis, believing that all languages will eventually merge into a single language by way of an official IAL, and claiming that this process is merely a conscious continuation of what is already occurring. Decades or centuries after the official IAL inauguration,

everyone might still learn at least two languages at school, but they would expect the IAL to develop relative to the mother tongues.

They would point to the precedent of pidgins and creoles, inasmuch as pidgins were IALs on a smaller scale, formulated for essentially the same reason - the pertinent fact about pidgins being their tendency to become creolised: a process shown to derive from children learning and using the pidgin as a mother tongue. Thus, although pidgins were originally employed as purely auxiliary trading languages - second languages that nobody used as a mother tongue - children of certain traders, seafarers etc. evidently learned the pidgins as mother tongues, and elaborated them with borrowed or intuitive grammatical constructions and new words from various sources - exactly as tends to happen with mother tongues or primary languages in their developmental phase.

Correspondingly, since the IAL will begin its life essentially as a global pidgin, there is every chance that it will be elaborated by future generations in a similar way and for the same reasons. The modern world contains an ever-increasing number of itinerant key workers and administrative personnel employed by transnational corporations and international agencies. Such people will find the IAL particularly useful, whether or not they possess other second languages such as English, and consequently the children of some of them are likely to pick up the IAL as a mother tongue. The intuitive elaboration of the IAL might then be expected to follow, in concert with more formal and conscious innovative attempts by authors, advertisers, film-makers etc. who might well wish to write in the IAL directly in order to access the global market, the whole being co-ordinated and kept within acceptable bounds by the IAL committee.

Assuming this process of development came to pass, the relationship between the IAL and every national tongue would be comparable to that which formerly existed between the minority ethnic tongues and the great national languages which entirely surrounded them. Thus, even as islands of minority ethnic tongues have been surrounded by a sea of English, every language would eventually find itself within the matrix of the IAL. And correspondingly, even as English formerly diluted and absorbed minority ethnic tongues in its midst, English would itself be absorbed, along with all other languages, into one universal tongue of enormous capacity and subtlety.

The history of the dogged survival of certain minority ethnic tongues clearly shows that such a process would never be achieved by force, rather would it happen for cultural and economic reasons. Thus, if speakers and writers were to deliberately use the international auxiliary language to reach the widest possible audience or readership, and listeners were to learn it - and tune into it - to keep up with the latest news and newest thought from anywhere in the world, there is little doubt that this common language would develop its own character as a truly global tongue, even as primary creative impetus went into it. If this did indeed happen - whether through neologism, transliteration, or other aspects of linguistic development - the national languages of the world could be expected to successively abandon their separate identities, over a period of centuries, in order to become part of it: in the same way that some minority ethnic tongues have hitherto become submerged in national languages.

Thus there is no reason to suppose that an international auxiliary consciously developed for creative usage would not gradually obtain the linguistic and euphonic capacity to incorporate all useful features, whether structural or decorative, from both "national" and constructed languages. Indeed, it might well display these assets more precisely and harmoniously than their own more or less irregular grammars, partial phonologies and ramshackle orthographies. In such a scenario the mother-tongues would continue to be preserved in written and recorded form, but ultimately for sentimental value rather than linguistic information.

[Return to List of Questions and Comments](#)

**7:** *Shouldn't the international committee choose an entirely neutral language, equally easy or difficult for all nationalities?*

An entirely neutral language would be very difficult if not impossible to realise in practice. For instance, unless the script were bi-directional, or vertical perhaps, it would favour either the left-to-right majority or the right-to-left minority. Similarly, there would have to be a choice between logographic and alphabetic script - the former benefiting East Asian countries such as China and Japan, and the latter the rest of the world. Much the same might be said about phonology and grammar. Moreover, even if a "horizontal" neutrality were achievable between the very diverse languages and scripts of the world, there might still be the problem of finding a "vertical" neutrality, or median position, between linguists and non-linguists. Briefly, there is no advantage in reinventing the wheel, so far as the IAL is concerned. Even a brand new solution of apparently impeccable political correctness would inevitably contain hidden inequities - quite apart from its difficulty for everyone due to unfamiliarity. An equally fair, but much more practical and realistic system would borrow linguistic features from as wide a variety of languages as possible, perhaps to some extent on a population pro rata basis. There would then be a certain amount of give and take. For instance, those who had to master a quite alien script for the IAL might see a relatively large proportion of their grammar and/or vocabulary incorporated into it, and so on.

[Return to List of Questions and Comments](#)

**8:** *Would it be possible to guess what kind of IAL the international committee might select?*

They might well operate within certain established norms endorsed by many IALers, as by others with an interest in the subject. These include:

a.. alphabetic script - logographic scripts take many times longer to learn



- b.. orthographic script - one-to-one correspondence between letters and sounds with no duplicated or silent letters
- c.. regular grammar, with the simplest possible rules, and no exceptions
- d.. no linguistic genders
- e.. an international vocabulary - with the eventual goal of words from as many languages as possible
- f.. no synonyms - only one word or name for each thing

[Return to List of Questions and Comments](#)

**9: *Does the World Language Process have any additional preferences?***

Only one at this early stage: an IAL Hierarchy - which from the practical viewpoint is the gradual introduction of a single IAL in stages. An IAL Hierarchy addresses the problem of universal acceptability. A median IAL, pitched somewhere between the usages of the various national languages, and between linguists and non-linguists, might purport to do this but actually discriminates against those at the extremities. Although suiting those towards the middle, it might well be regarded with suspicion as too easy by one part of the population, and with trepidation as too difficult by another part.

Orwell's "Newspeak", probably based on his perception of Esperanto and Basic English, is an old chestnut that might be brought out by way of illustration. Orwell's inference that an imposed IAL might be used to limit the thought and expression of speakers of more complex languages evidently struck a chord with his readers - unless it is purely coincidental, and related only to the ascendancy of the English language, that both Esperanto and Basic English have declined so much since his book was published.

On the other hand, a median IAL such as Esperanto is beyond the capacity of many non-linguists, particularly those whose own languages have a very different or more restricted grammatical structure or sound system. Certainly, speakers of creoles and some Asian tongues have found Esperanto very difficult. Many English speakers have also found Esperanto challenging, since it uses grammatical constructions that English manages without, apart from vestigially.

The two alternatives to a median IAL have, of course, been an advanced IAL and a basic IAL: Schleyer's "Volapuk" and Hogben's "Interglossa" (forerunner to "Glosa") are respective examples. However, for the reasons mentioned, neither of these IALs would now be acceptable. The inadequacies of Volapuk became evident when people tried to use it in everyday conversation; it obviously lacked a basic version. Conversely Interglossa, with its three tenses and absence of inflections, was in many ways an ideal IAL - though its lack of expandability was a fatal drawback. No current IAL is expandable or contractable: that is the problem with all of them.

Any language taught to children begins with "infant-speak". Those transmitting the language to the very

young instinctively employ the simplest grammar, the easiest speech sounds and the shortest words, often internally repetitive. However, the "infant-speak" is really the same language as that used by adults, as are the other gradations and variations.

The essential problem with IALs at the present time is that none of them have a "infant-speak" version and an advanced version and all the versions in between. For practical reasons, it's necessary to start with an "infant-speak" as the official IAL, whilst the other IALs in the hierarchy are developed in the background. At the requisite time, when all (or nearly all) peoples have attained the next level as a result of cultural and linguistic development, the second IAL on the hierarchy (which many if not most people in the world would already be using unofficially) would be designated as the official IAL, and so on. Thus the IAL hierarchy is really a single IAL, introduced in stages.

The table below, reproduced for illustrative rather than prophetic purposes, shows the kind of scheme the World Language Process has in mind. For mnemonic purposes, the number of consonants and vowels accords with the year of introduction. Thus Lang25, with 25 phonemes in its sound system - 20 consonants and 05 vowels - would be introduced in the year 2005 AD.

Lang25 would have an alphabetic script (possibly English-type, without diacritics), a very basic grammar (possibly Chinese-type, word-order based, wholly analytic), and the core vocabulary without consonant clusters etc. would be limited to the twenty most universal consonants identified by the UPSID survey and the five vowels (a, e, i, o, u) which most languages employ, and to which Spanish, Japanese and other tongues are restricted.

Perhaps the year 2005, at least, will be prophetic since the beginning of the construction of the World Language Process Universal Language Institute at Horning's Mills, Ontario, Canada is scheduled for that year.

Provisional IAL Name	Number of Consonants & Vowels	Inaugural Year as Official IAL	First Language or Mother Tongue	Second or Auxiliary Language
Lang53	27 C 26 V	2726 AD	100%	0%
Lang49	26 C 23 V	2623 AD	98%	2%
Lang45	25 C 20 V	2520 AD	90%	10%
Lang41	24 C 17 V	2417 AD	70%	30%
Lang37	23 C 14 V	2314 AD	30%	70%
Lang33	22 C 11 V	2211 AD	10%	90%
Lang29	21 C 8 V	2108 AD	2%	98%
Lang25	20 C 5 V	2005 AD	0%	100%

[Return to List of Questions and Comments](#)

**MENU: [HOME](#) » [Reconstruction](#) » [Recovery](#) » [Renewal](#) » [Language Main Page](#)**

---

---

**MENU: [HOME](#) » [Reconstruction](#) » [Recovery](#) » [Renewal](#) » [Language Main Page](#)**

## World Language Process Picture Gallery

The World Language Process has continuously progressed for many years. There should be, by now, many pictures for our picture gallery but we are just starting this page and hope to soon add more pictures to it.

The proposed architectural center piece of the UNKOMMON Foundation and the World Language Process is the [Universal Language Institute](#) at Bahji du Canada.

These are pictures of a model of the building that we hope will be built sometime in the next ten years. This picture is a [side view](#). The building won first prize in 1988 for Canadian Architectural Design.

The site for the Universal Language Institute is a beautiful rural setting divided by a stream and waterfall. On the other side of the stream is the [dormitory building](#).

The Universal Language Institute is located in the highest county in Ontario and is located on one of the highest hills in the county. From this height a [tall antenna](#) is intended to give it a broadcast reach all across North America.

The [overall site](#) has a deep spiritual significance in the history of Aboriginal Americans whose oral tradition prophesized that it is where a Great Treasure of the world would be discovered - which we hope to mean the Universal Auxiliary Language.

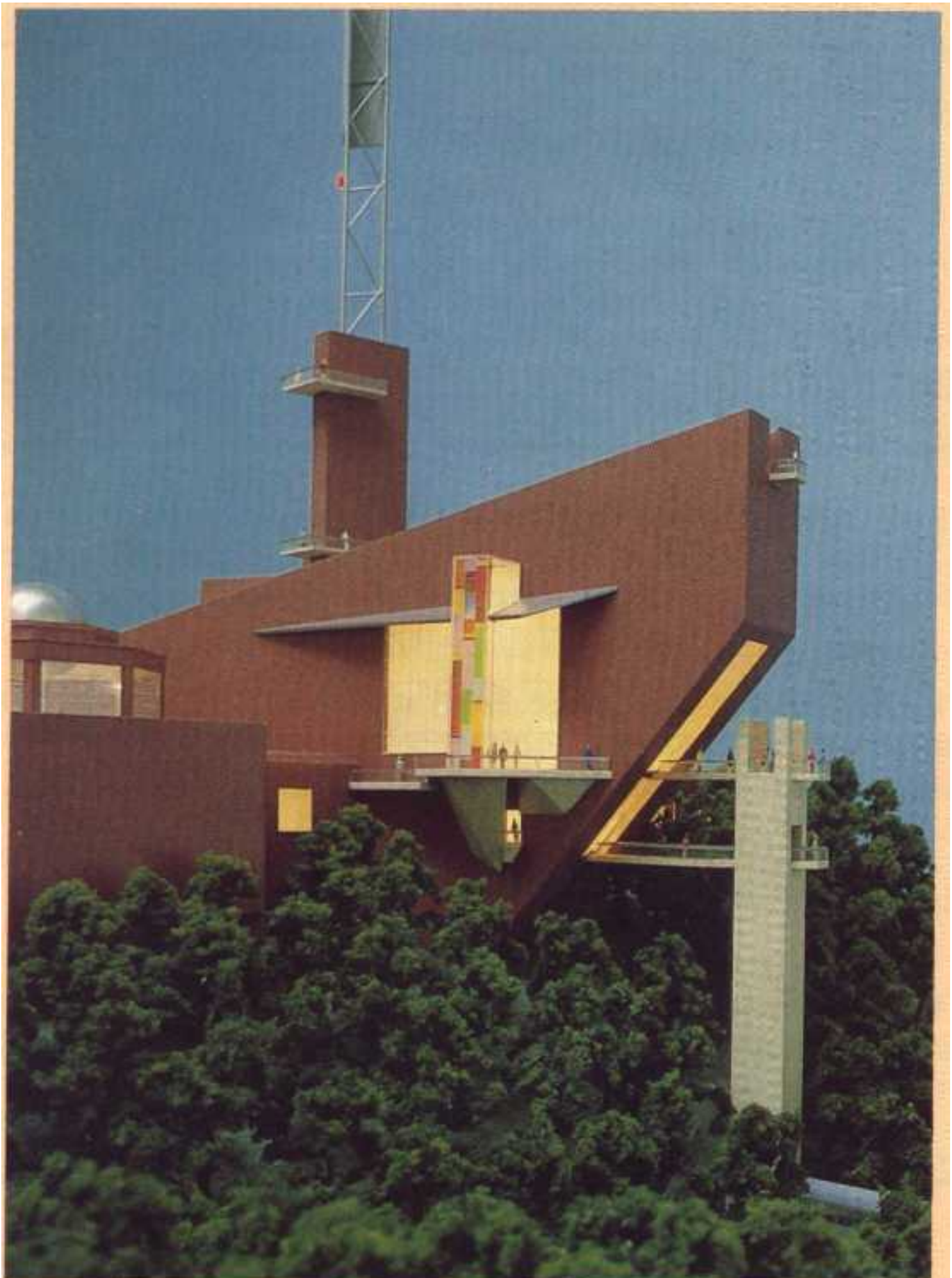
The Universal Language Institute is being dedicated as a memorium to [Bahji Barrett Beach](#) whose [memorial](#) is located on the site and who is buried beneath the [rock](#) located there.

In July of 2002 we held the first annual World Language Process picnic [picnic](#) at Bahji'i du Canada [with attendees](#) from Ontario, Quebec, Michigan, Oklahoma, and Washington.

**MENU: [HOME](#) » [Reconstruction](#) » [Recovery](#) » [Renewal](#) » [Language Main Page](#)**

---

---





























# CHINA GOALS of The World Language Process



The **UNKOMMON** (**UN**iversal **KOM**unications por la **MON**de - *Esperanto*) Foundation and its World Language Process have always considered China as being one of the **MAJOR** players in establishing a global Universal Auxiliary Language.

[\[Link](#) to the main page and the history of the World Language Process.]

[Picture is of a model of the Universal Language Institute to be built in Canada.]

The Coordinator of the World Language Process has made several trips to mainland China regarding the establishment of Language Teaching Institutes.

[Picture is of the coordinator's son and his son's family. The WLP coordinator's son taught English for a year in Northern China and now operates a Montessori method and English language school in Taiwan.]



While in Jiangsu, China, the World Program Language coordinator and the UNKOMMON Foundation, was granted a corporate charter for **EDCO** (**ED**ucation **CO**rporation) which was the first corporate charter ever granted by the modern state of China to a non-Chinese person or entity.

A primary goal of the UNKOMMON Foundation and EDCO is to establish non-profit language teaching institutes in China.



[Picture is of Bruce Beach,  
Coordinator of the World  
Language Process.]

The intent of the Olympic Committee in China to train guides, coordinators, facilitators and other personnel who speak English provides an exceptional opportunity for service by the UNKOMMON Foundation and its World Language Process.

The World Language Process has developed a system called:

The **ACCESS** System  
(**A**uxiliary **C**losed **C**aptioned **E**nglish with **S**implified **S**pelling)

which is a revolutionary new language teaching system, based upon:

a new **Technology**  
a new **Methodology**  
a new **Pedagogy**

that permits a person who has never spoken English, and who is perhaps even illiterate in their own language, to learn *in less than one month* to:

**read** the *MOST COMPLICATED POSSIBLE* directions  
to a person who speaks English.

**give full explanations** in English

regarding their specialty such as maid service, waitering, etc.

**take simple directions**

in English from a person who speaks English

Not only that - but a person who has learned all this by using the ACCESS System, at the end of the month they have spent learning it, can then use the same system to teach others.

Thus it is - that by each person who spends one month learning the system, spending another month teaching just ten others, within a year millions of Chinese who do not presently speak English can have learned to speak, regarding their trade, skill or specialty, so that English speaking persons can understand them.

It is our great hope that the officials responsible for these services and capabilities at the Olympics in China - will allow us to further explain in detail **The ACCESS System**.

Contact:

Bruce Beach  
World Language Process - Coordinator  
CANADA - (519) 925-6035  
language@webpal.org

**MENU: [HOME](#) » [Reconstruction](#) » [Recovery](#) » [Renewal](#) » [Language Main Page](#)**

---

---

# VOLUNTEER TEACHERS

The World Language Process presently has requests for hundreds of teachers to teach English. Many of these requests are from Governors of Provinces in Thailand, but there are many requests from other places in the world including from the State of Florida for teaching English to Spanish speaking prisoners.



Unfortunately, while the positions just mentioned provide room and board for the volunteers and have no cost to the volunteers, except transportation, they do require the availability of the World Language Process ACCESS System which, because of economies of scale, we cannot implement until we have requests for thousands of teachers.

While in the past we maintained a registry of teacher volunteers we discontinued doing so because we found that obtaining volunteers was not going to be a problem since there are many university students and retired people willing to volunteer. The problem is that we need requests for *THOUSANDS* of teachers so that we can implement the ACCESS System. For this, our present hope is that the Government of China will want to use many thousands of volunteers to teach English for the upcoming Olympics in China.

In the interim, we are assisting an affiliate in China to obtain volunteer teachers for the affiliate's English teaching program. Please understand, that while there is some expense to the volunteers for this program that the World Language Process *does not receive one penny* of the fees or any remuneration *of any sort* for helping make the placements. We do it completely in a spirit of service to China and the world.



The Chinese affiliate is called CNteach.net and is an independent, non-political and non-religious network for placement of native speakers of English and international volunteers to teach in China and for hosting international students to learn Chinese in China under the sponsorship and guarantee of Yantai Jianwen College. Presently, there are two programs.



## The Two Programs

One program is a **VOLUNTEER TEACHING** program and the other program is a **STUDY** program. The participant may enroll in one *or* the other. The different mission statements of the two programs are as follows:

### 1. The Volunteer Teaching Program

Placement of native speakers of English, international travellers and volunteers to **TEACH** conversational

English in various kinds of Chinese schools, colleges and universities on both short-term and long-term basis.

## 2. The Chinese Study Program

Hosting/receiving international students to **STUDY** Chinese language and culture in Chinese schools or universities.

### The Teaching Program

The mission of CNteach is to promote volunteerism and improve the quality English education in China as well as enhance intercultural understanding and friendship through English education.

CNteach volunteer positions are available year round for both short-term and long-term placements with associate schools, colleges and universities in China.



## Requirements

The qualifications required for teaching and volunteering on any of the associate campuses are as follows:

1. Must be a native speaker of English
2. Must be 18 years of age or older
3. Must be healthy
4. Should be enthusiastic

The package of benefits offered by all Chinese schools through CNteach are as follows:

1. Free standard quality room on campus with daily living facilities and necessities.
2. Monthly living allowance (pocket money), which will cover the basic daily expenses during the teaching placements.

3. Free local tour and sightseeing during weekends and/or holidays.
4. Teaching and living assistance provided.
5. Free Chinese language learning class arranged.
5. Free airport pick-up at local airport.

The volunteer will have to cover the following costs:

1. International round-trip airfare and China domestic airfare.
2. Phone bills if any.
3. Overseas travel and health insurance.
4. Other personal spending and costs not mentioned above.

The volunteer will be teaching conversational English for 16-20 hours per week. No classes on Saturdays and Sundays.

## Fees

There is a modest administrative program cost for both the Volunteer Teacher Program and the China Study Program and which the volunteer or student must pay.

There is a ONE TIME administrative fee of \$350  
and  
A \$50 per month maintenance fee.

The volunteer or student can extend their stay up to any period of time that they wish providing that they can obtain the required government visa. Fees are payable upon completion of arrangements and should be compatible with the visa period. For example the total fee for a planned stay of three months would be \$500 and the total fee for one year would be \$950 with annual extension fees of \$600 payable at the time of visa extension for those who stay for multiple years.

## Benefits of the Volunteer Teacher Program

The CNteach program fee covers an administrative charge, placement arrangement, accommodation, three meals/per day during the teaching periods, local transportation for volunteers and supervision, daily coordination between volunteers and the sponsoring schools as well as the organization of social activities such as parties, conferences, family visits/stays and so on.





The program fee is also taken as the contribution and donation from the volunteers to the China Teach and Volunteer Program to help the students and schools in development of the curriculum, and cover the costs of the library facilities, the textbooks and teaching materials.



As this is a teaching and volunteering program, the volunteers should not expect financial gain from the program. However the volunteers do benefit from living with the local Chinese community, experiencing the Chinese culture, visiting the relics of the Chinese heritage and as well in the making of Chinese friendships.



For the moment, the CNteach program focuses on the placement of volunteers in Yantai City and its neighbouring cities, Shandong Province, China. The people in Shandong are hospitable, friendly and easy-going and show great respect to the foreign teachers and volunteers.

## Additional Costs of The Chinese Study Program

While there are free Chinese language classes for the Teacher Volunteers there is an additional program fee for students who prefer to spend full time studying the Chinese Language. This fee varies from school to school, and will be quoted separately depending on the requests of individual applicants.

## Additional Information

For information on Yantai and Shandong Province, please refer to the following sites for details:

1. [www.apec-china.gov.cn](http://www.apec-china.gov.cn)
2. [www.chinatravel168.com](http://www.chinatravel168.com)
3. [www.yantaimarket.com](http://www.yantaimarket.com)
4. [www.cnyantai.com](http://www.cnyantai.com)
5. [www.sdta.gov.cn](http://www.sdta.gov.cn)
6. [yantaidi.gov.cn](http://yantaidi.gov.cn)

To enroll contact:

Bruce Beach

World Language  
Process - Coordinator  
language@webpal.org



Or contact directly:

Jack LIU

CNteach coordinator  
25-2-2,Siyanqiao St.,  
Zhifu District,  
Yantai, Shandong,  
China 264000  
Tel/Fax:86-535-6625534  
sinoteach@hotmail.com



**MENU: [HOME](#) » [Reconstruction](#) » [Recovery](#) » [Renewal](#) » [Language Main Page](#)**

**MENU: [HOME](#) » [Reconstruction](#) » [Recovery](#) » [Renewal](#)**

## Nuclear Survival Resources & Ark II Fallout Shelter Site

**[Nuclear Targets](#)  
and ESSENTIAL survival info  
[By STATE](#)**

**[Ark Two Facility](#)  
Photos & Info of a 42 Bus  
Nuclear Fallout Shelter  
Inside, out, and construction**

**[Radiation Detection Equipment](#)  
Pictures, Instructions  
Variety of types**

**[FREE Survival Books](#)  
and  
[Ark Two Programs](#)**

**[Shelter Building](#)  
alternate Survival and  
*KI Information***

**[Free Shelter Consultation](#)  
with a  
Radiological Scientific Officer**

The author, [Bruce Beach](#), can be reached personally at: [survival@webpal.org](mailto:survival@webpal.org)  
Subscribe to his popular mailing list by sending a blank email to:  
[arktwo-request@deuce.pairowoodies.com](mailto:arktwo-request@deuce.pairowoodies.com)  
with the subject as [subscribe](#)

**MENU: [HOME](#) » [Reconstruction](#) » [Recovery](#) » [Renewal](#)**

# State Maps and Information for **Nuclear Survival**

(Updated as of October 1st, 2002)

For the last several years, these pages **USED TO** include a list of *hundreds* of (Email VERIFIED) Intentional Communities and Survival Preparedness Groups along with an Ark Two state TEAM Leader in forty-eight of the 50 States.

Because of the changing circumstances that some see as the increasing immediacy of the threat, and because of a perception that there has been a recent change in the social / governmental attitude towards individual rights regarding freedom and property there has been a growing consensus among the individuals that were listed here that it is no longer prudent for them to make their names and locations public. It has become too arduous to maintain the list in response to the growing number of requests for deletion, and the fact that the list was going to become too skimpy to be useful has now led us to have to regrettably abandon it altogether after these many years of effort spent to assemble it.

While for years we have encouraged people to form survival communities and groups and to build shelters and otherwise make preparation - most of those who have done so are of the opinion that there may not any longer be sufficient time to integrate further members into their groups and communities. They are concerned that if the threat situation continues to increase, at the rate that it presently is, they will be overwhelmed by individuals who are not prepared and that those individuals instead of adding to their resources would only be a drag and potential for depletion to what they have prepared.

It is with regret that we have come to this point. Ark Two itself still welcomes any who wish to join its community in Canada AND we are still maintaining the structure of these pages AND THE REGISTRY so that in case of a nuclear war we may be able to implement these structures for providing assistance during the RECOVERY and REORGANIZATION phases. We hope at that time to be able to re-establish contact with, or appoint new, TEAM leaders in all the states and localities and then provide a network for developing assistance and cooperation among them.

**The following States in "red" Generate the MAJOR FALLOUT  
According to FEMA**

**Click on *your* STATE'S NAME in the DIRECTORY below to see its targets and other IMPORTANT information. Also look at the *TWO* maps at the botom of this page.**

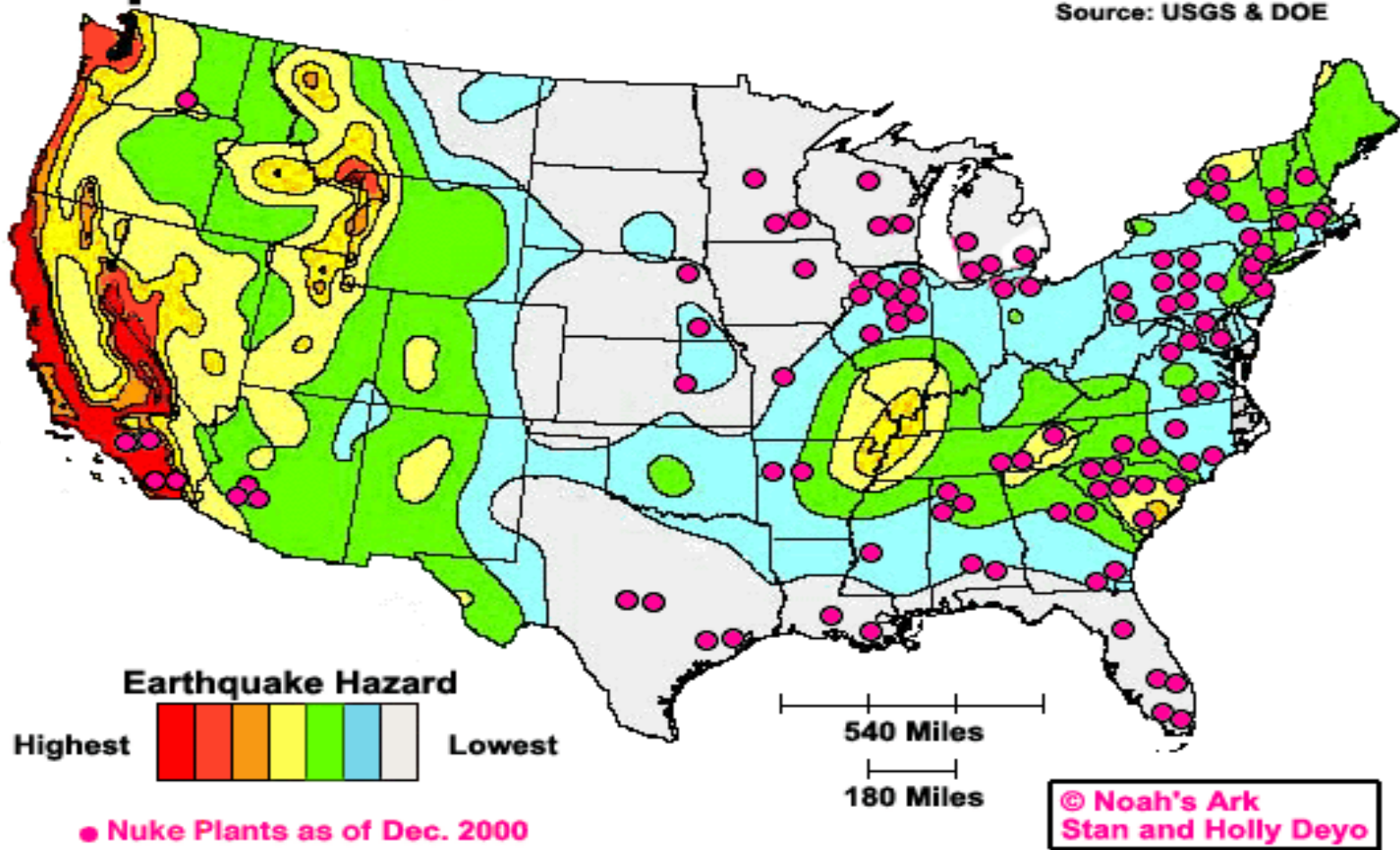
<a href="#"><u>Alabama</u></a>	<a href="#"><u>Alaska</u></a>	<a href="#"><u>Arizona</u></a>	<a href="#"><u>Arkansas</u></a>	<a href="#"><u>California</u></a>
<a href="#"><u>Colorado</u></a>	<a href="#"><u>Connecticut</u></a>	<a href="#"><u>Delaware</u></a>	<a href="#"><u>Florida</u></a>	<a href="#"><u>Georgia</u></a>
<a href="#"><u>Hawaii</u></a>	<a href="#"><u>Idaho</u></a>	<a href="#"><u>Illinois</u></a>	<a href="#"><u>Indiana</u></a>	<a href="#"><u>Iowa</u></a>
<a href="#"><u>Kansas</u></a>	<a href="#"><u>Kentucky</u></a>	<a href="#"><u>Louisiana</u></a>	<a href="#"><u>Maine</u></a>	<a href="#"><u>Maryland</u></a>
<a href="#"><u>Massachusetts</u></a>	<a href="#"><u>Michigan</u></a>	<a href="#"><u>Minnesota</u></a>	<a href="#"><u>Mississippi</u></a>	<a href="#"><u>Missouri</u></a>
<a href="#"><u>Montana</u></a>	<a href="#"><u>Nebraska</u></a>	<a href="#"><u>Nevada</u></a>	<a href="#"><u>New Hampshire</u></a>	<a href="#"><u>New Jersey</u></a>
<a href="#"><u>New Mexico</u></a>	<a href="#"><u>New York</u></a>	<a href="#"><u>North Carolina</u></a>	<a href="#"><u>North Dakota</u></a>	<a href="#"><u>Ohio</u></a>
<a href="#"><u>Oklahoma</u></a>	<a href="#"><u>Oregon</u></a>	<a href="#"><u>Pennsylvania</u></a>	<a href="#"><u>Rhode Island</u></a>	<a href="#"><u>South Carolina</u></a>
<a href="#"><u>South Dakota</u></a>	<a href="#"><u>Tennessee</u></a>	<a href="#"><u>Texas</u></a>	<a href="#"><u>Utah</u></a>	<a href="#"><u>Vermont</u></a>
<a href="#"><u>Virgina</u></a>	<a href="#"><u>Washington</u></a>	<a href="#"><u>West Virginia</u></a>	<a href="#"><u>Wisconsin</u></a>	<a href="#"><u>Wyoming</u></a>

**Because we are so often asked about nuclear reactor sites we have taken the following picture from [Stan and Holly Deyo](#) showing U.S. Nuclear Reactor Sites in relation to earthquake zones.**

# Map B

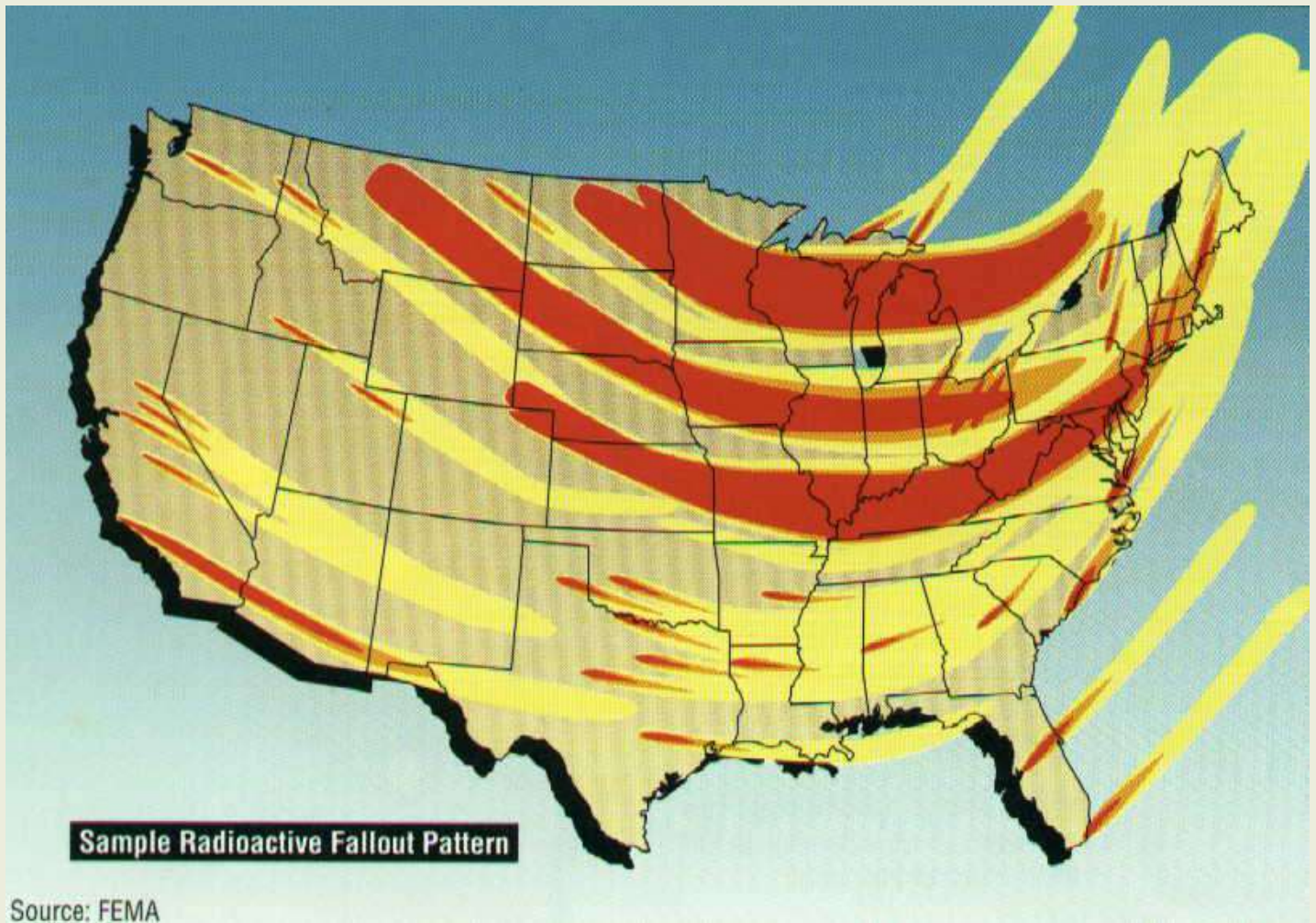
## Earthquake Zones with Nuclear Reactor Locations

Source: USGS & DOE



The following is the most commonly used prevailing wind predicted fallout pattern, but remember, fallout can go anywhere or everywhere (and probably will).

Continental US Fallout Pattern for Prevailing Winds (FEMA-196/September 1990)



**MENU: [HOME](#) » [Reconstruction](#) » [Recovery](#) » [Renewal](#) » [Survival](#)**

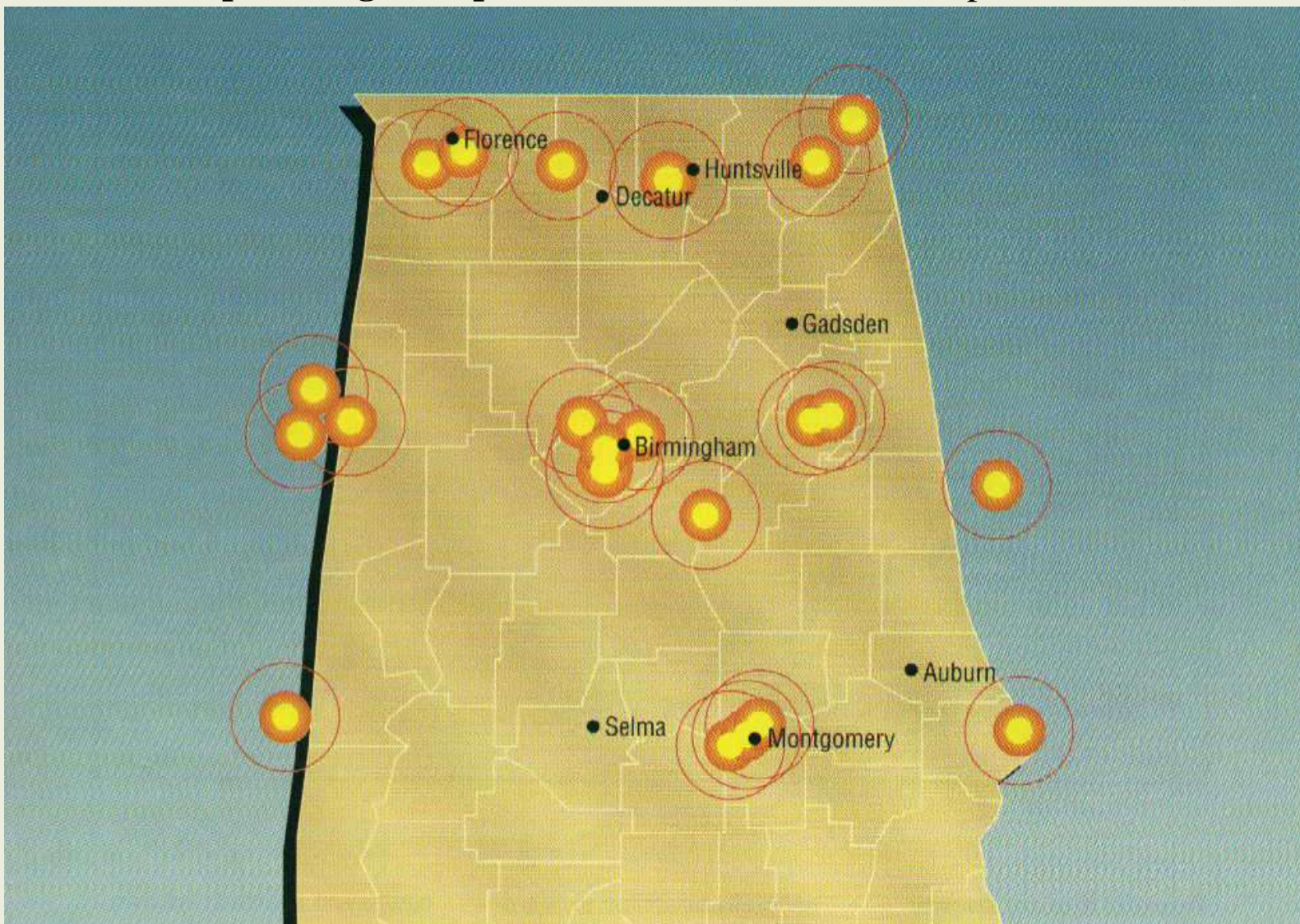


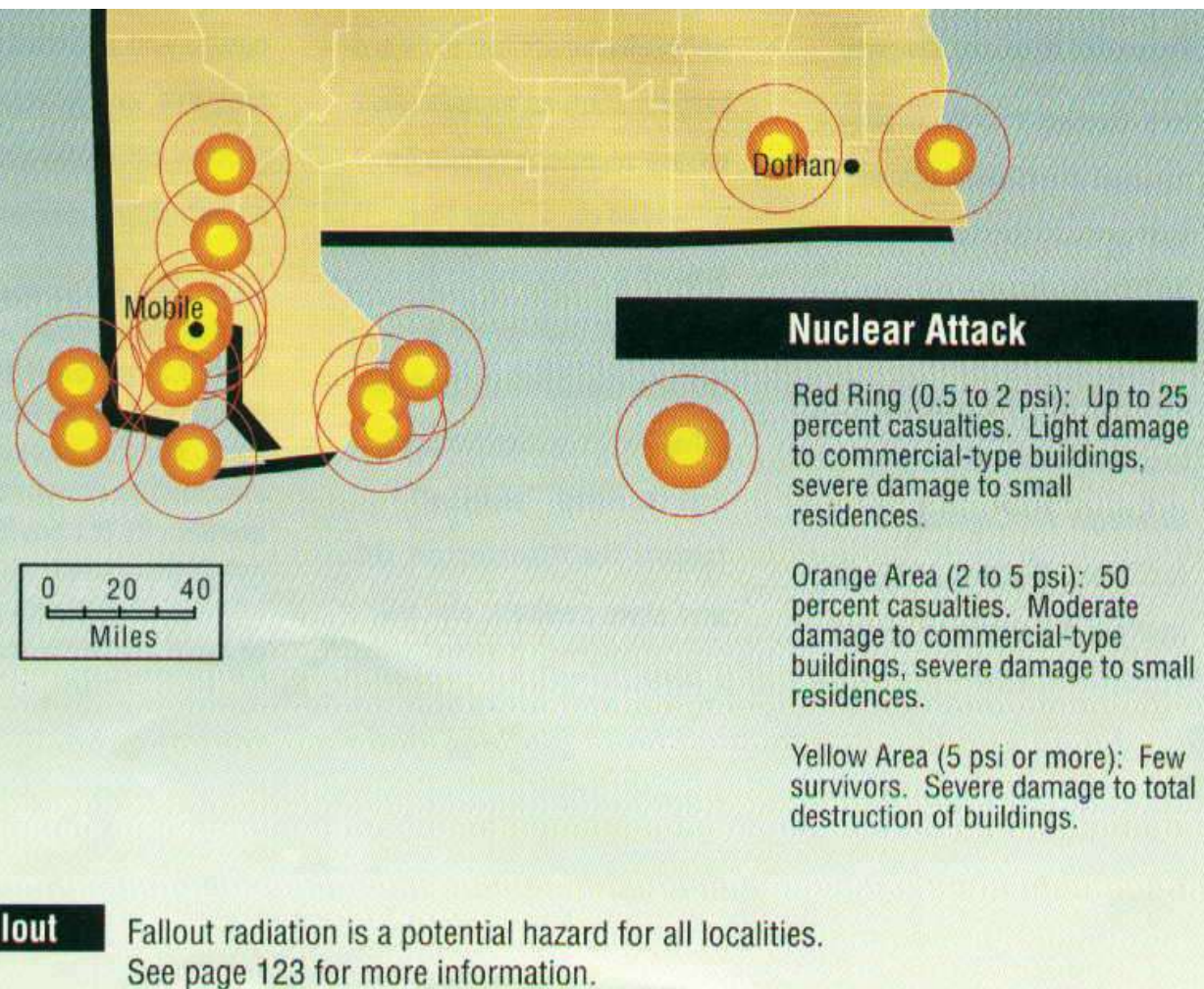
## Nuclear Survival in **Alabama**

This is the nuclear target map for Alabama, but remember, fallout can go anywhere or everywhere (and probably will). After you have looked at this map look at the [Information for Alabama](#) that follows it.

This link will take you back to the [Index of all the States](#)

### **Nuclear Weapon Target Map for Alabama (FEMA-196/September 1990)**





[UPDATE to Target Information!!!](#)

## Information for Alabama

This link will take you back to the [Index of all the States](#)

It is recommended that you go through the following 10 steps in studying about the nuclear threat to Alabama.

1. Look at the [State Map](#) above to see the target nuclear areas in Alabama.
2. Look at the [general expected fallout map](#) to see where Alabama (according to the **prevailing wind pattern**) gets fallout from other states.

3. If the state that you live in is anywhere EAST of any of the following 6 states in the **prevailing wind pattern** then look at the states in **RED** on the [INDEX of STATES](#) for

- **Montana**
- **North Dakota**
- **South Dakota**
- **Nebraska**
- **Missouri**
- **Colorado**

These six states contain what is called DENSE PACK which I explain on each of those states pages. **UNDERSTAND** that the wind pattern **COULD** at that time be something other than the "**prevailing**" wind pattern.

4. Bookmark the present URL or make a copy of this present address so that you can come back to it after going to

[Blast Mapper](#).

This mapper is on someone else's web site so that you will need to save this address in order to return here if your back button doesn't work. However, you want to be sure to go the mapper site and calculate the damage to probable targets (cities) around you.

5. Memorize the THREE top rules for survival. They are:

- Number One - **Get out of the cities!**
- Number Two - **Get out of the cities!**
- Number Three - **Get out of the cities!**

6. The follow-on rules are:

- a. Have a shelter

- b. Work with a group (you are going to need the manpower, brainpower, and skillpower).
- c. Stock supplies.

7. My [Main Survival Page](#) contains links to lots of other information such as free books to download about nuclear survival, links to plans for building shelters, and even free consultation about building a shelter.

8. If you are SUPER concerned about nuclear survival you might consider moving within 20 miles of the

[Ark Two Community](#)  
(in Canada)

9. And finally if you would like to be on the mailing list of the author of this site - send a blank email to:

[arktwo-request@deuce.pairowoodies.com](mailto:arktwo-request@deuce.pairowoodies.com)  
[with the subject as subscribe](#)

**MENU: [HOME](#) » [SURVIVAL](#) » [Index of States](#)**

---

---

Nuclear Survival in

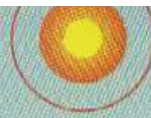
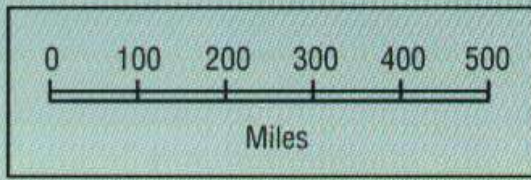
# Alaska

This is the nuclear target map for Alaska, but remember, fallout can go anywhere or everywhere (and probably will). After you have looked at this map look at the [Information for Alaska](#) that follows it.

This link will take you back to the [Index of all the States](#)

## Nuclear Weapon Target Map for Alaska (FEMA-196/September 1990)





percent casualties. Light damage to commercial-type buildings, severe damage to small residences.

Orange Area (2 to 5 psi): 50 percent casualties. Moderate damage to commercial-type buildings, severe damage to small residences.

Yellow Area (5 psi or more): Few survivors. Severe damage to total destruction of buildings.

### Fallout

Fallout radiation is a potential hazard for all localities. See page 123 for more information.

[UPDATE to Target Information!!!](#)

## Information for Alaska

This link will take you back to the [Index of all the States](#)

It is recommended that you go through the following 10 steps in studying about the nuclear threat to Alaska.

1. Look at the [State Map](#) above to see the target nuclear areas in Alaska.
2. Look at the [general expected fallout map](#) to see where Alaska (according to the **prevailing wind pattern**) gets fallout from other states.
3. If the state that you live in is anywhere EAST of any of the following 6 states in the **prevailing wind pattern** then look at the states in **RED** on the [INDEX of STATES](#) for

- **Montana**
- **North Dakota**
- **South Dakota**
- **Nebraska**
- **Missouri**

- **Colorado**

These six states contain what is called DENSE PACK which I explain on each of those states pages. **UNDERSTAND** that the wind pattern **COULD** at that time be something other than the "prevailing" wind pattern.

4. Bookmark the present URL or make a copy of this present address so that you can come back to it after going to

[Blast Mapper.](#)

This mapper is on someone else's web site so that you will need to save this address in order to return here if your back button doesn't work. However, you want to be sure to go the mapper site and calculate the damage to probable targets (cities) around you.

5. Memorize the THREE top rules for survival. They are:

- Number One - **Get out of the cities!**
- Number Two - **Get out of the cities!**
- Number Three - **Get out of the cities!**

6. The follow-on rules are:

- a. Have a shelter
- b. Work with a group (you are going to need the manpower, brainpower, and skillpower).
- c. Stock supplies.

7. My [Main Survival Page](#) contains links to lots of other information such as free books to download about nuclear survival, links to plans for building shelters, and even free consultation about building a shelter.

8. If you are SUPER concerned about nuclear survival you might consider moving within 20 miles of the

[Ark Two Community](#)

(in Canada)

9. And finally if you would like to be on the mailing list of the author of this site - send a blank email to:

[arktvo-request@deuce.pairowoodies.com](mailto:arktvo-request@deuce.pairowoodies.com)

[with the subject as subscribe](#)

**MENU:** [HOME](#) » [SURVIVAL](#) » [Index of States](#)

---

---



---

**Updated October 1st, 2002**  
**UPDATE to Target Information !!!**

**By Bruce Beach - Radiological Scientific Officer**

## **The FEMA Maps**

Target selection continuously changes, for a variety of reasons, most of which are either political or technological. The FEMA target maps are the only official ones that we have and some persons have criticized them because they feel that they are quite old and do not reflect recent military base closings, new facilities and so forth.

Even at their best - the FEMA maps only painted a conceptual picture of a perceived threat. No one could say, then or now, for sure what criteria foreign military target planners would use to select targets, how many missiles they'd commit, how powerful they'd be, how many would actually get through or how accurate they'd be.

One could be CERTAIN, both then and now, that nowhere near the number of targets shown on the maps would actually be struck. Many years ago there was a movie called - "On the Beach", which envisioned total annihilation of human life upon the earth. Nuclear scientists took up the term to measure the strength of the world's nuclear arsenals and concluded that there exists somewhere between 4 and 5 Beaches. That is to say - enough nuclear armaments to eliminate from fallout all human life on earth (four or five times over) if they were all exploded.

Anyone who simply looks at a FEMA map and says - "Ahhh - all those little yellow spots, that is where the bombs are going to fall," or "Ahhh - that yellow spot was a military base near me which no longer exists - so now I am safe", simply does not understand the problem. To begin with, as I explain in my booklet [YOU Will Survive Doomsday](#) a very small percentage of the population will have a bomb fall on them. It is other causes, resulting from the bombing, that will actually kill them. For one thing - fallout can go anywhere and it can be very deadly. As I repeatedly point out - death from fallout radiation is not a pleasant way to go, but death from that cause is avoidable.

The yellow dots on the FEMA maps were 'potential' targets. The criteria in originally selecting them included not only military sites, (which may or may not still exist) but also industrial, transportation, energy producing, and population centers which may have subsequently radically changed. Generally, for the latter, there are simply more.

You should use the FEMA maps only as a general guide to the targeting criteria foreign military planners

would likely use in selecting their targets. A few things have changed dramatically since the maps were drawn. For one thing, the Titan Missile Wings (sites) in western Missouri and eastern Kansas have been deactivated.

## **HOW MANY NUCLEAR WEAPONS WILL BE USED?**

The REAL question then - in evaluating the nuclear threat - is to determine FOR YOURSELF how many nuclear weapons YOU think will be used. The information that I am presenting here, is to help you in making that decision.

Here are some possible conclusions:

- All will be used.
- None will be used.
- Some will be used.

If one thinks that ALL the nuclear weapons will be used - then it is goodbye world. I will accept this as a distinct possibility, or at least the possibility that such a number will be used so as to have the same effect. If you believe *definitively* that is what will occur - then very simply you won't (and don't) have to worry about it. However, I believe (and it is only my personal belief) that because of Divine Intervention, through what will appear to be natural causes, that the event will be extensive - but limited.

On the other hand - there are those who think that because of man's rationality, or God's kindness, that none will be used and we don't have to worry about it. Many of these people feel that I am insane for my concerns. I can only say that I hope they are right.

It is only the third case that I present here. I feel that nuclear WWII is inevitable. Others may feel that it is only probable - or somewhat probable or possible. The degree of your concern will determine the value that you will put on the information that I am about to present, and the action that you will take based upon it.

First - my own conclusions. I feel that a sufficient number of weapons will strike North America to destroy 80% of its population. What that number of weapons will be is what I am trying to estimate. The information presented here is what I base my estimates on.

Presently, in the world, there may be fifty-thousand (50,000) nuclear warheads. Many of these are tactical (for use by field artillery) rather than strategic (for use on ICBMs - Intercontinental Ballistic Missiles). Two years ago, under Clinton, the US had recalled its tactical weapons from the field, and they were no longer under the control of field commanders. HOWEVER, as of this date, under Bush, they have now been again deployed to the field and Bush has cancelled many of the disarmament treaties and has definitively repudiated Clinton's policy of "No FIRST Use" saying that the US may use nuclear weapons -

even pre-emptively.

Of the strategic nuclear warheads, many (most) are now obsolete. They certainly are not mounted on warheads and ready for launch. It is really only the latter than we need to concern ourselves about, and if we wish to take a narrow view of self interest, it is only the potential enemy's that we need to concern ourselves about.

The US owns by far the largest current tested arsenal of nuclear weapons. Russia the second largest, and France may still have the third largest. Israel is thought to have about 400 (up from an estimate of 200 about a year ago). The major change, and it is a big one, is that they have put three nuclear ballistically armed submarines in service. China too, in the last year, has made considerable advance in its nuclear arsenal, particularly as applies to ICBMs of which it now has a number capable of reaching the US.

There are over 20 other countries in the world who are thought to have perhaps joined the nuclear club - but not all, like India and Pakistan, have tested their weapons. These latter, in the last year have made threats to each other - something inconceivable that a nuclear power would openly do even three years ago.

Weapons alone are not enough. One must also have delivery systems. While there is talk of suitcase weapons for terrorist purposes, the delivery system of choice is still the ICBM (Intercontinental Ballistic Missile) or the SLBM (Submarine Launched Ballistic Missile). Complete delivery capability has been defined as the TRIAD. Land, Air and Sea. Of late, one leg of the TRIAD has fallen into disfavor. Russia still has Bisons, and the US both B-52s and B2s, but they are beginning to be recognized as a technology that is becoming rapidly obsolete for nuclear delivery. Improved radar, satellite detection systems, and the much improved accuracy of interception missiles has much decreased their usefulness. They have also become relatively less cost effective. Consequently, the US under the Bush administration has announced that bombers - even the B2 - will no longer be nuclear armed. In the future this will mean that their bases, and bases that would have been used for refueling will no longer have as much priority as a target. This US policy and strategic change is just taking place and will require time to be reflected in the thinking of Soviet target planners.

Theatre nuclear weapons still include aircraft and ship mounted nuclear weapons such as the Cruise Missile, but our major concern here is the ICBM and the SLBM (Submarine Launched Ballistic Missile). So far, we are not aware of, nor are there supposed to be, (but I wouldn't bet on it) any space launched ballistic missiles. In fact, there are only three countries known to have operational SLBMs. The US, Russia, and Israel. Under normal circumstances it is possible to have only about one third of one's fleet on station at a time. For the US and Russia this means a half dozen each, and for Israel one or two because the latter has a total of three subs. If this gives you any particularly comfort it should be pointed out that each of the subs (particularly the US and Russian) carries more destructive power than was used by ALL the world's armies in the Second World War. There may be other terrible weapons (such as HAARP - don't ask) that we know nothing about. Who among us knew about the Atomic Bomb - until it was used.

Until the present US Administration there had been extensive discussion over the last decades about

reducing the world's nuclear armaments. In actuality they had become much more dispersed, efficient, reliable, and capable of being delivered with much greater accuracy. A reduction in their total number is not reflected in a reduction of their destructiveness or effectiveness. Actually, quite the opposite - more destructive power is being developed and deployed in manners that are more efficient. This is true, not only of the US, but also of a number of other countries. Pakistan, India, North Korea, and many others now have capabilities that would have made THEM a premier world power - a half century ago.

The United States currently has 7,295 deployed warheads compared to Russia's 6,094, and while the Bush administration is discussing making cuts down to 1,500 nuclear warheads in the US arsenal, these cuts are not to take place for years. In any case, as I have stated earlier, the ones that we need to be concerned about in making North American target estimates, is the ones held by the potential enemies.

China is thought to have fewer than 300 nuclear warheads capable of reaching the US. Some estimates put the number at even one-tenth of that. Whatever the present number, it is certain that they are in an all out effort to increase the number of their DF-31 and DF-41 rockets that will have that capability. Likewise, Russia, for the last three or four years, has been on a crash program to field as many as possible of their Topol-M, quite arguably the most advanced ICBM in the world. As a result of cancellation of the SALT agreements by Bush, Russia has said they will MIRV (Multiple Independent Re-entry Vehicles) their ICBMs. This is the same as multiplying by some factor the number being deployed. Americans may go on about other countries being backward and stealing their technology but they should remember that the Russians put the first satellite, the first man, and the first space station into space. Likewise the Chinese deployed a satellite and tested a nuclear weapon - decades ago.

But, let us only concern ourselves with what exists at the moment. Conservatively let us say that Russia and China combined currently have 7,500 nuclear warheads supposedly capable of reaching the US. So that we do not just scare ourselves to death, let us suppose that with their deteriorating economies that the maintenance on these have made about half of them operational. Let us say 4,000. And let us say that only half of these would be aimed at North America, the rest being aimed at Europe and other places in the world. This means that only 2,000 would be aimed at North America and let us further assume that US defenses are such that we will stop half of them (although I am not certain how one currently stops an ICBM or particularly a SLBM). But anyway, that leaves us with 1,000 nuclear weapons exploding over North America.

Now, please forgive me, but since I live in Canada, I am going to look at what share we might expect to fall where I live. Canada has ten percent the population that does the US, so I am going to say that Canada is going to get 10 percent of the North American warheads - or one hundred. In Canada we have a rule of thumb that the province in which I live has about 50% of the Canadian population, GNP, industry, and so forth, so I am going to say that we can expect about 50 nuclear weapons in Ontario.

What I am suggesting is that you make the same sort of extrapolation for your state, but I can tell you that when I start adding up the targets around Ontario, I find it hard to find a place to put 50 weapons. But here is an attempt.

- 1 at Niagara Falls - A big power generating source.
- 4 other power generating stations (mostly nuclear)
- 1 on Ottawa (the Capital of Canada)
- 1 at Sault Ste Marie (across the river from a US nuclear forces base)
- 4 other Canadian Military bases (about as threatening as boy scout camps)
- 5 on Toronto and what we call the Golden Horseshoe
- 1 on North Bay (if they don't know it has been deactivated as a NORAD site)
- 17 total

AND I feel that is really stretching it, but I wouldn't really know where to put anymore, without say bombing out some beaver dams or attacking my bus shelter. :) But, anyway, I expect the number is ridiculous, and I really wonder if the province could survive at all if 10% of the 50 weapons - that would be its North American share were used. That would be 5 nuclear weapons, each one more than a hundred times the size of the weapon used on Hiroshima or Nagasaki. Think about it. It is called the unthinkable for a reason. Now, do a similar extrapolation for your state.

On the same ratio of 10% of available weapons, as calculated above, and the 1% or 2% of total weapons existing world wide we would be talking about 100 weapons in North America and 200 world-wide. This would be like the energy release of two thousand SIMULTANEOUS Hiroshimas, along with the accompanying fallout. Lord, (I am not being facetious in addressing the Almighty) how could we possibly survive it? I can only pray that You have a plan.

So, when you look at all those yellow dots on the FEMA map - I think that you can forget that, and start trying to figure it out another way. Here is where I would put something less than 100 weapons in North America, and Lord, I hope it is a LOT less.

## TARGET SELECTION

Targets are selected on a:

- Primary
- Secondary
- Tertiary

basis. That is to say - those which have first, second and third priority.

## Primary Targets

- a. Three submarine launched high altitude bursts evenly spaced over continental US to create EMP (Electromagnetic Pulse) to knock out communications. The reason they would be submarine launched is because submarines can launch from off both coasts, are the least detectable and can get in the closest - for the least warning.

- b. Satellite to satellite strikes for weaponry, communication, control and surveillance technology that the general public does not know about. Who can guess about something we know nothing about - just as we knew nothing about the atomic bomb before Hiroshima.
- c. Submarine ports on both US coasts and at US controlled ports elsewhere in the world to prevent any submarines that are in port from getting underway. Normally only one third of the fleet is on station at a time. Number of subs that would be eliminated in this way depends on whether the attack comes as a "bolt out of the blue" or that navy is on some "high DEFCON status". The subs are considered the most threatening part of the "Triad".
- d. In the past, NORAD (North American Air Defense) communications centers at Colorado Springs, Colorado and North Bay, Ontario have included been included as Primary Targets. The latter has supposedly been deactivated, but what other 'secret' locations exist and how well the Russians and Chinese know those 'secrets' is problematical.
- e. SAC (Strategic Air Command) bases have been considered a priority for a strike out of the blue. Omaha Nebraska is of course the headquarters. Still, everyone knows that, so other arrangements have been made - such as 'Alice' and 'Looking Glass', which are airborne command centers - and as mentioned previously there is talk about new space and sub-sea elements. Air Bases are a good target for SLBM's (Submarine Launched Ballistic Missiles) especially forward bases in allied countries such as Turkey, Saudi Arabia, Britain, and France (which has its own nuclear force), and Navy Aircraft Carriers wherever they may be (and they would certainly wish they could find the submarines).
- f. Surprisingly, Washington D.C. and the Pentagon have often not made primary target lists. Washington D.C.. because there is one targeting theory that an enemy wishes the leaders to survive so that they have someone to negotiate surrender. The Pentagon, because while we hear of the famous war room and so forth, in actuality the Pentagon then becomes insignificant because we would be beyond the time of planning, policy, and procurement.

## Secondary Targets

By this point there would have been used one or two dozen weapons against American Forces.

- g. Beyond first strike, to catch the bombers while on the ground, - air bases and nuclear bombers are no longer considered as prominent a part of the Triad targets as they once were. Previously, it was thought important to get all the ten thousand foot runways in the US to prevent the bombers from returning to refuel and rearm. Not seen as so likely today.
- Major metropolitan areas will of course remain major targets, but these are SECONDARY target issues because they will have little effect upon US retaliatory capability, which are the concern of PRIMARY target issues. Major cities remain major targets simply for the

confusion, affect on morale, and political, social, and economic disruption they will cause the US. Most everyone can identify what the top 20 US city targets will be in this regards. One must remember that there will be similar world targets of US allies, so that recovery assistance will not be available to the US. One must, however, begin to ask - exactly what the geo-political, and overall goals are that target planners wish to achieve. Targets such as these may be used as hostages for negotiation - assuming that the planners have as a part of their model, the ending of the war and achieving some particular goals.

- It used to be thought that US Military training bases, war materials production plants, and such, would be important targets. But that is WWII thinking - not WWIII thinking. Everything, used in the war will already have been made, deployed and trained upon. There will be no time for further preparation or deployment. The only thought will be how to get it stopped.

## Tertiary Targets

Tertiary targets no longer have the prominence they once had in target planning, such as they did at the end of WWII when the bomber reigned. Then a bomber, assigned to a primary target, might carry multiple weapons and if it or a companion plane destroyed the primary target then it needed to go on to a secondary target so as not to waste the weapon in re-bombing the same target. This is particularly true of nuclear weapons - where one is sufficient.

A plane would then carry a priority list of additional targets within its range or return path, so that it could dispose of its weapons. With the little likelihood of getting a second chance, it is a matter of use them or lose them.

Between the Primary target sites and the Secondary target sites we have possibly used 50 weapons in North America. So what is left over? The question is - how completely do you want to devastate the land? There has already been enough damage done that the political and social organization has been destroyed. In North America aid flows in to limited disasters, a fire, tornado, earthquake. But now, everywhere would be in disaster. No electrical power, communication, or help available - from anywhere. The following map shows some principle North-South corridors, because I feel that the country would be severed East-West because of river crossings.



It is questionable that society could be restored but just to assure that the devastation is complete and that the country is severed a target planner might select as tertiary targets to destroy the bridges over the Mississippi and Missouri and the key railway passes through the mountains. Key nodes on the electrical, communications, and pipeline grids - and so forth. The following map is comprised of railway and highway nodes linking through Kansas City. You can do the same thing for any other major city.





You can take all those maps - and seek to designate targets. I have done it and I can tell you it is hard to find places to put another fifty bombs.

There are many academic studies that have been made on this subject, by VERY knowledgeable and capable people. If you wish to really study into it more then here is a link that has been highly recommended by both The Bulletin of Atomic Scientists and the Encyclopedia Britannica, both of which are very worthy sources:

<http://www.nukefix.org/>

I have said 100 weapons to devastate America. The nuclear subs alone carry hundreds between them. Launch and move on and wait. That would be the strategy. From satellite and other reports you would eventually be assigned another Tertiary target that hasn't been struck. The process could go on for months with nuclear powered subs. However, I hope that it won't last a week - before we find a way to end it.

## **How Likely Are the Weapons To Be Used?**

By what insanity could mankind possibly pull down upon itself the destruction that I have described above and in [YOU Will Survive Domsday](#)? My answer is by the same insanity that permits him to build such Abominations of Desolation in the first place. By the same insanity that expresses his selfishness and anger throughout the world almost daily in the killing of what amounts to at least tens of thousands of human beings annually. Men who are intellectual giants and spiritual midgets. Men who have turned from the will of God who loves all His creatures and wants them to all love one another.

One may say, "Yes, but we have gotten this far without using them - so why would it ever change?" But, the change is in the wind. The US says that it is abandoning the policy of MAD (Mutual Assured Destruction). In the past this was the rationale for not having an effective Civil Defense Program and a national civilian shelter program. It was thought that everyone on both sides would be destroyed anyway,

and to implement a shelter program would mean that one did not really believe in MAD - and therefore their shelter preparations would be seen as threatening by the enemy. So, one just wanted to be sure that they had total SECOND STRIKE CAPABILITY accompanied with ASSURED ANNIHILATION of the enemy and no enemy would ever attack them. Thus - the US under the Clinton and previous administrations maintained a "No first strike policy". The Russian's under their previous administrations did likewise, but just recently the Russians have said that they have changed their policy - in favor of first use.

Russia, China and some other countries never agreed that a nuclear war was not survivable and they continuously developed shelter programs. Under the US Reagan Administration it was felt that a defense - popularly called Star Wars - could be built against nuclear weapons. Most thinkers agree that it is an impossible idea, but the very attempt to try it was outlawed under the ABM (Anti Ballistic Missile) treaty. The reason the Russians (who were permitted under the treaty to maintain a few ABMs around Moscow - but which the US felt would be ineffectual) wanted such a treaty, was that they felt the very attempt to develop ABMs would create an arms race they couldn't afford. If any one nation DID come up with a defense - then other nations could be forced to surrender under nuclear blackmail. The US under Bush cancelled the treaty and has gone ahead with ABM development. Continuously, we now hear of some general in Russia or China who says they think that nuclear war is now inevitable.

And then there are all the Third World Countries with their axes to grind. Pakistan, Iran, Iraq, North Korea, Syria, Libya, and others. Yes, their conflicts can bring in the major players. Just the US preoccupation anywhere else can be incentive to China to solve its Taiwan problem. For some countries, such as Israel, nuclear may come to be seen as the only solution. Israel, greatly outnumbered, more than a hundred to one, could easily feel forced to nuke the capitals of its attacking enemies, and in the last few months it has indicated that it would take such "appropriate response" as needed.

For much of the last year, since 9-11-01, there has been expressed increasing concern about the existence of "dirty bombs", suitcase nuclear weapons, nuclear weapons concealed in sea shipping containers, and the delivery of bio/chem weapons, especially dealing with anthrax and smallpox, into North America by various terrorist organizations and the latest "empire of evil" of choice, which happens at this writing to be Iraq.

While the threat of Iraq (and Iran, Syria and Libya) are very great to Israel - these countries have no practical means of large scale attack on the US and for technical reasons widespread attack on the US by bio/chem is improbable. However, the use of WMD (Weapons of Mass Destruction) by ANY power, anywhere in the world, will undoubtedly have a very destabilizing effect. Thus it is that even limited powers can trigger an event that can bring about a world-wide conflagration.

Given the nature of modern weapons and the natural barrier of two great oceans, I do not expect there to be an invasion of any sort into North America. The perils of civil disorder, and responding military rule, rest within. Nevertheless, the threat of world cataclysm has never seemed greater.

No matter how irrational my analysis may seem to many - one fact remains. There are nuclear weapons in

the world. Plenty of them.

**MENU:** [HOME](#) » [SURVIVAL](#) » [Index of States](#)

**This booklet was converted to HTML by our Ark Two Librarian, Fred Walter; a lengthy task which, I for one, wish to express my appreciation.**

It contains so many photos that it is probably easiest for you to read it on-line, and some browsers will now print it off but you can capture it and print it off, along with a number of very useful other books from our Ark Two Librarian's easy printing .pdf versions at:

[http://groups.yahoo.com/group/Self\\_Sufficiency/files](http://groups.yahoo.com/group/Self_Sufficiency/files)

# You Will Survive Doomsday

*By Bruce Beach*

## Copyright Information

This document is copyrighted. You are welcome to reproduce it, however, for FREE distribution in whatever quantity you desire and by whatever means you desire so long as you reproduce the entire document. Extensive quotes are also welcomed so long as credit is properly given.

Our purpose in publishing this document is to ameliorate the effects of a nuclear holocaust for as many people as we can reach, and to locate as many people as we can who are willing and able to join our nuclear survival group.

## Table of Contents

- [Twenty-three myths that are repeatedly heard](#)
- [Useful Figures and Tables](#)
- [Nuclear Survival Groups](#)
- [About the Author](#)
- [Bibliography](#)

## MYTHS

Here are twenty-three myths that are repeatedly heard (some much more often than others) that this document tries to dispel.

- [MYTH #01](#): Almost everyone will suddenly be killed on doomsday.
- [MYTH #02](#): Most people would be quickly killed by the bomb blasts, thermal radiation, or radioactivity.
- [MYTH #03](#): You can build an adequate shelter in your basement.
- [MYTH #04](#): You must filter the air coming into a shelter to remove the fallout.
- [MYTH #05](#): Water would become radioactive.
- [MYTH #06](#): There would be no dangerous radioactivity after a couple of weeks.
- [MYTH #07](#): Radiation sickness is not contagious so there is no danger in assisting those affected.
- [MYTH #08](#): Food exposed to radiation becomes radioactive and is therefore not edible.
- [MYTH #09](#): If you have a special *radiation suit* (like you see in the movies and on TV) you will be protected from the radiation.

## You Will Survive Doomsday

- [MYTH #10](#): New crops of food grown in future years will not be radioactive.
- [MYTH #11](#): There is no such thing as a fallout pill.
- [MYTH #12](#): There is a fallout pill that will protect you from all radioactivity.
- [MYTH #13](#): There would be dangerous radioactivity for thousands of years.
- [MYTH #14](#): There would be no dangerous radioactivity after a couple of years.
- [MYTH #15](#): You are prepared if you have a two weeks emergency supply of food stored.
- [MYTH #16](#): You should be prepared to be self-sufficient and be able to survive on your own.
- [MYTH #17](#): Any survivors would have to live the rest of their lives underground.
- [MYTH #18](#): Life after doomsday won't be worth living.
- [MYTH #19](#): You need not make any preparation because you are either going to die in the holocaust or be *saved* (religious connotation).
- [MYTH #20](#): The bombs today are so large and there are so many they will destroy the world.
- [MYTH #21](#): You will receive adequate warning from your government.
- [MYTH #22](#): You will receive no warning, and there is no hope if you do.
- [MYTH #23](#): One of the primary targets will be nuclear power plants.

This document is published by a nuclear survival group. The group is not affiliated with any religious group or other organization. We welcome inquiries from all persons interested in joining our survival group. Send email to [survival@webpal.org](mailto:survival@webpal.org) (*Bruce Beach*) for more details.

## DOOMSDAY

### MYTH #01: Almost everyone will suddenly be killed on doomsday.

**You will survive doomsday.** And here you thought that if it ever happened the bomb would fall right on you. Probably not. It will more likely go like this.

One day, the inferior Russian computers may make a mistake and decide that the US has already launched a pre-emptory attack against Russia. The US warning system has made that same sort of mistake many times and a number of times we have gotten just minutes away from launching our retaliation before the mistake was discovered. Who is to say the Russians will always be so smart?

Forty minutes after a missile is launched from Russia it will be landing on its target in North America. Before this occurs the US has just minutes within which to respond or it will be caught with its missiles down. The hotline to Russia happens to be not working (this has also happened a number of times before). That is one of the factors that entered into the Russians decision to launch.

So, what's his name in the White House reaches for a jellybean and pushes the button. Interception missiles of course try to stop the Russian missiles before they reach their first two primary targets, NORAD (NORthern Air Defense) headquarters in Colorado Springs, Colorado and its backup at North Bay, Ontario.

These are hardened underground computer and communication sites that may require several bombs to wipe them out. Given the number of missiles that may be intercepted the Russians have sent a handful.

A better way to wipe out the communications of North America is to just explode four thermonuclear devices at a high altitude over the continent. These will generate an EMP (Electro Magnetic Pulse) that will knock out most electric and electronic devices tied into the power grids. It will also knock out any new devices that contain IC's (integrated circuits) and that have an antenna over thirty inches long. That means that your car radio, portable radio, and television will be inoperable, even if the power ever does come back on.

All over the continent the power and lights will suddenly go off. If you happen to be listening to a battery operated old tube type radio (when did you last see one of those?) that is tuned into a "hardened" transmitter sight (I don't know where you will find one) that transmits (fat chance) the EBS (Emergency Broadcast Signal) then you will know that doomsday has begun.

Otherwise you will be standing out there with the rest of us survivors saying, "Nice day, eh? Strange the power would go off on a nice day like this." Silence. The sun will continue to shine, and the birds will sing, and the breezes will blow and you will still not know that they have a bit of a problem up in North Bay. They are no longer there. Silence.

Eventually word may drift in. On the chance that there is something to the rumor you decide to try to call someone. Your spouse, a friend, a relative. Don't bother. Silence. The telephone isn't working either. Even if the EMP hadn't done it in, a mere power outage causes such an overload of demand on the central exchange that you couldn't even get a dial tone.

**You are a survivor.** Doomsday has occurred and you are a survivor. While you are waiting for the spouse and kids to get home maybe you should do something practical. Like go down to the supermarket and lay in a bit of an extra stock.

You may notice that the little corner store has closed. If he has believed the rumor, he wants to save his stock. And besides, your money may not be worth anything tomorrow. You thought you had seen rapid inflation before but this is like from zero to a million in sixty seconds.

At the supermarket, if you are early enough, you will find pandemonium. If not, you will find practically nothing. Maybe a large bag of dog food (take it) and some cans of floor wax (forget it). The rest of the stuff was all in those carts that you met come flying up the walk as you came running down.

There won't be any girls at the cash registers, (they have done their shopping and gone). Besides, the cash registers aren't working anyhow, with no power. It may have taken the hired manager a little longer to figure out that he should grab what he can and head home to his family, but he has probably gone now. The only cops you will see are the one's grabbing stuff themselves.

If on the way back you spot a shopping basket with something in it - think twice before helping yourself. If there is an altercation there are probably no doctors at the hospital to sew up the lacerations. Everyone else is also too busy to bother calling an ambulance, if they could, and one wouldn't be available if they did.

Of course the trip to the supermarket may have been nothing like that at all. It may have just been a bit more active than usual but if most people haven't caught on yet then we are very lucky. You just keep mumbling under your breath. "Good people, good people - that's the way, that's the way, just stay calm." This way we can just go about doing what we have to do as quickly as we can, while trying to not stir up panic. "Yes. I understand the cash registers aren't working but please let me just help you add this up by hand. No, that's fine, just keep the change."

Then, of course, if everything is really this calm we can take that good old plastic credit card and go out and buy all the good survival stuff that we are going to need and should have gotten beforehand. Don't worry about paying for it, no one is ever going to send you a bill. Getting the stuff home may be a bit of a problem if the car isn't working (the EMP may have wiped out that fancy electronic ignition). "No, that's fine. You don't need to deliver it. I'll just put it here in my little red wagon." But you sure don't want to lug it all the way up to your thirty-second floor apartment, if there is somewhere safe that you can stash it. "Can you really believe that people are staying this calm? How is it that we seem to be so much smarter than the rest?"

More than likely you are now back home and all you have is the fifty-pound bag of dog food. Are you really going to be able to carry it up to your thirty-second floor apartment? You know the elevators aren't working of course. Then maybe you could hide it in the trunk of your car in the garage- if no one sees you.

Ah, back home in the apartment. Home sweet home. The kids are home from school now. Do you have enough guts after that scene at the supermarket to send them out to do some more scavenging? It isn't exactly a party going on out there. Did you see Watts, Detroit, Washington D.C., and Baltimore after some of their similar parties? I did. I think I would keep the kids home. Not much you can do except to wait for the spouse to walk home. Shouldn't be more than a few hours.

The spouse finally makes it home. "What do you mean all you got is fifty pounds of dog food? We don't even have a dog." The electricity isn't on. We can't cook anything anyway. Best to eat everything out of the refrigerator before it spoils. Won't be anymore water as soon as the gravity feed tanks on the roof empty. Hope you saved a few pot's full. If everyone filled up their bathtubs - it is all gone. It has gotten cold. Might as well go to bed. There is no light to see anything by anyway. Certainly not going out in those streets in this dark with all that noise going on down there. Hopefully, everything will look brighter in the morning.

## Day Two

Morning comes early with the noise of people throwing pots and pans over the sides of their balconies along with the blankets, pillows and other things that it saves them carrying down. Apparently some of the residents are moving out. Perhaps you should too.

Everything looks better in the light, doesn't it? TV still doesn't come on. Telephone isn't working either. And you know what - the toilet doesn't flush. Can't cook anything. Got to eat what you've got. See, that wasn't so bad. Make it sort of a picnic. Eat it right out of the can. There is not going to be any water to wash dishes.

But see, **we survived doomsday**. Didn't even see an explosion, hear a bomb, or anything. Maybe we should sit down together and try to figure out what we are going to do from here. The bombs may still be coming. Probably are.

If the attacker's plans have gone according to schedule they have probably finished with their primary targets. They have hit the three Titan Wings in Kansas, Missouri and Arkansas (three wings, eighteen missiles each, for a total of fifty-four) or the things have landed in Russia by now, so why bother. They have certainly been knocking the bejammers out of Montana and the Dakotas. Can't hear or see a thing from here of course. [Author's update note: This point is a little dated. The Titan Wings have been decommissioned and both the U.S. and Russia have now put much greater reliance upon the MUCH greater and more reliable destructive power of MIRVed warheads aboard nuclear submarines. The primary targets are now most likely submarine bases, to prevent more subs from leaving port. Further update as of January 1st, 2002. The world keeps changing. Now not only Russia has missiles that can reach the US but China does also. There are now 14 nuclear nations and the number is growing).

Then they will start on the secondary targets. All the SAC (Strategic Air Command) bases both in the US and around the rest of the world. Oh, they have lots to keep them busy for a while. Cities themselves are pretty far down the list. Maybe they won't even go for them. Any airport with over a ten thousand foot runway is pretty important however because the SAC could land and refuel their bomber there. So you know where that puts us. They will probably get around to us in the next day or two.

There are two strategies of warfare. One is called *counterforce* and the other is called *countervalue*. With counterforce you knockout the enemy's forces so he can't harm you. This can be very chivalrous like the fighting codes of the knights of old. You never harm the women and children.

On the other hand, with countervalue, you go after everything the enemy holds dear in order to demoralize him. This was the technique of the Mongolian hordes.

"Take no prisoners." "Eliminate the enemy." "The only good Indian is a dead Indian." "Eliminate the Jews." "Sock it to the Japs."

Women, children, babies, everybody goes.

Now the problem with countervalue warfare is if everybody knows they are either going to win or die, some people can get very tough. So maybe the best thing is to knockout the military forces and hold the cities as hostage. "Now, either surrender or we bomb the cities." Anyway, the cities aren't generally the first targets.

And so here we sit. **Unscratched**, the day after doomsday. But we can see some problems on the horizon. Very possibly the city is going to be bombed in the next day or two. Even if it isn't, how can we stay here? The electricity is off. The heat is off. The water is off. And it isn't coming back on. The elevators aren't working. For older people it is "If we go down (if they can go down), we can't come back up."

There is no more food in the grocery store. And there won't be any more. (Unless you believe your government, which says they will start delivering it in about two weeks - want to bet?). Then there is that horrible stuff called fallout that is going to start showing up in about twenty-four to forty-eight hours, or sooner.

Now, we have all seen or heard about the book and the movie "On The Beach", and Beach himself shows up with the *solution*. A pocket full of cyanide pills. If you want one he will give you one for each of your kids or grandkids. There is only one catch. There are only so many and I don't want them wasted. So you will have to line up each of your children or grandchildren in a row and pop it down their throats right while I am here. How many of you will do it? "Here is your vitamin. Open wide..."

No? Then you really are a survivor. Here you always said you hoped the bomb would fall right on you and then when I offered you an easy out... Oh well, it won't be that bad. A world without electricity, automobiles, radio, television, telephones, and supermarkets. And maybe eventually with only twenty million people in North America. (They won't all be Canadians).

But then, that is the kind of world that was here in 1800. The people then didn't have cars, supermarkets, movies, TV, radio, telephones, modern medicine, airplanes, rockets, and computers. And they survived. They may have even enjoyed life. Maybe even more than many people do today with all their drugs, tranquilizers, and what have you.

People generally are survivors. Put them out on an ice floe in the middle of the arctic with no expectation of rescue, no supplies - nothing - and they will hold on. Some will even survive until they happen to be rescued.

So you are a survivor and you survived doomsday. But you will eventually die. We will all eventually die. That is the nature of this world. The question is not whether or not you will possibly die, but how long you will live, and what life will be like during that time.

So you have survived. And if you and your kids are going to continue to survive you had better get the heck out of the city. Not only is there the possibility that there will be bombs but those little scenes down at the supermarket, or anywhere else a little bit of food happens to show up, are going to become more and more unpleasant as anarchy prevails.

Moreover, without the toilets flushing and with no one removing the dead bodies, health conditions are really going to reach a state you just wouldn't want me to describe. So, off to the country. But, how? And, where?

Before actually departing for the country let us further consider the alternative of staying in the city. Perhaps you are convinced that the Russians would never really get around to bombing your city. Or you feel you have sufficient underground shelter if they do. Nothing, of course, would protect you if there were a direct hit on your shelter, but a good bomb shelter could certainly give you very good protection as little as five miles from ground zero.

The trouble is that subways and underground garages are not designed as blast shelters. They do not have blast vents and doors. Anyone in such a place, at the time of blast, within a couple of miles of ground zero will be subjected to a phenomenon called *popcorning*. Minute particles of greatly accelerated sand will cause blisters to pop out all over exposed parts of the body. This, combined with several other pathological mechanisms, will probably result in a rather painful death within a few days.

Although the blast protection in an underground shelter is much superior to being above ground there are reasons that one is better off staying in their high-rise apartment rather than going to a large public shelter if they feel there is little or no danger of blast.

The public shelters have no supplies and no equipment. The average designated public shelter is supposed to shelter over three thousand people. Can you imagine the anarchy and conditions there? Without food, the first to die will be infants who are not being breast fed. Other early candidates will be persons who require special medications (especially the elderly) and anyone who happens to be injured.

Not only will deaths have negative psychological effects on the survivors, they will create severe sanitation problems. There will be enough sanitation problems anyway if the water and sewage systems are not working. Most of the designated shelter locations do not have sanitary provision for three thousand people in the first place.

One of the greatest hazards in an underground shelter is carbon dioxide poisoning. The designated public shelters, almost without exception, do not have adequate ventilation for large numbers of people over a considerable period of time. And the existing ventilation systems generally depend upon electricity being available.

There are ventilation defense and survival techniques available. However, if you were to try to implement them in a large public shelter situation you would probably be one of the first persons killed by the other survivors. The reason is that most people have misconceptions about either the air becoming radioactive, or containing radioactive particles that they feel would be more dangerous than the carbon dioxide.

Add to these problems the fact that you might not have any light in the shelter, that anarchy may become rampant, and that there will almost certainly be no food, and perhaps, more importantly, no water and you will see why no trained survivalist would want to be caught dead in the place.

Returning to one's own high rise apartment, after the danger of blast is past, gives much more favorable opportunities for continued survival than given by remaining in a public shelter. If you are ten or fifteen stories above the ground the distance will probably adequately protect you from any radiation from the fallout on the ground. If there are ten or more stories above your head then that distance will also protect you from fallout on the roof.

The apartment dweller should try to secure an inner room without any windows. A blast fifteen or more miles away will knock out the windows and it is the glass shards that will kill most people. Pulling drapes and blinds are all helpful defenses. A blast wave will be preceded by a brilliant flash of light. The survivor will have from several seconds to three or four minutes, depending upon the distance from the blast, to duck behind a sofa or to take other shelter.

Training oneself to take similar immediate defensive action can also help give protection from the intense thermal radiation that accompanies a nuclear blast, and that can start fires *fifteen to twenty* miles from ground zero. Fires, in themselves, can be a problem and if you are downwind from a large fire or firestorm you have to watch out for carbon monoxide poisoning.

Fire defense techniques are generally well known so I will not dwell upon them here. One thing you need not do is call the fire department, if you could. There is little they could do, if they were still around, without central water supplies. But the thing you can do is improvise closings to seal off all the apartments above you, and those immediately below you, so that fallout will not blow



## You Will Survive Doomsday

in and settle on the floors over your head, or otherwise near you.

Now, it may be possible to organize your activities with other survivors to become a cliff dweller like those of old. A bucket on a rope might be used to haul up water gotten from a nearby stream or pond, and waste could be let down in the same way.

Some ingenuity may be required in providing heat and light, but if you really have sufficient supplies of food for yourself and your fellow survivors to hold out until another crop can be planted and harvested (most survivalists recommend at least two years supply), and you seriously face up to the sanitation problems created by morbidity, and you and your co-survivors are sufficiently organized against anarchy, and there are no more nearer bomb blasts - then you are probably well on your way towards continued survival. At least you are many times better off than being in a public shelter.

There may be all sorts of reasons why you elect to remain in the city rather than head for the country. If the attack comes in the winter and you do not have a planned escape route, adequate clothing and supplies to make the trip, are not physically able to make the trip, and do not have a known destination of refuge, well then...

Those who have most prepared themselves and have made the best plans should pray that their flight does not come in the winter. During a storm, or severely cold weather, it is very likely that many more persons may be killed by exposure than by any other single cause. The roads and highways will most likely be jammed. If there has been an explosion in the vicinity then overpasses and utility lines may have been dropped onto the roadways making them unusable.

Even without a blast having occurred, traffic jams, accidents, or vehicles just running out of gas will probably create bottlenecks that completely clog the roads. Once people find themselves just sitting there, not moving, they will abandon their vehicles. My guess is you can forget using an automobile for escape unless you had a plan and immediately implemented it before the general panic set in.

A motorcycle, scooter, or even a bicycle might offer certain advantages over an automobile. One might carry a smaller form of conveyance on a larger one and then implement the smaller means of conveyance, such as a bicycle, when that became the necessity.

The most dependable means of escape would probably remain walking. If one had to walk all the way out, and they were in any physical shape at all, they could surely do it in two or three days. Once again, proper preparation can make all the difference. Proper walking gear, proper survival clothing, a planned escape route, proper selection of material to be packed, and proper allocation of loads.

And, as before, there are better alternatives. One could have pre-arranged pickup points and times with co-survivors coming from the refuge destination, or in a worsening pre-crisis situation you may have made an early dispersal. But the greater likelihood is that anyone with a practical survival plan who reacts immediately can get out well before the rush sets in.

Just getting out into the country, or to the other side of the mountain, will increase the survivability factors for many people. The threats of blast and thermal radiation will have been greatly reduced. But blast and thermal radiation while very nasty in their effects are not going to kill that many people anyway. Oh, they will kill millions, but as a percentage of the people living the day before doomsday they will, combined, kill only ten to fifteen percent. And most of these will be a considerable distance from the blast and will eventually die as a result of injuries caused by the broken glass shards.

As stated before, depending upon the time of year and the weather, many more may be killed by exposure. But there is still another big killer coming. That is of course the fallout from the weapon explosions that took place many hundreds of miles away. This fallout may require from a few hours to a day or two to arrive. If the weather permits, and the survivors know what they are doing, they may still have time to build an expedient shelter against the fallout.

Techniques for defense against fallout have been developed and tested at great expense by almost every nuclear nation. While information on these techniques has been made readily available, most people have not availed themselves of it.

Two basic techniques are available. One is to leave the contaminated area. But the extent of the contaminated area may be far too wide to escape, or one may not have accurate information as to the delineation of the contaminated area, or they may not have the means of transportation, nor the means of survival should they reach a radiation free area.

The other basic means is to provide shelter within the contaminated area. Weather, ground, and time conditions permitting it is possible to dig a trench and cover it with dirt supported by poles, wooden doors, or a vehicle. Properly designed, such an expedient shelter can make all the difference between avoiding the effects of fallout radiation, and not avoiding those effects.

The details of how to build an expedient shelter are to be found in books listed in the [bibliography](#). One of the most important and often overlooked factors in designing a shelter is the matter of providing an airpump so as to eliminate the problem of carbon dioxide poisoning. The technique for building such an expedient pump from materials readily available in time of crisis is also found there.

The effect of fallout radiation is not always death, although many times it is. Even if it is death it is not immediate death. Intense radiation causes a very painful, and horrible death (what the literature calls a *hard* death) over several days. More likely the effects are drawn out over a period of weeks, months, or even years. As the title of this document points out, all these people will have survived doomsday. It is not a question of survival but the condition of survival with which we must concern ourselves. Everyone will die eventually but it is the quality of life in the interim that is of importance.

## **MYTH #02 Most people would be quickly killed by the bomb blasts, thermal radiation, or radioactivity.**

By the second year after doomsday the combined affects of blast, thermal radiation, and fallout will probably have resulted in some immediate, but mostly delayed, deaths accumulating to 35% of the population that were living on doomsday. Deaths that can be directly attributed to radiation and weapon related injuries will continue until five years after doomsday so that by that time 40% of the population that was living on doomsday may no longer be surviving because of the above named factors.

*However, the total population surviving five years after doomsday will probably be only 20% of the number that was living on doomsday) Obviously, nearly half, or perhaps more than half, of the fatalities will be directly contributable to causes other than the bombs.*

What then are these equally effective causes of post doomsday mortality? They are exposure, starvation, plagues, and anarchy. While the threat of chemical and biological warfare is not to be ignored the primary causes of these means of mortality can be looked upon as being more *natural*. That is to say they will just result naturally from the breakdown of the social infrastructure that we regularly depend upon for day to day survival.

The four factors that will determine survival are

- Location
- Knowledge
- Preparation
- Luck

On doomsday most people will be living outside of areas that will be struck in initial attacks by blast or thermal radiation. Many others will already be living in areas that will never be damaged by blast or thermal radiation. Both of these groups, if they have the knowledge of what to do, and have made the proper preparations, will very likely find themselves in the group of survivors who are living unharmed five years after doomsday when the surviving population has once again established some semblance of order and is once again multiplying and replenishing the earth.

## **Selecting and Designing a Shelter**

### **MYTH #03: You can build an adequate shelter in your basement.**

For a number of reasons, basement shelters do not offer the amount of protection that is commonly supposed. A proper analogy between them and a survival installation as described later in this document would be to compare a plank with a well-equipped and commanded lifeboat. This is not to say, that if someone finds themselves in the water from a sunken vessel, it is not well to advise them to grab hold of a plank and start paddling in the direction that one hopes there lies shore, if there is no better means of survival, such as a lifeboat, or raft.

Similarly, there is very little protection afforded (starting from the rooftop down) by a layer of shingles, a foot or two of light insulation (composed mainly of air-spaces for the purpose of retaining heat), a quarter to half inch of plaster board, some paint, a carpet on the floor, another layer or two of thin boards, and perhaps some paneling or ceiling tiles if the basement is finished. The distance between the roof and the basement (a two-story house offers more than a bungalow in this way) does allow some additional protection, but this factor, along with the combined density of all the matter described, would not equal more protection than would be afforded by six to eight inches of earth.

When, within such a basement situation, one starts to create an expedient shelter using, as is usually advised, such materials as bookcases and trunks (filled with earth if possible), there are certain design errors that are liable to creep in. Piling dirt or other material on the floor above will help but the greatest dangers will be from the areas outside the basement wall where the foundation extends above the ground. It is best to keep ones shelter at least three feet below the outside ground level, and to have at least three feet of soil above one's head.

The next most overlooked problem is that of proper ventilation, so as to avoid carbon dioxide poisoning. As stated before, most survival experts advise a location other than the basement for such reasons as the threat of carbon monoxide poisoning in case of fire, broken gas mains, and the threat of fire itself that may result from the wide spread firestorms caused by the thermal radiation associated with a nuclear blast.

There are certain advantages to a basement shelter. One may have access to necessities such as food, clothing, and blankets stored in the home. There may still be water available from the hot water tank. And, most importantly, one may feel certain psychological comfort by being in the familiar surroundings of their own home. None of these advantages of course hold a candle to the advantage of being in a properly equipped and manned survival center.

#### **MYTH #04: You must filter the air coming into a shelter to remove the fallout.**

One of the general misconceptions regarding fallout and fallout shelters is that the air itself may become radioactive. This is simply not true. Those with a little learning will then say "Ah, yes, but it will contain radioactive particles of fallout". That is true, but a properly designed air intake, even for an expedient shelter, will cause most of the particles to drop out of the air flow before the air enters the shelter.

Should the number of particles still suspended in the air be a problem, an expedient filter, such as a damp sheet hung in the air intake passageway, will do an adequate job of filtering the air.

If the air vents do not have automatic blast valves then the air passage should be quickly shut and remain shut for a few minutes after the brilliant flash of a nearby nuclear explosion (so as to prevent the popcoming effect described earlier). The air passages will have to be shut in every case where there is a large fire nearby that is generating carbon monoxide that would otherwise seep into the shelter.

Most expedient shelters will not have precautions such as those just described. The danger of carbon monoxide poisoning is one of the main reasons that most survival experts recommend that even if one has a basement in their house it is preferable to build an expedient shelter a considerable distance outside and away from existing structures in case of fire.

#### **MYTH #05: Water would become radioactive.**

As has been mentioned before, the materials necessary for building an airpump, and an expedient radiation detector, are available in almost every home. Anyone planning on attempting to use the basement survival method should obtain ahead of time the detailed instructions for building these devices, and store these instructions in their home, along with an emergency supply of food and containers for storing approximately 14 gallons of water for each individual that is going to be accommodated.

There is a similar misconception about water becoming radioactive as there is about air becoming radioactive. This may have something to do with misconceptions about the nature of *heavy water*, but we won't go into that here. Radioactive particles do become suspended in water, however, and that is why for the shelter confinement period, you must make sure that you have a sufficient store of potable water available ahead of time.

During the recovery period, after radiation has decreased to the point where it is safe to work outside, there are techniques for letting fallout settle out of water, and for distilling water, in order to make sure that it is safe for drinking and cooking. However, far from keeping air and water out of a shelter, it is absolutely necessary to life that they be available.

While an expedient shelter could mean the difference between life and death, it is probably not something that you would want to continue to use for a very long time.

#### **MYTH #06: There would be no dangerous radioactivity after a couple of weeks.**

There is a wide range of misconceptions about what is safe and what is not. The matter is sufficiently complicated that a person should have professional advice. However, if there was no doctor going to be available to set a broken leg I presume you would go ahead and do the best you could. And if one had to build a bridge to get across a river and there was no structural engineer around, again I presume one would have a go at it.

Doctors would like to have their x-ray machines available when setting a leg, and engineers would like to have their surveying equipment, specification guides, and computers or slide rules when they are building a bridge. So you can well imagine a radiological defense officer would like to have radiation detection equipment available when giving advice in a radiation defense situation.

However, if the advice, expertise, or equipment, is not available, one must go on. One rule of thumb is that if there is not enough fallout that you can see it, then there is not enough of it that it will kill you. Fallout is usually small grain dust or grit, often having a light color, but not always. It depends upon its source. The best place to spot it is on a smooth surface, like the hood of a car.

The more dense fallout is, probably the greater the hazard, although there isn't necessarily a direct correlation. It may fall thick enough that quite a little heap of it may be brushed up from a surface that is one foot square. It is possible to build, from common materials found around the home, an expedient radiation detection meter. The details for such a meter are found in books listed in the [bibliography](#).

Even if one has commercially available radiation detection equipment there is still some considerable skill required in its use. For example, almost all survey equipment is designed to be used by an adult of normal stature. This means that if the equipment is held in the hand of a walking adult it will tell how much radiation is being received 3 1/2 feet above the ground, and particularly by the adult's vital organs which are above that level. A child's or an infant's vital organs will be below that level and will be exposed to much more hazardous levels than an adult's. For this reason, if one is passing through an area that is suspected to have any radiation at all, a child should be carried on an adult's shoulders.

There is another rule of thumb that for every seven fold increase in time radioactivity will decrease by ten fold. This is called the seven/ten rule. This is based upon standard decay. It is useful as an example, for training, and in building theoretical models, but in actual practice the decay rate is likely to be something quite different. It is determined by the isotopic composition of the matter under consideration.

There is another commonly held misconception among semi-trained individuals that low levels of radiation cannot be rapidly fatal. Someone, after several days in the confines of a cramped expedient shelter, might conclude that because their meters now indicate a very low level of radioactivity (or perhaps no radioactivity if it is a high-range instrument), that it would now be all right to go outside and sleep on the ground in the cool breezes beneath the bright summer stars.

The fallacy again arises from taking measurements at a level that assumes the vital organs are well above the radiation source. This is not the case when a person is stretched out on the ground for long hours of sleep. These long hours of low level radiation exposure to the vital organs will result in a fatality in just a few days.

Likewise, perfectly healthy adults who take infants out of the cramped, unpleasant, expedient shelter to allow them to play during the day on a blanket spread out on the ground will be quite shocked to see those infants sicken and die in just a few days while they themselves remain healthy. The infant's vital organs again being close to the weak radiation source for a long period while the adults' vital organs are being protected by distance.

## **MYTH #07: Radiation sickness is not contagious so there is no danger in assisting those affected.**

The statement that radiation sickness is not contagious is often found in the literature. That is true. The erroneous conclusion is drawn, however, that being around persons with radiation sickness is not dangerous. The danger arises from the manner in which radiation kills.

Sufficient radiation can cook the vital organs, but more often what happens is that it kills the white corpuscles and the ability of the bone marrow to make more of them. It is the white corpuscles that are the body's defenders against viruses, bacteria, and other disease causing bodies.

Once these defenders are lost the person succumbs to a disease they might have otherwise warded off, and once that disease takes hold in the individual they may become highly contagious.

In this manner there is grave danger of plagues breaking out, and all sorts of illnesses one does not generally see, becoming very threatening. For this reason rigorous quarantine, sanitary measures, and health defense measures must be imposed and enforced.

Becoming aware of such unexpected and unpleasant snares may initially make one feel that the situation is hopeless. The danger really arises from a person's unfamiliarity with the circumstances. There is the story of the explorer who asked the young native if there were crocodiles in a certain stream. He was assured there were not. While then swimming in the stream he once again saw the young lad on the bank and asked for reassurance that there were no crocodiles. "Oh no sir!", replied the shocked young fellow, "They won't come here. They are all afraid of the piranha."

The young fellow would have found himself equally in danger from things with which he was not familiar in our society, like automobiles and electrical appliances. It is not that the hazards are so onerous, but simply that we are not familiar with them.

## FOOD - Some Important Considerations

### MYTH #08: Food exposed to radiation becomes radioactive and is therefore not edible.

Food is the most serious problem. Most food that is in the house will not be harmed by the radiation, no matter how intense. There are three types of radiation that are found in fallout. Alpha particles, beta particles, and gamma rays. As the first two names indicate, they are particles. They are minute (too small to be seen) pieces of atomic matter that attach themselves to the fallout (bits of dust that may or may not be large enough to be seen).

In any case, these particles may be simply washed off many types of foods that have a natural covering, such as eggs, bananas, potatoes, oranges, etc., or off well sealed foods such as those in vacuum packed cans. Foods such as grains (rice, dry cereals, etc.) that are in partially used packages that have been opened should be viewed with suspicion. Fallout dust may have crept in.

The food in its unopened container or natural covering should be rinsed under flowing water and then placed on a surface that has been similarly cleansed, before opening. Make sure that the hands (and under the nails) have been thoroughly cleansed before handling the food. There is little danger in handling such articles. The radiation given off by these particles is so weak that it will often not even penetrate something as thin as the cellophane wrapper on a package of cigarettes.

You may then ask "Why, then, be concerned?" The reason is that once these minute particles are ingested into the biological system they will get into the organs and the very bone marrow itself where they can do a lot of damage. This is not to say that you need not worry about getting the alpha and beta particles on your skin. You do. Because they can cause skin burns. However, good hygiene practice can eliminate that problem but they are a much more severe hazard internally than externally.

### MYTH #09: If you have a special *radiation suit* like you see in the movies and on TV you will be protected from the radiation.

As an aside, this is one of the reasons that those *fallout or radiation suits* that you see in all the pictures and movies and on TV are such a **joke**. Those things are not going to protect the guy from anything, that a couple of good garbage bags wrapped around his feet and made into a hood to go over his head, would not do as well. In fact the garbage bags are in many ways better. They would be considered disposable.

The main purpose of the fallout suits is to prevent the wearer from tracking the fallout into the shelter. The user simply takes the suit off at the door. If the person were to wear it on inside, it would defeat the purpose. There are some clean handling techniques that are beneficial to know and practice, but in a wartime situation there is so much of the stuff around that peacetime standards of exposure and cleanliness lose their meaning.

The gamma rays are another matter. They are very penetrating. No fallout or radiation suit is going to protect you from them. It requires much more dense matter to protect you than you could lift, let alone lug around. This is why one must remain in a shelter when there is intense radiation. With good housekeeping there should not be so much dust inside a shelter as to create a hazard from gamma rays. However, be sure to dispose of the contaminated rinse water that you have used for cleaning the food containers and persons returning from outside. It may contain matter that is giving off gamma rays.

There will probably not be sufficient fallout on the food packages (or you can get rid of it quickly enough) that you need concern yourself about the amount of gamma radiation that you are going to get from that source during the decontamination process. However, the food may have been stored in an area that has received very intense radiation. That can of beans or peaches may have been stored right out there where it was receiving 1000 roentgens of radiation per hour. An amount that would have killed you right away. But it will not be harmed.

That is right. It is perfectly edible. If it were not so I would have told you. It is only living things that radiation hurts. Even then it depends upon the frequency and intensity of the radiation. For example, there are all sorts of radio and TV waves going right through where you are sitting right now and they are not harming you.

The food in the can is already dead and the gamma rays are not going to harm it. They will not make it radioactive. If the radiation is strong enough it may kill any bacteria that happen to still be living in the food and thus preserve it even further. If the food is supposed to contain bacteria (such as yogurt) I am not sure what it would do for that!

Radiation preservation of food is a technique that is already being used in industry and will probably become much more widely used in future years. Many people already have radiation (microwave) ovens in their homes today. One further analogy. Fire will kill living animals but we use it to cook our food. You really shouldn't be overly frightened about radiation, either.

## **MYTH #10: New crops of food grown in future years will not be radioactive.**

Food that is grown in radioactive soil, or that has not yet been harvested when, fallout falls on it is another matter. This food will absorb the particles of radioactive matter into its own structure and thus become dangerous.

The biological food chain acts as a marvelous strainer and concentrator of radioactive isotopes. This was well demonstrated in certain tests that took place at Almagordo. From some intentional surface bursts and because of the unintentional venting of some underground bursts there was some fallout carried onto the milkshed for southern Utah.

The amount of fallout deposited over the surface was so slight that the most selective instruments could not detect it. An atomic or nuclear explosion releases its great amounts of energy by changing some matter into energy. It also changes certain amounts of matter into new and different types of matter. Without going into detail about atomic theory, the nature of the atom with its electron rings, and its nucleus consisting of protons and varying number of neutrons, let us simply say that these new forms of matter are generally unstable isotopes. That means they are going to change into another form of matter.

Once again, the matter, in the process of changing from one state to another, releases certain amounts of energy. It is this energy that we measure as radioactivity. The energy, depending upon the isotope involved, may be rapidly dispelled or it may continue to be released for a very, very long time. Most unstable isotopes release their energy and transform into a stable state within fractions of a second or at least within minutes after a nuclear explosion. Others take hours, and still others days, weeks, or months. Some take centuries.

Each isotope starts out with just so much energy. For all practical purposes we can say it is not going to get any more. Once that isotope has released all its excess energy it will become stable. Since the isotope releases its energy at a specified rate we can say how long it will take to lose half of its energy. After that, it will then take the same length of time again for it to lose (give off) one half of the remaining amount of energy. Question: When will all of the energy be given off by the isotope?

An ancient Greek philosopher posed the same problem. He said, "Suppose there is a bear at the back of a cave. On the first day the bear walks halfway to the entrance. On the next day he walks half of the distance that remained to the entrance after the first day. And on the day following the bear walks half of the distance that remained to the entrance from the previous day. The bear continues to do this same thing on each subsequent day. He walks half of the distance to entrance of what was left from the previous day. The question is: when will the bear get out of the cave?"

The answer is: "Never." This sort of regression is what mathematicians call asymptotic. That is to say the figures continue to approach zero, closer and closer, but they never reach it. So just as the bear never gets out of the cave, all of the energy is never lost. But much (one half) of the energy is lost in the first half-life. And three quarters of the energy is lost by the end of the second half-life. After ten half lives a very large percentage of the energy is gone.

It is because so much of the energy is lost in the early periods (half-lives), as compared to the later periods, that it is important to be in shelter during the early periods after fallout has fallen. We might divide the half-life times of radioactive isotopes into three categories. Very short term, medium term, and very long term.

As mentioned earlier, most of the unstable isotopes generated by an atomic or nuclear explosion are very short term. They give off all their significant amounts of energy in a matter of seconds. Unless you are within very close range of an atomic or nuclear bomb there will be no way for this radiation to reach you. It was this initial radiation that caused the horrible radiation burns and sickness at Hiroshima and Nagasaki.

First the good news. There will not be any persons subjected to long suffering from the initial radiation by the nuclear weapons of today. The bad news is that the reason why is that the weapons blast such a large hole or create such a large area of complete destruction that the initial radiation can't escape. That is to say the totally destructive blast extends beyond the range of the initial radiation.

On the other hand, the survivors of Hiroshima and Nagasaki did not have much problem with fallout. The first major victims of fallout were some fishermen many, many miles downwind from the Bikini Island tests. Fallout is a phenomenon much more associated with nuclear weapons.

Nevertheless, there was fallout in Southern Utah. As stated before, it was so slight it could not be detected by the most sensitive instruments. The specific matter of interest in southern Utah was the isotope 131 of iodine. This was absorbed by minute bacteria in the soil. In the process of filtering the iodine out of the soil the bacteria greatly concentrated it.

The bacteria were absorbed by legumes and other biological forms higher in the food chain. Each in turn further concentrated the iodine isotope.

Finally, after the iodine had found its way into the grass a cow came along and ate it. Now a cow is a very complex organism in itself. There are all sorts of biological activities going on in a cow. Various organs and the bone marrow filter out different minerals for different purposes. One of these complex systems forms milk. This particular cow, and hundreds of others like it, was milked, and the milk was bottled and distributed to children all over the area of southern Utah.

The children were also complex biological organisms. They in turn had numbers of specific organs that specialized in straining out various minerals and compounds from the food that they consumed. The end result was that their thyroids once again concentrated the iodine 131. And this to such an extent that if you held a radiation detector next to their necks it buzzed like a rattlesnake. This was not healthy.

In fact numerous problems developed among the population. There were a great number of mentally retarded children born, and a number of other unpleasant ramifications. This need not have occurred from the iodine 131 if we had known what we know today.

### **MYTH #11: There is no such thing as a fallout pill.**

There is a simple pill that would have prevented the difficulty. It is supplied in every nuclear emergency kit in Russia and available in Denmark and Sweden. Unfortunately it is not sold in North America.

Fortunately, however, the pill is quite simple to make. Ahead of time, obtain a quantity of potassium iodide from your local drug store. Five dollars worth should be lots. When needed, take a regular glass and fill it a fourth or less full of water, and then slowly start pouring in the potassium iodide while thoroughly stirring the water.

Don't worry about how much you pour in. You cannot pour in too much. After a while you will notice that the chemical no longer dissolves in the water. It just lies there on the bottom. This means that the water is saturated. You can now stop pouring in the chemical. More will not help or hurt.

Next take an eyedropper, or a soaked piece of paper if you do not have an eyedropper, and drop four drops onto a little piece of bread for an adult. Or two drops for a child. If you get several times that amount it is not going to harm you (although in much larger amounts it is a poison).

Now take some butter or margarine and make a little ball out of the bread and pop it down. Tastes awful. Ugh. Take once a day for 100 days after the last bomb falls. This is good stuff and you should have it around for reasons other than defense in case of a nuclear war.

If you live anywhere within in a couple of hundred miles of a nuclear generating plant you might suddenly find yourself needing the stuff. The US department of Health rushed a supply of pills to Three Mile Island and they have a standard brochure all printed ready for distribution in case it or some similar site vents.

The department of defense also keeps a supply near the old Titan sites that are deteriorating and breaking down. [Author's update note: Once again those sites have been now decommissioned and no longer present a problem, but much greater concerns now arise from Terrorist Threat, and the U.S. Government is now stockpiling in many cities not only these pills but others for Bacteriological and Chemical Threats]. Canadians have nothing. I'll take that back. They do have lots of nuclear plants and the distinct possibility of bombs exploding over their heads and on their soil.

The reason why the potassium iodide works is that the thyroid will absorb only so much iodine. After that, any iodine taken into the body is passed off by the kidneys. Since the body already has all the good stuff it wants it passes out the bad stuff. This is what we call thyroid blocking.

Do not try to use the tincture of iodine that you put onto cuts. Taken internally it will kill you. And you cannot eat enough iodized salt to do you any good. You would get salt poisoning long before you got sufficient iodine to do the job.

### **MYTH #12: There is a fallout pill that will protect you from all radiation.**

I wish I could tell you about another pill that would solve all your radiation and other problems. But there is none. Unless you mean the cyanide pill mentioned earlier and things really are not that  
file:///E:/PROPHECYKEEPERS/data/POST-NUCLEAR-WAR/d\_resources/survival/books/doomsday/index.htm (12 of 26) [9/11/2004 8:23:23 PM]

gloomy. As I hope I have carefully explained, most of the radiation we have to be concerned about from a nuclear bomb will decay in a matter of days or weeks to a level where we can deal with it.

### **MYTH #13: There would be dangerous radioactivity for thousands of years.**

You may say "I've heard that some radiation will be around for thousands and even hundreds of thousands of years". Yes, but those isotopes are our friends. (That may be putting it a bit strongly.) Anyway, they are not near so harmful as many people think. There is the point of view that no radiation is good for you. Some dermatologists maintain that you should not even get a suntan. (Yes, that is radiation that you get from the sun.)

There is even the theory that it is cosmic radiation that causes both overall genetic change, aging, and death. In any case we are all subjected to many sources of radiation every day. The question is not whether or not you are going to receive radiation, but how much and how quickly. Let us compare the radiation we are concerned about with another type of radiation. Heat.

Just as we measure radioactivity in roentgens we measure heat in calories. If I were to tell you that that pipe over there was going to put off a million calories of heat, you might say, "Let me get away from it!". But, if I then said that it was going to be over the next million years, at the rate of one calorie per year, you would realize that you were in greater danger of freezing to death than of burning to death if you were depending upon that pipe for heat.

It is not how much heat is going to be given off (it may be a large amount) but how much over what period of time. A mere two hundred calories suddenly inflicted upon one point of the skin would create a bit of a sting, but hundreds of thousands might be comfortably absorbed from a heating pad over an appropriate period of time.

It is the same with radiation. Most isotopes give off their energy so rapidly that they are like flash bulbs. Flash and they are gone. It just happens right in the vicinity of the bomb. Others are like regular light bulbs that give off their light and heat for some period of time before they burn out. They may travel a long way from the bomb as fallout before they dissipate their energy. For these we need a shelter to protect us if we are in their vicinity. Nothing else will do.

Still others are like those small luminescent lights that some people put in their bathrooms for night-lights. Only weaker still. They just sit there and barely glow for a very long period of time.

Little miniature flashlight bulbs or matches are a good analogy to fallout particles. One or two of them in a room with you will not harm you. But surely you can imagine the situation where if you had thousands and thousands the light would either be blinding or the heat so intense that you would be incinerated.

Fallout is just the same way. A few pieces inside a shelter with you will not harm you, but if you go outside where there are millions of the little beasts lying around then you have had it. The only difference between their radiation and the radiation from a little flashlight bulb or a match is that it is invisible radiation that you cannot see or feel - like that from an x-ray machine.

### **MYTH #14: There would be no dangerous radioactivity after a couple of years.**

After having explained all this, now I must tell you that there are some isotopes that unfortunately do not fall into either the short range of initial radiation (which we do not need to worry about because it does not extend out of the blast area), nor the medium range (that you will be protected from by a fallout shelter), nor the very long range (that decays over so many hundreds of years that their energy is too weak to concern us here).

These remaining isotopes are real meanies. There may be solutions to the problems they present but there are no simple solutions. There will not be enough of them around that they will make walking around dangerous for most people but the problem is that they get into the food chain and that they have relatively short half-lives, between five and 30 years.

That means that during the next couple of hundred years they are going to be giving off most of their energy. Fortunately, some of them are rather rare, and given that they are going to be widely dissipated in worldwide fallout we can largely ignore their effects.

Others may be concentrated in certain areas, certain types of soil and certain foods where we can avoid them also.

So they will not be that serious a problem.



## You Will Survive Doomsday

Some others, however, particularly Cesium 137 and Strontium 90, present mayor problems in keeping them out of the food chain. Even here, there are available defense techniques. For example lime, gypsum, fertilizer, or organic matter (in practical amounts) may be applied to low calcium soil, or naturally high calcium soil may be used for growing certain crops which have an uptake preference for calcium over strontium.

There are known refining and purification techniques for some foods and milk, and there are some new techniques which I have discussed with some of the researchers at some of the leading nuclear laboratories, but which the world isn't ready to hear about as yet.

These methods along with others such as land denial, deep plowing, surface scraping, and selective utilization, are harsh realities that are going to have to be faced by the long-range survivors.

### **MYTH #15: You are prepared if you have a two weeks emergency supply of food stored.**

More important to the present theme are questions as to what preparations survivors should be making ahead of time. Since it will take a while to get crops growing again because of social disorganization, ozone depletion in the atmosphere, climatic changes, crop adaptation, early crop failures, soil deprivation, and similar factors, survivors will need a couple of year's supply of food. Wheat and honey are the only two basic foods, of which I am aware, that have an indefinite shelf life. Thousand year old kernels found in the pyramids have still sprouted. Fortunately, these two foods, wheat and honey, meet most adult nutrient requirements. Powdered milk will be necessary if one wishes to reduce the infant mortalities. The infants will not survive otherwise, unless their mothers have adequate natural milk, which is unlikely. Salt is important as a preservative, among other purposes.

In addition to storing the four basic survival foods (wheat, honey, powdered milk and salt), it is highly advisable that one also store a couple of year's supply of a variety of (non-hybrid) seeds. Some seeds will not store very well and need to be continually replaced.

It is equally important to develop certain skills. *Gardening skills.* I particularly recommend the area of hydroponics because this would be one way to grow foods free of contamination. *Preserving skills.* Here I recommend learning to dry foods using hot air. Freeze-drying requires too much elaborate and expensive equipment and freezing itself is not reliable when electricity is not reliable. *Preparation skills.* Bread making, use of lentils, and making of many foods, or their substitutes, that today are commonly gotten in prepared form.

On all of these subjects one could write a book. Indeed many books have been written on them. Even if one does not have time to immediately develop all these skills they might do well to get themselves a survival library and then as a next step acquire the essentials in materials listed in checklists in most well organized manuals.

### **MYTH #16: You should be prepared to be self-sufficient and be able to survive on your own.**

The very best thing that a survival minded person can do, after preparing for themselves an equipped place of refuge, and developing their own survival skills, is to associate themselves with other skilled survivalists. No one person can know everything, and almost everyone can contribute something. Agricultural, medical, mechanical, communicator, you name it, all skills will be needed.

Few people could afford the equipment that an organization can have. One well-equipped laboratory for testing for alpha and beta particles in food costs \$5,000. Along with other radiation detection equipment and many other types of emergency supplies, what individual can afford it? Yet no nuclear survival group should be without one.

Even in building a shelter the mayor expense is the entrance and support mechanisms such as emergency lighting, water source, etc. The incremental cost for space for one additional individual is quite small. Thus, the greater the number of people the overall cost can be spread over, the less the average cost.

Moreover, no individual has the personal resources that a group has. If the head of a single family survival group is injured or lost the chances of survival for that group are much reduced. However, if it is a large group then there are numbers of people available to continue to give support. Just like there are numbers of people available to maintain twenty-four hour watches, or to create a well manned convoy to go after necessary supplies. One more prepared and equipped individual added to such a group is an asset, whereas in a situation like a public shelter, one more unprepared and unequipped individual is just another liability.

A successful survival group will have to be either completely homogeneous or thoroughly committed to thoroughgoing tolerance and appreciation of a wide range of individual preferences regarding society, economics, religion, and future expectations. Still, a shelter is not a democratic society anymore than is a ship or an airliner. The captain's authority is absolute and one should have confidence in his credentials and ability before boarding.

Neither is a shelter a democracy in the sense that there must be much more stringent rules regarding behavior. Everyone must perform assigned duties. There are no wealthy passengers along for a  
file:///E:/PROPHECYKEEPERS/data/POST-NUCLEAR-WAR/d\_resources/survival/books/doomsday/index.htm (14 of 26) [9/11/2004 8:23:23 PM]

free ride to be served by others. There are many limitations to personal freedoms such as contraband materials. No drugs or alcohol (except under medical prescription and then as approved by the commander).

All firearms and weapons must be placed in the armory and will not be released except under orders from the commander. All valuables will be receipted and stored in the locker for safekeeping. No private stocks of foods because under survival conditions this can lead to social disorder. No tobacco or smoking inside the shelter, since it would cause discomfort to others.

No loud toys, devices, or other objects that would be environmentally disturbing to others. No large bulky items, or great quantities of any item without the permission of the commander. And no pets or animals unless the survival community has made prior special arrangements for their accommodation.

Tough. Yes, It is tough. But not nearly as tough as the conditions of survival will be for those who are not prepared. There are many items that are not prohibited, and in fact are encouraged. A reasonable supply of one's personal religious literature, the tools and resource manuals of their trade or profession, survival manuals and equipment of every sort, additional supplies of food to be put into the common larder, and extra supplies to be put into the common store.

## **MYTH #17: Any survivors would have to live the rest of their lives underground.**

Many people ask how long they might expect to have to live in a shelter. There are no fixed answers. If your shelter is an expedient hole in the ground you might want to stay in it no longer than was absolutely necessary. Maybe as much as a couple of weeks. If you dug a pretty elaborate hole in the ground you might be able to expand upon it and make it into a place where you could survive through a winter.

If you owned space in a shelter city, like there is in southern Utah or southern California, you might plan to live there the rest of your life. The co-operative shelter that I have been describing in the previous paragraphs is not sufficiently elaborate that anyone would want to make it a permanent home. Some persons would probably be able to find larger and more adequate quarters elsewhere after a few weeks.

Others might improve upon the existing structure and remain there for a year or two until more adequate homes could be built elsewhere. Decontamination procedures would provide work areas, schools, and school grounds outside of the shelter where people would carry on their daily activities after a few weeks. However, it might be beneficial for young children and expectant mothers to sleep in the shelter or a similar structure for several months.

Certain occupations, such as decontamination crews, farmers who work on large un-decontaminated areas, explorers who go into unsurveyed areas, long distance truck drivers, and others who go out of well defined areas for the next several years, will have to be closely monitored to be sure their total exposure does not exceed established limits.

It should be apparent to the reader, from what has been said earlier, that a person may receive substantially larger total doses over a large period of time than over a short period of time, just as with sunlight. A person may easily recover from several small sunburns throughout the years, resulting from staying in the sun overlong for an hour or two each time. If they were to be exposed to the hot desert sun, that many hours all at once, they would succumb.

In the same way one may recover from a number of small radiation burns (although some controversy holds that one never recovers - this seems unlikely), and in just the same way one may receive small amounts of radiation and never feel ill. Just the same, certain biological conditions dictate that certain individuals, (particularly the reproductively active) should receive less radiation exposure and that others may receive much larger amounts.

## **MYTH #18: Life after doomsday won't be worth living.**

Hearing descriptions of this sort some persons wonder if life will be worth living afterwards. For some, most assuredly so. Others do not find life worth living today. How many times have you heard of a person like a famous movie star, who had wealth, fame, beauty, health, the company of famous illustrious persons, opportunities to travel to all sorts of places, and to participate in all sorts of interesting events, the fulfillment of the very aspirations of thousands of young ambitious people and yet that same person committed suicide.

On the other hand there are many individuals who suffer daily from terrible physical afflictions and all sorts of personal misfortunes. Oftentimes in the greatest poverty. And yet, the world over, down through the centuries, they have gone on surviving. Many actually finding happiness, meaning, and perhaps even enlightenment in life. You will survive. The conditions of that survival are up to you.

Undoubtedly, the events that are about to transpire will have a profound effect upon the attitudes of many people and perhaps upon mankind itself. From the cauldron of the holocaust there may spring forth a new race of men who are less concerned with self-interest and who will come to understand man's true nature and his divine destiny.

Some of us may even feel that this event will herald the coming to maturity of the human race. Instead of no future, mankind may have a glorious future. There will be great amounts of resources available, combined with man's great advances in technology, to build a new and glorious world civilization. Providing, of course, that he has learned from this experience and does not just go about preparing for the next war in another twenty to thirty years.

But, I leave each man unto his own vision. While, to myself, looking upon the immensity of the visible universe, and pondering the events that have happened upon this one single planet circling a solitary sun among the uncountable millions in our but one of the innumerable galaxies, I cannot help but wonder if the events that are about to transpire are not less than all that unique in the repetitive cycles of life and nature that we see about us everywhere.

### **MYTH #19: You need not make any preparation because you are either going to die in the holocaust or be saved (religious connotation).**

Men's philosophies today often go to one extreme or the other. Claiming that all is within man's power. Or that nothing is within man's power. There is a middle ground. One can simultaneously feel that nothing can be achieved except by the will of God and think that the results are dependent upon his own efforts. God sets the boundaries and within those boundaries man can have some effect upon the outcome.

### **MYTH #20: The bombs today are so large and there are so many they will destroy the world.**

There are those who feel that the holocaust will destroy everything. And well it might, for there are certainly more than enough nuclear weapons in the world to achieve that end. "Except those days be shortened, none will survive, not even the very elect." But, if it is the Divine Will, those days will be shortened. There are those of us who feel that the Divine Hand is evidenced in the dealings of the world, every moment unto every moment.

The Divine happenings often seem quite natural. If one were to say unto a mountain, "Be thou removed and cast into the sea." and it should occur, another would say an earthquake just happened to happen right then. If the forces of nature should transpire so that in the midst of the holocaust the planet should suddenly tip on its side and place His sign (the Southern Cross) suddenly blazing in the sky above the heads of the people in the northern hemisphere, there are those who would only recognize the natural causes.

Such an event would certainly play heck with the astral, satellite based, and inertial, guidance systems upon which the individual and MIRVed warhead delivery systems depend.

Events would not even have to be as miraculous as I have described in order to limit World War III. There is serious concern on the part of the military that they will not even be able to fight the war because of such factors as the EMP. However, I have faith in the military. I am sure they will do an admirable job of trying to destroy the world.

None of us have an infallible insight into the future or its timetable. Whatever will be, will be. We can but wait upon events to prove our speculations to be right or wrong. While we are working and waiting some of us put our trust in God. Others put it in the Government.

### **MYTH #21: You will receive adequate warning from your government.**

The government at first proposed the individual family shelter plan. Then it abandoned it. Next it proposed the community shelter plan. Then it abandoned it. Then it proposed the relocation plan. Then it abandoned it. Presently it has no plan. Don't you feel abandoned?

The government has millions to spend for destruction but not a penny for defense. The EMO (Emergency Measures Organization) has been completely shut down. The Ontario government was allocated three berths in the Radiological Defense Officers course (for the summer of 1982) given by the Canadian Emergency Measures College at the Emergency Planning Canada Federal Study Center in Amprior, Ontario, but it didn't feel it could afford to send anyone even after our group offered to pay expenses for three people. We appealed all the way up to the Solicitor General's office.

Admittedly, I am authorized to teach the course but during the last course that I taught at one of the community colleges (free gratis) I could not even get any resource personnel to come from

Camp Borden, who are responsible for administering the examinations. I feel abandoned. A radiological detection kit that I used to be able to get for sixty dollars, in the US, now costs in Canada, with import duties (they really want you to have one), federal and provincial taxes, exchange rate, custom's brokerage, and you name it, \$450. Who cares?

The last Radiological Scientific Officers Course taught in Canada was in 1977. No future courses are planned. There are no communities with a nuclear defense plan. I think I can make that an unqualified statement.

Millions for destruction and not a penny for defense. Your family's destruction bill for this year is \$1,300 per member of your family. Do you realize what \$1,000 a year for the last ten years would have bought you in the way of nuclear survival defense? Instead, your government has bought you destruction. Your family's destruction.

Oh, I am well aware of the argument that that pile of bombs has maintained peace in the world for the last ten years, and the belief that it will continue to maintain peace. Believe it if you want to. All the high government officials have their shelters. Why do they need them if you don't? [Author's update note: Curiously, even the government's shelters for civil authorities have now been closed].

If the government knew today that the Russians were going to attack next week, do you think they would tell you? If they did, what would you and the millions like you do? It would only create panic and get in their way. No, I do not think that you would be told. Do you feel abandoned?

### **MYTH #22: You will receive no warning, and there is no hope if you do.**

The fact the government may not warn you, and is not giving you any assistance to defend yourself does not mean that you haven't been warned. There are many people who feel they can see the *signs of the times*. Anyway, if you have read this document, consider yourself warned. You may still have time to prepare. If an attack should occur you probably do not live in a primary target area and will have plenty of time to escape. If you have made preparation.

### **MYTH #23: One of the primary targets will be nuclear power plants.**

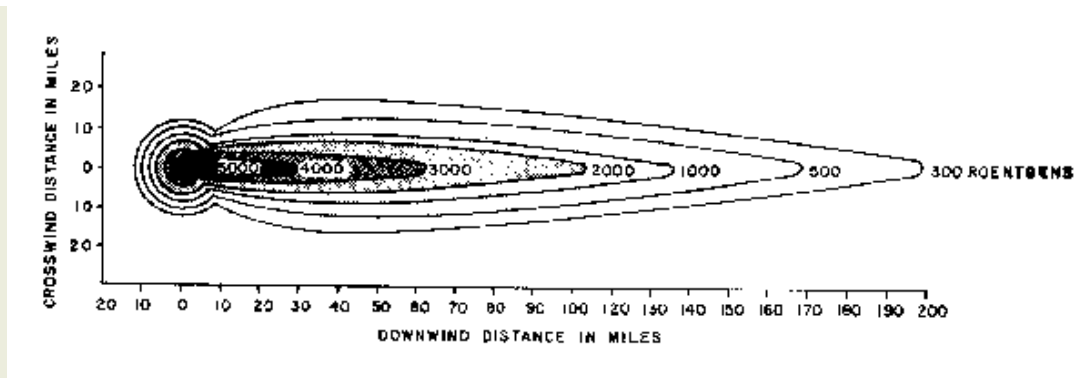
Many persons come up with all sorts of rationalizations as to why they should not prepare for survival. One is that there is a sufficient number of weapons in the world, that if they were all used, they could destroy the whole of mankind. This is true.

However, it may be that all the weapons will not be used. Some may be destroyed by the other side. Some may misfire. Others may just fail to get launched. This is why each side has so many extra. Moreover, many persons make the mistake of assuming that it is all in man's hands and determined by man's will. Whatever. It may be that some limited amount of the potential for destruction will be used.

Another rationalization often heard is that the person feels they live in a target area such as in the vicinity of a nuclear generating plant. In actuality the Russians have little need to target the nuclear generating plants and probably can do more damage by not doing so. A bomb on the plant would just blow it to smithereens and the material in the plant might add little to the radioactive fallout. On the other hand, as a result of the EMP, if the plant is left on its own when it loses its computer control it will go into a meltdown and add substantial radioactive material to the atmosphere.

All of this is quite speculative, of course. There are no experts on nuclear war. There is no one living who has been through one. There is general agreement that it will be awfully terrible. It will probably take six or seven months just to bury the bodies. But, there will probably be someone around to it.

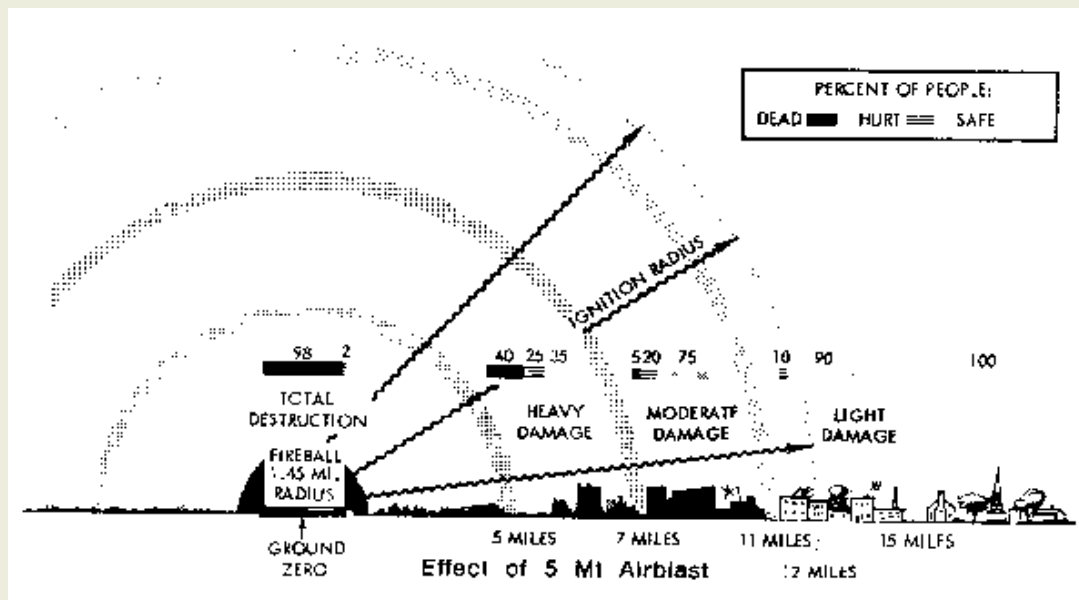
## **Useful Figures and Tables**



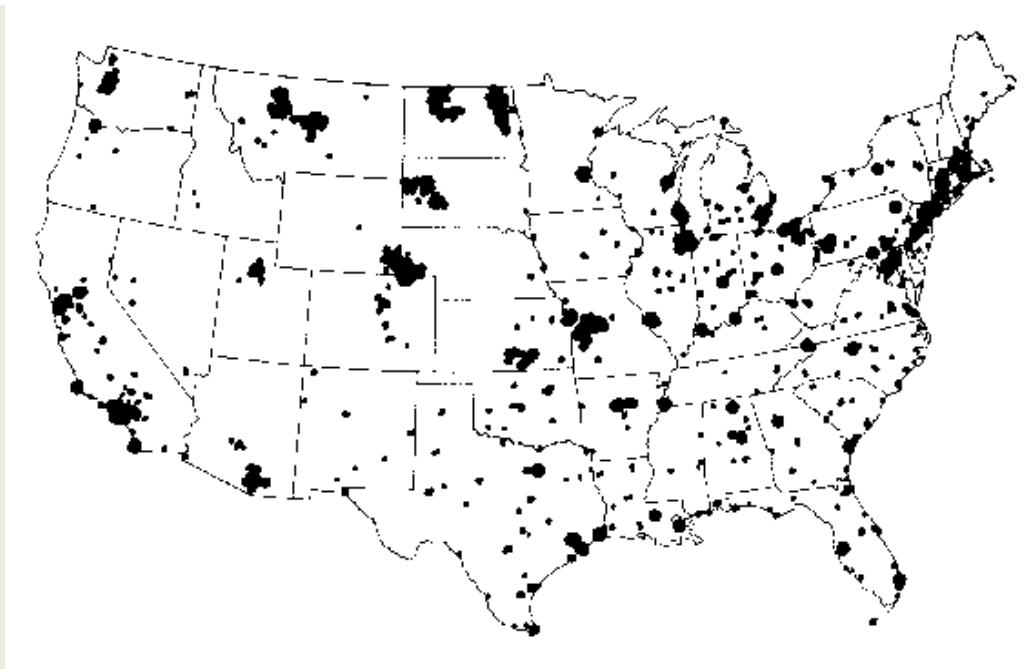
This was the fallout pattern 36 hours after a single 15-megaton thermonuclear device (the Bravo shot of Operation Castle at Bikini Atoll - March 1, 1954) was detonated. The eventual extension of the fallout was more than 20 miles upwind and over 320 miles downwind. The width in cross section was variable, the maximum being over 60 miles. This means there was substantial fallout contamination over an area of more than 7000 square miles.

It is important to note that persons anywhere downwind would not have had to travel more than 40 miles in a direction crosswind to be perfectly safe. Secondly, assuming upperwinds of 150 miles per hour and descent times of 30 minutes, persons 150 to 200 miles away would have over an hour in which to either evacuate the area or to take shelter.

As noted from the chart on [the effects of radiation on humans](#), the 300 roentgens per hour would cause serious illness with some fatalities after an exposure of 1 hour and exposure of 2 hours would certainly cause a hard death occurring in hours to days.

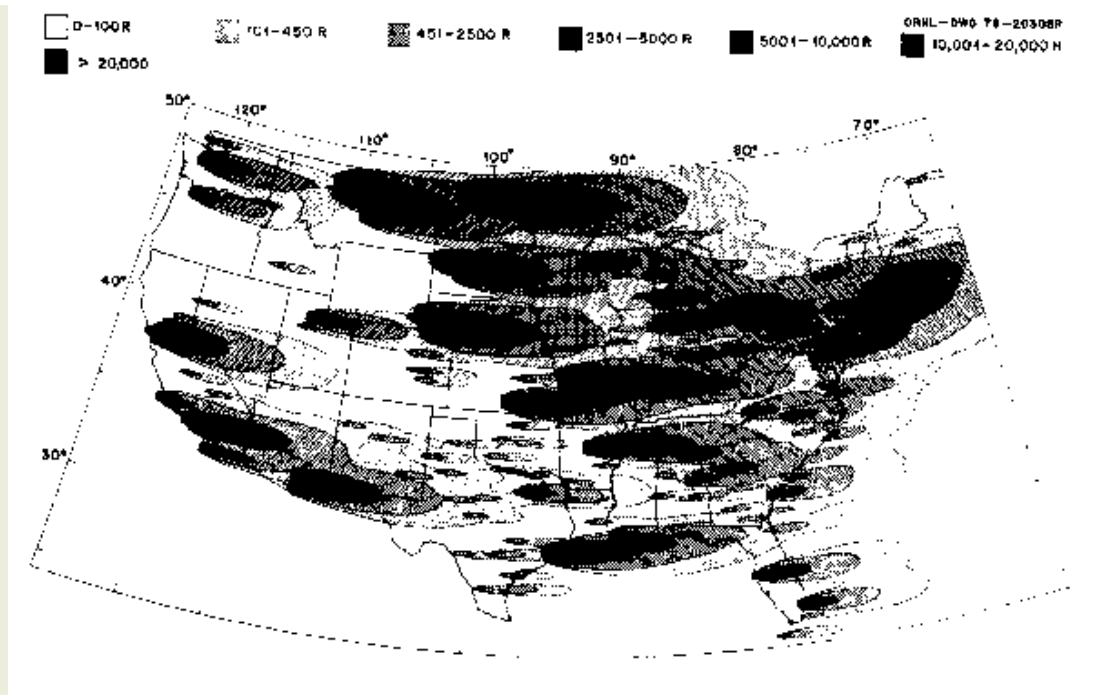


This picture shows the effect of a 5-megaton airblast. While much larger weapons have been developed experimentally their use is unlikely. For one thing they are too hard to deliver and, more importantly, with a 20-megaton weapon we do only about one third the damage that will be caused by 4 five-megaton weapons. 5 to 8 megatons will probably be the average size of the strategic weapons. They will probably be detonated at some altitude around 2000 feet for maximum effect. At 15 to 18 miles on a clear day exposed people will be blistered, and from 18 to 23 miles they will be sunburned.

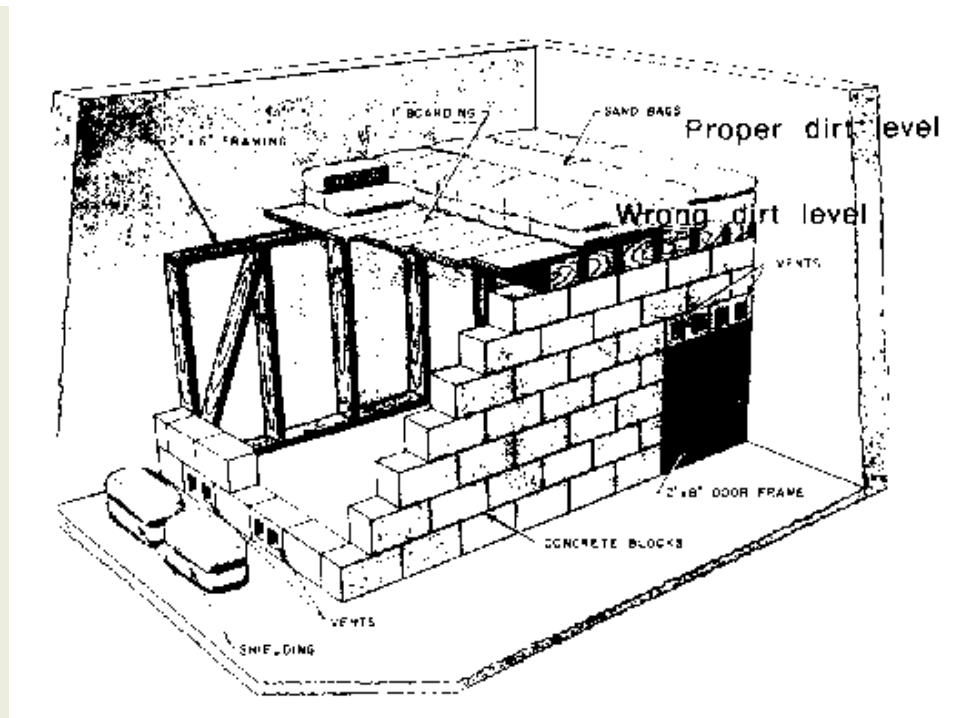


This map shows the principal targets in the US. Major airports, military installations, and railway passes would be targets in Canada. The number two target in North America is North Bay, Ontario.

In an all out nuclear exchange (WW III), with a multiplicity of devices being detonated over a relative short period of time (three days to two weeks is a common estimate), there would most likely be wide spread areas with general radiation levels (in the 5 to 20 roentgen per hour range) over 1000 miles down wind from the blast sites, two to three days after zero hour.



This map indicates the amount of radiation that a person would receive in various areas by remaining in the open for 14 days following the bombing of targets indicated in the map above. It is important to note from the map that even if Canada were not bombed that Ontario would receive 101 to 450 roentgens from the MinuteMan sites in Montana and the Dakotas.



The effect of a mere 10 roentgens per hour (arriving two or three days after a detonation and thus having already lost much of its rapid decay) would cause serious illness after one day's exposure, and (even with continued decay) would cause certain death within a couple of weeks. However, almost any expedient shelter would greatly minimize the effects.

The basement shelter shown here could mean the difference between life and death. As much care as possible should be taken to make sure the shelter roof is below outside ground level. Otherwise, radiation will come in at an angle through the narrow basement wall, as demonstrated.

### Seven/Ten Rule

1 hour	-----	1000	roentgens/hour
7 hours	-----	100	roentgens/hour
49 hours (2 days)	-----	10	roentgens/hour
2 weeks	-----	1	roentgens/hour
14 weeks	-----	0.1	roentgens/hour
98 weeks (2 1/2 years)	---	0.01	roentgens/hour

This chart indicates that if one started off with one thousand roentgens of radiation per hour at zero plus 1 hour, that it would take 2 weeks for the radiation to get down to 1 roentgen per hour.

Since death would be almost certain after exposure for even 1/2 hr (see accompanying chart) it is apparent that shelter would be necessary.

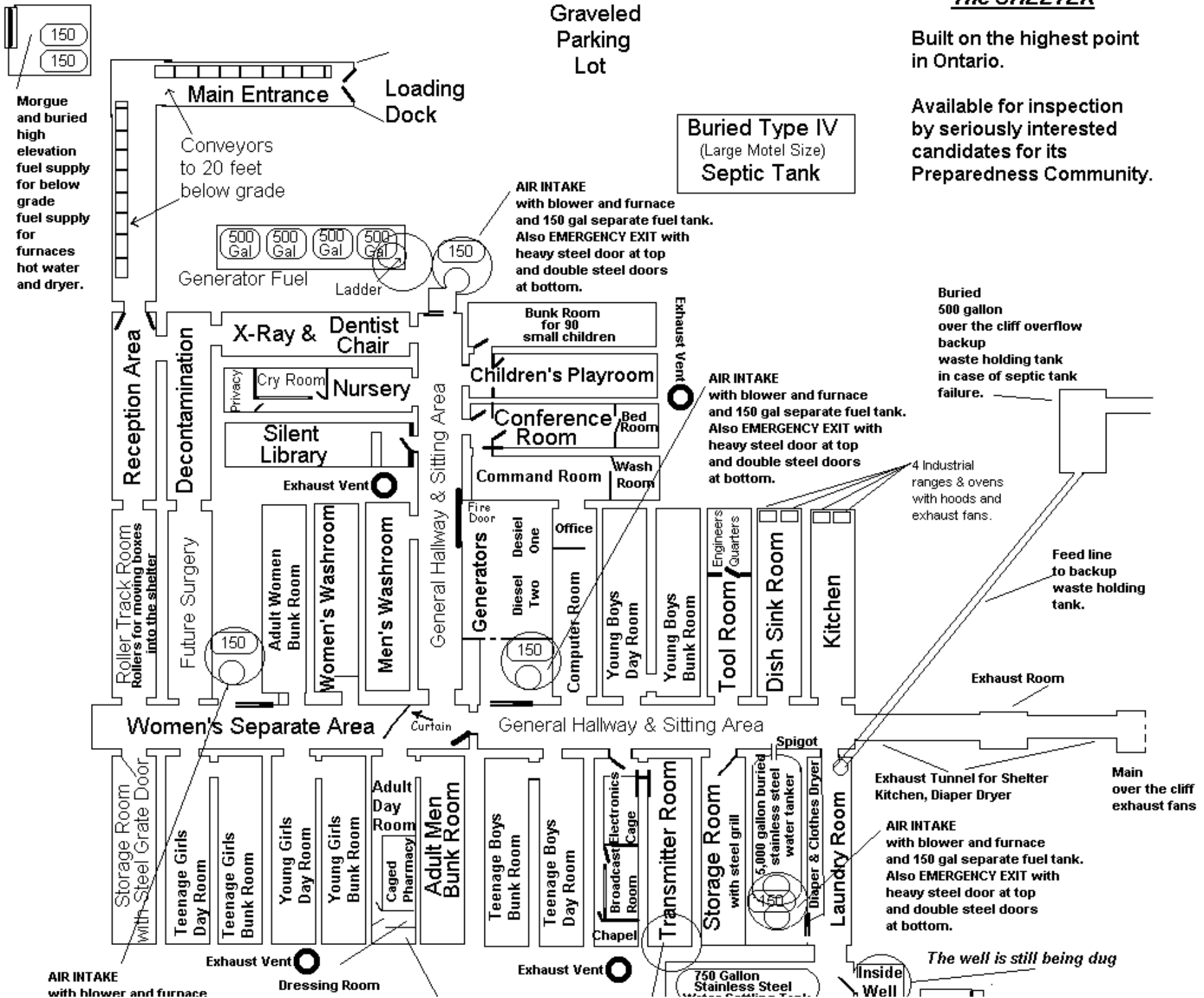
The important thing to remember about the seven/ten rule is that it is only theoretical, and that actual decay may follow a different slope. Secondly, in order to use it, one must know the exact time of detonation for the weapon causing the fallout. And thirdly, it is only applicable for calculating the fallout from one weapon, and not for multiple sources.



### The SHELTER

Built on the highest point in Ontario.

Available for inspection by seriously interested candidates for its Preparedness Community.



and 150 gal separate fuel tank. Also EMERGENCY EXIT with heavy steel door at top and double steel doors at bottom.

and pump room for Immersion Tank

**SENSORY DEPRIVATION Immersion Tank**  
Kept at body temperature and saline level so that person won't sink. Individual placed in tank with classical music will sleep and overcome cabin fever.

Surface Hatch to Below Ground Balloon Launch Room for Antenna Balloon. Access from Transmitter Room to Shelter is through double steel doors.

150 150  
Completely external buried bunker gasoline supply.

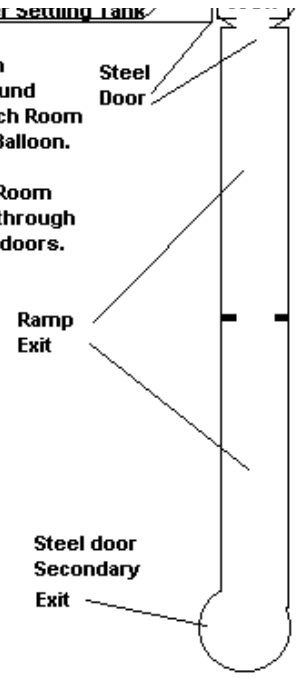
*The secondary exit tunnel is still under construction. New improvements are constantly being made on the shelter.*

Steel door and Grill to be installed at this level

The shelter is built out of extra strength concrete and is heavily reinforced throughout with steel. It far exceeds maximum recommendations both as to radiological and blast protection.

Ramp Exit

Steel door Secondary Exit



The shelter contains extensive alternative methods of moving air, fighting fire hazards, providing lighting, internal and external communication, and every other conceivably necessary requirement.

For example, it has a great amount of radiological monitoring equipment.

**General Information:**

The shelter was designed under the guidance of a number of licensed engineers. It was also inspected by numbers of government agencies, particularly the Federal Government shelter inspection group who said it was the finest shelter they had seen.

There are many, many features to the shelter that cannot be described here because it would too greatly clutter the drawing.

[Author's update note: The above is a map of the underground shelter actually built 90 miles northwest of Toronto. Anyone interested in joining the survival community where it is located should email the author for photos of the existing shelter. ]

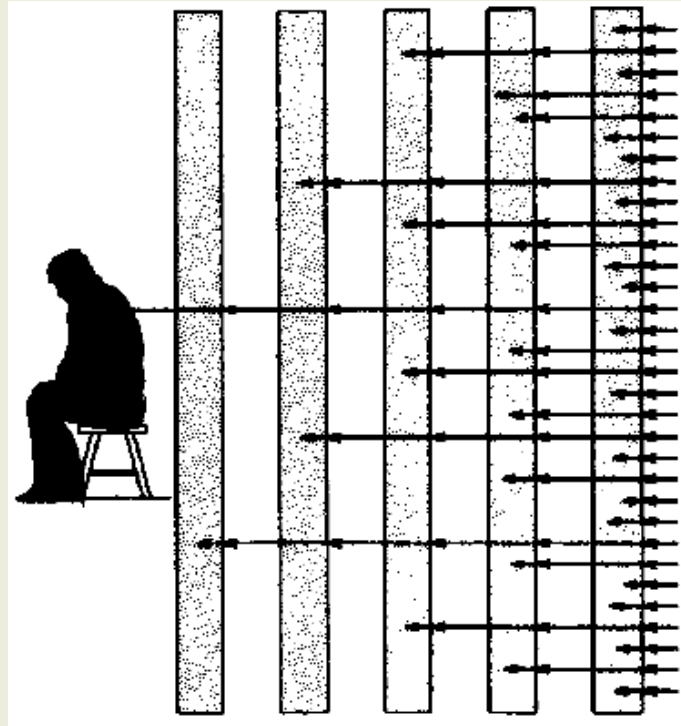
**Examples of the Effects of Radiation on Humans**

Roentgens per hour	Duration of exposure	Total dosage of radiation received	Number that will die	Deaths will occur in
5-10	2- 5 hours	10- 50R	none	
50	1- 4 hours	50- 200R	less than 5%	60 or more days
100	2- 4 hours	200- 400R	less than 50%	30 to 60 days
100	4- 6 hours	400- 600R	more than 50%	about one month
100	6-10 hours	600-1000R	all	less than two weeks
200 plus	3 hours plus	600R plus	all	the more intense the radiation the shorter the time before death
1.0	1 week	150R	none	
0.3	1 month	200R	none	
0.1	4 months	300R	none	
1.5	1 week	250R	5%	3 months
0.5	1 month	350R	5%	6 months

## You Will Survive Doomsday

0.2	4 months	500R	5%	9-18 months
2.7	1 week	450R	50%	1-3 months
0.8	1 month	600R	50%	2-6 months

## Example of the Effect of Shielding



Any material can be used for shielding against radiation. Even feathers. There is nothing magical about lead. It is only the density of the material that matters. A pound of lead and a pound of feathers weigh exactly the same. But it takes a much bigger stack of feathers than it does of lead to make a pound.

Neither feathers nor lead are generally particularly cheap to obtain, so it is usually better to use some other material like dirt or concrete. The more dirt or concrete in the barrier, the greater the protection. Since concrete is more dense (heavier) it only takes about 24 inches of concrete to give the same protection as 36 inches of dirt.

Thirty-six inches (three feet) of dirt will give good protection. Five feet of dirt will give better.

## Nuclear Survival Groups

There are probably 12 nuclear survival groups in the city of Toronto. I personally know of four and I have heard of three or four others. (There may be some overlap. I can't be certain.) My guess is that there are another three or four I don't know about. Most such groups are very secretive, for various reasons. Three of the groups are headed up by instructors, like myself, who teach survival courses at the community colleges.

[Author's 1998 update note: The author was maintaining a listing of survival communities in North America].

[Authors October 2002 update note: The list had grown to several hundred intentional communities and survival groups in North America when as a result of consensus of opinion he ceased to  
file:///E:/PROPHECYKEEPERS/data/POST-NUCLEAR-WAR/d\_resources/survival/books/doomsday/index.htm (24 of 26) [9/11/2004 8:23:23 PM]

publish it because of government and social attitudes. People on the list were asking to be removed because of fear of repercussions. Waco had occurred his own Ark Two Community had been raided without warrant by 7 police vehicles, including a K-9 unit plus 4 fire vehicles. A total of over 40 personnel as was shown on the National News.]

Most of the groups contain a number of very well trained and experienced people. There are also many other groups scattered around both the US and Canada. They have their own training bases and survival courses. There is a magazine, Survive, where you can learn about some of these groups.

## What is a Radiological Defense Officer?

Both in the Canada and the United States the Federal Governments have trained certain individuals to be advisors to mayors and other public officials in time of nuclear disaster. In Canada these individuals are called Radiological Defense Officers.

Certain Radiological Defense Officers have received additional training, so as to become qualified to teach Radiological Defense Officers. These individuals are designated as being Radiological Scientific Officers. The supposed requirement for becoming a Radiological Defense Officer is a Ph.D. in physics, but because of a lack of candidates, individuals with lesser qualifications have been selected.

## About the Author

The author of this document built twenty-three fallout shelters in Kansas and Utah in the 1960's. He completed the US Office of Civil Defense course in 1970 after moving to Canada and then the Radiological Defense Officer's course at Arnprior, Ontario in 1976, and the Radiological Scientific Officer's course in 1977.

While in the USAF, he was a control tower operator and graduated as Honor Student from the AACS supply school. Because of this training he was asked to inspect the Titan missile sites after his honorable discharge. He refused because of his understanding of what the missiles could do to mankind. He has been a member of various anti-war groups and his personal motto is "Bell the Cat and Ban the Bomb", but he thinks it is now too late to do either.

His master's degree is in Economics from Texas Christian University, and he holds certificates in both data processing and information technology, the latter from MIT. [He has also written and edited several books in the field of computer science].

Prior to becoming a college teacher of computer science he was a telephony engineer and holds both US and Canadian patents.

He presently devotes a large amount of his time to the nuclear survival group mentioned in this document.

## Bibliography

[Author's update note: The two books that I used to most highly recommend were]:

- [Life After Doomsday](#) by *Dr. Bruce D. Clayton*; click on the title of this book to order it from Amazon.com.
- [Nuclear War Survival Skills](#) by *Cresson H. Kearny*; click on the title of this book to order it from Amazon.com.

[Author's 1998 update note: While those two books are still very valuable, and it is a good idea to read more than one author's ideas on the same subject, still there is a new book about which I am quite enthused. This book is the most recent book of which I am aware and it gives some new and updated information. From the source, presentation, and approach of the book it somewhat makes me think that its writing may have been commissioned or supported by the Mormon Church, but (which is not a negative but) whatever its source it is excellent.]

The book is "Nuclear Defense Issues",  
by " Paul Seyfried and Sharon Packer of Utah Shelter Systems".

You can order in on the net from:

[Utah Shelter Systems](#)

or by mail (for \$25) from:

Utah Shelter Systems  
P.O. Box 638  
Heber, Utah 84032-0638  
U.S.A.

[Author's update note as of January 1st, 2002: I am now quite enthused about a still newer book.

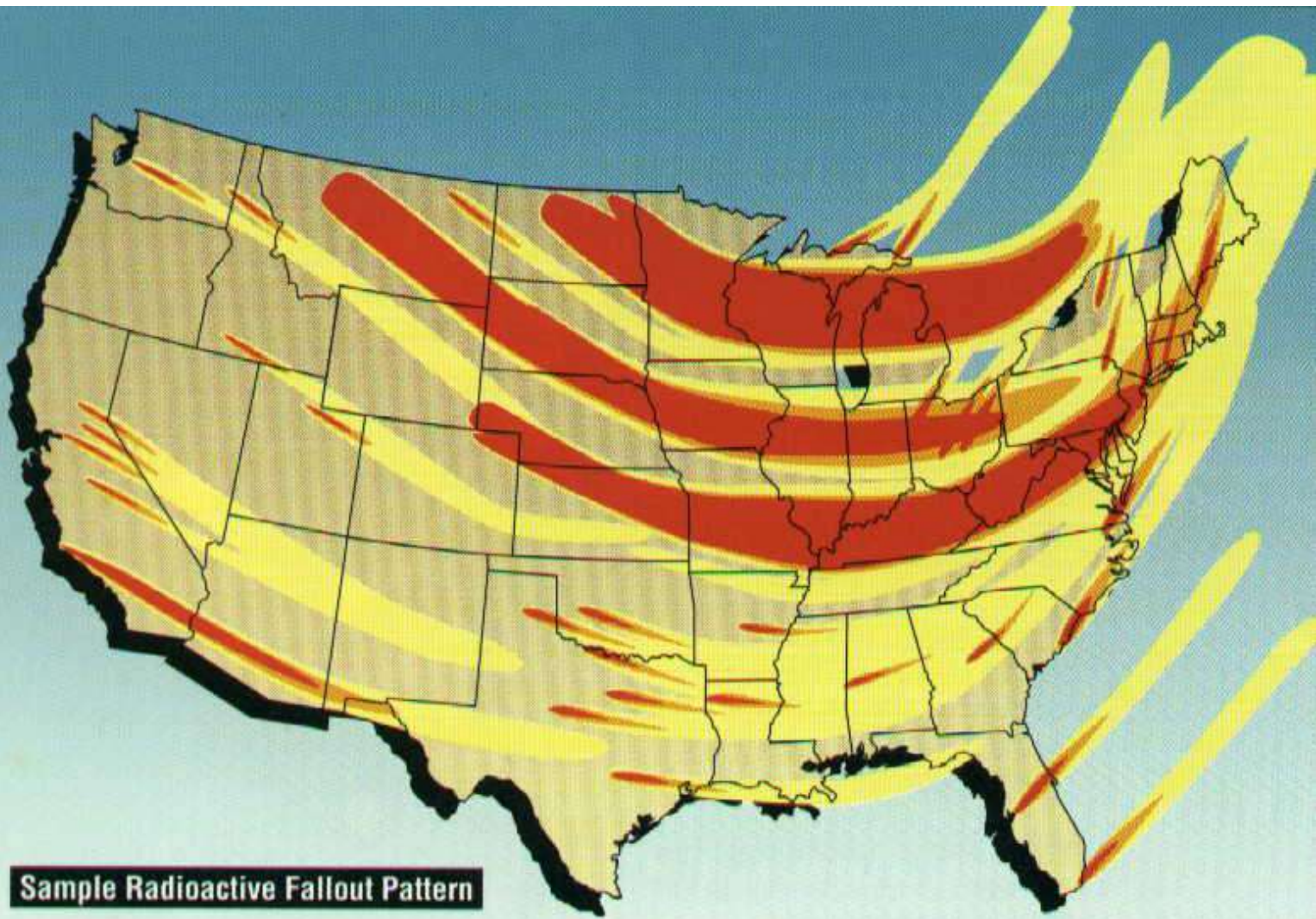
The book is "No Such Thing as Doomsday",  
by "Philip L. Hoag".

You can order it by mail (for \$25) from:

Yellowstone River Publishing  
P.O. Box 206  
Emigrant, MT 59027  
USA  
406-333-4707  
USA 800-585-5077

---

**MENU:** [HOME](#) » [SURVIVAL](#) » [Index of States](#)



Source: FEMA

**MENU:** [HOME](#) » [SURVIVAL](#) » [Index of States](#)

# The Ark Two Community

The Ark Two Community is the largest pluralistic survival community in North America without any political, religious, or cultural bias. Its purpose is to ameliorate the catastrophe of a nuclear war and to help restore civilization. Inquiries from all are invited. Write an email to:

[survival@webpal.org](mailto:survival@webpal.org)

## The Ark Two Refuge Facility

The Ark Two Community in Canada has a 10,000 sq/ft nuclear shelter as part of its refuge facility. This may be the largest Privately Constructed nuclear fallout shelter in the world. 42 buses were used as forms to pour a minimum of 12 inches of high strength concrete that was heavily reinforced with rebar. A minimum of 5 feet to a maximum of 14 feet of earth was pushed back overtop.

Go to:

[PICTURES](#)

for a tour of the complex.

The Ark Two Community is founded and commanded by a government trained and certified Radiological Scientific Officer.

Anyone is welcome to join the Ark Two Survival Community (located in Ontario, Canada) - so long as they do so before the catastrophe occurs. There is no charge for membership nor any restriction other than one be tolerant of the other members. However, it is only practical to be a member if one makes arrangement to live within about 20 miles because it would not otherwise likely be possible to get to the Ark at the time of catastrophe.

The purpose of the Ark Two Survival Community is to ameliorate the effects of a Nuclear War and to help reorganize society afterwards. The community founder believes that a nuclear war is inevitable and therefore in 1980 built the first phase of the Ark Two Refuge and has since expanded it and prepared many ways to assist survivors - as listed on this web site.

The project has not been favorably received by the local and provincial governments. By 1990, when I stopped counting, it had been subject to over 30 court and commission appearances and the

number has greatly increased in the last few years. Legal costs have mounted to hundreds of thousands of dollars. In 1999 there was a raid without warrants involving 7 police vehicles, 4 fire units and over 40 personnel and a K-9 unit, coincidentally caught on video tape by the CBC. Subsequently the facility was hounded with repeated government inspections. Some of the inspectors candidly admitted that it was just harassment, but because of wanting to keep their jobs they of course were not going to put that into writing. It is for this reason that one might refer to the facility as Waco North. A kinder, gentler Canadian version in that The Ark doesn't have any weapons and in that so far no one has been killed by the raiders.

The general public views the project as being operated by an eccentric (in the most favorable terms) or by a nut-case in what is the more usual expressed attitude. For the forty years in which I have built over two dozen shelters and have consulted on many dozens of others, the general ridicule has been extensive, to say the least. "Why do it then?", I have often been asked. Why not get a life, enjoy life and quit worrying about doomsday? The answer is that I don't see the purpose of life, nor happiness in life measured in how many rounds of golf I might play, but rather in service to my fellowman. While I don't have any "visions" or hear any "voices" this appears to me to be the service to which I have been called.

**MENU:** [HOME](#) » [SURVIVAL](#) » [Index of States](#)

---

---



**MENU: [HOME](#) » [SURVIVAL](#) » [Index of States](#)**

---

Pictures and Information About  
**The Ark Two Facility**

[MAP of the actual interior of the shelter](#)

[Artist's concept of the interior of the shelter](#)

[MAP to the location of the Refuge Facility](#)

[Interior Photos of the shelter](#)

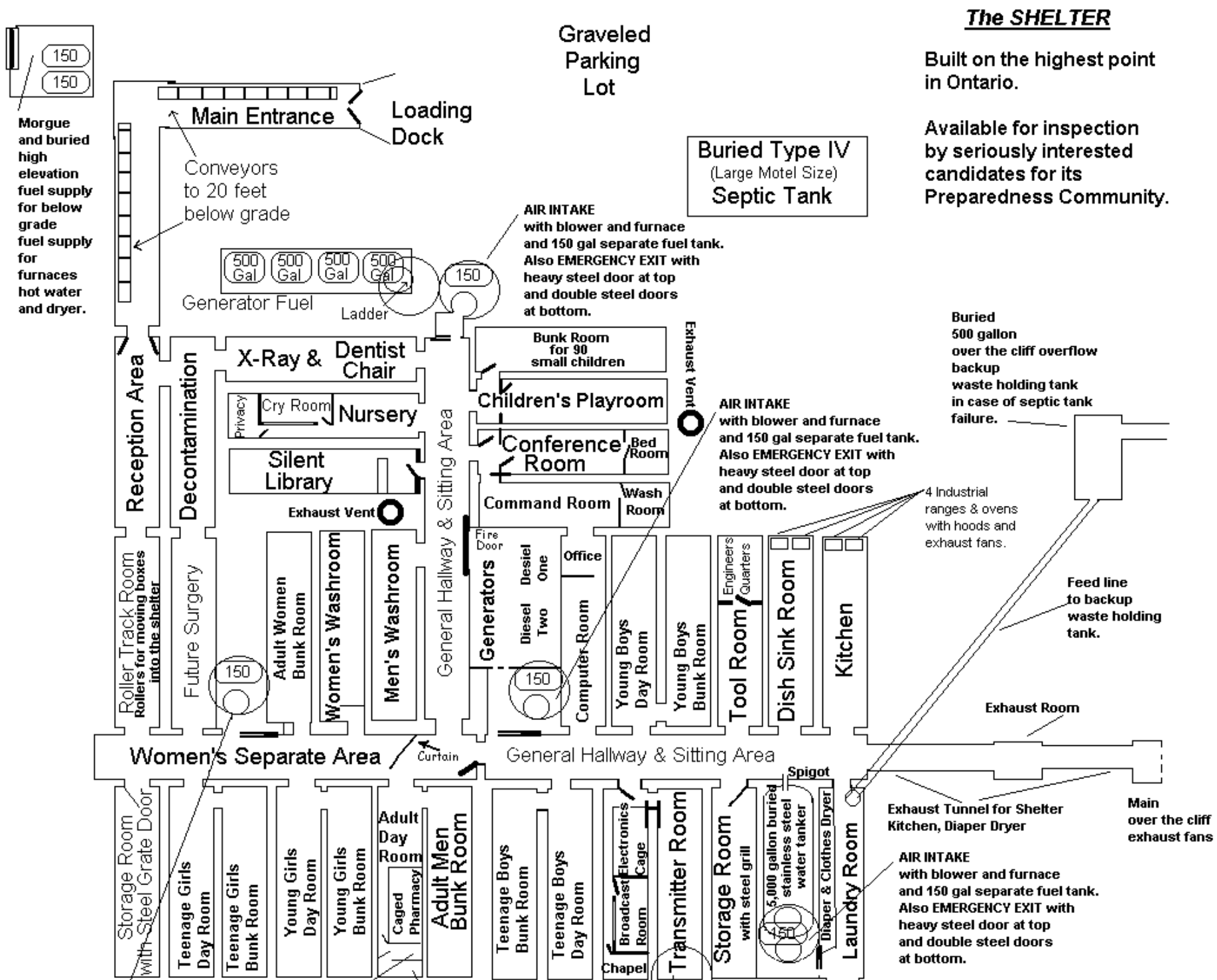
[Exterior Photos of the Refuge Facility](#)

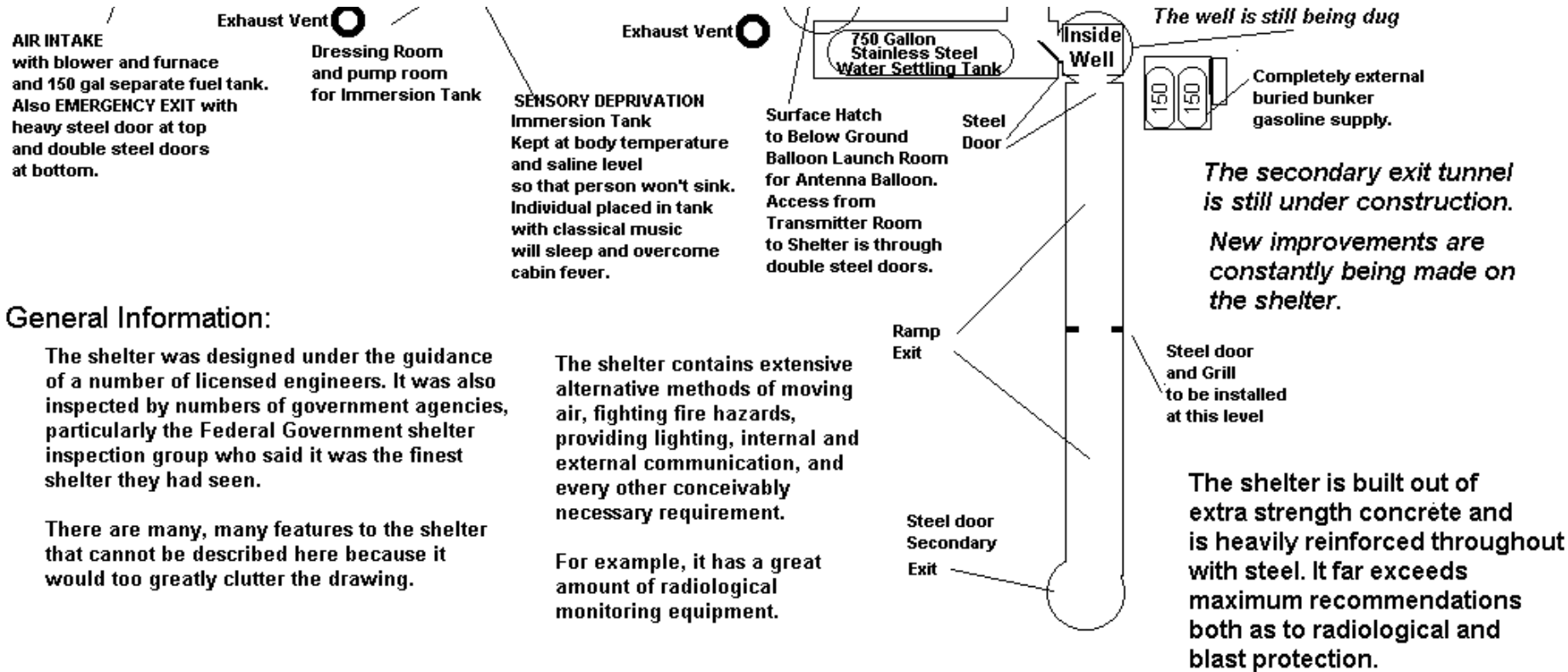
[Construction Photos of the shelter](#)

[Ark Two Community Life](#)

---

**MENU: [HOME](#) » [SURVIVAL](#) » [Index of States](#)**





### General Information:

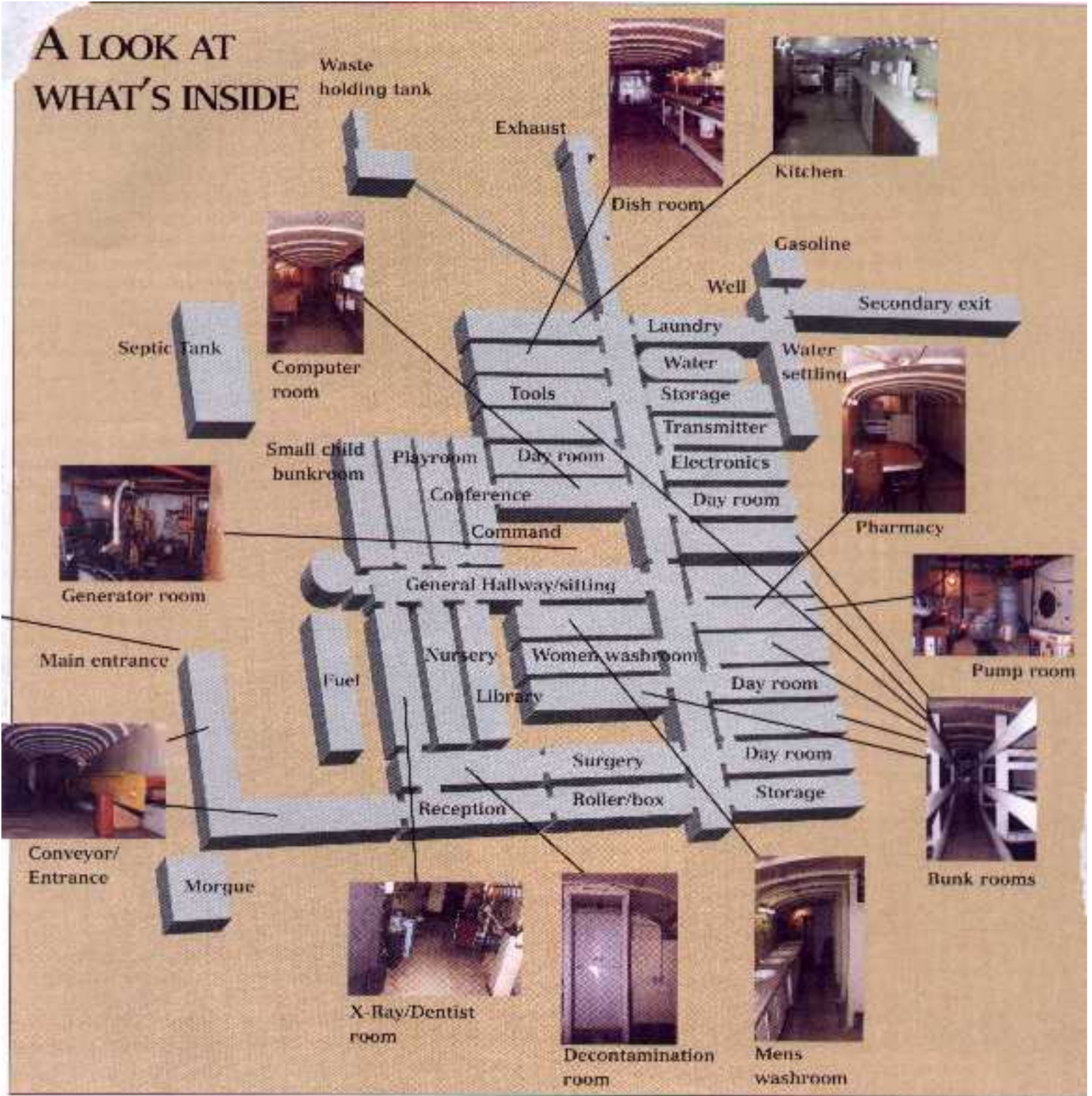
The shelter was designed under the guidance of a number of licensed engineers. It was also inspected by numbers of government agencies, particularly the Federal Government shelter inspection group who said it was the finest shelter they had seen.

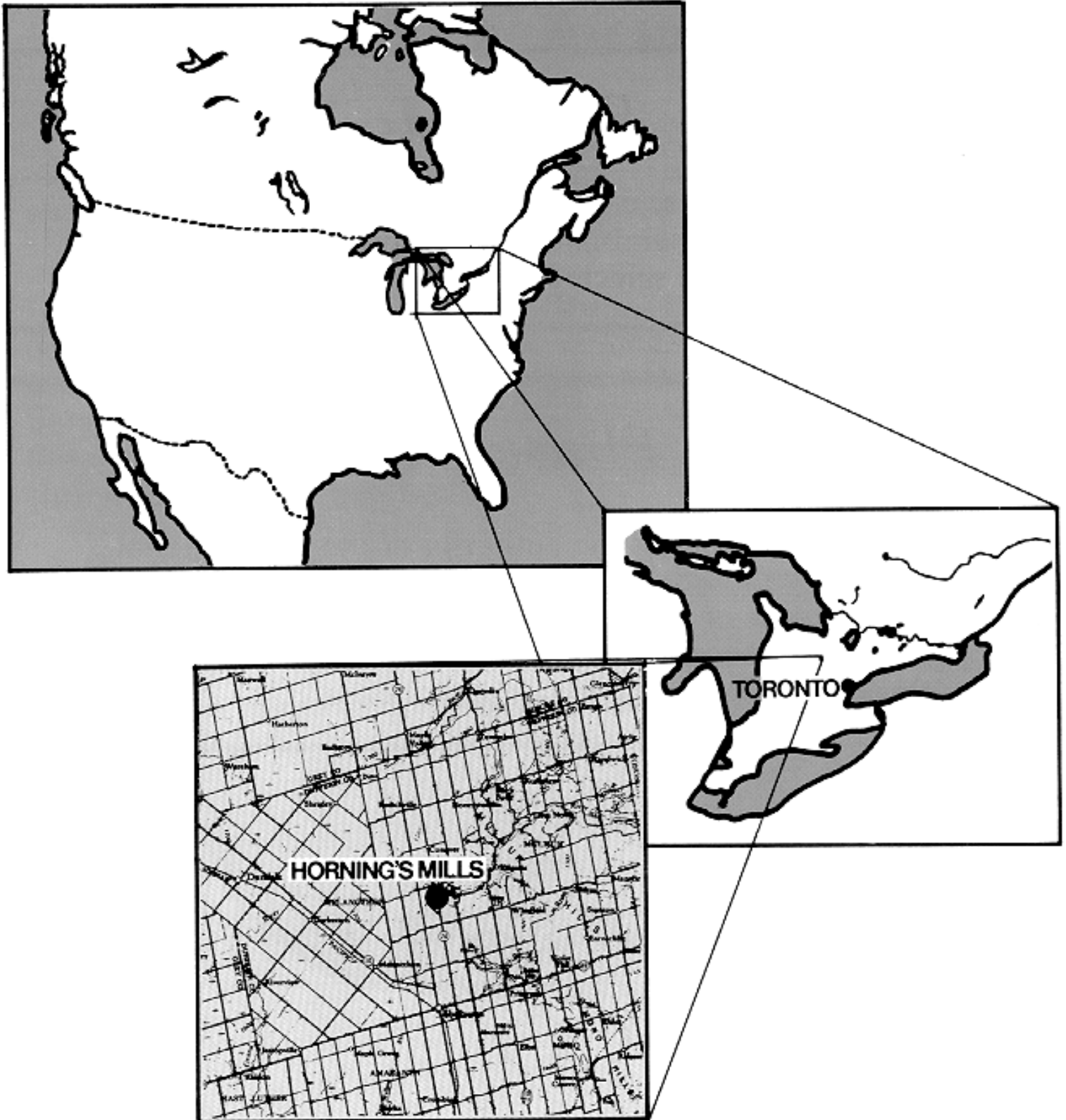
There are many, many features to the shelter that cannot be described here because it would too greatly clutter the drawing.

The shelter contains extensive alternative methods of moving air, fighting fire hazards, providing lighting, internal and external communication, and every other conceivably necessary requirement.

For example, it has a great amount of radiological monitoring equipment.

# A LOOK AT WHAT'S INSIDE





# Photos of the Inside of the Ark II Shelter

Pictures of the inside of the shelter can be seen by clicking on the links below. If you have not already looked at photos of the outside, and the *map of the inside*, you may wish to look at them first for orientation.

Many, many times I have been asked - "When will the shelter be finished and ready?" I guess the answer is that, like Disney World, it will never be finished because there is always more that one can do. On the other hand it has been "ready" since 1980. At that time there were only four buses and there was no generator or pump. We brought the water in, in stainless steel milk pails and for lights we used twelve volt car batteries. Toilets were pails with garbage bags, and we would have had to sleep on the floor in sleeping bags. Still we had all the requirements for a survival shelter as listed in the government publications.

Over the years we added water pumps and generators, flush toilets and bunks. Lighting, heating, and dozens of other amenities besides lots of additional space, security and other functionality. I think what people really mean when they look at it and ask the question is, "When are you going to put up the curtains and put around the lace doilies?" Admittedly, twenty thousand dollars of painting and new tile on the floor would make it look a lot better, but then we always think of another purpose of funds that will increase functionality and which would take precedence over cosmetic appearance. Consequently, given the opportunity to spend another twenty thousand on the shelter - there is probably something else we would do, rather than make it look better.

## Inside the Main Entrance

Inside the main entrance beyond the loading area there is a heavy steel grate door and electric conveyors that go down two levels.

## [The Top Conveyor](#)

There is quite a bit more slope to the floor than is obvious from the photo. The conveyors can operate either direction - to take things into or out of the shelter. They are powered by powerful 220 motors.

## [The Bottom Conveyor](#)

At the bottom of the second electric conveyor, which can be seen through the doorway, there is lighter steel grate which can be seen on the left, and another lighter steel entrance door which can be seen on the right.

## [The Decontamination Room](#)

The first room inside the shelter is the decontamination room. It contains a shower, a stainless steel double sink and table for decontaminating such things as vegetables, and a full-size bathtub with shower head for decontaminating children and incapacitated individuals.

## **The Generator Room**

### [The two big diesel generators inside the facility](#)

There are two large diesel generators that supply the facility. There is on-site a three month fuel storage capacity for the generators. The main generator, in the foreground, was replaced in 1999 with a new 75KW.

Either of the diesel generators will more than completely supply the facility's needs. The yellow Caterpillar back up generator is started by a hand-pull pup engine.

There is also an external 5KW emergency gasoline generator that can actually light the whole shelter or run fire fans for emergency movement of air. Other electrical supply resources are being developed.

Great advances have been made, in the last five years, regarding inverter technology and the power generation system is currently being rennovated to take advantage of these advances.

### [Main Generator being installed.](#)

The above picture is of one of the main generators being lifted in during the construction phase gives you some idea of their size.

## [Main Power Distribution Panel](#)

Here we see the main power distribution panel. It includes feeds from the outside - which we have presently disconnected, and EMP protection. Below the panel is the tunnel to the main exhaust system.

## **Air Intake and Distribution**

We have, in addition to the powerful exhaust fans, two portable large fire fans with air tubes that can be used to move air rapidly from any one place in the shelter to another. In point of fact, natural air flow seems to be adequate to supply the shelter, but we have made a variety of alternative provisions.

### [Air Intake and Blower Bike](#)

This is one of the alternative provisions for moving air. We have stockpiled a number of bikes and blowers, and we have installed throughout the shelter venting systems to which they can be attached. Next to this blower bike there is one of the large air intakes. It can be opened with just the heavy grill, or closed altogether with the steel door.

## **The Bunk Rooms and Day Rooms**

There are seven bunk rooms and six day rooms. (The adults share their day room but the women have a separate section in the facility where they can gather).

The children's bunk room for smaller children has capacity for over 90 children. In addition to this, there is a nursery, and play room.

### [Photo of A Bunk Room](#)

Bunk room occupancy is separated by sex and age. People would of course prefer to be housed by families and each person have their own private bed that they could use at any time. However, in order to get the number of people into the shelter that the government standard says that a shelter this size is supposed to shelter, we have to do this in this manner. Each of the seven bunk rooms has 24 bunks. These are shared on three shifts by adults, and 2 shifts by children.

Each day room and bunk room suite is given the name of an animal so that children can remember which is their's, or their siblings.

The suite names are:

- A (Antelope - Adult Women)
- B (Bulls - Adult Men)
- C (Cats - (or Kittens - Young Girls)
- D (Deer - Teenage Girls)



- E (Elk - Teenage Boys)
- F (Frogs - Young Boys)
- G (Gerbels - Very young children)

### [Photo of A Day Room](#)

In each of the day rooms there is storage for one's personal belongings. Each person gets a cubicle (a little square space as shown) in which to keep their toothbrush, towel, change of underwear and so forth. The size of the day room as seen in the picture is probably deceptive, and in reality it is twice as large as it appears here.

## **Wash Rooms**

There are of course separate men's and women's washrooms. There is also a laundry room with a large diaper drying facility for babies diapers.

### [Photo of Toilet Stalls](#)

There are rods to hold modesty curtains, but the curtains are not in place. Vandals broke the watertanks on the toilets. But that turned out to be a favor. The Health Department wanted us to replace them with low flush toilets - but in retrospect that would still not have been satisfactory. When the generators are off and we are working on low level lighting then the pressure pump will lose its pressure. We will have lots of water, but we will need to carry it in buckets to flush the toilets. By not having water tanks on the toilets this keeps people from emptying the pressure tank and also allows us to better control how often the toilets are flushed so that we don't overflow the waste holding tank before the next power-on pumping time.

### [Photo of Men's Washbasins](#)

In the women's washroom there are also children's level wash basins. There were mirrors above the washbasins, but vandals broke them and they have not yet been replaced. Over the years, vandals broke in dozens of times and stole or did about \$15,000 worth of damage. Each time we strengthened the security of where they broke in and it has now been several years since any have gotten in (although there have been signs that many have tried). Curiously the police and local government considered us to be the criminals, because we had made an "attractive nuisance" that attracted the vandals. They have severely punished us for this. The vandals around here, even if caught - are not punished.

### [Water Heater](#)

There are a number of hot water tanks located around the facility and there are two alternative ways of heating water, just as there are alternative ways of obtaining water, moving, heating and cooling air,

getting rid of waste disposal and so forth. Details about all the facility's systems are just too voluminous to include them all.

### [Alternate Water Heater](#)

This is one of the alternative ways of heating water. It is a circulating tank that is suspended from the ceiling and is attached to a heater plenum. How much actual water heating we will be able to do other than for food and drink, is somewhat questionable. It is highly unlikely that people will be able to take long hot showers.

## **Water Supply**

This is a good spot to discuss the shelter water supply. We are very blessed in having a river and a number of springs on the property. In years past we used a water ram from one of the springs. A water ram is a mechanical way of pumping water uphill by using the force of the water itself. We have presently dismantled the RAM and brought it inside along with a brand new much larger one that we have never installed as yet. The problem was that the ram was outside where it could be tampered with, but as of the summer of 2000 we now have an inside well and do not have to rely upon the rams. Later (afterwards), if there is no electricity, we can re-install the water rams.

### [Photo of the Well during construction](#)

On the "construction page" I tell about the miracle of the well. You can read the story there if you like but here I will just explain a bit about the well itself. Water is one of the most essential features of a survival facility. Especially one that might have 500 or a thousand occupants, and we have a sufficient supply to handle that number of people.

### [The Three Pumps for the Pressure and Storage System](#)

This picture shows the heart of the water pressure and storage system. The two lower pumps are both one horsepower pumps that together can pump better than 15 gallons per minute. We can refill the top half of our settling tank (the big 500 gallon stainless steel white tank that you can just see the end of on the right), in about 15 minutes, and then turn back off the generators. (We also have a back up hand winch and bucket).

The third pump (on the ceiling and at the very top right in the picture) fills both the big 5,000 gallon stainless steel milk tanker - (told about in a following picture) and pressurizes the vertical tank below it, from the settling tank.

In the year 2,000 when we completed the well we were, for the first time in many years, now able to keep both tanks full. (Years ago we used to fill them with a ram pump, but it was a very slow process). The

well is also what makes it feasible for us to now install a Fire Sprinkler System.

### [Steel Steps Into the Well Area](#)

These are the steel steps that go out over the well and into the tunnel leading out the back of the shelter.

### [The hand operated bucket winch for the Well](#)

Here we can see down through the steps over the well, the hand winch system which is used to pull water up by the bucket from the well, if all else fails. Every system, water, electric, waste disposal, air movement, and so forth, has several backup systems to it so that if all else fails, then there is a simple hand mechanical system that will permit survival.

### [Milk Tanker](#)

Behind the spigots and the wall that I am leaning on, there is a 5,000 gallon stainless steel Milk Tanker, like the ones you see going down the highway. Nope, we don't store milk in it, although milk is admittedly important if infants are going to survive. (For that purpose we do have stored substantial quantities of powdered milk, although we would like to have still more stored). Nope, the Milk Tanker stores water as another backup. Water that we occasionally replace, but intentionally never use. When the water gets half way down in the main settling tank - then we intend to turn on the pumps and refill that tank - so the milk tanker (which is also filled by the same pumps) always stays full and is never touched.

Both of the water tanks are higher than the rest of the shelter and therefore will feed water to anywhere in the shelter by gravity feed. We now have a hose, attached to the spigot that I am pointing at, that will reach anywhere in the shelter. Likewise there is a hose attached to the pressure pump system, in case we have power when we wish to deliver water to some remote location.

### [Fire Stations](#)

In addition to the garden hoses, when the shelter is occupied we will maintain throughout shelter manned fire stations which will have buckets of water, sand and fire extinguishers. There is really very little threat of fire, but because fire in a shelter like in an airplane or on a submarine, would be so calamitous (because one would have nowhere to go and could not leave the facility) we take extensive safety precautions.

## **Kitchens**

### [Photo of Kitchen](#)

There are actually two kitchens. The ovens shown in both of them have been removed. The ovens shown

were industrial size and had been equipped with new elements. However, it has been decided that they would be an inefficient use of energy, and therefore fuel, and so consequently they have been removed with plans to replace them with a more efficient system.

### [Photo of Sink Room](#)

The second kitchen is primarily used as a sink room for doing the dishes.

There are also two locked rooms with grate doors for the storage food, besides other bulk food storage areas. The community has developed and is continuously implementing extensive plans for the storage and production of adequate food supplies.

## **Other Rooms in the Shelter**

There are MANY other rooms in the shelter. While the pictures included here give one a flavor of the shelter environment, you must really study the shelter map to get an idea of its immensity. It is so large that maps are posted throughout the shelter to tell one where they are and how to find their way to another location.

### [The caged electronic Repair room](#)

Adjacent to the caged electronic repair room is the transmitter room. We used to have four large transmitters (each about the size of a refrigerator) in the room, but after 15 years they became obsolete and we removed them a couple of years ago and have not yet replaced them.

Behind the repair cage, and down the hallway beside it, there is a glassed-in broadcast room, and behind that a chapel.

### [Pharmacy](#)

The pharmacy is another caged area in the shelter.

### [Computer Room](#)

Like many of the rooms in the shelter, the computer room currently consists of only desks and chairs. We hope to move-in at the last minute, computers and many other types of equipment (such as microwaves, tools, supplies and so forth). In the past, many types of equipment that we have stored have deteriorated because of the prolonged exposure to underground humidity.

### [Dental Room](#)

The dental room has been a prime example of the problem of maintaining systems in the shelter. Vandals broke the X-ray (we have a replacement in storage) and humidity has caused considerable rust on the chair. We have left the chair in place because it is so heavy to move and we feel that we will be able to clean it up once we activate the shelter, .

Some of the many interesting rooms, for which photos have not been included, are:

- The Surgery (as yet still unequipped)
- The Laundry room
- The Silent Library (books are in offsite storage)
- The Conference Room
- The Tool Room
- The Chapel
- The Exercise Areas
- A Privacy Room
- The Nursery and its Cry Room

and numbers of still others as you will see on the map.

**MENU:** [HOME](#) » [SURVIVAL](#) » [Index of States](#)



















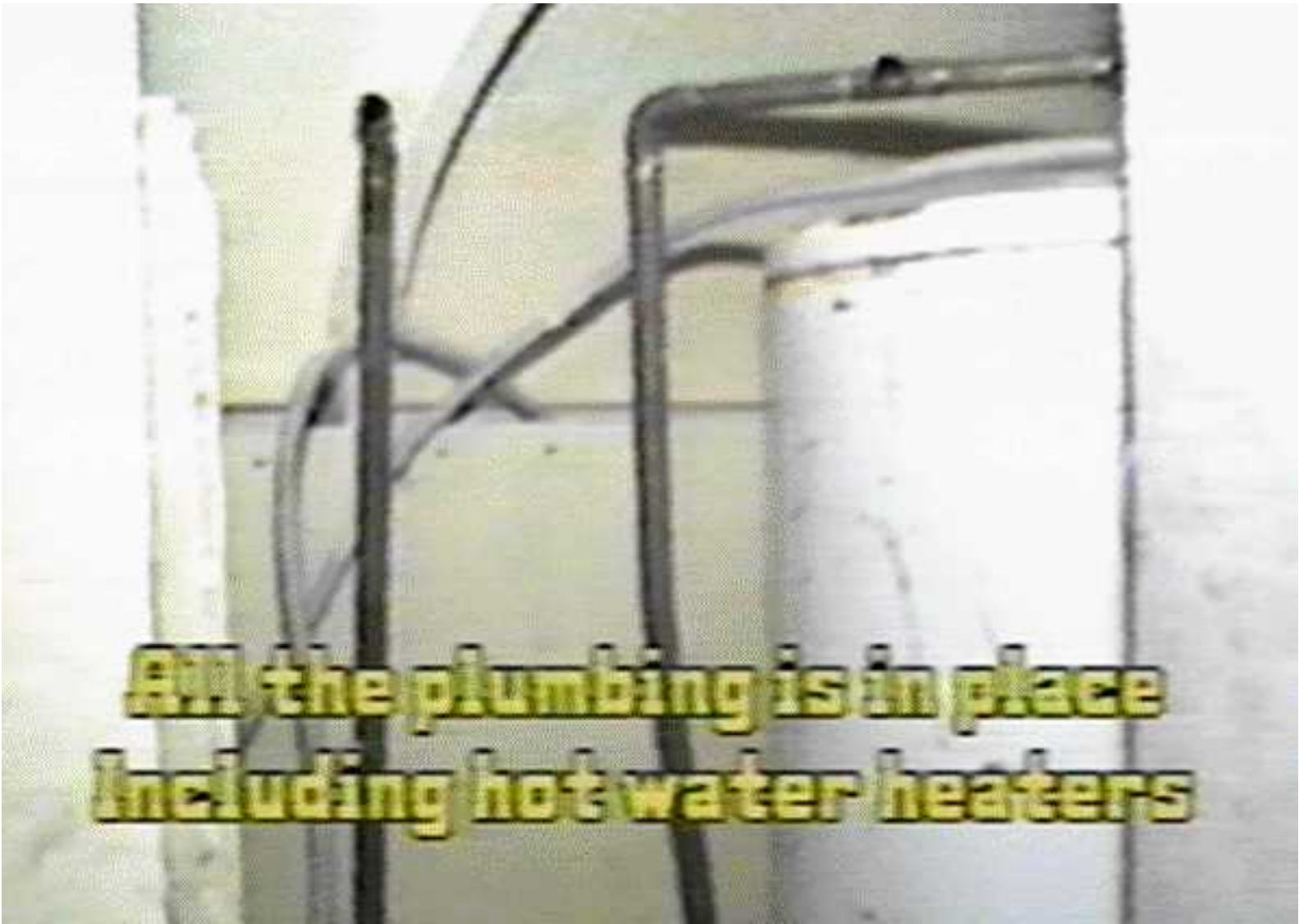


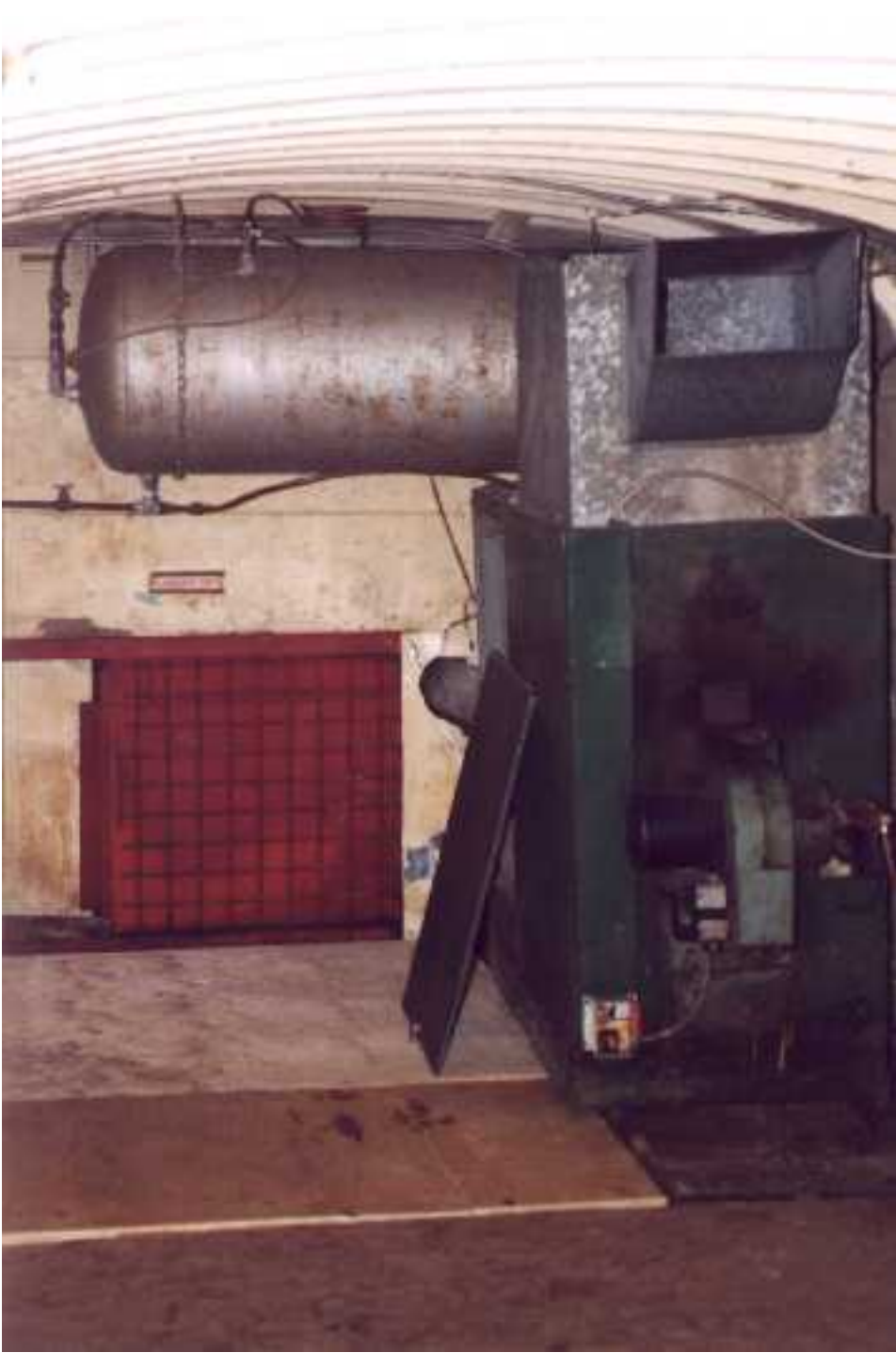


**The Men's Washroom  
& Showers**



































# April 25, 2001

## Outside Views of

# Ark II



### **The Front Gate**

From the front gate gate of the property one cannot actually see the shelter area, (or even the second tall gate) although a new tall tower and some tall fence posts at one end of the property are now visible over the berm."



### **Front Gate Lock**

This is only the first locked gate that one has to go through, to reach the shelter.





## The Road In

This picture of the road in was taken last summer. It becomes impassable during snow storms unless we use snow removal equipment, and then it takes about an hour and a half to clear it and the parking lot.

---



## Outside the Tall Gate

This is the second gate that one passes through in approaching the shelter. The fence is ten feet high, but the gate is much higher in order to allow semi-trucks to pass through.

---



### **The Tall Gate from Inside**

This is another view of the tall gate from the parking lot inside. In the background you can see the berm that conceals the shelter from the road.



## **Bike Supply**

This is the five-speed bike supply that we maintain in front of the shelter. These can be taken inside later to do such things as drive blowers that we store inside the shelter. They can also be used for other purposes such as running the wheat mill or even to generate low level lighting. There are numbers of other stockpiles around the shelter. Such as fuel bunkers, woodpiles, lumber and steel storage, and so forth. Bikes for transportation are kept in another storage location.

---



### **Main Entrance from the Parking Lot**

This is the front entrance (which is also actually the loading dock) from the parking lot. In the background you can see a couple of the air-intake towers.



## **HEAVY STEEL Double Locked Front Door**

We have no explosives in the shelter but several persons who have been in the explosive business have likened the shelter to the security of an explosive bunker. Before we put up the high fence, vandals used to damage the lock by putting glue in it although they have not gotten the door open since we put two locks on it several years ago, and now with the lock protector and the high fence about the property, it is even more difficult to get into.

The individual door is actually set inside a pair of wide opening steel doors for bringing in supplies and putting them on the conveyor from the loading dock. Inside these steel doors there is a heavy iron gate, and beyond that before entering the shelter, another steel door. One has to go through two steel doors to gain entrance to the shelter from any entrance or air shaft.

All the external doors open outward, at the insistence of the Fire Marshal, except for the loading dock doors. This latter is so that the occupants cannot be blocked in from the outside, although there are also other escape routes.



### **The Back Entrance**

The back entrance to the shelter is heavily bermed about as protection from a possible but improbable target fifteen or twenty air miles away. The door itself faces away from the target. The shelter is theoretically designed to survive a mile and a half outside the crater of a nuclear weapon. A theory that I hope we don't have to test even at fifteen or twenty miles.

---



### **Inside the Back Door**

From inside the back door you can see the two separated steel doors at this entrance and the steel steps between them leading down to the tunnel going into the shelter.

---



### **The Steel Tunnel from the Backdoor**

Once past the two steel doors at the back, there is a steel tunnel (with more slope than the photo appears to indicate) leading down to another set of steel steps that go on down into the shelter. The front entrance was made wheelchair accessible at the Fire Marshal's insistence but the back entrance consists of steel steps and the four emergency exits through the air-intakes have steel ladders.

---





### **Hilltop View of the Compound**

Looking down from a higher hill on the property one can see the entire compound. The prominent features in addition to the entrances are the surrounding 10ft high fence with its front and back gates, along with the tanks over the airshafts. The whole compound stands above a very high ravine.

---



### **Main Powered Exhaust**

Although there are many others, the main powered exhaust for the shelter exhausts out over the ravine. Natural air flow might seem to be to pull cool air in from the ravine and to exhaust warmed air out the top, but because we are dealing with fallout we want to pull the air in from as high above ground level as possible, and exhaust it out at the lower level.

---



### **Looking down from the exhaust fans**

The camera fails once again to give an appreciation of the depth, because the river is actually about 150 feet down from standing on the exhaust fan cabinet, from which this picture was taken.

---



### **Generator Room Air Shaft Tower**

The air shaft housings are taller than a person and 8 feet in diameter. The air actually enters through a heavily screened pipe which faces down on the side. In this way, fallout will not fall into it. An actual air intake pipe is most easily seen on the air shaft tank in the background of the photo of the front entrance.



### **Air Shaft Tower**

**Inside each of the airshafts towers there is a vertical shaft that has in it a steel ladder.**





### **Inside the Generator Room Air Shaft Tower**

**All the air shafts towers are pretty much alike. This is the one for the generator room with its door open.**



### **Inside the Generator Room Air Shaft**

**Through the open door of the generator room air shaft tower, one can see an additional small (5KW) gasoline powered generator that is maintained OUTSIDE the shelter. The reason for this is that if there should be an emergency involving the main generator room, then we can provide power to air fans. This generator may be moved to any of the air shafts where it may be required.**

**The large fuel tank seen through the doorway was removed on the Fire Marshal's orders.**

**Adjacent to this Air Shaft is a highly insulated and muffled exhaust for the main generators down in the shelter. It is so quiet that one can stand right next to it and carry on a conversation in a normal tone of voice.**



**One of a number of typical exhaust vents.**

**There are a number of exhaust vents located around the shelter. Each of the vents have a cover and a protective barrier around them (because we have otherwise often damaged them driving over them with a tractor or truck).**

---





### **Locks on the exhaust vents**

**All the exhaust vent caps are locked on. Like anything else, with enough time and effort they could be broken into. However, even if one were to hacksaw off the lock, there is no access to the shelter through the air exhausts. At the bottom of the one foot diameter pipe there are usually five inch pipes that run off a distance of five feet to the shelter.**

---



## **Road Beside Small Fuel Bunker #2**

**The road has actually been graveled since this shot was taken last summer.**

---



## **Entrance on Small Fuel Bunker #2**

**This is the entrance way to a small fuel bunker. There is NO access from the fuel bunker to the shelter.**

---



**Door on Small Fuel Bunker #2**



**Entrance on Small Fuel Bunker #3**

**This is the entrance way to another small fuel bunker. Again there is NO access from the fuel bunker to the shelter. This fuel bunker actually doubles as a morgue, and the main fuel bunker as a brig.**

---



### **Observation Tower**

**At both corners of the compound there is an observation tower that is higher than the fence and which gives a view down both fence lines and to the opposite observation tower and the perimeter access roads. The Fire Marshal has requested that we provide outside storage for certain materials presently in the shelter, and for this reason we have had to build the pictured facility, and are in the process of moving the materials to it. Both this structure, and the fence have actually been built at the Fire Marshal's request but since we were having to build them we have sought to make them useful.**



The fence was ordered by the Fire Marshal simply for the purpose of keeping vandals out, with the concern of protecting the vandals. Many improvements about the shelter have been at the Fire Marshal's insistence, such as the large tanks over the air vent escape hatches (to keep them free from snow) and the additional entrance/exit at the back of the shelter. While the total expense has been very large and we had not included them in our original design we are nevertheless pleased with these additional improvements.

It has been an interesting challenge to build the Ark, but as you can see - so far I have survived it.

**MENU:** [HOME](#) » [SURVIVAL](#) » [Index of States](#)

# Photos of Construction

For **free** consultation on how to build your own shelter (and other **free** nuclear survival information) by the only non-governmental RSO (Radiological Scientific Officer) in Canada [CLICK HERE](#).

## Construction

Our reason for going into such detail about the construction of our shelter is not just to show how large and strong it is but to let others benefit from our experience.

This was the 24th shelter that the designer has personally built. He has used in other shelters almost every material and method imaginable. Wood structure and sandbags, gunite, corrugated metal, steel construction, steel tanks, concrete forms, and concrete block. The best method found to date has been the use of school buses as forms.

Mind you, one learns from experience, and there are still many things that would be done differently another time around. Mistakes had to be corrected - that now with the experience could be avoided. Still, all in all, the assessment of the Federal Government shelter inspectors who came from Ottawa to view the shelter that, "This is the best shelter that we have ever seen!", seems to be accurate.

### [A GREAT DEEP HOLE](#)

To begin the facility, we first dug a DEEP hole. How deep the hole was, you can get an idea by looking at the road the concrete truck has to go up in the above picture. All the shelter lies below the truck and the big pile of dirt behind the truck is a very small part of the fill from the hole that was pushed back over the shelter.

### [A MOUNTAIN OF BACKFILL](#)

The mountain of backfill gives you another idea of the depth of the hole, when you see the road used to bring the buses down into it.

### [A LINE-UP of BUSES](#)

Here is a picture that shows all the buses being lined up in the hole. The far bus is just being jockeyed into place. On the left of the picture are stacked up forms that are placed around the whole complex. If the buses are accurately placed, each bus acts as a form for the next, and the concrete just fills in between. This is what makes this mode of construction so strong. It is formed like a beehive, with many, many, strong cells. The civil engineer who guided this construction was the engineer who designed the subway system in Toronto and he felt that the concept resulted in an IMMENSELY strong shelter. Especially with the immense amount of reinforcing steel that we put in and the extra strength concrete that we used.

### PREPARATION of the BUSES

Here you see how the buses are completely gutted and stripped before being brought to the site, so as to cause no environmental damage. Their engines, transmissions, gas tanks, windows, and so forth, have all been removed at another site. They are brought to the site on their rear wheels only, and then the same tow truck takes those wheels away with it. If you look at the bus in the bottom of this picture you will see how all the windows have been sealed with fibreboard. After the concrete is poured, the fibre board and the buses remain in place. Only the outside forms will be removed.

### FORMING and BRACING

Here you can see the outside forms being put in place and how strongly they are braced. This is VERY necessary. The buses are also greatly braced on the inside. Multiple 2 by 4's hammered together to make 4 by 8's and larger, running the length of the top inside and the floor of the bus with the same type of vertical bracing between them every 4 feet. NECESSARY, NECESSARY, NECESSARY. There is also cross bracing, at TWO levels every four feet. All this bracing is of course removed after the concrete is poured, and the AFTER the backfilling is done. The bracing is then used to build bunks and interior walls. There is not too much.

### START of the POUR

Here you can see all the buses parked tightly together, and the concrete being poured in between. The framing of doors between the buses must also be securely braced. The importance of STRONG bracing EVERYWHERE can not be over stressed. The concrete is poured over the whole complex bit by bit. Some on every side of all the buses. This is important because otherwise the weight of the concrete would cause the buses to move. Between all the buses is HEAVY wire netting to reinforce the concrete, and because this was private construction we were able to force down in TONS more of scrap steel to further reinforce the concrete.

### CLOSE UP OF CONCRETE POURING

Here you can see a close up of the pouring of the concrete. Notice the wire reinforcing rod over the top of the shelter. Every so many feet plastic and tin also had to be laid to create expansion joints. The big

pumper was rented for a week, at \$10K per week, and many concrete trucks were necessary to keep it serviced. One at the pumper, one waiting, one or two on the way back to the mixing yard. One at the mixing yard. One or two on the way to the pumper. From early morning till late at night. Make sure you pick a week of good weather. Talk with the airport meteorologists.

## [ONE BIG CONCRETE BLOCK](#)

The one bus being formed up separate from the others is the fuel bus. The rest of the buses end up in one big concrete block, which then must be kept dampened and hosed down for a month to let the concrete set. After the outside forms are removed everything is sprayed with heavy black water proofing (we have never had a leak) and then the bulldozers move the top cover back into place, and after giving everything a week or two to settle we remove the interior bracing. In the following picture there is a corrugated pipe that extends up into the air to the left and in the foreground in front of the workmen. The back fill around this pipe will end up about a foot from the top so you can see how far underground the shelter is after the backfilling.

## **The Miracle of the Well**

[Inside Photo of The Well](#)

[Photo of The Well During Construction](#)

[Photo of The Well During Blasting](#)

These photographs were taken when the inside well was still under construction - but it we completed it in the year 2000. It was a project that had been ongoing for over a decade. The well is wonderful, and I do consider it a true miracle - (just getting it paid for was one alone).

It was a miracle finding the right person to do it. He had been raised in this area and had family here, so answered my ad on the government employment net - just on that whim. He now lives in Northern Ontario and holds 14 mining tickets - including dynamiting. When the Safety Board was called in on us, the inspectors just shook their heads and said we were doing everything right.

We decided on the spot for the well before we ever put in the first bus over 20 years ago. My son Bonnar was the best in our family at water witching - (it is just a word - nothing to do with witchcraft, magic or any such thing - I now understand how it works scientifically) and we had him go out and survey the land.

This is the best spot for the well he said - but it was not where I really wanted to put the shelter. Well, try again I said. Three times we tried and he always picked that spot. Oh well, said I, this will do well for the well.



We lined up the first buses to that spot - and placed the water settling tank facing it. But immediately over the well location, I did not place cement - so that I could dig down through the dirt. And dig I did. Down, down, down. Thinking the water would only be another foot or two.

When the Fire Marshal ordered us to put in a back door, this was the area where it needed to go also, so I thought to just bring it in over the well and have the backhoe dig out the well for me at the same time. We brought in a 7ft in diameter big steel tank for the well casing and I had the backhoe dig down 20 feet to place it.

BUT, we ran into rock, so I had the well casing set on the rock, and later started digging under it. Eventually I put a concrete ring around under the casing to connect it to the rock. (Didn't do as good a job as I thought and we eventually had to scale away quite a bit).

Over the years I tried to dig the hole down further and further. First tried drilling and placing dynamite. But the first dynamiter I got years ago was terrible - and time and again I had to go down and dig out the dead heads. Had to stop that before I became a dead head.

Volunteer crews came and with jack hammers and we pressed on downward. Finally got down to 35 feet several years ago. In sort of an ice-cream cone shape - but no water. Decided that Bonnar was wrong. We know where the water comes out the side of the cliff in a spring, (which was the source we had been using) so we had the surveyor come and survey a tunnel path for us to there. We would dig the vertical shaft down and then tunnel over to the spring.

The water is at fifty-three (53) feet, the surveyor said, but he felt we wouldn't have to tunnel, because he thought we would hit a water table.

In the Summer of '98, the new blaster came and blasted away the thick concrete wall that had created a narrow door between the shelter and the well. We poured a new concrete supporting post, floor and wall and were ready to start.

Then in 2000 he came and widened the well to five feet all the way down from below the 7 ft concrete collar. We rented a tractor, and he brought from up north a marvelous winch to go on it. Also he brought powerful miner's drills, and two great helpers.

He thought they would do eight feet a day, but it averaged out to more like eight inches a day. Finally, weeks later we reached water at 52 feet and 10 inches. Just where the surveyor said we would. It is in a stream about the thickness of a broom stick, that came in through the wall, at the rate of a little over 6 gallons per minute.

We dug down another four feet to create a reservoir, and hollowed out the sides to capture 1500 gallons of water. Then we drilled around the incoming jet of water, to increase the flow. We drilled all around it

everywhere in a six inch circle. to a depth of four more feet back into the rock, but they were all completely dry. And we drilled all around the rest of the well. But this was the only real source of water and it came in only that one stream.

If we had put the well over a few feet in any direction we would have missed it. Thank you Bonnar.

The pumps are now installed. Two one horsepower pumps that together can pump better than 15 gallons per minute. We can fill our settling tank in about 30 minutes, and then turn off the generators. (We also have a back up hand winch and bucket).

A third pump fills the big stainless steel milk tanker - (like you see on the highways) that we have buried underground.

For the first time in many years, we now have both tanks full. (Years ago we used to fill them with a ram pump, but it was a very slow process). The well is also what makes it feasible for us to now install a Fire Sprinkler System.

The well ended up costing over a hundred thousand dollars. But its donation is also part of the miracle.

### **Current and Future Projects**

There are always on-going construction projects to improve the facility. While we consider the facility ready there are always more items that come to mind for equipping it.

**MENU: [HOME](#) » [SURVIVAL](#) » [Index of States](#)**

# Radiological Scientific Officer

On [another page](#) you will find links to all sorts of shelters, if you need additional free help, you can **E-mail me for free consultation.**

While previously, I would have been glad to chat with anyone, about any ideas, the interest has now become so great, and the requests in such number, that I wish to restrict this FREE service to those who meet the following three requirements:

1. They wish to build a shelter IMMEDIATELY and they are not merely "thinking" about it.
2. They already have a place where they can build it.
3. They have some amount of monetary resources they are allocating to the project.

If you meet those three requirements and wish my FREE assistance, please write to me telling me:

- a. your location
- b. describing the nature of the property you have available
- c. any plans you have in mind
- d. what monetary resources you have available  
- no matter how limited.

If I can help you in this way:

**E-mail me for free consultation at**

[survival@webpal.org](mailto:survival@webpal.org)

The old man himself!

.  
.  
Bruce Beach  
January 1998

I am the only non-governmental Radiological Scientific Officer in Canada. I graduated second in the last class that was taught. The pre-requisite for the course was supposedly a Ph.D in physics plus the previous required courses which I had completed with top grades.

While I did not have the required degree I had the good fortune to room next to the top student in the class who permitted me to study with him each evening and sit with him at each meal. We also sat next to each other in class and therefore were always able to team up on in-class projects. It was through his great assistance that I managed to come in second. Prior to that course I had taken three previous government courses. The first in the U.S. and the second and third in Canada. I had also graduated as the Honor Student from a specialized USAF AACS school and based upon this, and work experience with the Western Electric Company as an engineer, was *offered* a high paying job as a civilian doing the acceptance inspection for the USAF nuclear missile sites, *which I declined*.

Over the past many years I have built 24 shelters ranging in capacity from one person to 500. These have been of almost every design conceivable, and I have also consulted on a great many others. I have also written a widely distributed booklet entitled, [You Will Survive Doomsday](#), which is available to you FREE for the downloading.

In fact, I probably became the most *notorious* shelter builder in the world. Several major newspapers, in both the United States and Canada, have done multiple page articles about me. There was an article and picture on the front page of the Canadian national newspaper, and there have been articles about me in the national magazine. As recently as March 2002 I was featured on the front cover of a national construction magazine. Over the years there have been dozens of other newspaper and magazine articles, plus lengthy TV shows, and I have spoken on more radio shows than I can count, often being interviewed by phone from thousands of miles away.

I taught a college course on survival and have been the guest speaker at other college's survival courses and numerous conferences on survival. All told, millions of people have heard me or heard about me, including thousands on a face to face basis in various presentations and shelter tours. I have even been the subject of a post-doctoral dissertation by two Ph.Ds from the University of California who referred to me as the "dean" of American survivalists.

You probably cannot *imagine* the number or variety of survivalist groups that I have met with and heard their ideas. I have also, at one time or another, talked with most of the survivalist leaders in North America and have read many, many volumes of ideas and thoughts on the subject. At this point I am surprised if I hear anything new.

Interest in this subject has come in waves. The Berlin Wall crises, the Falkland Island crises, the Gulf War crises, some particular movie or some other event. Presently, interest is growing again because of activities in the Middle East and as the reality is sinking in that the nuclear threat has never been greater since the time of the Cuban Missile Crisis.

Over the last many years, my wife and I have distributed *free* well over one hundred thousand booklets to try to prepare people for a nuclear holocaust. We have *never* charged a dime for doing this. My position is that I cannot play God, deciding who I will help, so I cannot put up the barrier of money in refusing to help someone, therefore I offer the help freely to everyone.

This has already seemed like a lot of breeze but if you would like to know still something more about me personally, and my other interests, then you can

[link to my personal web page.](#)

**MENU: [HOME](#) » [SURVIVAL](#) » [Index of States](#)**

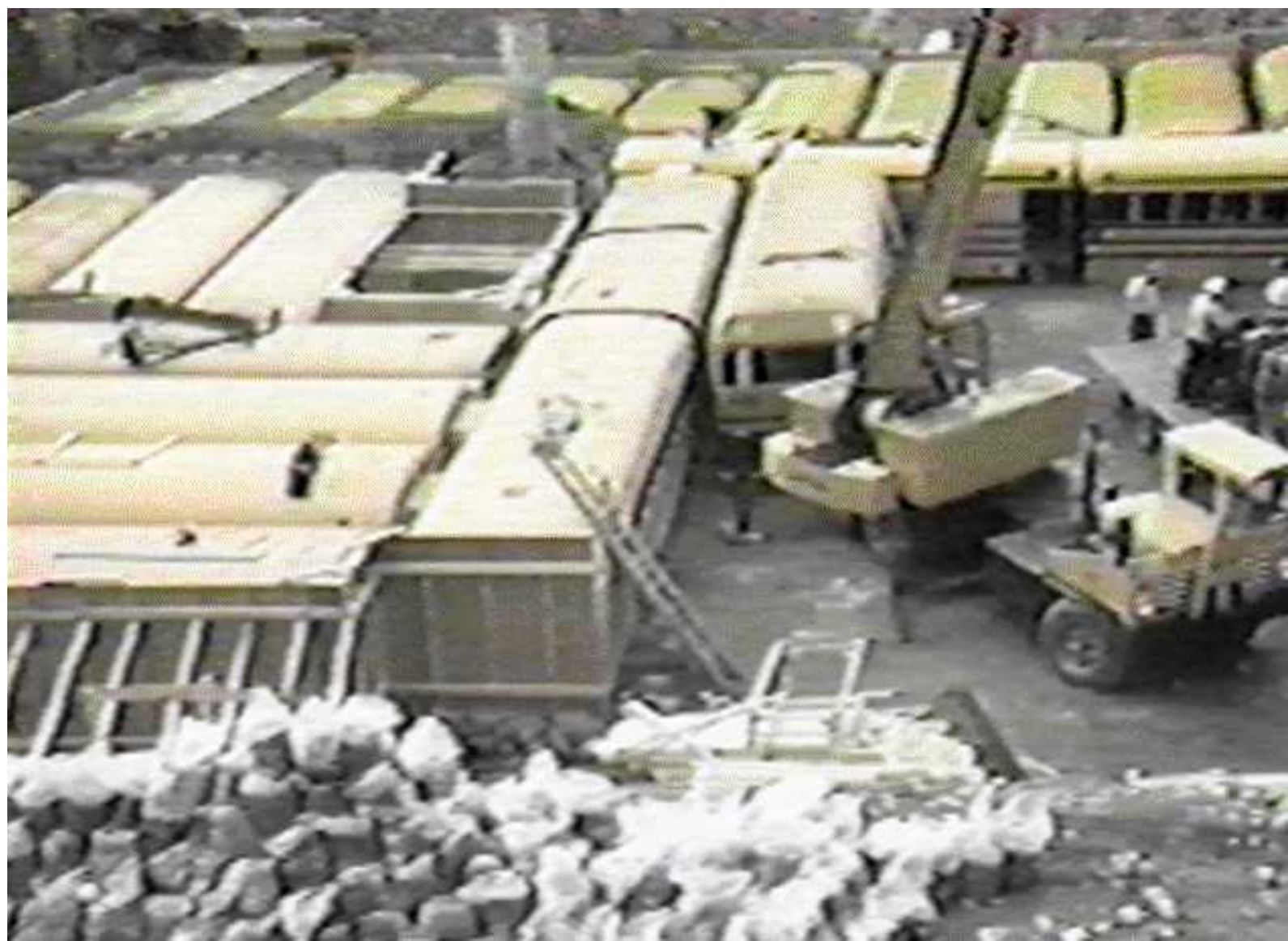






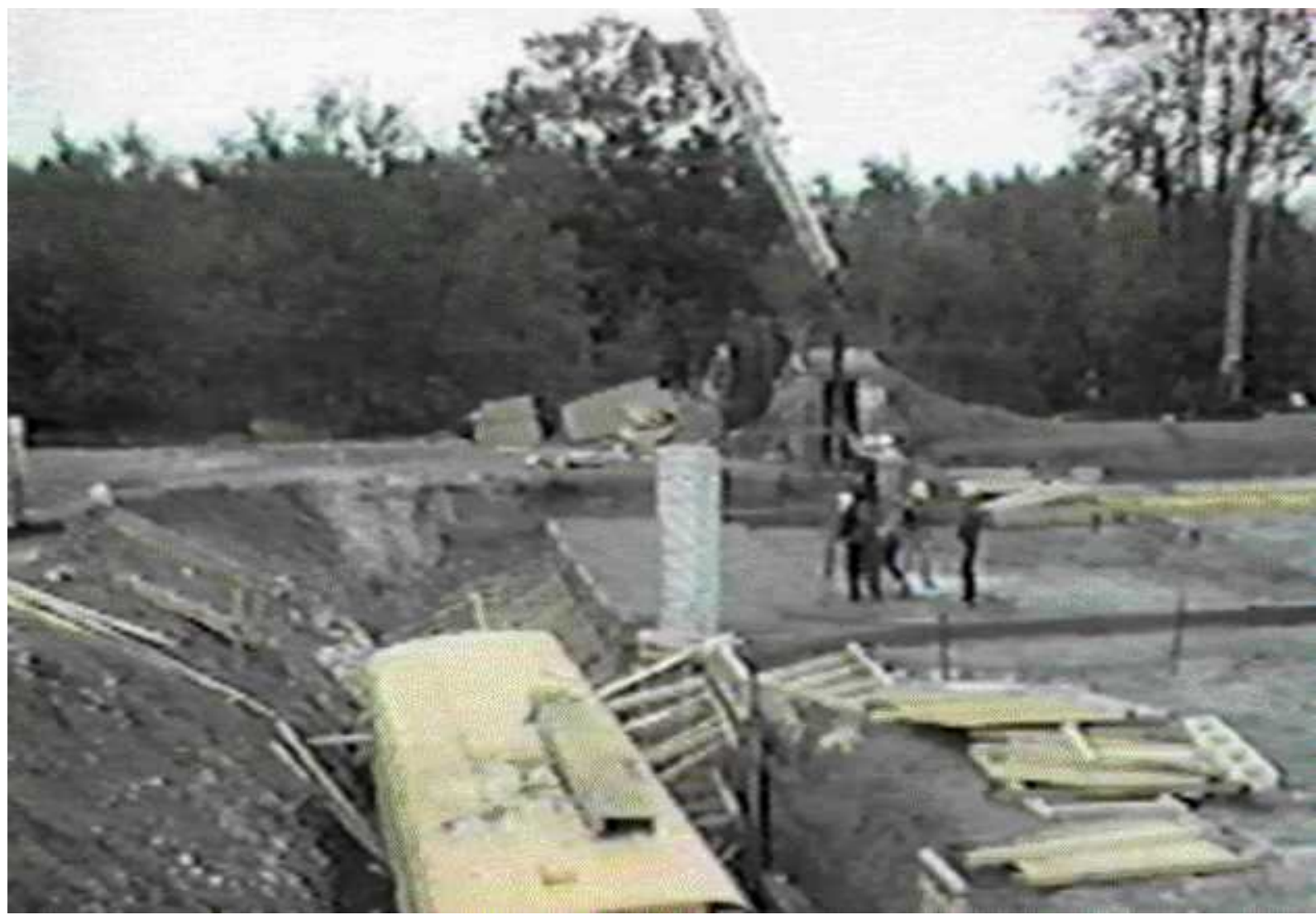




















## Life in the Ark Two Community

The Ark Two Survival Community is NOT a Commune. Nor is it based upon any particular religious or political concept. It is a pluralistic community that welcomes members from any religious, racial or cultural background.

Except in times of CATASTROPHE the community remains loosely knit. Members of the community can live at a distance, (although this is not recommended) and come to the facility if they feel that a catastrophe is imminent.

For information about the Ark Two Programs

[click here](#)

No one lives in the facility, although several families live nearby. The community tries to develop TEAM leaders with different types of expertise, and the Team leaders generally live within the vicinity.

For information about the Ark Two T.E.A.M.s

[click here](#)

Ideally, new members of the community would purchase or rent their primary home, (or a secondary home such as a resort cottage) within 20 miles of the facility. This, however, is not a requirement. The reasoning behind their having such a home location within the area, however, is that they would be near to the facility, should an emergency occur, and that they would have a base from which to re-establish their lives, during the reconstruction period after an emergency. We are located 90 miles northwest of Toronto, and Canadian Law changed in 1998, so that U.S. residents can purchase property in Canada, without tax penalty, and can reside here, only having to cross back over the border once every six months.

Use of the facility is anticipated in the worse case (an all out nuclear war) to be short term. By this we mean a period of from 3 weeks to six months. The facility would continue to be used as a resource for such functions as community administration, communication, and the ongoing work of agricultural recovery. It would also still be available as a refuge for any other emergencies, such as temporary social disturbances and so forth. Under the nuclear scenario, it is possible that children may need a longer period of sheltering for their sleep periods, than would adults.

Under other scenarios, such as Earth Changes, there would be other uses of the facility. One basic

scenario would be as a refuge from social disturbance and a base for the restoration of agriculture. In this latter regard the facility has fenced off, with a five foot fence a separate protected area for agriculture. The headwaters of the Pine River run through the facility as a water resource, and there are large ponds available.

Key to agricultural recovery is the necessary expertise. Member families of the survival community have farmed on this same land since before the beginning of the last century. It is anticipated that a situation may require labor intensive farming, of the gardening type, that members of the survival community presently maintain. There is sufficient land to provide new members their individual gardening plots, or to let them participate in joint community efforts at food production.

More central to agricultural recovery, is that the whole surrounding area is a well established agricultural community that has been VERY productive over many decades. Nevertheless, in anticipation of EXTREME conditions, preparations have been made for hydroponic seed germination and other such approaches.

For those concerned about Earth Change scenarios, it should be noted that the survival facility is located on the highest level of land in Ontario, far above any possible flood plain. That it is built upon an area of solid pre-cambrian rock, which has suffered no historical earthquake damage, and that the shelter itself, being underground, provides complete protection from any form of radiation, solar or otherwise. Any other personal concerns in this area will be addressed upon request.

During a Catastrophe the shelter operates much like a ship or submarine. There is a shelter commander and crew to maintain its operation. During the state of immediate emergency the shelter is NOT operated as a democracy. In order to protect the maximum number of people, the occupants are separated by age and sex. This admittedly concerns some people, but it must be remembered the facility is a Life Boat, not a Luxury Cruise Liner.

During an emergency, the adults have duties and are only permitted 8 hours per day of bunk time. They will be very busy the rest of the time. Young children and infants, are encouraged to sleep 12 hours a day, so as to reduce activity in the shelter. Nevertheless, in order to accommodate the maximum number of persons, that Canadian Government regulations permit in a shelter this size, it is necessary that all the bunks be assigned for shifts of a fixed number of hours per day, and that on alternate shifts someone else will have to use the bunk. This is the reason the sleeping arrangements have to be assigned by sex and age.

Community organization, aside from the time of emergency, will have to be determined by the community and the circumstances. In a scenario that is not too severe, individuals in the survival community, may simply return to their previous homes and something approximating their previous life style. In a more severe scenario, the members of the survival community may simply merge into the larger surrounding community and whatever response that community makes. In a very severe scenario, the members of the survival community may have to organize themselves into some sort of longer term

continuing entity. All of these responses are hypothetical and there is no need to overly speculate upon them until such time as one sees what the circumstances dictate.

The key to a successful experience in the survival community, is your participation ahead of time. Participation in the TEAM activities, of preparing for contingencies ahead of time. Becoming acquainted with the TEAM leaders and community members, so that you know them, and that they know you. The basis of this community is built upon a Spirit of Service. Those with that spirit will find that they fit right in and that their participation will be greatly appreciated.

If you want to know more particulars about this community, you can contact any of the [TEAM](#) leaders or [The Community Coordinator](#).

If for some reason you feel that this Survival Community is not the one for you, then you should find another more suitable community. To assist you in that we used to have a [list](#) of hundreds of survival groups and communities in North America. However, circumstances have changed and it is now much more difficult to find and make contact with other communities. Whatever you choose to do, we HIGHLY recommend that you join SOME community, if you believe there is an imminent danger, because your chances of survival are greatly enhanced by being in a community rather than being on your own.

---

**MENU: [HOME](#) » [SURVIVAL](#) » [Index of States](#)**

# The Ark Two Community Nuclear Holocaust Recovery Programs

<p style="text-align: center;">*</p> <p style="text-align: center;"><b><u>Introduction to Ark Two &amp; Overall Purpose</u></b></p>	<p style="text-align: center;"><b><u>Free Shelter Consultation &amp; Nuclear Survival Info</u></b></p>
<p style="text-align: center;">**</p> <p style="text-align: center;"><b><u>Agricultural Recovery</u></b></p>	<p style="text-align: center;"><b><u>Radiological Monitoring Equipment</u></b></p>
<p style="text-align: center;">***</p> <p style="text-align: center;"><b><u>Economic Recovery</u></b></p>	<p style="text-align: center;"><b><u>KI Information and Support</u></b></p>
<p style="text-align: center;">****</p> <p style="text-align: center;"><b><u>Refuge and Recovery Maps by State</u></b></p>	<p style="text-align: center;"><b><u>Family Finding</u></b></p>
<p style="text-align: center;">*****</p> <p style="text-align: center;"><b><u>Information Broadcast</u></b></p>	<p style="text-align: center;"><b><u>Social Restoration</u></b></p>

**Purpose:** Anyone is welcome to join the Ark Two Survival Community (located in Ontario,

Canada) - so long as they do so before the catastrophe occurs. There is no charge for membership nor any restriction other than one be tolerant of the other members. However, it is only practical to be a member if one makes arrangement to live within about 20 miles because it would not otherwise likely be possible to get to the Ark ([see pictures](#)) at the time of catastrophe.

The purpose of the Ark Two Survival Community is to ameliorate the effects of a Nuclear War and to help reorganize society afterwards. The community founder believes that a nuclear war is inevitable and therefore in 1980 built the first phase of the Ark Two Refuge and has since expanded it and established the following programs.

The project has not been favorably received by the local and provincial governments. By 1990, when I stopped counting, it had been subject to over 30 court and commission appearances and the number has greatly increased in the last few years. Legal costs have mounted to hundreds of thousands of dollars. In 1999 there was a raid without warrants involving 7 police vehicles, 4 fire units and over 40 personnel and a K-9 unit, coincidentally caught on video tape by the CBC. Subsequently the facility was hounded with repeated government inspections. Some of the inspectors candidly admitted that it was just harassment, but because of wanting to keep their jobs they of course were not going to put that into writing. It is for this reason that one might refer to the facility as Waco North. A kinder, gentler Canadian version in that The Ark doesn't have any weapons and in that so far no one has been killed by the raiders.

The general public views the project as being operated by an eccentric (in the most favorable terms) or by a nut-case in what is the more usual expressed attitude. For the forty years in which I have built over two dozen shelters and have consulted on many dozens of others, the general ridicule has been extensive, to say the least. "Why do it then?", I have often been asked. Why not get a life, enjoy life and quit worrying about doomsday? The answer is that I don't see the purpose of life, nor happiness in life measured in how many rounds of golf I might play, but rather in service to my fellowman. While I don't have any "visions" or hear any "voices" this appears to me to be the service to which I have been called.

It is my hope that the programs described below will save tens of thousands of lives and will be useful in restoring society and making people's lives better after the nuclear holocaust.

Click here to return to the  
[Table of Contents](#)

---

***Survival Education:*** For over 40 years the Ark Two Community founder has run a large variety of nuclear survival education programs. This has involved the printing and distribution of over 100,000 printed copies of [FREE books and booklets](#). Now, with the Internet, some of these are available right at this web site to untold numbers of more people for free downloading.

He also provides FREE [consultation](#) on shelter building.

In the process of trying to educate the public he has appeared on dozens of TV programs, dozens of radio shows, and has been written about in a great many magazine and newspaper articles. Many millions of persons have heard about his efforts.

The Ark Two Community has a librarian who has done a magnificent job of compiling on CD ROM, Microfilm, and in other media, thousands of volumes of practical and semi-technical descriptions of technology that we hope will be useful after a nuclear holocaust. We hope to be able to widely disseminate this information after the holocaust.

We have also assembled survival guidance material to handout at the door of the shelter to people for whom we have insufficient room in the shelter to accomodate. In December 2001 we completed a series of 4 videos, on such subjects as building an expedient shelter, which we hope to be able to show to the same group of people.

Click [here](#) to return to the  
[Table of Contents](#)

---

***Radiological Monitoring:*** As a Radiological Scientific Officer I try to provide useful information to people about [Radiation Detection Equipment](#). I have assisted many hundreds of people in obtaining thousands of pieces of equipment and in the past have given away hundreds of pieces. I simply no longer have the time to do that but we have stockpiled, tested and labeled hundreds of radiation detection devices (currently worth tens of thousands of dollars) that we will give away to those people that we have to turn away from the door of the shelter.

The plan is to train Radiological Instructors while in the shelter so that they can go out afterwards and train monitoring teams. Equipment has also been stockpiled for these teams.

Click [here](#) to return to the  
[Table of Contents](#)

---

***KI Information and Support:*** A significant radiological defense is in the use of Potassium Iodide (KI) or one of its derivatives. For this purpose we store in our survival community many tens of thousands of dosages to provide for thousands of people in the month following a nuclear event. These we also plan to provide free to persons that we have to turn away from the shelter.

For those persons interested in making provision for their own families we recommend their contacting [KI4U](#).

Click here to return to the  
[Table of Contents](#)

---

***Agricultural Recovery:*** Key to the survival of society and humanity will be the restoration of Agriculture. This is one of the ***MOST IMPORTANT*** types of information that we provide and I highly recommend that you look at [our webpages on agricultural recovery](#).

Among our shelter supplies we are storing multiple copies of [proven plans](#) for converting tractors to operate on wood combustion. With practically no farm horses or horse drawn implements remaining, and with there probably being low availability of petroleum fuels, knowledge of these and similar techniques could be very valuable. The plan would be to train mechanics locally who would then be dispersed to other agricultural locales to supervise local mechanics in the procedures.

We have also prepared a dozen radiological testing kits, for testing for radiation in food and water. We plan to send these to centralized locations, perhaps in each of the Canadian Provinces. Today it would cost over \$5,000 each to replace these and in the future they may invaluable.

We have also made a point of storing seeds for our own facility, in sufficient quantity to supply a sizable community around us.

Click here to return to the  
[Table of Contents](#)

---

***Economic Recovery:*** One of the most challenging issues will be the re-establishment of a functioning economy with monetary exchange. It is to this subject that we have been able to concentrate our particular skills in so much as I was trained as, and served as professor of Institutional Economics. Extensive study, although not known to the general public, was put into the subject by the US Government. Their summary conclusion was that the best bet was what we call LETS (Local Economy Trading Systems) although they did not go further and develop the concept in detail. That I have done, and have published the methodology for [LETS Entitlement](#) here on the web.

Our plan is after the holocaust to first establish a demonstration system and then train individuals in how

to go to other communities and show them how to replicate it. As the local systems progress we would like to then facilitate exchange between them.

Click here to return to the  
[Table of Contents](#)

---

***Refuge and Recovery Maps:*** For a number of years we maintained for each state of the United States, and for Provinces of Canada, lists of Intentional and Survival Communities, however, it became necessary as of the Oct. 2002 revision to discontinue the list in face of growing governmental and social opposition. For each of the states, we still show [maps with potential targets](#) as listed by FEMA.

It is our hope that after a nuclear holocaust we will be able to replace the current maps with maps showing the actual locations of destruction, information about the extensiveness of the destruction, and the pathways around those areas, as the pathways are developed. We would also hope to include information about surviving resources in the areas and that these maps will then be linked into our Family Finding Registry program.

Click here to return to the  
[Table of Contents](#)

---

***Information Broadcast:*** From the outset it was planned that Ark Two would be a broadcast facility, and for this purpose it was built upon the highest point in Ontario. Originally it was equipped with four transmitters that the radio engineers said had the capability to reach both of the coasts and as far south as Florida. Over the years the transmitters deteriorated and a couple of years ago we scrapped them and they have yet to be replaced.

The idea would be to gather information by short-wave and other means and to then broadcast on a band that could be received by AM receivers in automobiles. Specific broadcast times would be established for times relevant to specific localities.

The content would consist of news, shared recovery experience and expertise, agricultural and medical advice, and survivor lists for various locales at specified times. To what degree we will be able to implement this plan will have to be determined at the time. In the meantime we have upgraded the generator for the transmitter and are making additional steps to continue this program.



Click here to return to the  
[Table of Contents](#)

---

***Family Finding:*** One of the most difficult and yet desirable objectives of individuals will be the finding of missing members of their families. It is for this reason that we hope to establish ***THE REGISTRY*** using the above mentioned [state \(and provincial\) maps](#) with a hierarchial arrangement of T.E.A.M. Leaders to be established in each locality for this purpose. It was found that after the limited atomic blasts in Japan that families that were separated at the time of the blasts often had to go in different directions, and having no central known point to return to, often never found each other again, although there were occasionally happy reunifications decades later.

Using the maps, information gathering systems, and the facilities described under other topics, it is our hope to facilitate family finding. For this purpose our web pages were moved closer to the Internet Backbone (3 hops from the US Backbone whereas we were originally 14 hops) and on a fibre optic network with an ISP that has our own survival philosophy. The Internet was originally designed for nuclear survivability and depending upon how well it fulfills that purpose, or how rapidly it can be restored, then we hope to provide an information network where survivors can register for each of their localities, and seekers will be able to systematically look for family members.

Click here to return to the  
[Table of Contents](#)

---

***Social Restoration:*** The humanitarian motivation behind Ark Two has universal bounds. What the future holds, none of us can know in detail, but the Ark Two founder is one of great optimism. Hopefully mankind will learn from its mistakes and will develop an attitude of universal charity and concern towards all of mankind, regardless of race, religion, culture, or other coincidental distinguishing feature. In this regards there are published here two series of web pages on two subjects that the founder considers to be very germane to establishing peace in the world. One series of pages is on [The New World Order](#) and the other series is on a [Universal Auxiliary Language](#).

Click here to return to the  
[Table of Contents](#)

---

**MENU:** [HOME](#) » [SURVIVAL](#) » [Index of States](#)

## Join the MOST CAPABLE Preparedness Community in North America

Our goal is to have the largest and most CAPABLE  
Preparedness Community in North America.

Towards this goal,  
we assign our members to T.E.A.M.s.  
**T**ogether **E**veryone **A**ccomplishes **M**ore  
At the moment we have **12** TEAM Leaders.  
We would like to start some other Specialist TEAMs  
when we can find suitable TEAM leaders.  
Perhaps you are a person with those qualifications.

If you would like to explore the possibility of joining our Community  
you might like to contact one of the following TEAM leaders  
LISTED ALPHABETICALLY  
regarding the possibility of their acting as your mentor  
in joining our community.  
or contact directly

### The Community Coordinator

Bruce Beach at:

[survival@webpal.org](mailto:survival@webpal.org)

**Ours is a very open and tolerant community. Mainly we look for new members who are tolerant, and have a Spirit of Service, and for TEAM Leaders we look for exceptional skills.**

**Ours is a very diverse community. Represented in it are three different Major Religions, and several denominations of Christians. There are also different nationalities, and a wide spectrum of educational backgrounds. The thing that we have in common is EARNED mutual trust and confidence. The community, as such, espouses no particular philosophy, political, or otherwise.**

**The TEAM leaders, in alphabetic order, are as follows:**

**Microbiotics Team Leader.**

**Aina** ([aina@bmts.com](mailto:aina@bmts.com)) has a Masters Degree in Micro-biology. She has been associated with our Preparedness Community for over 15 years. Aina has done special research in the area of the effect of radiation on plants and food. You may see her letter [Radiation in Food](#) and her paper [Contamination of Food Problem After Nuclear War](#). Aina has gathered together a file drawer of folders filled with research papers on the subject of Radiation in Food, and she is in the process of updating her research in the light of published research resulting from the Chernobyle disaster. Coincidentally, Aina is also an expert on the plants and fauna in our area and will work closely with the Agriculture TEAM leader, in this regards.

**Medical Emergency Response TEAM Leader.**

**Bonnar** ([bonnarbeach@hotmail.com](mailto:bonnarbeach@hotmail.com)) has a Bachelor's Degree from Wilfred Laurier, and has completed the Emergency Medical Technician course at Humber College. He has been associated with our Preparedness Community for over twenty years, and has been active in both the building and equipping phase.

**Radiological Defense TEAM Leader.**

**Bruce** ([survival@webpal.org](mailto:survival@webpal.org)) has a Masters Degree in Economics and has completed four government courses in Radiological Defense to the highest level of Radiological Scientific Officer and is a certified trainer in Radiological Defense. Bruce is also both a St. John Ambulance and Red Cross First Aid Instructor. A member of Bruce's TEAM is Ron, probably the most experienced designer and manufacturer of nuclear radiation test equipment in Canada, if not in North America. (He has checked, and sometimes designed and manufactured all of our radiation detection equipment.) Bruce has written a well received booklet on the subject of Nuclear Survival that is available **FREE** at: [You Will Survive doomsday](#).

**Carpentry Maintenance TEAM Leader.**

**Dave** ([eldner@interhop.net](mailto:eldner@interhop.net)) is an experienced Habitat for Humanity builder and is an experienced craftsman, having his own business for many years. He is now associated full-time with an area hospital. Over the years he has worked on many of our shelter projects. He has had on his team, for several years, a licensed plumber.

**Administrative TEAM Leader.**

**Frank** ([dominion\\_group2@hotmail.com](mailto:dominion_group2@hotmail.com)) Frank has his degree in business

**administration from a Toronto college. He is the coordinator of the Canadian Preparedness Network, and the TEAM designation was his original concept for this group. Assisting Frank on his Team are Wilf and Bahia, two other experienced administrators. Frank has not been as active with us for the last couple of years but I got an email for this March 2000 update and he says that he is still there so until I get a phone call or notification otherwise he is still listed.**

### **Agricultural Acquisition TEAM Leader.**

**Gary ([gseaborne@stn.net](mailto:gseaborne@stn.net)) has been involved in the wholesale operation of agricultural products for the last fifteen years and has become very familiar with local agricultural resources. During those years he has also given us valuable volunteer assistance in the building of the Ark.**

### **Mechanical Systems TEAM Leader.**

**John ([jsipple@easyfocus.com](mailto:jsipple@easyfocus.com)) is a Wheelwright and has been associated with our Preparedness Community for several years. He works full time, and has many years experience, in large plants as the shift supervisor for mechanical and electrical maintenance. John also ends up with the brunt of moving things for the shelter with his truck and trailer, and we have moved many dozens of loads with his trailer in the last years.**

### **Construction Team Leader.**

**Percy ([percy@heaven.God](mailto:percy@heaven.God)) in MEMORIAM.**

**Percy passed on from a heart attack, but we still wish to acknowledge his GREAT contribution to our Preparedness Community. Percy over-saw the construction of our 500 person shelter. We will ever be appreciative of his many years of service. In recent years, many man months of labor have gone into the shelter by Bill, who was Percy's assistant foreman, and who is now assisted by Paul. Down through the years many craftsmen have dedicatedly worked on the shelter including John, who with his able crew, dug our well.**

### **Supply Team Leader.**

**Peter ([P\\_Corlett@yahoo.com](mailto:P_Corlett@yahoo.com)) has been associated with our Preparedness Community for over 10 years. He has been greatly dedicated to identifying a variety of necessary equipment and supplies. He is a full-time professional videographer, and our liason to the barter community. Peter has made a professional video of our survival complex. He will will send you a copy for \$10 copying and handling charges, if you wish.**

### **Medical Team Leader.**

**Ray (Ray@-----) has been a member of our Preparedness Community for over 15 years. Ray is an M.D. and he will be glad to correspond with**

**any other physicians who are seriously considering becoming a member of our community. If you are a licensed physician send Bruce your email address and he will pass it on to Ray. We also have two other physicians plus two nurses who are "acquainted" with, and not non-supportive of our activities, that may become active if conditions deteriorate. In the next few weeks we are expecting another doctor to join us from Florida and I have asked him for his permission to add his name here.**

**Communications Team Leader.**

**Velda ([vhardman@sympatico.ca](mailto:vhardman@sympatico.ca))** Member of the Preparedness Community for over 20 years. Ham Operator (call VE3 LIB) and all that. Probably best to make an appointment by email if you want to talk

**Personnel Team Leader.**

**Warren ([wsearch@triad-graphics.com](mailto:wsearch@triad-graphics.com))**

**works full time as a Graphics Artist and makes the daily commute back and forth to the city. In 2000 he took over as the TEAM Leader for Community Personnel and will be the one making assignments to the various TEAMS.**

**You - A Team of Your Choice**

**If you are a person who lives in the Greater Toronto Area or within a couple of hundred kilometers North West of Toronto (our shelter is 90 k.m. N.W. of Toronto City Hall, on the protected side of Caledon Mountain) we would like to invite you to investigate our Preparedness Community.**

**Although not listed here, we have a number of people who live in the vicinity that have some real talent and skills and that have been quite supportive of our efforts. Should the need arise they will be participating in the shelter and they have been tentatively assigned to the appropriate TEAMS.**

**If you have a skill that we need, we would like for you to become a TEAM leader. The TEAM leader positions that we are most needing to fill are:**

- **Community Health Expert**
- **Telephony and Electronics Repair**
- **Chemist (particularly in regards to pharmaceuticals and plastics)**
- **Petroleum Engineer**
- **Dietician and Food Preparation**
- **Automotive Repair**
- **Security**

- **Agricultural**

**Although for the latter we have team members with a combined total of over 100 years of agricultural experience in the area, and potential TEAM members with much more.**

**If you reside in the U.S. as a U.S. citizen, (and have NO criminal record) you may legally purchase for residence a cottage or farm in the Shelter Vicinity. The only requirement is that you must return to the U.S. for a few hours (minutes?) once every six months.**

**The members of our Preparedness Community have very diverse views about the future. Some are motivated by millennial concerns, some expect a nuclear holocaust, others anticipate earth changes, and still others social disruptions.**

**Whatever YOUR particular view or motivation you will most likely find a number of other members of our Preparedness Community with similar viewpoints, and you will find the efforts of ALL the members of our community compatible with your concerns. All persons worthy of trust and confidence, who have a Spirit of Service, will find a Haven in which they can have confidence.**

**If the above describes you as an individual then please contact RIGHT NOW,**

---

**MENU: [HOME](#) » [SURVIVAL](#) » [Index of States](#)**

## FREE Books on Nuclear Survival

There are many books and pamphlets throughout this web site. Here are a few that deal directly with the subject of survival from nuclear fallout. Elsewhere are others on the subject of recovery and reorganization.

Some of the material is in HTML, other in .pdf, a few in both. Some elsewhere are marked LOCKED because for those we have as yet to obtain copyright permission. The key to open the locked files won't be provided until after a nuclear war but they have been archived so that they will be available..

The material comes from a variety of sources but the bulk of it has been converted to web format, (sometimes HTML and sometimes .pdf and occasionally both), by our Ark Two Librarian. For the last several years it has been an intensive labor of love on his part requiring immense effort and dedication.

Some of the material he maintains in duplicate at another site:

[http://groups.yahoo.com/group/Self\\_Sufficiency/files](http://groups.yahoo.com/group/Self_Sufficiency/files)

The materials, here and elsewhere on this website, that are presently available and unlocked are copyrighted but you are free to:

- link to them
- print them off and distribute them free
  - so long as you do so in their entirety - giving the authors credit
- quote from them - so long as you do so accurately and give credit

**Nuclear Weapons and Fallout Defense**  
*in order of importance to read*

HTML  
[You Will Survive Doomsday](#)

This is an easy to read booklet by a Radiological Scientific Officer that gives an



**overall theoretical view of nuclear survival by refuting 23 myths often associated with the subject. It is meant to be read well ahead of time.**

**.pdf**

**[You Will Survive Doomsday](#)**

**This is the 2003 KB .pdf format of the above 24 page booklet.**

**HTML**

**[11 Steps To Survival](#)**

**This is a Canadian Government publication that lays out steps to nuclear survival, and should be the first priority to read in face of an immediate threat.**

**.pdf**

**[11 Steps To Survival](#)**

**This is the 930 KB of 25 pages in .pdf format of the above 47 page booklet.**

**.pdf**

**[Your Basement Fallout Shelter](#)**

**This 1111 KB 31 page booklet explains how to build a basement fallout shelter**

**.pdf**

**[Fallout On The Farm](#)**

**This 790 KB 14 page booklet by the Canadian Government explains basic defenses for use on the farm.**

**.pdf**

**[Nuclear Weapons Defense Manual](#)**

**This 1113 KB 95 page course manual was issued in the Canadian Radiological Defense Officers Course.**

**.pdf**

**[Nuclear Weapons Defense Manual - Tables](#)**

**This 951 KB 34 page manual of tables was issued in the Canadian Radiological**

## Defense Officers Course.

.pdf

### [Nuclear Weapons Effects - Radiological Scientific Officers Handbook](#)

This 2540 KB 124 page handbook was issued in the Canadian Radiological Scientific Officers Course.

### [Nuclear War Survival Skills](#)

This is the lengthy and comprehensive classic by Cresson Kearny that explains in detail the techniques needed for nuclear survival. Because of the length of this book, it is stored here in Replica Format. Clicking on the execute file will open it for you. If by chance you do not have Replica on your system it will load it for you and take only a moment to do so if you tell it to go ahead. The pictures do not appear.

### **Fallout Recovery**

*in order of importance to read*

HTML

### [Letter on Radiation in Food](#)

This is an introductory letter by the microbiologist Aina Shapley on the subject of Radiation in Food.

HTML

### [Contamination\\_of\\_Food\\_After\\_Nuclear\\_War](#)

This is the full report by the microbiologist Aina Shapley who was commissioned by Ark Two to examine the overall problem.

.pdf

### [Contamination\\_of\\_Food\\_After\\_Nuclear\\_War](#)

This 2687 KB 37 page paper in .pdf format of the above paper by the microbiologist Aina Shapley who was commissioned by Ark Two to examine the overall problem.

.pdf LOCKED

### [Manual of food quality control - radionuclides in food](#)

**This 13048 KB 133 page paper is the official USDA (United States Department of Agriculture) and UN (United Nations) standard and methodology for measuring radiation in food. This is the prime authoritative document on the subject. I obtained the information through its author Edmond J. Baratta, International Expert on Radioactivity with the US Food and Drug Administration at the research facility in Winchester, Massachusetts. The document is published both by the FDA and FAO (Food and Agricultural Organization of the UN). It is both very technical and readable in its detailed description of the methodologies and processes involved. However, since it does carry a copyright, and the government charges hundreds of dollars for a copy, this file is presently sealed until after the nuclear war.**

### **[Removal Of Strontium-89 and Calcium-45 From Milk](#)**

**How to remove radiation from milk in a processing plant. This is the 61 page masters thesis of David Gene Easterly. I have the author's personal permission to republish it here.**

### **[Radiation Risk and Ethics](#)**

**There was much scare talk about the effects of peace time radiation. This professional paper gives a much different view. It helps to get things into perspective.**

---

**MENU: [HOME](#) » [SURVIVAL](#) » [Index of States](#)**

# Embedded Secure Document

The file *file:///E:/PROPHECYKEEPERS/data/POST-NUCLEAR-WAR/d\_resources/survival/books/doomsday/ywsd.pdf* is a secure document that has been embedded in this document. Double click the pushpin to view.



**This booklet was converted to HTML by our Ark Two Librarian, Fred Walter; a lengthy task which, I for one, wish to express my appreciation.**

It contains so many photos that it is probably easiest for you to read it on-line, and some browsers will now print it off but you can capture it and print it off, along with a number of very useful other books from our Ark Two Librarian's easy printing .pdf versions at:

[http://groups.yahoo.com/group/Self\\_Sufficiency/files](http://groups.yahoo.com/group/Self_Sufficiency/files)

---

# **11 Steps to Survival**

## ***Canada Emergency Measures Organization***

**Department of National Defence**

***Blueprint for Survival No. 4***

---

**Make this your handbook for emergencies.**

**Keep it in a handy place so that you and your family can refer to it quickly should any emergency threaten.**

**Keep other emergency advice such as first aid and artificial respiration instructions, antidotes for poison, emergency telephone numbers, in the same place.**

---

## **Introduction**

The Canadian Government has joined other peace-minded nations in doing everything possible to reduce world tensions, to assist in the settlement of international disputes by peaceful means and to achieve disarmament with such controls as are necessary to preserve the security of all nations. However, the awesome threat of a major nuclear war involving North America remains a factor in plans for the defence of Canada.

The nature and scale of a possible nuclear attack on North America, and the extent to which Canada would be involved in such an attack, cannot be predicted with accuracy. Our major centres would be at some risk of deliberate attack, random explosions could occur, and there would be the certainty of the danger from widespread, radioactive fallout over most of the Country.

Governments at all levels have made, and are continuing to make, preparations which will reduce the number of casualties, safeguard survivors and contribute to the capacity of this nation to survive and recover from such a tragedy. The purpose of this booklet is to assist individuals and families in making personal survival plans and preparations to guard themselves against the potential dangers of nuclear war.

Many of the precautions which are recommended will serve a double purpose in that they will save lives in peacetime disasters such as flood, tornado, fire, hurricane, blizzard, ice storm or earthquake. Attention has been directed to this important feature throughout the various steps.

All Canadians are urged to read "11 Steps to Survival" with care to act on the advice it contains and to keep it handy for emergencies.

Although protected by Crown Copyright, the contents may be reproduced in whole or in part provided proper acknowledgment of the source is made.

The Queen's Printer  
Ottawa, 1969  
Cat. No. Id 83-1/4

---

## The Eleven Steps to Survival

Governments and communities at all levels are planning for the survival of our Nation in the event of a nuclear war. But the survival of individuals also will depend upon the preparation that each person makes. Persons ready to take the right action before and following an attack will increase their chances of survival.

This pamphlet describes what YOU can do before and following a nuclear attack. You can greatly increase your family's and your own protection by taking the Eleven Steps to Survival:

- [Step 1](#): Know the effects of nuclear explosions.
- [Step 2](#): Know the facts about radioactive fallout.
- [Step 3](#): Know the warning signal and have a battery-powered radio.
- [Step 4](#): Know how to take shelter.
- [Step 5](#): Have fourteen days emergency supplies.
- [Step 6](#): Know how to prevent and fight fires.
- [Step 7](#): Know first aid and home nursing.
- [Step 8](#): Know emergency cleanliness.
- [Step 9](#): Know how to get rid of radioactive dust.
- [Step 10](#): Know your municipal plans.
- [Step 11](#): Have a plan for your family and yourself.

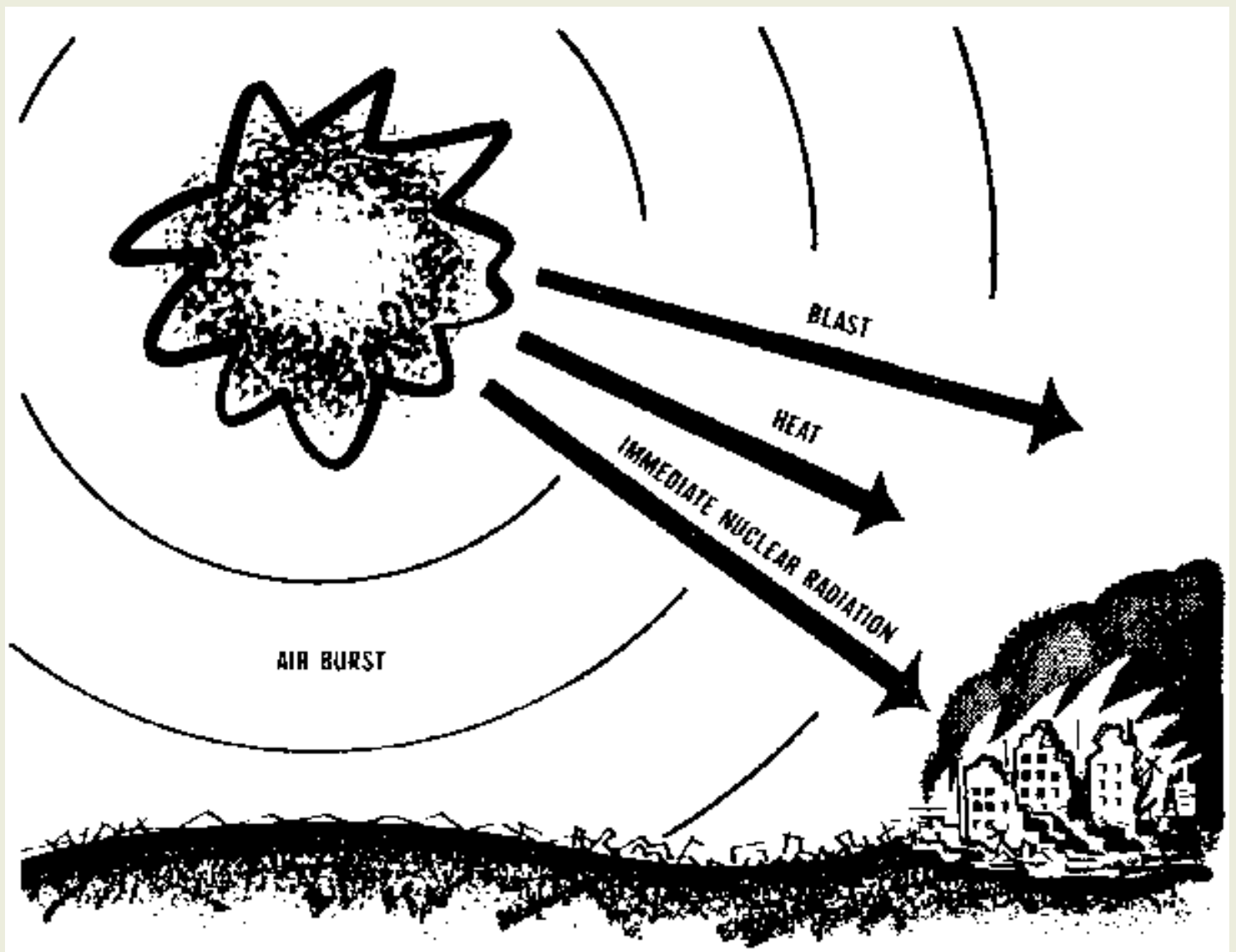
# Step 1: Know the Effects of Nuclear Explosions

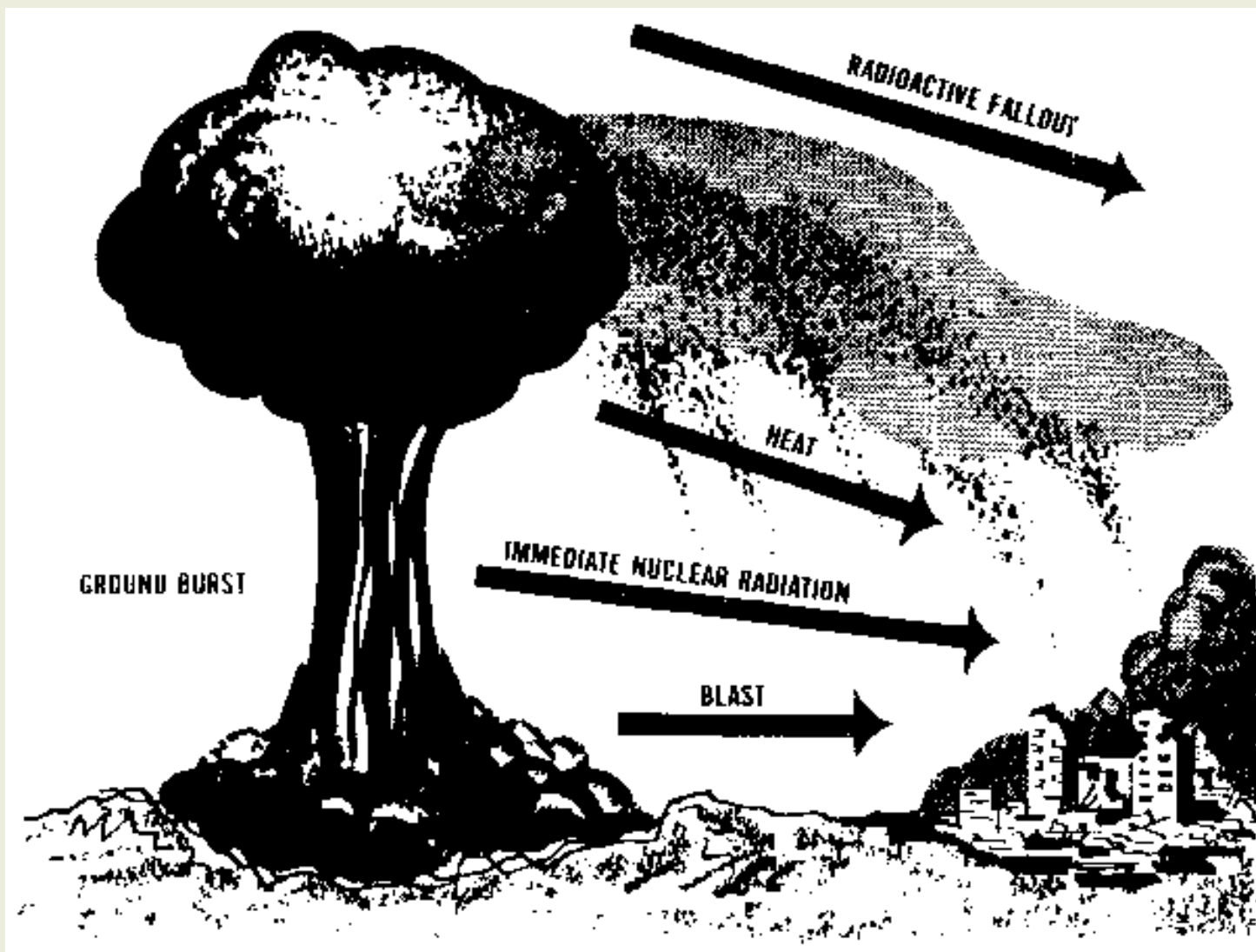
A nuclear explosion releases vast amounts of energy in three forms:

1. [Light and heat](#)
2. [Blast](#)
3. [Radiation](#)

The amount of energy released depends upon the size and design of the weapon. A wide range of weapons and delivery systems are available to an aggressor and we have no way of knowing what size of explosions might take place in Canada. For illustration purposes, we describe in this pamphlet the effects of a 5-megaton H-bomb equal to the explosive force of five million tons of TNT. Such a bomb could substantially damage the largest Canadian city.

The effects depend upon whether the weapon is exploded high in the air, or on, or near the ground. An air burst usually produces more fire and blast-damage than a ground burst which results in a big crater and more radioactive fallout. The effects described below are approximate for a 5-megaton explosion and can only be approximate since effects depend upon a number of conditions such as weather, terrain, etc.





## Light and Heat

A blaze of light brighter than the sun is produced by a nuclear explosion. It lasts for about 15 seconds. Temporary blindness and eye injury can result from the glare if eyes are not shielded.

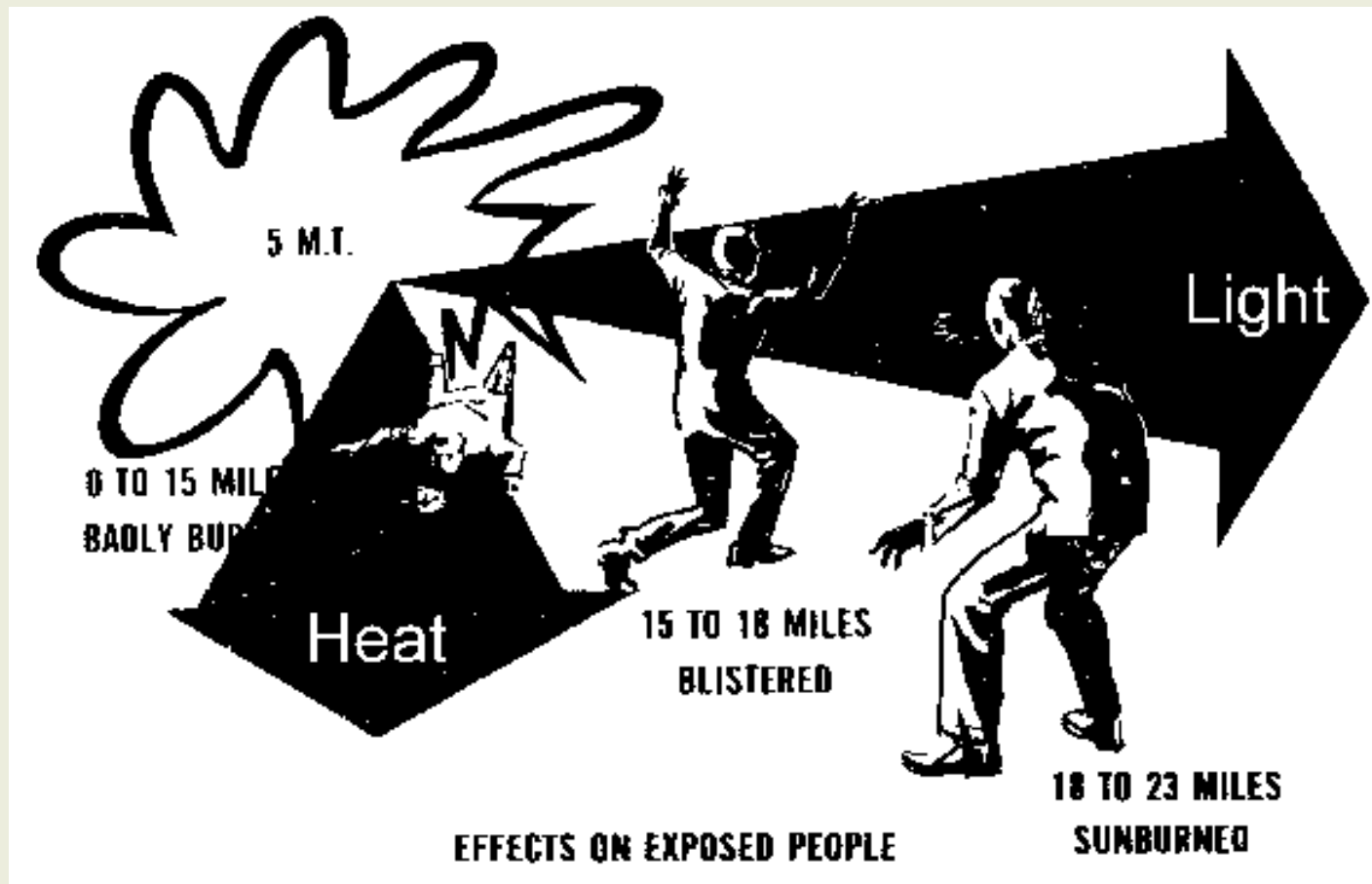
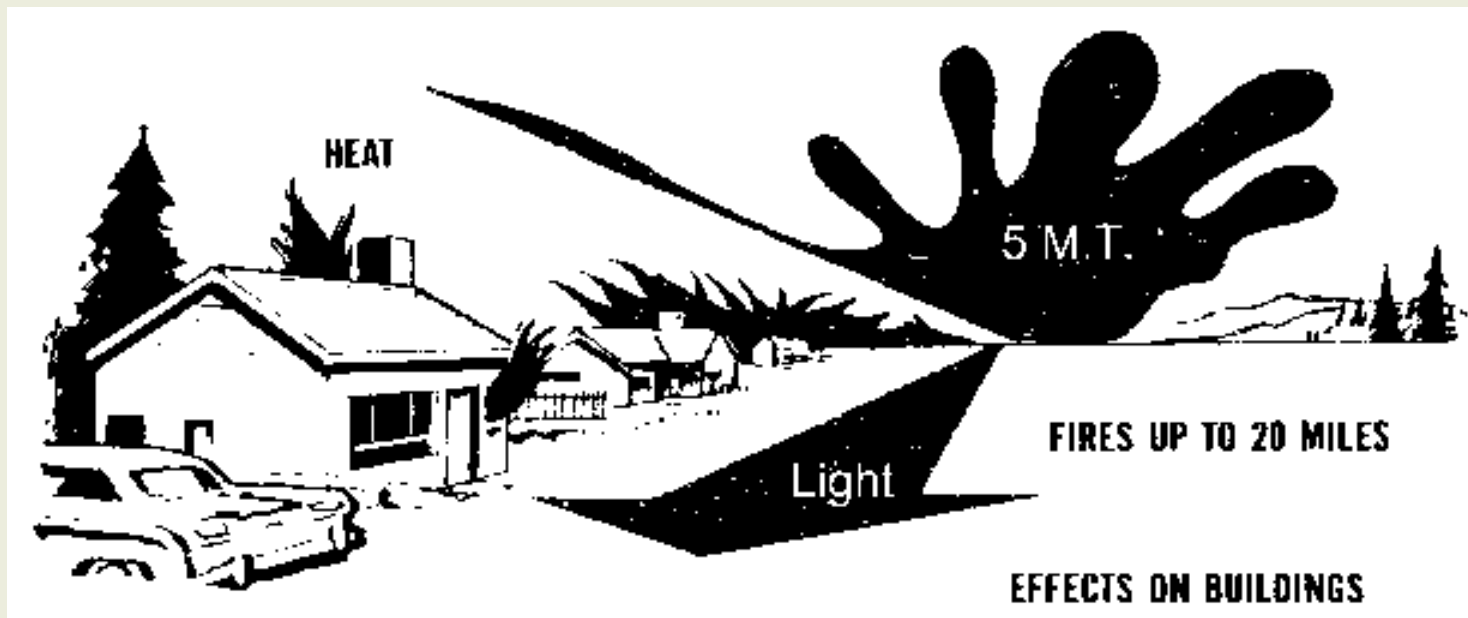
The heat rays from the explosion travel at the speed of light or about 186,000 miles per second. It can start fires up to 20 miles away. Many fires are caused when the heat pulse comes through a window to set fire to curtains, paper, clothing and furniture. The heat flash also can set fire to the outside of wooden buildings.

The following are some examples of the predictable effects on unprotected skin of the heat flash of a 5-megaton weapon exploded on a clear day:

- Skin is badly burned up to 15 miles from the explosion.
- Skin is blistered up to 18 miles from the explosion.
- Sunburn types of burns up to 23 miles from the explosion.

Nuclear explosions in the air rather than on the ground are more likely to produce a greater number of serious burns through the heat flash. Clothing will give some protection. A shield between you and the light will give protection against burns from the heat flash.

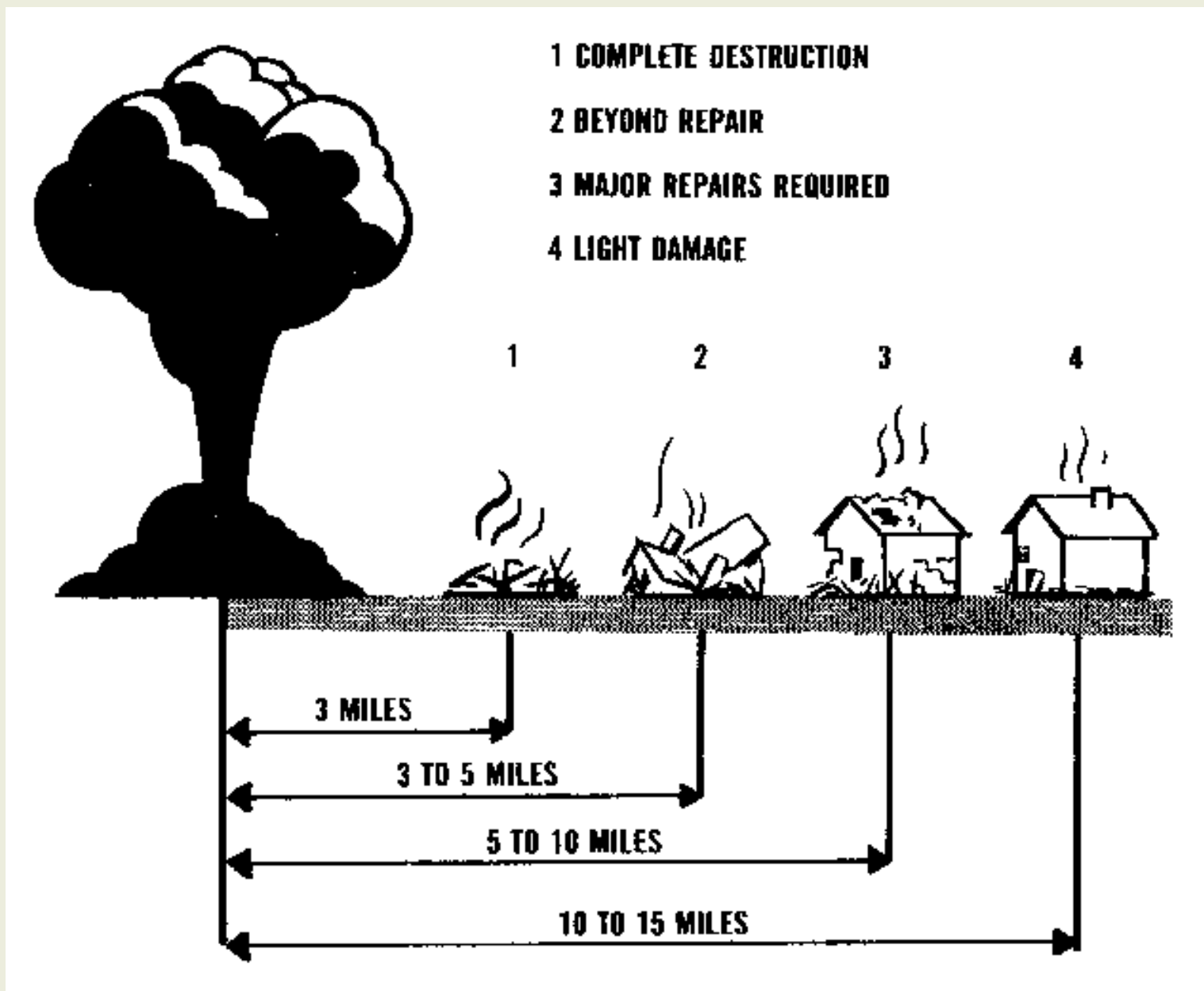




## Blast

The blast wave travels more slowly than the heat flash. Several seconds may pass after you have seen the light or felt the heat before the blast wave reaches you, depending on the distance you are from the explosion. It is like the time between seeing the flash of lightning and hearing the sound of thunder. For example, at ten miles from the centre of an explosion, it would take about 35 seconds for the blast wave to reach you. If caught in the open during a nuclear explosion, this time can be used to find some protection from the blast wave.

You might be injured by being thrown about by the blast; therefore, keep low. The greatest danger is from flying glass, bricks and other debris. The blast from a 5-megaton explosion could injure people as far away as 15 miles.



The kinds of damage that the blast can do to buildings are:

- Complete destruction of all buildings three miles from the centre of the explosion.
- Damage beyond repair to buildings three to five miles distant. They would have to be torn down.
- Major repairs required to buildings five to 10 miles distant before they could be occupied.
- Light to moderate damage to buildings 10 to 15 miles distant. They could be occupied during repairs.

A 20-megaton bomb increases the approximate ranges of damage described above to five, eight, sixteen and twenty-four miles.

These are approximate distances as the strength of buildings is not uniform. For example, reinforced concrete buildings are more blast resistant than wood frame structures. In some areas four miles away from the explosion,

concrete buildings might be repairable, while wood frame buildings would be completely destroyed. Windows, of course, are very vulnerable and are apt to be blown in as far away as 25 miles from the explosion.

## Radiation

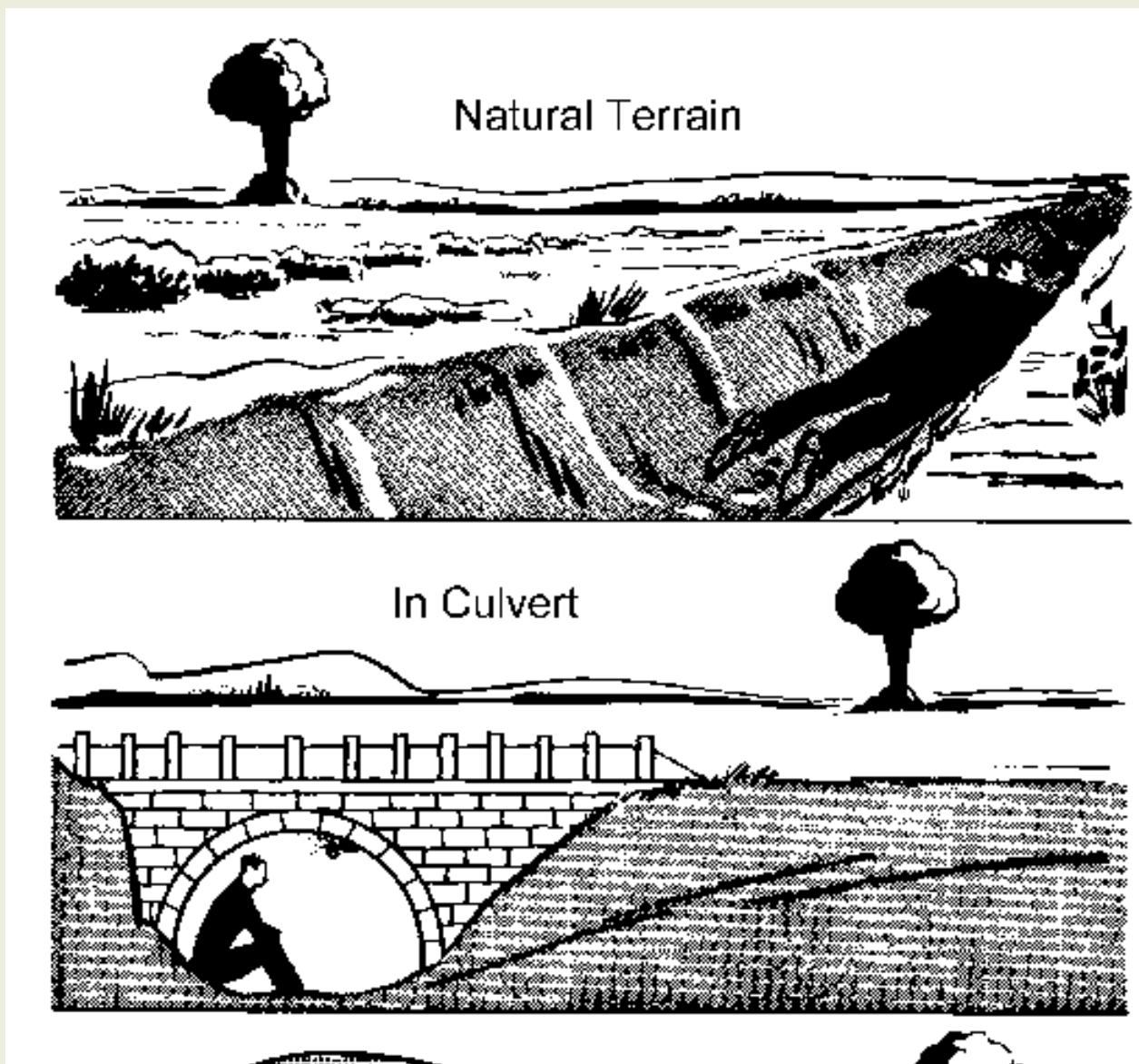
A nuclear explosion causes both immediate radiation and residual radiation.

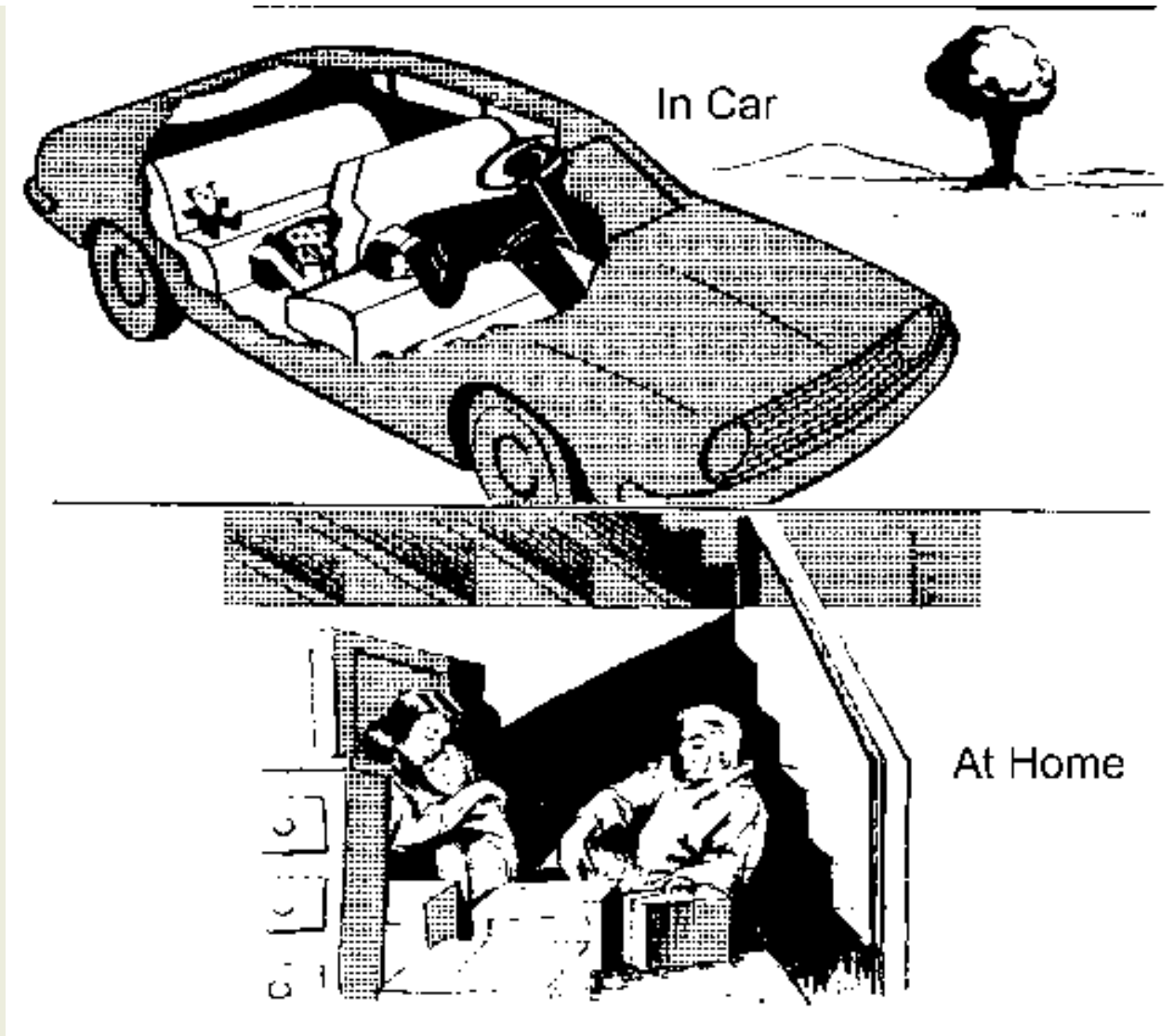
Immediate radiation is given off at the time of the explosion. It is dangerous only within two or three miles. If you were near the explosion without adequate protection and managed to survive the effects of blast and fire, you could still be seriously affected by immediate radiation.

Residual radiation is given off by the radioactive particles left as "fallout" after the explosion. The danger from fallout would be so great and widespread that it is discussed separately, in [Step 2](#).

## Protection against Heat, Blast and Immediate Radiation

The illustrations below show some of the most probable situations in which you might find yourself at the time of a nuclear attack, and what you should do:





## Step 2: Know the Facts About Radioactive Fallout

If a nuclear weapon is exploded on, or near, the ground, danger from radioactive fallout is greatest. The force of the explosion may make a crater up to a mile wide and to a depth of one hundred feet. Millions of tons of pulverized earth, stones, buildings and other materials are drawn up into the fireball and become radioactive. Some of the heavier particles spill out around the point of explosion. The rest are sucked up into the mushroom cloud.

This radioactive material is then carried by winds until it settles to earth. This is called "Fallout". Under some circumstances you may see the fallout; under others you may not.

The radioactivity it gives off cannot be seen. You can't feel it. You can't smell it.

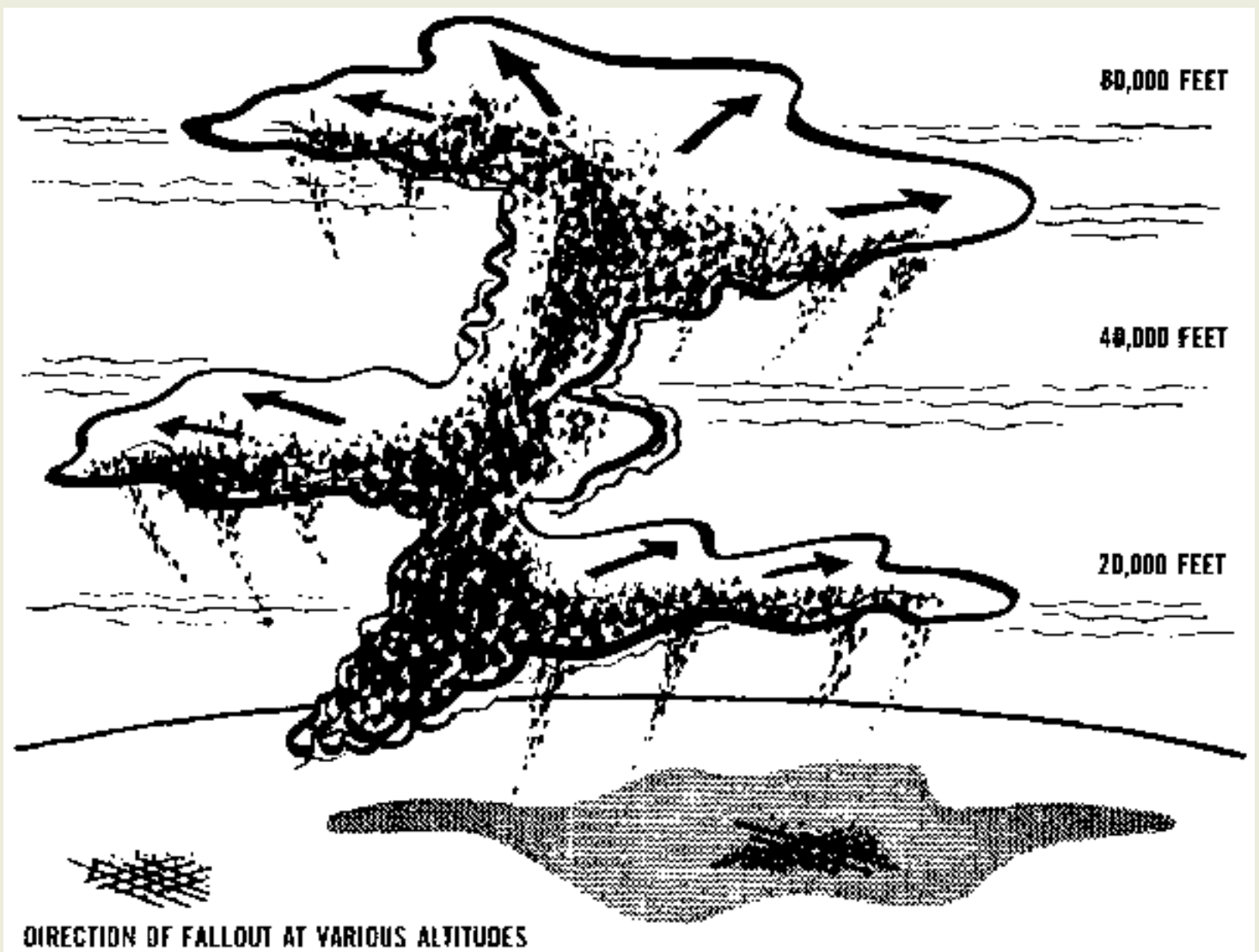
But fallout doesn't come out of the sky like a gas and seep into everything. It can best be described as a fine to coarse sand carried by the winds. Because the wind direction varies at different heights above the ground, it is not possible to judge from the ground where the fallout will settle. It can settle in irregular patterns hundreds of miles from the explosion.

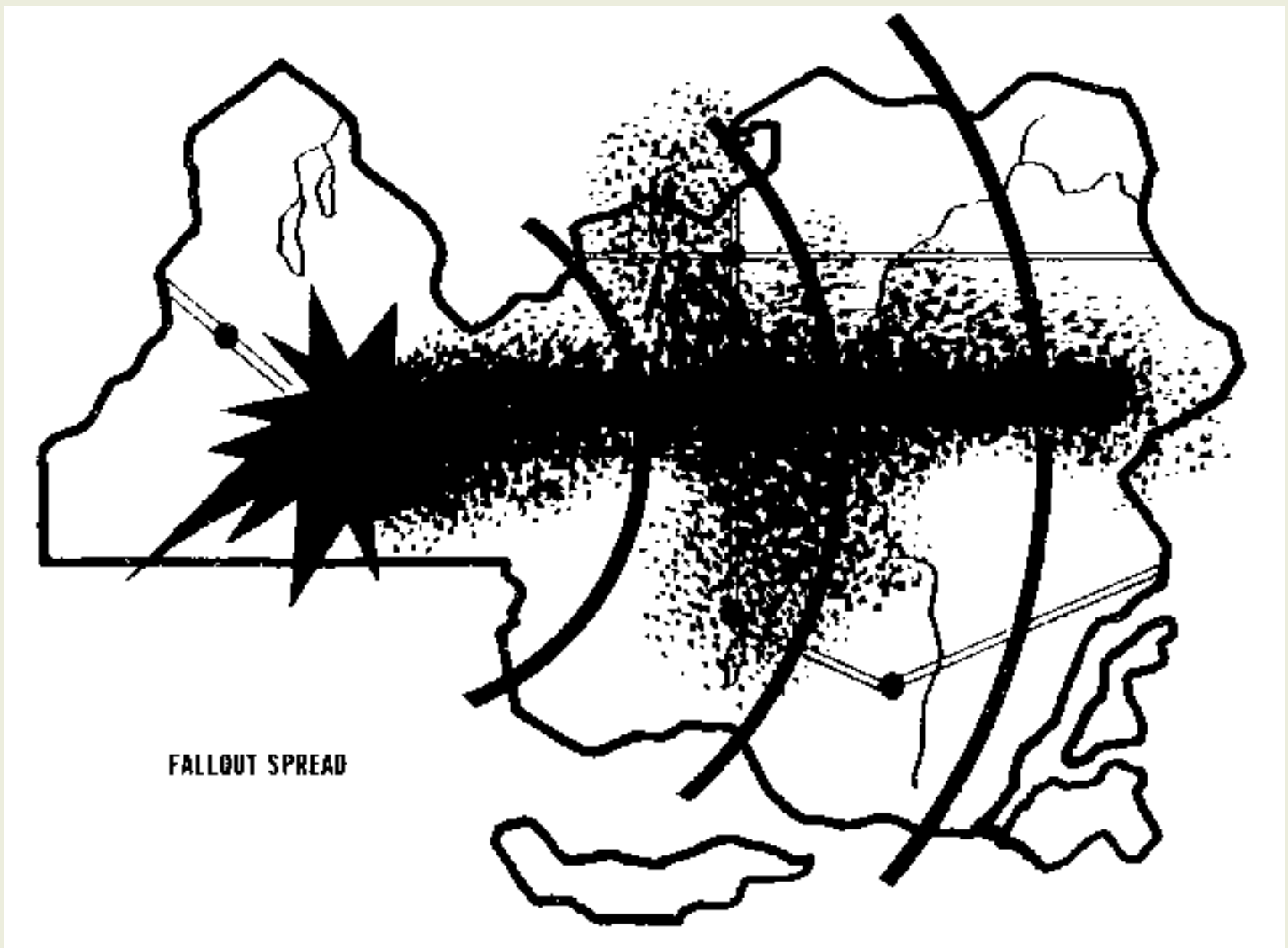
The fallout from a 5-megaton explosion could affect seriously an area of 7,000 square miles. If nothing were done to gain protection during the period of high radioactivity, there would be a grave danger to life in that area.

Because fallout is carried so far and covers such a large area, it could be the greatest danger to the largest number of Canadians in a nuclear war. If Canada was not hit by nuclear bombs, those exploding in the United States close to our border could result in serious fallout in many parts of Canada.

There are four things which determine the amount of radiation reaching your body from fallout:

1. The [time](#) that has passed since the explosion.
2. The length of [time](#) you are exposed to fallout.
3. The [distance](#) you are from the fallout.
4. The [shielding](#) between you and the fallout.

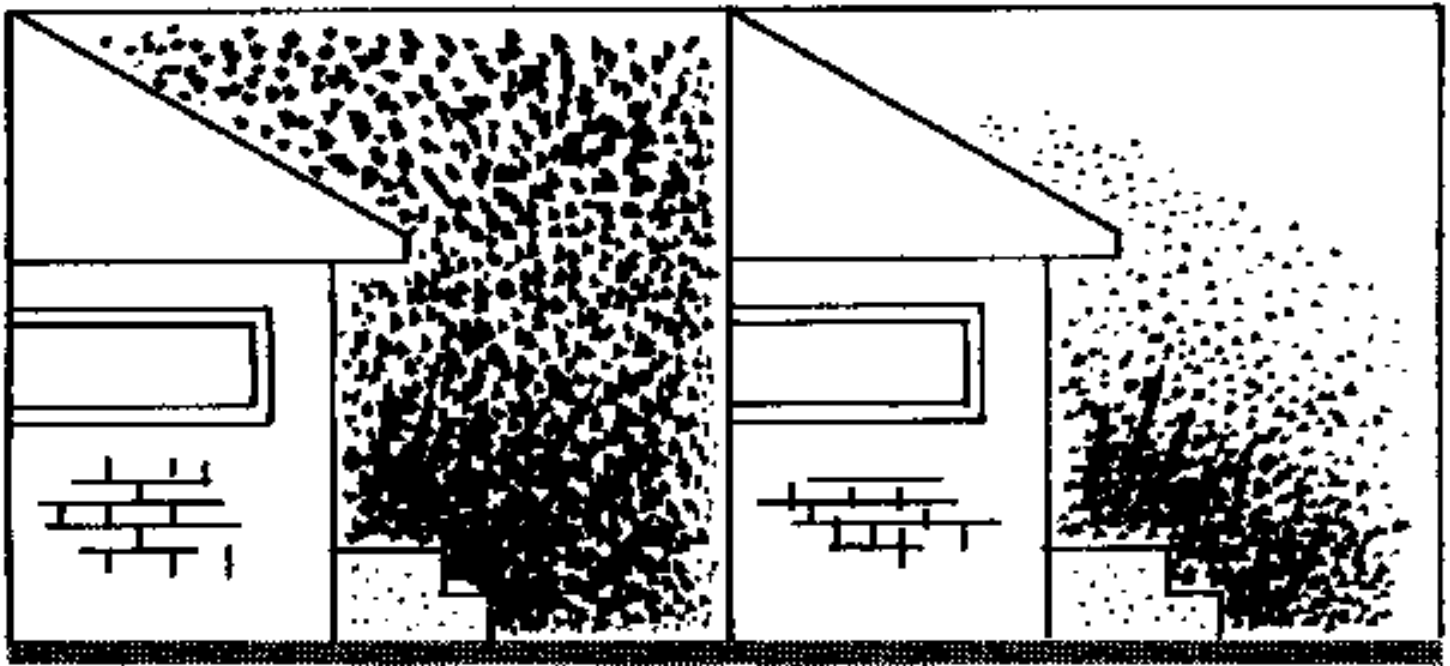




## Time

The radioactivity in fallout weakens rapidly in the first hours after an explosion. This weakening is called "decay". After seven hours, fallout has lost about 90% of the strength it had one hour after the explosion. After two days it has lost 99%; in two weeks 99.9% of its strength is gone. Nevertheless, if the radiation at the beginning were high enough, the remaining 0.1% could be dangerous.

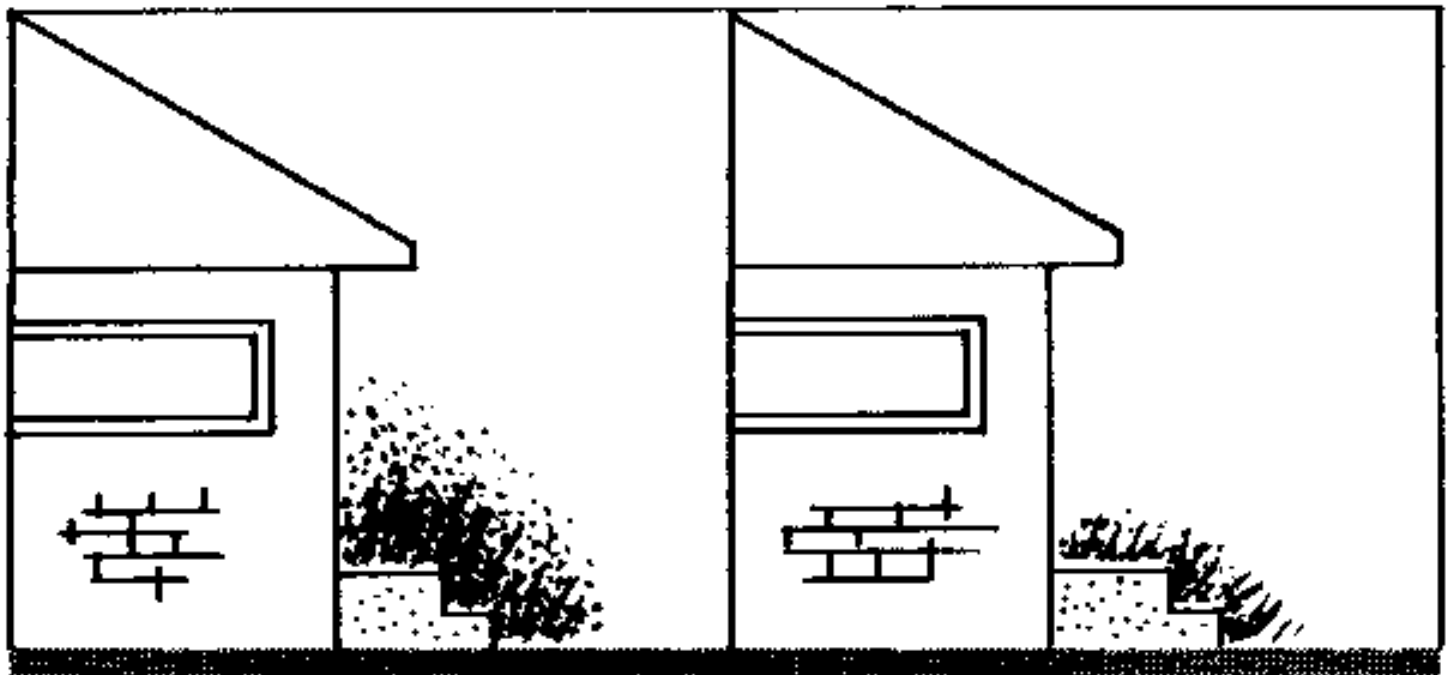
Radiation must be measured by special instruments handled by people trained to use them. But, if you stay in a shelter during the first days following an explosion, you escape the strongest radiation. *You should stay in the shelter until radiation has been measured and you have been told over the radio that it is safe to come out.*



1 HOUR

7 HOURS

RADIATION DECAY TIME

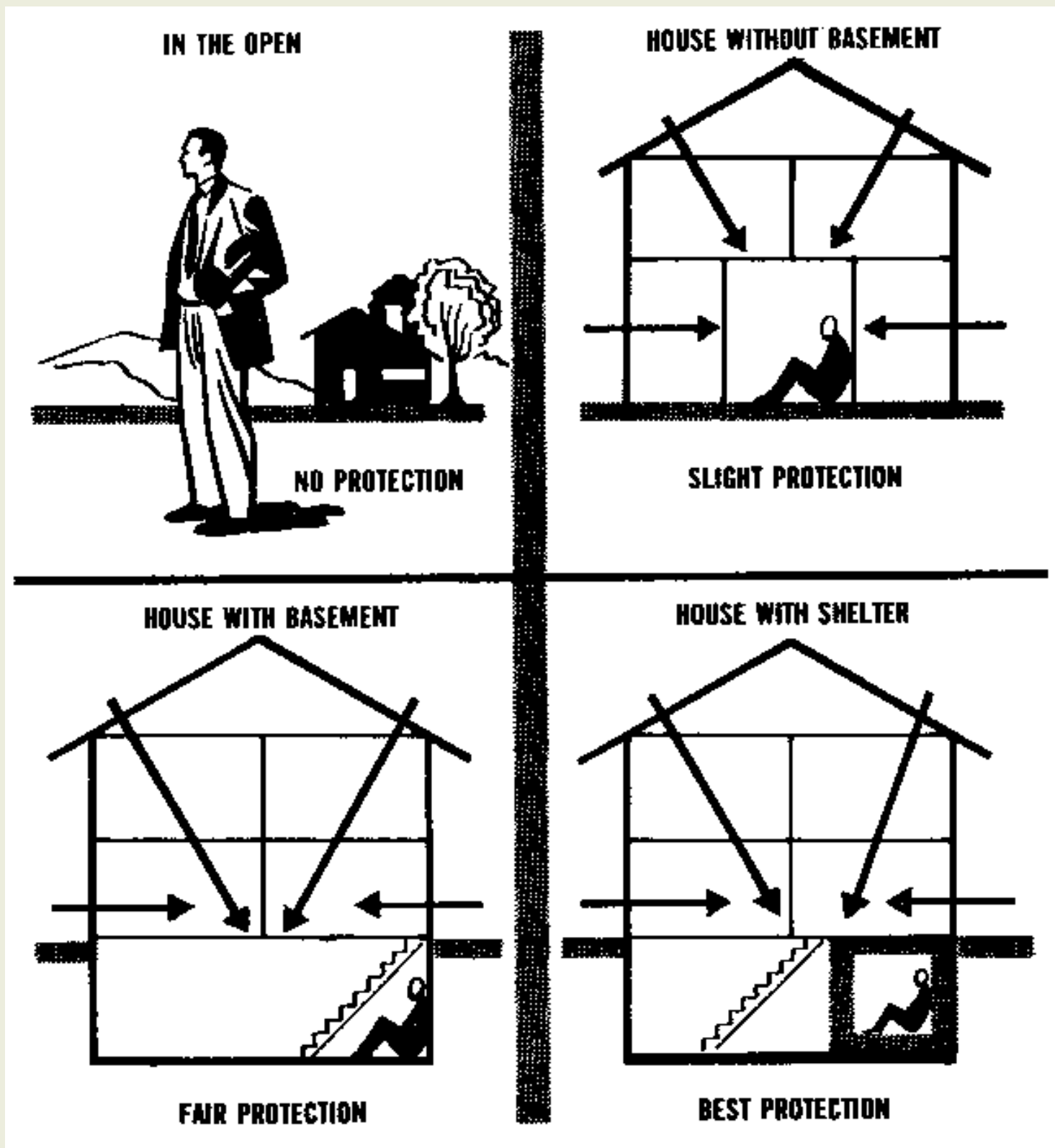


48 HOURS

2 WEEKS

## Distance

The strength of radiation reaching your body is reduced the farther you are from the fallout. Here are some illustrations of the safest place to be when you are in various kinds of buildings.



## Shielding

The most effective protection is to place some heavy material between yourself and the fallout. The heavier the material the better the protection. Many common materials give excellent protection. The materials and design of the fallout shelter recommended in **Blueprint for Survival No. 1** will stop penetration of 99% of outside radiation.

These thicknesses of material will stop 99% of radiation:

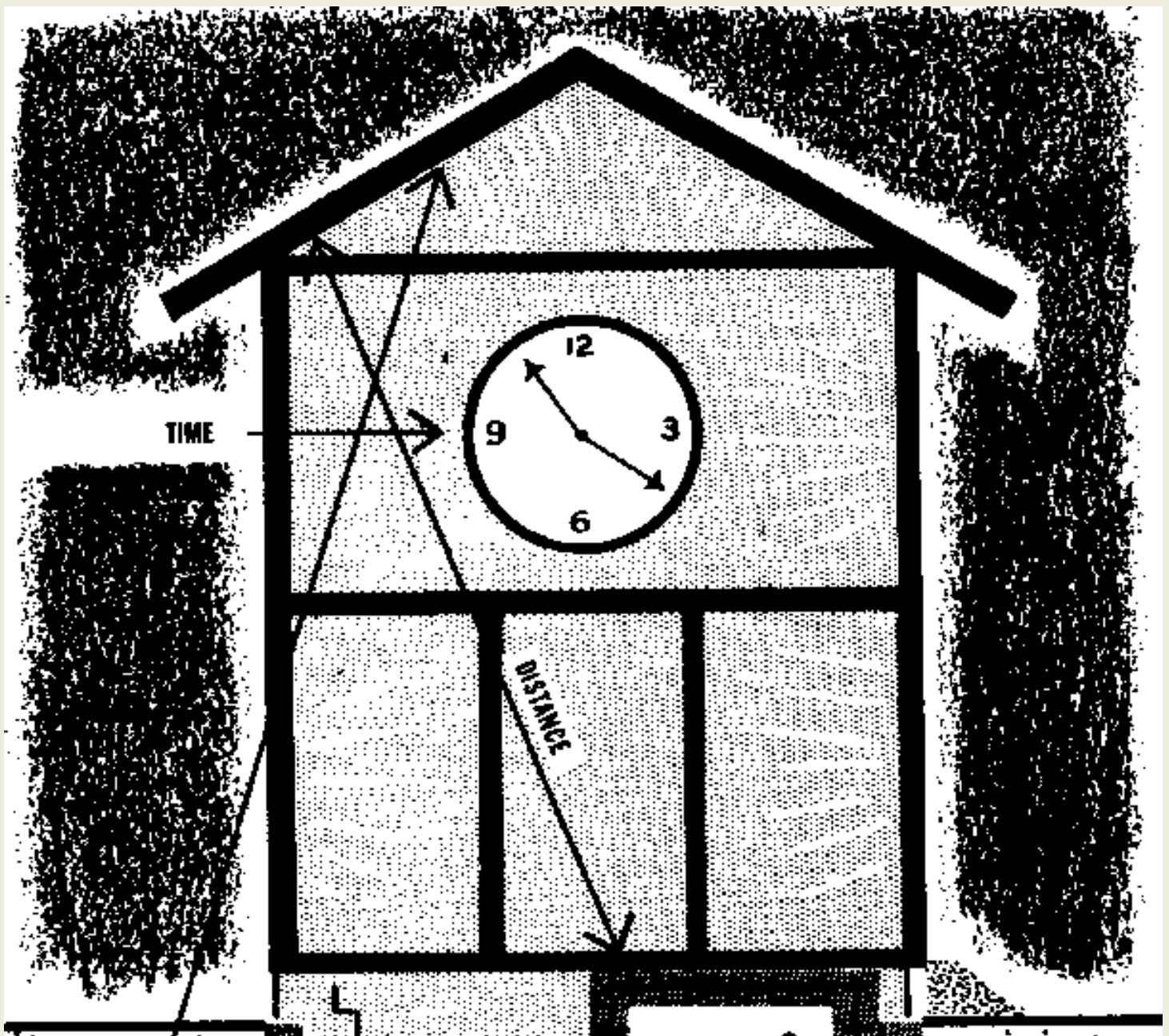


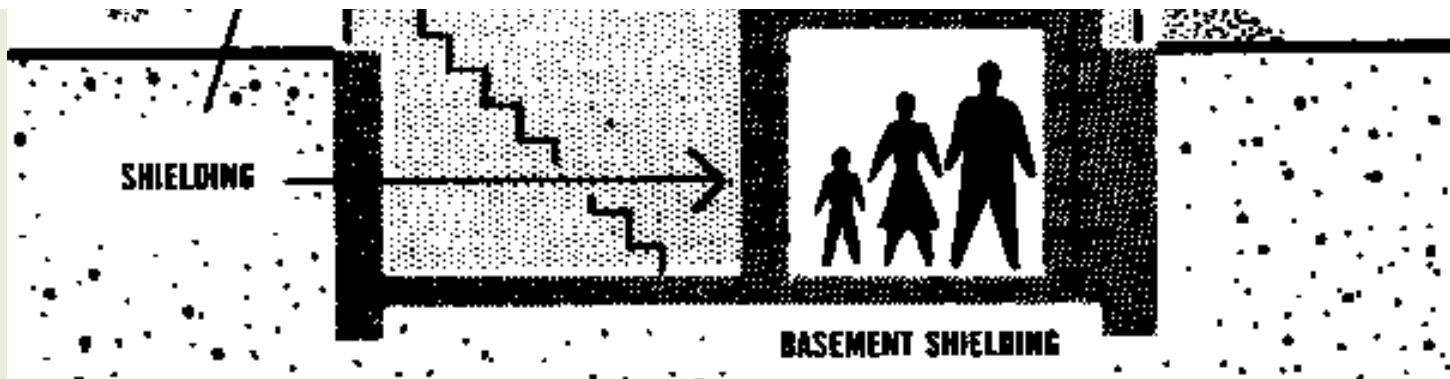
- 16 inches of solid brick
- 16 inches of hollow concrete blocks filled with mortar or sand
- 2 feet of packed earth  $\ddot{\text{A}}$  3 feet if loose
- 5 inches of steel
- 3 inches of lead
- 3 feet of water

**A fallout shelter is the best way to protect your family and yourself against radiation because:**

- It keeps the radiation at a distance.
- It shields you from radiation.
- The time spent there is the period when radiation is most intense.

By providing your family and yourself with a fallout shelter, you are unlikely to suffer serious effects from radioactive fallout.





## Personal Danger from Fallout

Radioactive particles in contact with your skin for a few hours may produce burns. Follow [Step 9](#) to prevent this danger.

Radioactive particles swallowed in food or water might be harmful. Follow [Step 9](#) to prevent this danger.

Radioactivity from an area of fallout may produce illness in the unprotected individual after a few days. Follow [Step 4](#) to prevent this danger.

Radiation illness develops slowly. It cannot be spread to other people. Except for temporary nausea shortly after exposure, evidence of serious effects from radiation may only appear after an interval of from a few days to three weeks. A combination of loss of hair, loss of appetite, increasing paleness, weakness, diarrhoea, sore throat, bleeding gums and easy bruising indicate that the individual requires medical attention. *Nausea and vomiting may be caused by fright, worry, food poisoning, pregnancy and other common conditions.*

---

## Step 3: Know the Warning Signal and have a Battery-Powered Radio

All Canadian communities where there is a likely need are provided, or will be provided, with sirens. Other areas should have warning arrangements based on local systems such as telephones, horns, bells or factory whistles.

Warning devices are only attention-getters. Dependent on the size of your municipality, the sirens, bells, telephones, etc., will sound the Attack Warning.

There is one type of siren warning signal in Canada:

### The ATTACK WARNING Signal

*The ATTACK WARNING Signal:* A wailing (undulating) tone on the sirens of three to five minutes duration or short blasts on horns or other devices repeated as necessary means:

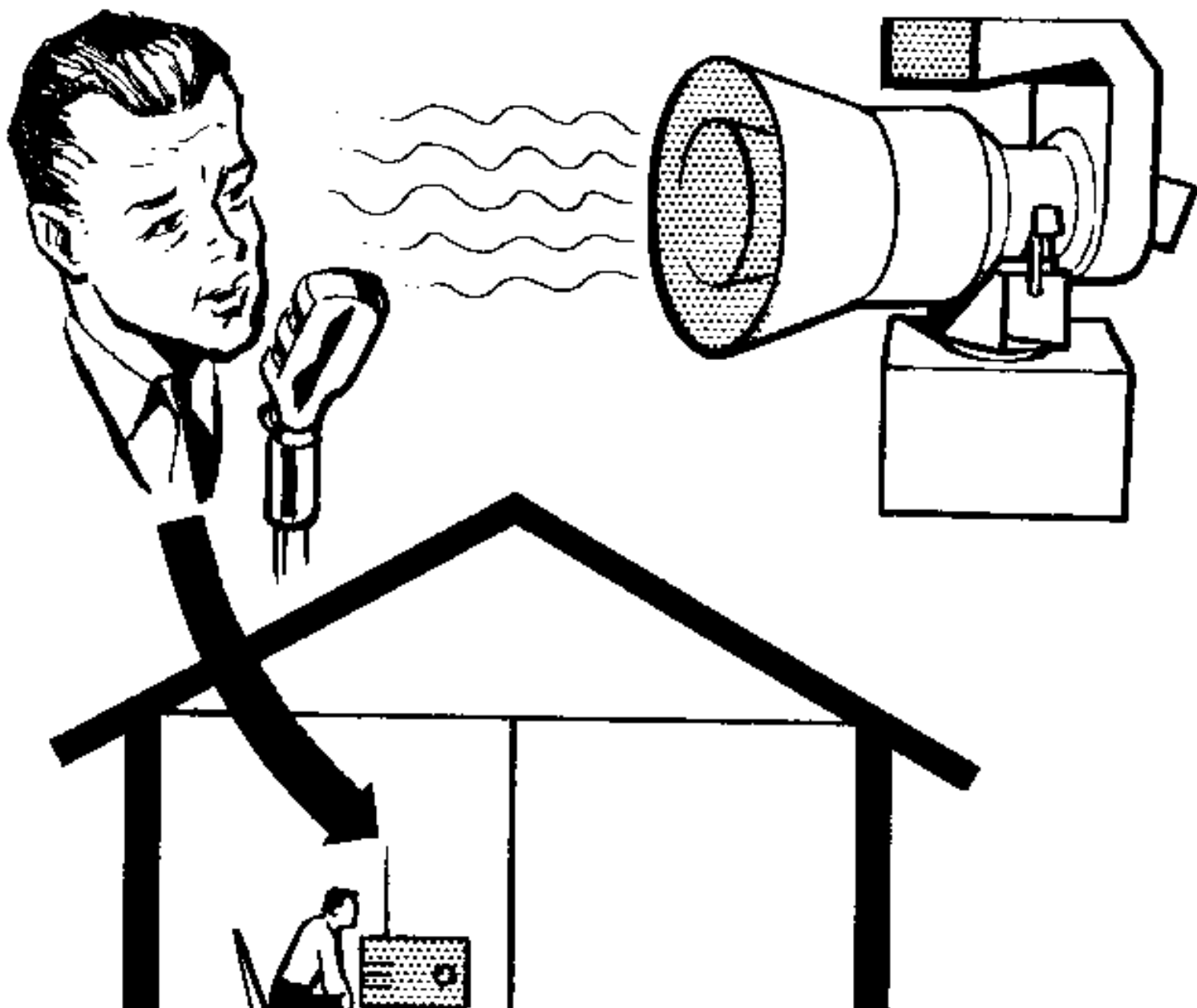
- An attack on North America has been detected;
- Warning of fallout.

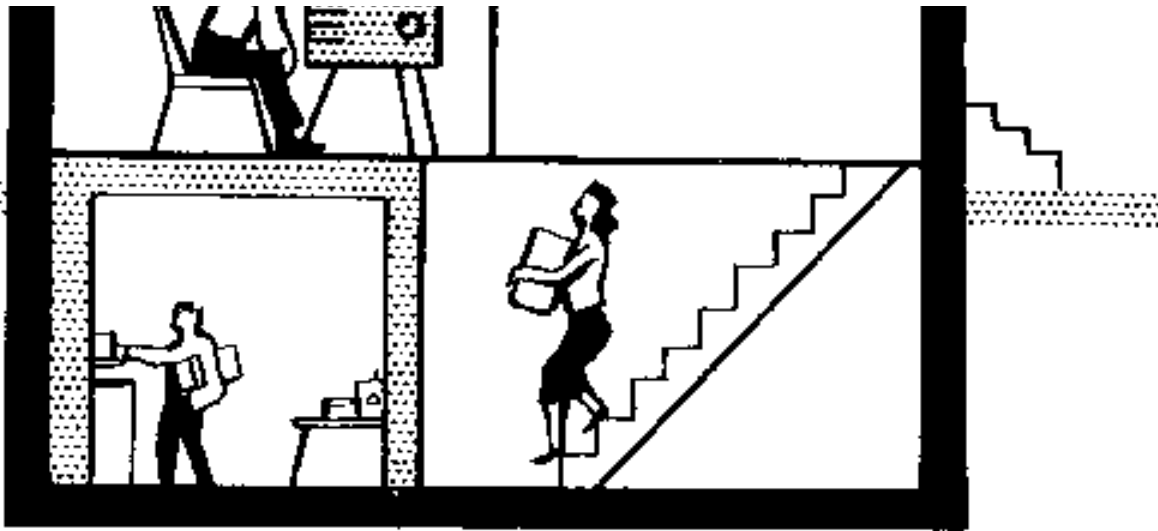
**WHEN YOU HEAR THE WARNING SIGNAL, YOU SHOULD TAKE PROTECTIVE ACTION AND LISTEN TO THE RADIO FOR INSTRUCTIONS.**

## **A Radio is Essential**

When the Attack Warning sounds, you must take protective action. Take a battery-powered radio with you. Broadcast advice and instruction may help to save your life. If you don't have a portable radio, turn up the volume of your house radio so that it can be heard in your shelter. If away from home you are forced to take emergency shelter and are near a radio-equipped vehicle, turn up the volume and open all the vehicle's doors or windows.

The Canadian Emergency Broadcasting System, a network of all Canadian radio and television stations which will be formed when a nuclear attack on Canada has been detected, will tell you when and how to take emergency protective action against possible attack and shelter against fallout if an attack occurs.





## Before Attack

If sirens or warning systems signal impending attack, regardless of where you are or what you are doing, you must take the best available cover against the blast, heat and light effects of nuclear explosions.

Emergency broadcast instructions will include the following advice:

- If you are at home go to the basement or strongest part of your house or building which offers the best protection. If material is handy, improvise blast protection. See Step 4.
- Take your battery radio with you, or turn up the house radio so that you can hear it while under cover.
- Stay away from windows.
- Lie down and protect yourself from flying glass and falling debris.
- Shield your eyes from the flash of an explosion.
- If you are away from home take protective cover immediately.
- If you are travelling, stop and take protective cover immediately, or if you are only a few minutes from a safe destination, proceed and take protective cover immediately.
- Listen to your radio for further instructions.

## After Attack

If sirens or warning systems sound following nuclear attacks, the warning may mean another attack or that radioactive fallout is approaching your area. **You will be advised over the radio.** If the advice concerns fallout, you must take cover against the fallout effects. (See [Step 4](#)).

Radio broadcasts will identify areas which will be affected by the fallout and give instructions and advice. These might include:

- Location of nuclear explosions causing local fallout.
- Information about the parts of the country to be affected by fallout.
- Length of time before fallout is likely to reach specific communities or areas.
- Ways to increase fallout protection.
- Supplies to take to your fallout shelter.

- Whether it is safer to stay in your community or area, or to go to other areas.
- Advice as to which areas are free of danger.
- Advice on when to leave shelters and for how long as danger from radioactive contamination diminishes.
- Requests for help in rescue operations, such as rescue, firefighting and medical assistance.
- Advice on conservation of food, water and fuel.
- How to keep warm when power is off and the weather is cold.

## Don't Use The Telephone

When the sirens sound don't use the telephone. Listen to a radio or television for information. In the event of an Attack Warning telephone lines will be required for official use.

---

## Step 4: Know How to Take Shelter

It is important to provide your family and yourself with a shelter. But what kind of shelter? This is a decision you must make yourself after studying the problem.

Study your shelter requirements in the same way that you would study accident or fire insurance. Decide upon the degree of protection you want for your family and yourself. Shelter is your insurance against something you hope will not happen, but if it does, will give you protection.

Shelters of the type commonly used in Europe during the Second World War would not provide protection against the blast of a nuclear explosion. They were designed to withstand short shock pressures lasting something like 1/100th of a second. Shelters designed to withstand the pressures created by a nuclear explosion must be able to stand up to pressures lasting as long as 6 seconds. In addition, they must be capable of giving the occupants protection against fires outside the shelter as well as against radiation.

The fallout shelter is designed to give protection against radioactive fallout only. Because most people in Canada probably would not be affected by the blast and heat effects of nuclear explosions, protection against fallout is all that is required by them.

The type of shelter for good protection depends upon the distance it will be from the explosion. Unfortunately, it is not possible to know this in advance. That is why each individual must make his own decision when selecting the type of shelter he wishes to have.

*Blueprint for Survival No. 1* gives details of a fallout shelter for the home in which you now live. If you rent the home, the decision to construct a shelter must be taken jointly with your landlord.

*Blueprint for Survival No. 2* gives details of a fallout shelter for the new home you may be planning to build.

*Blueprint for Survival No. 6* gives details of blast shelters which may be built outside the home.

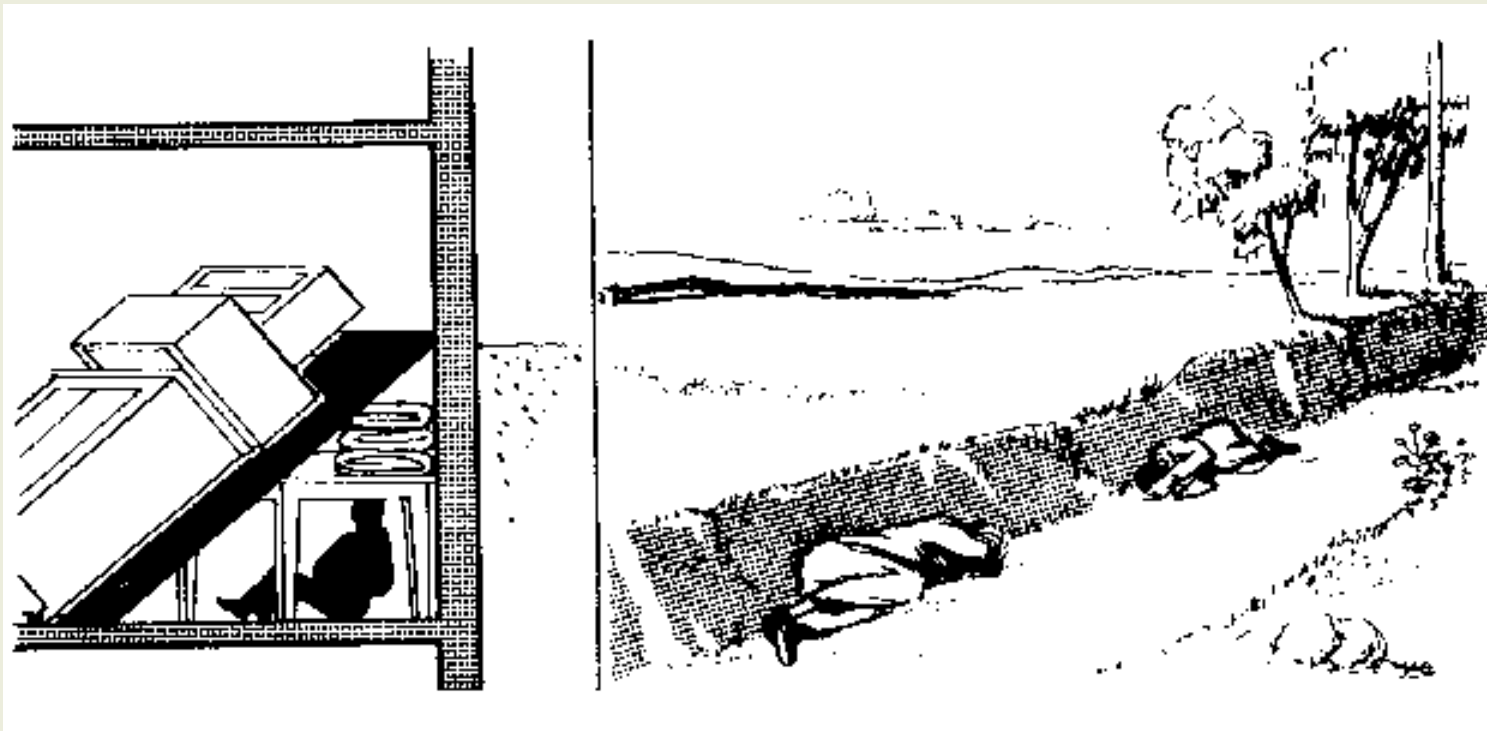
These pamphlets are available from your local Emergency Measures or Civil Defence Organization.



## Improvised Protection Against Blast

One of the simplest ways to improvise some anti-blast protection is to build a lean-to (bed springs or boards) against a work bench or heavy table, preferably in the basement, and pile mattresses on it and at the ends. If the material is readily available it could be built in a matter of minutes after the ATTACK WARNING is sounded and could protect you from loose bricks, flying glass, etc.

If you are in the open and there is a ditch or culvert within easy, quick reach, lie face down in it and cover your face with your arms. Make sure this shelter is not too close to buildings which could collapse into it.



"After" the blast and heat of the explosion, you would have to find other protection against fallout which will come down later. (Don't forget your battery-powered radio).

None of these improvisations is as good as a properly equipped blast shelter, but any single one of them could mean the difference between life and death.

## Improvised Protection Against Fallout

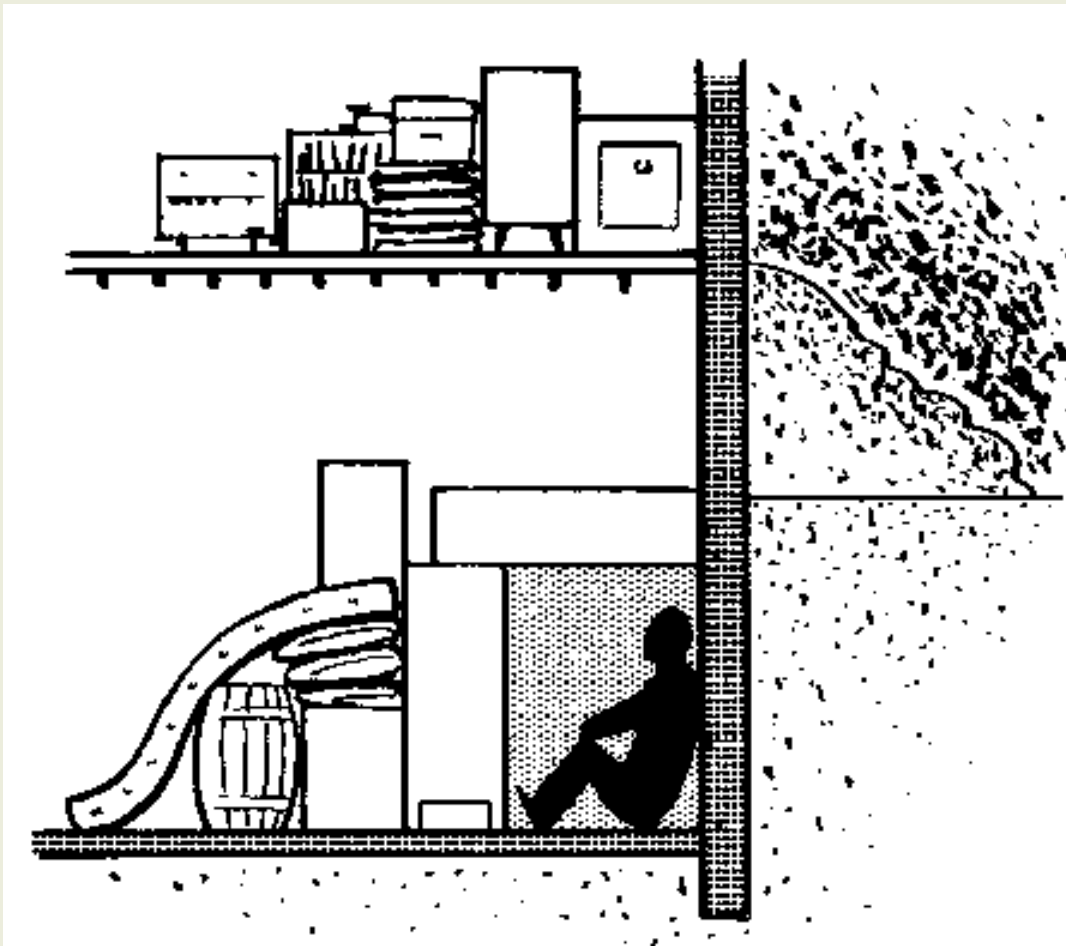
You may not have a fallout shelter when warning of approaching fallout is broadcast. Here are some tips on how to increase your protection in a basement. The amount of protection you can build will depend on how much time you have available until fallout arrives.

- You can improvise a small emergency shelter by using furniture, doors, dressers, work-bench and other materials.
- Select a corner of your basement, if possible away from windows, in which to build your shelter. Remove inside house doors from hinges to use as a shelter roof over supports. Supports for the improvised roof can be cabinets, chests of drawers, work-bench, or anything which will bear a heavy load. Use the house doors as a roof surface to provide a base for the heavy material you will have to place on it. Bricks, concrete blocks, sand-filled drawers or boxes, books or other dense items on the roof will help reduce radiation penetration. Around the sides and front of your shelter build walls of dense materials to provide vertical shielding. A small cabinet or dirt-filled box as may be used as a crawl-in entrance which can be closed behind you.
- Remember, the heavier or more dense the material around you, the greater the protection.
- Block basement windows with earth, bricks, concrete blocks, books or even bundles of newspaper. In winter, use packed snow.
- On the floor above the corner of the you select as your shelter area, pile any heavy objects you may have available, such as furniture, trunks filled with clothes, dirt-filled boxes, books, newspapers, or earth from outside.
- Outside, against above ground walls of the basement around your shelter area heap earth, sand, bricks,

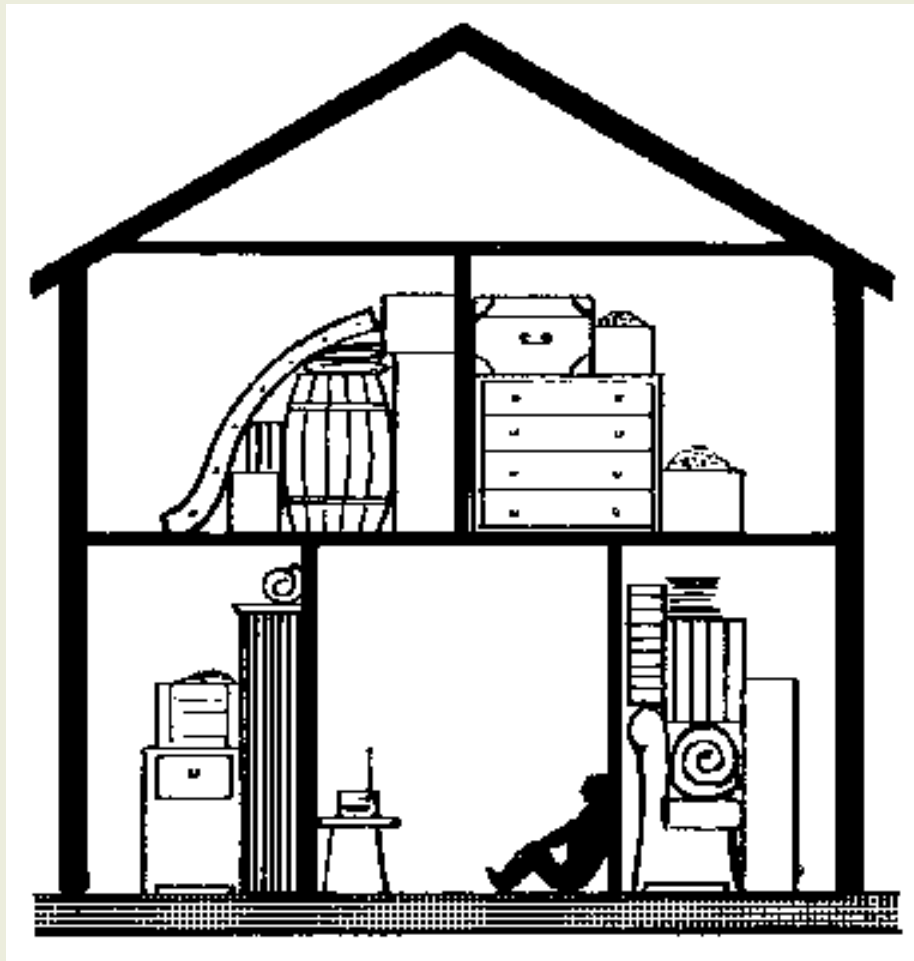
concrete blocks or packed snow.







If your home has no basement or crawl space, build your emergency shelter in that part of the house (centre hall or clothes closet) farthest away from outside walls and the roof. Build it as described for houses with basements. On the floor immediately above your shelter area, and against surrounding walls, pile up furniture, trunks, dressers, dirtfilled boxes or other heavy material which will reduce radio-active penetration into your emergency shelter.



## Step 5: Have 14 Days Emergency Supplies

Nuclear attacks on centres of production, and fallout conditions, may curtail the distribution of available food stocks for several days or even weeks following these attacks. Persons who had taken shelter against fallout might be advised to stay in their shelters for as long as 14 days. Those who had chosen to evacuate larger cities would be dependent largely on the resources available in reception towns. Because of these possibilities, it is recommended that every person should have emergency supplies. These supplies should include food, water, battery-powered radio, first aid kit, and where necessary, medical supplies as recommended in [Step 7](#). Heavy clothing would be necessary in winter. Extra changes of clothing should be considered particularly stockings and underclothing.

For those who may choose to evacuate major centres, supplies must be selected carefully because of space limitation in the family car. Supplies should be packaged beforehand so that they can quickly be put into the car. See the pamphlet "Your Emergency Pack" available from your local Emergency Measures or Civil Defence Organization.

Many of the recommended items are already in your home.

Whether you choose to evacuate or take shelter locally, you should have a road map with you. You could then relate the information about areas under fallout, which you would hear about on the radio, to your actual location. Toys, games, books for your children would help to occupy their time if they had to remain in shelter from fallout. Your battery-powered radio will keep you in contact with the outside world.

The following is a suggested list of items from which your two weeks' supplies should be developed to be in your shelter or handy to it.

## Equipment

- Beds (bunks or folding)
- Bedding
- Toilet
- Polyethylene bags for toilet
- Table (folding or other)
- Stools (folding)
- Cups and plates (disposable)
- Knives, forks, spoons
- Can opener
- Cooking utensils
- Kerosene cooker (*Do **not** use a pressurized stove in the confines of your shelter.*)
- Kerosene lamp
- Kerosene (sufficient for 14 days)
- Candles
- Safety matches
- Hand basin
- Calendar
- Paper towels
- Garbage can (two if no waste water runoff is possible)
- Garbage bags
- Shovel
- Broom
- Battery radio and spare batteries
- Electric lamp and spare bulbs
- Clock
- Flashlight and spare batteries
- Fire extinguisher
- Hand tools
- Pocket knife
- Axe
- String
- Light rope

## Recreational

- Books
- Paper
- Pencils
- Playing cards
- Chess, checkers, other games
- Crosswords, other puzzles
- Knitting, sewing, etc.

- Hobby materials
- Plasticine

## Toiletries

- Soap
- Toothpaste
- Toothbrushes
- Detergent
- Nail brush
- Razor, blades and soap
- Women's basic cosmetics
- Tissues (face and toilet)
- Face cloth
- Towels
- Brush and comb

## Clothing and Personal Items

Coveralls, rubber boots, rubber gloves for adults. To be used in venturing outside even after instructions have been given that this is safe for short periods.

- Bedding (blankets preferable)
- Warm sweaters and socks
- Change of underclothing and socks
- Personal hygiene items for women
- Baby clothes
- Baby feeding equipment
- Disposable diapers (two-week supply)
- Legal papers
- Plastic sheeting

## Medical

(See [Step 7](#))

## Food

These are suggested items and amounts for each adult for 14 days in shelter. Check off the items as you stock them in the shelter and mark the purchase date on them. Food stored for emergency use should be used and replaced at least once a year.

- Milk: 14 cans (6-oz) or 6 cans (15-oz) evaporated milk or 1-lb dried skim milk
- Vegetables: 6 cans (15 or 20-oz) - beans, peas, tomatoes, corn
- Fruits: 6 cans (15 or 20-oz) Ä peaches, pears, apple sauce
- Juices: 6 cans (20-oz) Ä apple, grapefruit, lemon, orange and tomato

- Cereals: 14 individual packages (sealed in wax bags inside or outside)
- Biscuits:
  - 2 packages of crackers (1-lb. each)
  - 2 packages of cookies or graham wafers
- Main Dish Items:
  - 2 cans meat (12-oz) - corned beef, luncheon meats
  - 2 cans beef and gravy
  - 2 cans baked beans (15 or 20-oz)
  - 2 jars cheese
  - 2 cans fish (8-oz)
- Canned and Dehydrated Soups: 2 cans (10-oz) - bean, pea, tomato, vegetable

## Other Foods:

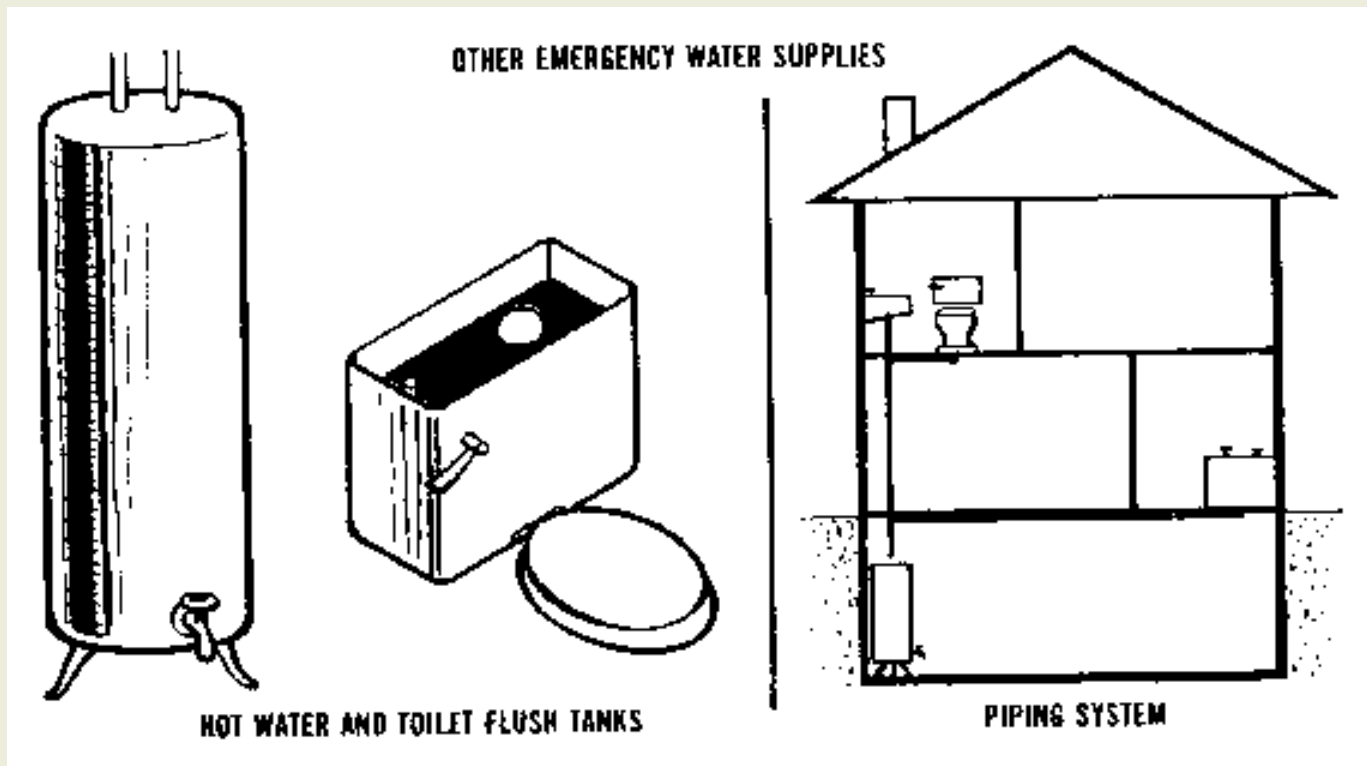
- 1 large jar or can honey, syrup, jam or marmalade
- 2 lbs. hard candy
- 1 jar or can peanut butter
- 1 package tea bags or instant tea
- 1 jar sugar
- 1 jar instant coffee
- Salt and pepper
- Instant chocolate powder
- Chewing gum

## Special Requirements for Children

- For each infant include 14 cans evaporated milk (15 oz) and infant food for 14 days.
- For each child up to 3 years, include 8 extra cans of milk.
- Decrease amounts of other foods according to appetite.
- Food for older children can be the same as for adults; adjust amounts according to appetite.

## Water

- Requirements: 7-14 gallons for each adult member of family; more for younger children (some water may be replaced by canned beverages).
- Containers: Store in well-cleaned, covered containers such as large thermos jugs, new fuel cans, large bottles, or plastic containers.
- Change: Change stored water at least once a month.



## Step 6: Know How To Prevent And Fight Fires

Misinformation about the fire danger from nuclear explosions is widespread and common. For example, some persons believe that the fire-ball would completely incinerate a city. This is not true.

The heat from the fire-ball lasts about 15 seconds and would create fires which are no different from the fires you see in peacetime. They can be put out with water and extinguishers, and if each survivor were able to put out a small fire quickly, mass fires would not take place.

The heat flash from the fire-ball entering through windows and doors could set fire to curtains, clothes, furniture and paper. Other fires could break out in attics, in backyard trash, on wooden shingles and on the outside of houses built of wood particularly if they are unpainted or weathered.

Knowing how to prevent and fight fires at home and at work reduces the number of peacetime fires. The same knowledge will also reduce the number of fires caused by a nuclear explosion.

But how can you fight fires in the presence of fallout? From 5 to 15 miles from the centre of the explosion, there will be many survivors. Fallout will not start coming down for about 30 minutes. During this half hour, survivors should inspect their houses and put out all the small fires they can. They must not rely on the fire department to extinguish these fires.

You should have in your home and place of work, fire extinguishers, or in an emergency, create a water supply for fire fighting in pails, bathtubs, washtubs, etc. Don't rely on being able to use the established water supply system.

Even those who live in areas not attacked may find their fire departments will have to fight major fires elsewhere.

Every householder should learn how to carry out fire prevention and know how to fight small fires. It may prove of value in peacetime!

Your local fire authorities are always anxious to advise you on how to fight fires. Attend any emergency fire fighting classes held in your area.

Here are some tips for an emergency:

- Prepare for emergency by preventing accumulations of trash and rubbish in and around the home. This would include dry leaves and grass, lumber, boxes, cardboard cartons, old unused furniture, bales of newspapers, etc. Keep waste and garbage in covered containers.
- The shaking and twisting of buildings and homes due to blast waves in wartime or earthquakes and explosions in peacetime, may break utility inlets at the point they enter the structure. This may allow gas or fuel oil to flow into basements creating a severe hazard. Do not smoke, strike a match, or a lighter, to light your way into a darkened basement. Gas or oil vapours may be present and a violent explosion and fire may result.
- To lessen the danger of fires and explosions follow local instructions about shutting off utility services when the ATTACK WARNING sounds.
- If you have a coal-burning furnace, or a wood-stove, extinguish it or at least be sure to close all fuel and draft doors.
- Close curtains shutters or venetian blinds on all windows and remove furniture from window areas.



## TO FIGHT AN ORDINARY FIRE:

- **Take away its fuel.** Get the burning material out of your home.
- **Take away its air.** Smother it with a blanket, wet if possible, or a rug.
- **Cool it** with water, earth, sand or fire extinguisher.

## GAS, OIL, ELECTRICAL FIRES REQUIRE SPECIAL METHODS:

- **Gas fire:** Make sure the gas is shut off and then try to extinguish anything still burning.
- **Oil fires:** Make sure the supply is shut off then smother the fire with earth, sand, rugs or other heavy materials. Don't use water.
- **Electrical fires:** Make sure the electricity is shut off then put out the fire. Don't use water if the power is still on.

## PROMPT ACTION TO PUT OUT SMALL FIRES IMMEDIATELY FOLLOWING A NUCLEAR ATTACK WILL SAVE LIVES.

---

## Step 7: Know First Aid And Home Nursing

The acquisition of First Aid and Home Nursing skills prepares individuals to serve effectively in a national emergency. If such an emergency occurs, the care of many thousands of injured or seriously ill persons becomes a tremendous task for the organized health services. Doctors and nurses may not be readily available to assist you. Thus the importance of First Aid and Home Nursing skills takes on a new dimension. The survival of the injured or sick members of your family may become your responsibility.

The main objectives of training individuals in first aid and home nursing are:

1. To preserve life
2. To minimize the effects of injury or illness
3. To relieve suffering or distress
4. To provide continuing care and assist in rehabilitation.

Therefore you must:

- Know and practice life-saving first aid.
- Know and practice simple home nursing measures.

## First Aid Supplies

A simple first aid box kept in your shelter or in your evacuation kit should contain:

- 1 bottle mild antiseptic solution (use to clean cuts)



- 5 yards 2-inch gauze bandage
- 2 triangular bandages (use for slings)
- 12 4" x 4" sterile pads (use to cover cuts, wounds and burns)
- 12 assorted individual adhesive dressings (use for minor cuts)
- 2 large dressing pads (shell dressing type) 8" x 8" (Available at minimal cost from St. John Ambulance Association)
- 5 yards 1/2 inch adhesive tape
- 9 assorted safety pins
- 1 small bottle toothache drops (for temporary treatment of toothache)
- 1 tube of petroleum jelly
- 1 small bottle aspirin tablets
- 1 thermometer
- 1 small scissors (blunt ended)
- 1 medicine glass
- 1 pair tweezers
- 4 oz baking soda and 8 oz table salt (make a drinking solution by adding 1 tsp salt and 1/2 tsp baking soda to 1 qt. of water)
- 1 First Aid Manual (St. John Ambulance Association)
- 1 Home Nursing Textbook (St. John Ambulance Association and/or Canadian Red Cross Society)
- 1 packet paper tissues

**NOTE:** individuals requiring special medication such as insulin should maintain at least 100-days supplies.

## First Aid Hints

### *General Rules:*

- Keep calm.
- Keep the injured person lying down in a comfortable position, his head level with his body until you determine whether his injuries are serious.
- Examine for stoppage of breathing, serious bleeding or broken bones. These must be treated immediately before any attempt is made to move the injured person. Do not be hurried into this unless you are in a situation of extreme danger.
- Keep him comfortably warm with blankets or other coverings, under and above the patient.
- Never attempt to give a semi-conscious or unconscious person anything to drink.

### *Unconsciousness:*

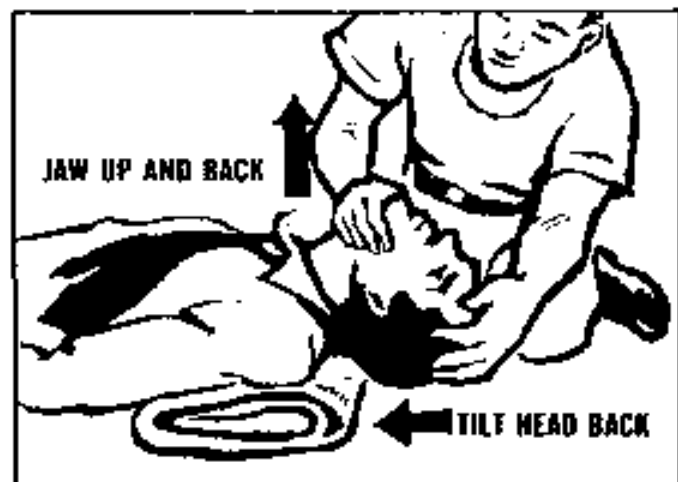
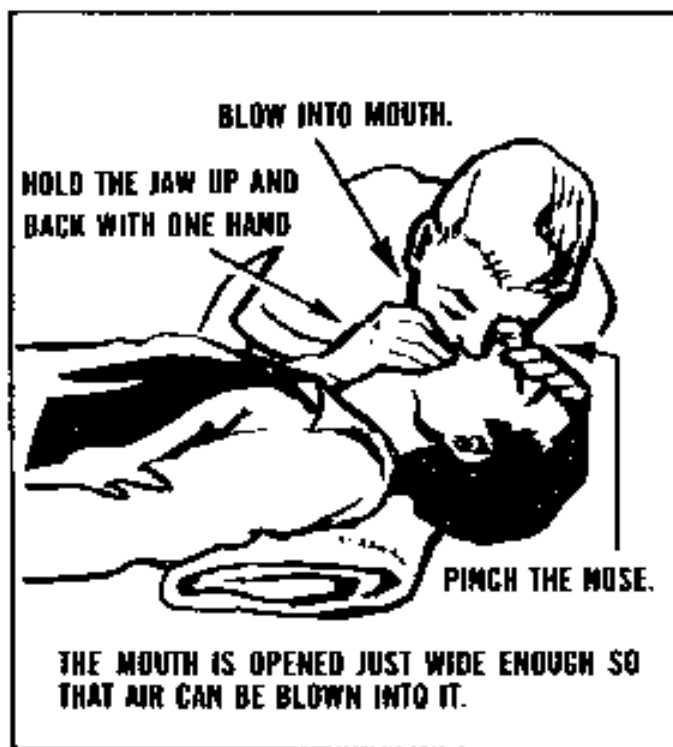
An unconscious patient lying on his back may be strangled by his own tongue which will tend to fall back and obstruct the airway. All unconscious persons should be placed lying half over on their faces, (three-quarter-prone position).

If the patient is breathing quietly and easily and his lips are pink and have no froth on them, breathing is not obstructed.

If the patient is breathing noisily and with difficulty, if his lips are blue and frothing, or if his chest is sucked inwards when he breathes in, his airway is obstructed and needs immediate attention.

*Keep the airway clear by:*

Placing the casualty on his back; supporting his shoulders on a pad of any suitable material available; tilting the head back with one hand on the forehead, the other lifting the neck.



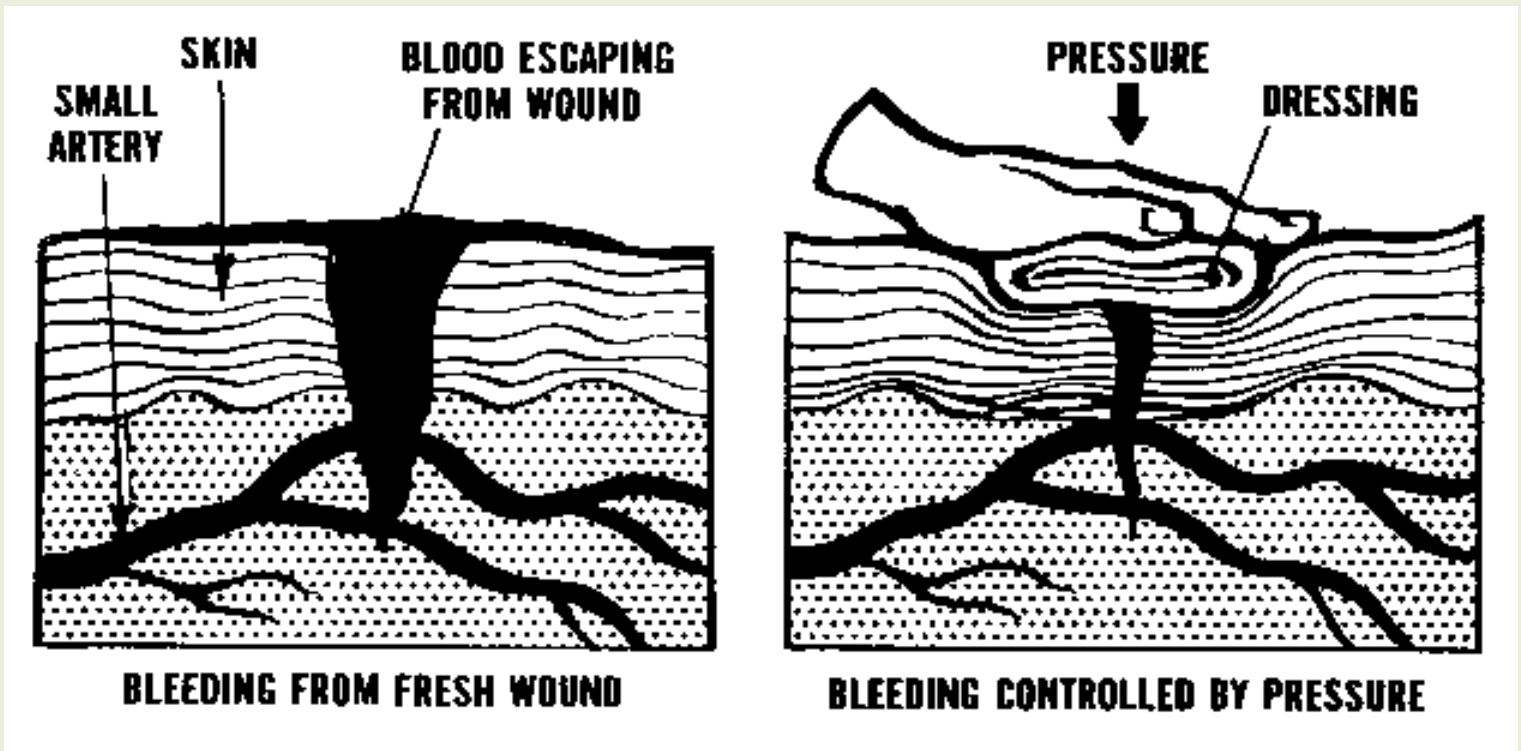
If his breathing stops you can breathe for the patient by blowing air into his lungs. Take a deep breath. Pinch the casualty's nostrils. Place mouth to mouth tightly. Blow into the casualty's lungs strongly enough to cause his chest to rise. The cycle should be repeated every 3 to 5 seconds for an adult and a little more frequently for a child. Blow more gently for a child or a baby, but strongly enough to make the chest rise.

*Wounds:*

*You Must:*

- Stop bleeding (haemorrhage)
- Keep out germs (infection)

Cover the wound with a clean dressing to keep out dirt and germs. Bandage it on firmly to stop the bleeding. If a wound is bleeding profusely, hold it firmly with your hand until you can secure an emergency dressing. Any thick pad of clean, soft, compressible material large enough to cover the wound will make a good dressing. Clean handkerchiefs, towels, sanitary pads, tissue handkerchiefs or sheets make good emergency dressings.



*Burns:*

Cover the burned area with large, thick, dry dressing and bandage it on firmly.

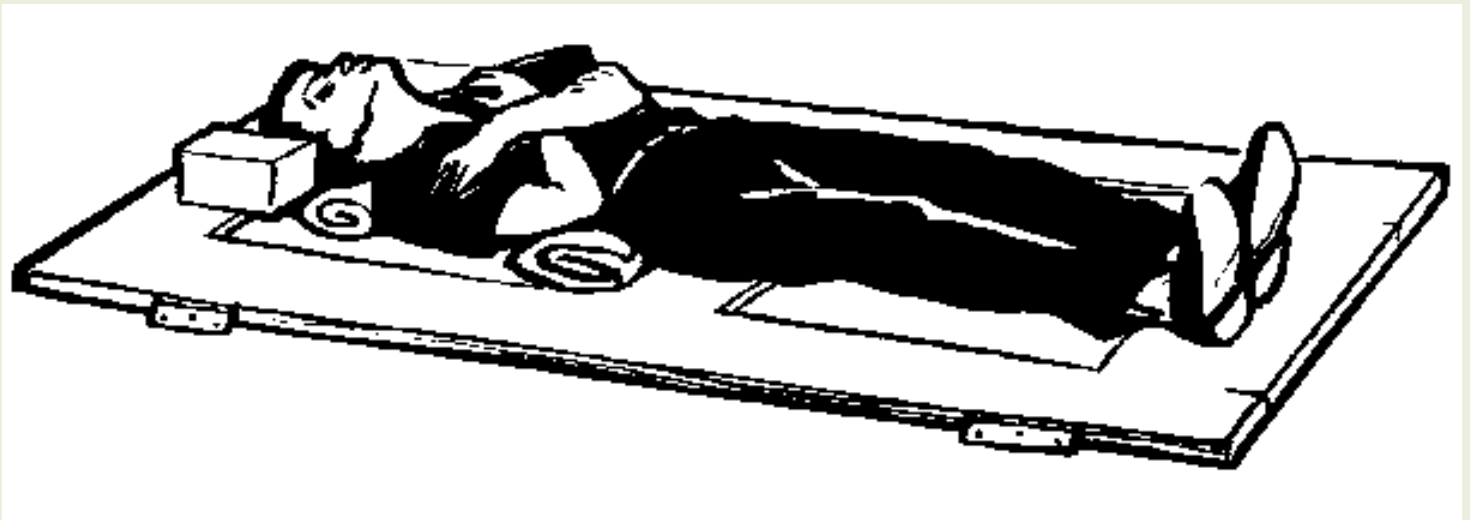
Encourage the casualty to drink plenty of fluids. A solution of salt and soda is useful to give to casualties with burns and to those who have suffered from serious bleeding.

*Broken bones (fractures):*

If a limb is very painful and cannot be used, appears to be bent in the wrong place or the casualty says he heard or felt the bone snap, it is likely that a bone is broken.

Sharp ends of a broken bone may damage important structures such as blood vessels and nerves. A broken limb should be steadied and supported to prevent movement of the broken ends before attempting to move the patient.

If a person's back or neck is so severely injured that he is afraid to move because of pain, or cannot move or feel his limbs, you should assume that he has a broken back. He should be moved on a hard, firm stretcher taking great care not to "jack-knife" him by picking up his feet and shoulders. Improvised stretchers can be made from a door, wide board, window shutter, etc. Fill in the natural hollows of the track and neck with padding and support the head on both sides to prevent movement.



## DO NOT:

- Put strong antiseptics into a wound.
- Use a tourniquet.
- Remove clothing which is stuck to a burn.
- Break any blisters or apply creams or grease to a large burn.
- Give anything by mouth to a semi-conscious patient, or to a patient with internal abdominal wounds.

## HOME NURSING HINTS

Before medical or nursing help becomes available you may also encounter infant care problems, emotional problems and persons suffering from radiation sickness. What to observe, and what to do for these latter cases, is outlined below.

### Infant Care

Breast feeding is preferable but, if not possible, then a formula using powdered or evaporated milk should be prepared under clean conditions.

If vomiting or diarrhoea occurs infants and children become dehydrated very quickly. To avoid this happening give frequent sips of boiled water.

If a rash or fever develops, keep others away from the sick child.

### Emotional Problems

Persons who become emotionally disturbed following a disaster should be treated calmly but firmly. They should be kept in small groups, preferably with persons whom they know and encouraged to "talk out" their problem. If they are not otherwise injured they should be given something to do. It may be necessary to enlist the aid of one other calm person to help subdue the overexcited patient. If a stunned or dazed reaction persists over 6 to 8 hours this should be reported to a doctor or nurse immediately one becomes available.

## Radiation Sickness

The signs and symptoms of this illness are described in [Step 2](#).

Treatment includes rest, the provision of whatever nutritional food and drink is available and personal encouragement to get well. Swab the mouth gently with mild, warm salt and water if it becomes sore. As these patients are susceptible to infection, keep wounds clean and covered with a sterile dressing. Separate these patients from persons with colds, rash or fever.

## Improvised Equipment

The following suggestions may help you care for your patient when proper equipment is not available.

- Bed: A couch, mattress or any well padded, firm surface; if too low raise on bricks, boxes or wooden blocks.
- Bedding Protection: Old crib pads cut into a convenient size and placed over a waterproof sheeting; or several layers of newspaper and heavy brown paper covered with old soft cotton. (Never use thin plastic if patient is a child.)
- Backrest: A straight-backed chair turned upside down at head of bed and securely tied to bed; a triangular bolster or cushions from a chair or chesterfield.
- Bed Cradle: A light wooden box or firm cardboard carton approximately 10 x 12 x 24 inches, with two sides removed; or a hoop sawn in half and the two pieces joined together in the centre.
- Pressure Pads: Soft cushion or foam or sponge rubber pads will protect heels, elbows, back of head or any other body pressure point.
- Bedpan or Urinal: For bedpan use a padded dish or pan; for urinal any wide-necked bottle or jar.
- Hot Water Bottle: A heated brick wrapped in several layers of newspaper.

## ***START TRAINING NOW!***

## **ONE PERSON IN EVERY FAMILY SHOULD BE TRAINED IN FIRST AID AND/OR HOME NURSING.**

Courses in these skills are available in most municipalities from your local St. John Ambulance Association or Canadian Red Cross Society.

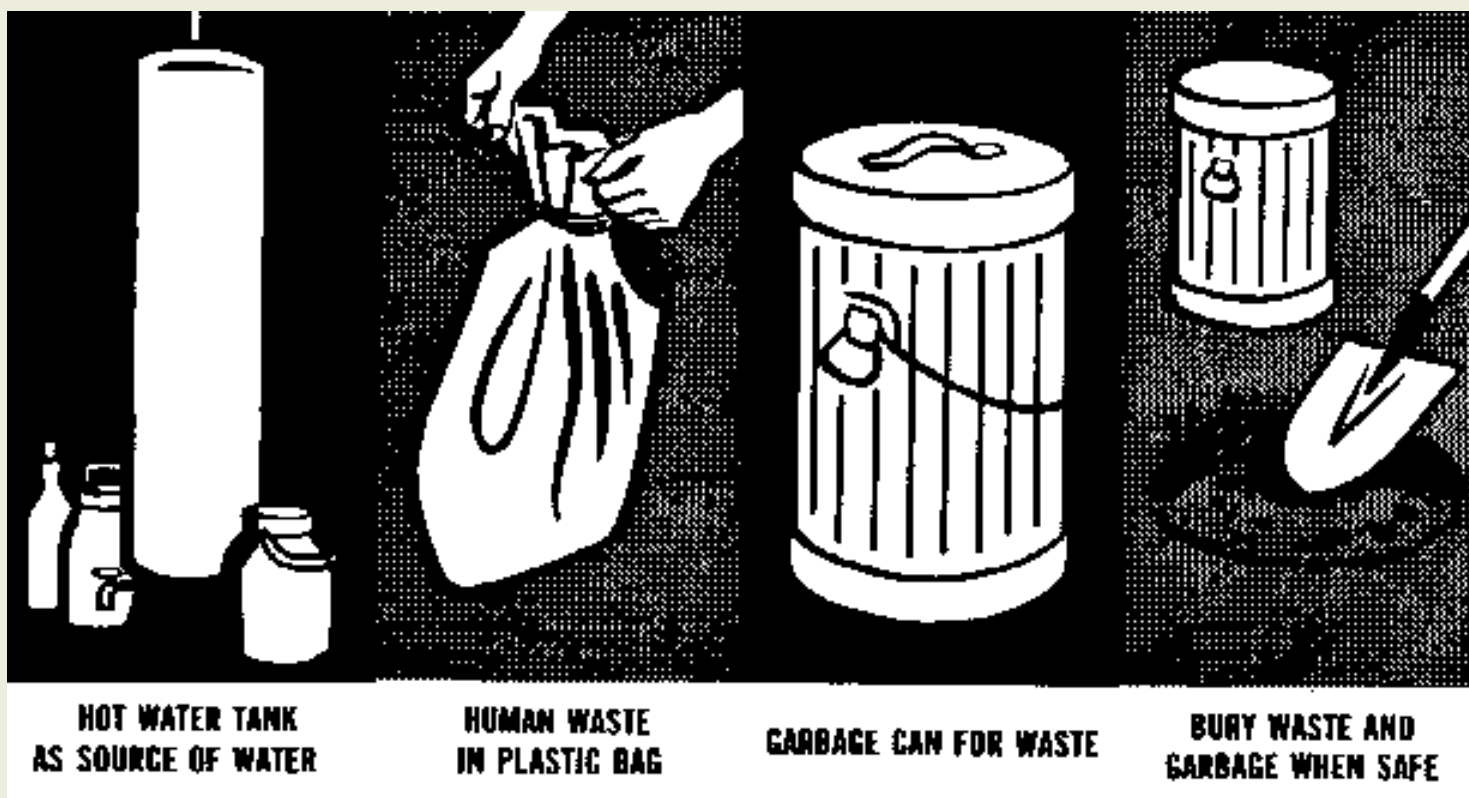
## **REGISTER NOW!**

---

## **Step 8: Know Emergency Cleanliness**

Your limited supply of water will have to be rationed and used only for essential purposes. If you have enough warning time before the arrival of fallout, fill your bathtub, all available buckets and pans with water. And remember that there is an emergency supply in your hot water tank. (Don't forget this if in peacetime your water supply has been temporarily disrupted).

The problems of garbage and human waste disposal can be solved even if fallout keeps you in the shelter. Put all your garbage in tightly covered garbage pails. After using your emergency toilet, you should tie human waste in waterproof plastic (polyethylene) bags and place them in the garbage pail. Store a 14-day supply of the plastic bags. After the second day in the shelter, you may risk leaving it for a few minutes for essential tasks. Therefore, when your garbage container is filled, move it out of the shelter.



Keep a soft broom in the shelter for tidying it up.

Remember, personal cleanliness in crowded shelter conditions is important to you and your family.

If your area is free of fallout but is without sewage services, bury human waste and garbage in the ground. Dig the pit deep enough so that the waste will be covered by at least two feet of earth.

## Step 9: Know How To Get Rid Of Radioactive Dust

In [Step 2](#), fallout was described as "sand". To remove the danger, remove the sand. If you suspect that your clothes have fallout on them, remove your outer clothing before you come inside your home and leave it outside. Don't shake these clothes inside the house or shelter. You would only scatter the fallout grit and create unnecessary danger to others. If you have water, wash thoroughly, particularly exposed skin and hair. But do not scrub your skin as this might rub in the radioactive particles.

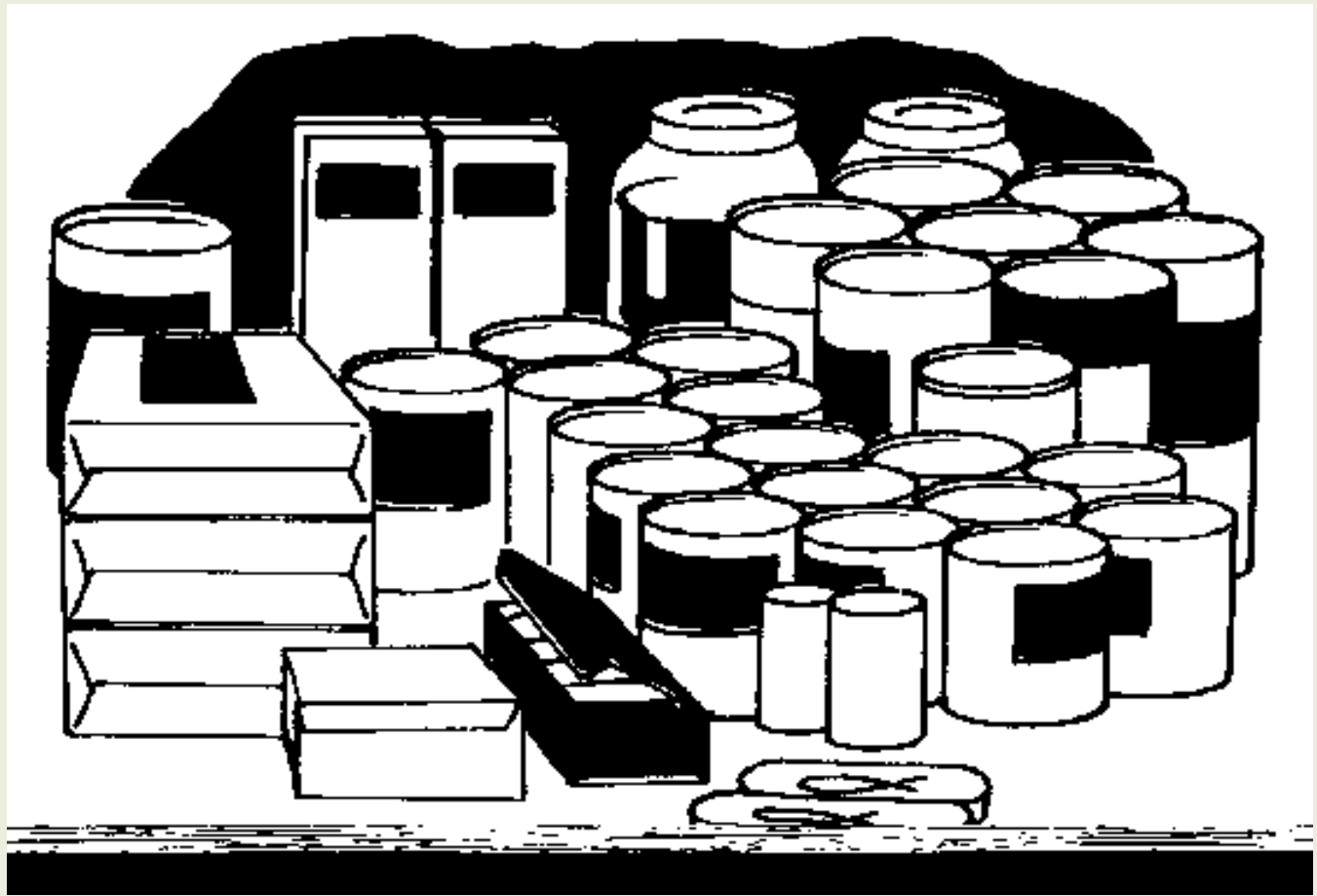
*Exposure to fallout does not make you radioactive.*

Even if you are stricken with radiation sickness, *this sickness cannot be passed on to others.*

Fallout on your clothing or body would expose you and those close to you to radiation. If you suspect you have been exposed to fallout, you will not be a danger to others if you carefully get rid of your outer clothing outside the shelter and wash.



## Food and Water



Since most of your food will be in tightly covered containers (cans, bottles, plastic, boxes), it will all be safe to eat or drink if you dust the containers. Food, if it is unspoiled and free of grit or dust, may be eaten during the emergency period.

Be sure to wash fruit and vegetables and peel carefully.

Water will be safe if it is in covered containers, or if it has come from covered wells, or from undamaged water systems.

---

## Step 10: Know Your Municipal Plan

It is important that your local municipality have a plan for a war emergency. And it is just as important that you know that plan.

Over the past several years, provincial and municipal governments, with the assistance of federal authorities, have been steadily developing plans for the protection of the population and the continuity of essential government services in wartime. Most municipalities in Canada have emergency plans to deal with both peacetime disasters and a nuclear attack situation. These include the details of how welfare, health, police, public utilities, fire and other emergency services will operate.

Some larger communities have developed plans to assist in the evacuation of those who would choose to leave before



an attack or who might have to be evacuated as survivors or casualties following an attack. These plans include traffic arrangements to reception centres and medical facilities in nearby communities.

It would be unwise to try and prepare your own family survival plan without first checking to see how it fits in with municipal plans. This would be true whether you plan to go to a safer area before attack or remain at home. It is particularly important that you know and understand the arrangements to instruct the public about staying in shelter and coming out of shelter when it is safe. Fallout is a health hazard which will require countermeasures for personal and family protection including assessment of radiation and advice and instructions to those in shelter.

There must be close understanding and cooperation between the public and municipal authorities responsible for their protection.

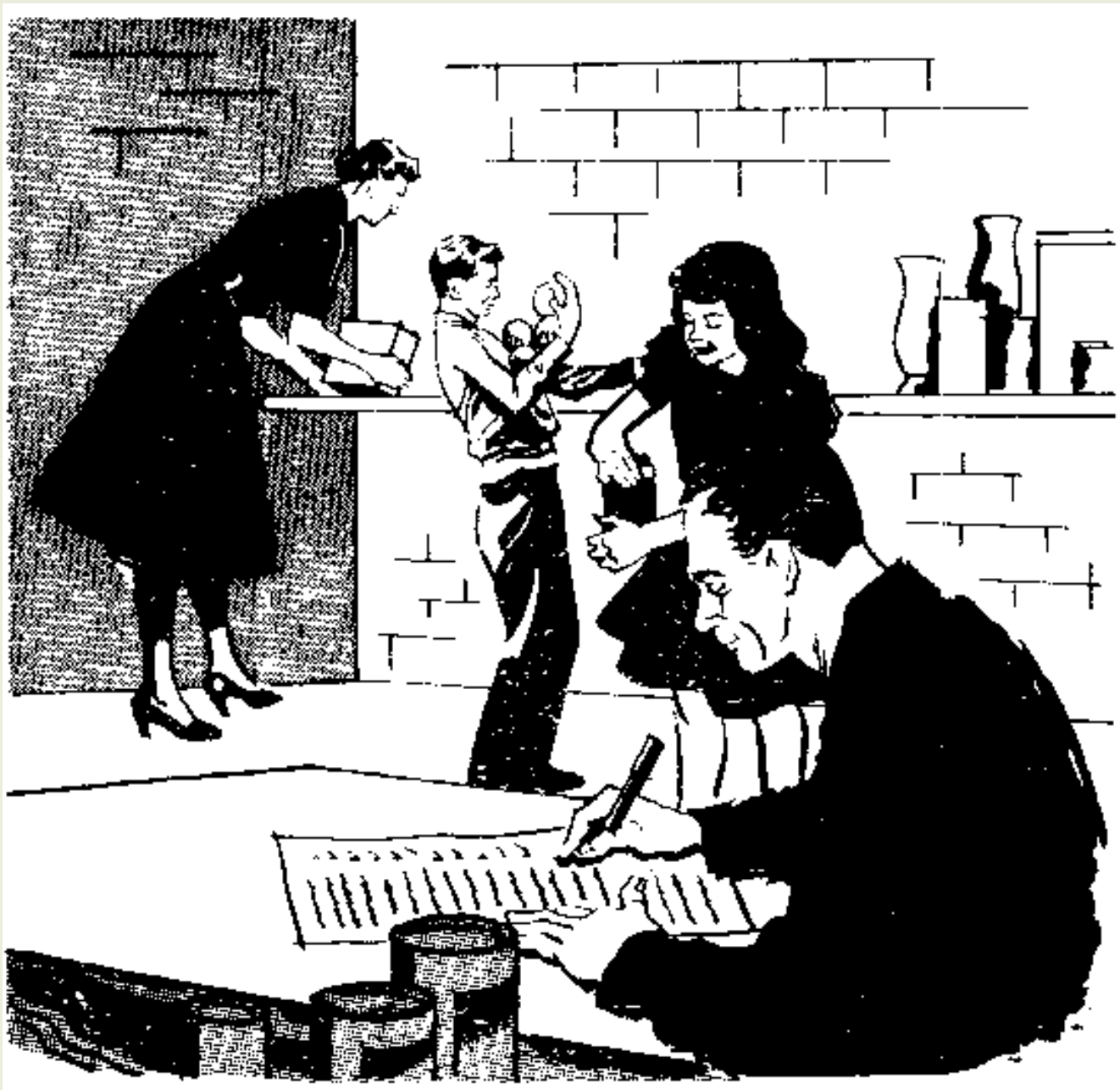
Find out about your municipal emergency plans now and keep well informed about them as they are further developed.

---

## **Step 11: Have A Plan For Your Family And Yourself**

If you know what is contained in the first nine steps, and you know your municipal plan for a war emergency, you should now make your personal and family survival plan. The success of your plan will depend on how many of the suggested recommendations you carry out. Your chances of survival increase as you carry out each recommendation.

Thinking about the problems with which you would be faced should nuclear attack be launched against North America is the first important step. Blast, light, heat and radioactive fallout are the problems. A workable survival plan will include all of the preparations you can make in advance to meet those problems.



In making that plan, there are certain things you must know:

## When to take protective action

When the sirens or other warning devices sound and your local broadcast station confirms that an attack on North America has been detected it means that you must take protective action immediately. Would you and your family

- Recognize the Attack Warning signal ?
- Turn on the radio or television and listen for instructions?

## Where to take shelter

Deciding where you will take initial protective action and where you and your family will seek shelter from fallout are two basic points which you must consider in making your survival plan. Can you answer the following questions

about seeking immediate protection and shelter:

- Have you decided where you will take shelter if you're not at home when the Attack Warning sounds?
- Will you try to get home?
- Will your family know what to do if you are not at home?
- Is there a shelter plan for your children at school?
- Do you want them to try to get home?
- Does everybody in your family know your survival plan?

In thinking about what you will do or where you would go, you might consider leaving your home to find shelter elsewhere. Before you decide to plan on evacuation, consider the following questions:

- Will protection there be better than in your home?
- Are there sufficient supplies there?
- Can you carry emergency supplies for 14 days?
- Do you know how to get there quickly?

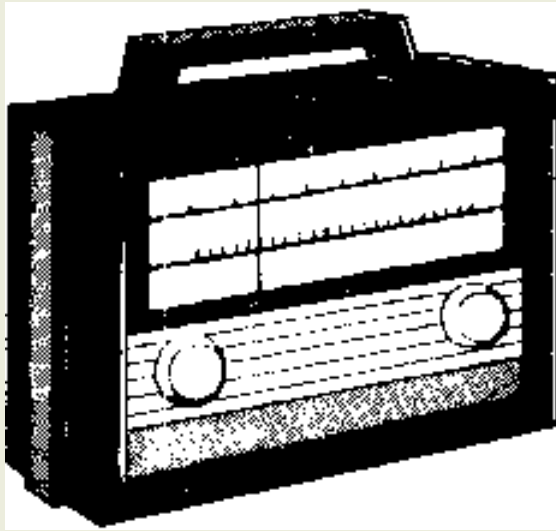
## How to take shelter

If you don't have a fallout shelter built in your home, study the guide given in [Step 4](#). It shows how you can improvise emergency home protection. Bearing in mind that density and distance between you and the fallout is necessary, try to estimate if there is enough material and furniture to build an emergency shelter in your basement or the central part of your house.

- Can you move it to where it will be needed quickly?
- Will you have the help you require?

Based on the lists of emergency supplies suggested in Steps [5](#), [6](#), [7](#) and [8](#), try to answer the following questions:

- Do you have them at home?
- Can you collect and move them to the shelter area quickly?
- Does your emergency cooker, lamp, flashlight, radio work?
- Have you containers for water, garbage, hygiene?
- **DO YOU HAVE A BATTERY RADIO AND SPARE BATTERIES?**



There are many other points which you and your family must resolve for a workable survival plan. This booklet provides most of the essential information on which to base your plans. Read the Steps again, and, as you review each Step, try to answer the questions which apply to your surroundings, your home, your family. Here are a few more which may help:

- Do I know the recommended fire precautions?
- Does anyone in my family know how to fight small fires?
- Can an emergency supply of water be obtained quickly - for fire fighting? for personal use?
- Are first aid supplies and special medicines readily available?
- Does anyone in my family know how to render first aid?
- Can materials for personal hygiene and cleanliness be gathered near the shelter area quickly?
- Do I know what I must do about radioactive dust?
- Do I know the emergency plans of my municipality - for public shelters? for planned evacuation routes? for schools, hospitals, welfare centres? other special instructions?

### **REMEMBER! YOU MUST PLAN FOR:**

- **PROTECTIVE ACTION WHEN WARNED OF ATTACK and**
- **PROVISION OF SHELTER AGAINST THE EFFECTS OF FALLOUT**

On the basis of what you've read and the questions and answers you've thought about, you should now make your survival plan and start making whatever arrangements you can. **BUT MAKE SURE THAT ALL MEMBERS OF YOUR FAMILY KNOW YOUR PLAN AND WHAT TO DO WHEN THE TIME COMES.**

The best way to arrive at a workable plan which will be remembered by your family is to practice it. If you plan on building an emergency shelter, try it now to find out if you have enough material, how much help you'll need, if your proposed area is large enough, and how long it will take to build. Locate and practice moving essential supplies, water, clothing, bedding, etc. Practice the essential things you would have to do.

If you plan to move to what you consider a safer location, make a practice run to make sure you know the quickest and safest route, that protection is available when you get there, and that you can carry all the supplies you think you'll need.

# A GOOD SURVIVAL PLAN IS A PLAN WHICH YOU KNOW YOU CAN CARRY OUT.

## WRITE DOWN THE IMPORTANT PARTS OF YOUR PLAN.

List for quick reference the important things to be done in the event of warning. As examples, note when and where all members of your family will take shelter at all times; where essential items of food, shelter and other supplies will be obtained; how shelter will be improvised; what windows must be blocked; if you plan on going to what you consider a safer area, details of the route and supplies you will need at your destination.

---

**MENU:** [HOME](#) » [SURVIVAL](#) » [Index of States](#)

# Embedded Secure Document

The file *file:///E:/PROPHECYKEEPERS/data/POST-NUCLEAR-WAR/d\_resources/survival/books/11steps/11\_steps.pdf* is a secure document that has been embedded in this document. Double click the pushpin to view.



*Your*  
**BASEMENT  
FALLOUT  
SHELTER**

**BLUEPRINT  
FOR  
SURVIVAL No. 1**

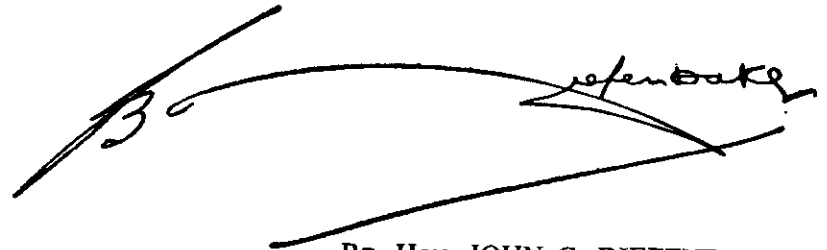
## FOREWORD

In announcing the policy of the Government concerning shelters for civil defence purposes, I stated that substantial protection against radioactive fallout could be achieved by family shelters built at home at a modest cost. I said a pamphlet would be issued giving detailed suggestions for those wishing to provide such protection for their families. This is it. Another will be issued shortly with suggestions for shelters that can be built in a backyard.

Although Canada will persist in its efforts to avoid war, and to settle international disputes by peaceful means, there still remains some risk of nuclear war. Should a nuclear war occur, the risk of radioactive fallout will be very widespread, and will endanger many of us in our homes, even though a long way from the bomb explosion. The best and simplest way to safeguard against fallout is by household shelters which will provide protection.

The shelter described in this booklet, although not affording protection against the blast of a nuclear explosion or the fires that may result, will provide good protection against the more widespread radiation danger. These shelters will be a practical and reasonable means of insuring one's family against this risk that would arise should a war occur.

Each householder can and should decide whether or not to have this form of family protection. I recommend it.

A large, stylized handwritten signature in black ink, which appears to read "Diefenbaker". The signature is written over a horizontal line that spans across the width of the signature.

Rt. Hon. JOHN G. DIEFENBAKER  
*Prime Minister*



## TABLE OF CONTENTS

<i>Section</i>	<i>Page</i>
1. WHY A FALLOUT SHELTER . . . . .	1
2. WHERE AND WHEN FALLOUT SHELTERS . . .	3
3. THE SHELTER AND HOW TO BUILD IT . . . .	5
4. LIFE IN THE SHELTER . . . . .	16
5. HEALTH AND SAFETY . . . . .	23
6. LEAVING THE SHELTER . . . . .	25
7. BUILD IT NOW . . . . .	26
8. ACTION GUIDE . . . . .	27
9. SHELTER SUPPLIES . . . . .	29
10. FOOD AND WATER . . . . .	31
11. ADDITIONAL SERVICES AVAILABLE . . . . .	32
12. BUILDING MATERIALS . . . . .	33

### NOTE

"The Associate Committee on the National Building Code of the National Research Council considers this design of household fallout shelter to be structurally acceptable for its intended use for installation in the basements of dwellings, for emergency use only.

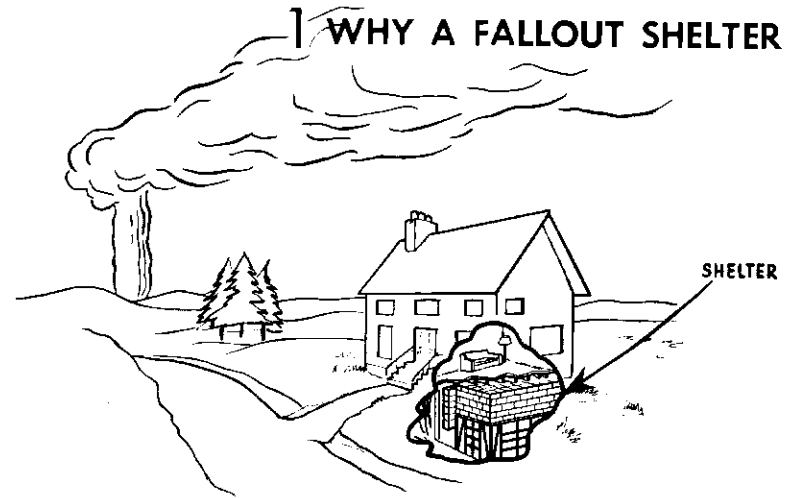
The Associate Committee makes this statement since the provisions of the National Building Code are intended for use with building for normal conditions of occupancy and not for emergency use."

Produced by the Emergency Measures Organization of the Privy Council Office by Authority of the Prime Minister of Canada, The Right Honourable John G. Diefenbaker.

*See enclosed wall chart for working plans*

PRINTED BY ALGER PRESS LIMITED  
UNDER THE AUTHORITY OF  
ROGER DUHAMEL, F.R.S.C., QUEEN'S PRINTER  
OTTAWA, CANADA, 1961

## 1 WHY A FALLOUT SHELTER



If nuclear war comes, the greatest danger to the greatest number of Canadians is likely to come from radioactive fallout. Fortunately, this danger can be averted or considerably reduced by the use of comparatively simple measures.

To understand how you can protect yourself against fallout, you must know something of its nature.

When a nuclear bomb explodes so that its fireball touches the ground, a considerable amount of earth and other pulverized material is drawn up into the cloud, becoming radioactive in the process. This dust is carried downwind and may be deposited over thousands of square miles of territory. After it has fallen onto the ground, or buildings, it still continues to emit radiation which cannot be detected by the human senses but is harmful to the human body.

For people outside the immediate blast area, one of the greatest dangers may be this radioactive dust. So we should keep such dust away from us.

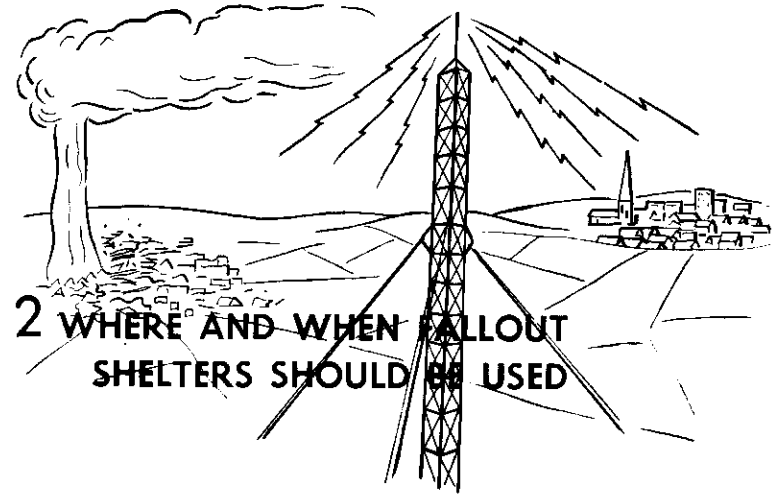
Study of radiation has shown us how to protect ourselves against it. We know, for example, that the further one is from any source of radiation, the less one is affected by it. Then, while

radiation can pass through walls and other solids, we know that the denser the obstacles it encounters the more its intensity is reduced. That is to say, a solid brick, or stone, or concrete wall will reduce radiation effects more than wooden walls. So, by placing some type of heavy construction between ourselves and the sources of radiation, we can achieve a considerable amount of protection.

Finally, fallout radiation decreases with time; its strength is reduced day by day. So one method of survival open to us is to stay in some form of protected accommodation until the radiation intensity has dropped to the point where it is safe for us to resume a more normal pattern of living.

You would be wise to follow to the letter the procedures recommended here. The fallout shelter has been designed to make maximum use, at minimum cost, of the protective measures already known to be effective. Some choice has been left to the householder—for example: selection of the shelter size and equipment. But unless something is clearly indicated to you as a matter of choice, in your own interest you should consult your local civil defence authority or the Emergency Measures Organization at the address given on Page 32 before you deviate from the pamphlet's recommendations.

The shelter design will allow you to live without fear of radiation or harmful fumes generated within the shelter. In spite of a possible loss of electrical power and normal facilities, there will be enough heat in the shelter, even in our Canadian winters—if you wear warm clothes—to safeguard you from the worst effects of exposure to cold. A prolonged stay in the shelter will almost certainly prove uncomfortable at times, but it should not be unbearable.



**D**anger from radioactive fallout may occur in any part of Canada, if a nuclear war occurs, and will be greatest in the southern parts of the country. It would be just as great in rural areas as in towns, and in small communities as well as large. It may come from bombs dropped on defence bases or on large centres or ports selected as targets, from bombs going off in aircraft shot down in battle, or from missiles that miss their targets. Consequently, it is prudent for all Canadians to consider protection against this risk in their own homes.

### **It's not a blast shelter**

You should not take refuge in a fallout shelter as a protection against the blast of an exploding weapon. There is a greater danger in the shelter than elsewhere because it may collapse as well as the house, and it may be more difficult to escape from the shelter if the house catches fire. It is better to seek protection elsewhere against the blast—in the basement lying down near a wall, under a heavy table, close to some exit in case of fire. The fallout shelter is for *after* the explosion, if you're in an area that has not been

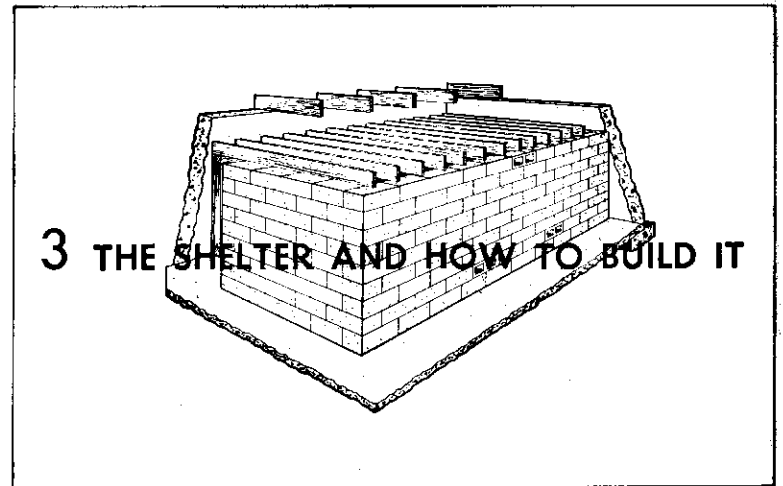
devastated by blast and fire but is in the path of the fallout. Warnings of fallout will be broadcast by radio.

## Until you build your shelter

If an attack should come before you have time to finish your shelter and your area is subjected to fallout, you should take refuge in a basement, in a corner, if possible under a heavy table, or other support on which should be piled as much heavy material as possible—bricks, books, piles of newspapers, lumber, etc. You should lie there for forty-eight hours, or until notified you can come out. It is much better in such circumstances to suffer from hunger, cold, thirst or other hardships than to run the risk of death or serious injury from radiation poisoning.

## Other shelters in target areas

Those living in possible target areas, such as the larger cities, may prefer to build household shelters that will protect them and their family against blast and fire as well as fallout, in case a weapon explodes a few miles away. These are more difficult and expensive to build, costing several times as much as fallout shelters. Detailed suggestions for building such antiblast shelters are being prepared. Those living in or near potential target areas who do not feel prepared to go to the expense of building stronger shelters, can and should protect their families against the fallout danger.



Even an ordinary house provides some protection against radioactive fallout. The safest place inside is a corner of a basement. However, even in this part of the house there will not be, in most cases, sufficient protection to ensure the survival of the householder and his family. It is therefore necessary to add to the protection afforded, and this can best be done by building a basement fallout shelter. The shelter described in this pamphlet will provide the additional protection that is required.

## Selection of site

Because the protection already available is highest in a corner of the basement, one of these should be chosen. That corner of the basement with the highest outside ground level will give the best protection and will simplify construction of the shelter. If, however, the ground is level with the basement floor or varies only slightly, then you should place the shelter below a room which contains a considerable amount of heavy equipment, such as a kitchen. In this way you increase overhead protection, and you can improve this further, after a fallout warning has been received, with more furniture, books, magazines, etc.

The corner you select should not have any basement windows inside the shelter. If it does, however, the windows and wood frame must be removed and the opening filled with brick or solid concrete blocks at least eight inches thick. (See Diagram 7(a) on the enclosed chart).

## The nature of the shelter

The basement fallout shelter described here has been designed as a "do-it-yourself" project. An able-bodied person should be able to build it by following the instructions in this booklet and the plans on the enclosed chart.

The shelter is a small, protected room built on the concrete basement floor. The walls are made of heavy concrete blocks, except against that part of the cellar wall which is below the level of the ground outside. Here there is no danger from radiation and the wall of the shelter is simply a framework of lumber to hold the concrete blocks above it. The roof of the shelter consists of two layers of loose concrete blocks, laid on planks which are supported by strong wooden joists resting on the two sides of the shelter. The entrance is a short passageway built of concrete blocks to prevent direct radiation coming in the doorway.

Diagram 1 on the enclosed chart shows an outline plan of such a shelter located in the corner of a house basement.

## Size

This shelter has been designed to a minimum width of 6 feet 8 inches inside its walls. This width is recommended because it provides for a full-length bed along the end wall furthest from the shelter entrance.

Most houses have a maximum distance of about 10 feet in the clear between the external wall and the beam supporting the floor joists. Thus the shelter will fit into most houses without interfering with the existing structural framework. The height from the underside of floor joists to the basement floor in an average Canadian home is approximately 7 feet 3 inches. This should

still give adequate headroom in the shelter after its roof has been put in place. If the height of your basement is less, the height of the shelter must be reduced by using a method described later in this section.

Diagram 1 on the enclosed chart shows the dimensions of a typical shelter required to accommodate five persons, using a width of 6 feet 8 inches between the inside walls. The size of the shelter should not, if possible, be reduced for families with fewer than five persons because a smaller size shelter is likely to be much less comfortable and may create ventilation problems. Changes in length required to accommodate additional persons are as follows:

<i>No. of People</i>	<i>Clear Inside Width</i>	<i>Clear Inside Length</i>	<i>Overall Length</i>
5	6'8"	9'4"	14'0"
6	6'8"	10'8"	15'4"
7	6'8"	13'4"	18'0"
8	6'8"	14'8"	19'4"

Diagrams 2, 3 and 4 on the chart show various construction details. The materials required to construct the shelter include concrete blocks of several sizes for the walls and roof (solid blocks are suggested but you may use hollow blocks *provided* their hollows are completely filled with sand or mortar as work proceeds); heavy lumber to support the roof and construct the framework against the basement walls; hydrated lime, cement and sand to make mortar; nails, lag screws, bars and washers to be used as described below. The detailed amounts required for the four sizes of shelters noted above are listed on Page 33. Tools required for the project include:

- Mortar Mixing Board
- Shovel and Pail
- Bricklayer's Trowel
- Level and Bricklayer's Line
- Long Straightedge
- Saw
- Hammer
- Drill with masonry bit
- Spanner or Wrench

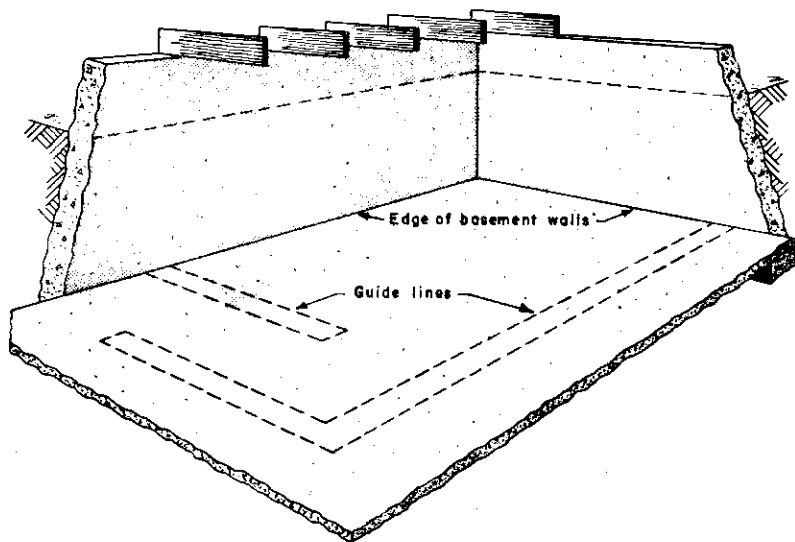
## How to make mortar and lay up masonry

The mortar mix recommended for shelter construction is one part of cementing material to three parts of clean sand. The cementing material may be masonry cement, or Portland cement plus hydrated lime in equal proportions, or Portland cement alone. The usual cement used in construction, called Portland cement, will not give as easy a mix to work with when used alone as will masonry cement. Prehydrated lime, purchased in bags, gives a workable mix when added to Portland cement, but means that an extra ingredient must be purchased.

A ready mortar mix in bags containing both cement and sand, and requiring only mixing with water, is available in some localities.

Mix the cementing materials and sand while dry, then add water and mix again thoroughly. Do your mixing in a shallow box, on a metal or plywood sheet or on a board platform. You may even use the basement floor for mixing, if you do not object

FIGURE 1



to its discoloration by the cement, but a box or plywood sheet will be more convenient. Mortar sets quickly, so mix only as much material at once as you can use conveniently in fifteen or twenty minutes.

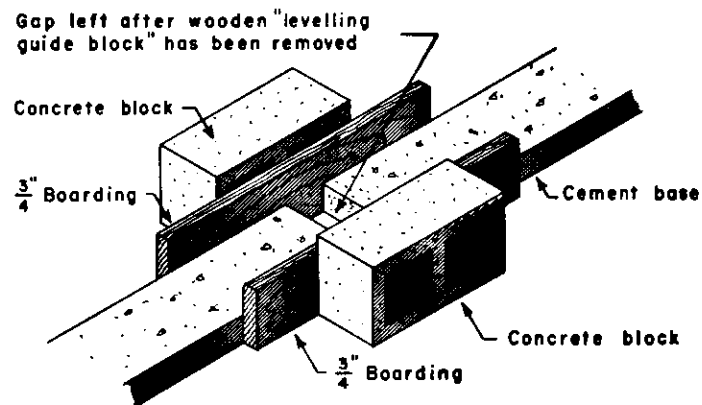
## Lay it on the line

Having decided the size of shelter you need for your family, the first step is to mark out "guide lines" on the basement floor as illustrated in Figure 1 on Page 8.

## Start on the level

After marking out your "guide lines", check to see if the floor is level. If it is not level, then the procedure illustrated in Diagram 9 on the enclosed chart should be followed. This is to construct a shallow form in which are placed guide blocks to indicate the level to which the concrete is to be finished. The mortar is placed inside this form and finished level with the tops of the guide blocks. After it has set, the form and guide blocks can be removed and the spaces left by them filled in with the aid of an elementary form as shown in Figure 2 below.

FIGURE 2



## Plan your work

Now that you have a level base, plan so that the walls come out straight and true (See Diagram 11) and to the exact height desired at each stage. Measure carefully the dimensions of the block you have available and remember to add  $\frac{1}{4}$  inch to the block height for the thickness of the mortar joint when calculating the heights at any given course.

At corners the blocks must alternate and be fitted together, so you must keep the corresponding mortar joints at the same heights on all walls. Make use of a long, wooden straightedge, a level and a bricklayer's line in checking your work. Do not forget that the cores of hollow blocks *MUST* be filled as work progresses in order to give the desired degree of protection.

Consider carefully how many rows of whole blocks you can get into the height of your wall. The top row of blocks must not be closer than 16 inches to the existing floor joists or you won't have room for your roof. You may not be able to use the nine rows of blocks needed to give you the six feet of clearance within the shelter. (The shelter described in this pamphlet is, of necessity, calculated on the basis that the average Canadian house has 7 feet 3 inches of clearance between floor joists and basement floor).

However, you will want to make use of every inch of headroom your basement offers. If a wall of nine courses, or rows, of blocks is too high and one of eight courses not high enough, the difference can be made up by increasing the height of the level footing you make for the wall and, if necessary, by combining this with a top course of 4-inch blocks on the wall.

The following table will show you how to do this:

<i>If your basement headroom is:</i>	<i>You will need this number of 8-inch courses of blocks</i>	<i>and this increase in height to your level wall footing</i>
7'4" and over	9	Nil
7'3"	8½*	3"
7'2"	8½*	2"
7'1"	8½*	1"
7'0"	8½*	Nil
6'11"	8	3"
6'10"	8	2"
6'9"	8	1"
6'8"	8	Nil

\*The half course consists of 4-inch blocks.

If the basement headroom is less than 6 feet 8 inches, which means a shelter headroom of 5 feet 4 inches, you should build the next larger size of shelter in order to ensure having the correct volume of air space inside.

## Framing

The blocks which are built against the existing basement walls of the house, above the ground level, rest on 2-inch by 8-inch timber framing, which itself must be supported on a course of cement blocks or concrete at least 3 inches thick (See Diagram 10 on the enclosed chart). The framing reduces the number of concrete blocks required and provides storage space.

Below outside ground level and immediately adjacent to the shelter, the existing concrete wall of the house and the existing ground will provide adequate protection. Therefore, the height of the framing and the number of courses of blocks on top will depend on the level of the ground outside the basement wall. As an example, if it is 4 feet 6 inches from ground level to basement floor, then the top 2-inch by 8-inch board on which blocks are laid must not be more than 4 feet 6 inches from the floor. If the grade outside is lower, so must be the height of the framing. If the ground level is higher than the top side of the shelter roof, then concrete blocks would not be required on these walls. But timber framing must be built on these walls to support the ends of the roof joists. The timber framing must be properly braced

with diagonal pieces and all pieces well "spiked" together, using 4-inch nails (See Diagrams 2 and 3 on the chart).

The framing must be anchored to the existing basement wall as shown in Diagrams 5 and 8 on the chart.

It is important to remember that the height of your framing and blocks on top of it must always correspond to the height of the rows of blocks on the opposite walls so that your shelter will end up at the same height on all sides.

The surfaces of the framing which are to be placed in contact with concrete or masonry should first be treated with some suitable timber preservative such as copper naphthanate. You just paint it on; you'll get the necessary instructions on its use when you buy it.

## Walls

Having set the timber framing in position, the corner of the shelter on top of the framing is built about four blocks high (using blocks 16 inches long by 8 inches wide by 8 inches deep), and the remainder of the wall then built to the same height (See Diagram 10). Continue building the wall in this way to the required height.

The blocks which form the 90-degree angles at the corners need to be "toothed" together (as shown in Diagram 11 of the chart) in order to achieve proper bonding and rigidity.

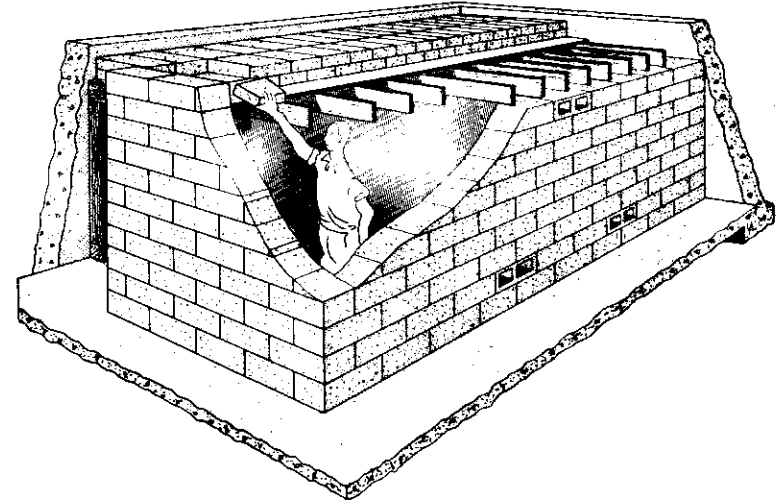
These blocks must support the heavy roof of the shelter. For this reason the wall must be anchored to the existing basement walls. This is done by imbedding a metal bar at every other block between the two top courses of blocks and securing it to the basement wall by means of a lag screw (Diagram 8). Don't forget to drill the holes in the basement wall and secure the bars in place (bent as shown in Diagram 6) before laying the top course.

The first row, or base course, of blocks which form the other walls is set in about  $\frac{3}{4}$  of an inch of wet mortar along the guide lines you have drawn on the floor. You then move to the corner

nearest the centre of the basement, build that corner about four blocks high and continue with the remaining walls in the same manner as described above.

Don't forget to insert the vent or air-circulating blocks as shown in position in Figure 3 below and Diagram 1 on the chart. Hollow blocks laid on edge will form suitable openings.

FIGURE 3



Block designs differ but most blocks will provide about the same area of opening, 40 square inches per block. Four blocks should be arranged for vents, two at the top and two at the bottom of the shelter, providing up to 80 square inches of opening at each level. You may, if you wish, arrange to provide the equivalent area of opening in some other way, such as by leaving out half a block. (If you plan to use solid blocks in your construction programme, it would be an idea also to buy four hollow blocks for the vents).

Before construction of the outer wall has gone too far, all bulky fittings and furniture such as cots, bunks or tables should be placed inside the shelter. Even when these have been put in



place, the walls should not be built all the way to the basement ceiling since a clear space of at least 16 inches is needed overhead to permit construction of the shelter roof.

The baffle wall protecting the shelter entrance from direct radiation must be the same height as the shelter walls.

## The roof

When the mortar in the block wall has dried for a period of at least 48 hours, the roof joists may be installed. As the inside width of the shelter is 6 feet 8 inches, then joists, 2-inches by 6-inches by 7 feet 4 inches, should be set 10 inches apart (on 12-inch centres) and placed across the shelter. Each joist should bear on the block walls for a distance of 4 inches at its end. A 6-inch blocking piece is nailed between each pair of joists flush with the inside face of the shelter walls to hold the joists in place.

The space between the joists where they rest on the wall **MUST** be filled with mortar to maintain the required 8 inches of thickness to the top of the roof. This is done by laying one course of 4-inch thick solid blocks which will butt against the end of the joists and which when completed will form a "box" into which the mortar can be poured. (The "box" is formed by the blocking piece between the joists, the sides of two joists and the 4-inch concrete block).

You should note on Diagram 2 of the chart that the joists carrying the roof over the entranceway are supported on two 4-inch by 4-inch posts and a beam placed there for that purpose.

After the spaces between the 4-inch blocks and the joists on the house foundation wall side of the shelter have been filled with mortar, the laying of the 1-inch roof boards may be started at that side of the shelter. The first one or two boards should be placed in position across the roof joists. These boards are nailed to the joists by reaching up through the open space between the joists. Four-inch thick solid concrete blocks are then passed between the joists and placed on the boards. (There is no need to mortar them together). These roof blocks are in two layers which form a total thickness of 8 inches as shown in Figure 3.

Work on the roof continues in a similar manner until the inside of the opposite wall is reached. Again the space between the joists

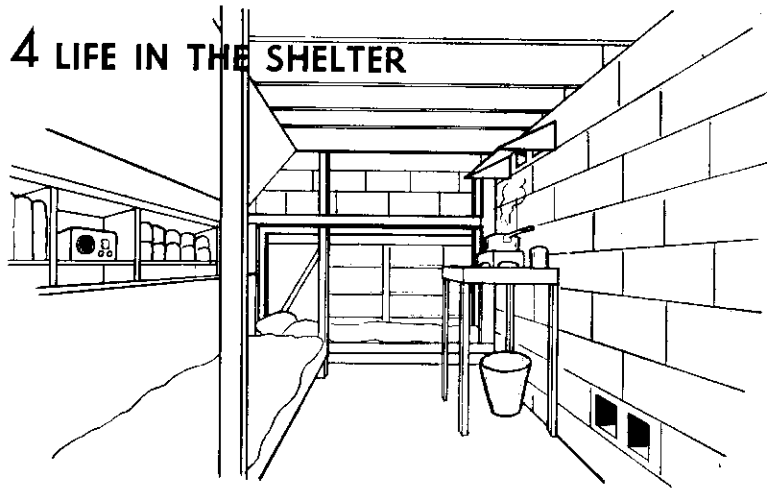
where they rest on the wall must be filled with mortar. When this has been done, continue with the remaining course of 8-inch blocks to complete the wall. (Note in Diagrams 2 and 3 of the chart that the wall goes up beyond the rafters and the roof does not cover the walls).

## Building sequence

In summary, the steps which you should follow in constructing the shelter are:

- (1) Plan your work well. Use the pamphlet in conjunction with the diagrams on the enclosed chart.
- (2) Mark out guide lines on the basement floor.
- (3) Erect timber framing against the outer basement walls and fasten it to them.
- (4) Build the concrete block wall on top of the framing to the required height and anchor it to the basement walls.
- (5) Build the remaining walls to the required height, remembering to move larger objects inside before the walls have been raised too high.
- (6) Place the joists or rafters into position, inserting the necessary blocking pieces between them and filling the spaces between joists and blocks with mortar.
- (7) Construct the overhead protection by nailing on roof boards and placing 4-inch concrete blocks in position, working from the outside wall of the house inwards towards the centre of the basement.

## 4 LIFE IN THE SHELTER



### Shelter layout

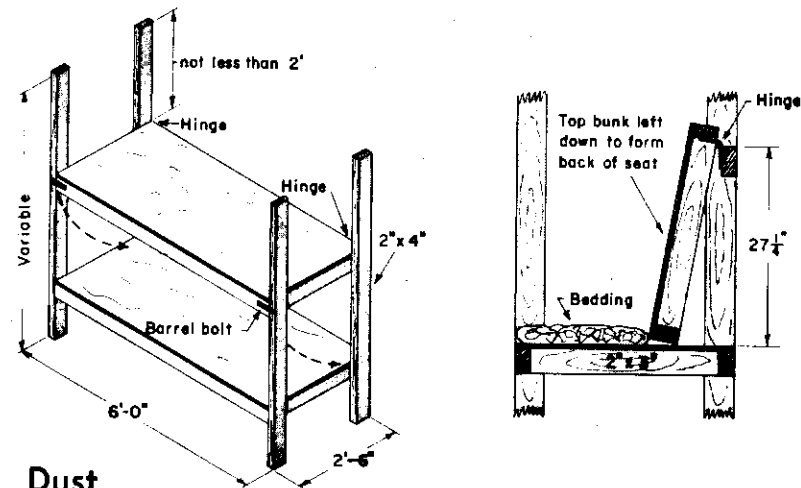
There isn't much space inside the shelter by normal living standards. And as you may have to live in it for a considerable period, it is wise to arrange the accommodation as compactly and neatly as possible. If, for example, a shelter is to accommodate five people, you could save space by using a 3-tier and a 2-tier bunk. (Three tiers are the most you can fit into the available headroom).

The living space will be improved if bunks can be built so that they can also serve as additional seating or table space. Suggestions on how this might be done are shown in Figure 4. A folding table will leave you more floor area between meal times.

You will undoubtedly adapt the shelter to suit yourself. However, such measures as painting the inside walls of the shelter, painting the concrete floor or placing an old carpet on it, putting up shelves and other minor fittings will all go a long way to improving your comfort.

Proper understanding of the recommended shelter facilities, and good planning in laying out and stocking a shelter can reduce discomfort to a minimum.

FIGURE 4 2 TIER BUNK



### Dust

Ventilation need not be a problem. The shelter does not have to be made airtight or sealed off from the basement. Radiation does not travel with air movement, and provided the house itself is closed up in the normal way (doors and windows closed) radioactive dust will be kept outside.

It is possible that if you live in an area within 25 miles of a potential target, the windows of your house could be blown in without any other serious damage being caused to the house. In this case, it is possible that a small amount of radioactive dust might be deposited inside the house, but this can be kept out of the basement by arranging to have a door or curtain between the basement and the rest of the house. You should also make provision to block up all basement windows. (See Diagram 7(b) on the chart).

### Ventilation

The shelter air supply can be regulated by adjusting the curtain in the doorway. (This curtain should be of some heavy material such as canvas). Adjusting the curtain will also, to some extent,

control the heat within the shelter. When the curtain is closed, the air flow will be restricted to the vents in the wall and the temperature and humidity in the shelter will rise. When the curtain is open, air flow will be at a maximum and the temperature will fall.

When the basement is cold, ventilation should be restricted by closing the curtain tightly and perhaps even by blocking half the vent openings top and bottom in order to maintain a comfortable temperature in the shelter. This can be done quite safely so long as no fuel-burning appliance is operating in the shelter. When a fuel-burning appliance is in use and the basement is cold, the curtain may be kept tightly closed but the vent openings should be kept completely clear. At all other times, when the need for heat is not great, both vents and curtain should be used for ventilation while operating an open, unvented fuel-burning appliance.

## Heating and cooking

It is possible that damage outside the area where you live may interrupt the supply of electrical power for long periods. This makes it essential to provide for other than electrical methods of cooking and heating which do not involve your making visits to other parts of the house or basement. However, since power may not be interrupted in all areas, or it may be quickly restored, your shelter design may also include facilities to take advantage, up to 1,500 watts, of the normal electrical supply when this is in operation. Wiring should, of course, be installed by a qualified electrician.

In winter, the shelter will almost certainly need to be heated and this will help to increase the air circulation and reduce humidity which might otherwise become oppressive. For shelter heating, high-quality, kerosene-fuelled appliances, available at hardware stores, etc., seem to offer the most satisfactory features. (**WARNING: DO NOT USE** gasoline and other highly volatile liquids because they are far too hazardous for use in a confined space).

The hot gases produced by an unvented fuel-burning appliance will tend to rise. They may be collected and led out of the shelter by placing the appliance directly under a small hood located at one of the top vents. This procedure is recommended for all times when the heat produced is not needed for heating the shelter.

When an open, unvented, fuel-burning appliance is used to warm the shelter, a problem arises. A top vent hood will not only draw off an appliance's gases, but much of the heat produced and existing warm air in the shelter. Further, the warm air in the shelter will rise, leaving the floor cool. So, for the best heating performance under these conditions, the heating appliance should be placed near the floor. Of course, you would be better off with a small closed stove, fitted with a vent pipe. This would heat without subjecting you to unpleasant odours or dangerous gases.

Don't try to convert a small open fuel burner into a closed stove; there can be real danger if the burner and fuel tank are made to operate at too high a temperature. You should use an open hood above the burner.

The quantities of fuel required are not excessive. Even under winter conditions, one gallon of liquid fuel per day should be adequate for all heating, lighting and cooking purposes within the shelter. About  $\frac{1}{3}$  pint per hour will provide adequate heating. If this rate of fuel consumption is not exceeded, the ventilation system will be more than adequate to ensure that no hazard to health occurs from depletion of oxygen or production of carbon dioxide. A hood and vent over cooking or heating appliances is recommended. This will both improve ventilation and remove combustion products.

In summer, the shelter may be uncomfortably hot and you should therefore keep cooking to an absolute minimum.

## Lighting

Battery-powered lamps, candles or kerosene lanterns or lamps can be used. At least twelve, No. 6 dry cell batteries would be required to provide one watt of electrical output during waking

hours for a two-week period. During hot weather you should use lighting generated from batteries. There are many types of emergency lighting equipment on the market today.

## Sanitation

Inside the shelter, the health of your family will depend to a large degree upon the standards of sanitation and personal hygiene that you adopt. Cleanliness is the keynote.

Your major concern will be the disposal of human waste. It is recommended that you install a sanitary toilet provided with polyethylene bags. Your shelter should be pre-equipped with at least a two-weeks supply of large-size bags. After use they should be tied at the neck and deposited in the garbage can or other suitable metal container until they can be disposed of. For the first 48 hours at least, the toilet and garbage can should be placed in the entrance passageway to the shelter. (See Diagram 1). During this period, you and your family should remain within the shelter, unless otherwise officially advised, so blocking this passageway will not matter. After 48 hours, it may be possible to move both items further out into the basement. You will be advised officially. Families with infants should ensure that at least a two-weeks supply of disposable diapers is stored. These too should be placed in polyethylene bags after use and deposited in the waste container.

Washing, especially of hands, is of great importance. Soap, detergents and water do the job best. But, naturally, the waste water from this—and perhaps cooking—has to be disposed of. So it will be important for you to make use somehow of the basement drainage system which normally exists in most houses. One way is to lead a hose from your basement drain to the shelter entranceway, equip the end with a funnel and get rid of the waste water that way. If this is not possible, waste water will have to be treated in the same way as garbage and an additional receptacle for it placed alongside the garbage can.

For reasons of hygiene, and in order to reduce shelter odour, you should provide a number of changes of underclothing for all occupants of your shelter.

## Food and water

Radiation conditions may make it necessary for you to live in the shelter for two to fourteen days. Better make sure, then, that you have enough food and water inside the shelter for at least two days; the balance of your supplies—which can be stored outside but close to the shelter—should be enough for at least twelve days. On Page 31 you will find a list of suitable foodstuffs for a 14-day period. These may be bought and stored over a period of time.

As for water, you should have enough to give at least half a gallon daily to each person; a gallon would be even better. Even if you find that the normal water supply to your house has not been cut off after an attack, you should *NOT* use it until you are told definitely that it is safe to do so. The water could be contaminated without your knowing it. In fact, one of the last things you should do before occupying your shelter is turn off the water at the main shut-off valve. (Make sure you know where it is). You should not open it again until you have been advised to do so by local authorities. Once the valve is closed you may use the water stored in your hot water tank as an additional supply.

## Communications

Your only contact with the outside world, once you are in the shelter, will be by radio. It is vital, therefore, that you have a battery-powered radio as part of your shelter equipment. It is important that you check the reception in the shelter when you install it; it is possible that you will require an aerial to ensure adequate reception. The radio will *keep you informed* of any changes in the general situation in your area. Broadcasts will let you know when, and for how long, it is possible for you to leave the shelter. Under NO circumstances should you leave the shelter before being told it is safe to do so.

## Equipment

The items of equipment with which your shelter should be stocked are listed, for handy reference, on Page 29. After all

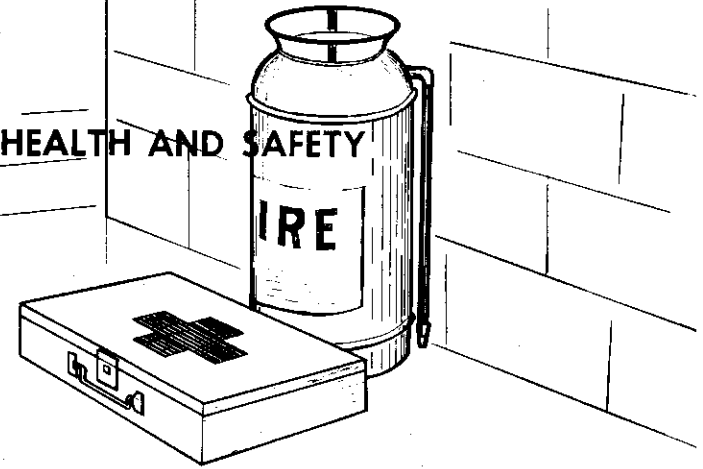
essentials which you need, and for which there is adequate room, have been stored, you should give thought to additional items which might make shelter life more pleasant, and which will not take up too much space.

## Daily routine

The degree of comfort in shelter living will be governed by two factors—daily routine, and outside conditions. The first of these you can control by the planning that you put into working out a routine for daily life within the shelter. The second you cannot control. Conditions outside the shelter may or may not permit limited excursions to other parts of the house or even out of doors.

In planning a daily routine you should break up the day into various periods for rest, individual and group activity, cooking and feeding, shelter chores, and so on.

## 5 HEALTH AND SAFETY



## Sanitation and hygiene

Polyethylene bags used for the disposal of human waste, diapers, etc., must be tied at the neck after use and deposited in the garbage can until they can be disposed of by burial or other means.

Water must be rationed according to your supply. Remember, part of the ration will be for washing, especially hands.

Changes of underclothing must be planned according to the supply available.

The main water supply valve must NOT be turned on again until you receive instructions that it is safe to do so.

## Ventilation and heating

In winter, the shelter should be heated if at all possible. This will increase air circulation and reduce humidity. Use a kerosene appliance for cooking and heating. Do not burn more than one gallon of fuel per day since this will be adequate for all heating, cooking and lighting purposes. At this rate of consumption there is no problem of fumes.

In summer, the shelter may be too hot and you should aim at reducing the heat generated inside the shelter by keeping cooking to a minimum and using lighting generated by batteries.

## Fire precaution

DO NOT use gasoline or other volatile fuels in the shelter. Kerosene is recommended. Consult your local fuel oil company concerning the best grade of kerosene for long-term storage.

DO NOT use dished, reflector-type electric heaters.

Store your fuel in non-leaking containers and make sure that taps, bungs, etc., are out of the reach of children.

See that all sources of ignition such as matches, etc., are in your possession at all times and not accessible to children.

DO NOT locate cooker or heater where a chance fire could block the entrance.

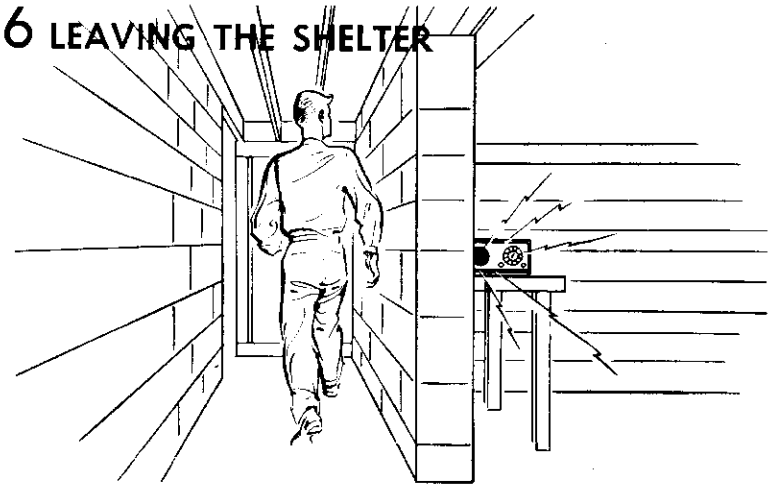
Take great care in refuelling appliances and always use a funnel. It is safer to wait until the appliance has cooled off before refuelling.

## Medical supplies

Don't forget to store adequate First Aid supplies, etc., and special medicines if required.

DO NOT leave such supplies within reach of children. A medicine cabinet which can be locked would be a valuable addition to your shelter furnishings.

## 6 LEAVING THE SHELTER

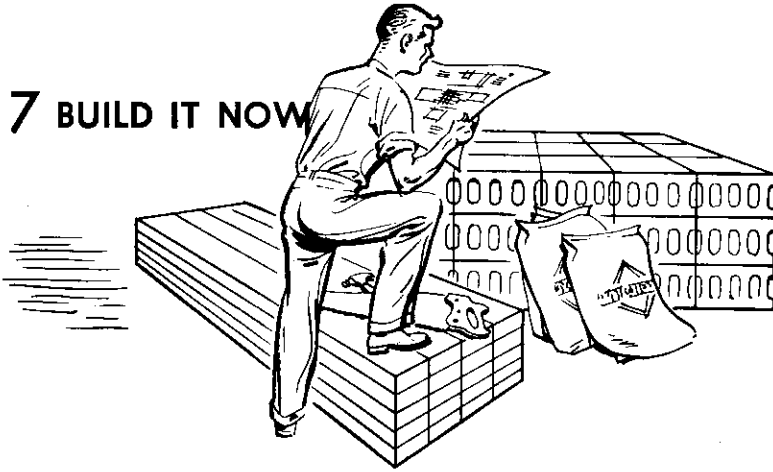


As the radiation intensity outside the house is reduced, it will be possible for you to come out of your shelter for limited periods of time. When you may do so, for how long and where you may go safely will be the subject of instructions issued at the time by local civil defence authorities. Normally, these instructions would be broadcast; under certain circumstances they may be delivered by word of mouth. By whatever means you receive these instructions it will be, of course, extremely important to follow them carefully, otherwise you may endanger the lives of yourself and your family.

Generally, it is anticipated that you will have to remain within your shelter continuously for 48 hours if you happen to be in an area of high radiation. After that, your excursions from the shelter will be in accordance with instructions given you at the time. Even then you should make a point of using the shelter for all non-productive activity, such as sleeping, eating, resting, and listening-in.

In an area subjected to fallout there are safety zones at your home. Safest place is in your shelter; next safest is in the basement below ground; next is upstairs in the house; least safe is outside the house.

## 7 BUILD IT NOW

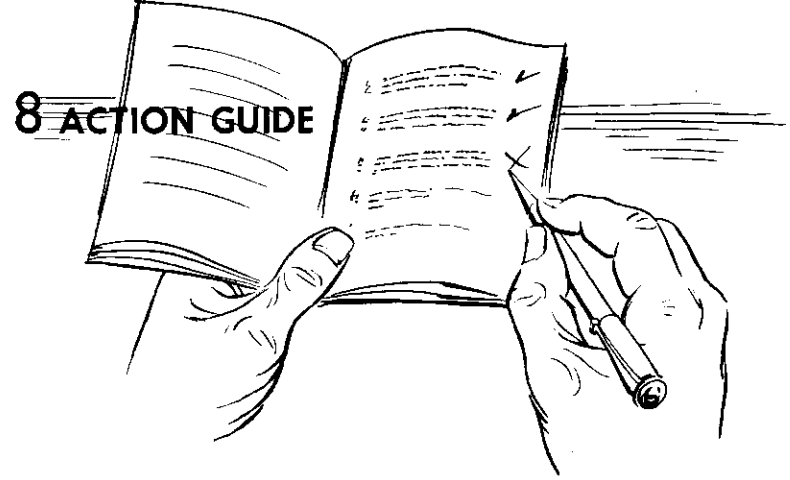


By now you will have realized that there *IS* a great deal you can do to protect yourself and your family from the dangers of radioactive fallout. The shelter described here is based upon the best knowledge available today. However, studies continue and simple means of improving it still further may be found in the future. You should therefore keep in touch with your local civil defence authority.

It is not an expensive shelter, as you will find when you price the list of materials, and if you are prepared to do the work yourself this represents a modest price to pay for your survival. Talk it over with your neighbours and your friends. Perhaps you can all get together and build your shelters as a team—it could be a real community project. You might even consider building the shelter for relatives, friends or neighbours who are not able, for one reason or another, to build their own.

You can accomplish a great deal at little cost, with little effort and a little forethought. What is important, however, is to build the shelter *NOW*. The work cannot be done at the last minute, and it will be too late when the warning is given.

## 8 ACTION GUIDE



### Now You Can:

1. Build your shelter in accordance with the enclosed working drawings.
2. Install the suggested items of equipment. Check them against the list on Page 29. Have you got all the essentials, particularly the shelter radio?
3. Store all the food, water, fuel, batteries, etc., that you will need. Arrange to use and replace at the specified intervals.
4. Plan a family drill for occupying the shelter and practise it. (Remember, *any* adult or adolescent in your home may have to assume command of the situation at the time of an emergency).
5. Plan a daily routine for shelter life.
6. Make preparations so that all basement windows can be quickly and effectively shielded in accordance with instructions.
7. Keep the shelter warm and dry.

### If Warning Comes:

1. Turn on your home radio. Wait for instructions. You will be told when to go into your shelter.

2. If there is time—you will be told how much—do as many of the following tasks as you can in this order of priority:

- (a) Shield all basement windows;
- (b) Move clothes and bedding, suitable for the season, into the shelter;
- (c) Move as much furniture, books, magazines, papers, etc., as possible into the room above your shelter;
- (d) Fill up any additional water containers which may be useful later on. These can be left outside the shelter for use when you are told it's safe to venture into the basement;
- (e) Take in any extra reading material, etc., you might need;
- (f) Open an upstairs tap and turn off the water at main shut-off valve.

## Go Into The Shelter

1. Last person in places toilet and garbage can in passageway.
2. Turn on the shelter radio. Listen for instructions.
3. Put daily shelter routine into effect.
4. Remain in the shelter until instructed to leave. (In most cases this will come via radio but in some instances civil defence officials may notify you in person).
5. Keep calm. Your family will look to you for leadership.

## 9 SHELTER SUPPLIES

### Equipment

- Beds (Bunks or folding)
- \*Table (Folding or other facility)
- \*Stools (Fold flat)
- Cooking vessels
- Cups and Plates (disposable)
- Knives, forks, spoons
- Can openers
- Paper towels
- Kerosene cooker
- Kerosene Lamp
- Electric Lamp and Batteries, spare bulbs
- Flashlight
- 10 Gallons Kerosene (2 gals. in shelter; remainder in basement)
- Matches
- Garbage can (2 if no waste water run-off is possible)
- Garbage bags

- Toilet
- Polyethylene bags for toilet (two-week supply)
- Shovel
- Crowbar
- Axe
- Pocket knife
- Whistle
- \*Saw
- \*Screwdriver
- \*Hammer
- \*Screws
- \*Nails
- Pliers
- Fire Extinguisher (non-carbon tetrachloride)
- \* $\frac{1}{4}$ -inch Rope
- String
- Battery Radio
- Clock
- Spare Radio batteries
- Hand basin

### Recreational

- \*Calendar
- \*Books
- Paper
- Pencils
- \*Playing cards
- \*Chess, checkers, other games
- \*Crossword, other puzzles
- \*Knitting, sewing, etc.
- \*Hobby materials



## Toiletries

Soap, toothpaste, tooth-brushes  
Detergent  
Nail brush  
Razor, blades and soap

\*Women's basic cosmetics  
Tissues (face and toilet)  
Face cloth  
Towels  
Brush and comb

## Personal

Bedding (blankets preferable)  
Warm sweaters and socks  
Change of underclothing and socks  
Personal hygiene items for women

Baby clothes  
Baby feeding equipment  
Disposable diapers (two-week supply)  
Plastic sheeting

## Medical

First Aid dressings and drugs (commercial First Aid kit)  
\*Aspirins  
\*Bicarbonate of soda  
\*Cough drops  
\*Nose drops

Specific medicines such as insulin, heart medicines, etc. as required (100-day supply)  
Disinfectant  
Scissors

## Protective clothing

Coveralls, rubber boots, rubber gloves for adults. To be used in venturing outside even after instructions have been given that this is safe for short periods.

\*Desirable but not essential.

## Food

These are the requirements *per person* for 14 days. Canned foodstuffs should be used and replaced once every six months. Check off the items as you stock them in the shelter.

*Milk:* 4 cans milk (1 lb. cans, evaporated or dried skim milk)

*Vegetables:* 6 cans (15 oz. or 20 oz. cans—beans, peas, tomatoes)

*Fruits:* 6 cans (15 oz. or 20 oz. cans—peaches, pears)

*Juices:* 6 cans citrus juice (20 oz. cans—apple, grapefruit, lemon, orange, tomato)

*Cereals:* 14 individual packages (sealed in wax bags inside or outside)

*Biscuits:* 2 packages crackers (1 lb.)  
2 packages cookies

*Main Dish Items:*

2 cans meat (12 oz.—corned beef, luncheon meats)

2 cans beef and gravy

2 cans beans (15 oz. or 20 oz. cans—baked beans, pork and beans)

2 jars cheese

2 cans fish (8 oz.)

*Canned and Dehydrated Soups:* 2 cans (10 oz.—bean, pea, tomato, vegetable)

*Infant Foods:* Meat and vegetable soup, precooked baby cereal, assorted strained fruits.

*Other Foods:*

1 can honey

2 lbs. hard candy

1 jar or can peanut butter

1 package tea bags

1 jar sugar

1 jar instant coffee

Salt and pepper

Jam, syrup, molasses, jelly

Chocolate powder

Chewing gum

## Water

*Requirement:* 7-14 gallons for each member of the family.

*Containers:* Store in clean, tightly covered containers such as large thermos jug, new fuel cans, large vinegar bottles, etc.

*Change:* Change the stored water at least once a month.

## 11 ADDITIONAL SERVICES AVAILABLE

If you have difficulty in adapting the design to your basement, you may obtain advice on possible modifications by writing to the Emergency Measures Organization, Privy Council Office, East Block, Ottawa, Ontario.

Extra copies of the pamphlet may be obtained from your local or provincial civil defence or emergency measures coordinator.

## 12 BUILDING MATERIALS

Item	Size	Amount in shelter for:			
		5 people	6 people	7 people	8 people
<i>Concrete Blocks</i> (preferably solid but can be hollow (a))					
Walls	8"×8"×16"	220	240	260	300
	8"×8"×8"	20	20	20	20
Roof	4"×8"×16"	210	250	300	340
Inner Layer Shielding (b)	8"×8"×16" – allow for each course	13	14	16	17
	4"×8"×16" one course only	7	8	10	11

(a) If solid blocks are used, add 4 hollow blocks to the list for ventilation purposes.  
(b) Height depends upon height of shelter above ground level.

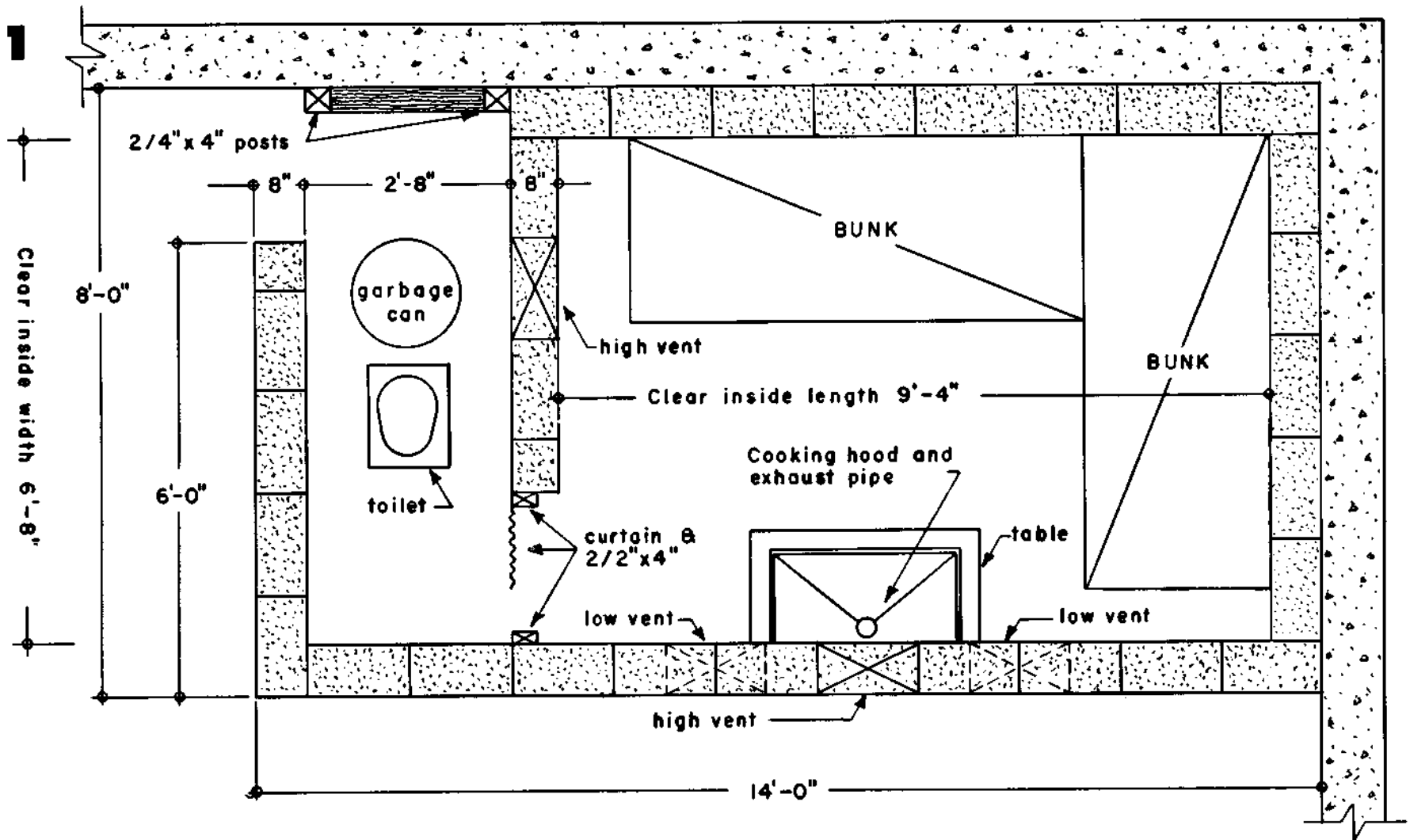
Item	Size	Amount in shelter for:			
		5 people	6 people	7 people	8 people
<i>Mortar</i>					
Hydrated Lime		200 lbs.	250 lbs.	300 lbs.	350 lbs.
Cement		18 bags	21 bags	27 bags	31 bags
Mortar Sand		3 cu. yd.	3½ cu. yd.	4 cu. yd.	4½ cu. yd.
<i>Lumber (c)</i>					
Posts and Beam	4"×4"×10'0"	2 pcs	2 pcs	2 pcs	2 pcs
Stud wall					
Plates (short)	2"×8"×8'0"	3	3	3	3
Stud wall					
Plates (long)	2"×8"×10'0"	3	—	—	—
	2"×8"×12'0"	—	3	—	—
	2"×8"×14'0"	—	—	3	—
	2"×8"×16'0"	—	—	—	3
Studs	2"×8"× (d)				
Rafters	2"×6"×8'0"	14	16	19	20
Blocking pieces	2"×6"×10'0"	3	4	4	4
Curtain frame	2"×4"×8'0"	2	2	2	2
Roof boards	1"×6"×14'0"	14	—	—	—
	1"×6"×16'0"	—	14	—	—
	1"×6"×18'0"	—	—	14	—
	1"×6"×20'0"	—	—	—	14
Shelving	1"×8"×10'0"	4	5	6	7

(c) Commercial lengths are listed. See diagram dimensions for lengths you cut.  
(d) Length depends upon height of shelter above ground level.

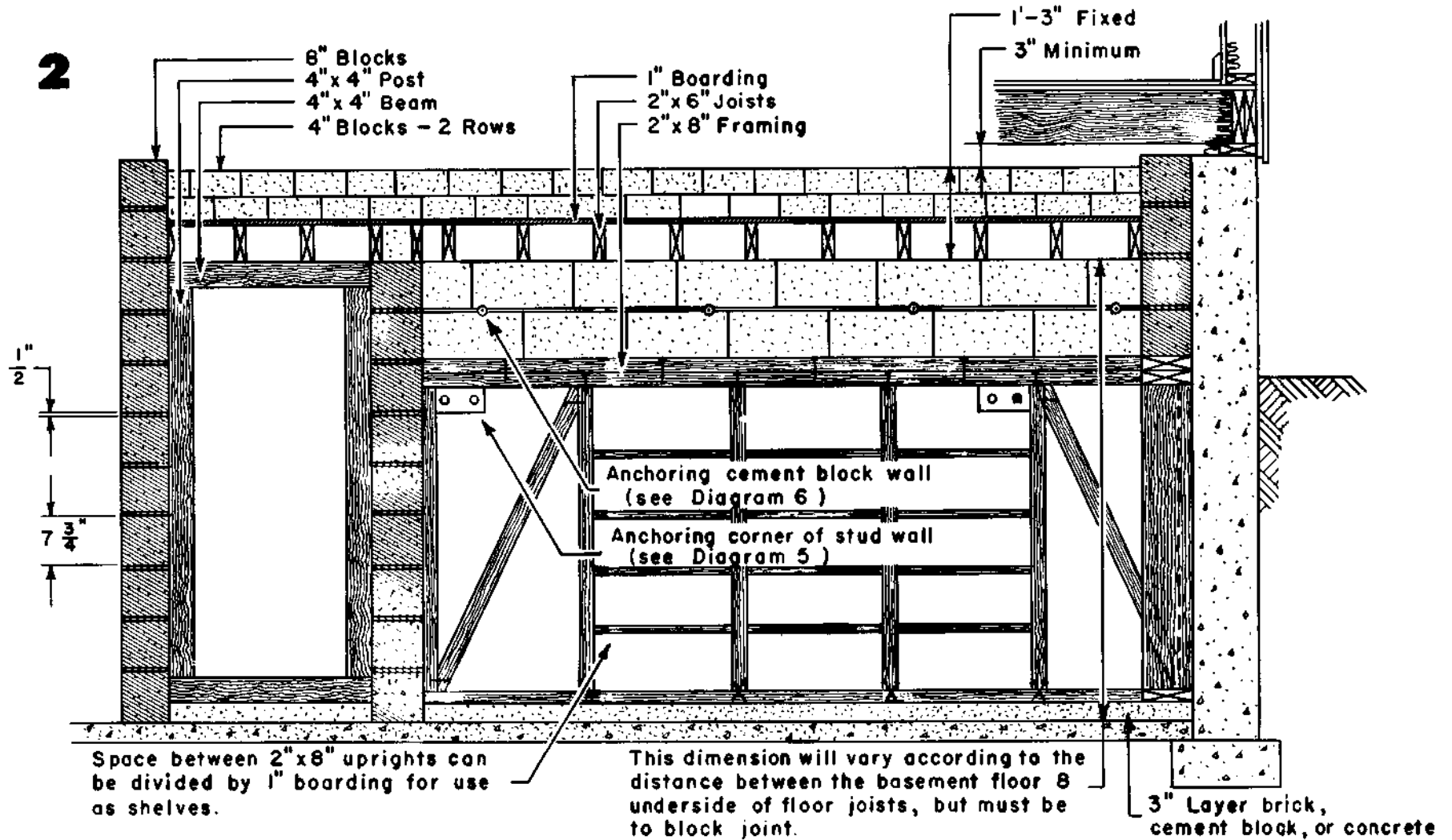
Item	Size	Amount in shelter for:			
		5 people	6 people	7 people	8 people
<i>Hardware</i>					
Nails	6 inch	1 lb	1 lb	1 lb	1 lb
	4 inch	6 lbs	7 lbs	8 lbs	9 lbs
	2 inch	3 lbs	3½ lbs	4 lbs	4½ lbs
Copper Naphthanate		As Required			
<i>Framing Anchor</i>					
Lag screws & plugs	3/8"	4	4	4	4
Washers		4	4	4	4
Lumber	2"×4"×8"	2	2	2	2
<i>Wall Anchor</i>					
Lag screws & plugs	1/4"	5	5	6	7
¾" Bar	12" long*	5	5	6	7
Washers		5	5	6	7

\*Bent as in Diagram 6 on the wall chart.

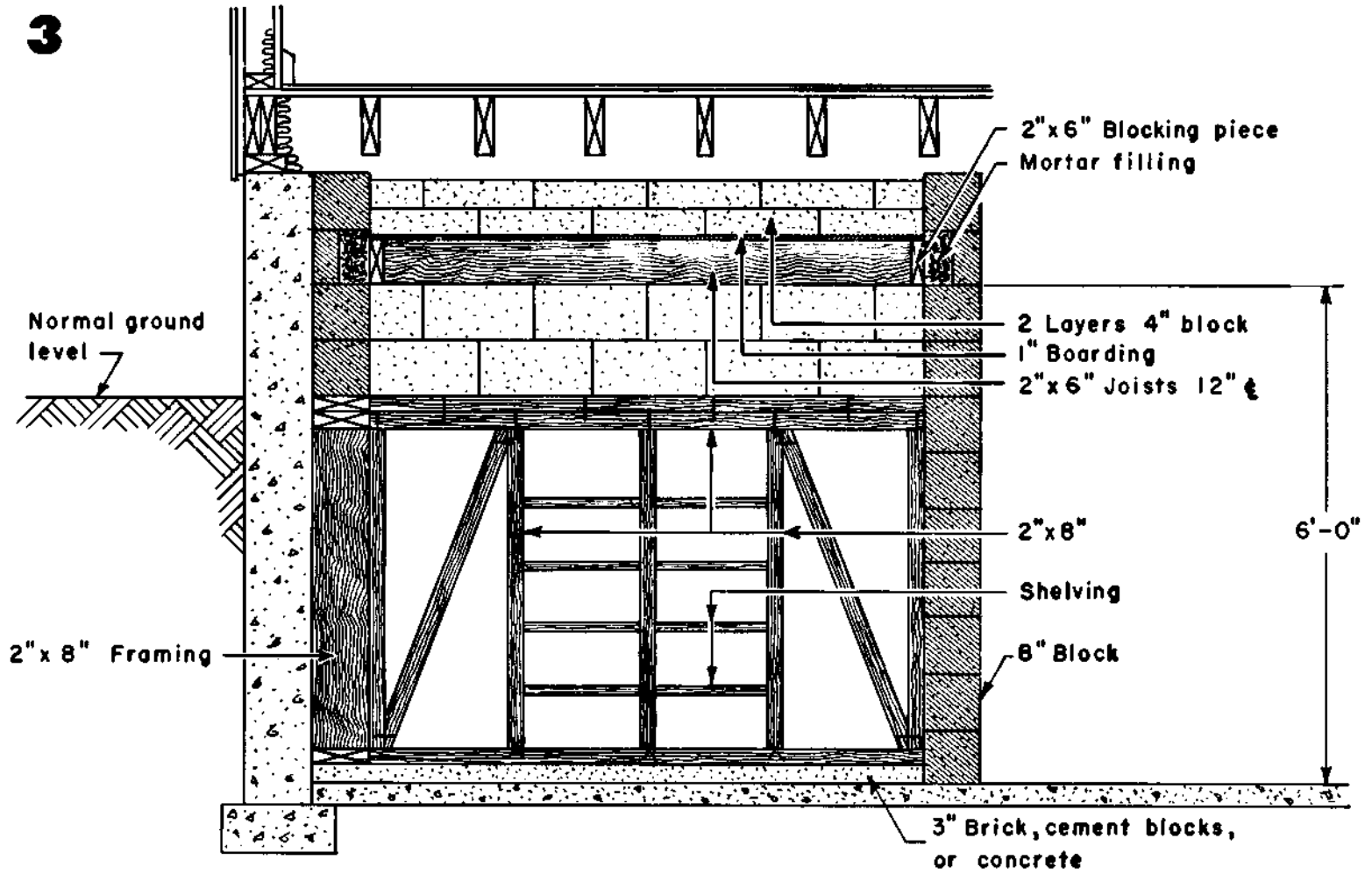




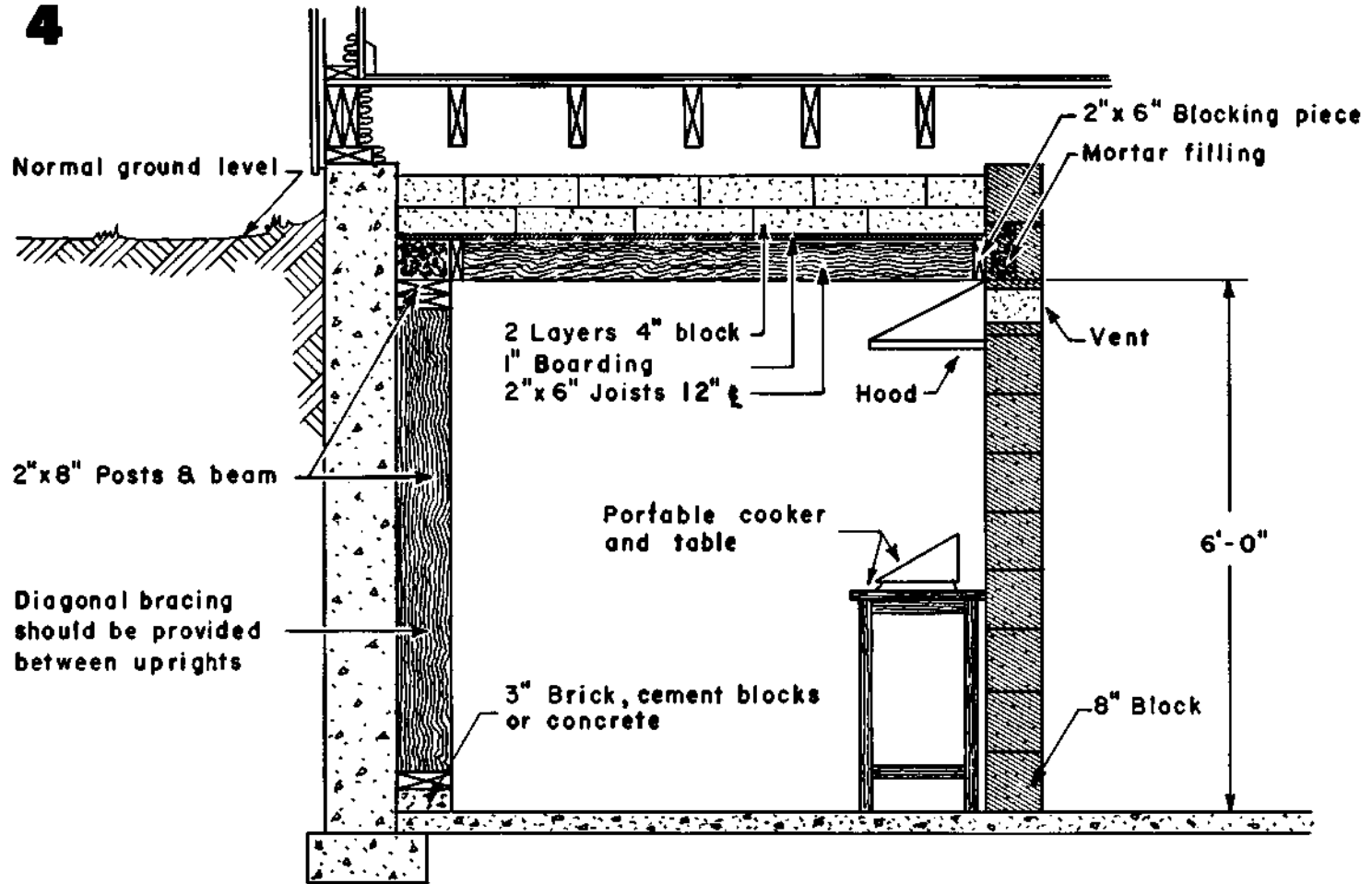
**2**



**3**

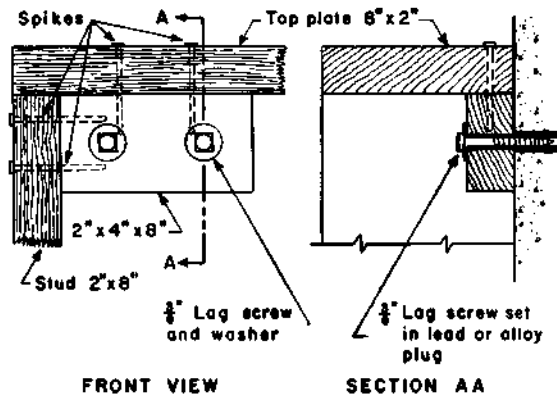


**4**

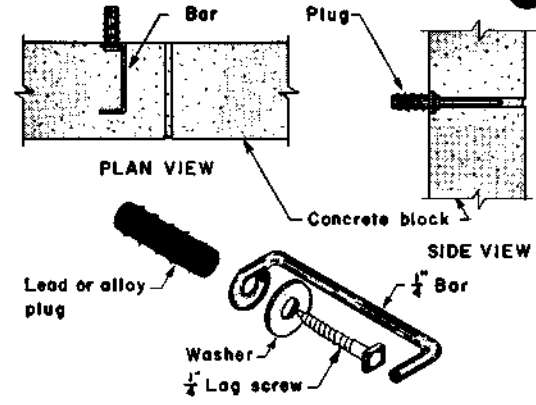




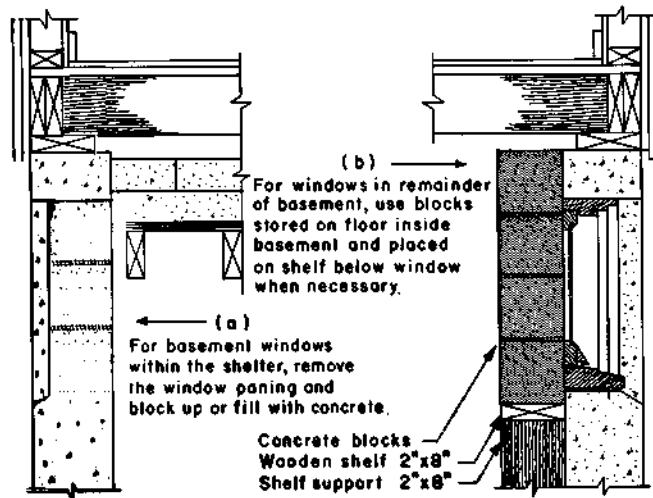
**5**



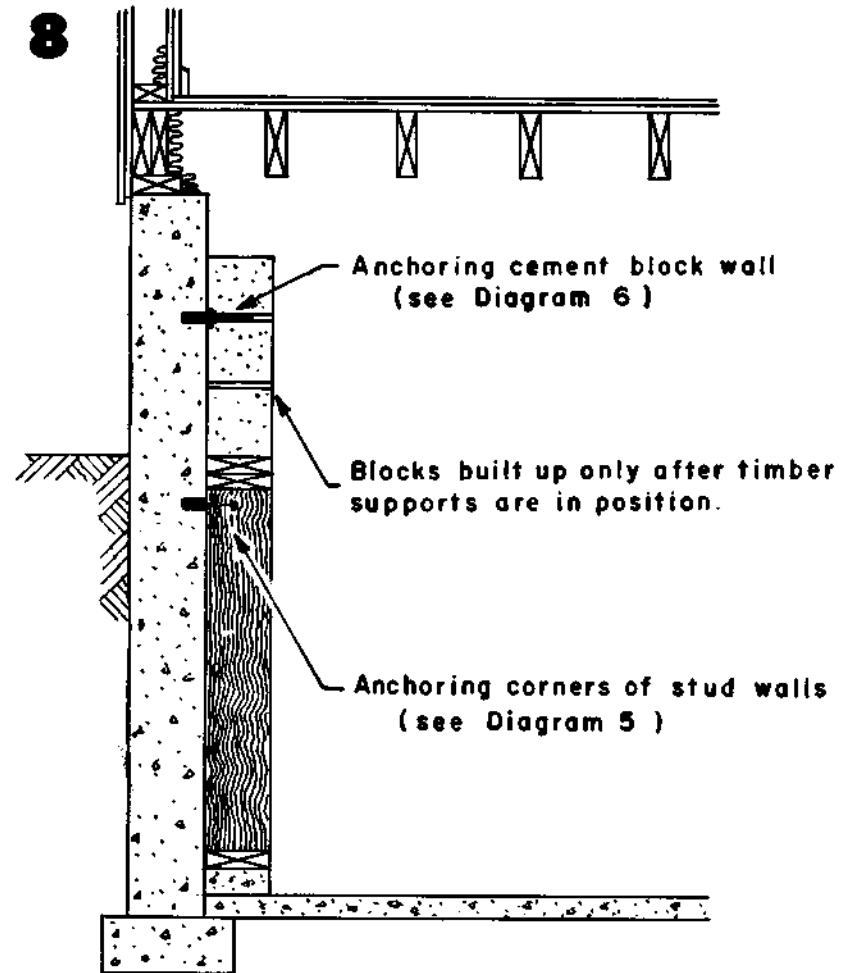
**6**



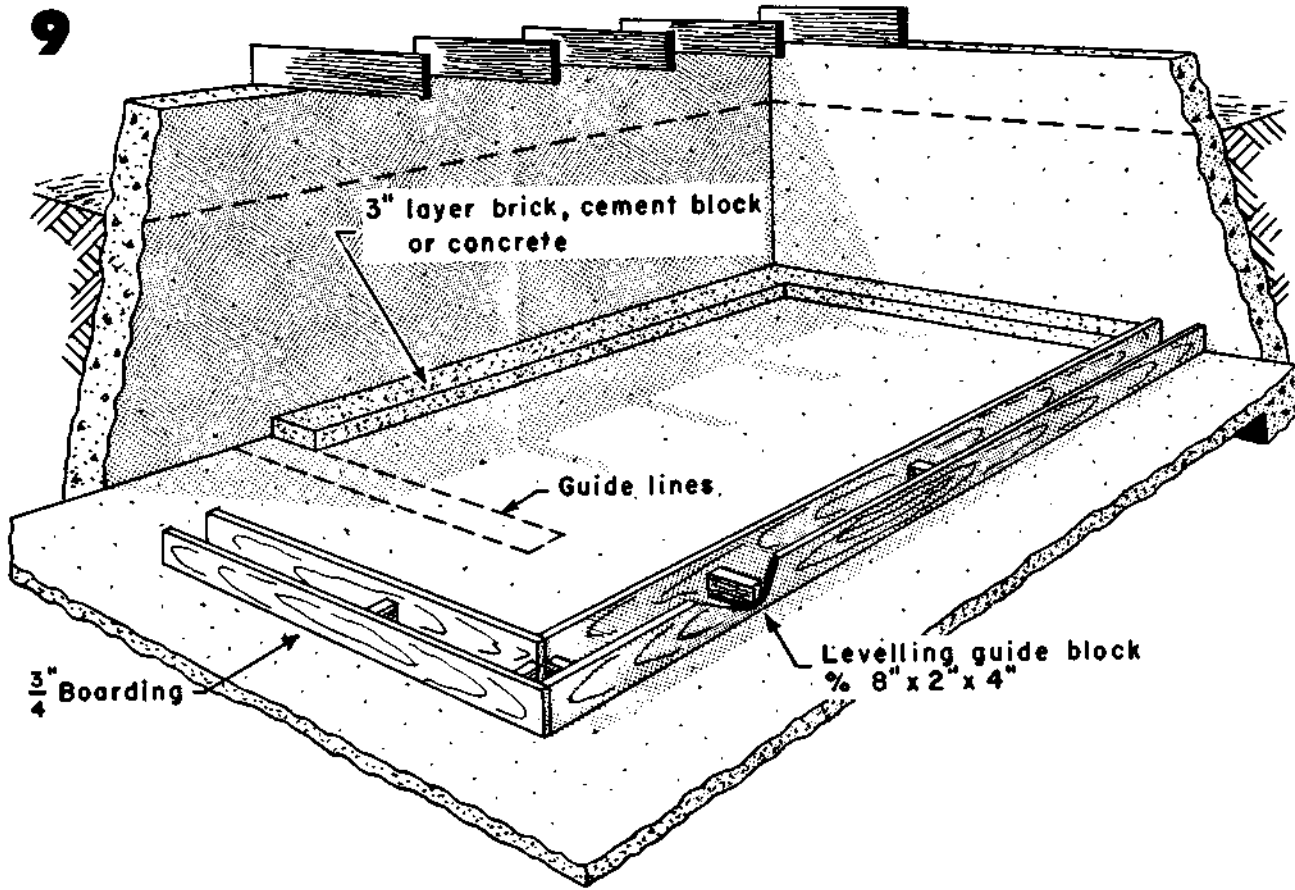
**7**



**8**

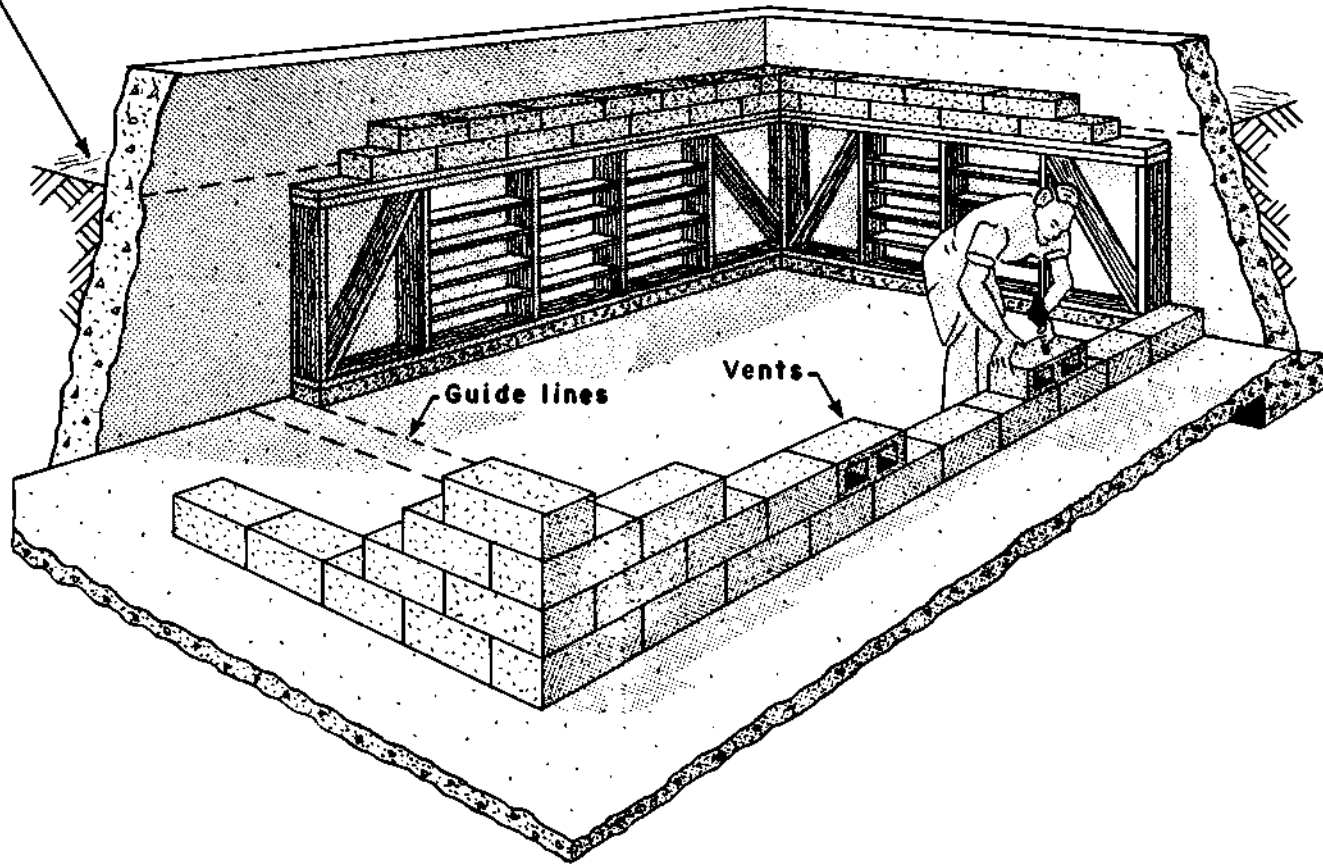


9

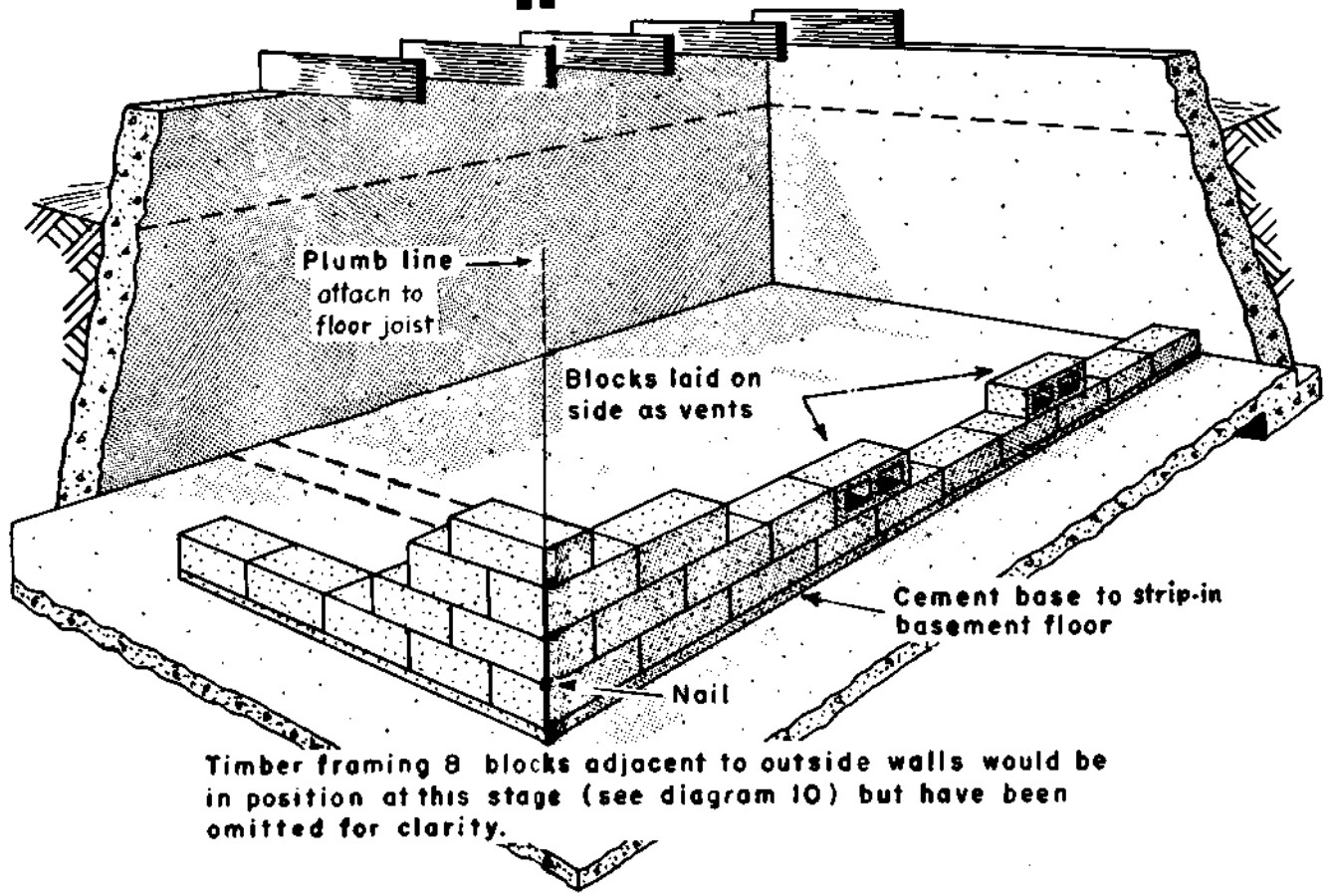


**10**

← Normal ground level



11



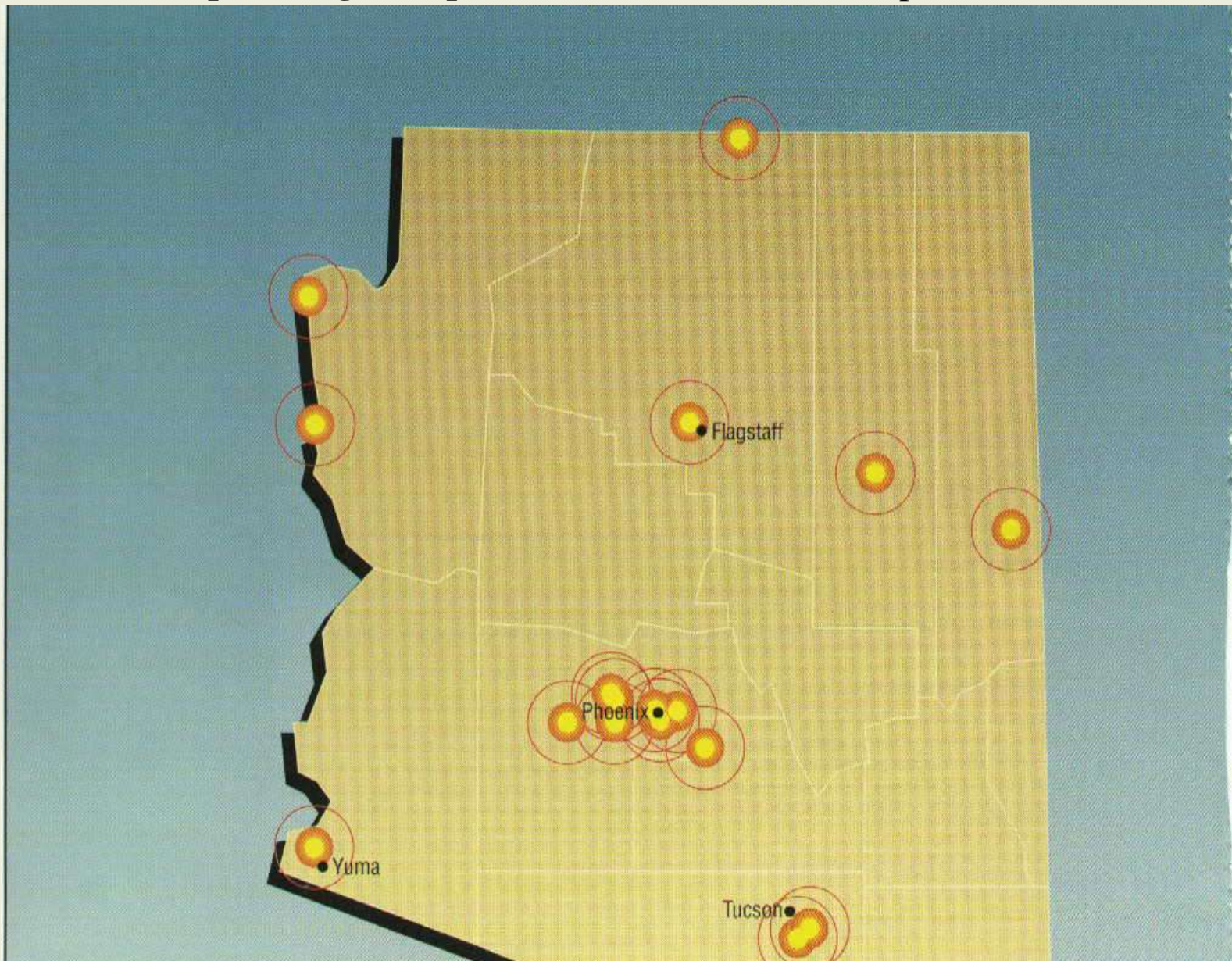
Timber framing & blocks adjacent to outside walls would be in position at this stage (see diagram 10) but have been omitted for clarity.

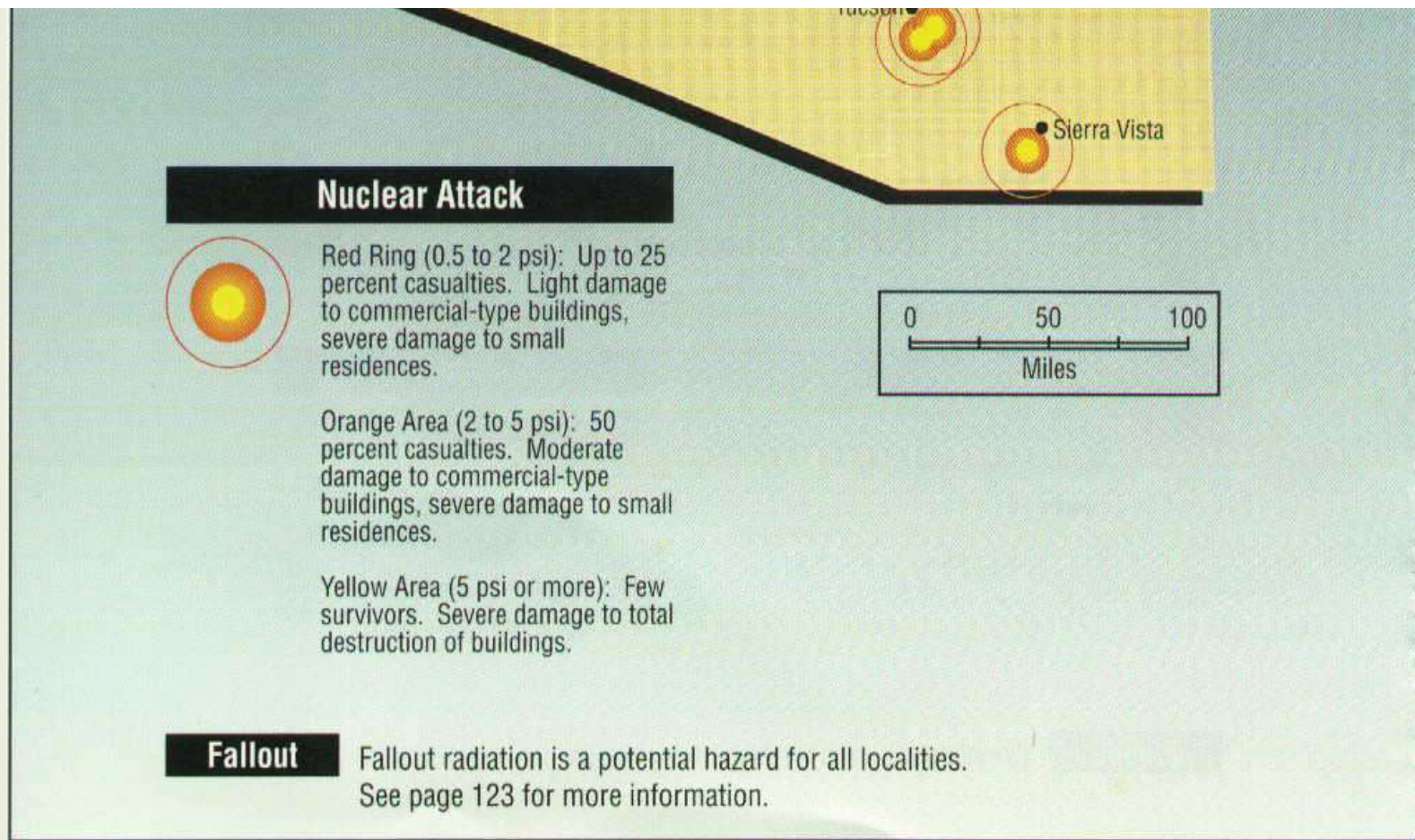
## Nuclear Survival in **Arizona**

This is the nuclear target map for Arizona, but remember, fallout can go anywhere or everywhere (and probably will). After you have looked at this map look at the [Information for Arizona](#) that follows it.

This link will take you back to the [Index of all the States](#)

### **Nuclear Weapon Target Map for Arizona (FEMA-196/September 1990)**





[UPDATE to Target Information!!!](#)

## Information for Arizona

This link will take you back to the [Index of all the States](#)

It is recommended that you go through the following 10 steps in studying about the nuclear threat to Arizona.

1. Look at the [State Map](#) above to see the target nuclear areas in Arizona.
2. Look at the [general expected fallout map](#) to see where Arizona (according to the **prevailing wind pattern**) gets fallout from other states.
3. If the state that you live in is anywhere EAST of any of the following 6 states in the **prevailing wind pattern** then look at the states in **RED** on the [INDEX of](#)

## STATES for

- Montana
- North Dakota
- South Dakota
- Nebraska
- Missouri
- Colorado

These six states contain what is called DENSE PACK which I explain on each of those states pages. **UNDERSTAND** that the wind pattern **COULD** at that time be something other than the "prevailing" wind pattern.

4. Bookmark the present URL or make a copy of this present address so that you can come back to it after going to

[Blast Mapper](#).

This mapper is on someone else's web site so that you will need to save this address in order to return here if your back button doesn't work. However, you want to be sure to go the mapper site and calculate the damage to probable targets (cities) around you.

5. Memorize the THREE top rules for survival. They are:

- Number One - **Get out of the cities!**
- Number Two - **Get out of the cities!**
- Number Three - **Get out of the cities!**

6. The follow-on rules are:

- a. Have a shelter
- b. Work with a group (you are going to need the manpower, brainpower, and skillpower).



- c. Stock supplies.

7. My [Main Survival Page](#) contains links to lots of other information such as free books to download about nuclear survival, links to plans for building shelters, and even free consultation about building a shelter.

8. If you are SUPER concerned about nuclear survival you might consider moving within 20 miles of the

[Ark Two Community](#)  
(in Canada)

9. And finally if you would like to be on the mailing list of the author of this site - send a blank email to:

[arktwo-request@deuce.pairowoodies.com](mailto:arktwo-request@deuce.pairowoodies.com)  
[with the subject as subscribe](#)

**MENU: [HOME](#) » [SURVIVAL](#) » [Index of States](#)**

---

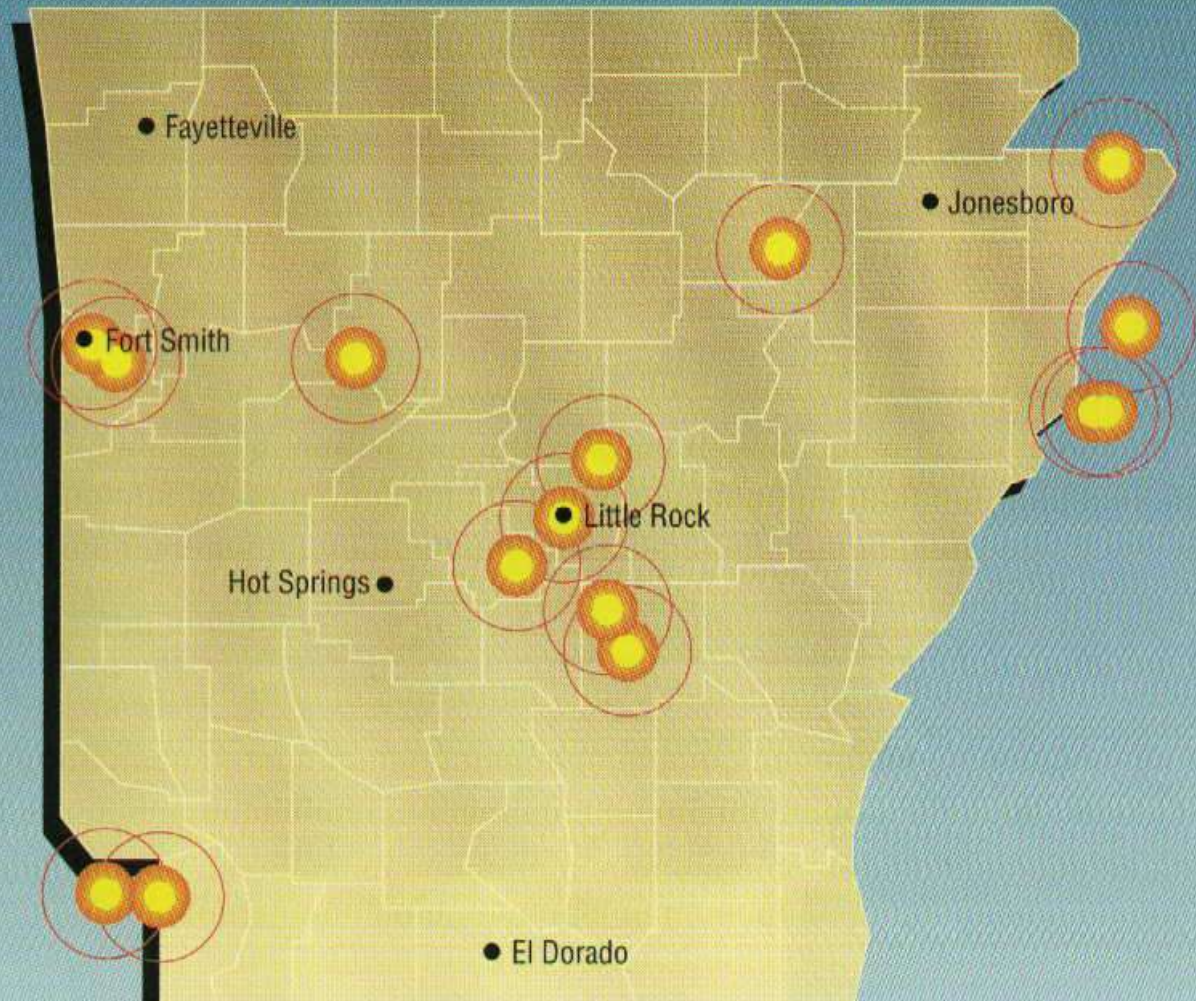
---

## Nuclear Survival in **Arkansas**

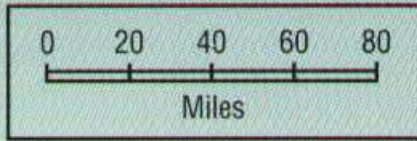
This is the nuclear target map for Arkansas, but remember, fallout can go anywhere or everywhere (and probably will). After you have looked at this map look at the [Information for Arkansas](#) that follows it.

This link will take you back to the [Index of all the States](#)

### **Nuclear Weapon Target Map for Arkansas (FEMA-196/September 1990)**



● El Dorado



## Nuclear Attack



**Red Ring (0.5 to 2 psi):** Up to 25 percent casualties. Light damage to commercial-type buildings, severe damage to small residences.

**Orange Area (2 to 5 psi):** 50 percent casualties. Moderate damage to commercial-type buildings, severe damage to small residences.

**Yellow Area (5 psi or more):** Few survivors. Severe damage to total destruction of buildings.

## Fallout

Fallout radiation is a potential hazard for all localities. See page 123 for more information.

[UPDATE to Target Information!!!](#)

## Information for Arkansas

This link will take you back to the [Index of all the States](#)

It is recommended that you go through the following 10 steps in studying about the nuclear threat to Arkansas.

1. Look at the [State Map](#) above to see the target nuclear areas in Arkansas.
2. Look at the [general expected fallout map](#) to see where Arkansas (according to the **prevailing wind pattern**) gets fallout from other states.
3. If the state that you live in is anywhere EAST of any of the following 6 states in the **prevailing wind pattern** then look at the states in **RED** on the [INDEX of](#)

## STATES for

- Montana
- North Dakota
- South Dakota
- Nebraska
- Missouri
- Colorado

These six states contain what is called DENSE PACK which I explain on each of those states pages. **UNDERSTAND** that the wind pattern **COULD** at that time be something other than the "prevailing" wind pattern.

4. Bookmark the present URL or make a copy of this present address so that you can come back to it after going to

[Blast Mapper](#).

This mapper is on someone else's web site so that you will need to save this address in order to return here if your back button doesn't work. However, you want to be sure to go the mapper site and calculate the damage to probable targets (cities) around you.

5. Memorize the THREE top rules for survival. They are:

- Number One - **Get out of the cities!**
- Number Two - **Get out of the cities!**
- Number Three - **Get out of the cities!**

6. The follow-on rules are:

- a. Have a shelter
- b. Work with a group (you are going to need the manpower, brainpower, and skillpower).

- c. Stock supplies.

7. My [Main Survival Page](#) contains links to lots of other information such as free books to download about nuclear survival, links to plans for building shelters, and even free consultation about building a shelter.

8. If you are SUPER concerned about nuclear survival you might consider moving within 20 miles of the

[Ark Two Community](#)  
(in Canada)

9. And finally if you would like to be on the mailing list of the author of this site - send a blank email to:

[arktwo-request@deuce.pairowoodies.com](mailto:arktwo-request@deuce.pairowoodies.com)  
[with the subject as subscribe](#)

**MENU: [HOME](#) » [SURVIVAL](#) » [Index of States](#)**

---

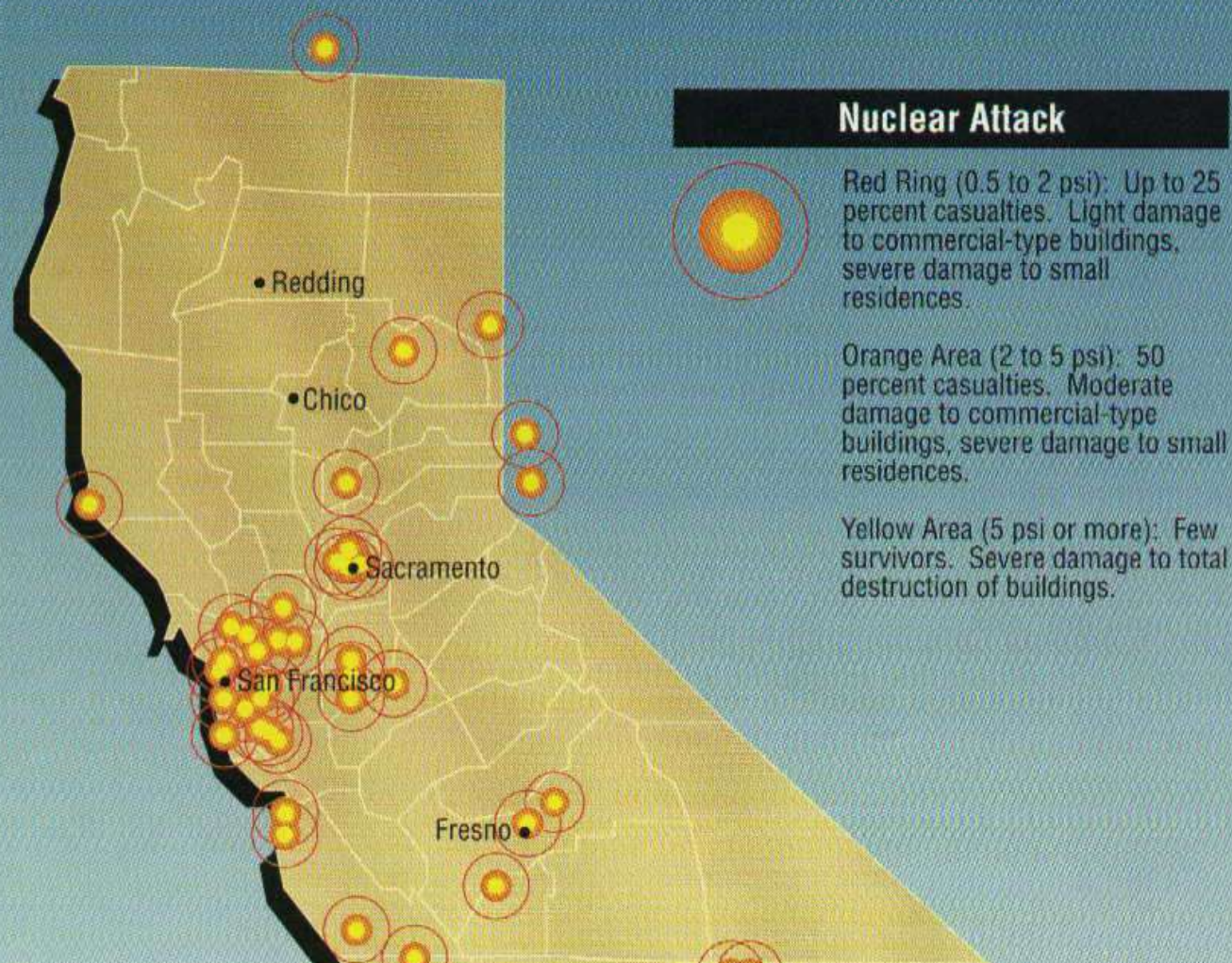
---

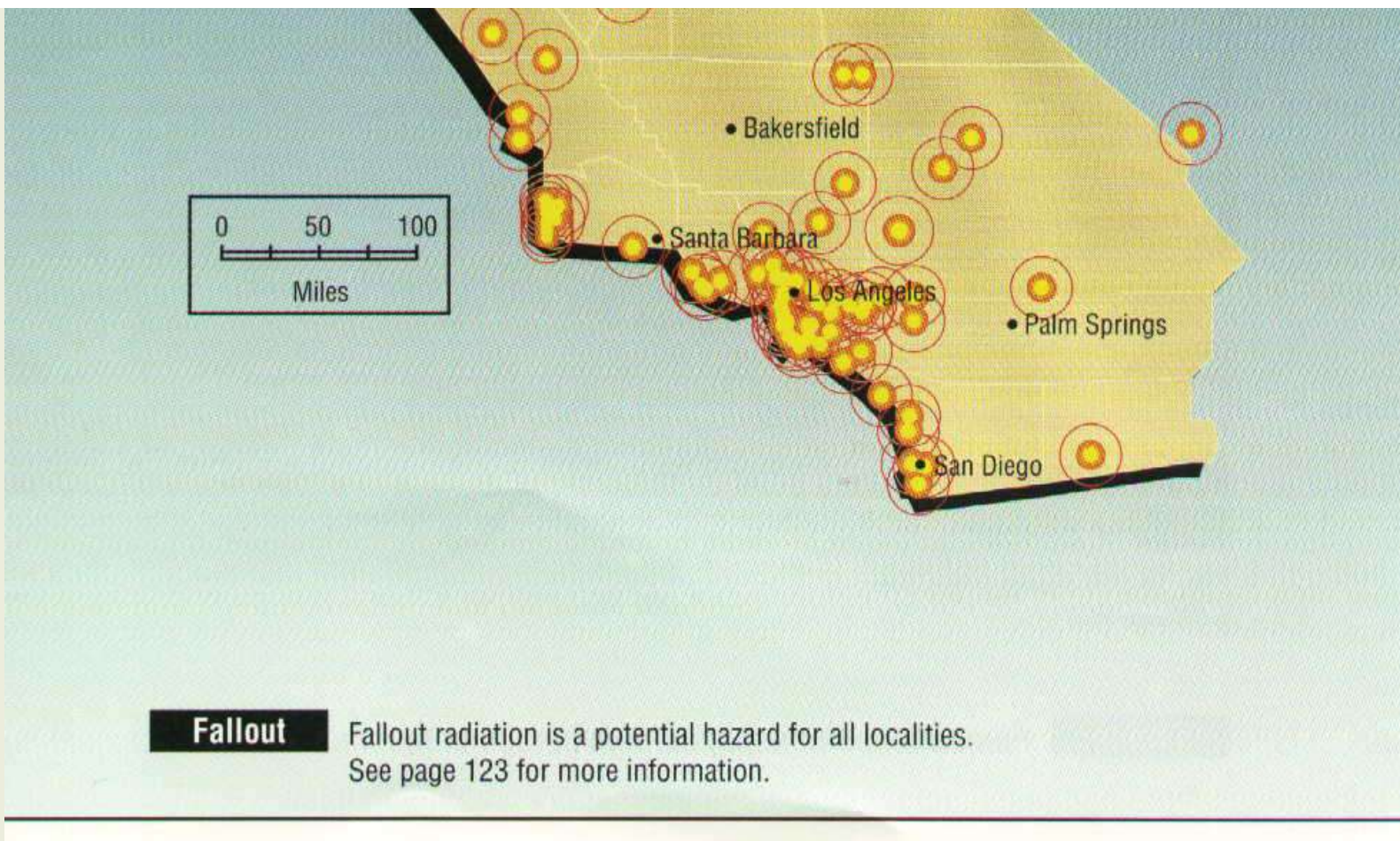
## Nuclear Survival in **California**

This is the nuclear target map for California, but remember, fallout can go anywhere or everywhere (and probably will). After you have looked at this map look at the [Information for California](#) that follows it.

This link will take you back to the [Index of all the States](#)

### **Nuclear Weapon Target Map for California (FEMA-196/September 1990)**





[UPDATE to Target Information!!!](#)

## Information for California

This link will take you back to the [Index of all the States](#)

It is recommended that you go through the following 10 steps in studying about the nuclear threat to California.

1. Look at the [State Map](#) above to see the target nuclear areas in California.
2. Look at the [general expected fallout map](#) to see where California (according to the **prevailing wind pattern**) gets fallout from other states.
3. If the state that you live in is anywhere EAST of any of the following 6 states in the **prevailing wind pattern** then look at the states in **RED** on the [INDEX of](#)

## STATES for

- Montana
- North Dakota
- South Dakota
- Nebraska
- Missouri
- Colorado

These six states contain what is called DENSE PACK which I explain on each of those states pages. **UNDERSTAND** that the wind pattern **COULD** at that time be something other than the "prevailing" wind pattern.

4. Bookmark the present URL or make a copy of this present address so that you can come back to it after going to

[Blast Mapper](#).

This mapper is on someone else's web site so that you will need to save this address in order to return here if your back button doesn't work. However, you want to be sure to go the mapper site and calculate the damage to probable targets (cities) around you.

5. Memorize the THREE top rules for survival. They are:

- Number One - **Get out of the cities!**
- Number Two - **Get out of the cities!**
- Number Three - **Get out of the cities!**

6. The follow-on rules are:

- a. Have a shelter
- b. Work with a group (you are going to need the manpower, brainpower, and skillpower).



- c. Stock supplies.

7. My [Main Survival Page](#) contains links to lots of other information such as free books to download about nuclear survival, links to plans for building shelters, and even free consultation about building a shelter.

8. If you are SUPER concerned about nuclear survival you might consider moving within 20 miles of the

[Ark Two Community](#)  
(in Canada)

9. And finally if you would like to be on the mailing list of the author of this site - send a blank email to:

[arktwo-request@deuce.pairowoodies.com](mailto:arktwo-request@deuce.pairowoodies.com)  
[with the subject as subscribe](#)

**MENU: [HOME](#) » [SURVIVAL](#) » [Index of States](#)**

---

---

## Nuclear Survival in **Colorado**

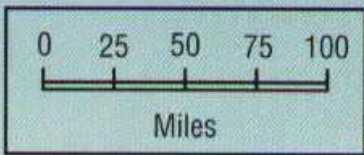
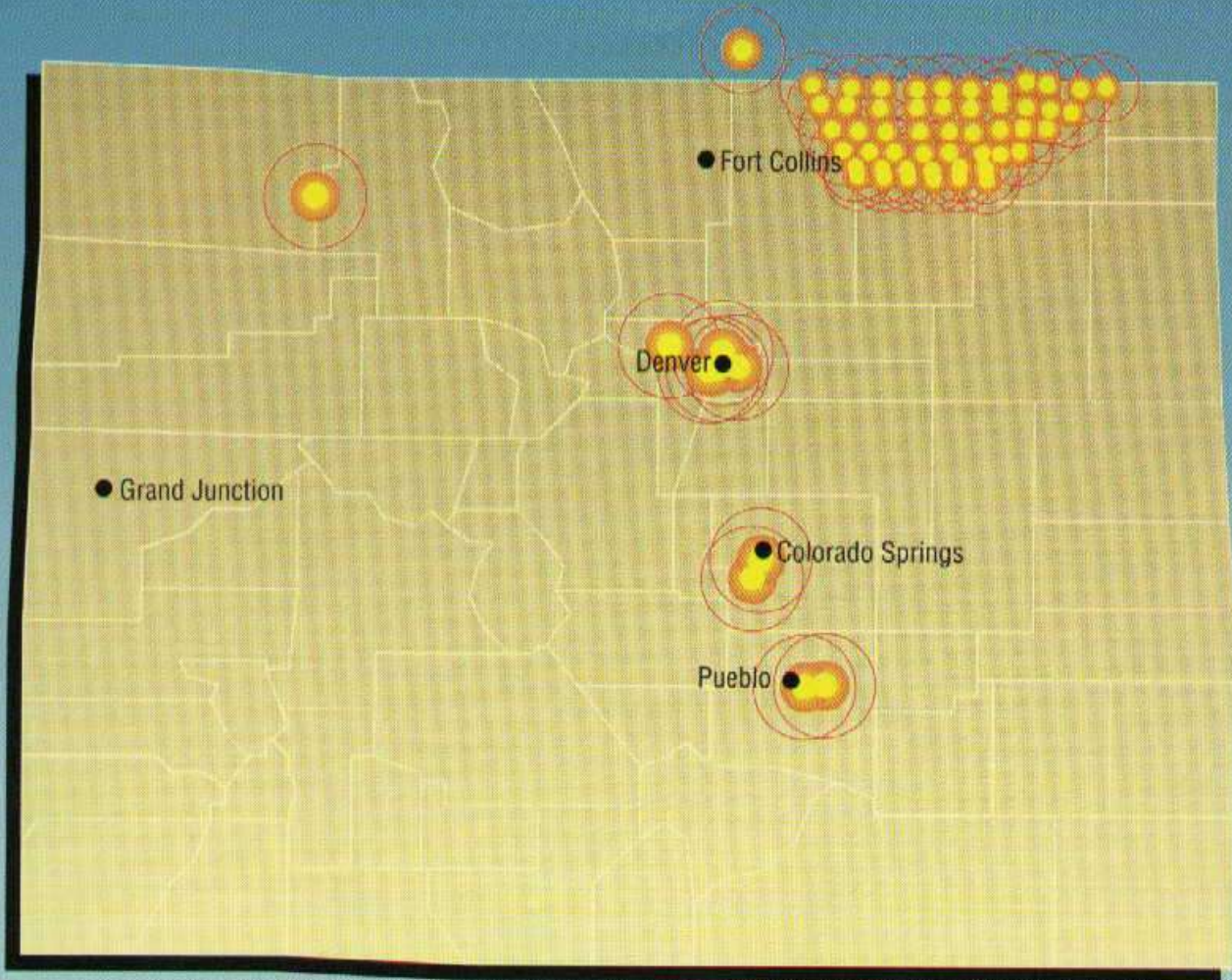
This is the nuclear target map for Colorado, but remember, fallout can go anywhere or everywhere (and probably will). After you have looked at this map look at the [Information for Colorado](#) that follows it.

This link will take you back to the [Index of all the States](#)

***DENSE PACK** - Look at all those target sites. So close Together! It serves a purpose. It is missiles protecting missiles, and this is how it is done. These are "hardened" sites. Meaning it takes a direct ground explosion to dig them out. An air burst will not do it. When you have a ground explosion it throws many tons of dust and sand up into the air. High into the air. This is what will later become fallout carried by the winds hundreds, sometimes thousands, of miles away. But right over that site that has just been hit the sand and grit in the air is very thick for quite a while. Another high speed missile (ICBM) trying to come through it will have its skin torn off just like by sand blasting and it will be destroyed. So the other missile sites nearby are safe. On the other hand, because missiles take off much slower than the speeds they eventually reach, the missiles in the undamaged silos can still be launched and will pass through the dust cloud without be harmed. Neat, eh? See there is a purpose in putting so many in one place. Now the only way that you can dig them out is with what is called a slow walk. Hit a target. Move on further and hit another target where the dust from the first won't hurt you. Come back thirty or forty-five minutes later and hit a second target near where you hit the first, after the cloud has had time to blow away. A slow process. Some silos will already have launched and you will waste the shot. Others can still wait to launch later because you can only get one at a time. This could go on for days. Neat. The military missiles protecting missiles. But they don't protect you, because if you are downwind you will get the fallout. Fatal if you are not in a*

*shelter. They call it Defense but it is only Destruction. Nothing here defends or protects you, if they are used.*

## Nuclear Weapon Target Map for Colorado (FEMA-196/September 1990)



### Nuclear Attack



Red Ring (0.5 to 2 psi): Up to 25 percent casualties. Light damage to commercial-type buildings, severe damage to small residences.

Orange Area (2 to 5 psi): 50 percent casualties. Moderate damage to commercial-type buildings, severe damage to small residences.

buildings, severe damage to small residences.

Yellow Area (5 psi or more): Few survivors. Severe damage to total destruction of buildings.

### Fallout

Fallout radiation is a potential hazard for all localities. See page 123 for more information.

[UPDATE to Target Information!!!](#)

## Information for Colorado

This link will take you back to the [Index of all the States](#)

It is recommended that you go through the following 10 steps in studying about the nuclear threat to Colorado.

1. Look at the [State Map](#) above to see the target nuclear areas in Colorado.
2. Look at the [general expected fallout map](#) to see where Colorado (according to the **prevailing wind pattern**) gets fallout from other states.
3. If the state that you live in is anywhere EAST of any of the following 6 states in the **prevailing wind pattern** then look at the states in **RED** on the [INDEX of STATES](#) for

- **Montana**
- **North Dakota**
- **South Dakota**
- **Nebraska**
- **Missouri**
- **Colorado**

These six states contain what is called DENSE PACK which I explain on each of

those states pages. **UNDERSTAND** that the wind pattern **COULD** at that time be something other than the "prevailing" wind pattern.

4. Bookmark the present URL or make a copy of this present address so that you can come back to it after going to

[Blast Mapper](#).

This mapper is on someone else's web site so that you will need to save this address in order to return here if your back button doesn't work. However, you want to be sure to go the mapper site and calculate the damage to probable targets (cities) around you.

5. Memorize the **THREE** top rules for survival. They are:

- Number One - **Get out of the cities!**
- Number Two - **Get out of the cities!**
- Number Three - **Get out of the cities!**

6. The follow-on rules are:

- a. Have a shelter
- b. Work with a group (you are going to need the manpower, brainpower, and skillpower).
- c. Stock supplies.

7. My [Main Survival Page](#) contains links to lots of other information such as free books to download about nuclear survival, links to plans for building shelters, and even free consultation about building a shelter.

8. If you are **SUPER** concerned about nuclear survival you might consider moving within 20 miles of the

[Ark Two Community](#)

(in Canada)

9. And finally if you would like to be on the mailing list of the author of this site - send a blank email to:

[arktvo-request@deuce.pairowoodies.com](mailto:arktvo-request@deuce.pairowoodies.com)  
[with the subject as subscribe](#)

**MENU:** [HOME](#) » [SURVIVAL](#) » [Index of States](#)

---

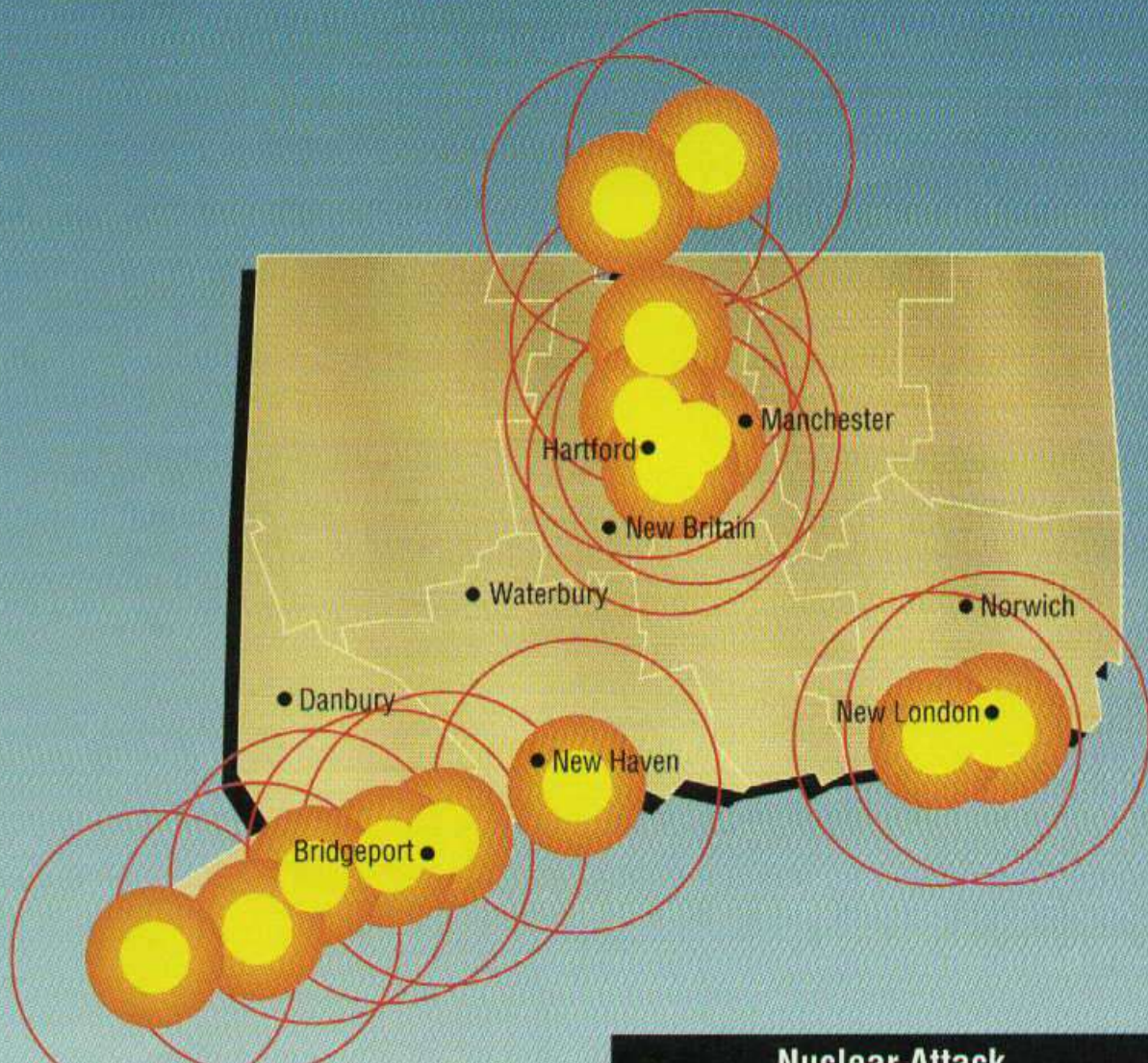
---

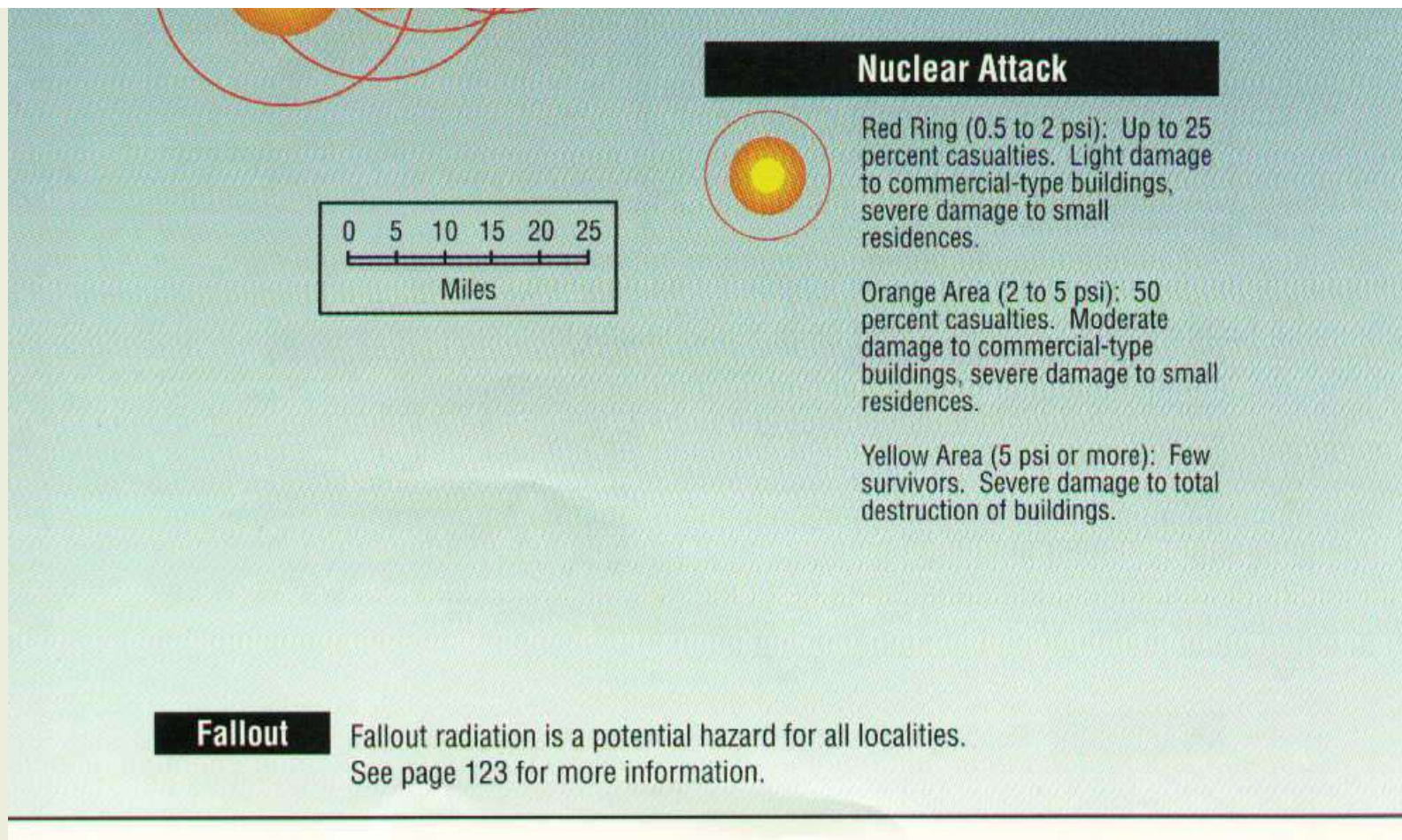
## Nuclear Survival in **Connecticut**

This is the nuclear target map for Connecticut, but remember, fallout can go anywhere or everywhere (and probably will). After you have looked at this map look at the [Information for Connecticut](#) that follows it.

This link will take you back to the [Index of all the States](#)

### **Nuclear Weapon Target Map for Connecticut (FEMA-196/September 1990)**





## [UPDATE to Target Information!!!](#)

### Information for Connecticut

This link will take you back to the [Index of all the States](#)

It is recommended that you go through the following 10 steps in studying about the nuclear threat to Connecticut.

1. Look at the [State Map](#) above to see the target nuclear areas in Connecticut.
2. Look at the [general expected fallout map](#) to see where Connecticut (according to the **prevailing wind pattern**) gets fallout from other states.
3. If the state that you live in is anywhere EAST of any of the following 6 states in the **prevailing wind pattern** then look at the states in **RED** on the [INDEX of](#)



## STATES for

- Montana
- North Dakota
- South Dakota
- Nebraska
- Missouri
- Colorado

These six states contain what is called DENSE PACK which I explain on each of those states pages. **UNDERSTAND** that the wind pattern **COULD** at that time be something other than the "prevailing" wind pattern.

4. Bookmark the present URL or make a copy of this present address so that you can come back to it after going to

[Blast Mapper](#).

This mapper is on someone else's web site so that you will need to save this address in order to return here if your back button doesn't work. However, you want to be sure to go the mapper site and calculate the damage to probable targets (cities) around you.

5. Memorize the THREE top rules for survival. They are:

- Number One - **Get out of the cities!**
- Number Two - **Get out of the cities!**
- Number Three - **Get out of the cities!**

6. The follow-on rules are:

- a. Have a shelter
- b. Work with a group (you are going to need the manpower, brainpower, and skillpower).

- c. Stock supplies.

7. My [Main Survival Page](#) contains links to lots of other information such as free books to download about nuclear survival, links to plans for building shelters, and even free consultation about building a shelter.

8. If you are SUPER concerned about nuclear survival you might consider moving within 20 miles of the

[Ark Two Community](#)  
(in Canada)

9. And finally if you would like to be on the mailing list of the author of this site - send a blank email to:

[arktwo-request@deuce.pairowoodies.com](mailto:arktwo-request@deuce.pairowoodies.com)  
[with the subject as subscribe](#)

**MENU: [HOME](#) » [SURVIVAL](#) » [Index of States](#)**

---

---

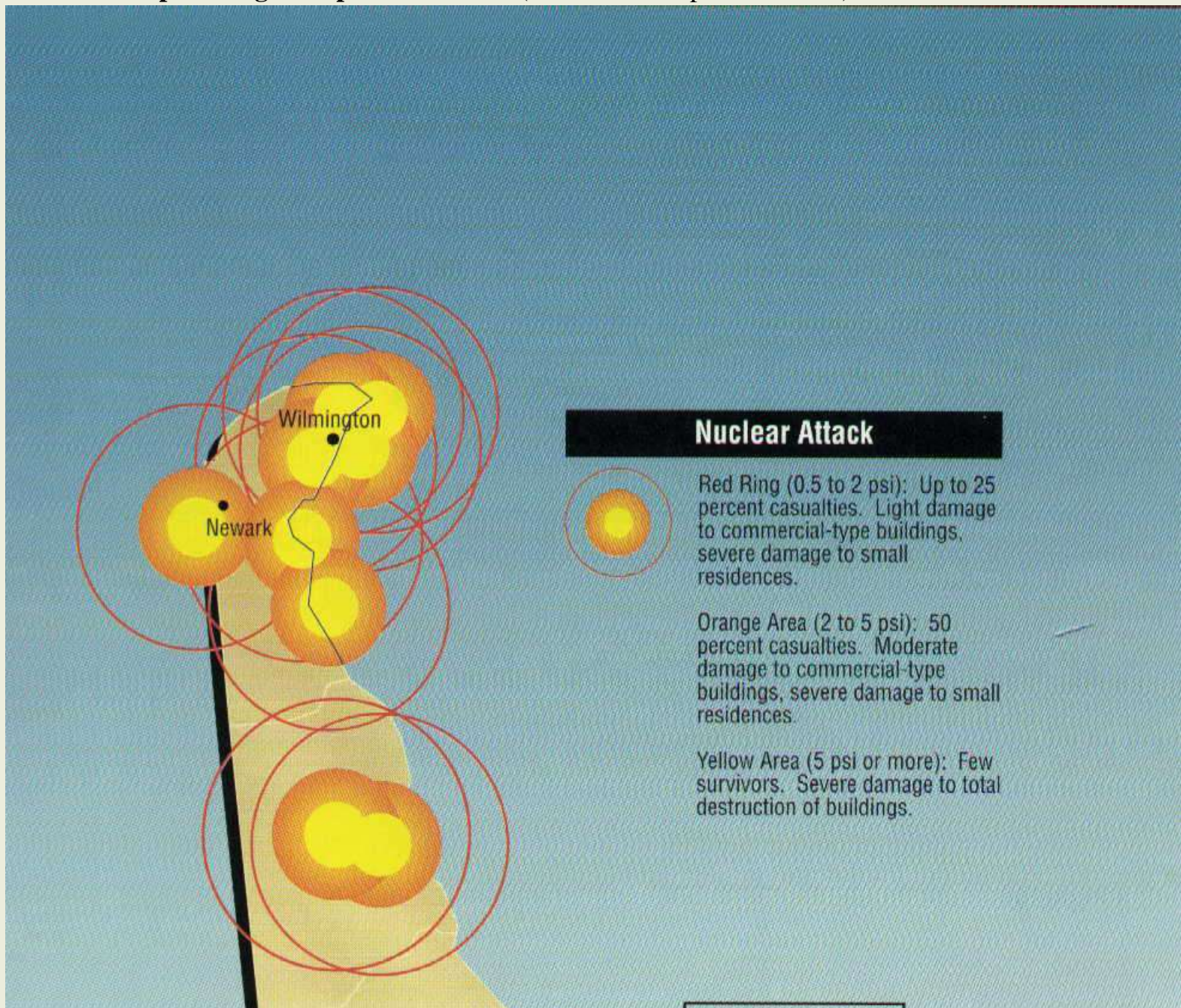
Nuclear Survival in

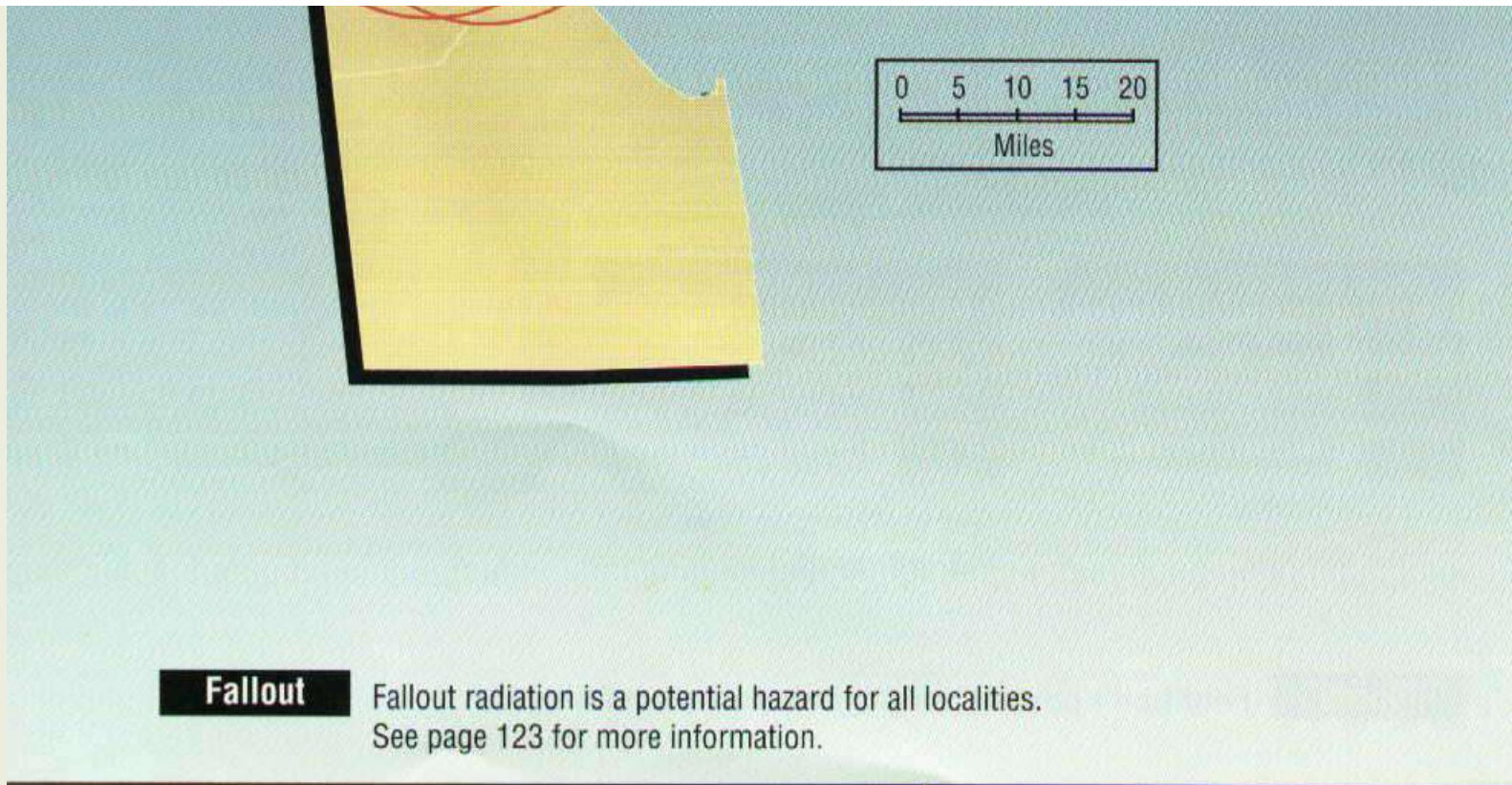
# Delaware

This is the nuclear target map for Delaware, but remember, fallout can go anywhere or everywhere (and probably will). After you have looked at this map look at the [Information for Delaware](#) that follows it.

This link will take you back to the [Index of all the States](#)

## Nuclear Weapon Target Map for Delaware (FEMA-196/September 1990)





[UPDATE to Target Information!!!](#)

## Information for Delaware

This link will take you back to the [Index of all the States](#)

It is recommended that you go through the following 10 steps in studying about the nuclear threat to Delaware.

1. Look at the [State Map](#) above to see the target nuclear areas in Delaware.
2. Look at the [general expected fallout map](#) to see where Delaware (according to the **prevailing wind pattern**) gets fallout from other states.
3. If the state that you live in is anywhere EAST of any of the following 6 states in the **prevailing wind pattern** then look at the states in **RED** on the [INDEX of STATES](#) for
  - **Montana**
  - **North Dakota**
  - **South Dakota**
  - **Nebraska**
  - **Missouri**

- **Colorado**

These six states contain what is called DENSE PACK which I explain on each of those states pages. **UNDERSTAND** that the wind pattern **COULD** at that time be something other than the "prevailing" wind pattern.

4. Bookmark the present URL or make a copy of this present address so that you can come back to it after going to

[Blast Mapper](#).

This mapper is on someone else's web site so that you will need to save this address in order to return here if your back button doesn't work. However, you want to be sure to go the mapper site and calculate the damage to probable targets (cities) around you.

5. Memorize the THREE top rules for survival. They are:

- Number One - **Get out of the cities!**
- Number Two - **Get out of the cities!**
- Number Three - **Get out of the cities!**

6. The follow-on rules are:

- a. Have a shelter
- b. Work with a group (you are going to need the manpower, brainpower, and skillpower).
- c. Stock supplies.

7. My [Main Survival Page](#) contains links to lots of other information such as free books to download about nuclear survival, links to plans for building shelters, and even free consultation about building a shelter.

8. If you are SUPER concerned about nuclear survival you might consider moving within 20 miles of the

[Ark Two Community](#)

(in Canada)

9. And finally if you would like to be on the mailing list of the author of this site - send a blank email to:

[arktvo-request@deuce.pairowoodies.com](mailto:arktvo-request@deuce.pairowoodies.com)

with the subject as subscribe

**MENU: [HOME](#) » [SURVIVAL](#) » [Index of States](#)**

---

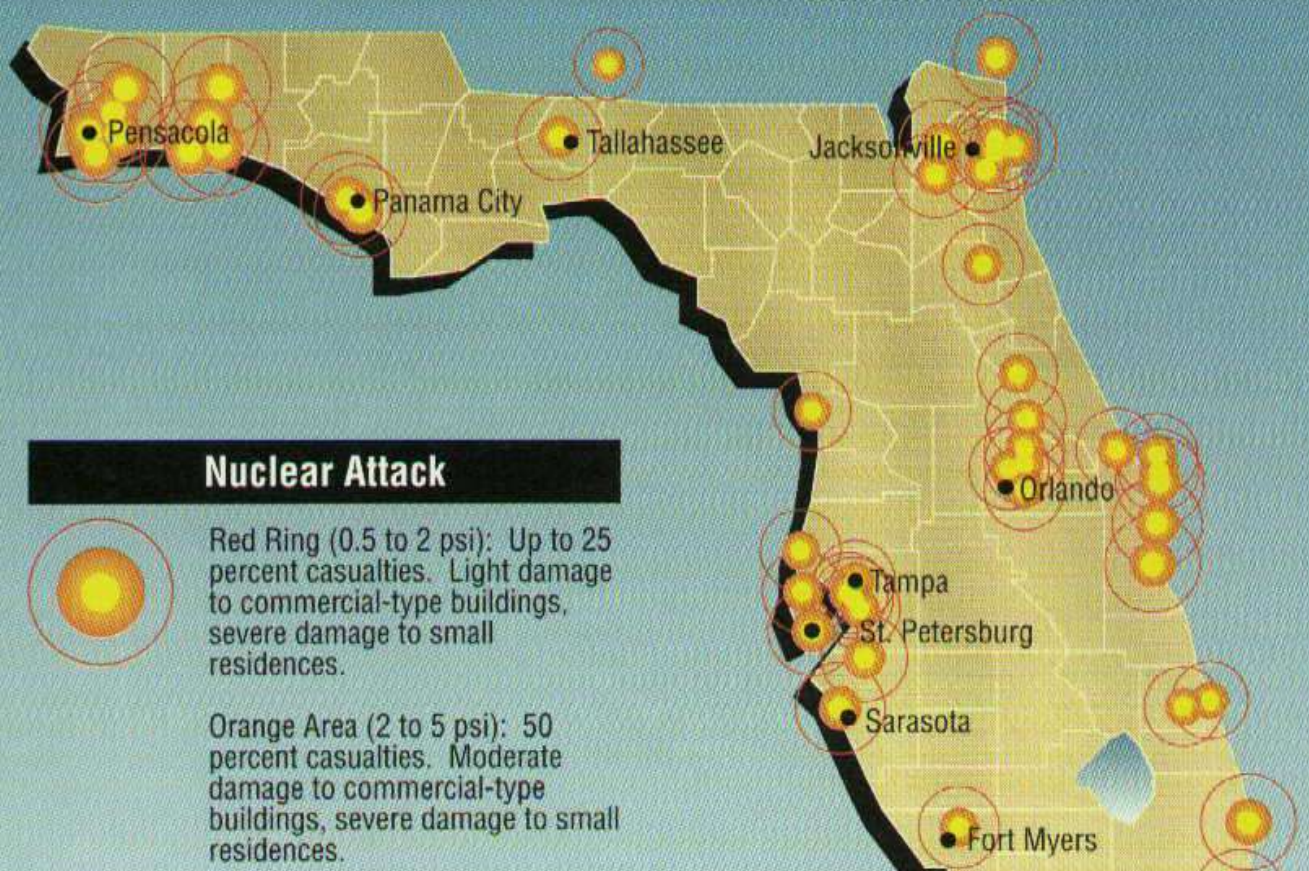
---

## Nuclear Survival in **Florida**

This is the nuclear target map for Florida, but remember, fallout can go anywhere or everywhere (and probably will). After you have looked at this map look at the [Information for Florida](#) that follows it.

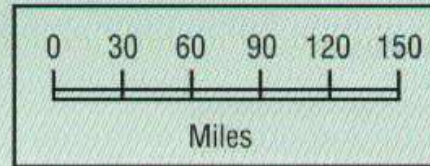
This link will take you back to the [Index of all the States](#)

### **Nuclear Weapon Target Map for Florida (FEMA-196/September 1990)**



buildings, severe damage to small residences.

Yellow Area (5 psi or more): Few survivors. Severe damage to total destruction of buildings.



### Fallout

Fallout radiation is a potential hazard for all localities. See page 123 for more information.

[UPDATE to Target Information!!!](#)

## Information for Florida

This link will take you back to the [Index of all the States](#)

It is recommended that you go through the following 10 steps in studying about the nuclear threat to Florida.

1. Look at the [State Map](#) above to see the target nuclear areas in Florida.
2. Look at the [general expected fallout map](#) to see where Florida (according to the **prevailing wind pattern**) gets fallout from other states.
3. If the state that you live in is anywhere EAST of any of the following 6 states in the **prevailing wind pattern** then look at the states in **RED** on the [INDEX of](#)



## STATES for

- Montana
- North Dakota
- South Dakota
- Nebraska
- Missouri
- Colorado

These six states contain what is called DENSE PACK which I explain on each of those states pages. **UNDERSTAND** that the wind pattern **COULD** at that time be something other than the "prevailing" wind pattern.

4. Bookmark the present URL or make a copy of this present address so that you can come back to it after going to

[Blast Mapper](#).

This mapper is on someone else's web site so that you will need to save this address in order to return here if your back button doesn't work. However, you want to be sure to go the mapper site and calculate the damage to probable targets (cities) around you.

5. Memorize the THREE top rules for survival. They are:

- Number One - **Get out of the cities!**
- Number Two - **Get out of the cities!**
- Number Three - **Get out of the cities!**

6. The follow-on rules are:

- a. Have a shelter
- b. Work with a group (you are going to need the manpower, brainpower, and skillpower).

- c. Stock supplies.

7. My [Main Survival Page](#) contains links to lots of other information such as free books to download about nuclear survival, links to plans for building shelters, and even free consultation about building a shelter.

8. If you are SUPER concerned about nuclear survival you might consider moving within 20 miles of the

[Ark Two Community](#)  
(in Canada)

9. And finally if you would like to be on the mailing list of the author of this site - send a blank email to:

[arktwo-request@deuce.pairowoodies.com](mailto:arktwo-request@deuce.pairowoodies.com)  
[with the subject as subscribe](#)

**MENU: [HOME](#) » [SURVIVAL](#) » [Index of States](#)**

---

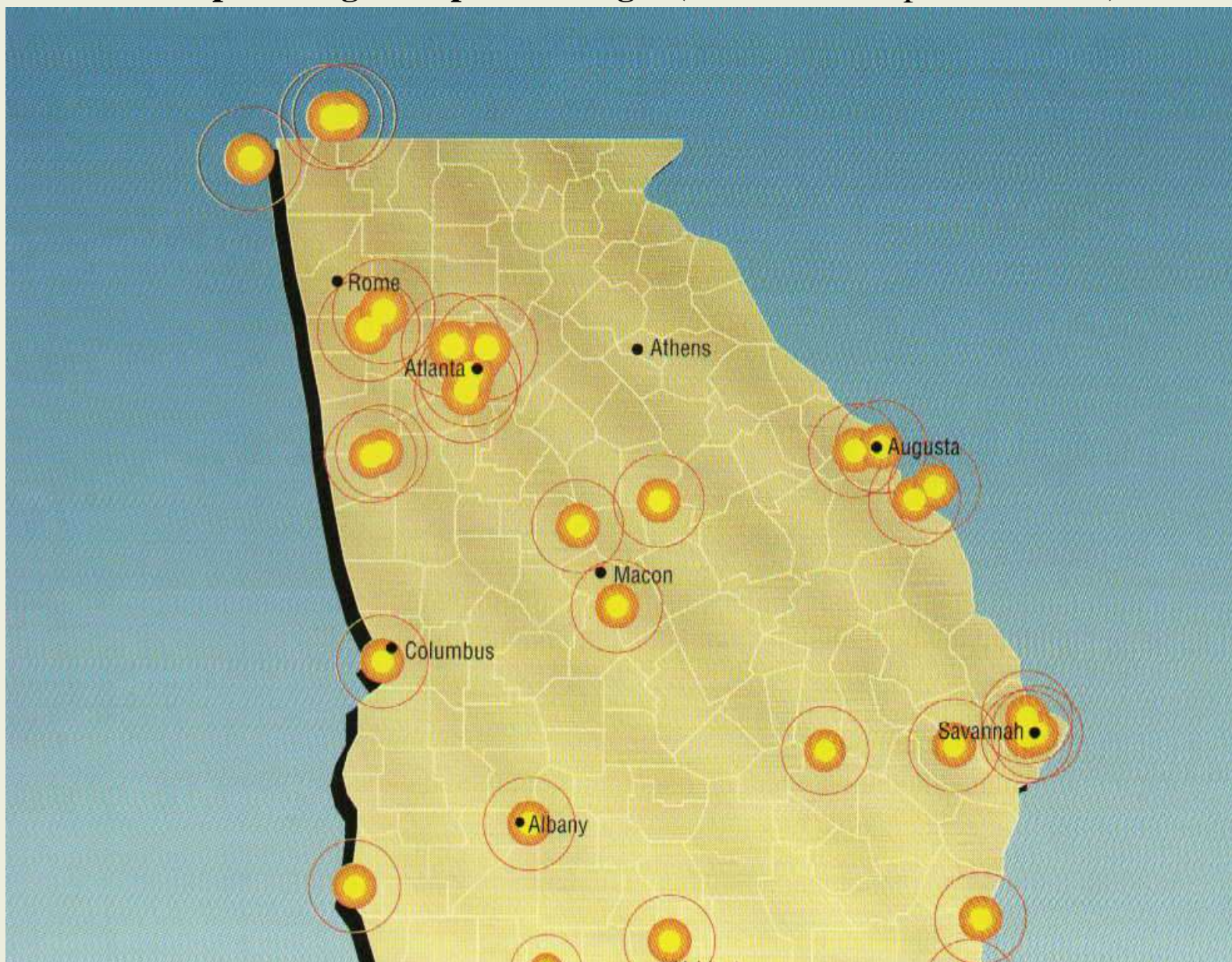
---

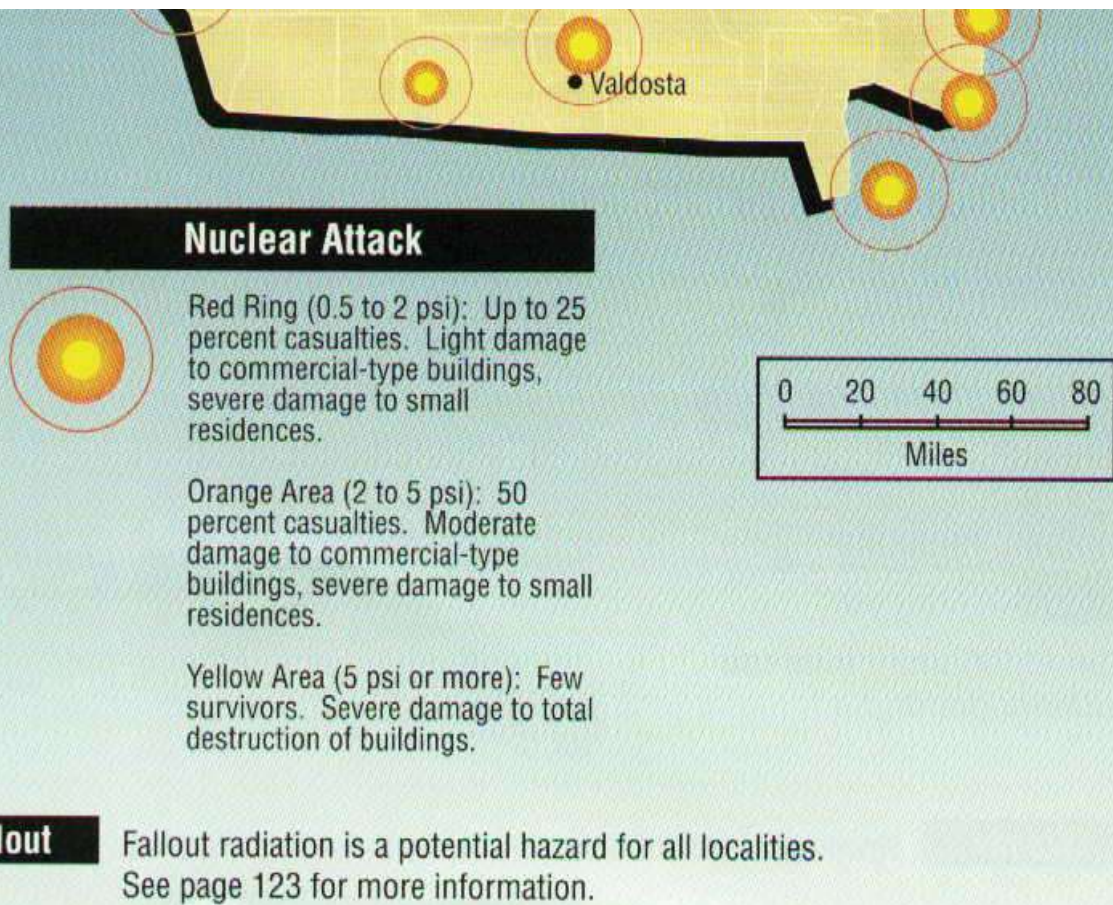
## Nuclear Survival in **Georgia**

This is the nuclear target map for Georgia, but remember, fallout can go anywhere or everywhere (and probably will). After you have looked at this map look at the [Information for Georgia](#) that follows it.

This link will take you back to the [Index of all the States](#)

### **Nuclear Weapon Target Map for Georgia (FEMA-196/September 1990)**





## [UPDATE to Target Information!!!](#)

### Information for Georgia

This link will take you back to the [Index of all the States](#)

It is recommended that you go through the following 10 steps in studying about the nuclear threat to Georgia.

1. Look at the [State Map](#) above to see the target nuclear areas in Georgia.
2. Look at the [general expected fallout map](#) to see where Georgia (according to the **prevailing wind pattern**) gets fallout from other states.
3. If the state that you live in is anywhere EAST of any of the following 6 states in the **prevailing wind pattern** then look at the states in **RED** on the [INDEX of](#)

## STATES for

- Montana
- North Dakota
- South Dakota
- Nebraska
- Missouri
- Colorado

These six states contain what is called DENSE PACK which I explain on each of those states pages. **UNDERSTAND** that the wind pattern **COULD** at that time be something other than the "prevailing" wind pattern.

4. Bookmark the present URL or make a copy of this present address so that you can come back to it after going to

[Blast Mapper](#).

This mapper is on someone else's web site so that you will need to save this address in order to return here if your back button doesn't work. However, you want to be sure to go the mapper site and calculate the damage to probable targets (cities) around you.

5. Memorize the THREE top rules for survival. They are:

- Number One - **Get out of the cities!**
- Number Two - **Get out of the cities!**
- Number Three - **Get out of the cities!**

6. The follow-on rules are:

- a. Have a shelter
- b. Work with a group (you are going to need the manpower, brainpower, and skillpower).

- c. Stock supplies.

7. My [Main Survival Page](#) contains links to lots of other information such as free books to download about nuclear survival, links to plans for building shelters, and even free consultation about building a shelter.

8. If you are SUPER concerned about nuclear survival you might consider moving within 20 miles of the

[Ark Two Community](#)  
(in Canada)

9. And finally if you would like to be on the mailing list of the author of this site - send a blank email to:

[arktwo-request@deuce.pairowoodies.com](mailto:arktwo-request@deuce.pairowoodies.com)  
[with the subject as subscribe](#)

**MENU: [HOME](#) » [SURVIVAL](#) » [Index of States](#)**

---

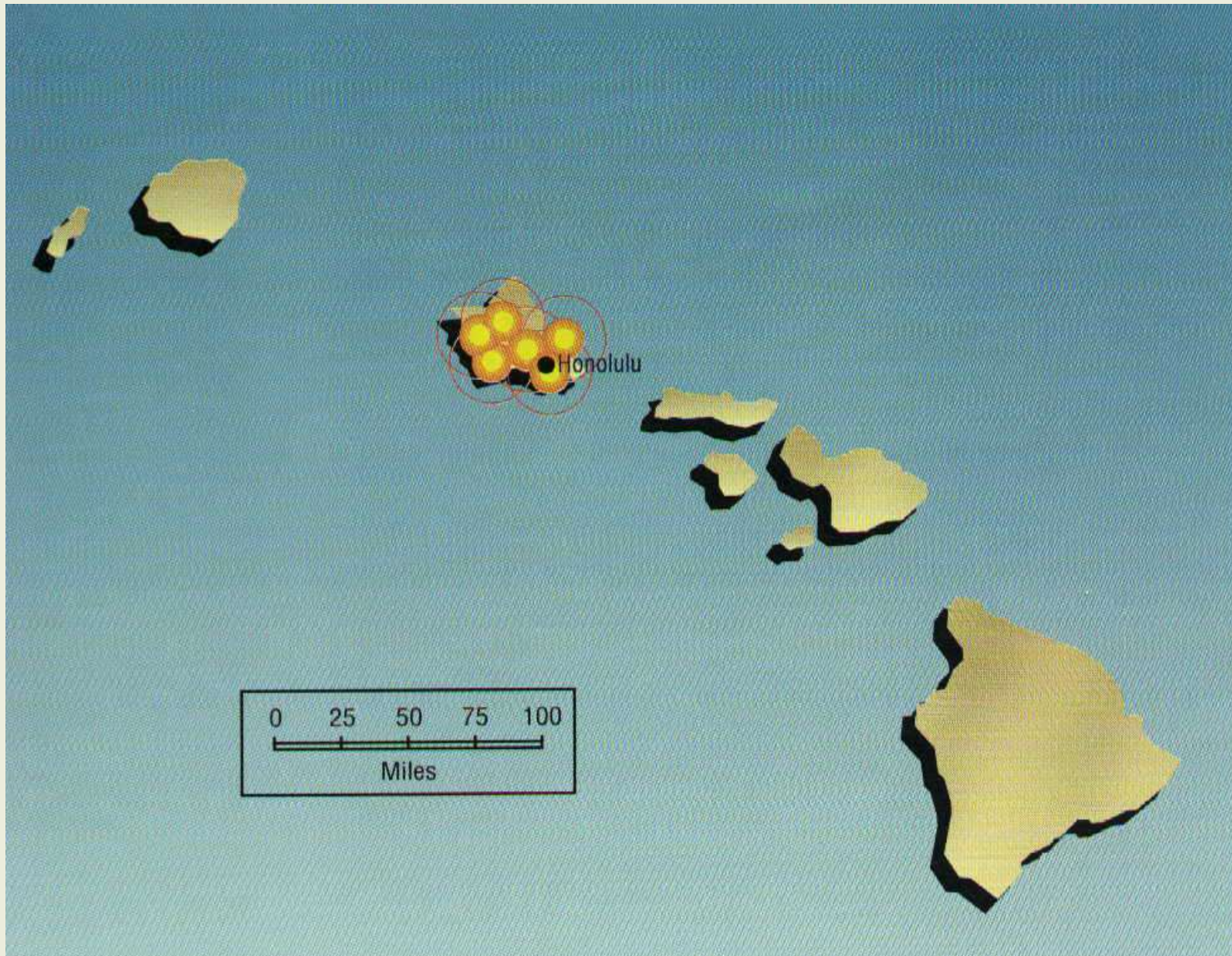
---

## Nuclear Survival in **Hawaii**

This is the nuclear target map for Hawaii, but remember, fallout can go anywhere or everywhere (and probably will). After you have looked at this map look at the [Information for Hawaii](#) that follows it.

This link will take you back to the [Index of all the States](#)

### **Nuclear Weapon Target Map for Hawaii (FEMA-196/September 1990)**



## Nuclear Attack



Red Ring (0.5 to 2 psi): Up to 25 percent casualties. Light damage to commercial-type buildings, severe damage to small residences.

Orange Area (2 to 5 psi): 50 percent casualties. Moderate damage to commercial-type buildings, severe damage to small residences.

Yellow Area (5 psi or more): Few survivors. Severe damage to total destruction of buildings.

## Fallout

Fallout radiation is a potential hazard for all localities. See page 123 for more information.

## [UPDATE to Target Information!!!](#)

## Information for Hawaii

This link will take you back to the [Index of all the States](#)

It is recommended that you go through the following 10 steps in studying about the nuclear threat to Hawaii.

1. Look at the [State Map](#) above to see the target nuclear areas in Hawaii.
2. Look at the [general expected fallout map](#) to see where Hawaii (according to the **prevailing wind pattern**) gets fallout from other states.
3. If the state that you live in is anywhere EAST of any of the following 6 states in the **prevailing wind pattern** then look at the states in **RED** on the [INDEX of](#)



## STATES for

- Montana
- North Dakota
- South Dakota
- Nebraska
- Missouri
- Colorado

These six states contain what is called DENSE PACK which I explain on each of those states pages. **UNDERSTAND** that the wind pattern **COULD** at that time be something other than the "prevailing" wind pattern.

4. Bookmark the present URL or make a copy of this present address so that you can come back to it after going to

[Blast Mapper](#).

This mapper is on someone else's web site so that you will need to save this address in order to return here if your back button doesn't work. However, you want to be sure to go the mapper site and calculate the damage to probable targets (cities) around you.

5. Memorize the THREE top rules for survival. They are:

- Number One - **Get out of the cities!**
- Number Two - **Get out of the cities!**
- Number Three - **Get out of the cities!**

6. The follow-on rules are:

- a. Have a shelter
- b. Work with a group (you are going to need the manpower, brainpower, and skillpower).

- c. Stock supplies.

7. My [Main Survival Page](#) contains links to lots of other information such as free books to download about nuclear survival, links to plans for building shelters, and even free consultation about building a shelter.

8. If you are SUPER concerned about nuclear survival you might consider moving within 20 miles of the

[Ark Two Community](#)  
(in Canada)

9. And finally if you would like to be on the mailing list of the author of this site - send a blank email to:

[arktwo-request@deuce.pairowoodies.com](mailto:arktwo-request@deuce.pairowoodies.com)  
[with the subject as subscribe](#)

**MENU: [HOME](#) » [SURVIVAL](#) » [Index of States](#)**

---

---

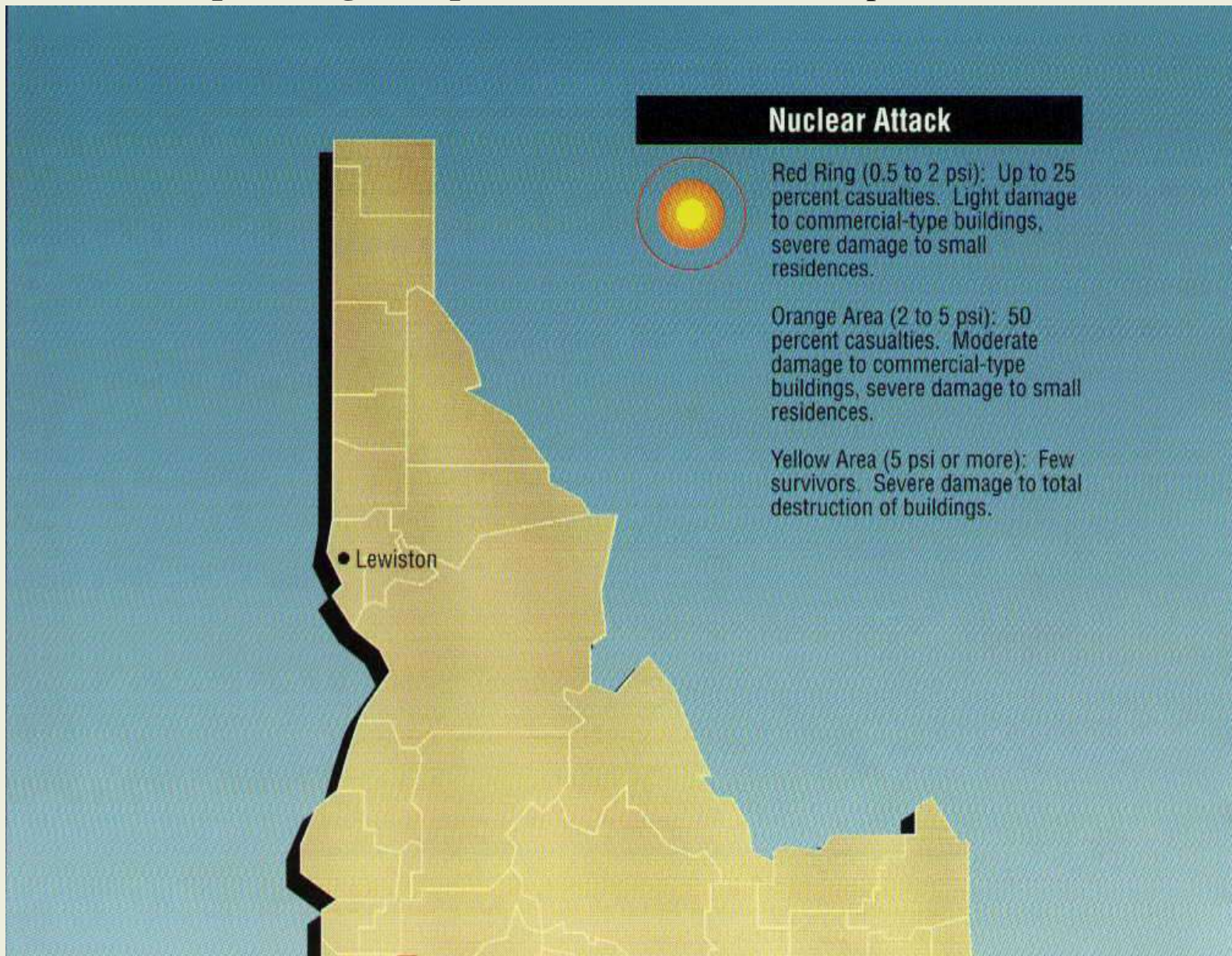
Nuclear Survival in

# Idaho

This is the nuclear target map for Idaho, but remember, fallout can go anywhere or everywhere (and probably will). After you have looked at this map look at the [Information for Idaho](#) that follows it.

This link will take you back to the [Index of all the States](#)

## Nuclear Weapon Target Map for Idaho (FEMA-196/September 1990)





### Fallout

Fallout radiation is a potential hazard for all localities.  
See page 123 for more information.

[UPDATE to Target Information!!!](#)

## Information for Idaho

This link will take you back to the [Index of all the States](#)

It is recommended that you go through the following 10 steps in studying about the nuclear threat to Idaho.

1. Look at the [State Map](#) above to see the target nuclear areas in Idaho.
2. Look at the [general expected fallout map](#) to see where Idaho (according to the **prevailing wind pattern**) gets fallout from other states.
3. If the state that you live in is anywhere EAST of any of the following 6 states in the **prevailing wind pattern** then look at the states in **RED** on the [INDEX of](#)

## STATES for

- Montana
- North Dakota
- South Dakota
- Nebraska
- Missouri
- Colorado

These six states contain what is called DENSE PACK which I explain on each of those states pages. **UNDERSTAND** that the wind pattern **COULD** at that time be something other than the "prevailing" wind pattern.

4. Bookmark the present URL or make a copy of this present address so that you can come back to it after going to

[Blast Mapper](#).

This mapper is on someone else's web site so that you will need to save this address in order to return here if your back button doesn't work. However, you want to be sure to go the mapper site and calculate the damage to probable targets (cities) around you.

5. Memorize the THREE top rules for survival. They are:

- Number One - **Get out of the cities!**
- Number Two - **Get out of the cities!**
- Number Three - **Get out of the cities!**

6. The follow-on rules are:

- a. Have a shelter
- b. Work with a group (you are going to need the manpower, brainpower, and skillpower).

- c. Stock supplies.

7. My [Main Survival Page](#) contains links to lots of other information such as free books to download about nuclear survival, links to plans for building shelters, and even free consultation about building a shelter.

8. If you are SUPER concerned about nuclear survival you might consider moving within 20 miles of the

[Ark Two Community](#)  
(in Canada)

9. And finally if you would like to be on the mailing list of the author of this site - send a blank email to:

[arktwo-request@deuce.pairowoodies.com](mailto:arktwo-request@deuce.pairowoodies.com)  
[with the subject as subscribe](#)

**MENU: [HOME](#) » [SURVIVAL](#) » [Index of States](#)**

---

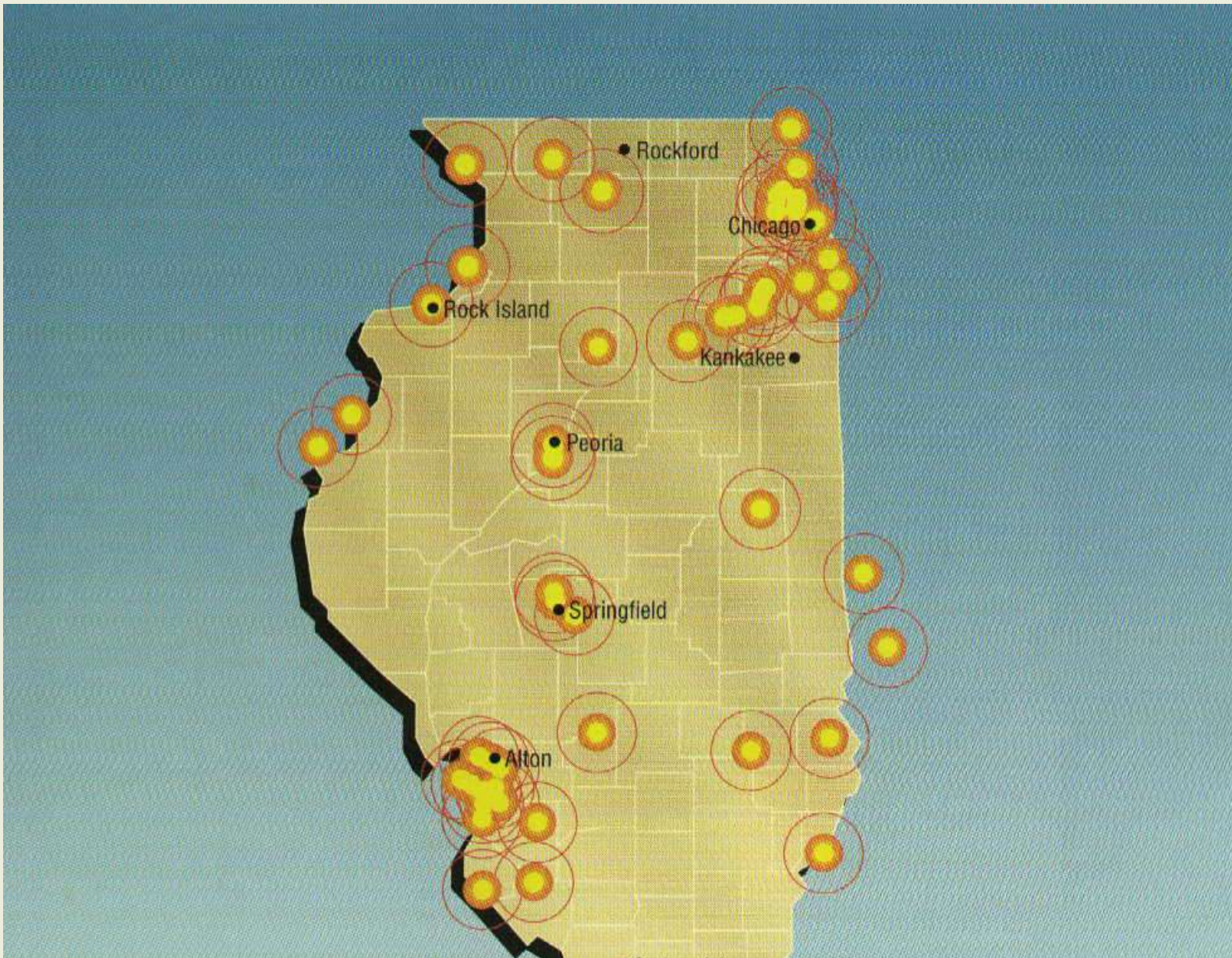
---

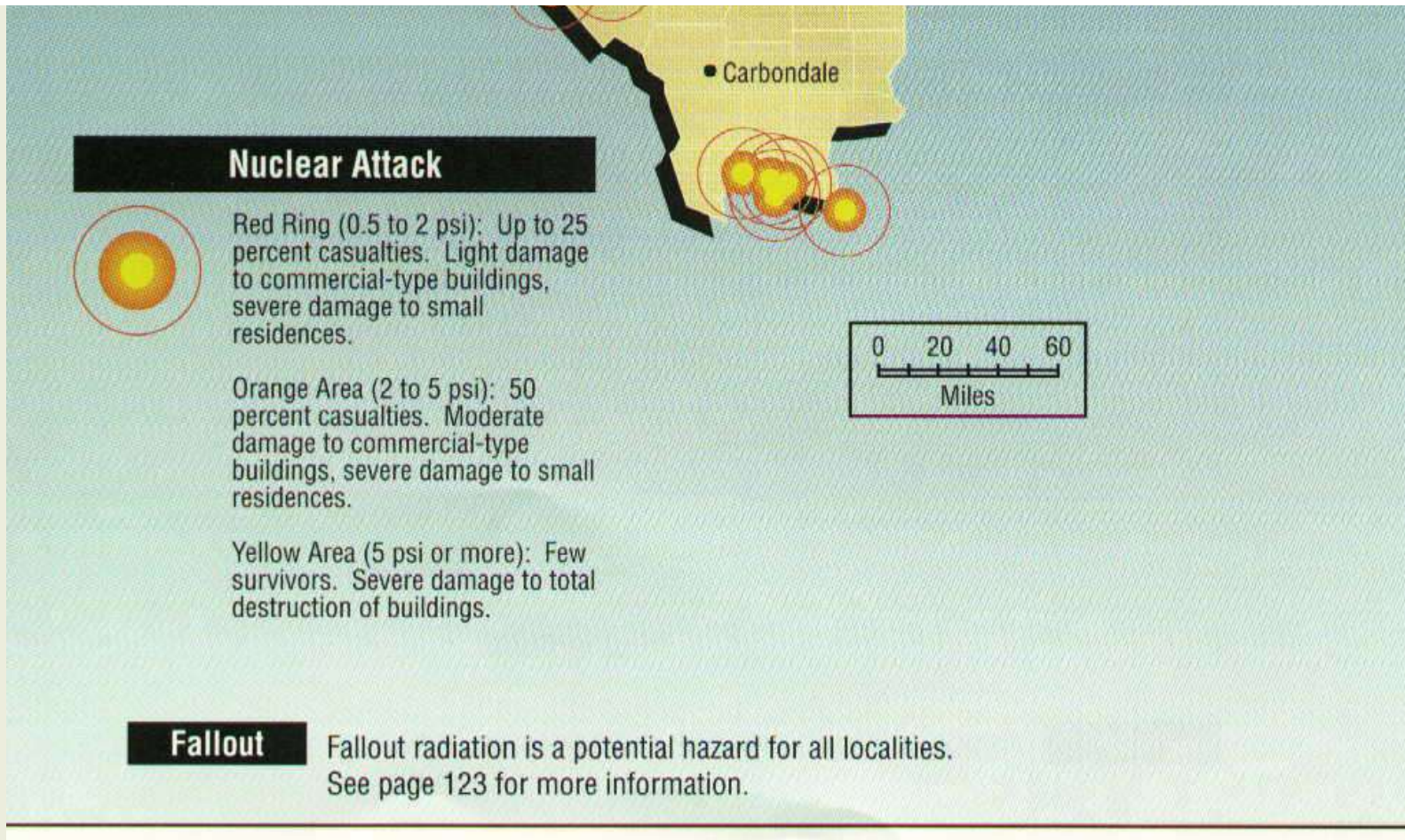
## Nuclear Survival in **Illinois**

This is the nuclear target map for Illinois, but remember, fallout can go anywhere or everywhere (and probably will). After you have looked at this map look at the [Information for Illinois](#) that follows it.

This link will take you back to the [Index of all the States](#)

### **Nuclear Weapon Target Map for Illinois (FEMA-196/September 1990)**





[UPDATE to Target Information!!!](#)

## Information for Illinois

This link will take you back to the [Index of all the States](#)

It is recommended that you go through the following 10 steps in studying about the nuclear threat to Illinois.

1. Look at the [State Map](#) above to see the target nuclear areas in Illinois.
2. Look at the [general expected fallout map](#) to see where Illinois (according to the **prevailing wind pattern**) gets fallout from other states.
3. If the state that you live in is anywhere EAST of any of the following 6 states in the **prevailing wind pattern** then look at the states in **RED** on the [INDEX of](#)



## STATES for

- Montana
- North Dakota
- South Dakota
- Nebraska
- Missouri
- Colorado

These six states contain what is called DENSE PACK which I explain on each of those states pages. **UNDERSTAND** that the wind pattern **COULD** at that time be something other than the "prevailing" wind pattern.

4. Bookmark the present URL or make a copy of this present address so that you can come back to it after going to

[Blast Mapper](#).

This mapper is on someone else's web site so that you will need to save this address in order to return here if your back button doesn't work. However, you want to be sure to go the mapper site and calculate the damage to probable targets (cities) around you.

5. Memorize the THREE top rules for survival. They are:

- Number One - **Get out of the cities!**
- Number Two - **Get out of the cities!**
- Number Three - **Get out of the cities!**

6. The follow-on rules are:

- a. Have a shelter
- b. Work with a group (you are going to need the manpower, brainpower, and skillpower).

- c. Stock supplies.

7. My [Main Survival Page](#) contains links to lots of other information such as free books to download about nuclear survival, links to plans for building shelters, and even free consultation about building a shelter.

8. If you are SUPER concerned about nuclear survival you might consider moving within 20 miles of the

[Ark Two Community](#)  
(in Canada)

9. And finally if you would like to be on the mailing list of the author of this site - send a blank email to:

[arktwo-request@deuce.pairowoodies.com](mailto:arktwo-request@deuce.pairowoodies.com)  
[with the subject as subscribe](#)

**MENU: [HOME](#) » [SURVIVAL](#) » [Index of States](#)**

---

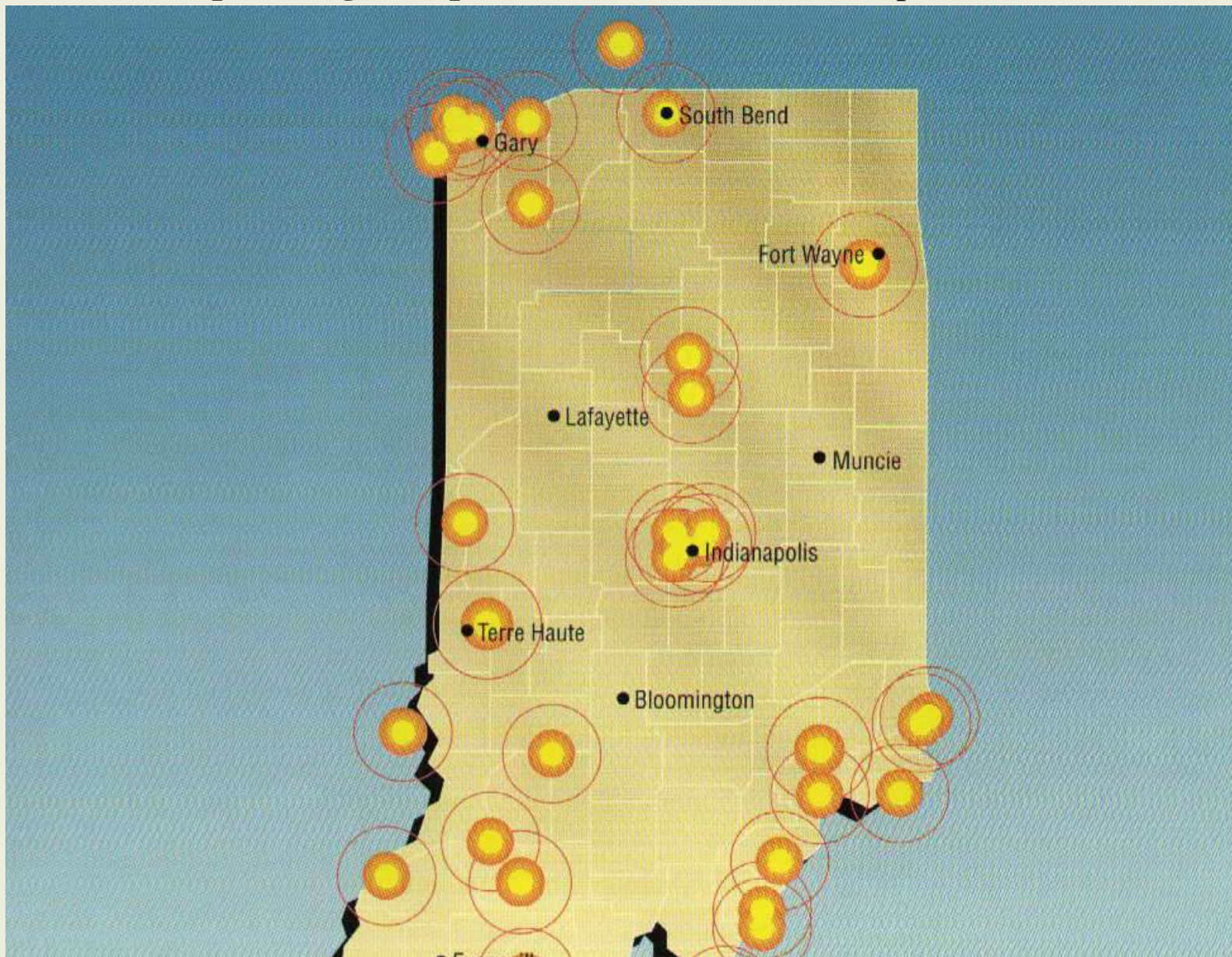
---

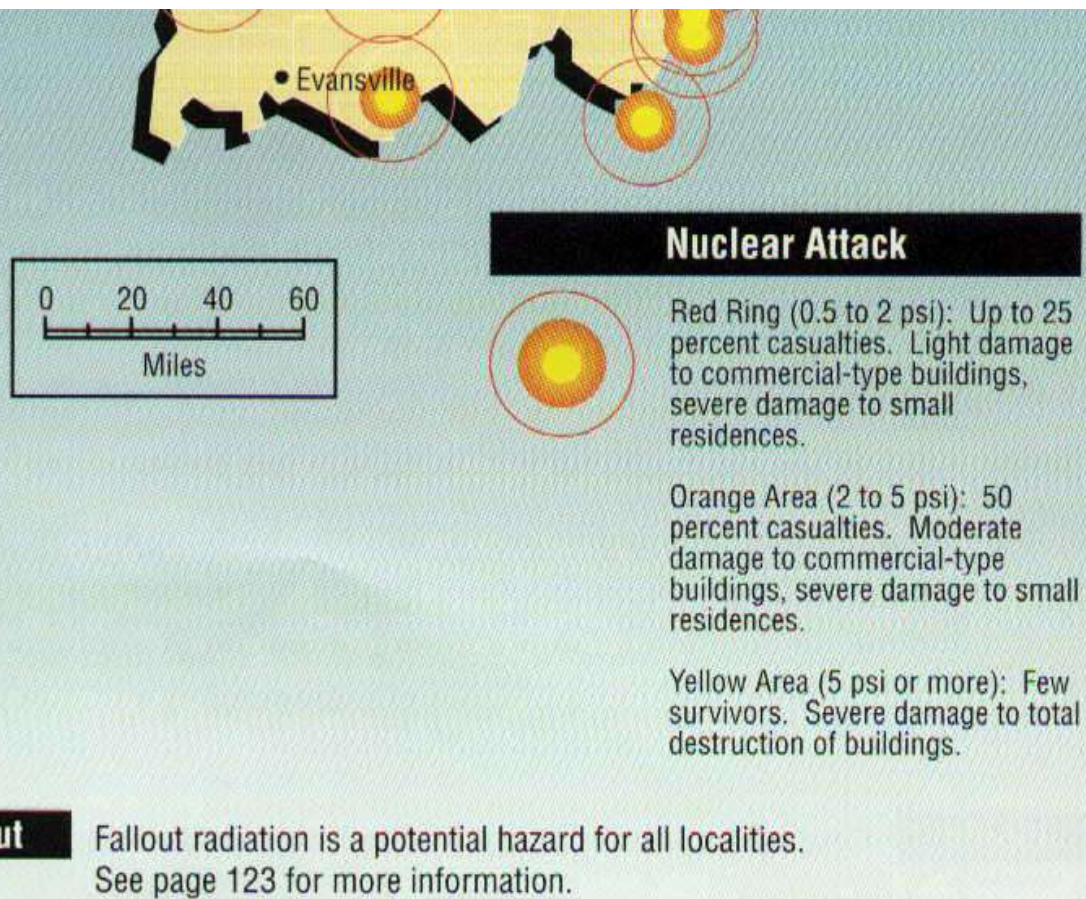
## Nuclear Survival in **Indiana**

This is the nuclear target map for Indiana, but remember, fallout can go anywhere or everywhere (and probably will). After you have looked at this map look at the [Information for Indiana](#) that follows it.

This link will take you back to the [Index of all the States](#)

### **Nuclear Weapon Target Map for Indiana (FEMA-196/September 1990)**





[UPDATE to Target Information!!!](#)

## Information for Indiana

This link will take you back to the [Index of all the States](#)

It is recommended that you go through the following 10 steps in studying about the nuclear threat to Indiana.

1. Look at the [State Map](#) above to see the target nuclear areas in Indiana.
2. Look at the [general expected fallout map](#) to see where Indiana (according to the **prevailing wind pattern**) gets fallout from other states.
3. If the state that you live in is anywhere EAST of any of the following 6 states in the **prevailing wind pattern** then look at the states in **RED** on the [INDEX of](#)

## STATES for

- Montana
- North Dakota
- South Dakota
- Nebraska
- Missouri
- Colorado

These six states contain what is called DENSE PACK which I explain on each of those states pages. **UNDERSTAND** that the wind pattern **COULD** at that time be something other than the "prevailing" wind pattern.

4. Bookmark the present URL or make a copy of this present address so that you can come back to it after going to

[Blast Mapper](#).

This mapper is on someone else's web site so that you will need to save this address in order to return here if your back button doesn't work. However, you want to be sure to go the mapper site and calculate the damage to probable targets (cities) around you.

5. Memorize the THREE top rules for survival. They are:

- Number One - **Get out of the cities!**
- Number Two - **Get out of the cities!**
- Number Three - **Get out of the cities!**

6. The follow-on rules are:

- a. Have a shelter
- b. Work with a group (you are going to need the manpower, brainpower, and skillpower).

- c. Stock supplies.

7. My [Main Survival Page](#) contains links to lots of other information such as free books to download about nuclear survival, links to plans for building shelters, and even free consultation about building a shelter.

8. If you are SUPER concerned about nuclear survival you might consider moving within 20 miles of the

[Ark Two Community](#)  
(in Canada)

9. And finally if you would like to be on the mailing list of the author of this site - send a blank email to:

[arktwo-request@deuce.pairowoodies.com](mailto:arktwo-request@deuce.pairowoodies.com)  
[with the subject as subscribe](#)

**MENU: [HOME](#) » [SURVIVAL](#) » [Index of States](#)**

---

---

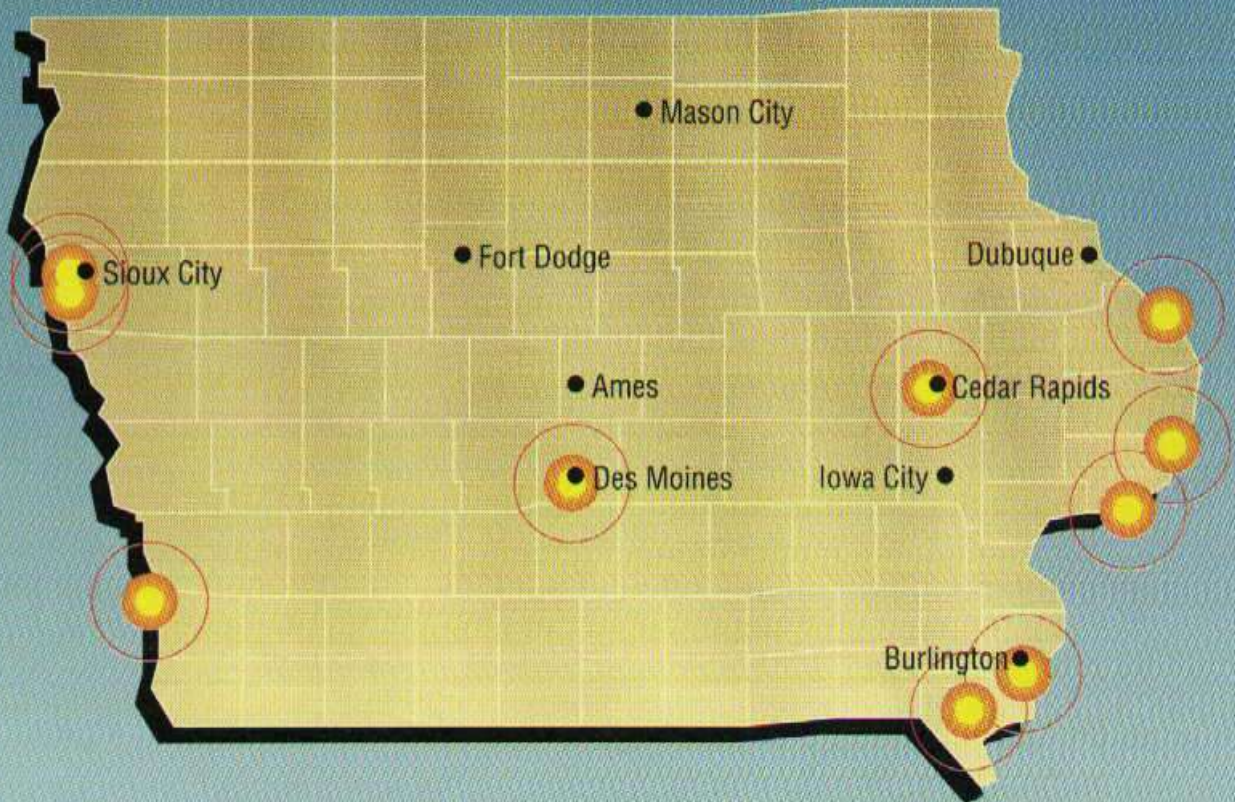
## Nuclear Survival in

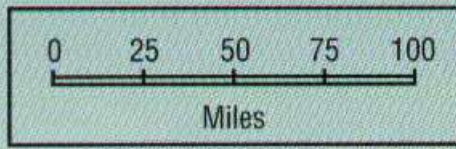
# Iowa

This is the nuclear target map for Iowa, but remember, fallout can go anywhere or everywhere (and probably will). After you have looked at this map look at the [Information for Iowa](#) that follows it.

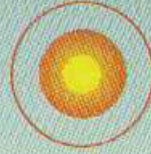
This link will take you back to the [Index of all the States](#)

## Nuclear Weapon Target Map for Iowa (FEMA-196/September 1990)





## Nuclear Attack



**Red Ring (0.5 to 2 psi):** Up to 25 percent casualties. Light damage to commercial-type buildings, severe damage to small residences.

**Orange Area (2 to 5 psi):** 50 percent casualties. Moderate damage to commercial-type buildings, severe damage to small residences.

**Yellow Area (5 psi or more):** Few survivors. Severe damage to total destruction of buildings.

## Fallout

Fallout radiation is a potential hazard for all localities. See page 123 for more information.

[UPDATE to Target Information!!!](#)

## Information for Iowa

This link will take you back to the [Index of all the States](#)

It is recommended that you go through the following 10 steps in studying about the nuclear threat to Iowa.

1. Look at the [State Map](#) above to see the target nuclear areas in Iowa.
2. Look at the [general expected fallout map](#) to see where Iowa (according to the **prevailing wind pattern**) gets fallout from other states.
3. If the state that you live in is anywhere EAST of any of the following 6 states in the **prevailing wind pattern** then look at the states in **RED** on the [INDEX of](#)



## STATES for

- Montana
- North Dakota
- South Dakota
- Nebraska
- Missouri
- Colorado

These six states contain what is called DENSE PACK which I explain on each of those states pages. **UNDERSTAND** that the wind pattern **COULD** at that time be something other than the "prevailing" wind pattern.

4. Bookmark the present URL or make a copy of this present address so that you can come back to it after going to

[Blast Mapper](#).

This mapper is on someone else's web site so that you will need to save this address in order to return here if your back button doesn't work. However, you want to be sure to go the mapper site and calculate the damage to probable targets (cities) around you.

5. Memorize the THREE top rules for survival. They are:

- Number One - **Get out of the cities!**
- Number Two - **Get out of the cities!**
- Number Three - **Get out of the cities!**

6. The follow-on rules are:

- a. Have a shelter
- b. Work with a group (you are going to need the manpower, brainpower, and skillpower).

- c. Stock supplies.

7. My [Main Survival Page](#) contains links to lots of other information such as free books to download about nuclear survival, links to plans for building shelters, and even free consultation about building a shelter.

8. If you are SUPER concerned about nuclear survival you might consider moving within 20 miles of the

[Ark Two Community](#)  
(in Canada)

9. And finally if you would like to be on the mailing list of the author of this site - send a blank email to:

[arktwo-request@deuce.pairowoodies.com](mailto:arktwo-request@deuce.pairowoodies.com)  
[with the subject as subscribe](#)

**MENU: [HOME](#) » [SURVIVAL](#) » [Index of States](#)**

---

---

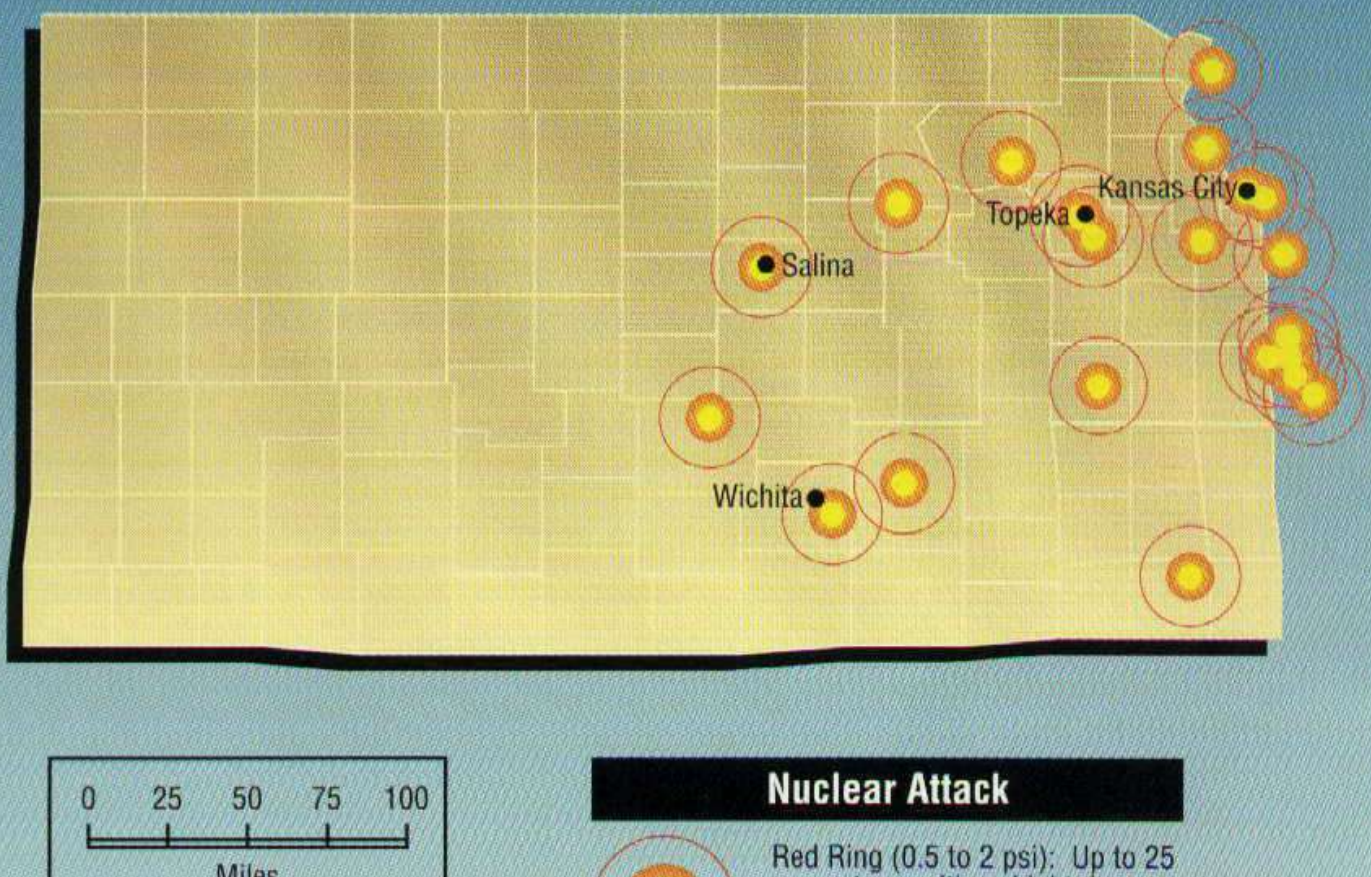
Nuclear Survival in

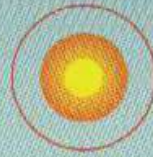
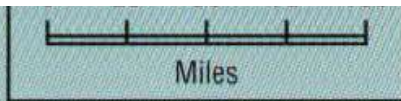
# Kansas

This is the nuclear target map for Kansas, but remember, fallout can go anywhere or everywhere (and probably will). After you have looked at this map look at the [Information for Kansas](#) that follows it.

This link will take you back to the [Index of all the States](#)

## Nuclear Weapon Target Map for Kansas (FEMA-196/September 1990)





**Red Ring (0.5 to 2 psi):** Up to 25 percent casualties. Light damage to commercial-type buildings, severe damage to small residences.

**Orange Area (2 to 5 psi):** 50 percent casualties. Moderate damage to commercial-type buildings, severe damage to small residences.

**Yellow Area (5 psi or more):** Few survivors. Severe damage to total destruction of buildings.

### Fallout

Fallout radiation is a potential hazard for all localities. See page 123 for more information.

## [UPDATE to Target Information!!!](#)

### Information for Kansas

This link will take you back to the [Index of all the States](#)

It is recommended that you go through the following 10 steps in studying about the nuclear threat to Kansas.

1. Look at the [State Map](#) above to see the target nuclear areas in Kansas.
2. Look at the [general expected fallout map](#) to see where Kansas (according to the **prevailing wind pattern**) gets fallout from other states.
3. If the state that you live in is anywhere EAST of any of the following 6 states in the **prevailing wind pattern** then look at the states in **RED** on the [INDEX of](#)

## STATES for

- Montana
- North Dakota
- South Dakota
- Nebraska
- Missouri
- Colorado

These six states contain what is called DENSE PACK which I explain on each of those states pages. **UNDERSTAND** that the wind pattern **COULD** at that time be something other than the "prevailing" wind pattern.

4. Bookmark the present URL or make a copy of this present address so that you can come back to it after going to

[Blast Mapper.](#)

This mapper is on someone else's web site so that you will need to save this address in order to return here if your back button doesn't work. However, you want to be sure to go the mapper site and calculate the damage to probable targets (cities) around you.

5. Memorize the THREE top rules for survival. They are:

- Number One - **Get out of the cities!**
- Number Two - **Get out of the cities!**
- Number Three - **Get out of the cities!**

6. The follow-on rules are:

- a. Have a shelter
- b. Work with a group (you are going to need the manpower, brainpower, and skillpower).

- c. Stock supplies.

7. My [Main Survival Page](#) contains links to lots of other information such as free books to download about nuclear survival, links to plans for building shelters, and even free consultation about building a shelter.

8. If you are SUPER concerned about nuclear survival you might consider moving within 20 miles of the

[Ark Two Community](#)  
(in Canada)

9. And finally if you would like to be on the mailing list of the author of this site - send a blank email to:

[arktwo-request@deuce.pairowoodies.com](mailto:arktwo-request@deuce.pairowoodies.com)  
[with the subject as subscribe](#)

**MENU: [HOME](#) » [SURVIVAL](#) » [Index of States](#)**

---

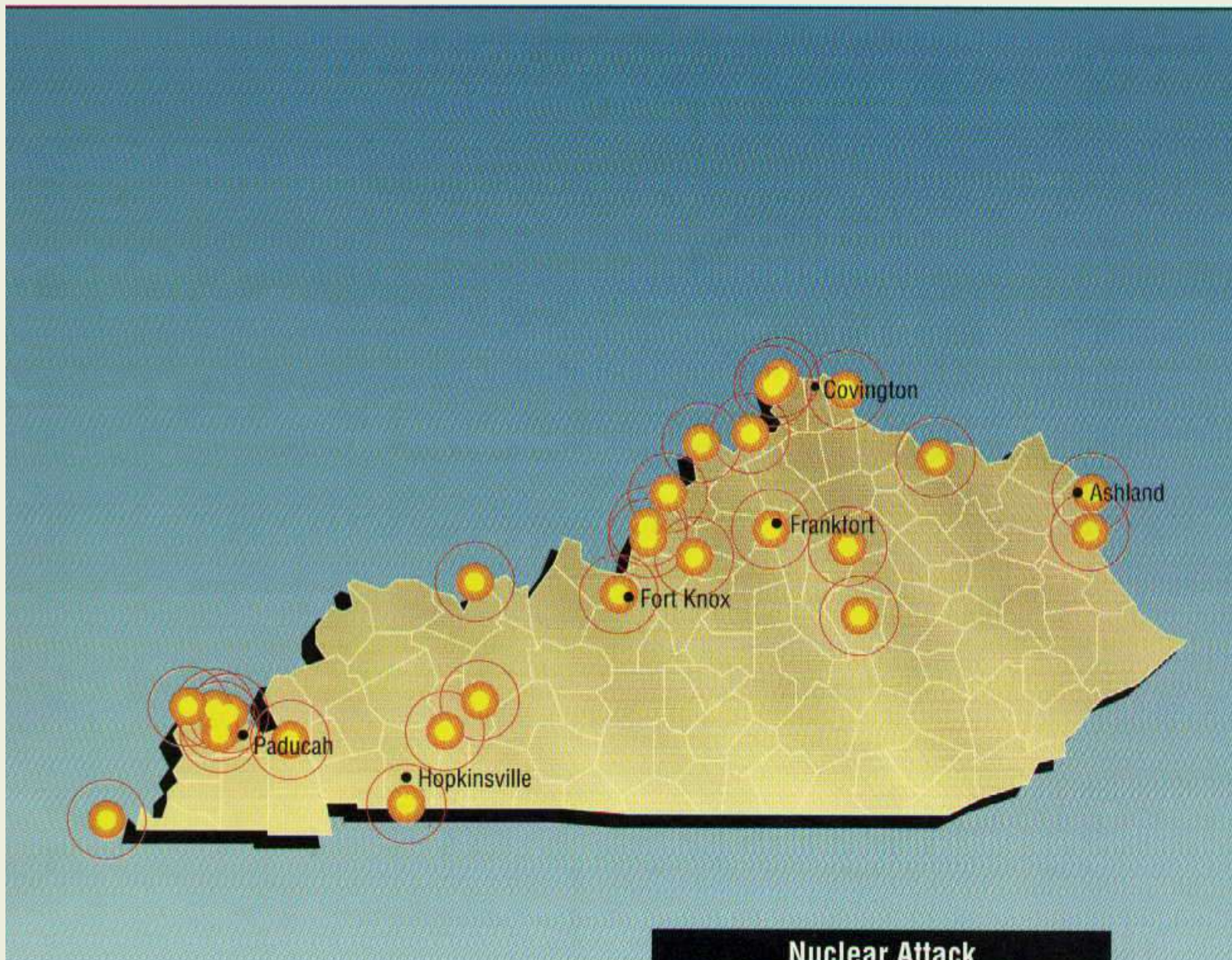
---

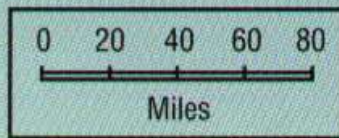
## Nuclear Survival in **Kentucky**

This is the nuclear target map for Kentucky, but remember, fallout can go anywhere or everywhere (and probably will). After you have looked at this map look at the [Information for Kentucky](#) that follows it.

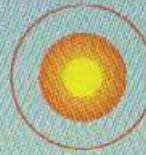
This link will take you back to the [Index of all the States](#)

### **Nuclear Weapon Target Map for Kentucky (FEMA-196/September 1990)**





## Nuclear Attack



**Red Ring (0.5 to 2 psi):** Up to 25 percent casualties. Light damage to commercial-type buildings, severe damage to small residences.

**Orange Area (2 to 5 psi):** 50 percent casualties. Moderate damage to commercial-type buildings, severe damage to small residences.

**Yellow Area (5 psi or more):** Few survivors. Severe damage to total destruction of buildings.

## Fallout

Fallout radiation is a potential hazard for all localities. See page 123 for more information.

## [UPDATE to Target Information!!!](#)

### Information for Kentucky

This link will take you back to the [Index of all the States](#)

It is recommended that you go through the following 10 steps in studying about the nuclear threat to Kentucky.

1. Look at the [State Map](#) above to see the target nuclear areas in Kentucky.
2. Look at the [general expected fallout map](#) to see where Kentucky (according to the **prevailing wind pattern**) gets fallout from other states.
3. If the state that you live in is anywhere EAST of any of the following 6 states in the **prevailing wind pattern** then look at the states in **RED** on the [INDEX of](#)



## STATES for

- Montana
- North Dakota
- South Dakota
- Nebraska
- Missouri
- Colorado

These six states contain what is called DENSE PACK which I explain on each of those states pages. **UNDERSTAND** that the wind pattern **COULD** at that time be something other than the "prevailing" wind pattern.

4. Bookmark the present URL or make a copy of this present address so that you can come back to it after going to

[Blast Mapper](#).

This mapper is on someone else's web site so that you will need to save this address in order to return here if your back button doesn't work. However, you want to be sure to go the mapper site and calculate the damage to probable targets (cities) around you.

5. Memorize the THREE top rules for survival. They are:

- Number One - **Get out of the cities!**
- Number Two - **Get out of the cities!**
- Number Three - **Get out of the cities!**

6. The follow-on rules are:

- a. Have a shelter
- b. Work with a group (you are going to need the manpower, brainpower, and skillpower).

- c. Stock supplies.

7. My [Main Survival Page](#) contains links to lots of other information such as free books to download about nuclear survival, links to plans for building shelters, and even free consultation about building a shelter.

8. If you are SUPER concerned about nuclear survival you might consider moving within 20 miles of the

[Ark Two Community](#)  
(in Canada)

9. And finally if you would like to be on the mailing list of the author of this site - send a blank email to:

[arktwo-request@deuce.pairowoodies.com](mailto:arktwo-request@deuce.pairowoodies.com)  
[with the subject as subscribe](#)

**MENU: [HOME](#) » [SURVIVAL](#) » [Index of States](#)**

---

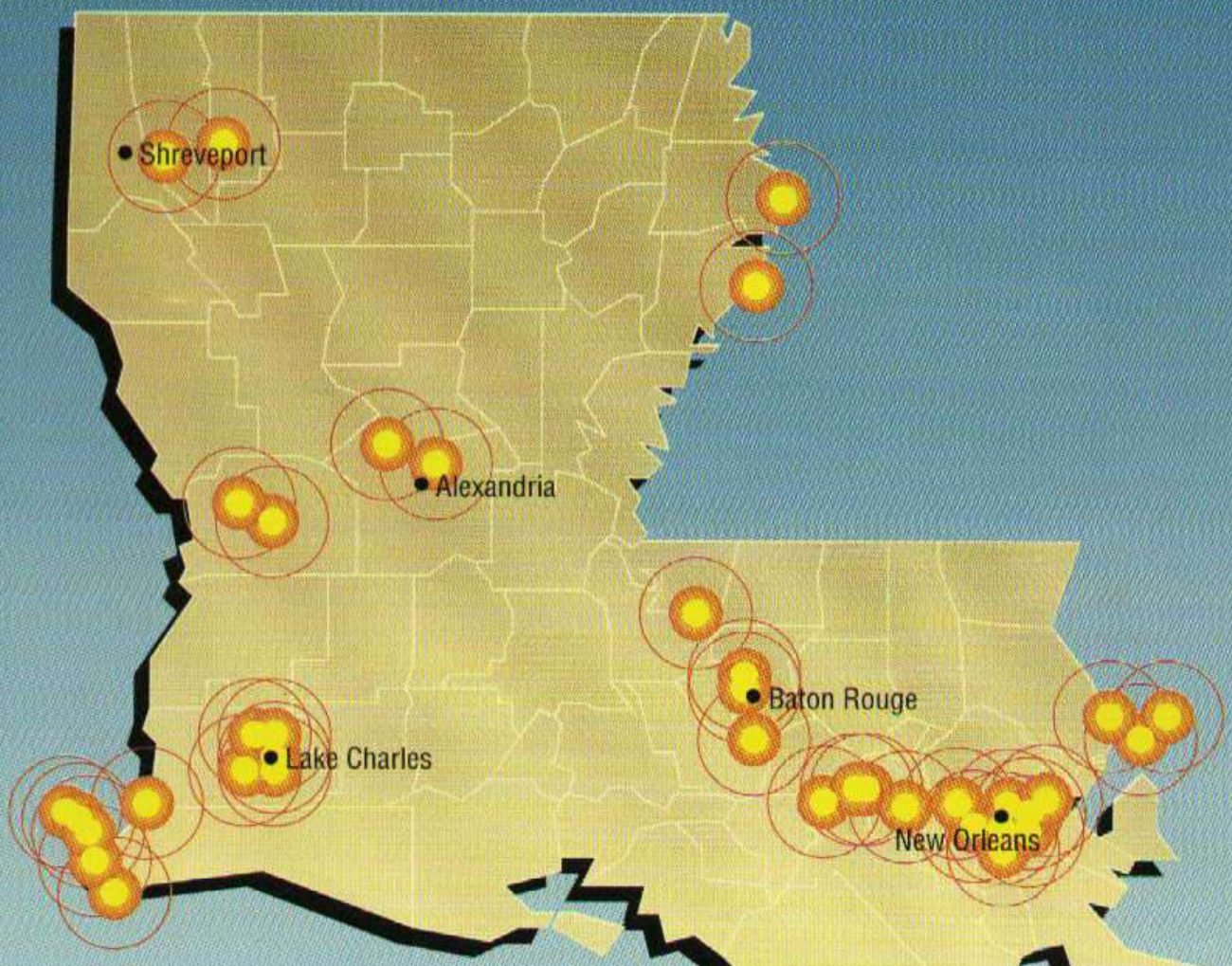
---

## Nuclear Survival in **Louisiana**

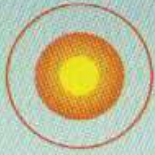
This is the nuclear target map for Louisiana, but remember, fallout can go anywhere or everywhere (and probably will). After you have looked at this map look at the [Information for Louisiana](#) that follows it.

This link will take you back to the [Index of all the States](#)

### **Nuclear Weapon Target Map for Louisiana (FEMA-196/September 1990)**



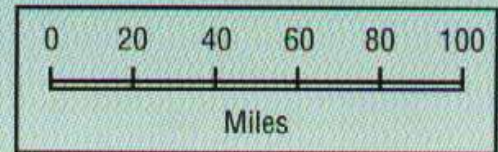
## Nuclear Attack



**Red Ring (0.5 to 2 psi):** Up to 25 percent casualties. Light damage to commercial-type buildings, severe damage to small residences.

**Orange Area (2 to 5 psi):** 50 percent casualties. Moderate damage to commercial-type buildings, severe damage to small residences.

**Yellow Area (5 psi or more):** Few survivors. Severe damage to total destruction of buildings.



## Fallout

Fallout radiation is a potential hazard for all localities. See page 123 for more information.

[UPDATE to Target Information!!!](#)

## Information for Louisiana

This link will take you back to the [Index of all the States](#)

It is recommended that you go through the following 10 steps in studying about the nuclear threat to Louisiana.

1. Look at the [State Map](#) above to see the target nuclear areas in Louisiana.
2. Look at the [general expected fallout map](#) to see where Louisiana (according to the **prevailing wind pattern**) gets fallout from other states.
3. If the state that you live in is anywhere EAST of any of the following 6 states in the **prevailing wind pattern** then look at the states in **RED** on the [INDEX of](#)

## STATES for

- Montana
- North Dakota
- South Dakota
- Nebraska
- Missouri
- Colorado

These six states contain what is called DENSE PACK which I explain on each of those states pages. **UNDERSTAND** that the wind pattern **COULD** at that time be something other than the "prevailing" wind pattern.

4. Bookmark the present URL or make a copy of this present address so that you can come back to it after going to

[Blast Mapper](#).

This mapper is on someone else's web site so that you will need to save this address in order to return here if your back button doesn't work. However, you want to be sure to go the mapper site and calculate the damage to probable targets (cities) around you.

5. Memorize the THREE top rules for survival. They are:

- Number One - **Get out of the cities!**
- Number Two - **Get out of the cities!**
- Number Three - **Get out of the cities!**

6. The follow-on rules are:

- a. Have a shelter
- b. Work with a group (you are going to need the manpower, brainpower, and skillpower).

- c. Stock supplies.

7. My [Main Survival Page](#) contains links to lots of other information such as free books to download about nuclear survival, links to plans for building shelters, and even free consultation about building a shelter.

8. If you are SUPER concerned about nuclear survival you might consider moving within 20 miles of the

[Ark Two Community](#)  
(in Canada)

9. And finally if you would like to be on the mailing list of the author of this site - send a blank email to:

[arktwo-request@deuce.pairowoodies.com](mailto:arktwo-request@deuce.pairowoodies.com)  
[with the subject as subscribe](#)

**MENU: [HOME](#) » [SURVIVAL](#) » [Index of States](#)**

---

---

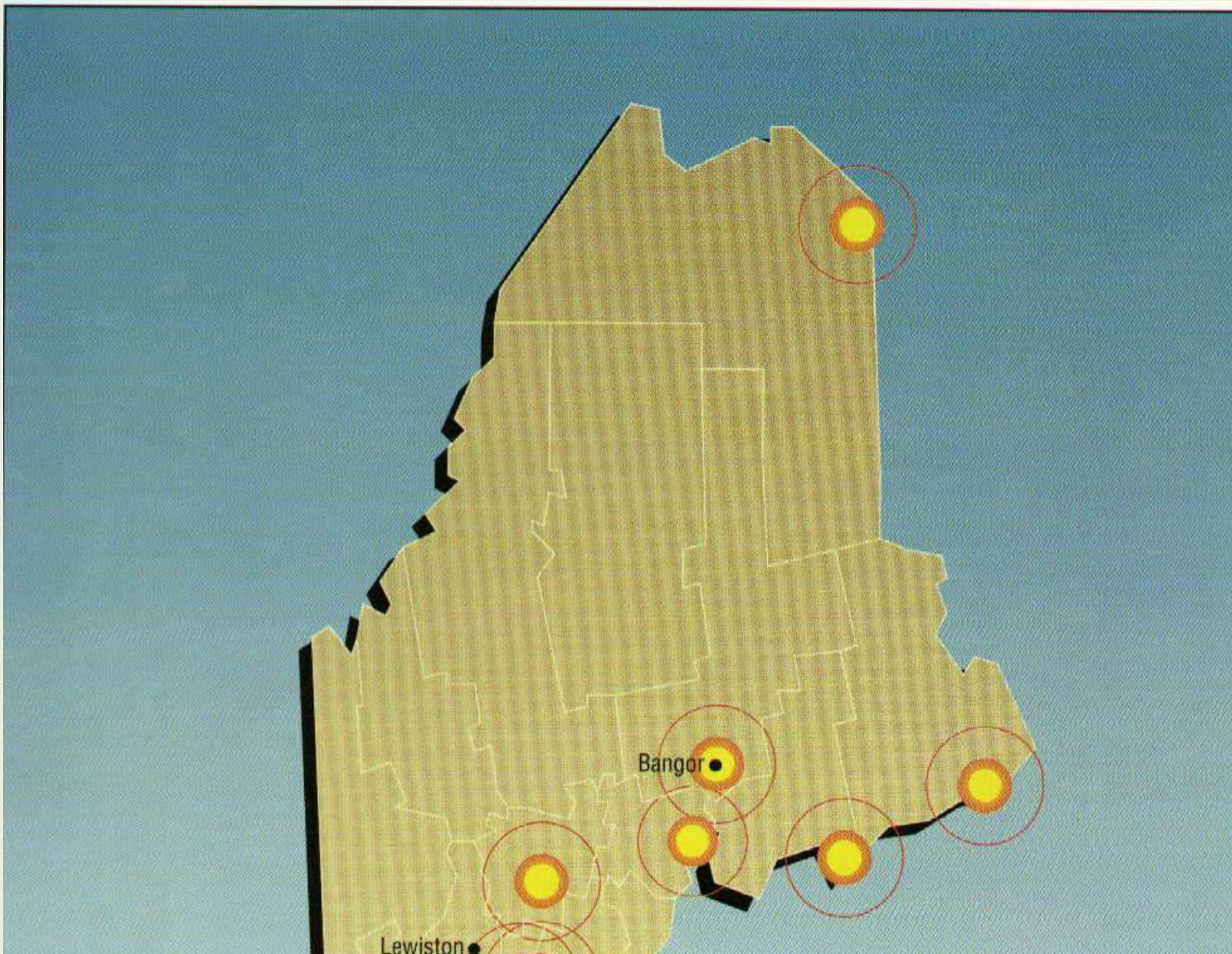
Nuclear Survival in

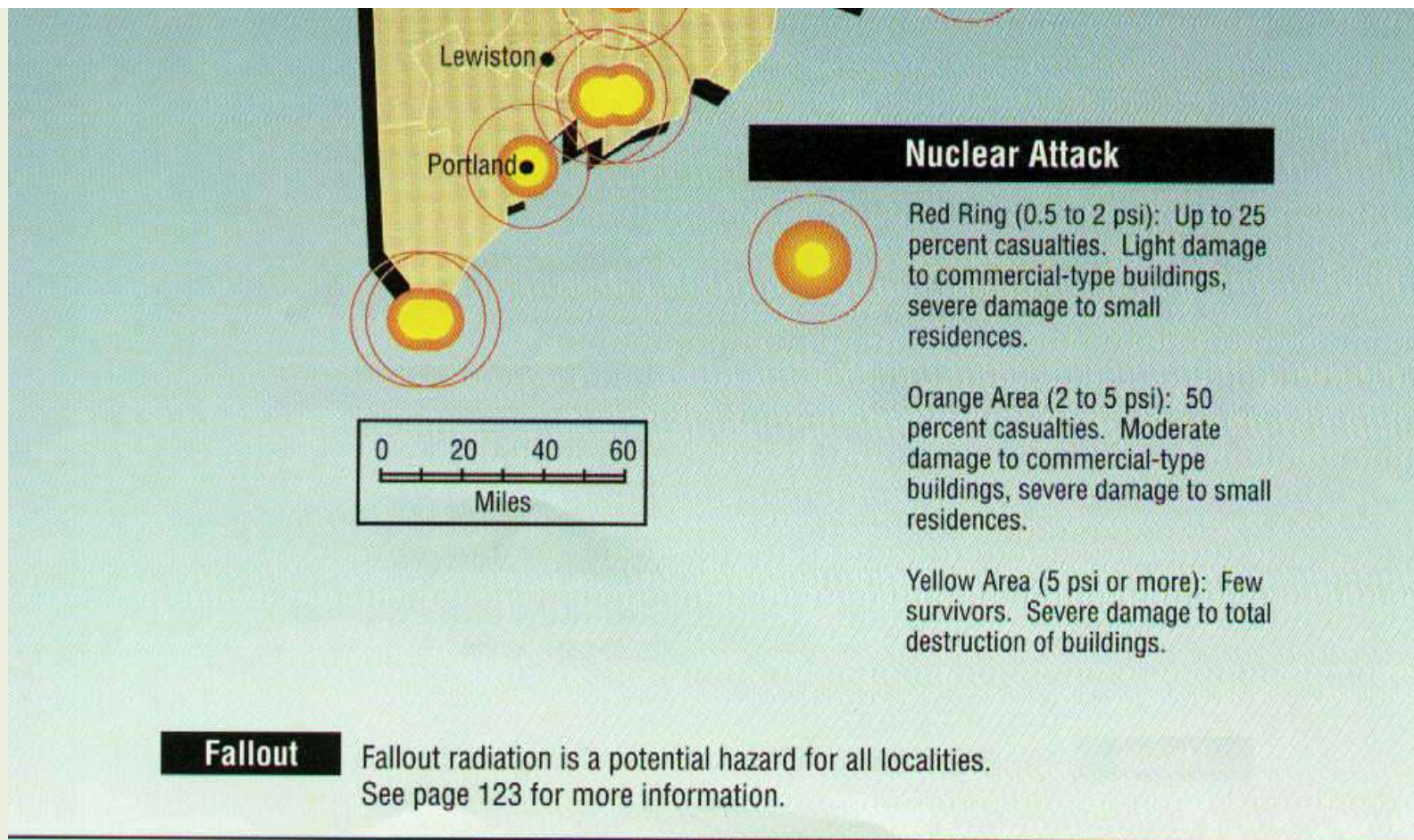
# Maine

This is the nuclear target map for Maine, but remember, fallout can go anywhere or everywhere (and probably will). After you have looked at this map look at the [Information for Maine](#) that follows it.

This link will take you back to the [Index of all the States](#)

## Nuclear Weapon Target Map for Maine (FEMA-196/September 1990)





[UPDATE to Target Information!!!](#)

## Information for Maine

This link will take you back to the [Index of all the States](#)

It is recommended that you go through the following 10 steps in studying about the nuclear threat to Maine.

1. Look at the [State Map](#) above to see the target nuclear areas in Maine.
2. Look at the [general expected fallout map](#) to see where Maine (according to the **prevailing wind pattern**) gets fallout from other states.
3. If the state that you live in is anywhere EAST of any of the following 6 states in the **prevailing wind pattern** then look at the states in **RED** on the [INDEX of](#)



## STATES for

- Montana
- North Dakota
- South Dakota
- Nebraska
- Missouri
- Colorado

These six states contain what is called DENSE PACK which I explain on each of those states pages. **UNDERSTAND** that the wind pattern **COULD** at that time be something other than the "prevailing" wind pattern.

4. Bookmark the present URL or make a copy of this present address so that you can come back to it after going to

[Blast Mapper](#).

This mapper is on someone else's web site so that you will need to save this address in order to return here if your back button doesn't work. However, you want to be sure to go the mapper site and calculate the damage to probable targets (cities) around you.

5. Memorize the THREE top rules for survival. They are:

- Number One - **Get out of the cities!**
- Number Two - **Get out of the cities!**
- Number Three - **Get out of the cities!**

6. The follow-on rules are:

- a. Have a shelter
- b. Work with a group (you are going to need the manpower, brainpower, and skillpower).

- c. Stock supplies.

7. My [Main Survival Page](#) contains links to lots of other information such as free books to download about nuclear survival, links to plans for building shelters, and even free consultation about building a shelter.

8. If you are SUPER concerned about nuclear survival you might consider moving within 20 miles of the

[Ark Two Community](#)  
(in Canada)

9. And finally if you would like to be on the mailing list of the author of this site - send a blank email to:

[arktwo-request@deuce.pairowoodies.com](mailto:arktwo-request@deuce.pairowoodies.com)  
[with the subject as subscribe](#)

**MENU: [HOME](#) » [SURVIVAL](#) » [Index of States](#)**

---

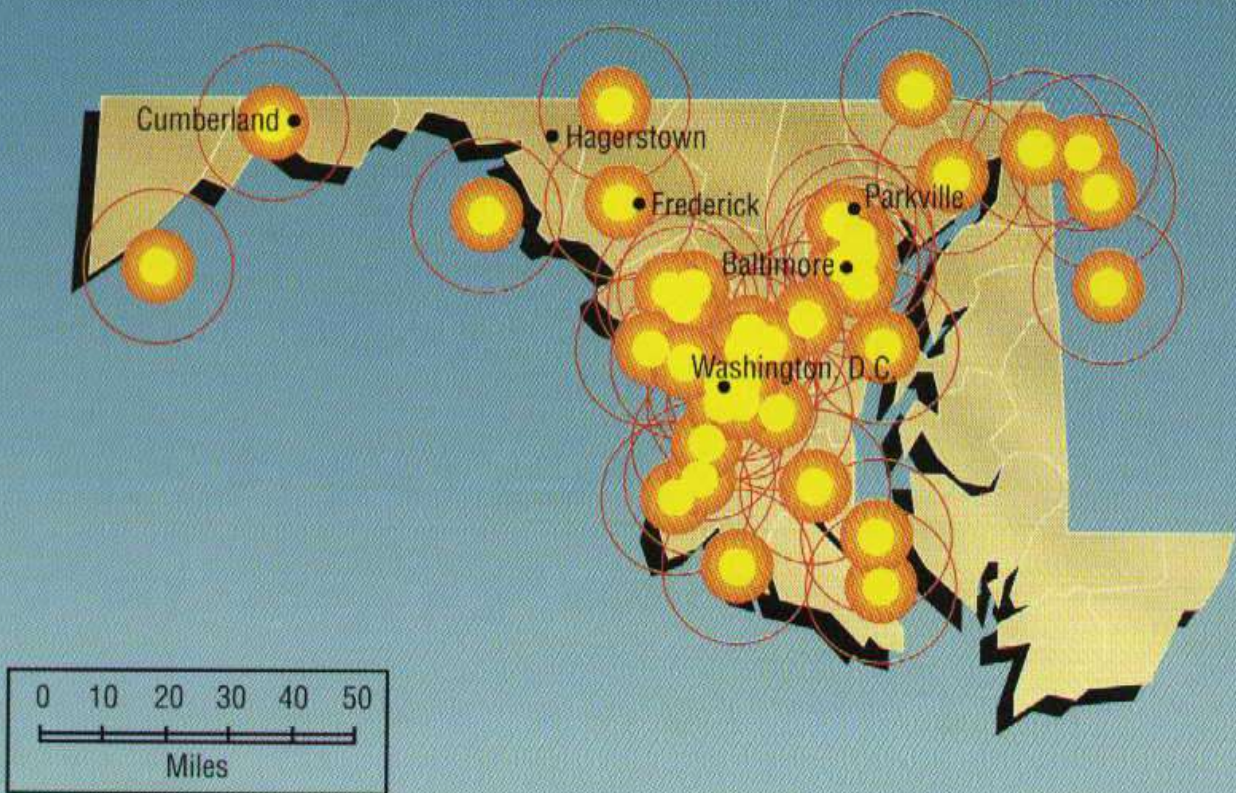
---

## Nuclear Survival in **Maryland**

This is the nuclear target map for Maryland, but remember, fallout can go anywhere or everywhere (and probably will). After you have looked at this map look at the [Information for Maryland](#) that follows it.

This link will take you back to the [Index of all the States](#)

### **Nuclear Weapon Target Map for Maryland (FEMA-196/September 1990)**



**Nuclear Attack**

## Nuclear Attack



Red Ring (0.5 to 2 psi): Up to 25 percent casualties. Light damage to commercial-type buildings, severe damage to small residences.

Orange Area (2 to 5 psi): 50 percent casualties. Moderate damage to commercial-type buildings, severe damage to small residences.

Yellow Area (5 psi or more): Few survivors. Severe damage to total destruction of buildings.

## Fallout

Fallout radiation is a potential hazard for all localities. See page 123 for more information.

## [UPDATE to Target Information!!!](#)

## Information for Maryland

This link will take you back to the [Index of all the States](#)

It is recommended that you go through the following 10 steps in studying about the nuclear threat to Maryland.

1. Look at the [State Map](#) above to see the target nuclear areas in Maryland.
2. Look at the [general expected fallout map](#) to see where Maryland (according to the **prevailing wind pattern**) gets fallout from other states.
3. If the state that you live in is anywhere EAST of any of the following 6 states in the **prevailing wind pattern** then look at the states in **RED** on the [INDEX of](#)

## STATES for

- Montana
- North Dakota
- South Dakota
- Nebraska
- Missouri
- Colorado

These six states contain what is called DENSE PACK which I explain on each of those states pages. **UNDERSTAND** that the wind pattern **COULD** at that time be something other than the "prevailing" wind pattern.

4. Bookmark the present URL or make a copy of this present address so that you can come back to it after going to

[Blast Mapper](#).

This mapper is on someone else's web site so that you will need to save this address in order to return here if your back button doesn't work. However, you want to be sure to go the mapper site and calculate the damage to probable targets (cities) around you.

5. Memorize the THREE top rules for survival. They are:

- Number One - **Get out of the cities!**
- Number Two - **Get out of the cities!**
- Number Three - **Get out of the cities!**

6. The follow-on rules are:

- a. Have a shelter
- b. Work with a group (you are going to need the manpower, brainpower, and skillpower).

- c. Stock supplies.

7. My [Main Survival Page](#) contains links to lots of other information such as free books to download about nuclear survival, links to plans for building shelters, and even free consultation about building a shelter.

8. If you are SUPER concerned about nuclear survival you might consider moving within 20 miles of the

[Ark Two Community](#)  
(in Canada)

9. And finally if you would like to be on the mailing list of the author of this site - send a blank email to:

[arktwo-request@deuce.pairowoodies.com](mailto:arktwo-request@deuce.pairowoodies.com)  
[with the subject as subscribe](#)

**MENU: [HOME](#) » [SURVIVAL](#) » [Index of States](#)**

---

---

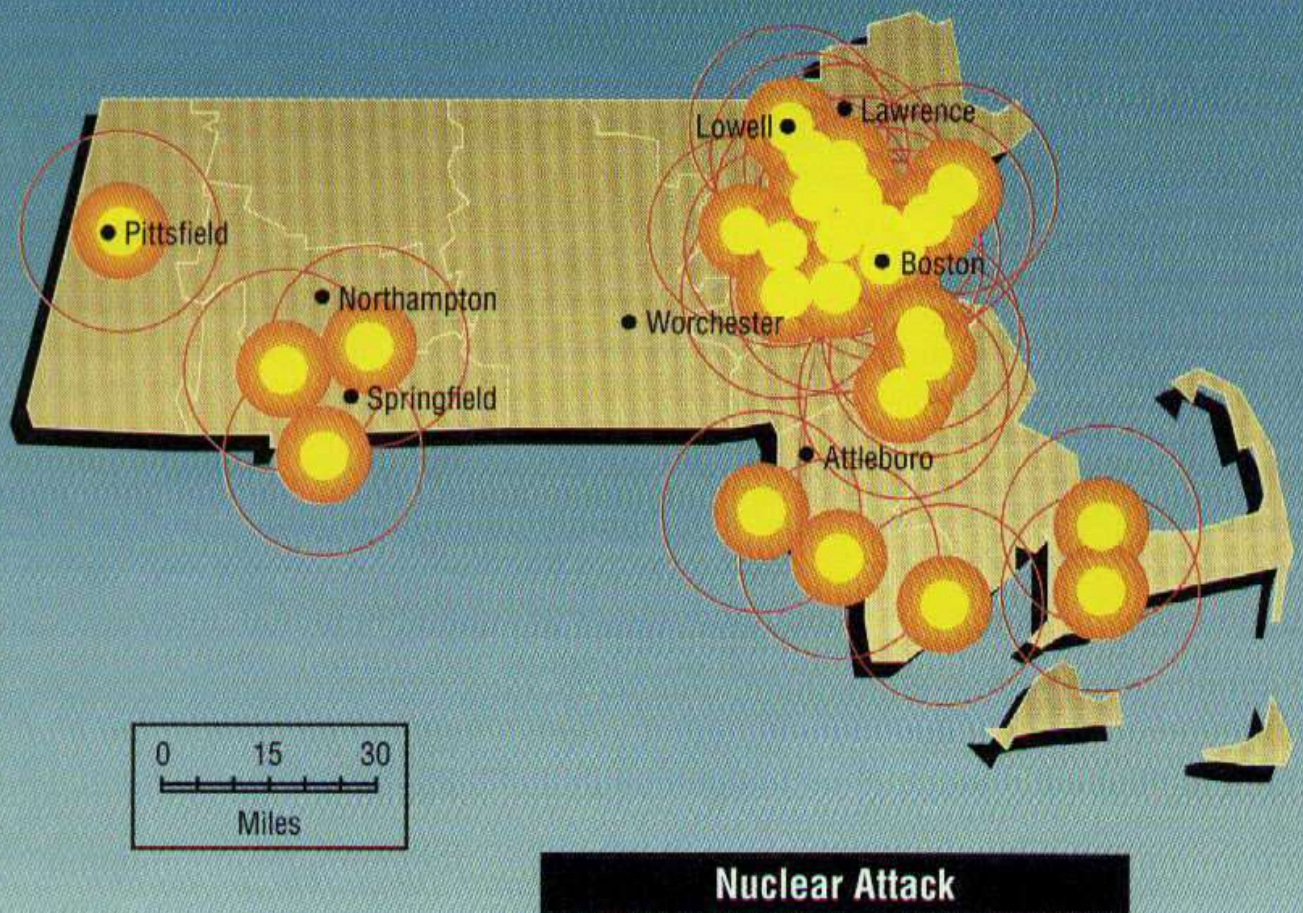
Nuclear Survival in

# Massachusetts

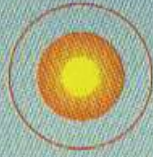
This is the nuclear target map for Massachusetts, but remember, fallout can go anywhere or everywhere (and probably will). After you have looked at this map look at the [Information for Massachusetts](#) that follows it.

This link will take you back to the [Index of all the States](#)

## Nuclear Weapon Target Map for Massachusetts (FEMA-196/September 1990)



## Nuclear Attack



**Red Ring (0.5 to 2 psi):** Up to 25 percent casualties. Light damage to commercial-type buildings, severe damage to small residences.

**Orange Area (2 to 5 psi):** 50 percent casualties. Moderate damage to commercial-type buildings, severe damage to small residences.

**Yellow Area (5 psi or more):** Few survivors. Severe damage to total destruction of buildings.

### Fallout

Fallout radiation is a potential hazard for all localities. See page 123 for more information.

## [UPDATE to Target Information!!!](#)

### Information for Massachusetts

This link will take you back to the [Index of all the States](#)

It is recommended that you go through the following 10 steps in studying about the nuclear threat to Massachusetts.

1. Look at the [State Map](#) above to see the target nuclear areas in Massachusetts.
2. Look at the [general expected fallout map](#) to see where Massachusetts (according to the **prevailing wind pattern**) gets fallout from other states.
3. If the state that you live in is anywhere EAST of any of the following 6 states in the **prevailing wind pattern** then look at the states in **RED** on the [INDEX of](#)



## STATES for

- Montana
- North Dakota
- South Dakota
- Nebraska
- Missouri
- Colorado

These six states contain what is called DENSE PACK which I explain on each of those states pages. **UNDERSTAND** that the wind pattern **COULD** at that time be something other than the "prevailing" wind pattern.

4. Bookmark the present URL or make a copy of this present address so that you can come back to it after going to

[Blast Mapper.](#)

This mapper is on someone else's web site so that you will need to save this address in order to return here if your back button doesn't work. However, you want to be sure to go the mapper site and calculate the damage to probable targets (cities) around you.

5. Memorize the THREE top rules for survival. They are:

- Number One - **Get out of the cities!**
- Number Two - **Get out of the cities!**
- Number Three - **Get out of the cities!**

6. The follow-on rules are:

- a. Have a shelter
- b. Work with a group (you are going to need the manpower, brainpower, and skillpower).

- c. Stock supplies.

7. My [Main Survival Page](#) contains links to lots of other information such as free books to download about nuclear survival, links to plans for building shelters, and even free consultation about building a shelter.

8. If you are SUPER concerned about nuclear survival you might consider moving within 20 miles of the

[Ark Two Community](#)  
(in Canada)

9. And finally if you would like to be on the mailing list of the author of this site - send a blank email to:

[arktwo-request@deuce.pairowoodies.com](mailto:arktwo-request@deuce.pairowoodies.com)  
[with the subject as subscribe](#)

**MENU: [HOME](#) » [SURVIVAL](#) » [Index of States](#)**

---

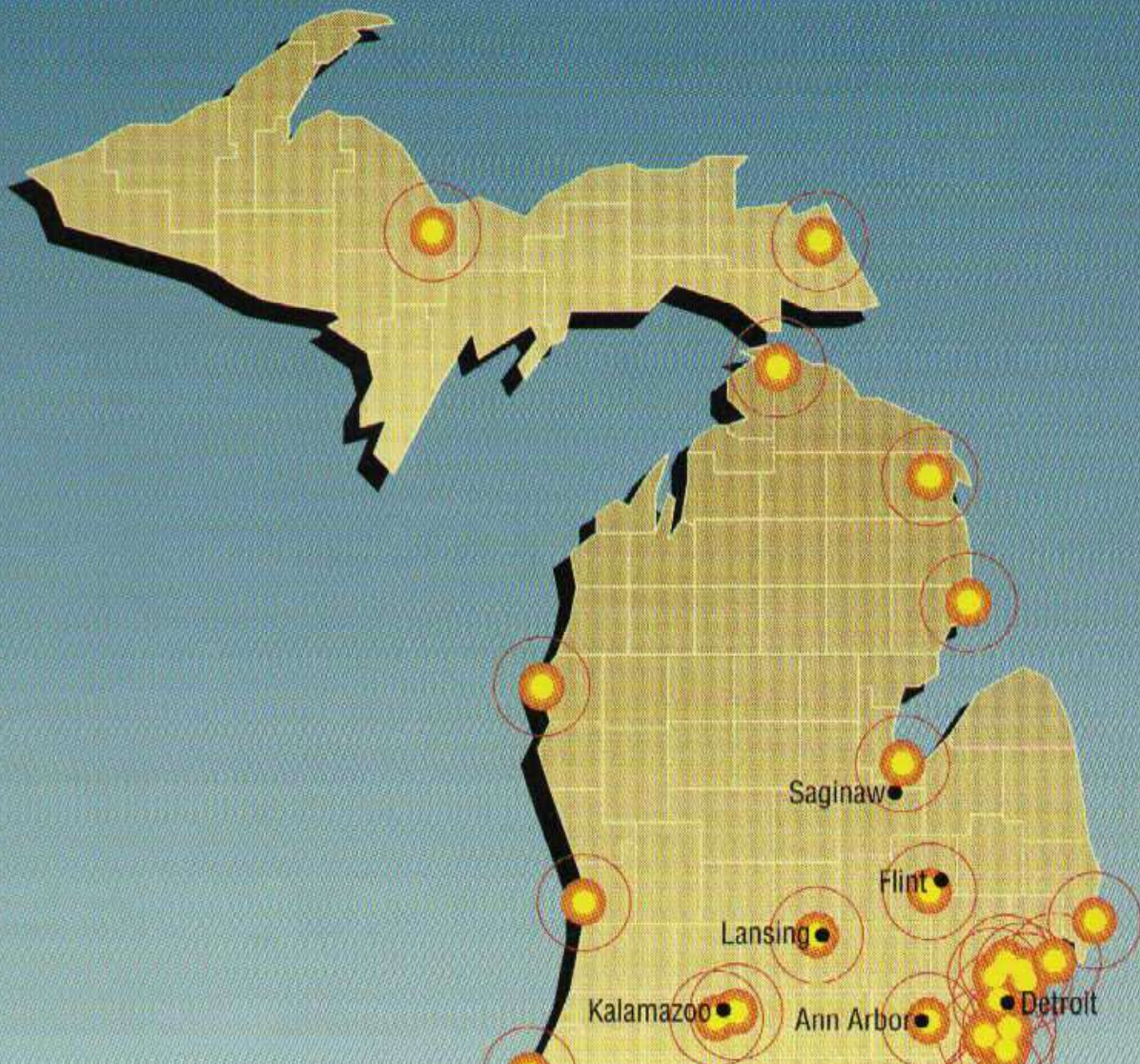
---

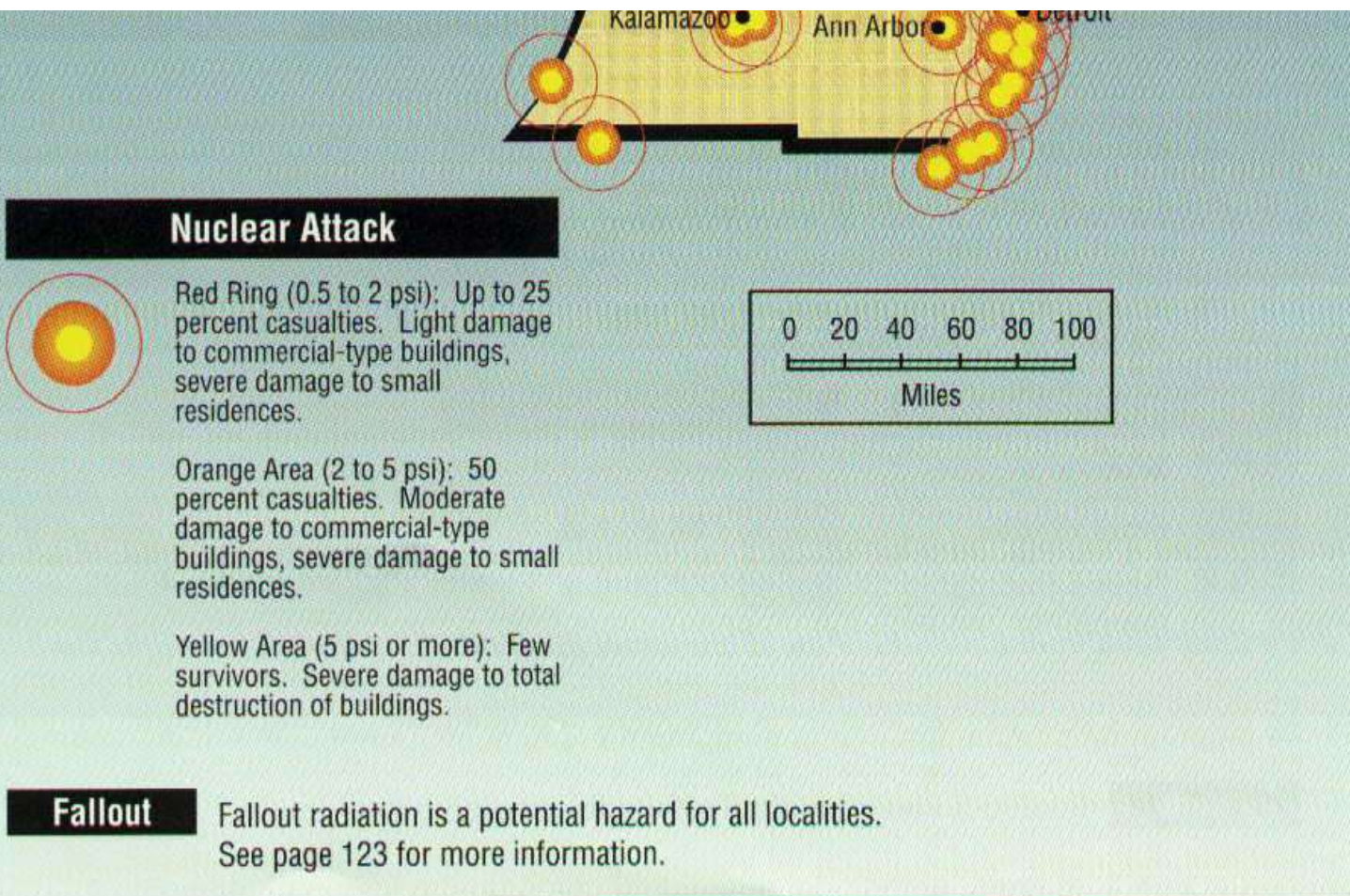
## Nuclear Survival in **Michigan**

This is the nuclear target map for Michigan, but remember, fallout can go anywhere or everywhere (and probably will). After you have looked at this map look at the [Information for Michigan](#) that follows it.

This link will take you back to the [Index of all the States](#)

### **Nuclear Weapon Target Map for Michigan (FEMA-196/September 1990)**





[UPDATE to Target Information!!!](#)

## Information for Michigan

This link will take you back to the [Index of all the States](#)

It is recommended that you go through the following 10 steps in studying about the nuclear threat to Michigan.

1. Look at the [State Map](#) above to see the target nuclear areas in Michigan.
2. Look at the [general expected fallout map](#) to see where Michigan (according to the **prevailing wind pattern**) gets fallout from other states.
3. If the state that you live in is anywhere EAST of any of the following 6 states in the **prevailing wind pattern** then look at the states in **RED** on the [INDEX of](#)

## STATES for

- Montana
- North Dakota
- South Dakota
- Nebraska
- Missouri
- Colorado

These six states contain what is called DENSE PACK which I explain on each of those states pages. **UNDERSTAND** that the wind pattern **COULD** at that time be something other than the "prevailing" wind pattern.

4. Bookmark the present URL or make a copy of this present address so that you can come back to it after going to

[Blast Mapper](#).

This mapper is on someone else's web site so that you will need to save this address in order to return here if your back button doesn't work. However, you want to be sure to go the mapper site and calculate the damage to probable targets (cities) around you.

5. Memorize the THREE top rules for survival. They are:

- Number One - **Get out of the cities!**
- Number Two - **Get out of the cities!**
- Number Three - **Get out of the cities!**

6. The follow-on rules are:

- a. Have a shelter
- b. Work with a group (you are going to need the manpower, brainpower, and skillpower).

- c. Stock supplies.

7. My [Main Survival Page](#) contains links to lots of other information such as free books to download about nuclear survival, links to plans for building shelters, and even free consultation about building a shelter.

8. If you are SUPER concerned about nuclear survival you might consider moving within 20 miles of the

[Ark Two Community](#)  
(in Canada)

9. And finally if you would like to be on the mailing list of the author of this site - send a blank email to:

[arktwo-request@deuce.pairowoodies.com](mailto:arktwo-request@deuce.pairowoodies.com)  
[with the subject as subscribe](#)

**MENU: [HOME](#) » [SURVIVAL](#) » [Index of States](#)**

---

---

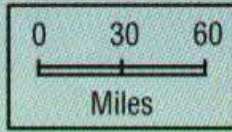
## Nuclear Survival in **Minnesota**

This is the nuclear target map for Minnesota, but remember, fallout can go anywhere or everywhere (and probably will). After you have looked at this map look at the [Information for Minnesota](#) that follows it.

This link will take you back to the [Index of all the States](#)

### **Nuclear Weapon Target Map for Minnesota (FEMA-196/September 1990)**





## Nuclear Attack



**Red Ring (0.5 to 2 psi):** Up to 25 percent casualties. Light damage to commercial-type buildings, severe damage to small residences.

**Orange Area (2 to 5 psi):** 50 percent casualties. Moderate damage to commercial-type buildings, severe damage to small residences.

**Yellow Area (5 psi or more):** Few survivors. Severe damage to total destruction of buildings.

## Fallout

Fallout radiation is a potential hazard for all localities. See page 123 for more information.

[UPDATE to Target Information!!!](#)

## Information for Minnesota

This link will take you back to the [Index of all the States](#)

It is recommended that you go through the following 10 steps in studying about the nuclear threat to Minnesota.

1. Look at the [State Map](#) above to see the target nuclear areas in Minnesota.
2. Look at the [general expected fallout map](#) to see where Minnesota (according to the **prevailing wind pattern**) gets fallout from other states.
3. If the state that you live in is anywhere EAST of any of the following 6 states in the **prevailing wind pattern** then look at the states in **RED** on the [INDEX of](#)



## STATES for

- Montana
- North Dakota
- South Dakota
- Nebraska
- Missouri
- Colorado

These six states contain what is called DENSE PACK which I explain on each of those states pages. **UNDERSTAND** that the wind pattern **COULD** at that time be something other than the "prevailing" wind pattern.

4. Bookmark the present URL or make a copy of this present address so that you can come back to it after going to

[Blast Mapper](#).

This mapper is on someone else's web site so that you will need to save this address in order to return here if your back button doesn't work. However, you want to be sure to go the mapper site and calculate the damage to probable targets (cities) around you.

5. Memorize the THREE top rules for survival. They are:

- Number One - **Get out of the cities!**
- Number Two - **Get out of the cities!**
- Number Three - **Get out of the cities!**

6. The follow-on rules are:

- a. Have a shelter
- b. Work with a group (you are going to need the manpower, brainpower, and skillpower).

- c. Stock supplies.

7. My [Main Survival Page](#) contains links to lots of other information such as free books to download about nuclear survival, links to plans for building shelters, and even free consultation about building a shelter.

8. If you are SUPER concerned about nuclear survival you might consider moving within 20 miles of the

[Ark Two Community](#)  
(in Canada)

9. And finally if you would like to be on the mailing list of the author of this site - send a blank email to:

[arktwo-request@deuce.pairowoodies.com](mailto:arktwo-request@deuce.pairowoodies.com)  
[with the subject as subscribe](#)

**MENU: [HOME](#) » [SURVIVAL](#) » [Index of States](#)**

---

---

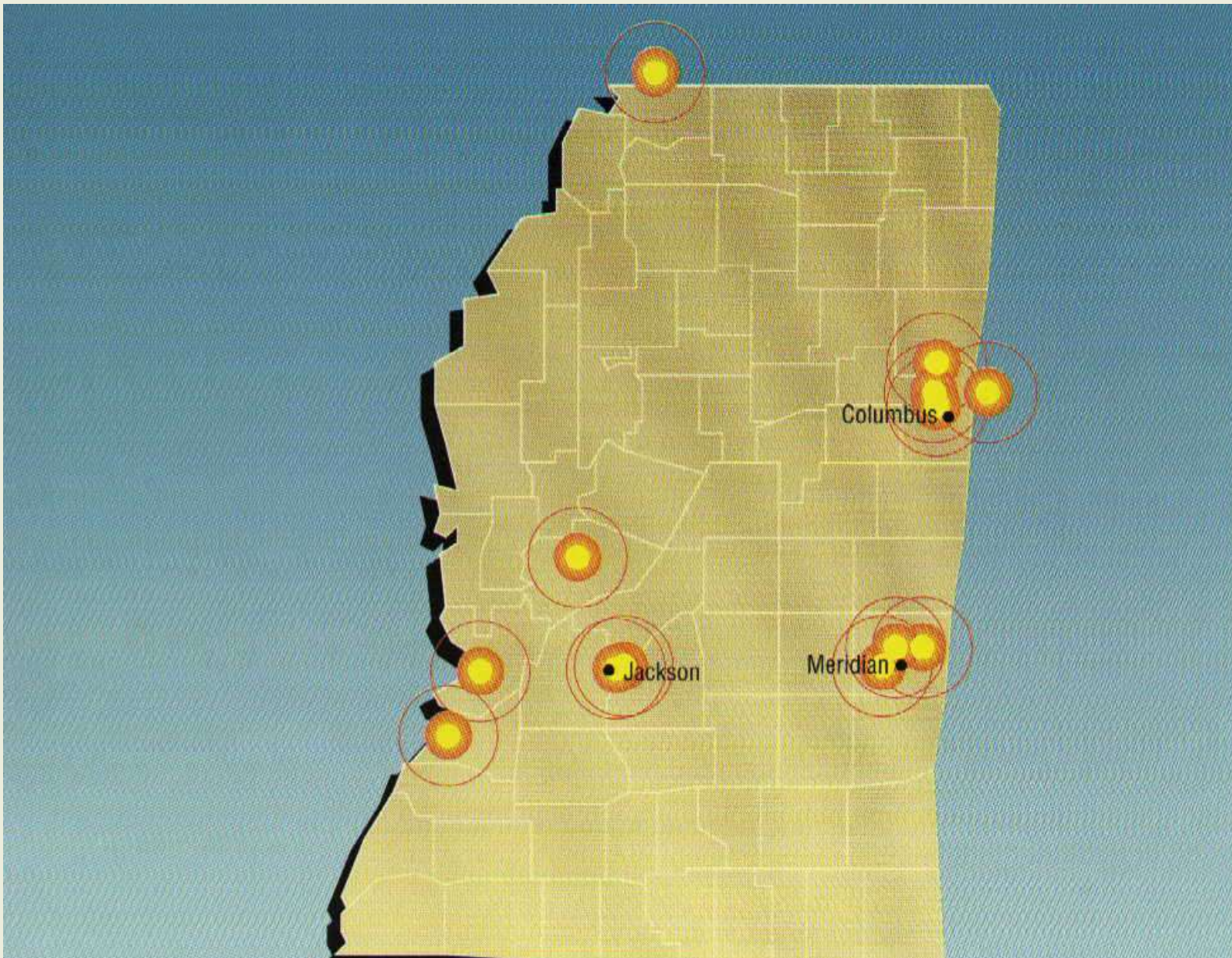
Nuclear Survival in

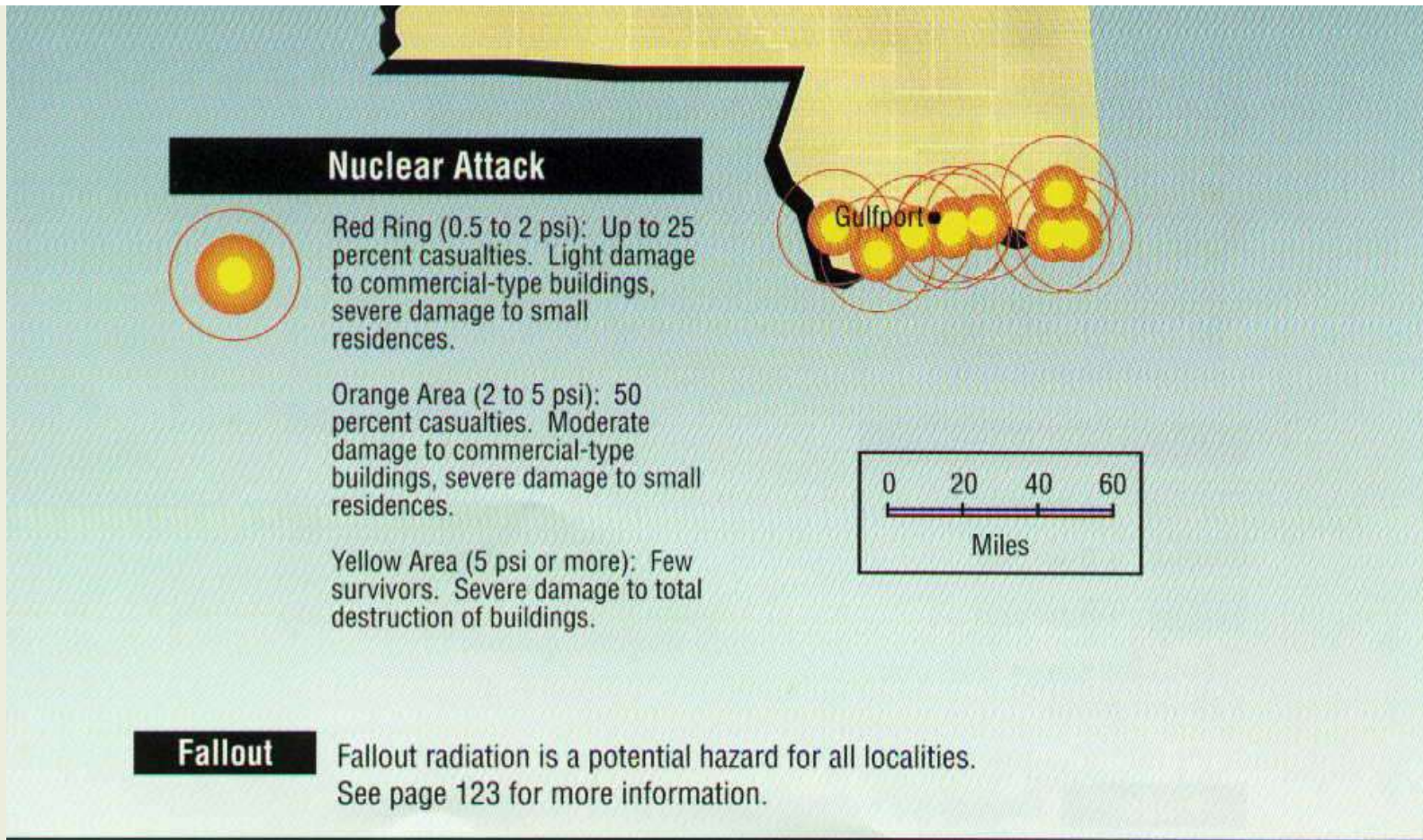
# Mississippi

This is the nuclear target map for Mississippi, but remember, fallout can go anywhere or everywhere (and probably will). After you have looked at this map look at the [Information for Mississippi](#) that follows it.

This link will take you back to the [Index of all the States](#)

## Nuclear Weapon Target Map for Mississippi (FEMA-196/September 1990)





[UPDATE to Target Information!!!](#)

## Information for Mississippi

This link will take you back to the [Index of all the States](#)

It is recommended that you go through the following 10 steps in studying about the nuclear threat to Mississippi.

1. Look at the [State Map](#) above to see the target nuclear areas in Mississippi.
2. Look at the [general expected fallout map](#) to see where Mississippi (according to the **prevailing wind pattern**) gets fallout from other states.
3. If the state that you live in is anywhere EAST of any of the following 6 states in the **prevailing wind pattern** then look at the states in **RED** on the [INDEX of](#)

## STATES for

- Montana
- North Dakota
- South Dakota
- Nebraska
- Missouri
- Colorado

These six states contain what is called DENSE PACK which I explain on each of those states pages. **UNDERSTAND** that the wind pattern **COULD** at that time be something other than the "prevailing" wind pattern.

4. Bookmark the present URL or make a copy of this present address so that you can come back to it after going to

[Blast Mapper](#).

This mapper is on someone else's web site so that you will need to save this address in order to return here if your back button doesn't work. However, you want to be sure to go the mapper site and calculate the damage to probable targets (cities) around you.

5. Memorize the THREE top rules for survival. They are:

- Number One - **Get out of the cities!**
- Number Two - **Get out of the cities!**
- Number Three - **Get out of the cities!**

6. The follow-on rules are:

- a. Have a shelter
- b. Work with a group (you are going to need the manpower, brainpower, and skillpower).

- c. Stock supplies.

7. My [Main Survival Page](#) contains links to lots of other information such as free books to download about nuclear survival, links to plans for building shelters, and even free consultation about building a shelter.

8. If you are SUPER concerned about nuclear survival you might consider moving within 20 miles of the

[Ark Two Community](#)  
(in Canada)

9. And finally if you would like to be on the mailing list of the author of this site - send a blank email to:

[arktwo-request@deuce.pairowoodies.com](mailto:arktwo-request@deuce.pairowoodies.com)  
[with the subject as subscribe](#)

**MENU: [HOME](#) » [SURVIVAL](#) » [Index of States](#)**

---

---

## Nuclear Survival in **Missouri**

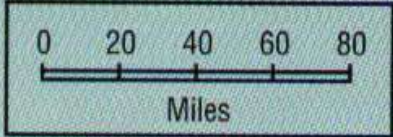
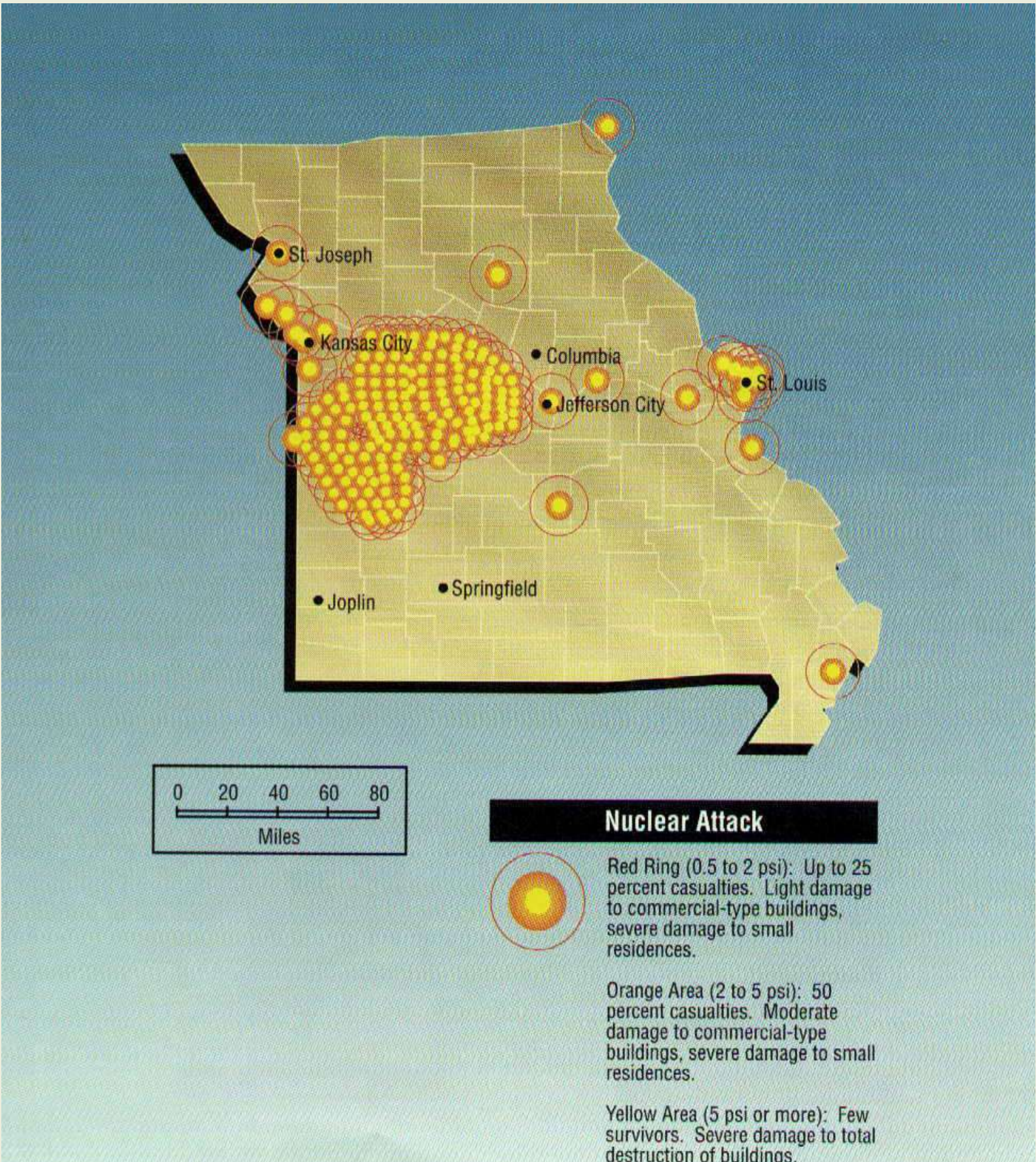
This is the nuclear target map for Missouri, but remember, fallout can go anywhere or everywhere (and probably will). After you have looked at this map look at the [Information for Missouri](#) that follows it.

This link will take you back to the [Index of all the States](#)

***DENSE PACK** - Look at all those target sites. So close Together! It serves a purpose. It is missiles protecting missiles, and this is how it is done. These are "hardened" sites. Meaning it takes a direct ground explosion to dig them out. An air burst will not do it. When you have a ground explosion it throws many tons of dust and sand up into the air. High into the air. This is what will later become fallout carried by the winds hundreds, sometimes thousands, of miles away. But right over that site that has just been hit the sand and grit in the air is very thick for quite a while. Another high speed missile (ICBM) trying to come through it will have its skin torn off just like by sand blasting and it will be destroyed. So the other missile sites nearby are safe. On the other hand, because missiles take off much slower than the speeds they eventually reach, the missiles in the undamaged silos can still be launched and will pass through the dust cloud without be harmed. Neat, eh? See there is a purpose in putting so many in one place. Now the only way that you can dig them out is with what is called a slow walk. Hit a target. Move on further and hit another target where the dust from the first won't hurt you. Come back thirty or forty-five minutes later and hit a second target near where you hit the first, after the cloud has had time to blow away. A slow process. Some silos will already have launched and you will waste the shot. Others can still wait to launch later because you can only get one at a time. This could go on for days. Neat. The military missiles protecting missiles. But they don't protect you, because if you are downwind you will get the fallout. Fatal if you are not in a*

*shelter. They call it Defense but it is only Destruction. Nothing here defends or protects you, if they are used.*

## Nuclear Weapon Target Map for Missouri (FEMA-196/September 1990)



### Nuclear Attack



**Red Ring (0.5 to 2 psi):** Up to 25 percent casualties. Light damage to commercial-type buildings, severe damage to small residences.

**Orange Area (2 to 5 psi):** 50 percent casualties. Moderate damage to commercial-type buildings, severe damage to small residences.

**Yellow Area (5 psi or more):** Few survivors. Severe damage to total destruction of buildings.



survivors. Severe damage to total destruction of buildings.

**Fallout**

Fallout radiation is a potential hazard for all localities.  
See page 123 for more information.

[UPDATE to Target Information!!!](#)

## Information for Missouri

This link will take you back to the [Index of all the States](#)

It is recommended that you go through the following 10 steps in studying about the nuclear threat to Missouri.

1. Look at the [State Map](#) above to see the target nuclear areas in Missouri.
2. Look at the [general expected fallout map](#) to see where Missouri (according to the **prevailing wind pattern**) gets fallout from other states.
3. If the state that you live in is anywhere EAST of any of the following 6 states in the **prevailing wind pattern** then look at the states in **RED** on the [INDEX of STATES](#) for

- **Montana**
- **North Dakota**
- **South Dakota**
- **Nebraska**
- **Missouri**
- **Colorado**

These six states contain what is called DENSE PACK which I explain on each of

those states pages. **UNDERSTAND** that the wind pattern **COULD** at that time be something other than the "prevailing" wind pattern.

4. Bookmark the present URL or make a copy of this present address so that you can come back to it after going to

[Blast Mapper](#).

This mapper is on someone else's web site so that you will need to save this address in order to return here if your back button doesn't work. However, you want to be sure to go the mapper site and calculate the damage to probable targets (cities) around you.

5. Memorize the **THREE** top rules for survival. They are:

- Number One - **Get out of the cities!**
- Number Two - **Get out of the cities!**
- Number Three - **Get out of the cities!**

6. The follow-on rules are:

- a. Have a shelter
- b. Work with a group (you are going to need the manpower, brainpower, and skillpower).
- c. Stock supplies.

7. My [Main Survival Page](#) contains links to lots of other information such as free books to download about nuclear survival, links to plans for building shelters, and even free consultation about building a shelter.

8. If you are **SUPER** concerned about nuclear survival you might consider moving within 20 miles of the

[Ark Two Community](#)

(in Canada)

9. And finally if you would like to be on the mailing list of the author of this site - send a blank email to:

[arktwo-request@deuce.pairowoodies.com](mailto:arktwo-request@deuce.pairowoodies.com)  
[with the subject as subscribe](#)

**MENU: [HOME](#) » [SURVIVAL](#) » [Index of States](#)**

---

---

## Nuclear Survival in

# Montana

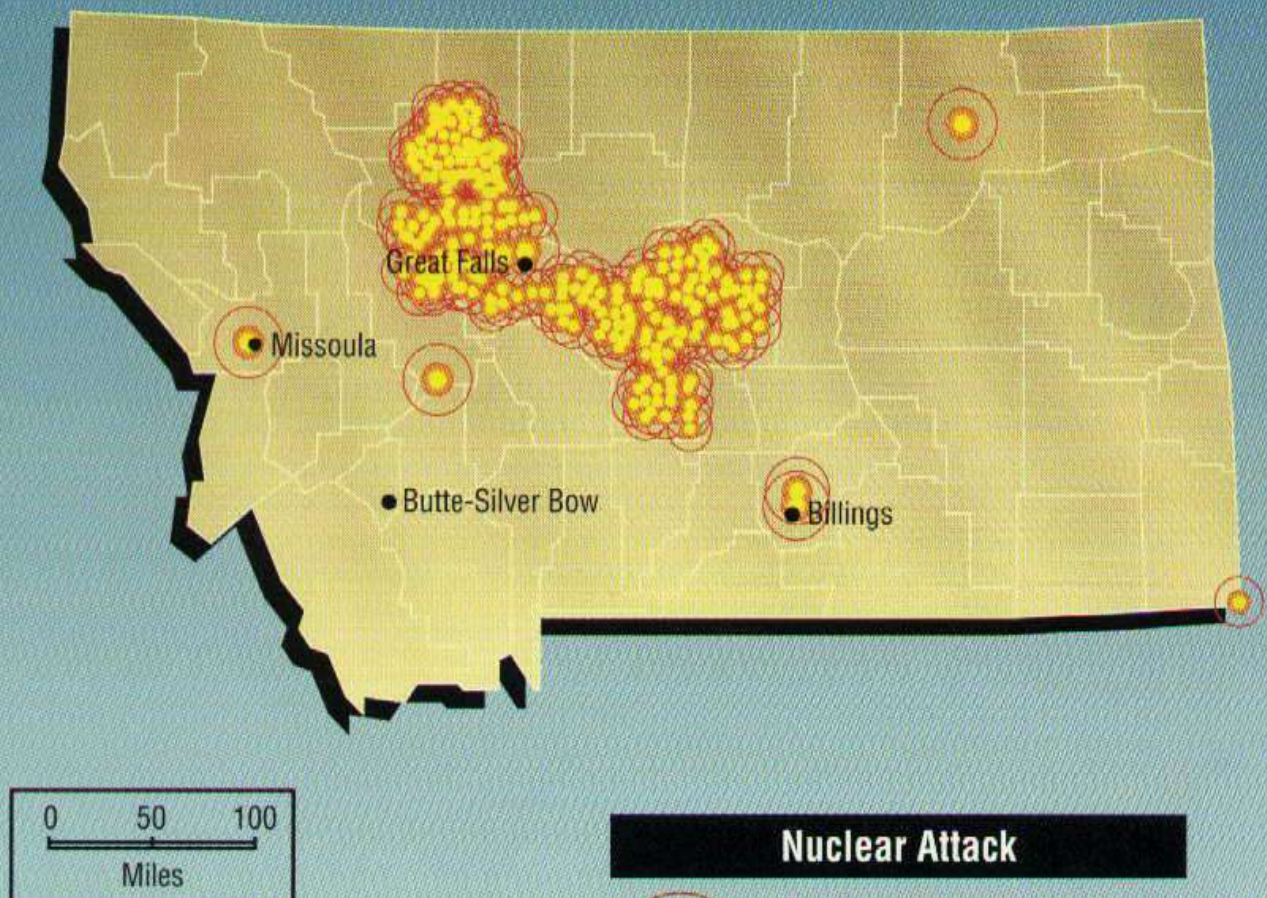
This is the nuclear target map for Montana, but remember, fallout can go anywhere or everywhere (and probably will). After you have looked at this map look at the [Information for Montana](#) that follows it.

This link will take you back to the [Index of all the States](#)

***DENSE PACK** - Look at all those target sites. So close Together! It serves a purpose. It is missiles protecting missiles, and this is how it is done. These are "hardened" sites. Meaning it takes a direct ground explosion to dig them out. An air burst will not do it. When you have a ground explosion it throws many tons of dust and sand up into the air. High into the air. This is what will later become fallout carried by the winds hundreds, sometimes thousands, of miles away. But right over that site that has just been hit the sand and grit in the air is very thick for quite a while. Another high speed missile (ICBM) trying to come through it will have its skin torn off just like by sand blasting and it will be destroyed. So the other missile sites nearby are safe. On the other hand, because missiles take off much slower than the speeds they eventually reach, the missiles in the undamaged silos can still be launched and will pass through the dust cloud without be harmed. Neat, eh? See there is a purpose in putting so many in one place. Now the only way that you can dig them out is with what is called a slow walk. Hit a target. Move on further and hit another target where the dust from the first won't hurt you. Come back thirty or forty-five minutes later and hit a second target near where you hit the first, after the cloud has had time to blow away. A slow process. Some silos will already have launched and you will waste the shot. Others can still wait to launch later because you can only get one at a time. This could go on for days. Neat. The military missiles protecting missiles. But they don't protect you, because if you are downwind you will get the fallout. Fatal if you are not in a*

*shelter. They call it Defense but it is only Destruction. Nothing here defends or protects you, if they are used.*

## Nuclear Weapon Target Map for Montana (FEMA-196/September 1990)



### Nuclear Attack



Red Ring (0.5 to 2 psi): Up to 25 percent casualties. Light damage to commercial-type buildings, severe damage to small residences.

Orange Area (2 to 5 psi): 50 percent casualties. Moderate damage to commercial-type buildings, severe damage to small residences.

Yellow Area (5 psi or more): Few survivors. Severe damage to total destruction of buildings.

**Fallout**

Fallout radiation is a potential hazard for all localities.  
See page 123 for more information.

[UPDATE to Target Information!!!](#)

## Information for Montana

This link will take you back to the [Index of all the States](#)

It is recommended that you go through the following 10 steps in studying about the nuclear threat to Montana.

1. Look at the [State Map](#) above to see the target nuclear areas in Montana.
2. Look at the [general expected fallout map](#) to see where Montana (according to the **prevailing wind pattern**) gets fallout from other states.
3. If the state that you live in is anywhere EAST of any of the following 6 states in the **prevailing wind pattern** then look at the states in **RED** on the [INDEX of STATES](#) for

- **Montana**
- **North Dakota**
- **South Dakota**
  - **Nebraska**
  - **Missouri**
  - **Colorado**

These six states contain what is called DENSE PACK which I explain on each of

those states pages. **UNDERSTAND** that the wind pattern **COULD** at that time be something other than the "prevailing" wind pattern.

4. Bookmark the present URL or make a copy of this present address so that you can come back to it after going to

[Blast Mapper](#).

This mapper is on someone else's web site so that you will need to save this address in order to return here if your back button doesn't work. However, you want to be sure to go the mapper site and calculate the damage to probable targets (cities) around you.

5. Memorize the **THREE** top rules for survival. They are:

- Number One - **Get out of the cities!**
- Number Two - **Get out of the cities!**
- Number Three - **Get out of the cities!**

6. The follow-on rules are:

- a. Have a shelter
- b. Work with a group (you are going to need the manpower, brainpower, and skillpower).
- c. Stock supplies.

7. My [Main Survival Page](#) contains links to lots of other information such as free books to download about nuclear survival, links to plans for building shelters, and even free consultation about building a shelter.

8. If you are **SUPER** concerned about nuclear survival you might consider moving within 20 miles of the

[Ark Two Community](#)

(in Canada)

9. And finally if you would like to be on the mailing list of the author of this site - send a blank email to:

[arktvo-request@deuce.pairowoodies.com](mailto:arktvo-request@deuce.pairowoodies.com)  
[with the subject as subscribe](#)

**MENU: [HOME](#) » [SURVIVAL](#) » [Index of States](#)**

---

---



## Nuclear Survival in **Nebraska**

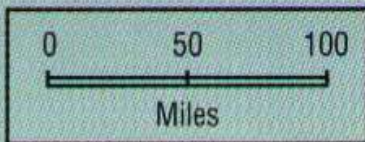
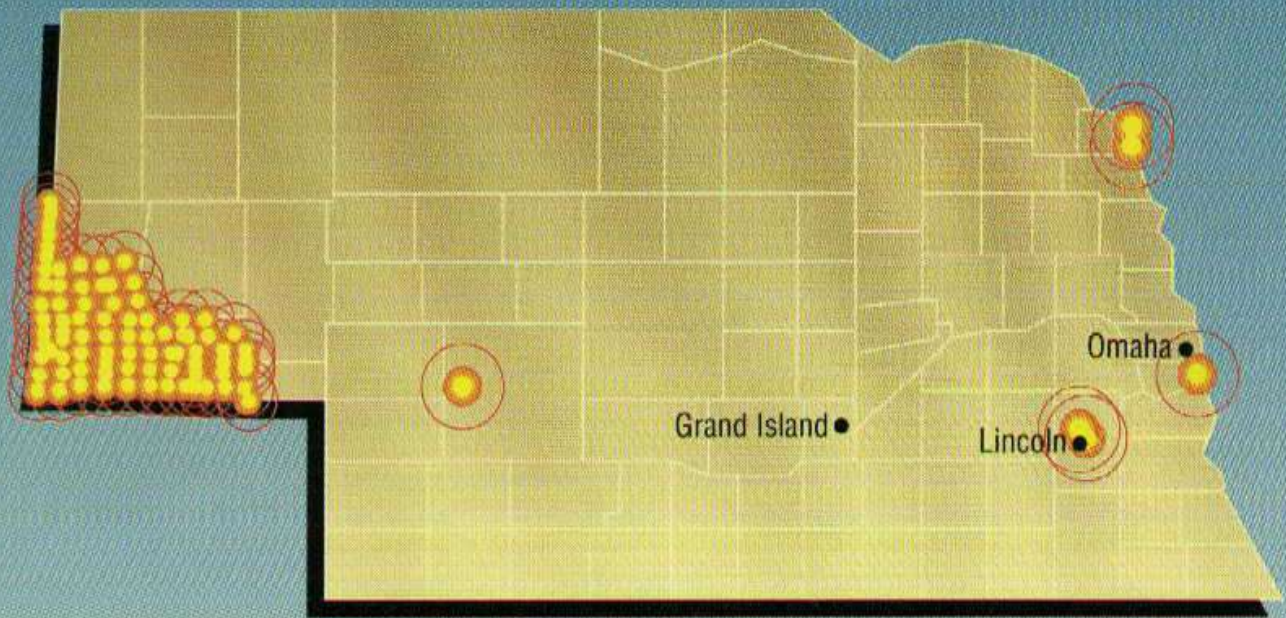
This is the nuclear target map for Nebraska, but remember, fallout can go anywhere or everywhere (and probably will). After you have looked at this map look at the [Information for Nebraska](#) that follows it.

This link will take you back to the [Index of all the States](#)

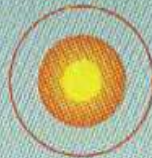
***DENSE PACK** - Look at all those target sites. So close Together! It serves a purpose. It is missiles protecting missiles, and this is how it is done. These are "hardened" sites. Meaning it takes a direct ground explosion to dig them out. An air burst will not do it. When you have a ground explosion it throws many tons of dust and sand up into the air. High into the air. This is what will later become fallout carried by the winds hundreds, sometimes thousands, of miles away. But right over that site that has just been hit the sand and grit in the air is very thick for quite a while. Another high speed missile (ICBM) trying to come through it will have its skin torn off just like by sand blasting and it will be destroyed. So the other missile sites nearby are safe. On the other hand, because missiles take off much slower than the speeds they eventually reach, the missiles in the undamaged silos can still be launched and will pass through the dust cloud without be harmed. Neat, eh? See there is a purpose in putting so many in one place. Now the only way that you can dig them out is with what is called a slow walk. Hit a target. Move on further and hit another target where the dust from the first won't hurt you. Come back thirty or forty-five minutes later and hit a second target near where you hit the first, after the cloud has had time to blow away. A slow process. Some silos will already have launched and you will waste the shot. Others can still wait to launch later because you can only get one at a time. This could go on for days. Neat. The military missiles protecting missiles. But they don't protect you, because if you are downwind you will get the fallout. Fatal if you are not in a*

*shelter. They call it Defense but it is only Destruction. Nothing here defends or protects you, if they are used.*

## Nuclear Weapon Target Map for Nebraska (FEMA-196/September 1990)



### Nuclear Attack



Red Ring (0.5 to 2 psi): Up to 25 percent casualties. Light damage to commercial-type buildings, severe damage to small residences.

Orange Area (2 to 5 psi): 50 percent casualties. Moderate damage to commercial-type buildings, severe damage to small residences.

Yellow Area (5 psi or more): Few survivors. Severe damage to total destruction of buildings.

**Fallout**

Fallout radiation is a potential hazard for all localities.  
See page 123 for more information

[UPDATE to Target Information!!!](#)

## Information for Nebraska

This link will take you back to the [Index of all the States](#)

It is recommended that you go through the following 10 steps in studying about the nuclear threat to Nebraska.

1. Look at the [State Map](#) above to see the target nuclear areas in Nebraska.
2. Look at the [general expected fallout map](#) to see where Nebraska (according to the **prevailing wind pattern**) gets fallout from other states.
3. If the state that you live in is anywhere EAST of any of the following 6 states in the **prevailing wind pattern** then look at the states in **RED** on the [INDEX of STATES](#) for

- **Montana**
- **North Dakota**
- **South Dakota**
- **Nebraska**
- **Missouri**
- **Colorado**

These six states contain what is called DENSE PACK which I explain on each of

those states pages. **UNDERSTAND** that the wind pattern **COULD** at that time be something other than the "prevailing" wind pattern.

4. Bookmark the present URL or make a copy of this present address so that you can come back to it after going to

[Blast Mapper](#).

This mapper is on someone else's web site so that you will need to save this address in order to return here if your back button doesn't work. However, you want to be sure to go the mapper site and calculate the damage to probable targets (cities) around you.

5. Memorize the **THREE** top rules for survival. They are:

- Number One - **Get out of the cities!**
- Number Two - **Get out of the cities!**
- Number Three - **Get out of the cities!**

6. The follow-on rules are:

- a. Have a shelter
- b. Work with a group (you are going to need the manpower, brainpower, and skillpower).
- c. Stock supplies.

7. My [Main Survival Page](#) contains links to lots of other information such as free books to download about nuclear survival, links to plans for building shelters, and even free consultation about building a shelter.

8. If you are **SUPER** concerned about nuclear survival you might consider moving within 20 miles of the

[Ark Two Community](#)

(in Canada)

9. And finally if you would like to be on the mailing list of the author of this site - send a blank email to:

[arktvo-request@deuce.pairowoodies.com](mailto:arktvo-request@deuce.pairowoodies.com)  
[with the subject as subscribe](#)

**MENU: [HOME](#) » [SURVIVAL](#) » [Index of States](#)**

---

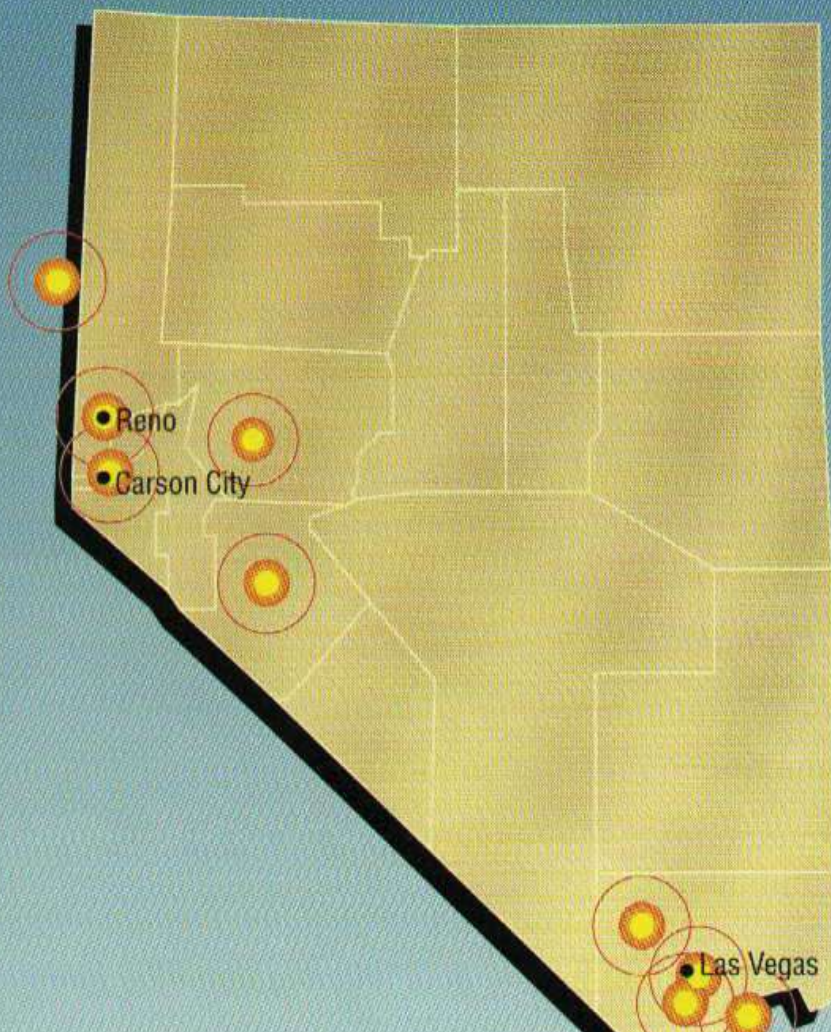
---

## Nuclear Survival in **Nevada**

This is the nuclear target map for Nevada, but remember, fallout can go anywhere or everywhere (and probably will). After you have looked at this map look at the [Information for Nevada](#) that follows it.

This link will take you back to the [Index of all the States](#)

### **Nuclear Weapon Target Map for Nevada (FEMA-196/September 1990)**



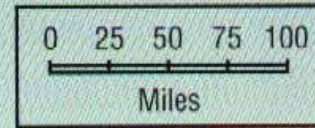
## Nuclear Attack



**Red Ring (0.5 to 2 psi):** Up to 25 percent casualties. Light damage to commercial-type buildings, severe damage to small residences.

**Orange Area (2 to 5 psi):** 50 percent casualties. Moderate damage to commercial-type buildings, severe damage to small residences.

**Yellow Area (5 psi or more):** Few survivors. Severe damage to total destruction of buildings.



## Fallout

Fallout radiation is a potential hazard for all localities. See page 123 for more information.

## [UPDATE to Target Information!!!](#)

### Information for Nevada

This link will take you back to the [Index of all the States](#)

It is recommended that you go through the following 10 steps in studying about the nuclear threat to Nevada.

1. Look at the [State Map](#) above to see the target nuclear areas in Nevada.
2. Look at the [general expected fallout map](#) to see where Nevada (according to the **prevailing wind pattern**) gets fallout from other states.
3. If the state that you live in is anywhere EAST of any of the following 6 states in the **prevailing wind pattern** then look at the states in **RED** on the [INDEX of](#)

## STATES for

- Montana
- North Dakota
- South Dakota
- Nebraska
- Missouri
- Colorado

These six states contain what is called DENSE PACK which I explain on each of those states pages. **UNDERSTAND** that the wind pattern **COULD** at that time be something other than the "prevailing" wind pattern.

4. Bookmark the present URL or make a copy of this present address so that you can come back to it after going to

[Blast Mapper](#).

This mapper is on someone else's web site so that you will need to save this address in order to return here if your back button doesn't work. However, you want to be sure to go the mapper site and calculate the damage to probable targets (cities) around you.

5. Memorize the THREE top rules for survival. They are:

- Number One - **Get out of the cities!**
- Number Two - **Get out of the cities!**
- Number Three - **Get out of the cities!**

6. The follow-on rules are:

- a. Have a shelter
- b. Work with a group (you are going to need the manpower, brainpower, and skillpower).



- c. Stock supplies.

7. My [Main Survival Page](#) contains links to lots of other information such as free books to download about nuclear survival, links to plans for building shelters, and even free consultation about building a shelter.

8. If you are SUPER concerned about nuclear survival you might consider moving within 20 miles of the

[Ark Two Community](#)  
(in Canada)

9. And finally if you would like to be on the mailing list of the author of this site - send a blank email to:

[arktwo-request@deuce.pairowoodies.com](mailto:arktwo-request@deuce.pairowoodies.com)  
[with the subject as subscribe](#)

**MENU: [HOME](#) » [SURVIVAL](#) » [Index of States](#)**

---


---

## Nuclear Survival in **New Hampshire**

This is the nuclear target map for New Hampshire, but remember, fallout can go anywhere or everywhere (and probably will). After you have looked at this map look at the [Information for New Hampshire](#) that follows it.

This link will take you back to the [Index of all the States](#)

**Nuclear Weapon Target Map for New Hampshire (FEMA-196/September 1990)**

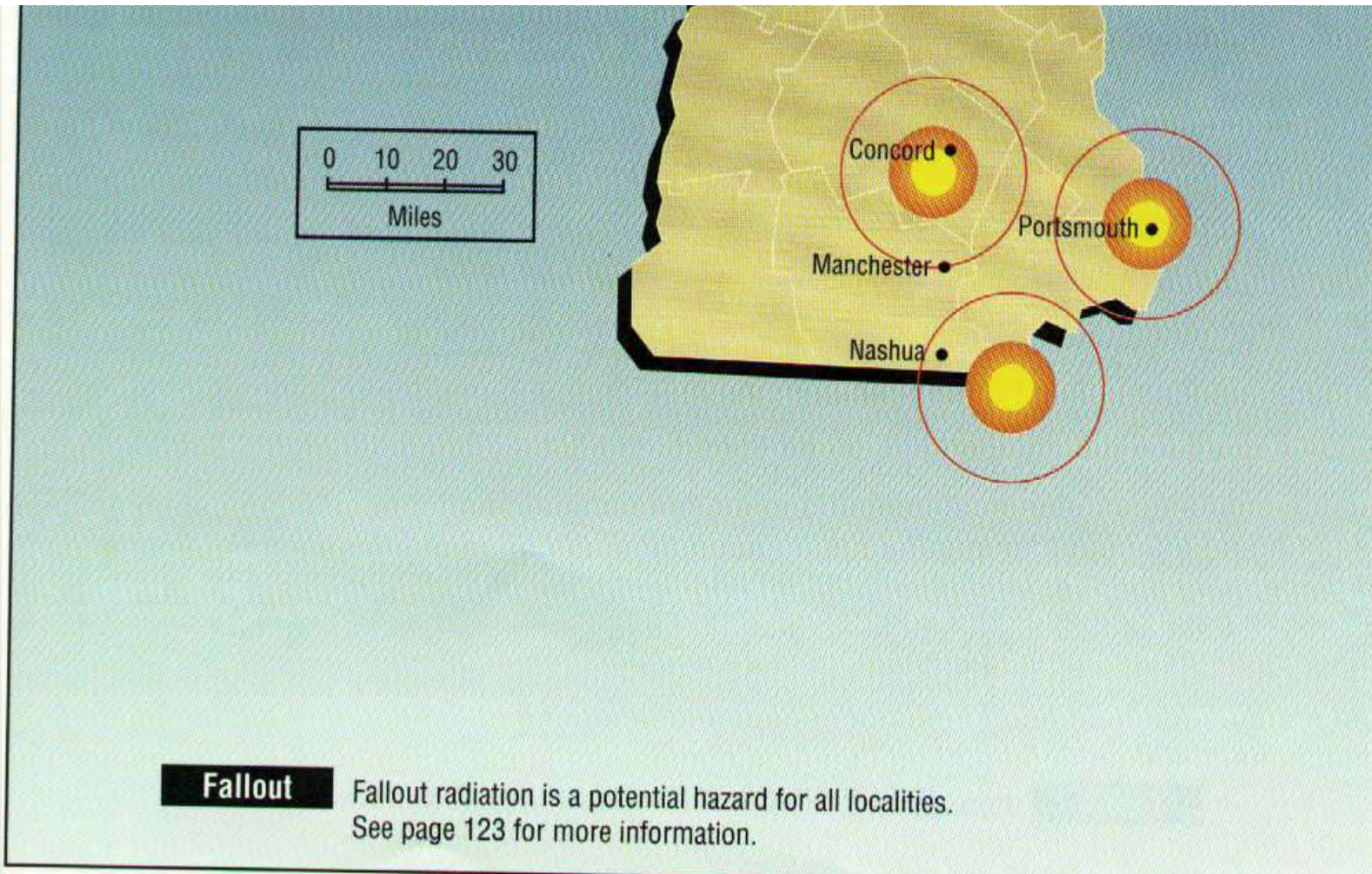


**Nuclear Attack**

**Red Ring (0.5 to 2 psi):** Up to 25 percent casualties. Light damage to commercial-type buildings, severe damage to small residences.

**Orange Area (2 to 5 psi):** 50 percent casualties. Moderate damage to commercial-type buildings, severe damage to small residences.

**Yellow Area (5 psi or more):** Few survivors. Severe damage to total destruction of buildings.



[UPDATE to Target Information!!!](#)

## Information for New Hampshire

This link will take you back to the [Index of all the States](#)

It is recommended that you go through the following 10 steps in studying about the nuclear threat to New Hampshire.

1. Look at the [State Map](#) above to see the target nuclear areas in New Hampshire.
2. Look at the [general expected fallout map](#) to see where New Hampshire (according to the **prevailing wind pattern**) gets fallout from other states.
3. If the state that you live in is anywhere EAST of any of the following 6 states in

the **prevailing wind pattern** then look at the states in **RED** on the [INDEX of STATES](#) for

- **Montana**
- **North Dakota**
- **South Dakota**
- **Nebraska**
- **Missouri**
- **Colorado**

These six states contain what is called DENSE PACK which I explain on each of those states pages. **UNDERSTAND** that the wind pattern **COULD** at that time be something other than the "**prevailing**" wind pattern.

4. Bookmark the present URL or make a copy of this present address so that you can come back to it after going to

[Blast Mapper](#).

This mapper is on someone else's web site so that you will need to save this address in order to return here if your back button doesn't work. However, you want to be sure to go the mapper site and calculate the damage to probable targets (cities) around you.

5. Memorize the **THREE** top rules for survival. They are:

- Number One - **Get out of the cities!**
- Number Two - **Get out of the cities!**
- Number Three - **Get out of the cities!**

6. The follow-on rules are:

- a. Have a shelter
- b. Work with a group (you are going to need the manpower, brainpower, and

skillpower).

- c. Stock supplies.

7. My [Main Survival Page](#) contains links to lots of other information such as free books to download about nuclear survival, links to plans for building shelters, and even free consultation about building a shelter.

8. If you are SUPER concerned about nuclear survival you might consider moving within 20 miles of the

[Ark Two Community](#)  
(in Canada)

9. And finally if you would like to be on the mailing list of the author of this site - send a blank email to:

[arktwo-request@deuce.pairowoodies.com](mailto:arktwo-request@deuce.pairowoodies.com)  
[with the subject as subscribe](#)

**MENU: [HOME](#) » [SURVIVAL](#) » [Index of States](#)**

---

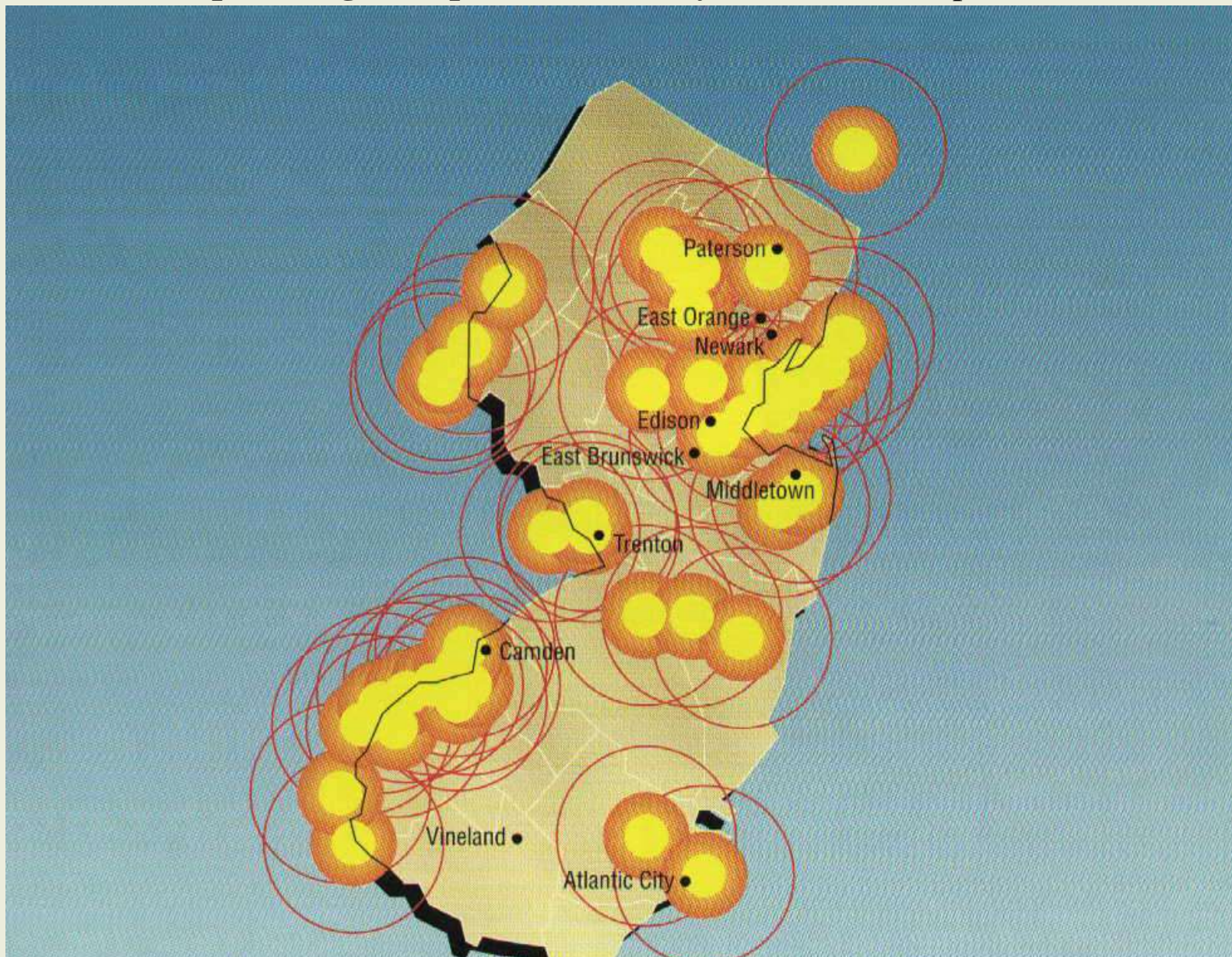
---

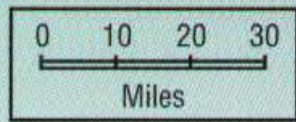
## Nuclear Survival in **New Jersey**

This is the nuclear target map for New Jersey, but remember, fallout can go anywhere or everywhere (and probably will). After you have looked at this map look at the [Information for New Jersey](#) that follows it.

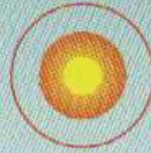
This link will take you back to the [Index of all the States](#)

### **Nuclear Weapon Target Map for New Jersey (FEMA-196/September 1990)**





## Nuclear Attack



**Red Ring (0.5 to 2 psi):** Up to 25 percent casualties. Light damage to commercial-type buildings, severe damage to small residences.

**Orange Area (2 to 5 psi):** 50 percent casualties. Moderate damage to commercial-type buildings, severe damage to small residences.

**Yellow Area (5 psi or more):** Few survivors. Severe damage to total destruction of buildings.

## Fallout

Fallout radiation is a potential hazard for all localities. See page 123 for more information.

[UPDATE to Target Information!!!](#)

## Information for New Jersey

This link will take you back to the [Index of all the States](#)

It is recommended that you go through the following 10 steps in studying about the nuclear threat to New Jersey.

1. Look at the [State Map](#) above to see the target nuclear areas in New Jersey.
2. Look at the [general expected fallout map](#) to see where New Jersey (according to the **prevailing wind pattern**) gets fallout from other states.
3. If the state that you live in is anywhere EAST of any of the following 6 states in the **prevailing wind pattern** then look at the states in **RED** on the [INDEX of](#)

## STATES for

- Montana
- North Dakota
- South Dakota
- Nebraska
- Missouri
- Colorado

These six states contain what is called DENSE PACK which I explain on each of those states pages. **UNDERSTAND** that the wind pattern **COULD** at that time be something other than the "prevailing" wind pattern.

4. Bookmark the present URL or make a copy of this present address so that you can come back to it after going to

[Blast Mapper.](#)

This mapper is on someone else's web site so that you will need to save this address in order to return here if your back button doesn't work. However, you want to be sure to go the mapper site and calculate the damage to probable targets (cities) around you.

5. Memorize the THREE top rules for survival. They are:

- Number One - **Get out of the cities!**
- Number Two - **Get out of the cities!**
- Number Three - **Get out of the cities!**

6. The follow-on rules are:

- a. Have a shelter
- b. Work with a group (you are going to need the manpower, brainpower, and skillpower).



- c. Stock supplies.

7. My [Main Survival Page](#) contains links to lots of other information such as free books to download about nuclear survival, links to plans for building shelters, and even free consultation about building a shelter.

8. If you are SUPER concerned about nuclear survival you might consider moving within 20 miles of the

[Ark Two Community](#)  
(in Canada)

9. And finally if you would like to be on the mailing list of the author of this site - send a blank email to:

[arktwo-request@deuce.pairowoodies.com](mailto:arktwo-request@deuce.pairowoodies.com)  
[with the subject as subscribe](#)

**MENU: [HOME](#) » [SURVIVAL](#) » [Index of States](#)**

---

---

Nuclear Survival in

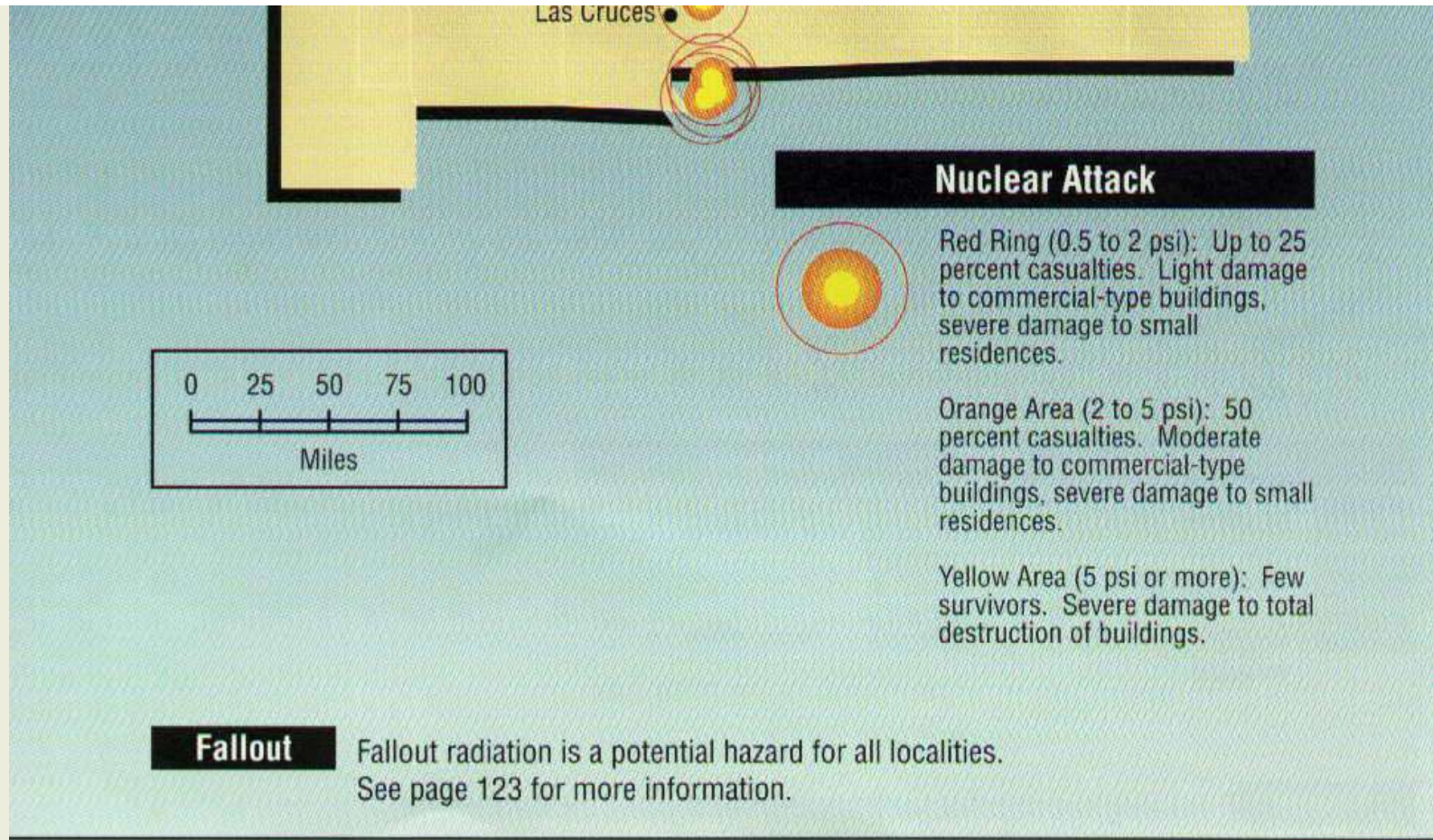
# New Mexico

This is the nuclear target map for New Mexico, but remember, fallout can go anywhere or everywhere (and probably will). After you have looked at this map look at the [Information for New Mexico](#) that follows it.

This link will take you back to the [Index of all the States](#)

## Nuclear Weapon Target Map for New Mexico (FEMA-196/September 1990)





[UPDATE to Target Information!!!](#)

## Information for New Mexico

This link will take you back to the [Index of all the States](#)

It is recommended that you go through the following 10 steps in studying about the nuclear threat to New Mexico.

1. Look at the [State Map](#) above to see the target nuclear areas in New Mexico.
2. Look at the [general expected fallout map](#) to see where New Mexico (according to the **prevailing wind pattern**) gets fallout from other states.
3. If the state that you live in is anywhere EAST of any of the following 6 states in the **prevailing wind pattern** then look at the states in **RED** on the [INDEX of](#)

## STATES for

- Montana
- North Dakota
- South Dakota
- Nebraska
- Missouri
- Colorado

These six states contain what is called DENSE PACK which I explain on each of those states pages. **UNDERSTAND** that the wind pattern **COULD** at that time be something other than the "prevailing" wind pattern.

4. Bookmark the present URL or make a copy of this present address so that you can come back to it after going to

[Blast Mapper](#).

This mapper is on someone else's web site so that you will need to save this address in order to return here if your back button doesn't work. However, you want to be sure to go the mapper site and calculate the damage to probable targets (cities) around you.

5. Memorize the THREE top rules for survival. They are:

- Number One - **Get out of the cities!**
- Number Two - **Get out of the cities!**
- Number Three - **Get out of the cities!**

6. The follow-on rules are:

- a. Have a shelter
- b. Work with a group (you are going to need the manpower, brainpower, and skillpower).

- c. Stock supplies.

7. My [Main Survival Page](#) contains links to lots of other information such as free books to download about nuclear survival, links to plans for building shelters, and even free consultation about building a shelter.

8. If you are SUPER concerned about nuclear survival you might consider moving within 20 miles of the

[Ark Two Community](#)  
(in Canada)

9. And finally if you would like to be on the mailing list of the author of this site - send a blank email to:

[arktwo-request@deuce.pairowoodies.com](mailto:arktwo-request@deuce.pairowoodies.com)  
[with the subject as subscribe](#)

**MENU: [HOME](#) » [SURVIVAL](#) » [Index of States](#)**

---

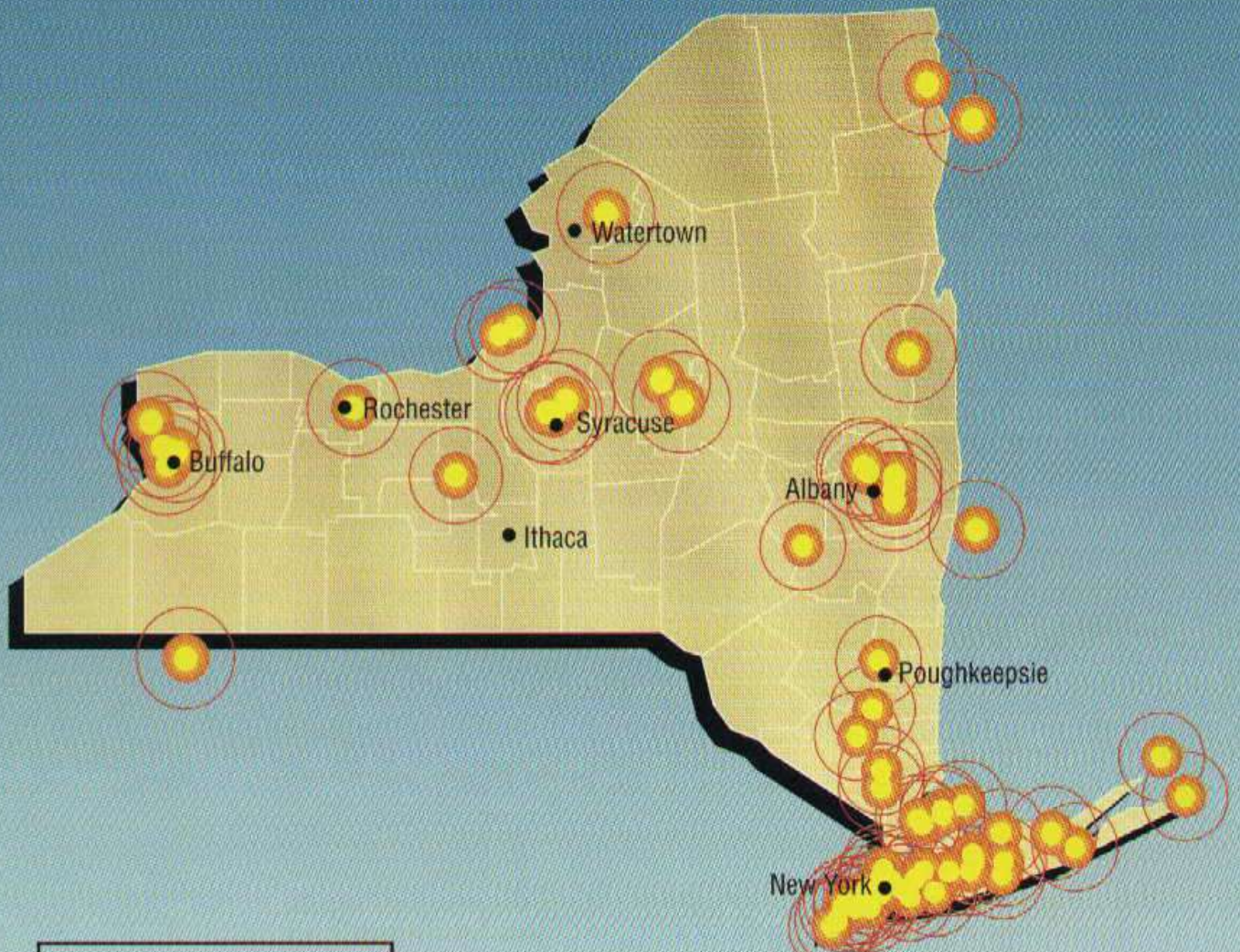
---

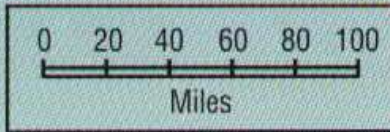
## Nuclear Survival in **New York**

This is the nuclear target map for New York, but remember, fallout can go anywhere or everywhere (and probably will). After you have looked at this map look at the [Information for New York](#) that follows it.

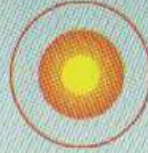
This link will take you back to the [Index of all the States](#)

### **Nuclear Weapon Target Map for New York (FEMA-196/September 1990)**





### Nuclear Attack



Red Ring (0.5 to 2 psi): Up to 25 percent casualties. Light damage to commercial-type buildings, severe damage to small residences.

Orange Area (2 to 5 psi): 50 percent casualties. Moderate damage to commercial-type buildings, severe damage to small residences.

Yellow Area (5 psi or more): Few survivors. Severe damage to total destruction of buildings.

### Fallout

Fallout radiation is a potential hazard for all localities. See page 123 for more information.

[UPDATE to Target Information!!!](#)

## Information for New York

This link will take you back to the [Index of all the States](#)

It is recommended that you go through the following 10 steps in studying about the nuclear threat to New York.

1. Look at the [State Map](#) above to see the target nuclear areas in New York.
2. Look at the [general expected fallout map](#) to see where New York (according to the **prevailing wind pattern**) gets fallout from other states.
3. If the state that you live in is anywhere EAST of any of the following 6 states in the **prevailing wind pattern** then look at the states in **RED** on the [INDEX of](#)

## STATES for

- Montana
- North Dakota
- South Dakota
- Nebraska
- Missouri
- Colorado

These six states contain what is called DENSE PACK which I explain on each of those states pages. **UNDERSTAND** that the wind pattern **COULD** at that time be something other than the "prevailing" wind pattern.

4. Bookmark the present URL or make a copy of this present address so that you can come back to it after going to

[Blast Mapper](#).

This mapper is on someone else's web site so that you will need to save this address in order to return here if your back button doesn't work. However, you want to be sure to go the mapper site and calculate the damage to probable targets (cities) around you.

5. Memorize the THREE top rules for survival. They are:

- Number One - **Get out of the cities!**
- Number Two - **Get out of the cities!**
- Number Three - **Get out of the cities!**

6. The follow-on rules are:

- a. Have a shelter
- b. Work with a group (you are going to need the manpower, brainpower, and skillpower).



- c. Stock supplies.

7. My [Main Survival Page](#) contains links to lots of other information such as free books to download about nuclear survival, links to plans for building shelters, and even free consultation about building a shelter.

8. If you are SUPER concerned about nuclear survival you might consider moving within 20 miles of the

[Ark Two Community](#)  
(in Canada)

9. And finally if you would like to be on the mailing list of the author of this site - send a blank email to:

[arktwo-request@deuce.pairowoodies.com](mailto:arktwo-request@deuce.pairowoodies.com)  
[with the subject as subscribe](#)

**MENU: [HOME](#) » [SURVIVAL](#) » [Index of States](#)**

---

---

Nuclear Survival in

# North Carolina

This is the nuclear target map for North Carolina, but remember, fallout can go anywhere or everywhere (and probably will). After you have looked at this map look at the [Information for North Carolina](#) that follows it.

This link will take you back to the [Index of all the States](#)

## Nuclear Weapon Target Map for North Carolina (FEMA-196/September 1990)



## Nuclear Attack



Red Ring (0.5 to 2 psi): Up to 25 percent casualties. Light damage to commercial-type buildings, severe damage to small residences.

Orange Area (2 to 5 psi): 50 percent casualties. Moderate damage to commercial-type buildings, severe damage to small residences.

Yellow Area (5 psi or more): Few survivors. Severe damage to total destruction of buildings.

## Fallout

Fallout radiation is a potential hazard for all localities. See page 123 for more information.

## [UPDATE to Target Information!!!](#)

### Information for North Carolina

This link will take you back to the [Index of all the States](#)

It is recommended that you go through the following 10 steps in studying about the nuclear threat to North Carolina.

1. Look at the [State Map](#) above to see the target nuclear areas in North Carolina.
2. Look at the [general expected fallout map](#) to see where North Carolina (according to the **prevailing wind pattern**) gets fallout from other states.
3. If the state that you live in is anywhere EAST of any of the following 6 states in the **prevailing wind pattern** then look at the states in **RED** on the [INDEX of](#)

## STATES for

- Montana
- North Dakota
- South Dakota
- Nebraska
- Missouri
- Colorado

These six states contain what is called DENSE PACK which I explain on each of those states pages. **UNDERSTAND** that the wind pattern **COULD** at that time be something other than the "prevailing" wind pattern.

4. Bookmark the present URL or make a copy of this present address so that you can come back to it after going to

[Blast Mapper](#).

This mapper is on someone else's web site so that you will need to save this address in order to return here if your back button doesn't work. However, you want to be sure to go the mapper site and calculate the damage to probable targets (cities) around you.

5. Memorize the THREE top rules for survival. They are:

- Number One - **Get out of the cities!**
- Number Two - **Get out of the cities!**
- Number Three - **Get out of the cities!**

6. The follow-on rules are:

- a. Have a shelter
- b. Work with a group (you are going to need the manpower, brainpower, and skillpower).

- c. Stock supplies.

7. My [Main Survival Page](#) contains links to lots of other information such as free books to download about nuclear survival, links to plans for building shelters, and even free consultation about building a shelter.

8. If you are SUPER concerned about nuclear survival you might consider moving within 20 miles of the

[Ark Two Community](#)  
(in Canada)

9. And finally if you would like to be on the mailing list of the author of this site - send a blank email to:

[arktwo-request@deuce.pairowoodies.com](mailto:arktwo-request@deuce.pairowoodies.com)  
[with the subject as subscribe](#)

**MENU: [HOME](#) » [SURVIVAL](#) » [Index of States](#)**

---

---

## Nuclear Survival in

# North Dakota

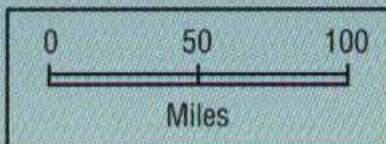
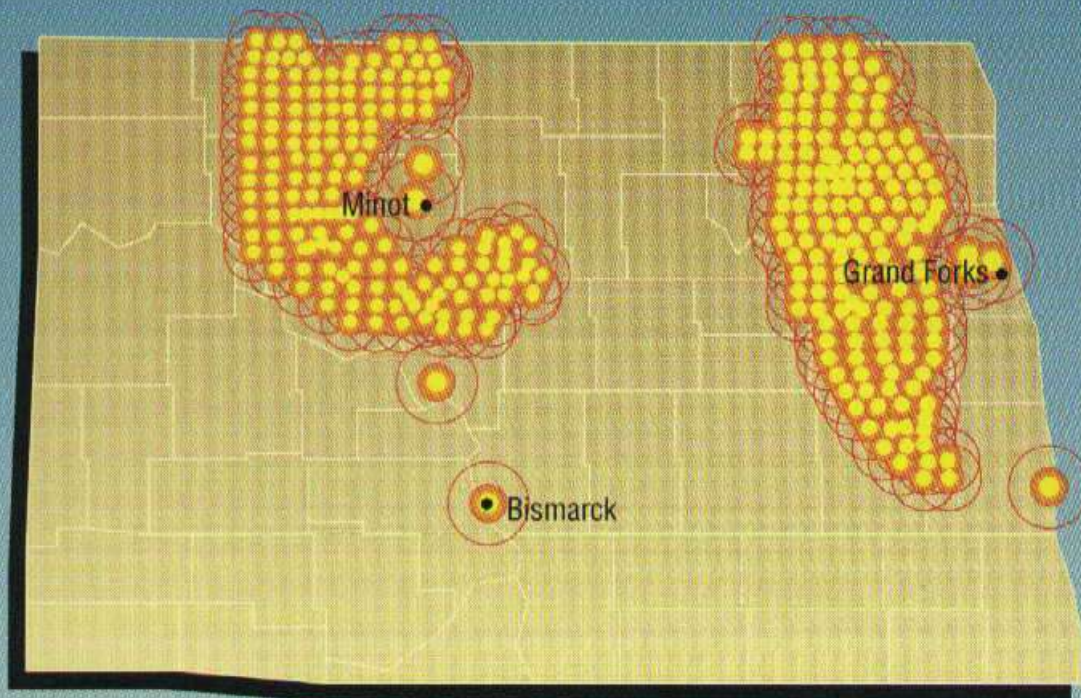
This is the nuclear target map for North Dakota, but remember, fallout can go anywhere or everywhere (and probably will). After you have looked at this map look at the [Information for North Dakota](#) that follows it.

This link will take you back to the [Index of all the States](#)

***DENSE PACK** - Look at all those target sites. So close Together! It serves a purpose. It is missiles protecting missiles, and this is how it is done. These are "hardened" sites. Meaning it takes a direct ground explosion to dig them out. An air burst will not do it. When you have a ground explosion it throws many tons of dust and sand up into the air. High into the air. This is what will later become fallout carried by the winds hundreds, sometimes thousands, of miles away. But right over that site that has just been hit the sand and grit in the air is very thick for quite a while. Another high speed missile (ICBM) trying to come through it will have its skin torn off just like by sand blasting and it will be destroyed. So the other missile sites nearby are safe. On the other hand, because missiles take off much slower than the speeds they eventually reach, the missiles in the undamaged silos can still be launched and will pass through the dust cloud without be harmed. Neat, eh? See there is a purpose in putting so many in one place. Now the only way that you can dig them out is with what is called a slow walk. Hit a target. Move on further and hit another target where the dust from the first won't hurt you. Come back thirty or forty-five minutes later and hit a second target near where you hit the first, after the cloud has had time to blow away. A slow process. Some silos will already have launched and you will waste the shot. Others can still wait to launch later because you can only get one at a time. This could go on for days. Neat. The military missiles protecting missiles. But they don't protect you, because if you are downwind you will get the fallout. Fatal if you are not in a*

*shelter. They call it Defense but it is only Destruction. Nothing here defends or protects you, if they are used.*

## Nuclear Weapon Target Map for North Dakota (FEMA-196/September 1990)



### Nuclear Attack



Red Ring (0.5 to 2 psi): Up to 25 percent casualties. Light damage to commercial-type buildings, severe damage to small residences.

Orange Area (2 to 5 psi): 50 percent casualties. Moderate damage to commercial-type buildings, severe damage to small residences.

Yellow Area (5 psi or more): Few survivors. Severe damage to total destruction of buildings.

**Fallout**

Fallout radiation is a potential hazard for all localities.  
See page 123 for more information.

[UPDATE to Target Information!!!](#)

## Information for North Dakota

This link will take you back to the [Index of all the States](#)

It is recommended that you go through the following 10 steps in studying about the nuclear threat to North Dakota.

1. Look at the [State Map](#) above to see the target nuclear areas in North Dakota.
2. Look at the [general expected fallout map](#) to see where North Dakota (according to the **prevailing wind pattern**) gets fallout from other states.
3. If the state that you live in is anywhere EAST of any of the following 6 states in the **prevailing wind pattern** then look at the states in **RED** on the [INDEX of STATES](#) for

- **Montana**
- **North Dakota**
- **South Dakota**
  - **Nebraska**
  - **Missouri**
  - **Colorado**

These six states contain what is called DENSE PACK which I explain on each of



those states pages. **UNDERSTAND** that the wind pattern **COULD** at that time be something other than the "prevailing" wind pattern.

4. Bookmark the present URL or make a copy of this present address so that you can come back to it after going to

[Blast Mapper](#).

This mapper is on someone else's web site so that you will need to save this address in order to return here if your back button doesn't work. However, you want to be sure to go the mapper site and calculate the damage to probable targets (cities) around you.

5. Memorize the **THREE** top rules for survival. They are:

- Number One - **Get out of the cities!**
- Number Two - **Get out of the cities!**
- Number Three - **Get out of the cities!**

6. The follow-on rules are:

- a. Have a shelter
- b. Work with a group (you are going to need the manpower, brainpower, and skillpower).
- c. Stock supplies.

7. My [Main Survival Page](#) contains links to lots of other information such as free books to download about nuclear survival, links to plans for building shelters, and even free consultation about building a shelter.

8. If you are **SUPER** concerned about nuclear survival you might consider moving within 20 miles of the

[Ark Two Community](#)

(in Canada)

9. And finally if you would like to be on the mailing list of the author of this site - send a blank email to:

[arktwo-request@deuce.pairowoodies.com](mailto:arktwo-request@deuce.pairowoodies.com)  
[with the subject as subscribe](#)

**MENU: [HOME](#) » [SURVIVAL](#) » [Index of States](#)**

---

---

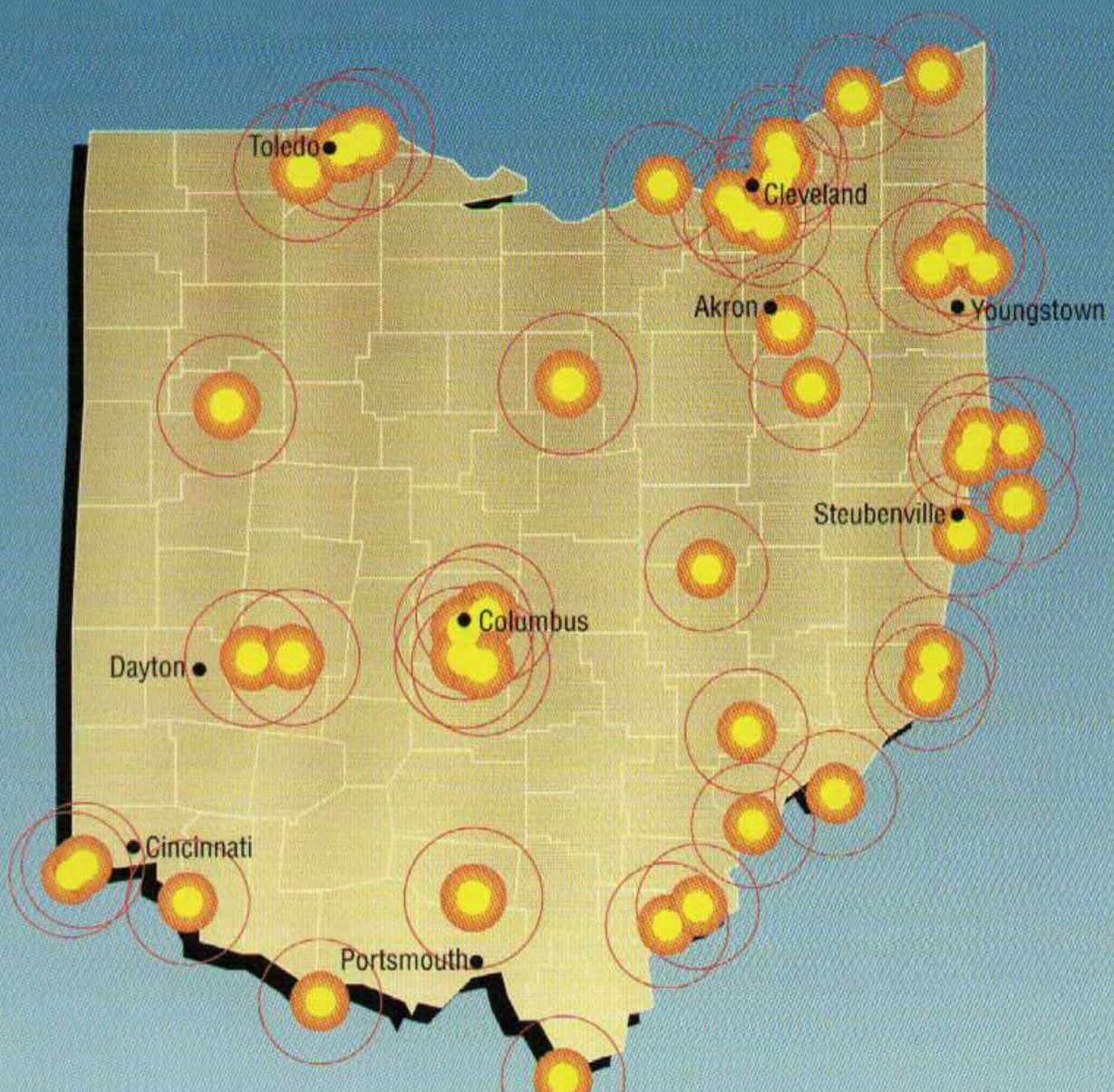
## Nuclear Survival in

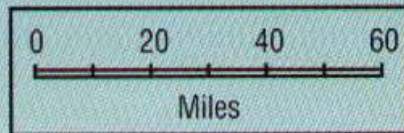
# Ohio

This is the nuclear target map for Ohio, but remember, fallout can go anywhere or everywhere (and probably will). After you have looked at this map look at the [Information for Ohio](#) that follows it.

This link will take you back to the [Index of all the States](#)

## Nuclear Weapon Target Map for Ohio (FEMA-196/September 1990)





## Nuclear Attack



**Red Ring (0.5 to 2 psi):** Up to 25 percent casualties. Light damage to commercial-type buildings, severe damage to small residences.

**Orange Area (2 to 5 psi):** 50 percent casualties. Moderate damage to commercial-type buildings, severe damage to small residences.

**Yellow Area (5 psi or more):** Few survivors. Severe damage to total destruction of buildings.

## Fallout

Fallout radiation is a potential hazard for all localities. See page 123 for more information.

[UPDATE to Target Information!!!](#)

## Information for Ohio

This link will take you back to the [Index of all the States](#)

It is recommended that you go through the following 10 steps in studying about the nuclear threat to Ohio.

1. Look at the [State Map](#) above to see the target nuclear areas in Ohio.
2. Look at the [general expected fallout map](#) to see where Ohio (according to the **prevailing wind pattern**) gets fallout from other states.
3. If the state that you live in is anywhere EAST of any of the following 6 states in the **prevailing wind pattern** then look at the states in **RED** on the [INDEX of](#)

## STATES for

- Montana
- North Dakota
- South Dakota
- Nebraska
- Missouri
- Colorado

These six states contain what is called DENSE PACK which I explain on each of those states pages. **UNDERSTAND** that the wind pattern **COULD** at that time be something other than the "prevailing" wind pattern.

4. Bookmark the present URL or make a copy of this present address so that you can come back to it after going to

[Blast Mapper](#).

This mapper is on someone else's web site so that you will need to save this address in order to return here if your back button doesn't work. However, you want to be sure to go the mapper site and calculate the damage to probable targets (cities) around you.

5. Memorize the THREE top rules for survival. They are:

- Number One - **Get out of the cities!**
- Number Two - **Get out of the cities!**
- Number Three - **Get out of the cities!**

6. The follow-on rules are:

- a. Have a shelter
- b. Work with a group (you are going to need the manpower, brainpower, and skillpower).

- c. Stock supplies.

7. My [Main Survival Page](#) contains links to lots of other information such as free books to download about nuclear survival, links to plans for building shelters, and even free consultation about building a shelter.

8. If you are SUPER concerned about nuclear survival you might consider moving within 20 miles of the

[Ark Two Community](#)  
(in Canada)

9. And finally if you would like to be on the mailing list of the author of this site - send a blank email to:

[arktwo-request@deuce.pairowoodies.com](mailto:arktwo-request@deuce.pairowoodies.com)  
[with the subject as subscribe](#)

**MENU: [HOME](#) » [SURVIVAL](#) » [Index of States](#)**

---

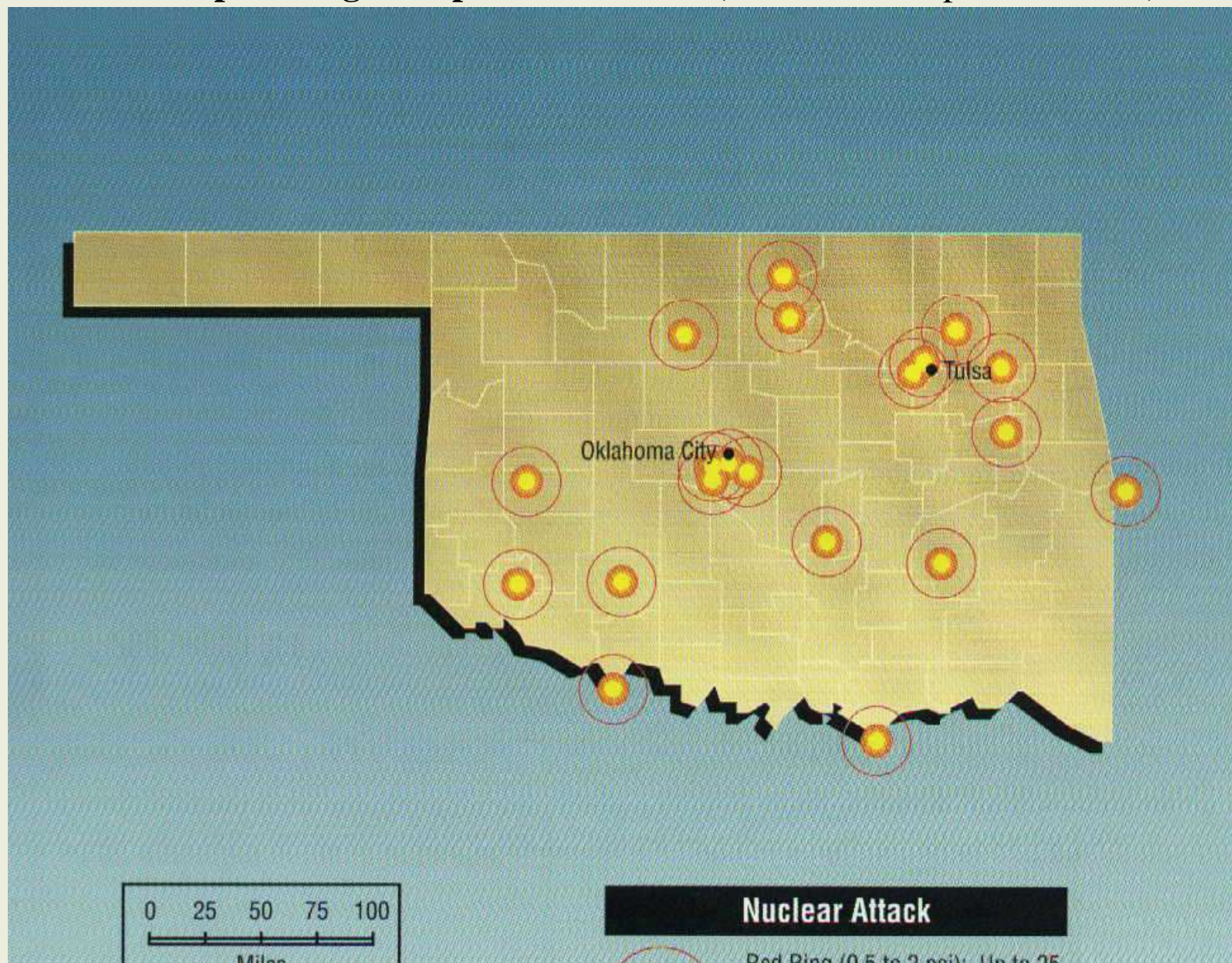
---

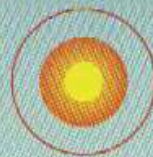
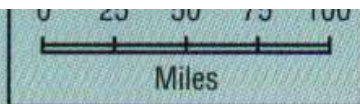
## Nuclear Survival in **Oklahoma**

This is the nuclear target map for Oklahoma, but remember, fallout can go anywhere or everywhere (and probably will). After you have looked at this map look at the [Information for Oklahoma](#) that follows it.

This link will take you back to the [Index of all the States](#)

### **Nuclear Weapon Target Map for Oklahoma (FEMA-196/September 1990)**





## Nuclear Attack

**Red Ring (0.5 to 2 psi):** Up to 25 percent casualties. Light damage to commercial-type buildings, severe damage to small residences.

**Orange Area (2 to 5 psi):** 50 percent casualties. Moderate damage to commercial-type buildings, severe damage to small residences.

**Yellow Area (5 psi or more):** Few survivors. Severe damage to total destruction of buildings.

## Fallout

Fallout radiation is a potential hazard for all localities. See page 123 for more information.

[UPDATE to Target Information!!!](#)

## Information for Oklahoma

This link will take you back to the [Index of all the States](#)

It is recommended that you go through the following 10 steps in studying about the nuclear threat to Oklahoma.

1. Look at the [State Map](#) above to see the target nuclear areas in Oklahoma.
2. Look at the [general expected fallout map](#) to see where Oklahoma (according to the **prevailing wind pattern**) gets fallout from other states.
3. If the state that you live in is anywhere EAST of any of the following 6 states in the **prevailing wind pattern** then look at the states in **RED** on the [INDEX of](#)



## STATES for

- Montana
- North Dakota
- South Dakota
- Nebraska
- Missouri
- Colorado

These six states contain what is called DENSE PACK which I explain on each of those states pages. **UNDERSTAND** that the wind pattern **COULD** at that time be something other than the "prevailing" wind pattern.

4. Bookmark the present URL or make a copy of this present address so that you can come back to it after going to

[Blast Mapper](#).

This mapper is on someone else's web site so that you will need to save this address in order to return here if your back button doesn't work. However, you want to be sure to go the mapper site and calculate the damage to probable targets (cities) around you.

5. Memorize the THREE top rules for survival. They are:

- Number One - **Get out of the cities!**
- Number Two - **Get out of the cities!**
- Number Three - **Get out of the cities!**

6. The follow-on rules are:

- a. Have a shelter
- b. Work with a group (you are going to need the manpower, brainpower, and skillpower).

- c. Stock supplies.

7. My [Main Survival Page](#) contains links to lots of other information such as free books to download about nuclear survival, links to plans for building shelters, and even free consultation about building a shelter.

8. If you are SUPER concerned about nuclear survival you might consider moving within 20 miles of the

[Ark Two Community](#)  
(in Canada)

9. And finally if you would like to be on the mailing list of the author of this site - send a blank email to:

[arktwo-request@deuce.pairowoodies.com](mailto:arktwo-request@deuce.pairowoodies.com)  
[with the subject as subscribe](#)

**MENU: [HOME](#) » [SURVIVAL](#) » [Index of States](#)**

---

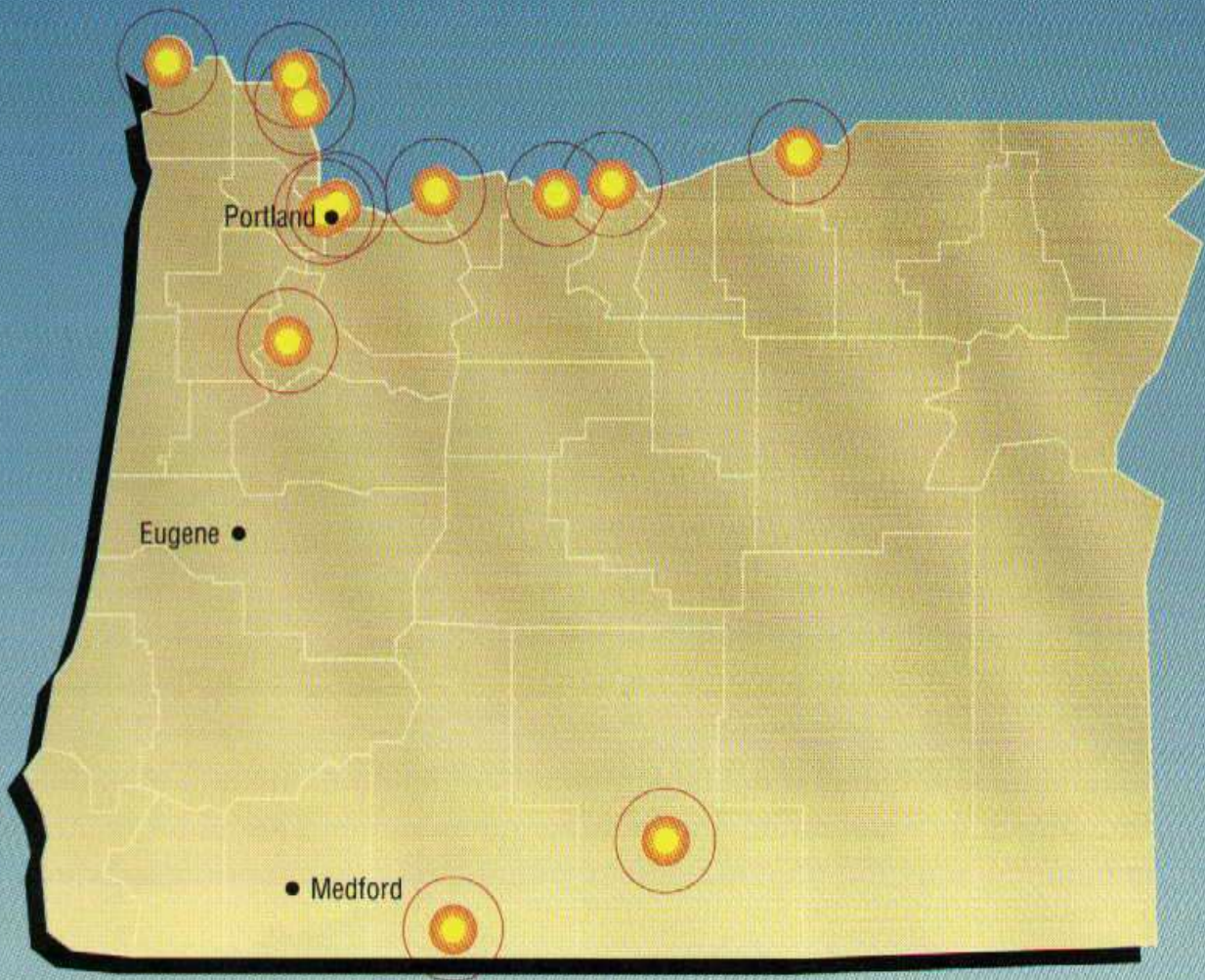
---

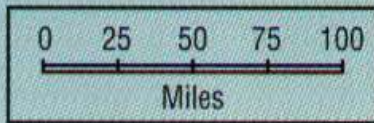
## Nuclear Survival in **Oregon**

This is the nuclear target map for Oregon, but remember, fallout can go anywhere or everywhere (and probably will). After you have looked at this map look at the [Information for Oregon](#) that follows it.

This link will take you back to the [Index of all the States](#)

### **Nuclear Weapon Target Map for Oregon (FEMA-196/September 1990)**





## Nuclear Attack



**Red Ring (0.5 to 2 psi):** Up to 25 percent casualties. Light damage to commercial-type buildings, severe damage to small residences.

**Orange Area (2 to 5 psi):** 50 percent casualties. Moderate damage to commercial-type buildings, severe damage to small residences.

**Yellow Area (5 psi or more):** Few survivors. Severe damage to total destruction of buildings.

## Fallout

Fallout radiation is a potential hazard for all localities. See page 123 for more information.

## [UPDATE to Target Information!!!](#)

## Information for Oregon

This link will take you back to the [Index of all the States](#)

It is recommended that you go through the following 10 steps in studying about the nuclear threat to Oregon.

1. Look at the [State Map](#) above to see the target nuclear areas in Oregon.
2. Look at the [general expected fallout map](#) to see where Oregon (according to the **prevailing wind pattern**) gets fallout from other states.
3. If the state that you live in is anywhere EAST of any of the following 6 states in the **prevailing wind pattern** then look at the states in **RED** on the [INDEX of](#)

## STATES for

- Montana
- North Dakota
- South Dakota
- Nebraska
- Missouri
- Colorado

These six states contain what is called DENSE PACK which I explain on each of those states pages. **UNDERSTAND** that the wind pattern **COULD** at that time be something other than the "prevailing" wind pattern.

4. Bookmark the present URL or make a copy of this present address so that you can come back to it after going to

[Blast Mapper](#).

This mapper is on someone else's web site so that you will need to save this address in order to return here if your back button doesn't work. However, you want to be sure to go the mapper site and calculate the damage to probable targets (cities) around you.

5. Memorize the THREE top rules for survival. They are:

- Number One - **Get out of the cities!**
- Number Two - **Get out of the cities!**
- Number Three - **Get out of the cities!**

6. The follow-on rules are:

- a. Have a shelter
- b. Work with a group (you are going to need the manpower, brainpower, and skillpower).

- c. Stock supplies.

7. My [Main Survival Page](#) contains links to lots of other information such as free books to download about nuclear survival, links to plans for building shelters, and even free consultation about building a shelter.

8. If you are SUPER concerned about nuclear survival you might consider moving within 20 miles of the

[Ark Two Community](#)  
(in Canada)

9. And finally if you would like to be on the mailing list of the author of this site - send a blank email to:

[arktwo-request@deuce.pairowoodies.com](mailto:arktwo-request@deuce.pairowoodies.com)  
[with the subject as subscribe](#)

**MENU: [HOME](#) » [SURVIVAL](#) » [Index of States](#)**

---

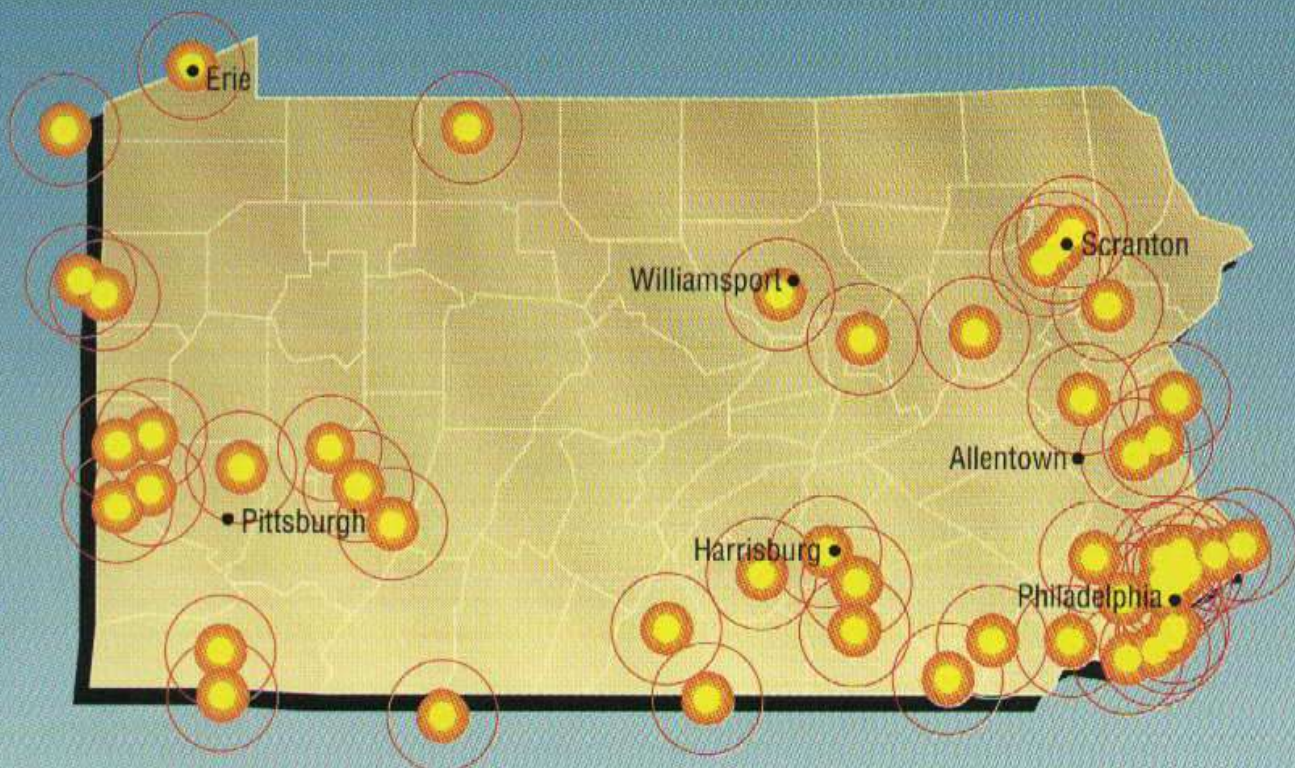
---

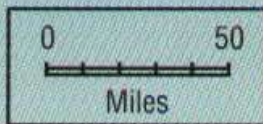
## Nuclear Survival in **Pennsylvania**

This is the nuclear target map for Pennsylvania, but remember, fallout can go anywhere or everywhere (and probably will). After you have looked at this map look at the [Information for Pennsylvania](#) that follows it.

This link will take you back to the [Index of all the States](#)

### **Nuclear Weapon Target Map for Pennsylvania (FEMA-196/September 1990)**





## Nuclear Attack



**Red Ring (0.5 to 2 psi):** Up to 25 percent casualties. Light damage to commercial-type buildings, severe damage to small residences.

**Orange Area (2 to 5 psi):** 50 percent casualties. Moderate damage to commercial-type buildings, severe damage to small residences.

**Yellow Area (5 psi or more):** Few survivors. Severe damage to total destruction of buildings.

## Fallout

Fallout radiation is a potential hazard for all localities. See page 123 for more information.

[UPDATE to Target Information!!!](#)

## Information for Pennsylvania

This link will take you back to the [Index of all the States](#)

It is recommended that you go through the following 10 steps in studying about the nuclear threat to Pennsylvania.

1. Look at the [State Map](#) above to see the target nuclear areas in Pennsylvania.
2. Look at the [general expected fallout map](#) to see where Pennsylvania (according to the **prevailing wind pattern**) gets fallout from other states.
3. If the state that you live in is anywhere EAST of any of the following 6 states in the **prevailing wind pattern** then look at the states in **RED** on the [INDEX of](#)



## STATES for

- Montana
- North Dakota
- South Dakota
- Nebraska
- Missouri
- Colorado

These six states contain what is called DENSE PACK which I explain on each of those states pages. **UNDERSTAND** that the wind pattern **COULD** at that time be something other than the "prevailing" wind pattern.

4. Bookmark the present URL or make a copy of this present address so that you can come back to it after going to

[Blast Mapper.](#)

This mapper is on someone else's web site so that you will need to save this address in order to return here if your back button doesn't work. However, you want to be sure to go the mapper site and calculate the damage to probable targets (cities) around you.

5. Memorize the THREE top rules for survival. They are:

- Number One - **Get out of the cities!**
- Number Two - **Get out of the cities!**
- Number Three - **Get out of the cities!**

6. The follow-on rules are:

- a. Have a shelter
- b. Work with a group (you are going to need the manpower, brainpower, and skillpower).

- c. Stock supplies.

7. My [Main Survival Page](#) contains links to lots of other information such as free books to download about nuclear survival, links to plans for building shelters, and even free consultation about building a shelter.

8. If you are SUPER concerned about nuclear survival you might consider moving within 20 miles of the

[Ark Two Community](#)  
(in Canada)

9. And finally if you would like to be on the mailing list of the author of this site - send a blank email to:

[arktwo-request@deuce.pairowoodies.com](mailto:arktwo-request@deuce.pairowoodies.com)  
[with the subject as subscribe](#)

**MENU: [HOME](#) » [SURVIVAL](#) » [Index of States](#)**

---

---

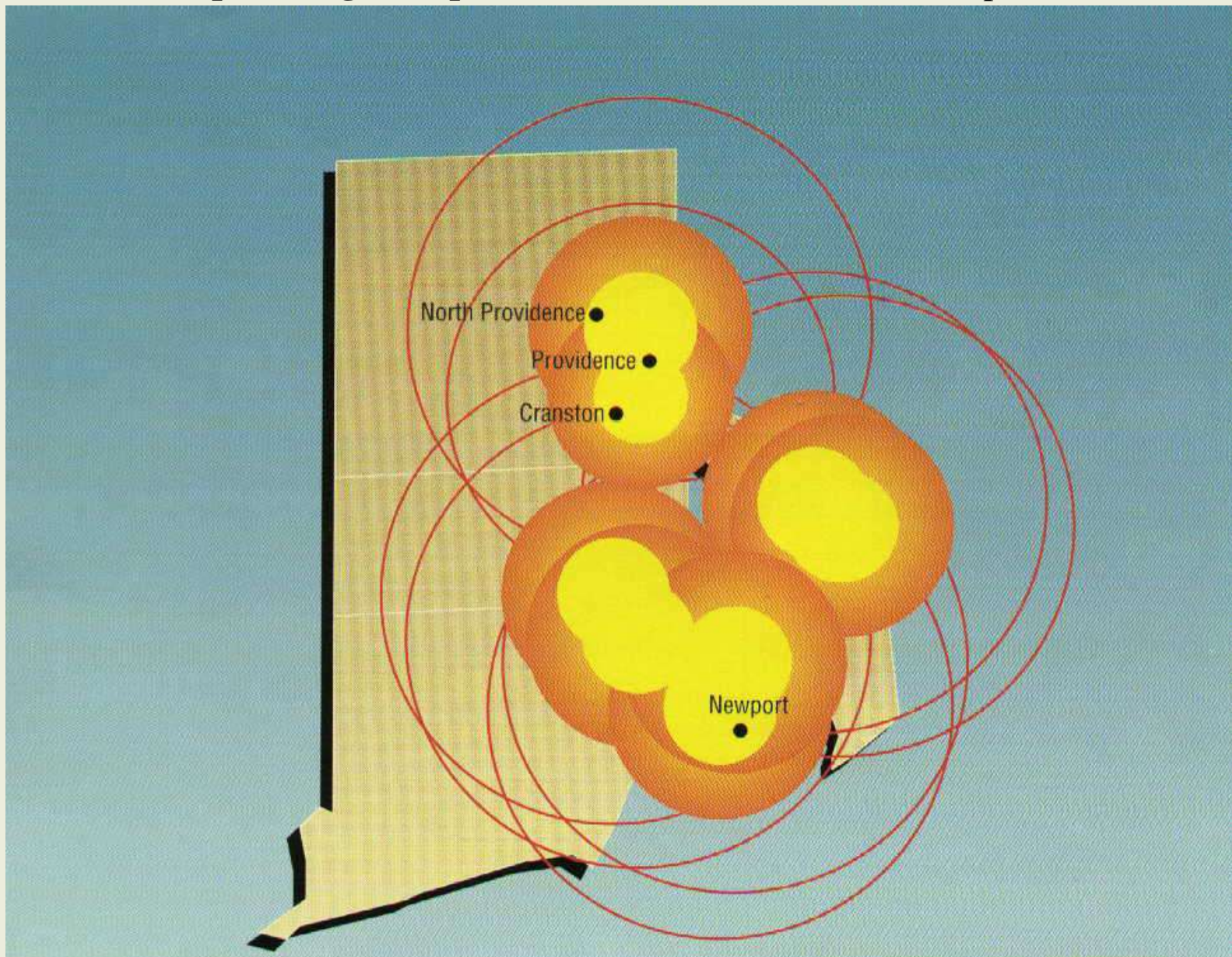
## Nuclear Survival in

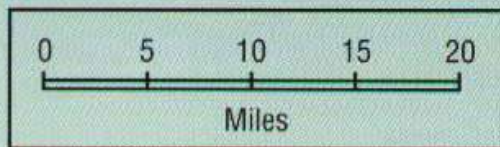
# Rhode Island

This is the nuclear target map for Rhode Island, but remember, fallout can go anywhere or everywhere (and probably will). After you have looked at this map look at the [Information for Rhode Island](#) that follows it.

This link will take you back to the [Index of all the States](#)

### Nuclear Weapon Target Map for Rhode Island (FEMA-196/September 1990)





## Nuclear Attack



Red Ring (0.5 to 2 psi): Up to 25 percent casualties. Light damage to commercial-type buildings, severe damage to small residences.

Orange Area (2 to 5 psi): 50 percent casualties. Moderate damage to commercial-type buildings, severe damage to small residences.

Yellow Area (5 psi or more): Few survivors. Severe damage to total destruction of buildings.

## Fallout

Fallout radiation is a potential hazard for all localities. See page 123 for more information.

[UPDATE to Target Information!!!](#)

## Information for Rhode Island

This link will take you back to the [Index of all the States](#)

It is recommended that you go through the following 10 steps in studying about the nuclear threat to Rhode Island.

1. Look at the [State Map](#) above to see the target nuclear areas in Rhode Island.
2. Look at the [general expected fallout map](#) to see where Rhode Island (according to the **prevailing wind pattern**) gets fallout from other states.
3. If the state that you live in is anywhere EAST of any of the following 6 states in the **prevailing wind pattern** then look at the states in **RED** on the [INDEX of](#)

## STATES for

- Montana
- North Dakota
- South Dakota
- Nebraska
- Missouri
- Colorado

These six states contain what is called DENSE PACK which I explain on each of those states pages. **UNDERSTAND** that the wind pattern **COULD** at that time be something other than the "prevailing" wind pattern.

4. Bookmark the present URL or make a copy of this present address so that you can come back to it after going to

[Blast Mapper.](#)

This mapper is on someone else's web site so that you will need to save this address in order to return here if your back button doesn't work. However, you want to be sure to go the mapper site and calculate the damage to probable targets (cities) around you.

5. Memorize the THREE top rules for survival. They are:

- Number One - **Get out of the cities!**
- Number Two - **Get out of the cities!**
- Number Three - **Get out of the cities!**

6. The follow-on rules are:

- a. Have a shelter
- b. Work with a group (you are going to need the manpower, brainpower, and skillpower).

- c. Stock supplies.

7. My [Main Survival Page](#) contains links to lots of other information such as free books to download about nuclear survival, links to plans for building shelters, and even free consultation about building a shelter.

8. If you are SUPER concerned about nuclear survival you might consider moving within 20 miles of the

[Ark Two Community](#)  
(in Canada)

9. And finally if you would like to be on the mailing list of the author of this site - send a blank email to:

[arktwo-request@deuce.pairowoodies.com](mailto:arktwo-request@deuce.pairowoodies.com)  
[with the subject as subscribe](#)

**MENU: [HOME](#) » [SURVIVAL](#) » [Index of States](#)**

---

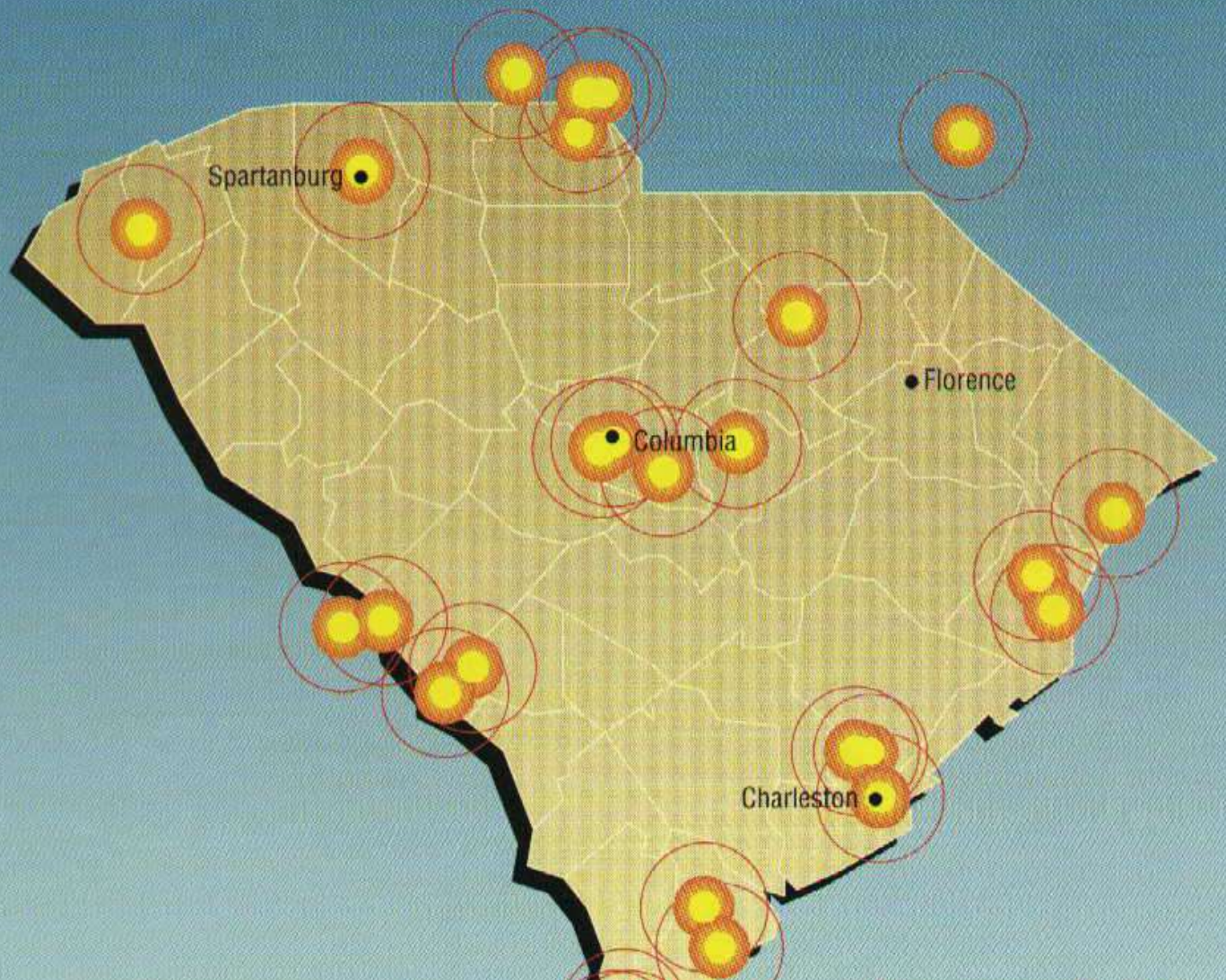
---

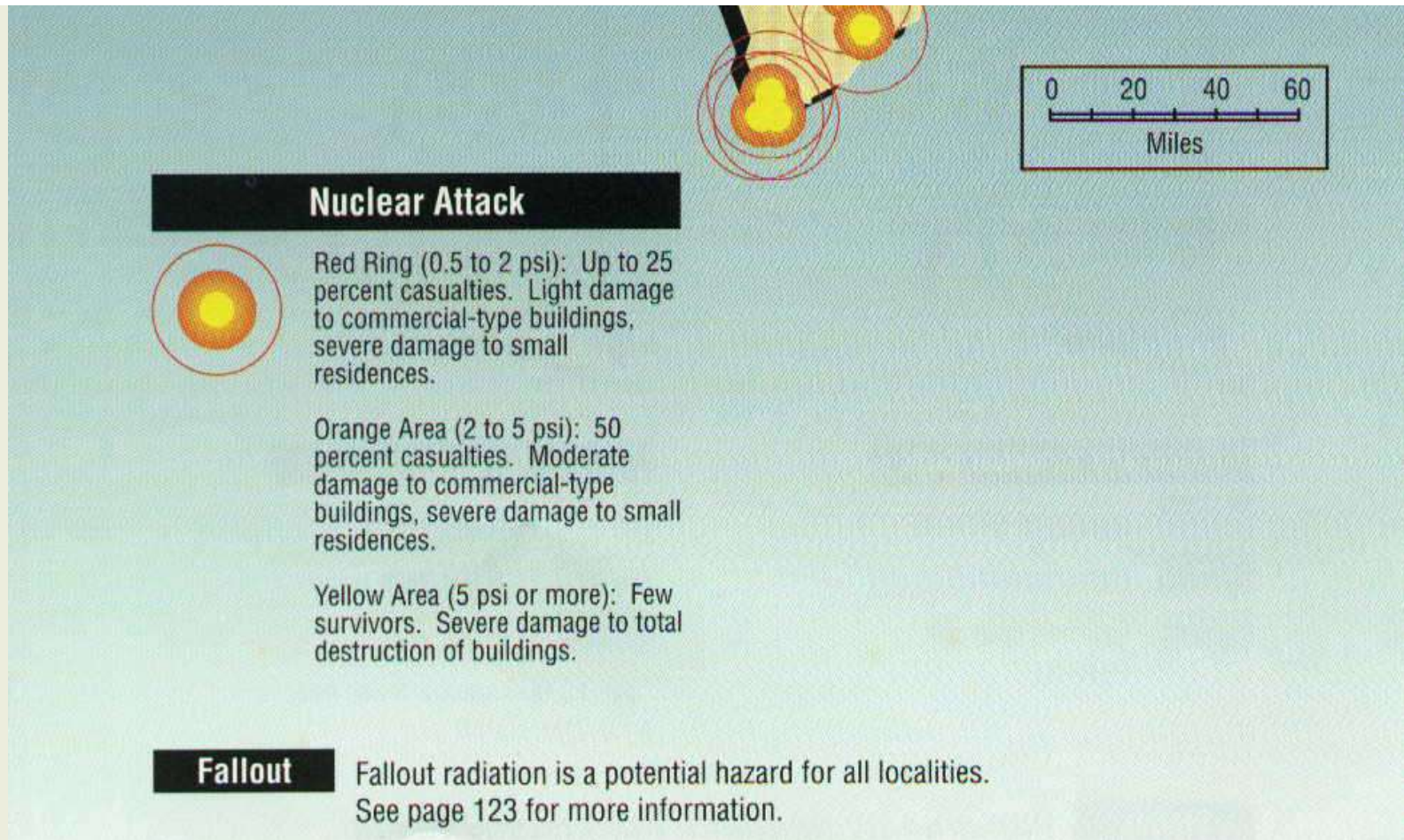
## Nuclear Survival in **South Carolina**

This is the nuclear target map for South Carolina, but remember, fallout can go anywhere or everywhere (and probably will). After you have looked at this map look at the [Information for South Carolina](#) that follows it.

This link will take you back to the [Index of all the States](#)

**Nuclear Weapon Target Map for South Carolina (FEMA-196/September 1990)**





[UPDATE to Target Information!!!](#)

**Information for South Carolina**

This link will take you back to the [Index of all the States](#)

It is recommended that you go through the following 10 steps in studying about the nuclear threat to South Carolina.

1. Look at the [State Map](#) above to see the target nuclear areas in South Carolina.
2. Look at the [general expected fallout map](#) to see where South Carolina (according to the **prevailing wind pattern**) gets fallout from other states.
3. If the state that you live in is anywhere EAST of any of the following 6 states in the **prevailing wind pattern** then look at the states in **RED** on the [INDEX of](#)



## STATES for

- Montana
- North Dakota
- South Dakota
- Nebraska
- Missouri
- Colorado

These six states contain what is called DENSE PACK which I explain on each of those states pages. **UNDERSTAND** that the wind pattern **COULD** at that time be something other than the "prevailing" wind pattern.

4. Bookmark the present URL or make a copy of this present address so that you can come back to it after going to

[Blast Mapper](#).

This mapper is on someone else's web site so that you will need to save this address in order to return here if your back button doesn't work. However, you want to be sure to go the mapper site and calculate the damage to probable targets (cities) around you.

5. Memorize the THREE top rules for survival. They are:

- Number One - **Get out of the cities!**
- Number Two - **Get out of the cities!**
- Number Three - **Get out of the cities!**

6. The follow-on rules are:

- a. Have a shelter
- b. Work with a group (you are going to need the manpower, brainpower, and skillpower).

- c. Stock supplies.

7. My [Main Survival Page](#) contains links to lots of other information such as free books to download about nuclear survival, links to plans for building shelters, and even free consultation about building a shelter.

8. If you are SUPER concerned about nuclear survival you might consider moving within 20 miles of the

[Ark Two Community](#)  
(in Canada)

9. And finally if you would like to be on the mailing list of the author of this site - send a blank email to:

[arktwo-request@deuce.pairowoodies.com](mailto:arktwo-request@deuce.pairowoodies.com)  
[with the subject as subscribe](#)

**MENU: [HOME](#) » [SURVIVAL](#) » [Index of States](#)**

---

---

## Nuclear Survival in

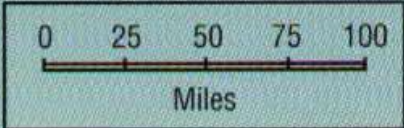
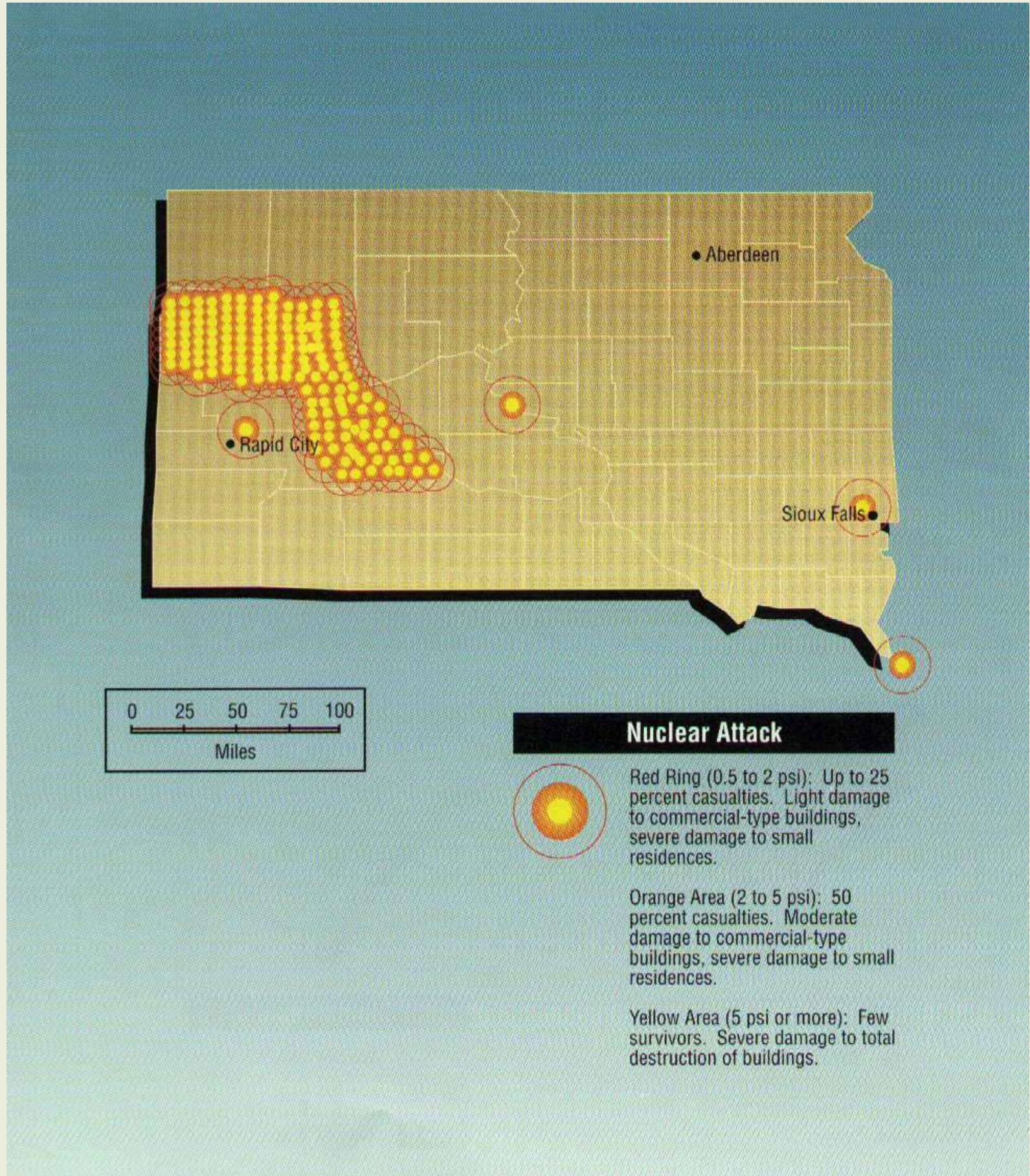
# South Dakota

This is the nuclear target map for South Dakota, but remember, fallout can go anywhere or everywhere (and probably will). After you have looked at this map look at the [Information for South Dakota](#) that follows it.

***DENSE PACK** - Look at all those target sites. So close Together! It serves a purpose. It is missiles protecting missiles, and this is how it is done. These are "hardened" sites. Meaning it takes a direct ground explosion to dig them out. An air burst will not do it. When you have a ground explosion it throws many tons of dust and sand up into the air. High into the air. This is what will later become fallout carried by the winds hundreds, sometimes thousands, of miles away. But right over that site that has just been hit the sand and grit in the air is very thick for quite a while. Another high speed missile (ICBM) trying to come through it will have its skin torn off just like by sand blasting and it will be destroyed. So the other missile sites nearby are safe. On the other hand, because missiles take off much slower than the speeds they eventually reach, the missiles in the undamaged silos can still be launched and will pass through the dust cloud without be harmed. Neat, eh? See there is a purpose in putting so many in one place. Now the only way that you can dig them out is with what is called a slow walk. Hit a target. Move on further and hit another target where the dust from the first won't hurt you. Come back thirty or forty-five minutes later and hit a second target near where you hit the first, after the cloud has had time to blow away. A slow process. Some silos will already have launched and you will waste the shot. Others can still wait to launch later because you can only get one at a time. This could go on for days. Neat. The military missiles protecting missiles. But they don't protect you, because if you are downwind you will get the fallout. Fatal if you are not in a shelter. They call it Defense but it is only Destruction. Nothing here defends or protects you, if they are used.*

This link will take you back to the [Index of all the States](#)

## Nuclear Weapon Target Map for South Dakota (FEMA-196/September 1990)



### Nuclear Attack



**Red Ring (0.5 to 2 psi):** Up to 25 percent casualties. Light damage to commercial-type buildings, severe damage to small residences.

**Orange Area (2 to 5 psi):** 50 percent casualties. Moderate damage to commercial-type buildings, severe damage to small residences.

**Yellow Area (5 psi or more):** Few survivors. Severe damage to total destruction of buildings.

## Fallout

Fallout radiation is a potential hazard for all localities.  
See page 123 for more information.

[UPDATE to Target Information!!!](#)

## Information for South Dakota

This link will take you back to the [Index of all the States](#)

It is recommended that you go through the following 10 steps in studying about the nuclear threat to South Dakota.

1. Look at the [State Map](#) above to see the target nuclear areas in South Dakota.
2. Look at the [general expected fallout map](#) to see where South Dakota (according to the **prevailing wind pattern**) gets fallout from other states.
3. If the state that you live in is anywhere EAST of any of the following 6 states in the **prevailing wind pattern** then look at the states in **RED** on the [INDEX of STATES](#) for

- **Montana**
- **North Dakota**
- **South Dakota**
- **Nebraska**
- **Missouri**
- **Colorado**

These six states contain what is called DENSE PACK which I explain on each of those states pages. **UNDERSTAND** that the wind pattern **COULD** at that time be

something other than the "prevailing" wind pattern.

4. Bookmark the present URL or make a copy of this present address so that you can come back to it after going to

[Blast Mapper](#).

This mapper is on someone else's web site so that you will need to save this address in order to return here if your back button doesn't work. However, you want to be sure to go the mapper site and calculate the damage to probable targets (cities) around you.

5. Memorize the THREE top rules for survival. They are:

- Number One - **Get out of the cities!**
- Number Two - **Get out of the cities!**
- Number Three - **Get out of the cities!**

6. The follow-on rules are:

- a. Have a shelter
- b. Work with a group (you are going to need the manpower, brainpower, and skillpower).
- c. Stock supplies.

7. My [Main Survival Page](#) contains links to lots of other information such as free books to download about nuclear survival, links to plans for building shelters, and even free consultation about building a shelter.

8. If you are SUPER concerned about nuclear survival you might consider moving within 20 miles of the

[Ark Two Community](#)  
(in Canada)

9. And finally if you would like to be on the mailing list of the author of this site - send a blank email to:

[arktwo-request@deuce.pairowoodies.com](mailto:arktwo-request@deuce.pairowoodies.com)  
with the subject as subscribe

**MENU: [HOME](#) » [SURVIVAL](#) » [Index of States](#)**

---

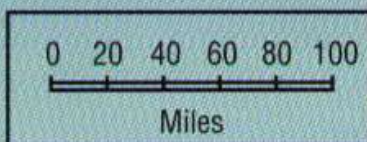
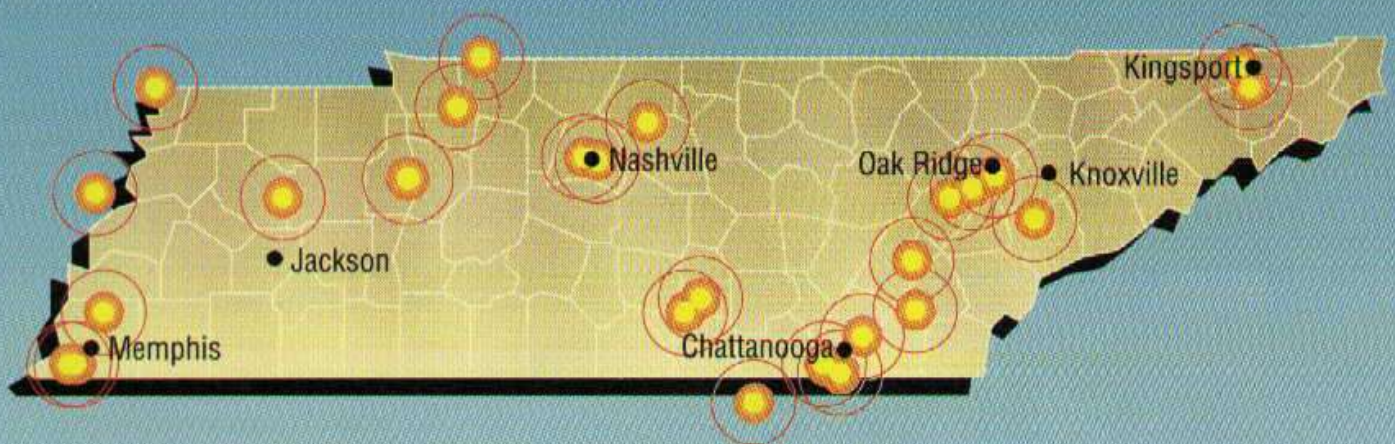
---

## Nuclear Survival in **Tennessee**

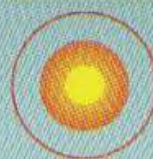
This is the nuclear target map for Tennessee, but remember, fallout can go anywhere or everywhere (and probably will). After you have looked at this map look at the [Information for Tennessee](#) that follows it.

This link will take you back to the [Index of all the States](#)

### **Nuclear Weapon Target Map for Tennessee (FEMA-196/September 1990)**



#### **Nuclear Attack**



Red Ring (0.5 to 2 psi): Up to 25 percent casualties. Light damage to commercial-type buildings, severe damage to small residences.



to commercial-type buildings,  
severe damage to small  
residences.

Orange Area (2 to 5 psi): 50  
percent casualties. Moderate  
damage to commercial-type  
buildings, severe damage to small  
residences.

Yellow Area (5 psi or more): Few  
survivors. Severe damage to total  
destruction of buildings.

### Fallout

Fallout radiation is a potential hazard for all localities.  
See page 123 for more information.

## [UPDATE to Target Information!!!](#)

### Information for Tennessee

This link will take you back to the [Index of all the States](#)

It is recommended that you go through the following 10 steps in studying about the nuclear threat to Tennessee.

1. Look at the [State Map](#) above to see the target nuclear areas in Tennessee.
2. Look at the [general expected fallout map](#) to see where Tennessee (according to the **prevailing wind pattern**) gets fallout from other states.
3. If the state that you live in is anywhere EAST of any of the following 6 states in the **prevailing wind pattern** then look at the states in **RED** on the [INDEX of](#)

## STATES for

- Montana
- North Dakota
- South Dakota
- Nebraska
- Missouri
- Colorado

These six states contain what is called DENSE PACK which I explain on each of those states pages. **UNDERSTAND** that the wind pattern **COULD** at that time be something other than the "prevailing" wind pattern.

4. Bookmark the present URL or make a copy of this present address so that you can come back to it after going to

[Blast Mapper](#).

This mapper is on someone else's web site so that you will need to save this address in order to return here if your back button doesn't work. However, you want to be sure to go the mapper site and calculate the damage to probable targets (cities) around you.

5. Memorize the THREE top rules for survival. They are:

- Number One - **Get out of the cities!**
- Number Two - **Get out of the cities!**
- Number Three - **Get out of the cities!**

6. The follow-on rules are:

- a. Have a shelter
- b. Work with a group (you are going to need the manpower, brainpower, and skillpower).

- c. Stock supplies.

7. My [Main Survival Page](#) contains links to lots of other information such as free books to download about nuclear survival, links to plans for building shelters, and even free consultation about building a shelter.

8. If you are SUPER concerned about nuclear survival you might consider moving within 20 miles of the

[Ark Two Community](#)  
(in Canada)

9. And finally if you would like to be on the mailing list of the author of this site - send a blank email to:

[arktwo-request@deuce.pairowoodies.com](mailto:arktwo-request@deuce.pairowoodies.com)  
[with the subject as subscribe](#)

**MENU: [HOME](#) » [SURVIVAL](#) » [Index of States](#)**

---

---

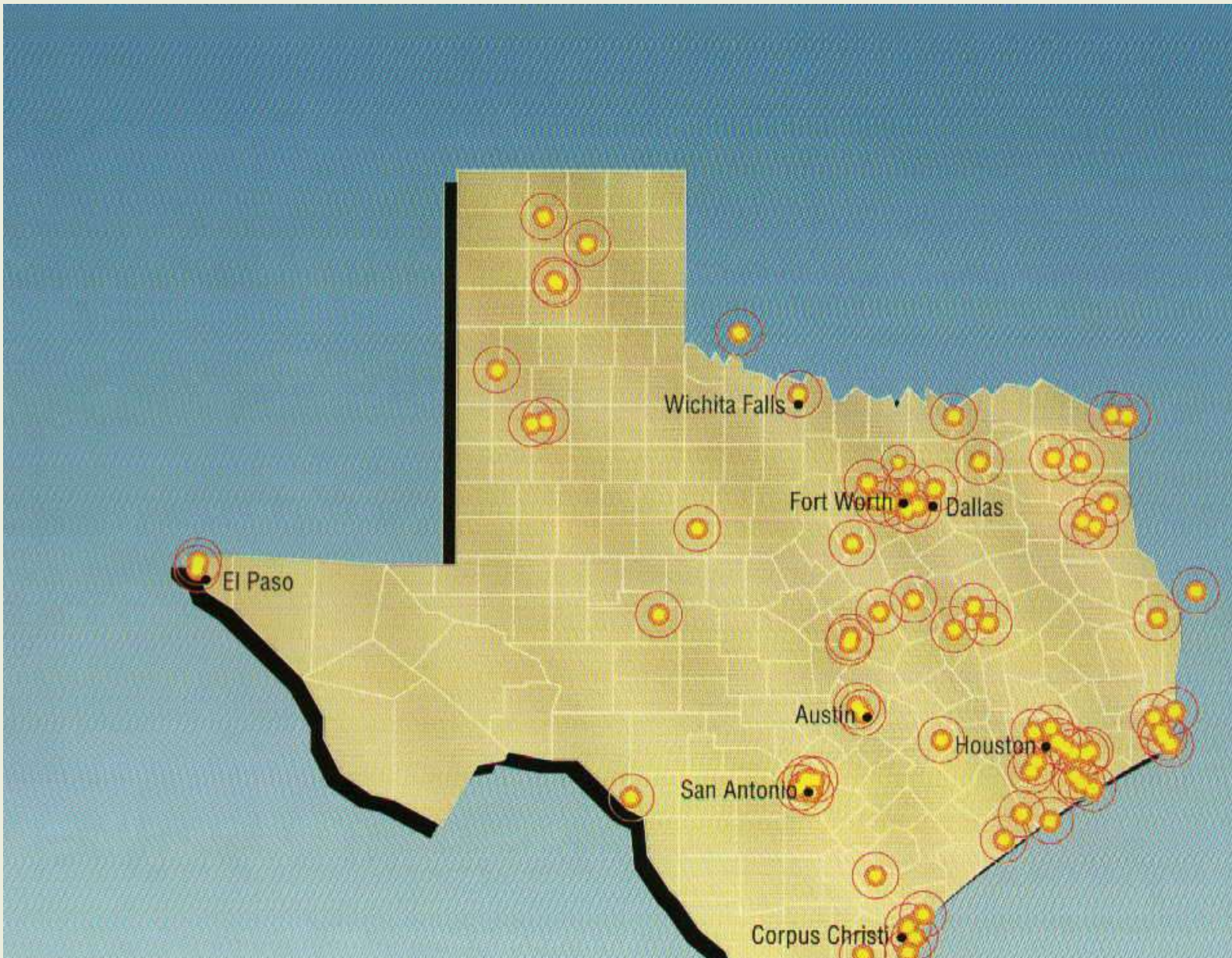
## Nuclear Survival in

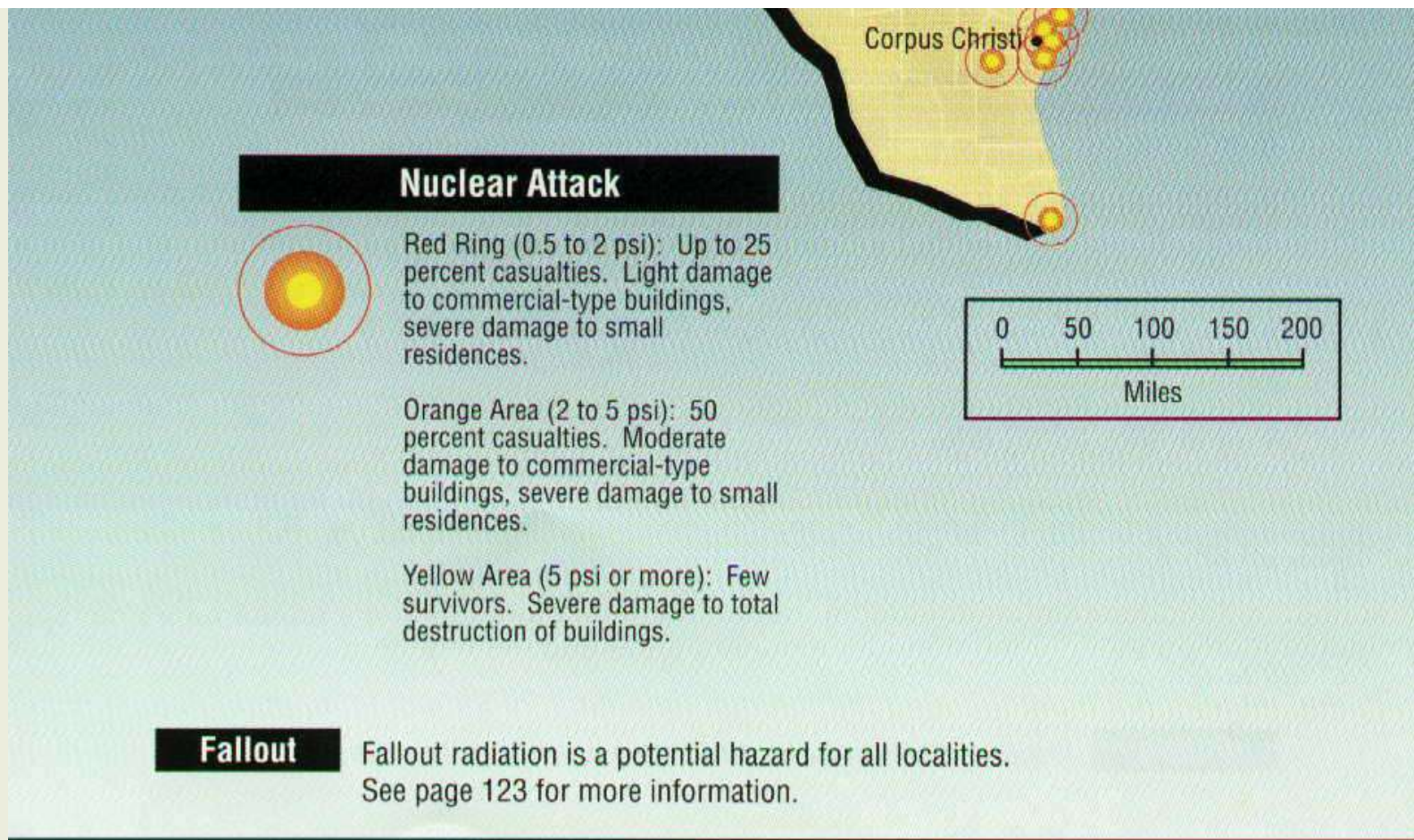
# Texas

This is the nuclear target map for Texas, but remember, fallout can go anywhere or everywhere (and probably will). After you have looked at this map look at the [Information for Texas](#) that follows it.

This link will take you back to the [Index of all the States](#)

## Nuclear Weapon Target Map for Texas (FEMA-196/September 1990)





[UPDATE to Target Information!!!](#)

## Information for Texas

This link will take you back to the [Index of all the States](#)

It is recommended that you go through the following 10 steps in studying about the nuclear threat to Texas.

1. Look at the [State Map](#) above to see the target nuclear areas in Texas.
2. Look at the [general expected fallout map](#) to see where Texas (according to the **prevailing wind pattern**) gets fallout from other states.
3. If the state that you live in is anywhere EAST of any of the following 6 states in the **prevailing wind pattern** then look at the states in **RED** on the [INDEX of](#)

## STATES for

- Montana
- North Dakota
- South Dakota
- Nebraska
- Missouri
- Colorado

These six states contain what is called DENSE PACK which I explain on each of those states pages. **UNDERSTAND** that the wind pattern **COULD** at that time be something other than the "prevailing" wind pattern.

4. Bookmark the present URL or make a copy of this present address so that you can come back to it after going to

[Blast Mapper](#).

This mapper is on someone else's web site so that you will need to save this address in order to return here if your back button doesn't work. However, you want to be sure to go the mapper site and calculate the damage to probable targets (cities) around you.

5. Memorize the THREE top rules for survival. They are:

- Number One - **Get out of the cities!**
- Number Two - **Get out of the cities!**
- Number Three - **Get out of the cities!**

6. The follow-on rules are:

- a. Have a shelter
- b. Work with a group (you are going to need the manpower, brainpower, and skillpower).

- c. Stock supplies.

7. My [Main Survival Page](#) contains links to lots of other information such as free books to download about nuclear survival, links to plans for building shelters, and even free consultation about building a shelter.

8. If you are SUPER concerned about nuclear survival you might consider moving within 20 miles of the

[Ark Two Community](#)  
(in Canada)

9. And finally if you would like to be on the mailing list of the author of this site - send a blank email to:

[arktwo-request@deuce.pairowoodies.com](mailto:arktwo-request@deuce.pairowoodies.com)  
[with the subject as subscribe](#)

**MENU: [HOME](#) » [SURVIVAL](#) » [Index of States](#)**

---

---

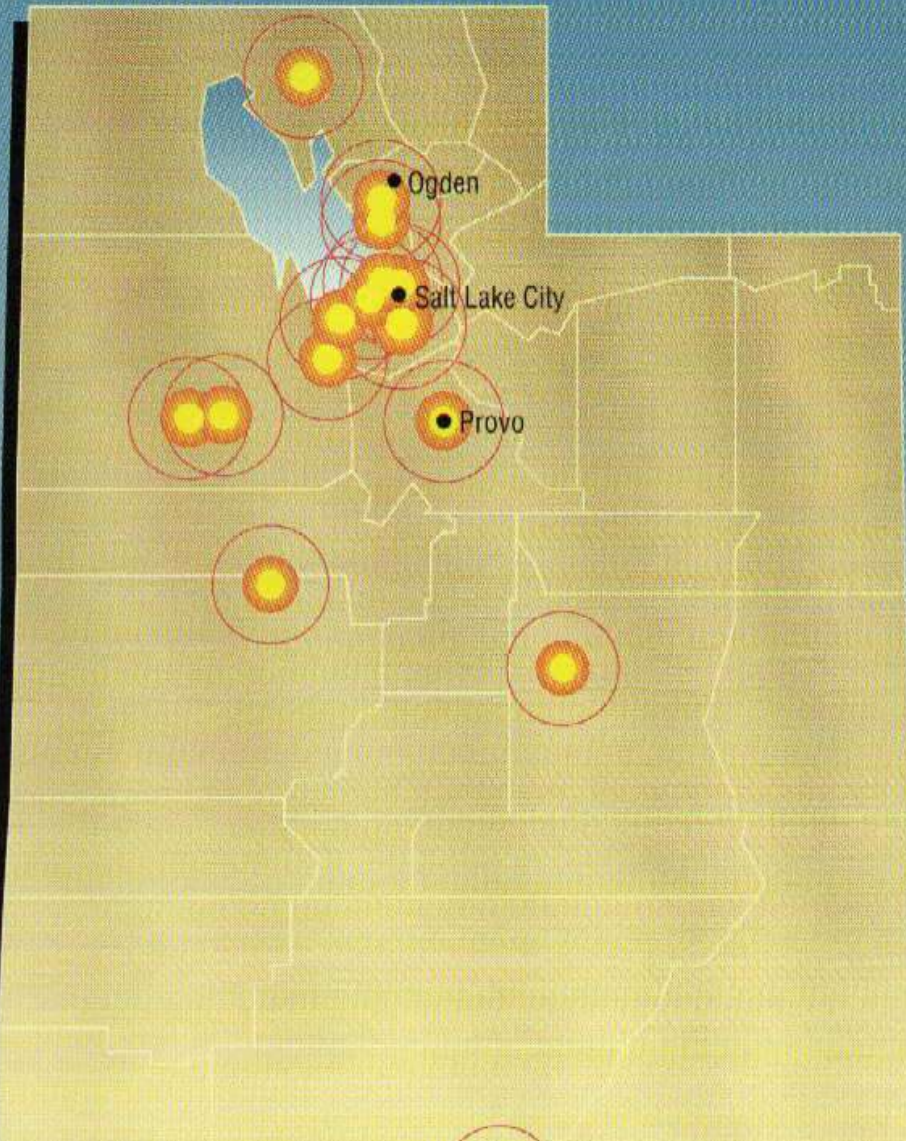
## Nuclear Survival in

# Utah

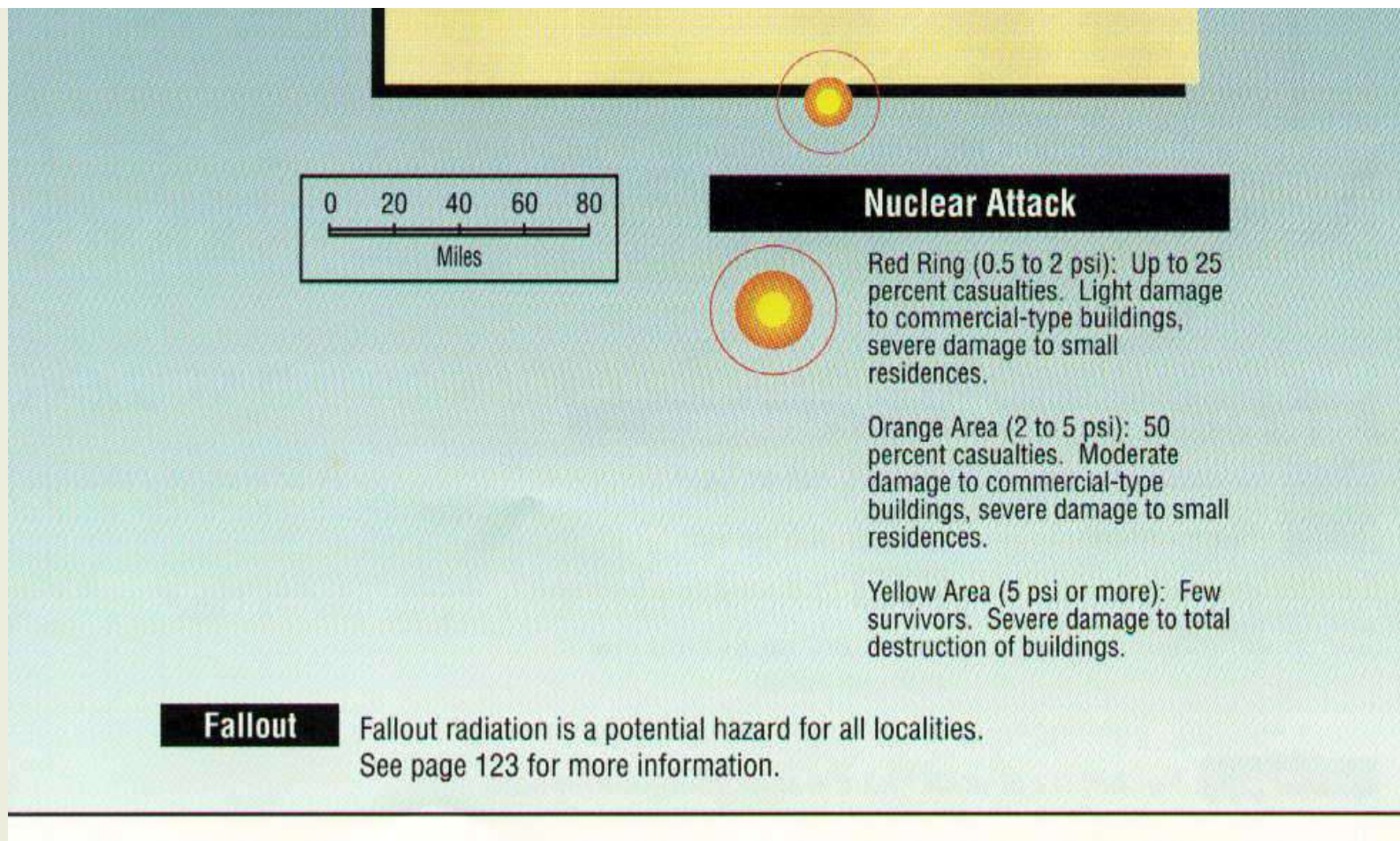
This is the nuclear target map for Utah, but remember, fallout can go anywhere or everywhere (and probably will). After you have looked at this map look at the [Information for Utah](#) that follows it.

This link will take you back to the [Index of all the States](#)

## Nuclear Weapon Target Map for Utah (FEMA-196/September 1990)







[UPDATE to Target Information!!!](#)

## Information for Utah

This link will take you back to the [Index of all the States](#)

It is recommended that you go through the following 10 steps in studying about the nuclear threat to Utah.

1. Look at the [State Map](#) above to see the target nuclear areas in Utah.
2. Look at the [general expected fallout map](#) to see where Utah (according to the **prevailing wind pattern**) gets fallout from other states.
3. If the state that you live in is anywhere EAST of any of the following 6 states in the **prevailing wind pattern** then look at the states in **RED** on the [INDEX of](#)

## STATES for

- Montana
- North Dakota
- South Dakota
- Nebraska
- Missouri
- Colorado

These six states contain what is called DENSE PACK which I explain on each of those states pages. **UNDERSTAND** that the wind pattern **COULD** at that time be something other than the "prevailing" wind pattern.

4. Bookmark the present URL or make a copy of this present address so that you can come back to it after going to

[Blast Mapper](#).

This mapper is on someone else's web site so that you will need to save this address in order to return here if your back button doesn't work. However, you want to be sure to go the mapper site and calculate the damage to probable targets (cities) around you.

5. Memorize the THREE top rules for survival. They are:

- Number One - **Get out of the cities!**
- Number Two - **Get out of the cities!**
- Number Three - **Get out of the cities!**

6. The follow-on rules are:

- a. Have a shelter
- b. Work with a group (you are going to need the manpower, brainpower, and skillpower).

- c. Stock supplies.

7. My [Main Survival Page](#) contains links to lots of other information such as free books to download about nuclear survival, links to plans for building shelters, and even free consultation about building a shelter.

8. If you are SUPER concerned about nuclear survival you might consider moving within 20 miles of the

[Ark Two Community](#)  
(in Canada)

9. And finally if you would like to be on the mailing list of the author of this site - send a blank email to:

[arktwo-request@deuce.pairowoodies.com](mailto:arktwo-request@deuce.pairowoodies.com)  
[with the subject as subscribe](#)

**MENU: [HOME](#) » [SURVIVAL](#) » [Index of States](#)**

---

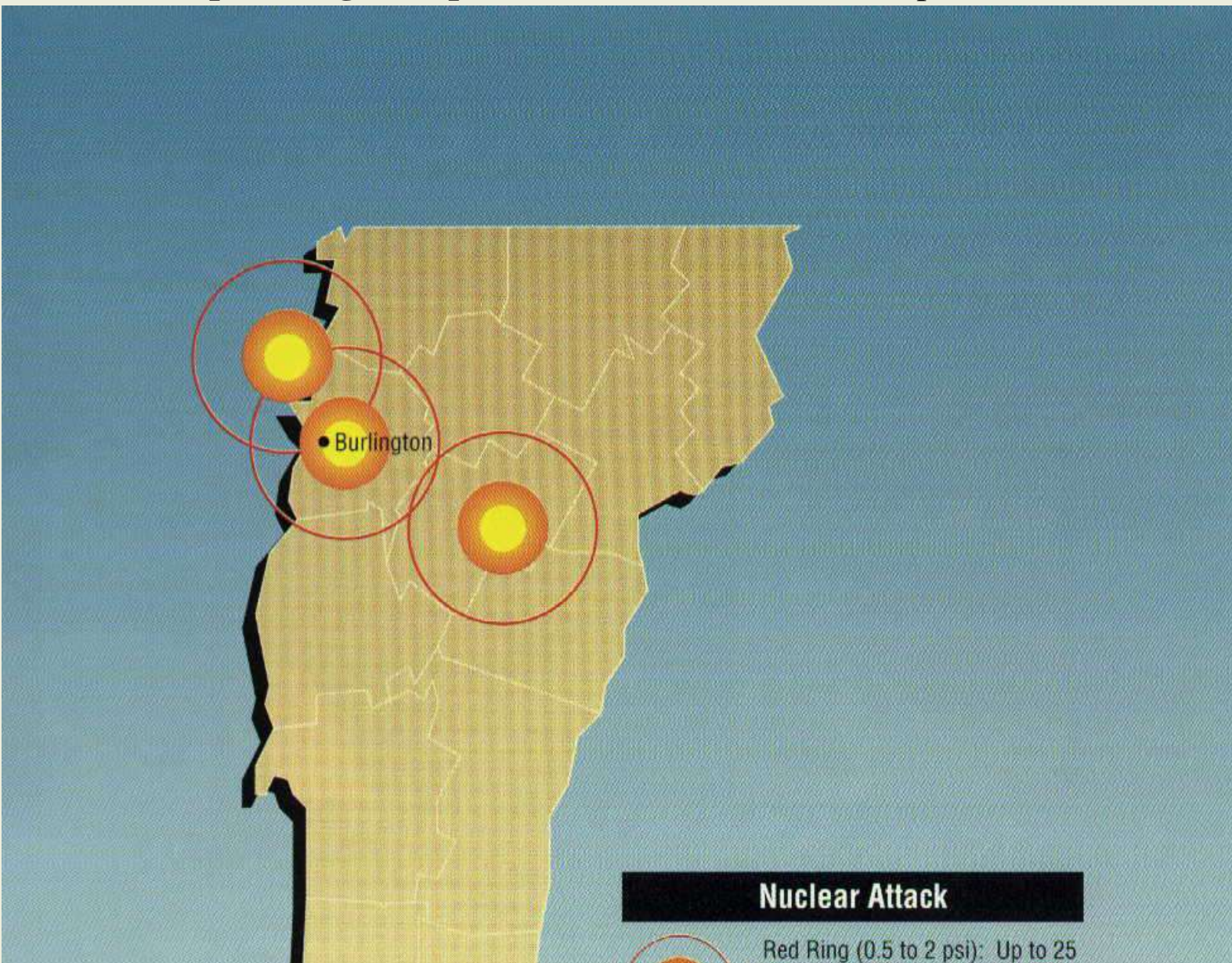
---

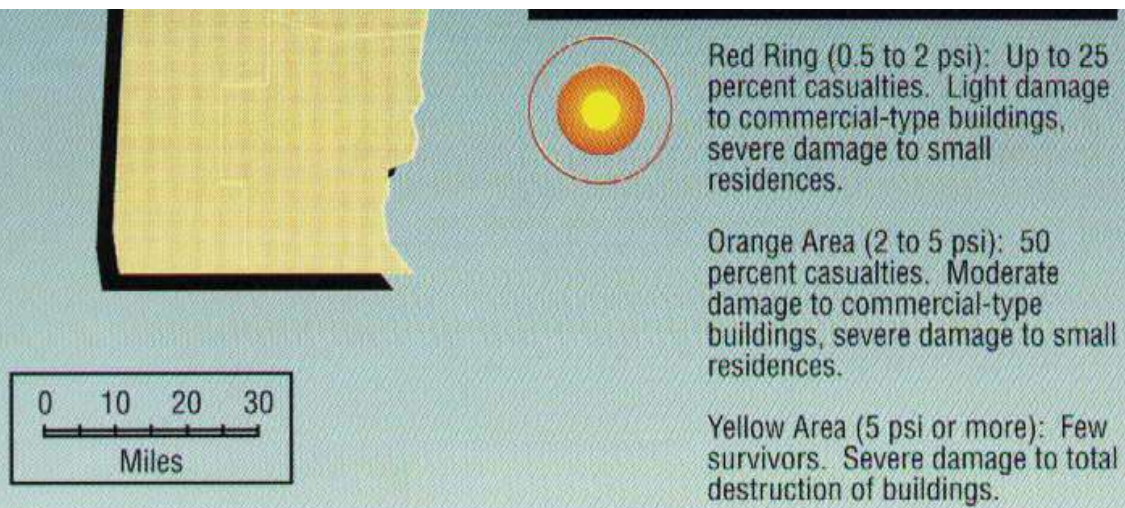
## Nuclear Survival in **Vermont**

This is the nuclear target map for Vermont, but remember, fallout can go anywhere or everywhere (and probably will). After you have looked at this map look at the [Information for Vermont](#) that follows it.

This link will take you back to the [Index of all the States](#)

### **Nuclear Weapon Target Map for Vermont (FEMA-196/September 1990)**





### Fallout

Fallout radiation is a potential hazard for all localities. See page 123 for more information.

[UPDATE to Target Information!!!](#)

## Information for Vermont

This link will take you back to the [Index of all the States](#)

It is recommended that you go through the following 10 steps in studying about the nuclear threat to Vermont.

1. Look at the [State Map](#) above to see the target nuclear areas in Vermont.
2. Look at the [general expected fallout map](#) to see where Vermont (according to the **prevailing wind pattern**) gets fallout from other states.
3. If the state that you live in is anywhere EAST of any of the following 6 states in the **prevailing wind pattern** then look at the states in **RED** on the [INDEX of](#)

## STATES for

- Montana
- North Dakota
- South Dakota
- Nebraska
- Missouri
- Colorado

These six states contain what is called DENSE PACK which I explain on each of those states pages. **UNDERSTAND** that the wind pattern **COULD** at that time be something other than the "prevailing" wind pattern.

4. Bookmark the present URL or make a copy of this present address so that you can come back to it after going to

[Blast Mapper](#).

This mapper is on someone else's web site so that you will need to save this address in order to return here if your back button doesn't work. However, you want to be sure to go the mapper site and calculate the damage to probable targets (cities) around you.

5. Memorize the THREE top rules for survival. They are:

- Number One - **Get out of the cities!**
- Number Two - **Get out of the cities!**
- Number Three - **Get out of the cities!**

6. The follow-on rules are:

- a. Have a shelter
- b. Work with a group (you are going to need the manpower, brainpower, and skillpower).

- c. Stock supplies.

7. My [Main Survival Page](#) contains links to lots of other information such as free books to download about nuclear survival, links to plans for building shelters, and even free consultation about building a shelter.

8. If you are SUPER concerned about nuclear survival you might consider moving within 20 miles of the

[Ark Two Community](#)  
(in Canada)

9. And finally if you would like to be on the mailing list of the author of this site - send a blank email to:

[arktwo-request@deuce.pairowoodies.com](mailto:arktwo-request@deuce.pairowoodies.com)  
[with the subject as subscribe](#)

**MENU: [HOME](#) » [SURVIVAL](#) » [Index of States](#)**

---

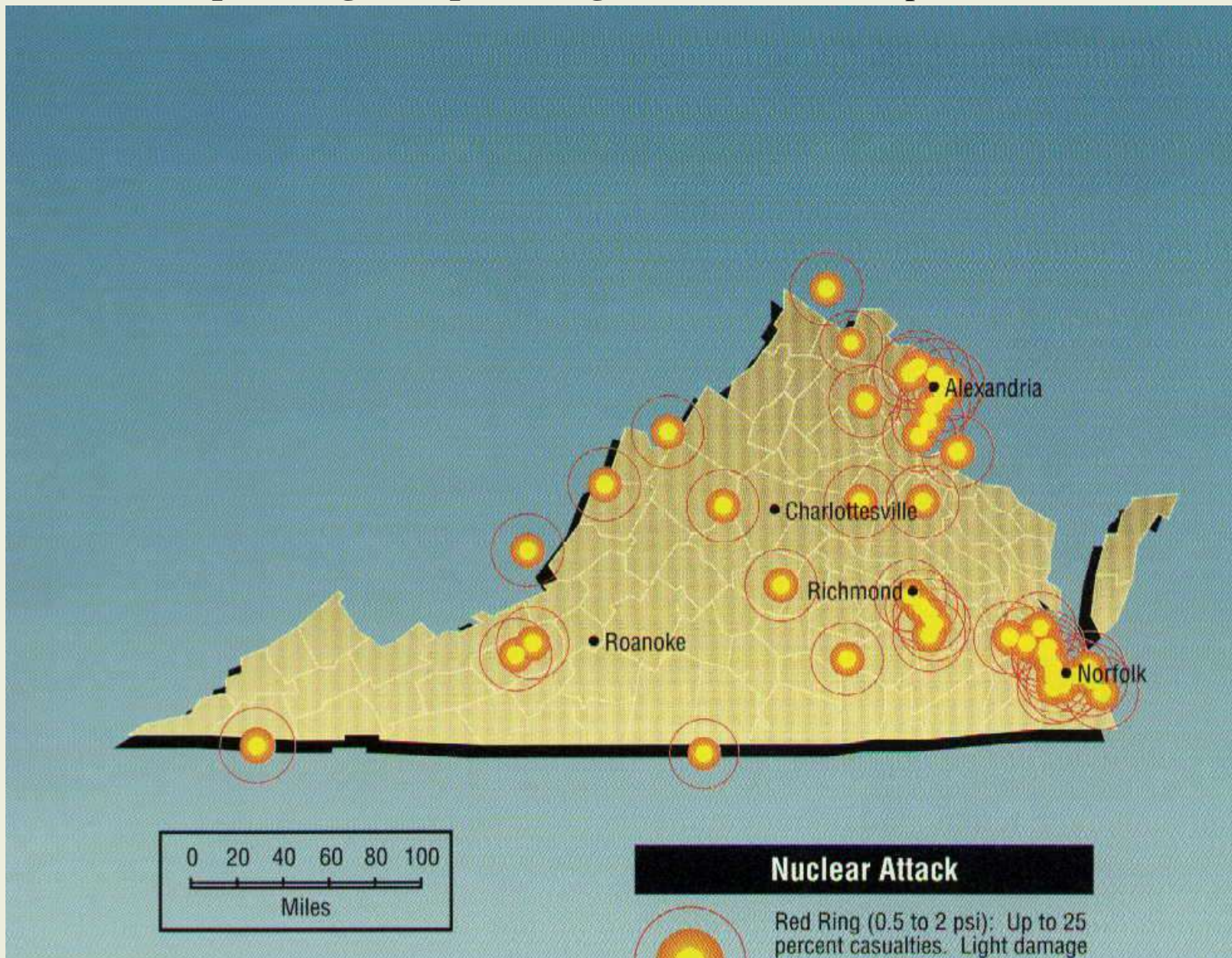
---

## Nuclear Survival in **Virginia**

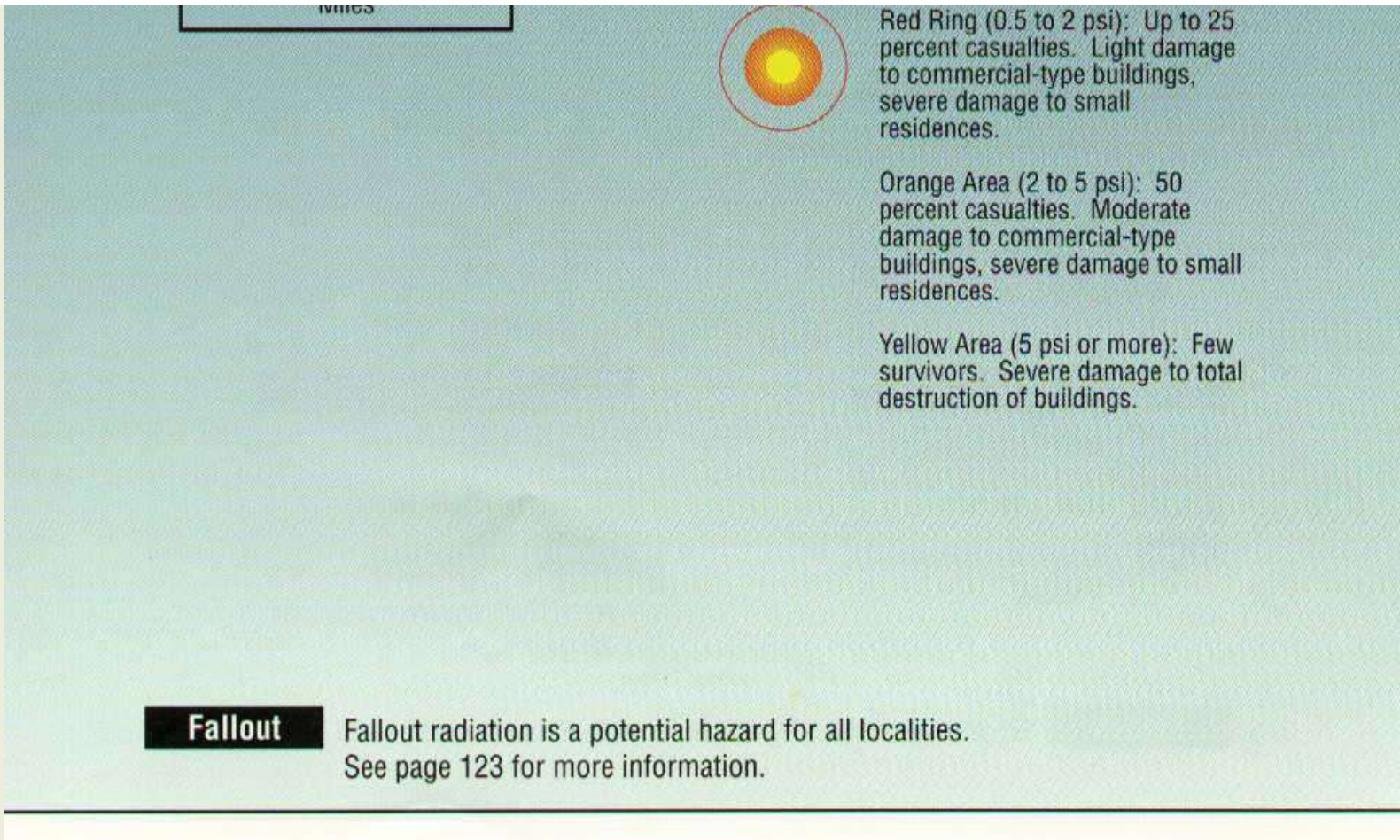
This is the nuclear target map for Virginia, but remember, fallout can go anywhere or everywhere (and probably will). After you have looked at this map look at the [Information for Virginia](#) that follows it.

This link will take you back to the [Index of all the States](#)

### **Nuclear Weapon Target Map for Virginia (FEMA-196/September 1990)**







[UPDATE to Target Information!!!](#)

## Information for Virginia

This link will take you back to the [Index of all the States](#)

It is recommended that you go through the following 10 steps in studying about the nuclear threat to Virginia.

1. Look at the [State Map](#) above to see the target nuclear areas in Virginia.
2. Look at the [general expected fallout map](#) to see where Virginia (according to the **prevailing wind pattern**) gets fallout from other states.
3. If the state that you live in is anywhere EAST of any of the following 6 states in the **prevailing wind pattern** then look at the states in **RED** on the [INDEX of](#)

## STATES for

- Montana
- North Dakota
- South Dakota
- Nebraska
- Missouri
- Colorado

These six states contain what is called DENSE PACK which I explain on each of those states pages. **UNDERSTAND** that the wind pattern **COULD** at that time be something other than the "prevailing" wind pattern.

4. Bookmark the present URL or make a copy of this present address so that you can come back to it after going to

[Blast Mapper](#).

This mapper is on someone else's web site so that you will need to save this address in order to return here if your back button doesn't work. However, you want to be sure to go the mapper site and calculate the damage to probable targets (cities) around you.

5. Memorize the THREE top rules for survival. They are:

- Number One - **Get out of the cities!**
- Number Two - **Get out of the cities!**
- Number Three - **Get out of the cities!**

6. The follow-on rules are:

- a. Have a shelter
- b. Work with a group (you are going to need the manpower, brainpower, and skillpower).

- c. Stock supplies.

7. My [Main Survival Page](#) contains links to lots of other information such as free books to download about nuclear survival, links to plans for building shelters, and even free consultation about building a shelter.

8. If you are SUPER concerned about nuclear survival you might consider moving within 20 miles of the

[Ark Two Community](#)  
(in Canada)

9. And finally if you would like to be on the mailing list of the author of this site - send a blank email to:

[arktwo-request@deuce.pairowoodies.com](mailto:arktwo-request@deuce.pairowoodies.com)  
[with the subject as subscribe](#)

**MENU: [HOME](#) » [SURVIVAL](#) » [Index of States](#)**

---

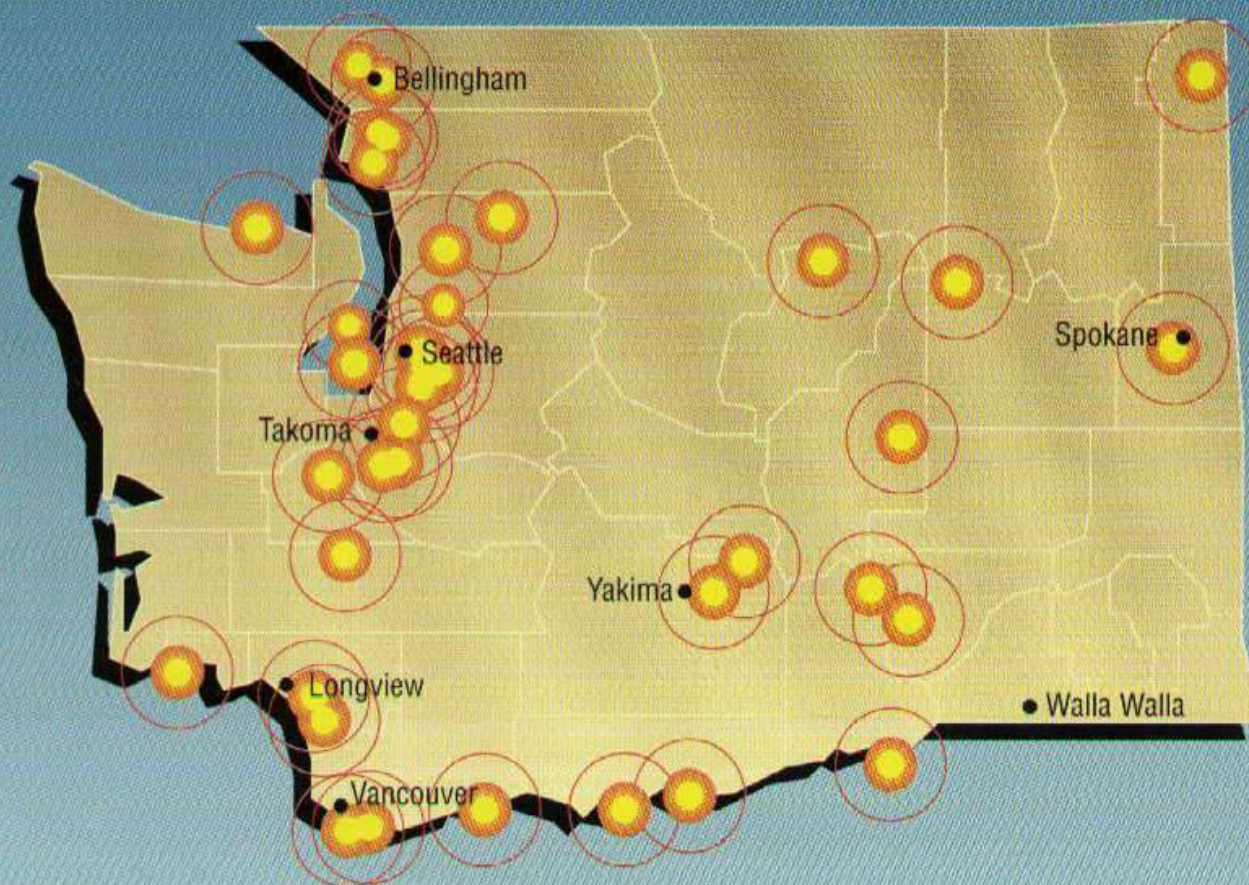
---

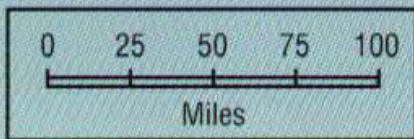
## Nuclear Survival in **Washington**

This is the nuclear target map for Washington, but remember, fallout can go anywhere or everywhere (and probably will). After you have looked at this map look at the [Information for Washington](#) that follows it.

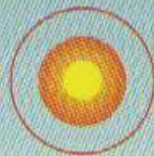
This link will take you back to the [Index of all the States](#)

**Nuclear Weapon Target Map for Washington (FEMA-196/September 1990)**





## Nuclear Attack



Red Ring (0.5 to 2 psi): Up to 25 percent casualties. Light damage to commercial-type buildings, severe damage to small residences.

Orange Area (2 to 5 psi): 50 percent casualties. Moderate damage to commercial-type buildings, severe damage to small residences.

Yellow Area (5 psi or more): Few survivors. Severe damage to total destruction of buildings.

## Fallout

Fallout radiation is a potential hazard for all localities. See page 123 for more information.

[UPDATE to Target Information!!!](#)

## Information for Washington

This link will take you back to the [Index of all the States](#)

It is recommended that you go through the following 10 steps in studying about the nuclear threat to Washington.

1. Look at the [State Map](#) above to see the target nuclear areas in Washington.
2. Look at the [general expected fallout map](#) to see where Washington (according to the **prevailing wind pattern**) gets fallout from other states.
3. If the state that you live in is anywhere EAST of any of the following 6 states in the **prevailing wind pattern** then look at the states in **RED** on the [INDEX of](#)

## STATES for

- Montana
- North Dakota
- South Dakota
- Nebraska
- Missouri
- Colorado

These six states contain what is called DENSE PACK which I explain on each of those states pages. **UNDERSTAND** that the wind pattern **COULD** at that time be something other than the "prevailing" wind pattern.

4. Bookmark the present URL or make a copy of this present address so that you can come back to it after going to

[Blast Mapper](#).

This mapper is on someone else's web site so that you will need to save this address in order to return here if your back button doesn't work. However, you want to be sure to go the mapper site and calculate the damage to probable targets (cities) around you.

5. Memorize the THREE top rules for survival. They are:

- Number One - **Get out of the cities!**
- Number Two - **Get out of the cities!**
- Number Three - **Get out of the cities!**

6. The follow-on rules are:

- a. Have a shelter
- b. Work with a group (you are going to need the manpower, brainpower, and skillpower).

- c. Stock supplies.

7. My [Main Survival Page](#) contains links to lots of other information such as free books to download about nuclear survival, links to plans for building shelters, and even free consultation about building a shelter.

8. If you are SUPER concerned about nuclear survival you might consider moving within 20 miles of the

[Ark Two Community](#)  
(in Canada)

9. And finally if you would like to be on the mailing list of the author of this site - send a blank email to:

[arktwo-request@deuce.pairowoodies.com](mailto:arktwo-request@deuce.pairowoodies.com)  
[with the subject as subscribe](#)

**MENU: [HOME](#) » [SURVIVAL](#) » [Index of States](#)**

---

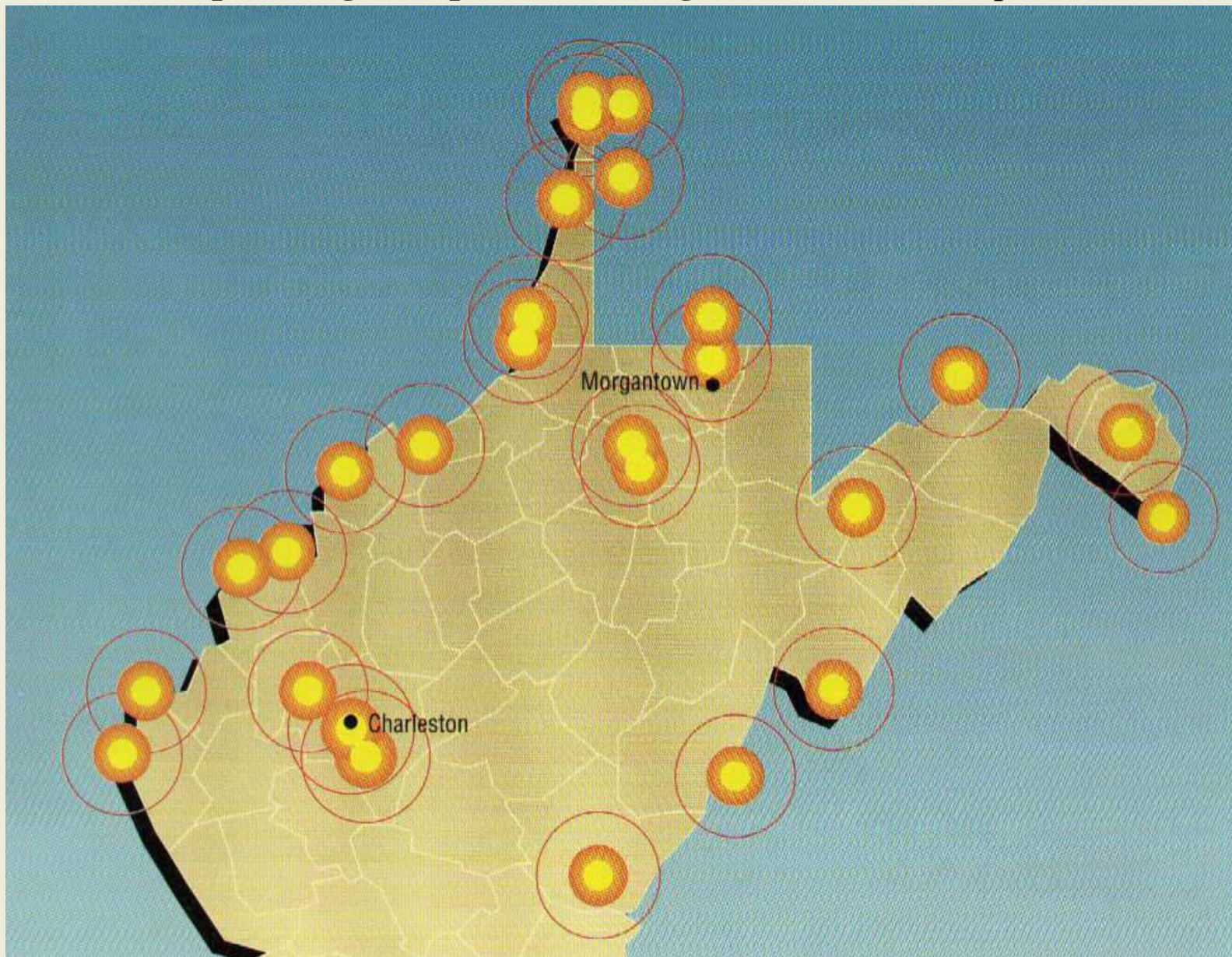
---

## Nuclear Survival in **West Virginia**

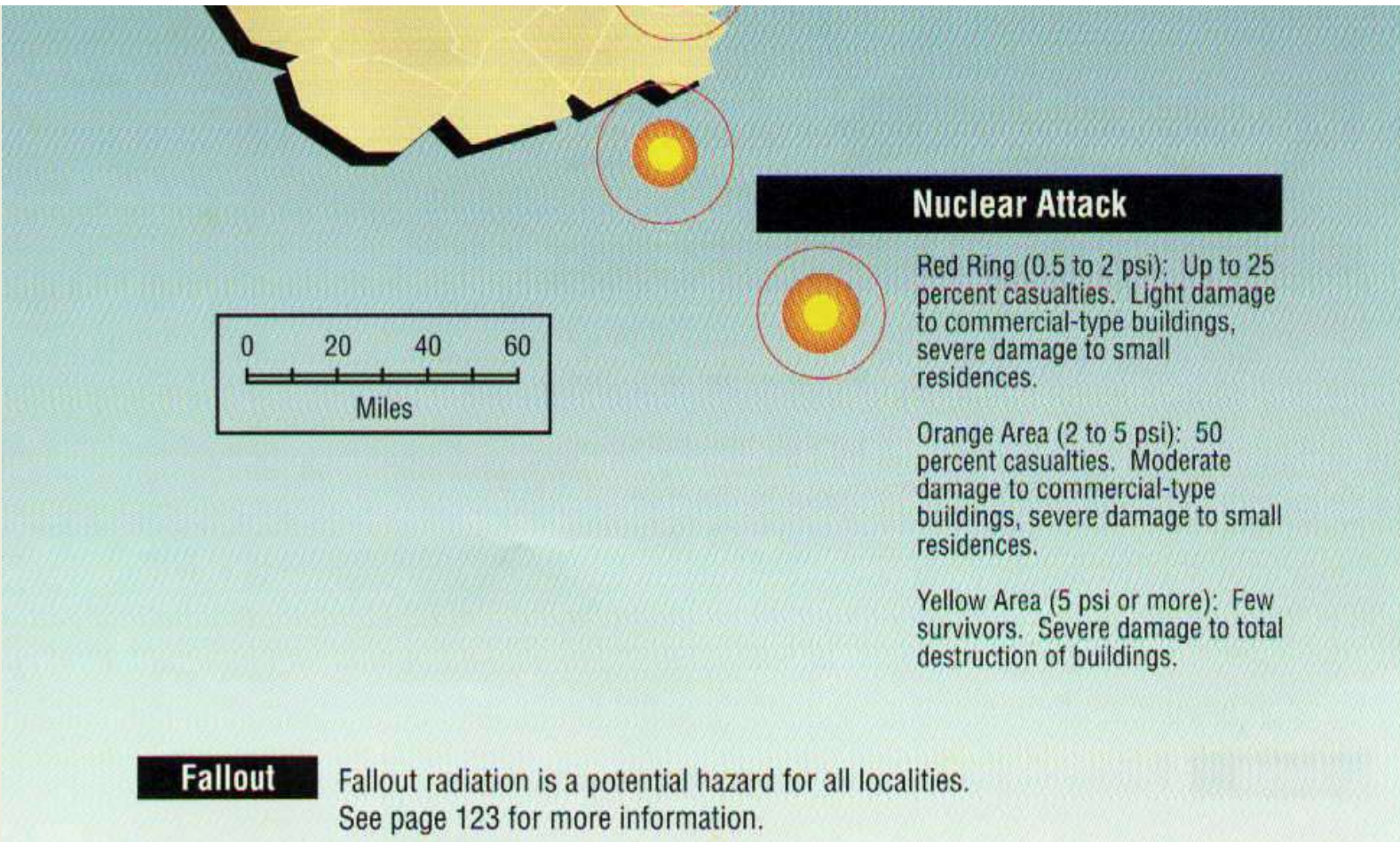
This is the nuclear target map for West Virginia, but remember, fallout can go anywhere or everywhere (and probably will). After you have looked at this map look at the [Information for West Virginia](#) that follows it.

This link will take you back to the [Index of all the States](#)

### **Nuclear Weapon Target Map for West Virginia (FEMA-196/September 1990)**







[UPDATE to Target Information!!!](#)

## Information for West Virginia

This link will take you back to the [Index of all the States](#)

It is recommended that you go through the following 10 steps in studying about the nuclear threat to West Virginia.

1. Look at the [State Map](#) above to see the target nuclear areas in West Virginia.
2. Look at the [general expected fallout map](#) to see where West Virginia (according to the **prevailing wind pattern**) gets fallout from other states.
3. If the state that you live in is anywhere EAST of any of the following 6 states in the **prevailing wind pattern** then look at the states in **RED** on the [INDEX of](#)

## STATES for

- Montana
- North Dakota
- South Dakota
- Nebraska
- Missouri
- Colorado

These six states contain what is called DENSE PACK which I explain on each of those states pages. **UNDERSTAND** that the wind pattern **COULD** at that time be something other than the "prevailing" wind pattern.

4. Bookmark the present URL or make a copy of this present address so that you can come back to it after going to

[Blast Mapper](#).

This mapper is on someone else's web site so that you will need to save this address in order to return here if your back button doesn't work. However, you want to be sure to go the mapper site and calculate the damage to probable targets (cities) around you.

5. Memorize the THREE top rules for survival. They are:

- Number One - **Get out of the cities!**
- Number Two - **Get out of the cities!**
- Number Three - **Get out of the cities!**

6. The follow-on rules are:

- a. Have a shelter
- b. Work with a group (you are going to need the manpower, brainpower, and skillpower).

- c. Stock supplies.

7. My [Main Survival Page](#) contains links to lots of other information such as free books to download about nuclear survival, links to plans for building shelters, and even free consultation about building a shelter.

8. If you are SUPER concerned about nuclear survival you might consider moving within 20 miles of the

[Ark Two Community](#)  
(in Canada)

9. And finally if you would like to be on the mailing list of the author of this site - send a blank email to:

[arktwo-request@deuce.pairowoodies.com](mailto:arktwo-request@deuce.pairowoodies.com)  
[with the subject as subscribe](#)

**MENU: [HOME](#) » [SURVIVAL](#) » [Index of States](#)**

---

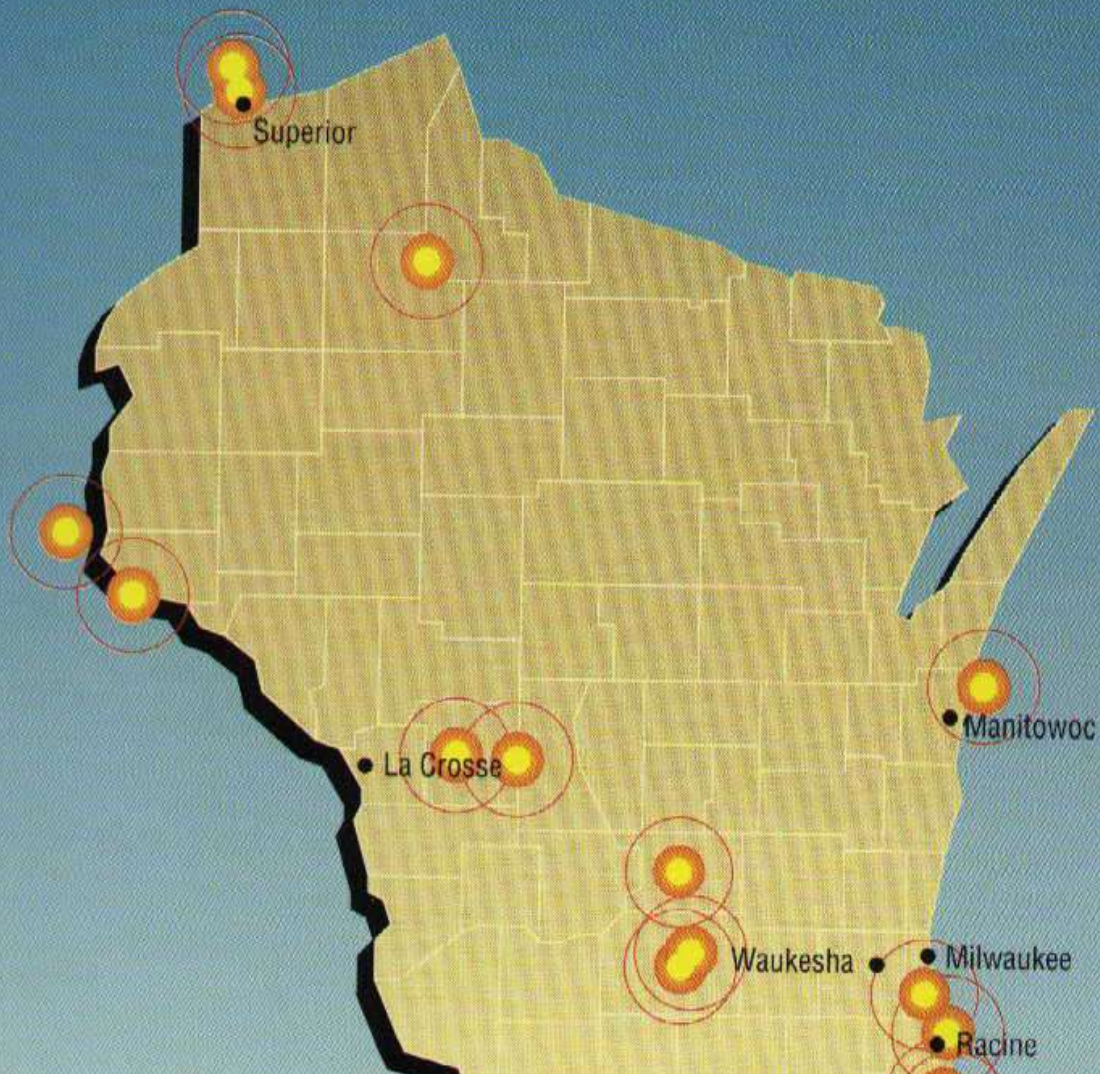
---

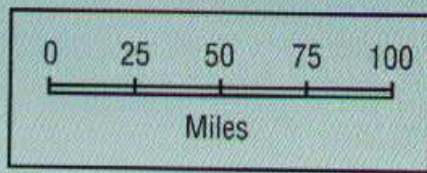
## Nuclear Survival in **Wisconsin**

This is the nuclear target map for Wisconsin, but remember, fallout can go anywhere or everywhere (and probably will). After you have looked at this map look at the [Information for Wisconsin](#) that follows it.

This link will take you back to the [Index of all the States](#)

### **Nuclear Weapon Target Map for Wisconsin (FEMA-196/September 1990)**





## Nuclear Attack



**Red Ring (0.5 to 2 psi):** Up to 25 percent casualties. Light damage to commercial-type buildings, severe damage to small residences.

**Orange Area (2 to 5 psi):** 50 percent casualties. Moderate damage to commercial-type buildings, severe damage to small residences.

**Yellow Area (5 psi or more):** Few survivors. Severe damage to total destruction of buildings.

## Fallout

Fallout radiation is a potential hazard for all localities. See page 123 for more information.

[UPDATE to Target Information!!!](#)

## Information for Wisconsin

This link will take you back to the [Index of all the States](#)

It is recommended that you go through the following 10 steps in studying about the nuclear threat to Wisconsin.

1. Look at the [State Map](#) above to see the target nuclear areas in Wisconsin.
2. Look at the [general expected fallout map](#) to see where Wisconsin (according to the **prevailing wind pattern**) gets fallout from other states.
3. If the state that you live in is anywhere EAST of any of the following 6 states in the **prevailing wind pattern** then look at the states in **RED** on the [INDEX of](#)

## STATES for

- Montana
- North Dakota
- South Dakota
- Nebraska
- Missouri
- Colorado

These six states contain what is called DENSE PACK which I explain on each of those states pages. **UNDERSTAND** that the wind pattern **COULD** at that time be something other than the "prevailing" wind pattern.

4. Bookmark the present URL or make a copy of this present address so that you can come back to it after going to

[Blast Mapper](#).

This mapper is on someone else's web site so that you will need to save this address in order to return here if your back button doesn't work. However, you want to be sure to go the mapper site and calculate the damage to probable targets (cities) around you.

5. Memorize the THREE top rules for survival. They are:

- Number One - **Get out of the cities!**
- Number Two - **Get out of the cities!**
- Number Three - **Get out of the cities!**

6. The follow-on rules are:

- a. Have a shelter
- b. Work with a group (you are going to need the manpower, brainpower, and skillpower).

- c. Stock supplies.

7. My [Main Survival Page](#) contains links to lots of other information such as free books to download about nuclear survival, links to plans for building shelters, and even free consultation about building a shelter.

8. If you are SUPER concerned about nuclear survival you might consider moving within 20 miles of the

[Ark Two Community](#)  
(in Canada)

9. And finally if you would like to be on the mailing list of the author of this site - send a blank email to:

[arktwo-request@deuce.pairowoodies.com](mailto:arktwo-request@deuce.pairowoodies.com)  
[with the subject as subscribe](#)

**MENU: [HOME](#) » [SURVIVAL](#) » [Index of States](#)**

---

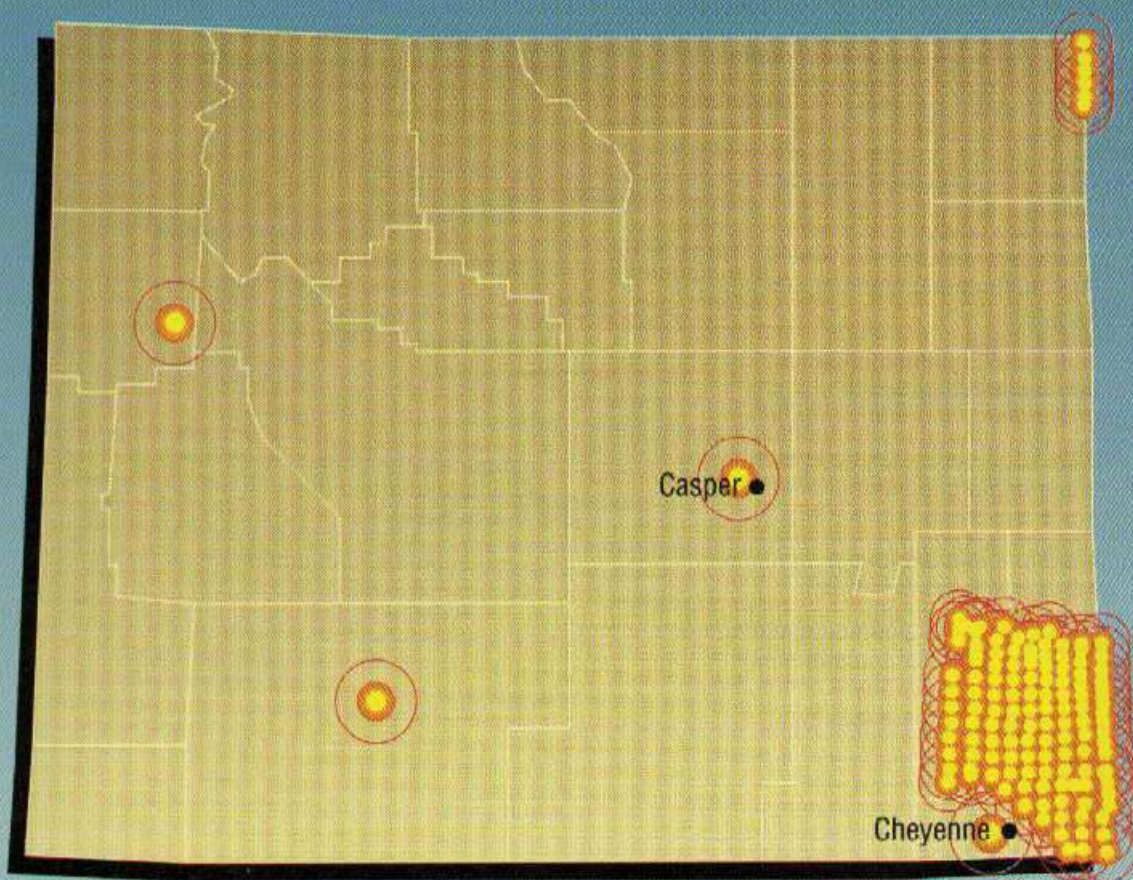
---

## Nuclear Survival in **Wyoming**

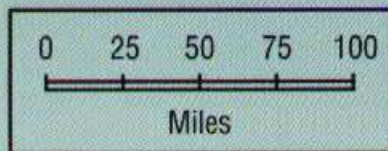
This is the nuclear target map for Wyoming, but remember, fallout can go anywhere or everywhere (and probably will). After you have looked at this map look at the [Information for Wyoming](#) that follows it.

This link will take you back to the [Index of all the States](#)

### **Nuclear Weapon Target Map for Wyoming (FEMA-196/September 1990)**







## Nuclear Attack



**Red Ring (0.5 to 2 psi):** Up to 25 percent casualties. Light damage to commercial-type buildings, severe damage to small residences.

**Orange Area (2 to 5 psi):** 50 percent casualties. Moderate damage to commercial-type buildings, severe damage to small residences.

**Yellow Area (5 psi or more):** Few survivors. Severe damage to total destruction of buildings.

## Fallout

Fallout radiation is a potential hazard for all localities. See page 123 for more information.

[UPDATE to Target Information!!!](#)

## Information for Wyoming

This link will take you back to the [Index of all the States](#)

It is recommended that you go through the following 10 steps in studying about the nuclear threat to Wyoming.

1. Look at the [State Map](#) above to see the target nuclear areas in Wyoming.
2. Look at the [general expected fallout map](#) to see where Wyoming (according to the **prevailing wind pattern**) gets fallout from other states.
3. If the state that you live in is anywhere EAST of any of the following 6 states in the **prevailing wind pattern** then look at the states in **RED** on the [INDEX of](#)

## STATES for

- Montana
- North Dakota
- South Dakota
- Nebraska
- Missouri
- Colorado

These six states contain what is called DENSE PACK which I explain on each of those states pages. **UNDERSTAND** that the wind pattern **COULD** at that time be something other than the "prevailing" wind pattern.

4. Bookmark the present URL or make a copy of this present address so that you can come back to it after going to

[Blast Mapper](#).

This mapper is on someone else's web site so that you will need to save this address in order to return here if your back button doesn't work. However, you want to be sure to go the mapper site and calculate the damage to probable targets (cities) around you.

5. Memorize the THREE top rules for survival. They are:

- Number One - **Get out of the cities!**
- Number Two - **Get out of the cities!**
- Number Three - **Get out of the cities!**

6. The follow-on rules are:

- a. Have a shelter
- b. Work with a group (you are going to need the manpower, brainpower, and skillpower).

- c. Stock supplies.

7. My [Main Survival Page](#) contains links to lots of other information such as free books to download about nuclear survival, links to plans for building shelters, and even free consultation about building a shelter.

8. If you are SUPER concerned about nuclear survival you might consider moving within 20 miles of the

[Ark Two Community](#)  
(in Canada)

9. And finally if you would like to be on the mailing list of the author of this site - send a blank email to:

[arktwo-request@deuce.pairowoodies.com](mailto:arktwo-request@deuce.pairowoodies.com)  
[with the subject as subscribe](#)

**MENU: [HOME](#) » [SURVIVAL](#) » [Index of States](#)**

---

---

## Bruce Beach

Greetings, my name is Bruce Beach and I am adding this page so that anyone desiring to do so may get to know me more personally. I am the coordinator, founder and initial vision holder of the [World Language Process](#). I am a former professor of computer science and have been a student of the world language problem for over thirty years.



I now live in a little village of 200 people, called Horning's Mills, that is about 90 miles northwest of Toronto, Ontario, Canada. My wife was born in this village (and her mother also, in the 19th century). We have many relations that live in the village and I have a son and daughter and grandchildren nearby.



I was born in Winfield, Kansas and raised mostly in Wellington, Kansas where a number of my offspring (children, grandchildren, and great grandchild) still live. I moved to Canada in 1970 to teach in the Northern College System (in Sault Ste. Marie, Kirkland Lake and Kapuskasing) after having previously taught in black colleges in the U.S. (Morgan State and Jarvis Christian College in Hawkins Texas).

Years ago I spent a year in the Arctic as a control tower operator, courtesy of the U.S. Air Force. I have made a couple of trips to China and have travelled somewhat extensively in South America and less so to Europe and elsewhere. I have a total of over 20 children, grandchildren, and a great grandchild, several of which live in Taiwan and the rest in the U.S. and Canada. Below is a picture of myself with some of my grandchildren.



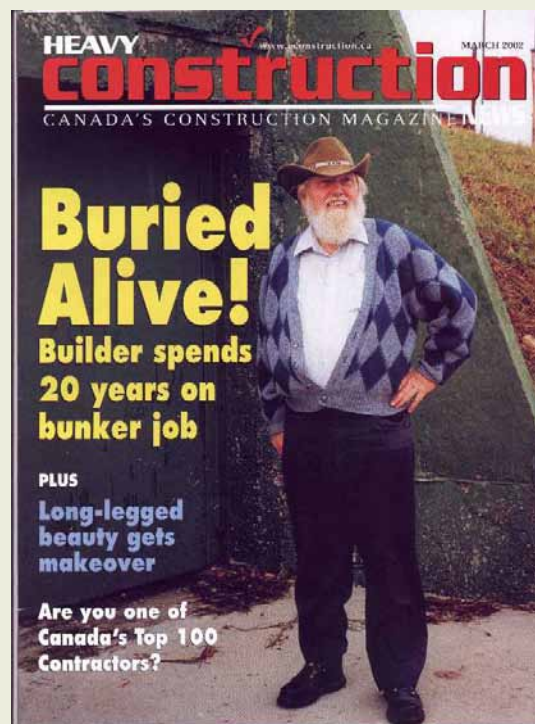
At one time I owned a very large research ship called **Canada's Tomorrow** and one third of the company that built the robotic arm that recovered the space shuttle Challenger. One of the company's robotic arms is in the Smithsonian. I have also written a number of books in the computer sciences, the latest being on the programming language 'C'.



My strongest interests, outside of the [World Language Process](#), lie in the areas

of religion, astronomy and the social sciences. I have no musical or sports talents but was once upon a time an exceptional speed reader, reading as many as five books a day. Now I read only about that many a month. I used to play a little [chess](#) and hold patents on a chess teaching machine that was manufactured some years ago and sold in several countries.

I am somewhat notorious as a survivalist having built two dozen [shelters](#) for myself and others, and I have consulted on many dozens more. I maintain a web page on this subject also, and you can click on the link in the unlikely case that this is something that interests you.



I am an optimist about the long term future of mankind but a pessimist about the immediate future, particularly at this millennialist point. As I have said, I am greatly interested in religion, being a class taught student of Christian Science and a persistent student of the writings of Emannuel Swedenborg for almost forty years. At one time I termed myself a Zen Buddhist and have read many translations of both the Bhagavad Gita and the Koran. I have also thoroughly studied the Mormon religion (I did some practice teaching at BYU) and the Jehovah's Witness religion. I truly appreciate them all and have been a Baha'i for thirty-five years. You can link to my [essays](#) if you are interested to know where



my understanding of the Baha'i Writings has led me. I met my wife at the Baha'i Temple in Wilmette, Illinois which is just outside Chicago. She was guiding at the front door.





My reading interest, in addition to Swedenborg, Computer Magazines, Sky and Telescope and the Bulletin of the Atomic Scientists, is completely eclectic. My favorite books of all time, aside from religious books, have been "Zen and the Art of Motorcycle Maintenance", "The Flatland", "Godel, Escher and Bach", "Varieties of Religious Experience", and many works by J.S. Mills. I have also in the past read gobs in psychology and economics (having a master's degree in the latter). There are times in my life when I have been a science fiction and movie hound but my greatest pleasure now is my children and grandchildren.

This should be about enough to bore you about any one person. I lead a very active life working fourteen to sixteen hours a day. A stroke some years ago blinded me in one eye but I have since reprogrammed myself to type on a Dvorak keyboard. I have loving children who look after me and a wife that everyone,

including myself, says is a saint. I am truly a happy and joyful person, a claim that I wish that more people could make in this technologically illustrious and spiritually dark age.

I can be reached personally at:

[language@webpal.org](mailto:language@webpal.org)

My hope, of course, is that we can find a mutual interest in furthering the

[World Language Process,](#)

which you can click on and link to if you have come to this page by a different path.

Regards,

Bruce M. Beach



**MENU:** [HOME](#) » [Reconstruction](#) » [Recovery](#) » [Renewal](#) » [Survival](#)

---

---

# Reconstruction of Society

## [Holocaust: Immediate Steps to Social Restoration after Holocaust](#)

This a link to another page that presents solutions for the first early problems of social restoration. Anarchy and Martial Law / Mass Death and Body Disposal / Refugees and Emergency Shelter / and many other issues.

The other entries immediately below will fit in - in the longer term.

## [REGISTRY: Family LOCATING and relocating](#)

After a holocaust one of the major concerns that people will have, will be that of locating missing family members and finding a place where they can settle. The pages linked here will be intended to help provide that information at that time. At the moment they show potential nuclear targets but in the future the intention is to reformat them to show the actual disaster areas, paths around them and a link to the REGISTRY of survivors for each area.

## [LETS: Reconstruction of the Economic System](#)

There is good reason to believe that much of the conflict, that led to the nuclear war, grew out of the greed, power and conflict of the world's economic systems. As large and powerful as they were there were many people in the world who were without economic opportunity to improve themselves. There is recommended here an alternative economic approach that will help great numbers of people to rapidly recover economically.

## [Pencil: The Making of a Pencil](#)

This is an essay that explains why people cannot live independently of others. It shows why the economic system has to be reconstructed. To reconstruct something does not mean to necessarily put it back as it was. Indeed, it is a chance for improvement and to remove what experience has shown were faults in the previous design.

## [Carnegie: Management of Large Scale Enterprises](#)

Because large scale enterprises offer economies of scale they are often the most efficient and most productive systems. In connection with the subject of entitlement covered in the previous section this section uses the insights of Andrew Carnegie who was one of America's foremost capitalists and its leading philanthropist to explain what he called "The Gospel of Wealth". The subject is really the integrity, morality, and motives that should be required of the managers of large economic concerns.

## [NWO: The New World Order-an introduction](#)

There are many ideas about the New World Order. It was international anarchy that brought about the nuclear war and there will surely be a willingness, indeed an eagerness, to implement a system of international order that will eliminate the scourge of war. Here, there is presented the very varied thinking on the subject of many notables from over a century.

## [Angel Tongue: World Language Process](#)

A premier project of this author is the World Language Process. The main activity, until now, of the program has been the research into the requirements of a universal auxiliary language. As a part of the reconstruction of society it will be necessary that some world body will eventually select such a language. The purpose of the World Language Process will then be the further development and promotion of that language. An experimental language candidate, called the Angel Tongue, is presented here.

**MENU: [HOME](#) » [Reconstruction](#) » [Recovery](#) » [Renewal](#) » [Survival](#)**

---

---

## Immediate Steps to Social Restoration

The immediate aftermath of a world-wide nuclear war will most likely result in anarchy, total confusion and disaster in almost every local community no matter how far it is located from the blast and firestorm effects of the nuclear weapons themselves. Most likely there will be no distributed electrical power, extremely limited and not immediately irreplaceable supplies of food and fuel, and very limited means of communication.

In these circumstances there will most often be looting of the few remaining supplies from stores. Medical and other services will be impossible to maintain. For a more graphic illustration of what may be expected you may be interested in reading the author's

["You Will Survive Doomsday"](#) (Myth #01).

The first order of the day will be the

## Restoration of Security

Moving masses of refugees, semi-organized mobs such as motorcycle gangs or groups who are able to mutually identify on some racial or other basis, along with mass escapes from penal institutions, will add to confusion and hazard for personal safety.

The first order of business, of any entities who wish to establish a system of justice and order, will be that of security. There is the possibility that previous police and military units may simply go renegade but if they can be called upon to provide service their identity will be helpful in gaining respect for their enforcement. You will probably be very fortunate if you have any security - even martial law.

### [Martial Law: Domestic Support Operations](#)

This is the full 1993 Field Manual in .pdf format from the Headquarters of the Department of the Army and the US Marine Corps. Of particular interest may be Chapter 9-5 in regards to operation *Garden Plot*. In our off-line library we maintain a number of other manuals dealing with lines of authorization and other such matters.

The essential requirement is always security and this is why it is necessary to extend the social perimeters as far as possible. Live and let live, will not work - if the other fellow does not agree. No matter how well armed and organized an individual family or small collective might be - they cannot withstand unending repeated assaults nor the attack of a significantly larger force. This is just a fact of

life.

The three choices are to conquer, cooperate, collaborate - or die in the effort. The preferred choice is cooperate. If one or a community is attacked by a vicious renegade gang that has no inclination to cooperate and which offers no benefits in collaboration (such as protection) then the only choice is between conquering or dying in the effort, where otherwise they will be pillaged, raped and murdered anyway.

### **Martial Law: Reconstruction of Social Order**

This is the Table of Contents in HTML format of the 2001 Field Manual from the Headquarters of the Department of the Army on Military Police Internment and Resettlement Operations. There are links here for downloading the entire manual from the official government site.

## **Humanitarian Services**

The second order of business, after security, will be that of shelter, especially in the winter time. Such public and private buildings that can be commanded will need to be utilized. Food and fuel will then become the nagging problems. Any significant stocks must be immediately commanded and protected. Those who are able to provide for these essentials, perhaps by some collective effort, can then begin to widen their horizons as to providing for the largest collective good.

### **Martial Law: Internment and Resettlement Operations**

This is the full .pdf version of the above 2001 Field Manual from the Headquarters of the Department of the Army on Military Police Internment and Resettlement Operations.

### **Camps: Standards for Building Refugee Camps**

This UN paper is based upon experience and gives considerations that should be taken into account wherever possible. After a nuclear holocaust, a compounding problem for many areas will be a shortage of supplies and no outside source for them.

### **Health: Field Hygiene and Sanitation**

This is the 2000 Marine Corps Field Manual. Health and hygiene from a community perspective, rather than the individual perspective. Everything from maintaining community kitchens to showers, toilets, and so forth. Refugee handling centers, camps and facilities along with emergency medical facilities may find some application of principles listed here.

### **Toilets: Unsewered Toilets**



As a sub-issue to public health this is a 40 page booklet from the Ontario Ministry of the Environment which we have placed in a 1599KB .pdf file.

## Salvaging Operations

The size of marauding renegade, or not so renegade, forces that may be allied against initially forming cooperative and collective communities - may be very great and may increase overtime. Once again, the best solution is to increase through cooperation the size and perimeters of the collective community. If given the opportunity to submit to the authority of some entity that already has in place or has achieved a superior degree of organization, along with the resources to maintain it, then that is the most reasonable and rapid choice - providing that entity is sufficiently altruistic towards one's essential values.

One of the first potential resources will be that of salvaging and protecting the assets that remain. Initially, this particularly applies to food, fuel, and medicines. However, any controlling entity will do well to as quickly as possible establish protocols for dealing with looters and vandals. Regarding the latter, there will arise a destructive mindset that must be controlled immediately in order to prevent detrimental destruction that can thus be avoided. On the other hand, salvaging needs to be quickly legitimately authorized, organized, coordinated, controlled, collected and cataloged. This will be an excellent use of what would be otherwise unemployed manpower and a redirection of energies that could otherwise be put to detrimental purposes. The old saying - "the devil finds work for idle hands".

### Rescue: Basic Rescue Skills

This 831 KB in 22 .pdf pages of this 43 page booklet covers basic rescue skills, which may be a continuing necessity for some period of time.

### Death: Mass body disposal

This is a link to another page where I deal with problems of mass body disposal.

### Medical: Emergency Medical Facilities

This is a link to another page where I deal with establishing emergency medical facilities.

## Reestablishment of Infrastructure

An inventory of resources needs to be compiled. Not just physical objects but what is called human capital so that recovery and reconstruction coordinators can best utilize both materials and skills. The primary concerns will be [Individual Agricultural Recovery](#), communication, fuel, transportation, and manufacture.

Communications may have to be as simple as establishing runners or a localized postal system. On the other hand there may be the capability of charging batteries for battery powered radios and even HAM radio for more distant communication. If a local transmitter can be brought back on the air this would provide one way communication to battery powered car radios, the batteries for which could be charged by a variety of methods. Local phone lines may be undamaged and it again becomes a matter of charging the system. As with any system it may be necessary to restrict or ration usage to those points with the highest social priority.

Alternate fuel sources are described in [Individual Agricultural Recovery after Nuclear Holocaust](#). Some of these may be as primitive as salvaging and distributing wood for heating and cooking. Combustible fuels for internal combustion engines will be a high priority.

Transportation is highly necessary for security, fire defense, salvaging, distribution and getting the labor force where it is needed. A busing system may have high priority in this latter regard.

The reestablishment of manufacture is an important goal. Support and incentive should be given to those trying to do so. Large scale manufacture may come considerably later but what should be done first is to identify the immediate needs and what methods there are of fulfilling them. Two lists, one of priorities, the other of resources and capabilities, can be drawn up. High priority items have a first call upon resources. Lower priority items that can be easily fulfilled without detriment to high priority items can also be readily met. The challenge will be in allocating resources to priorities in the middle range which are not so essential but are not so easily met either.

The very largest scales of manufacture require large functioning reconstructed communities. To support the reconstruction of a refinery, for instance, with its requirements for energy, raw material, transportation of product, expert operators, and so forth would very likely require a functioning surrounding community of tens, if not hundreds, of thousands. Once again a reason for extending the perimeters of the supporting communities. While such reestablishment may be a considerable time coming in many areas, nevertheless all such resources should be protected, as much as possible, for the future. In the meantime, all presently usable resources should be utilized to the maximum. This particularly applies to the human capital.

A traumatized society will probably collectively go through the seven stages of grief. Intense, purposeful and meaningful activity is probably the best therapy available, both individually and collectively. The reestablishment of social institutions for security, justice, health, education, all depend upon the functioning political / economic system. Whoever or whatever controls the economic, production, distribution system will also control the security and other systems. This writer's preference is for that which he describes in conjunction with the [LETS](#) system, but most any functioning system will be better than none.

**MENU: [HOME](#) » [Reconstruction](#) » [Recovery](#) » [Renewal](#) » [Survival](#)**



FM 100-19  
FMFM 7-10

# **DOMESTIC SUPPORT OPERATIONS**

**HEADQUARTERS DEPARTMENT OF THE ARMY  
US MARINE CORPS**

JULY 1993

**DISTRIBUTION RESTRICTION:** Approved for public release; distribution is unlimited.

Field Manual  
FM 100-19  
Fleet Marine Force Manual  
FMFM 7-10

Headquarters  
Department of the Army  
The Marine Corps  
Washington, DC, 1 July 1993

## **DOMESTIC SUPPORT OPERATIONS**

### **TABLE OF CONTENTS**

	<b>Page</b>
<b>PREFACE</b> .....	vii
<b>INTRODUCTION</b> .....	viii
<b>CHAPTER 1 CONCEPT AND PRINCIPLES</b> .....	1-1
HISTORY AND CATEGORIES OF DOMESTIC SUPPORT .....	1-1
DISASTER ASSISTANCE .....	1-2
ENVIRONMENTAL ASSISTANCE .....	1-2
LAW ENFORCEMENT .....	1-3
COMMUNITY ASSISTANCE .....	1-3
CONCEPT .....	1-4
PRINCIPLES OF OPERATIONS OTHER THAN WAR .....	1-4
THE ARMY'S ROLE .....	1-5
SUMMARY .....	1-6
<b>CHAPTER 2 ROLES AND RESPONSIBILITIES</b> .....	2-1
THE PRESIDENT .....	2-1
FEDERAL AGENCIES OTHER THAN DOD .....	2-2
DEPARTMENT OF AGRICULTURE (USDA) .....	2-2
THE AMERICAN RED CROSS (ARC) .....	2-2
DEPARTMENT OF COMMERCE (DOC) .....	2-2
DEPARTMENT OF EDUCATION (DOEd) .....	2-2
DEPARTMENT OF ENERGY (DOE) .....	2-2
ENVIRONMENTAL PROTECTION AGENCY (EPA) .....	2-2
FEDERAL EMERGENCY MANAGEMENT AGENCY (FEMA) .....	2-3
GENERAL SERVICES ADMINISTRATION (GSA) .....	2-3
DEPARTMENT OF HEALTH AND HUMAN SERVICES (DHHS) .....	2-3
DEPARTMENT OF INTERIOR (DOI) .....	2-4
DEPARTMENT OF JUSTICE (DOJ) .....	2-4
DEPARTMENT OF LABOR (DOL) .....	2-4
NATIONAL COMMUNICATIONS SYSTEM (NCS) .....	2-4
NUCLEAR REGULATORY COMMISSION (NRC) .....	2-4
DEPARTMENT OF STATE (DOS) .....	2-4
DEPARTMENT OF TRANSPORTATION (DOT) .....	2-4
DEPARTMENT OF TREASURY .....	2-5
NATIONAL WEATHER SERVICE (NWS) .....	2-5
DEPARTMENT OF DEFENSE (DOD) .....	2-5
SECRETARY OF DEFENSE (SECDEF) .....	2-5

DISTRIBUTION RESTRICTION: Approved for public release; distribution is unlimited.  
Marine Corps: PCN 139000572 00

	<b>Page</b>
SECRETARY OF ARMY .....	2-5
DIRECTOR OF MILITARY SUPPORT (DOMS) .....	2-5
UNIFIED COMMANDS .....	2-5
DEFENSE COORDINATING OFFICER (DCO) .....	2-8
NATIONAL GUARD .....	2-8
US ARMY RESERVE .....	2-9
MAJOR COMMANDS (MACOMs).....	2-9
STATE AND LOCAL GOVERNMENT .....	2-9
STATE RESPONSIBILITIES .....	2-10
LOCAL RESPONSIBILITIES .....	2-13
SUMMARY .....	2-13
<b>CHAPTER 3 LEGAL CONSIDERATIONS AND CONSTRAINTS .....</b>	<b>3-0</b>
CIVILIAN CONTROL OF THE MILITARY .....	3-0
THE ROLE OF THE ARMY .....	3-0
THE LAW .....	3-1
SUPPORT TO CIVILIAN LAW ENFORCEMENT: <i>The Posse Comitatus Act</i> .....	3-1
DOMESTIC DISASTER RELIEF: <i>The Robert T. Stafford Disaster Relief Act</i> .....	3-2
CIRCUMSTANCES CONCERNING ELECTIONS .....	3-3
COMBATTING TERRORISM, AIRCRAFT PIRACY, AND OTHER OPERATIONS .....	3-3
COMBATTING TERRORISM, .....	3-3
AIRCRAFT PIRACY .....	3-4
OTHER OPERATIONS .....	3-4
USE OF PERSONNEL, MATERIEL, AND EQUIPMENT .....	3-5
USE OF MILITARY INTELLIGENCE (MI) PERSONNEL .....	3-5
USE OF RESERVE COMPONENT PERSONNEL .....	3-5
USE OF MATERIEL AND EQUIPMENT .....	3-5
REIMBURSEMENT .....	3-5
SUMMARY .....	3-6
<b>CHAPTER 4 LOGISTICS AND SUPPORT OPERATIONS .....</b>	<b>4-1</b>
PLANNING .....	4-1
SOURCES OF SUPPORT .....	4-2
CONTRACTING .....	4-2
NEGOTIATED SUPPORT .....	4-2
MILITARY SUPPORT .....	4-2
SUPPORT FROM OTHER FEDERAL AGENCIES .....	4-2
LOGISTICS COMMAND AND CONTROL CELLS .....	4-3
RESOURCE MANAGEMENT .....	4-4
SUPPLIES AND FIELD SERVICES .....	4-4

	<b>Page</b>
DEFENSE LOGISTICS AGENCY .....	4-5
QUARTERMASTER (QM) UNITS .....	4-5
MORTUARY AFFAIRS UNITS .....	4-6
FORCE PROVIDER UNIT .....	4-6
OTHER SUPPORT .....	4-7
MAINTENANCE .....	4-8
TRANSPORTATION .....	4-8
DEPLOYMENT .....	4-9
CONVOYS .....	4-9
REDEPLOYMENT .....	4-9
AVIATION .....	4-9
ENGINEER .....	4-10
MAPS AND CHARTS .....	4-11
INTELLIGENCE .....	4-11
MILITARY POLICE .....	4-11
MILITARY HEALTH SERVICE SUPPORT .....	4-11
TASK-ORGANIZED MEDICAL TEAMS .....	4-12
KEY PLANNING GUIDANCE .....	4-12
NATIONAL DISASTER MEDICAL SYSTEM .....	4-12
SYSTEM ACTIVATION .....	4-12
PERSONNEL SERVICES .....	4-13
FINANCE .....	4-14
BAND .....	4-14
LEGAL .....	4-14
CHAPLAINCY .....	4-14
PUBLIC AFFAIRS (PA) .....	4-15
SPECIAL OPERATIONS FORCES (SOF) .....	4-15
CIVIL AFFAIRS .....	4-15
PSYCHOLOGICAL OPERATIONS .....	4-15
SPECIAL FORCES .....	4-16
SIGNAL .....	4-16
CHEMICAL CORPS .....	4-16
SAFETY .....	4-17
SUMMARY .....	4-18
<b>CHAPTER 5 DISASTERS AND DOMESTIC EMERGENCIES .....</b>	<b>5-1</b>
THE ROLE OF THE ARMY .....	5-1
DISASTERS .....	5-1
RESPONSE FOLLOWING A PRESIDENTIAL DECLARATION .....	5-2
RESPONSE PRIOR TO A PRESIDENTIAL DECLARATION .....	5-3
PREPARING FOR DISASTER ASSISTANCE SUPPORT .....	5-4
THE FEDERAL RESPONSE PLAN .....	5-6
RESPONSIBILITIES .....	5-8
FEDERAL COORDINATING OFFICER .....	5-8

DEFENSE COORDINATING OFFICER ..... 5-8  
STATE COORDINATING OFFICER (SCO)..... 5-8  
JOINT TASK FORCE (JTF) 5-8  
DOMESTIC EMERGENCIES ..... 5-9  
    CIVIL DEFENSE EMERGENCIES ..... 5-9  
    ENVIRONMENTAL DISASTERS ..... 5-10  
    MASS IMMIGRATION EMERGENCY SUPPORT OPERATIONS..... 5-11  
    OTHER DIRECTED MISSIONS ..... 5-11  
SUMMARY ..... 5-11

**CHAPTER 6 ENVIRONMENTAL MISSIONS** ..... 6-0  
    PLANNING AND EXECUTION ..... 6-0  
        CHARACTERISTICS ..... 6-1  
        CLASSIFICATIONS ..... 6-2  
    COMPLIANCE ..... 6-2  
        OIL AND HAZARDOUS MATERIAL SPILLS ..... 6-2  
        PERMIT APPLICATIONS AND PLANS ..... 6-3  
        ENVIRONMENTAL COMPLIANCE ASSESSMENTS (AUDITS)..... 6-3  
        RESEARCH AND DEVELOPMENT ..... 6-3  
        WETLANDS ..... 6-3  
    RESTORATION ..... 6-4  
        FACILITY RESTORATION ..... 6-4  
        REAL PROPERTY TRANSFERS ..... 6-5  
        GENERAL SUPPORT ..... 6-5  
    PREVENTION ..... 6-5  
    CONSERVATION ..... 6-6  
        NATURAL RESOURCES MANAGEMENT ..... 6-6  
        WILDLAND FIREFIGHTING ..... 6-7  
        ANIMAL DISEASE ERADICATION ..... 6-7  
        CULTURAL RESOURCES MANAGEMENT ..... 6-7  
    ARMY RESOURCES ..... 6-8  
        DEPARTMENT OF THE ARMY ..... 6-8  
        TECHNICAL SUPPORT ORGANIZATIONS ..... 6-9  
        INSTALLATIONS AND STATE AREA COMMANDS ..... 6-9  
        COMMANDERS ..... 6-10  
SUMMARY ..... 6-11



<b>CHAPTER 7 MISSIONS IN SUPPORT OF LAW ENFORCEMENT .....</b>	<b>7-0</b>
COUNTERDRUG OPERATIONS .....	7-0
ROLES .....	7-0
CATEGORIES OF SUPPORT .....	7-2
REQUESTS FOR SUPPORT .....	7-7
PROVISION OF SUPPORT .....	7-8
CONSIDERATIONS FOR PLANNING .....	7-8
STAND-ALONE CAPABILITY .....	7-8
DECISION-MAKING PROCESS .....	7-8
LEGAL AND TACTICAL ASPECTS .....	7-8
LEGAL CONSTRAINTS .....	7-8
RULES OF ENGAGEMENT .....	7-9
OPERATIONS SECURITY .....	7-9
COMMAND AND CONTROL .....	7-9
COMMUNICATIONS .....	7-11
PUBLIC AFFAIRS .....	7-11
THREAT AWARENESS AND RISK ASSESSMENT .....	7-11
SUPPORT FOR CIVIL DISTURBANCE OPERATIONS .....	7-11
ROLES .....	7-11
REQUESTS FOR FEDERAL MILITARY ASSISTANCE .....	7-12
CONDUCT OF CIVIL DISTURBANCE OPERATIONS .....	7-12
SUPPORT FOR COMBATTING TERRORISM .....	7-14
ANTITERRORISM ASSISTANCE .....	7-14
COUNTERTERRORISM ASSISTANCE .....	7-14
TYPES OF SUPPORT .....	7-14
SUMMARY .....	7-15
<b>CHAPTER 8 COMMUNITY ASSISTANCE .....</b>	<b>8-0</b>
PRINCIPLES .....	8-0
COMMAND EMPHASIS .....	8-1
INDIVIDUAL AND UNIT ENHANCEMENT .....	8-1
READINESS ENHANCEMENT .....	8-1
COMMUNITY BENEFIT .....	8-1
COMMON INTEREST AND BENEFIT .....	8-1
NONCOMPETITIVE .....	8-1
NONPROFIT .....	8-1
TYPES OF COMMUNITY ASSISTANCE .....	8-2
NATIONAL EFFORTS .....	8-2
STATE AND LOCAL EFFORTS .....	8-3
SOCIAL IMPROVEMENTS .....	8-5
PUBLIC AFFAIRS CONSIDERATIONS .....	8-6
LEGAL IMPLICATIONS .....	8-6
SUMMARY .....	8-7

**CHAPTER 9 EDUCATION AND TRAINING** ..... 9-0

    CONCEPT ..... 9-0

    TRAINING TECHNOLOGIES ..... 9-2

    READINESS ..... 9-3

    RISK MANAGEMENT ..... 9-3

    PUBLIC AFFAIRS ..... 9-3

    ENVIRONMENTAL ASSISTANCE ..... 9-4

    DISASTER ASSISTANCE OPERATIONS ..... 9-4

    LAW ENFORCEMENT SUPPORT OPERATIONS ..... 9-5

    SUMMARY ..... 9-6

APPENDIX ..... A-1

GLOSSARY ..... Glossary-0

REFERENCES ..... References-1

---

## PREFACE

---

### PURPOSE

This manual provides the capstone doctrine for US Army and US Marine Corps domestic support operations. It also provides general information to civilian authorities at federal, state, and local levels involved in planning for and conducting such operations. It identifies linkages and defines relationships with federal, state, and local organizations and with other services that have roles and responsibilities in domestic support operations.

### SCOPE AND APPLICABILITY

This doctrine applies to all Army and Marine Corps commanders and staff tasked with planning, preparing for, and conducting domestic support operations. For overseas theaters, this doctrine applies to US unilateral operations only, subject to applicable host nation laws and agreements.

### USER INFORMATION

This publication was developed by the Army Doctrine Directorate at Headquarters, Training and Doctrine Command (HQ TRADOC) with the participation of the Doctrine Division (C42) at Marine Corps Combat Development Command (MCCDC). HQ TRADOC, with MCCDC, will review and update this publication as necessary. Send comments and recommendations directly to—

Commander  
HQ TRADOC  
ATTN: ATDO-A  
Fort Monroe, VA 23651-5000

or

Commanding General  
Doctrine Division (C42)  
MCCDC  
2042 Broadway Street, Suite 214  
Quantico, VA 22134-5021

Unless this publication states otherwise, masculine nouns and pronouns do not refer exclusively to men.

## INTRODUCTION

---

Domestic support operations are not new. They had their beginning with settlement of the new world and organization of the colonial militia. With the establishment of the United States and a federal military, the Army routinely provided support to state and territorial governors as the nation expanded westward. In some instances, it actually administered governmental affairs until the fledgling local government became a viable entity.

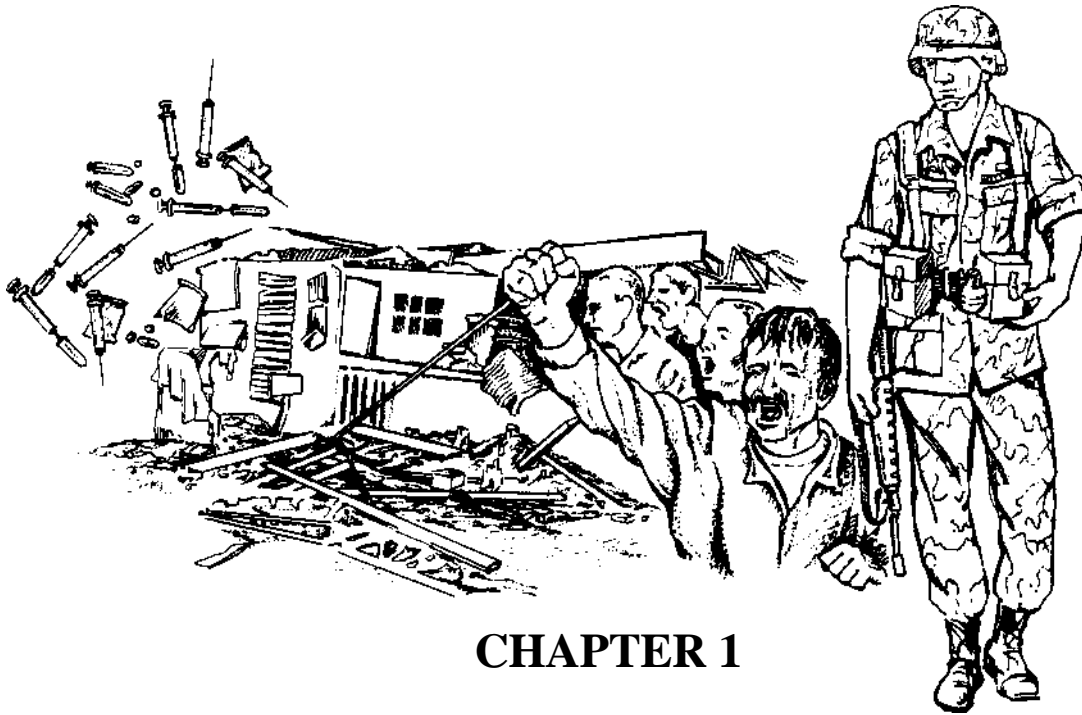
Congress has determined and the National Command Authorities have directed that the military should become more engaged in supporting domestic needs. In addition, the National Security Strategy “Domestic Imperative” affirmed that national security must be viewed in the context of the nation’s well-being.

Acknowledging the inherent capabilities the Army possesses for supporting federal, state, and local governments, the Congress has passed numerous laws providing for domestic military support. These laws recognize that the National Guard, while in state status, has primary responsibility for providing initial support when military assistance is required. They also institutionalize interdepartmental and interagency coordination/planning, linking it to the national strategy.

Commanders should anticipate requirements to provide emergency assistance and use domestic support opportunities to enhance unit and individual wartime skills. The Army, particularly the National Guard and Army Reserve, with its extensive combat support and combat service support (CS/CSS) structure, is ideally equipped to assist civil authorities in a wide variety of missions that fall into four general categories: disaster assistance, environmental assistance, law enforcement support, and community assistance.

Although the frequency of domestic support operations may increase, they are not in lieu of wartime operational requirements. The Army’s primary mission remains to defend the United States and its interests. It is the Army’s combat readiness that enables it to accomplish domestic support operations.

This manual provides specific guidelines and operational principles in the conduct of domestic support operations. It emphasizes the utilization of the Army’s core combat competencies and values to enhance combat readiness and the overall well-being of the nation.



## CHAPTER 1

### CONCEPT AND PRINCIPLES

---

*This chapter presents a brief historical perspective and concept of Army domestic support operations, the principles of operations other than war that apply to these operations, and a description of the Army's role. The Army consists of the active component (AC), the Army National Guard (ARNG), the US Army Reserve (USAR), and Department of Army (DA) civilians. The National Guard (NG), in a state or territorial status, has primary responsibility for providing military assistance to state and local civil authorities.*

---

#### HISTORY AND CATEGORIES OF DOMESTIC SUPPORT

**A domestic support operation is the authorized use of Army physical and human resources to support domestic requirements.**

Since the Army's inception, its mission has been to fight and win the nation's wars. At the same time, the Army has provided general military support to the

nation, including participation in a wide variety of activities to assist civilian authorities. The Army has enforced laws, quelled domestic violence and insurrection, combatted terrorism, participated in public works and environmental projects, and assisted in recovery operations following disasters.

The dramatic end of the Cold War caused significant changes in the nation's domestic and foreign priorities. During the Cold War, national attention was directed to the external threat and related issues. Today, along with a shift from a forward deployed to a force projection strategy is a new awareness of the benefits of military assistance to improve the nation's physical and social infrastructure. The Army's focus on and continuing involvement in all aspects of domestic support operations identified the need for published doctrine.

The Army's roles and responsibilities in domestic support operations divide into four primary categories: disaster assistance, environmental assistance, law enforcement support, and community assistance, as depicted in Figure 1-1.

## DISASTER ASSISTANCE.

From the earliest years of the republic, the Army has provided assistance to the country in times of disaster. During the final year of the Civil War, Army officers provided disaster relief through the Freedman's Bureau. The Army also played a direct role in many disaster relief operations in the late nineteenth century, including the great Chicago fire, the Johnstown flood, and the Charleston earthquake.

In recent years, Presidential and Congressionally mandated federal disaster assistance programs have evolved. The Army actively participates with federal and

state agencies in disaster assistance planning, exercises, and operations in response to both natural and man-made disasters.

Disaster assistance includes those humanitarian and civil defense activities, functions, and missions in which the Army has legal authority to act. The Army provides disaster assistance to states, the District of Columbia, territories, and possessions. Civil authorities must request assistance, usually as a result of disasters such as hurricanes, typhoons, earthquakes, or massive explosions.

## ENVIRONMENTAL ASSISTANCE

Environmental assistance has been evolving since the 1960s. The Army has provided a variety of resources to meet environmental challenges that have emerged as a result of increased public concern and demands for the restoration, conservation, and protection

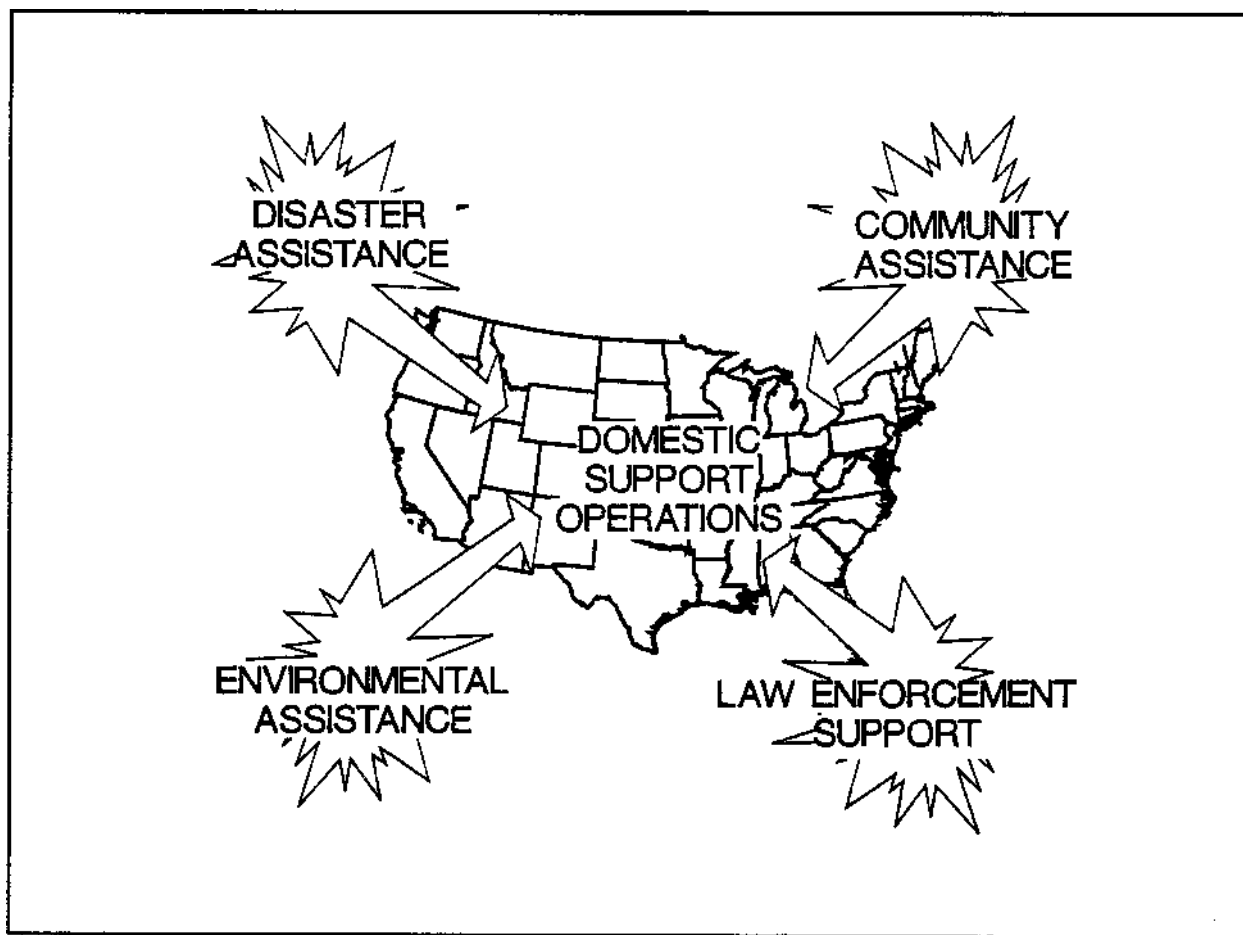


Figure 1-1. Domestic Support

of the environment. Typical missions are responding to hazardous material releases, restoring contaminated land and water, and conserving the nation's natural and cultural resources. With the passage of *The Comprehensive Environmental Response, Compensation, and Liability Act of 1980* and the later development of The National Oil and Hazardous Substances Contingency Plan, the Army became a member of the national and regional response teams that plan for and respond to hazardous substance spills.

The Army is inextricably linked to environmental stewardship. Its environmental assistance operations aid civil authorities in preserving, protecting, and enhancing the environment. Its strategy rests on the four pillars of compliance, restoration, prevention, and conservation.

- Compliance is responding to small-scale hazardous material spills and regulating support to other government agencies.
- Restoration is cleaning up contamination from past operations.
- Prevention is developing and sharing new technologies that reduce pollution generation.
- Conservation focuses on the preservation of natural and cultural resources such as wetlands and wildlands.

Army support in these areas may be initiated under disaster assistance or executed under separate authority.

#### LAW ENFORCEMENT

*The Posse Comitatus Act of 1878* severely restricts the use of federal forces to enforce public law. However, acting under Constitutional provisions, the Army has on many occasions been used to quell civil disturbances and restore order. Use of military force has ranged from the Whiskey Rebellion in 1794 to the urban riots of the 1960s and the Los Angeles riot of 1992.

In 1981, Congress passed The Military Cooperation with Civilian Law Enforcement Agencies Act to allow military collaboration with civilian law enforcement agencies. This act dramatically expanded the Army's participation in counterdrug efforts. Alliance and North Star are two examples of operations that use active and reserve component forces to halt the flow of contraband across United States borders.

Operations in support of law enforcement include assistance in counterdrug operations, assistance for civil disturbances, special security operations, combatting terrorism, explosive ordnance disposal (EOD), and similar activities. Some, by their nature, may become international in scope due to a linkage between domestic and international operations. Constitutional and statutory restrictions and corresponding directives and regulations limit the type of support provided in this area.

#### COMMUNITY ASSISTANCE

Throughout its history, the Army has been involved in community projects and operations, applying its skills, capabilities, and resources to the needs and interests of American communities. Efforts at the national level focus on contributions to the nation and generate public support for the Army. State and local efforts foster an open, mutually satisfactory, cooperative relationship among installations, units, and the local community.

The most frequently conducted domestic support operations involve community assistance. Army resources may be used to support civilian organizations to promote the community's general welfare. These missions and operations include public works, education, and training. Other examples include participation in minor construction projects and providing color guards for local events. In compliance with existing regulations and directives, the Army and local communities may establish mutual support agreements concerning medical, police, and emergency services.

## CONCEPT

**The Secretary of the Army is the DOD's executive agent for most domestic support operations.**

The National Command Authorities (NCA) direct the Army to conduct domestic and international operations. The Secretary of Defense has designated the Secretary of the Army as the executive agent for most domestic support operations. During these operations, military support supplements, rather than replaces, civil agency responsibilities.

The Army provides domestic support through Army posts, camps, installations, armories, and stations as members of the communities in which they are located. Commanders should maintain close liaison with local elected and appointed officials.

Domestic support ranges from disaster assistance to more frequently conducted community assistance activities. All domestic support operations share the common characteristic of using Army human and physical resources to enhance national security, thus contributing to the nation's overall well-being. These operations, which usually draw extensive media attention, must consider public affairs implications.

Environmental missions and operations are directed at the physical infrastructure of the nation. National and local efforts may be supported by Army organizations, activities, and units.

Law enforcement support helps civil law enforcement authorities maintain law and order. Laws, directives, and regulations restrict the Army from assuming the civil law enforcement mission.

Community assistance operations help meet national, state, or local community objectives. Intended to fill needs not met, they should avoid duplication or competition with the civilian sector.

The Army offers assistance, such as providing equipment or personnel to accomplish a specific task, to other federal, state, or local agencies. The Army's goal is to use its assets prudently for domestic support

operations while providing a significant benefit to the nation.

Civilian emergency management is almost universally organized on the "unmet needs" philosophy. Local jurisdictions, responsible for the security and welfare of their citizens, request assistance only when their resources are insufficient to meet requirements. Most states conform to the general outlines of this emergency management concept, as do their constituent county and local jurisdictions. Normally the state directs large-scale efforts, and commanders should establish liaison at that level. Disaster or emergency declarations are associated with legal and funding requirements.

A final facet of this concept is that Army commanders should be aware that exercising Army core competencies and demonstrating Army values are vital aspects of providing domestic support. Basic soldier skills in logistical support, engineering, medical care, and communications are but a few examples of competencies that can be exercised in both wartime and peacetime operations. Commanders should, when possible, use domestic support requirements to exercise basic soldier competencies, thereby enhancing individual and unit wartime capabilities. Additionally, domestic support operations provide excellent opportunities for soldiers to interface with the civilian community and demonstrate traditional Army values such as teamwork, success-oriented attitude, and patriotism. These demonstrations provide positive examples of values that can benefit the community and also promote a favorable view of the Army to the civilian population.

## PRINCIPLES OF OPERATIONS OTHER THAN WAR

Domestic support operations occur under various scenarios and conditions. Regardless, the six principles for the conduct of operations other than war—objective, unity of effort, legitimacy, perseverance, restraint, and security—apply. A discussion of each follows.

- Objective - *Direct every military operation toward a clearly defined, decisive, and attainable objective.* All commanders and soldiers must understand the objective and integrate their efforts with those of the supported civil



authorities to achieve it. The concepts of mission, enemy, troops, terrain, and time available (METT-T) determine intermediate or subordinate objectives that must be accomplished to achieve the primary objective.

- *Unity of effort - Seek unity of effort toward every objective.* Commanders must seek, establish, and maintain unity of effort. In most crisis situations, they will be in support and under the general direction of civil authorities. They must coordinate closely with these authorities and clearly understand the lines of authority and control. Unity of effort also requires coordination and cooperation among the other federal agencies involved. Almost all domestic support operations will be conducted in a joint and interagency environment. Although unity of command may not be possible since command structures vary, the requirement for unity of effort remains.
- *Legitimacy - Sustain the people's willing acceptance of the right of the government to govern or of a group or agency to make and carry out decisions.* Legitimacy derives from the perception that using military force is a legal, effective, and appropriate means of exercising authority for reasonable purposes. However, the issue of legitimacy demands caution and critical judgment. The Army must be aware of the legitimate interests, prerogatives, and authority of the various levels of civil government involved and act accordingly. If the Army aids in the solution of a domestic problem but detracts from the legitimacy of the national or state governments by so doing, its actions will be detrimental to the federal government's long-term strategic objectives.
- *Perseverance - Prepare for the measured, protracted application of military capabilities in support of strategic aims.* Domestic support operations may require years to achieve desired effects. They may not have a clear beginning or end decisively. For example, the Army's involvement in counterdrug operations, which began in 1981, remains active.
- *Restraint - Apply appropriate military capability prudently.* Specific rules of engagement govern

the disciplined application of force. In operations other than war, these rules will be more restrictive, detailed, and sensitive to political concerns and may change frequently during operations. Restraints on weaponry, tactics, and levels of force characterize domestic support operations.

- *Security - Never permit hostile forces to acquire an unexpected advantage.* The Army must never be lulled into believing that the nonhostile intent of a mission involves little or no risk. Individuals or groups may wish to take advantage of a crisis situation for personal gain or to make a political statement. Commanders must be ready to counter activity that could bring harm to their units or jeopardize their mission. Disaster assistance operations focus on alleviating human suffering, but as Army forces involved in 1992 Hurricane Andrew relief discovered, prevention of looting and protection of supplies are also necessary.

## THE ARMY'S ROLE

**The National Guard in a nonfederal status has the primary responsibility for providing military assistance to state and local governments.**

In domestic support operations, the Army recognizes that National Guard forces, acting under the command of their respective governors in a state (nonfederal) status, have the primary responsibility for providing military assistance to state, territorial, and local governments. When state and National Guard resources need supplementation and the governor requests it, the Army will, at the direction of the NCA, assist civil authorities.

*During massive flooding of the Mississippi River and its tributaries in the summer of 1993, more than 7000 National Guardsmen from the states of Arkansas, Illinois, Iowa, Kansas, Missouri, and Wisconsin were called to state active duty to provide relief to flood victims. Their duties included providing fresh water, security, evacuation, reconnaissance and traffic control, plus sandbagging, hauling, and dike reinforcement support for the duration of the emergency.*

The Army provides this support at federal, state, and local levels. For example, it may help a state or local community by providing disaster relief or it may provide medical personnel and transportation for a state's firefighting effort. Another example is aiding governmental agencies in cleaning up the environment. The Army may also be designated a lead agent for a

specific operation, such as urban search and rescue (US&R) under the Federal Response Plan (FRP), the document that directs federal response to natural disasters such as earthquakes, hurricanes, typhoons, tornadoes, and volcanic eruptions; technological emergencies involving radiological or hazardous material releases; and other incidents requiring federal assistance as prescribed by law. The FRP provides standing mission assignments to selected governmental and nongovernmental organizations to carry out specific emergency support functions (ESFs). Each type of assistance may require an extensive commitment of resources, depending on the nature and scope of the operation, and close coordination with federal, state, or local officials.

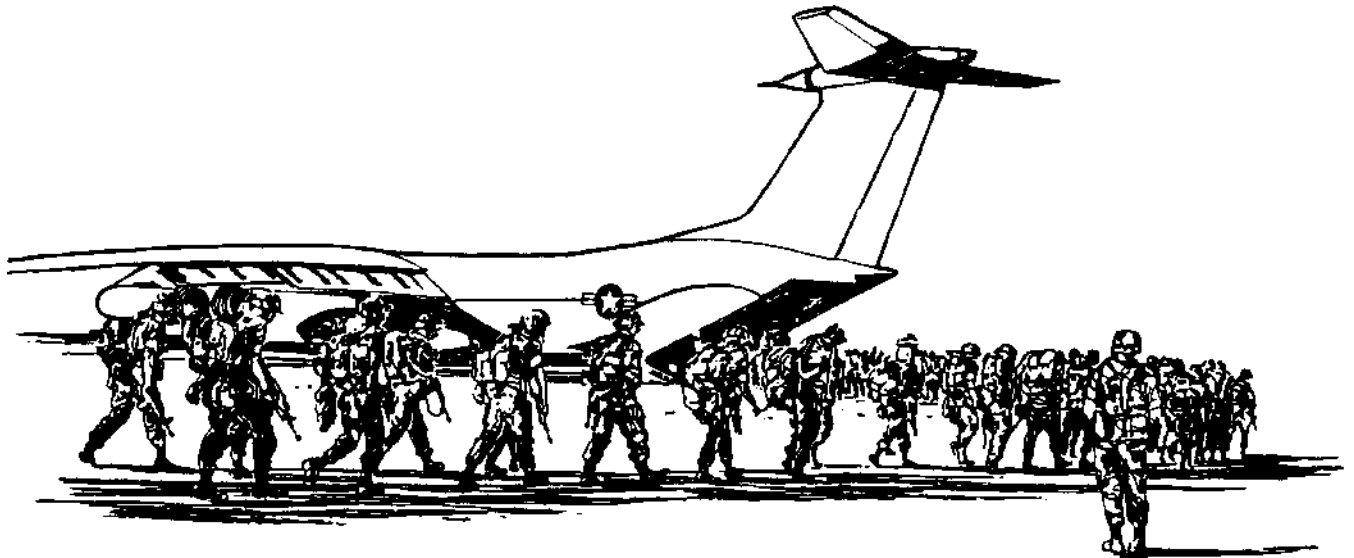
Army commanders will frequently coordinate with civilian emergency managers, both professional and volunteer. They are often referred to as the "coordinators of emergency services" or similar titles and, in smaller jurisdictions, may be the fire chief, police chief, or other official. The Army will—

- Establish achievable objectives.
- Establish clear termination standards.
- Tailor forces to the mission.

## SUMMARY

The Army, composed of the AC, ARNG, USAR, and DA civilians, has a long and proud tradition of providing domestic support to the nation. It ranges from less demanding operations such as community activities to high-intensity crisis situations. Principles of operations other than war provide the Army a conceptual foundation on which to conduct domestic support operations. Although the National Guard has primary responsibility for developing plans and providing support to state and local governments, the national shift from a forward deployed to a force projection strategy has brought a new awareness of the benefits the Army can provide to America.

---



## CHAPTER 2

### ROLES AND RESPONSIBILITIES

---

*Army support to federal, state, and local agencies covers a broad range of activities, events, and occurrences. The type of domestic support may vary from a static display at a local fair to a large deployment of troops, material, and supplies in response to a natural disaster. The scope may vary from involvement at the local community to massive operations covering a multistate or international arena. Depending on the type and scope of required support, the civil authorities and organizations that Army commanders assist will also vary greatly. These organizations are addressed in this chapter in terms of their roles and responsibilities in disaster assistance, environmental assistance, law enforcement, and community assistance operations. Also addressed are the Department of Defense agencies and commands that have significant responsibilities for providing domestic support.*

---

#### THE PRESIDENT

**The Army will conduct domestic support operations in a joint and interagency environment.**

---

The President, as the Chief Executive Officer of the US Government and Commander-in-Chief of all US

military forces, authorizes the use of federal resources for domestic support operations. During disasters or other periods of national emergency, the President provides guidance and direction to federal departments, agencies, activities, and other organizations. The President does this by declaring, usually at the request of a governor, a disaster or emergency and appointing a federal coordinating officer (FCO) to coordinate federal-level assistance.

The President also provides leadership and direction in other areas that may generate Army support, for example, drug abuse, the social and physical

2-1 infrastructure, and environmental pollution. The President may further assist in resolving these issues by committing federal resources or by proposing new programs.

### **FEDERAL AGENCIES OTHER THAN DOD**

Although not all-inclusive, the following list includes those organizations that have significant responsibilities in the categories of assistance addressed in this manual.

#### **DEPARTMENT OF AGRICULTURE (USDA)**

As the lead agency for food and firefighting under the FRP, the USDA has significant responsibilities in disaster assistance operations. The US Forest Service (USFS), an agency under the USDA, is responsible for leading firefighting efforts as well as protecting forest and watershed land from fire. Jointly with the Department of Interior (DOI), the USFS controls the National Interagency Fire Center (NIFC) in Boise, Idaho. The NIFC, in turn, provides national coordination and logistical support for federal fire control.

The USDA is scientifically and technically capable of measuring, evaluating, and monitoring situations where hazardous substances have impacted natural resources. In that regard, the USDA can also support environmental assistance operations involving cleanup of hazardous substances.

#### **THE AMERICAN RED CROSS (ARC)**

The ARC, under charter from Congress, is America's official volunteer disaster relief agency. In that capacity, it has a major role in disaster assistance operations, having been designated the lead agency for mass care under the FRP. Due to the general nature of its charter, it can provide support in environmental assistance, law enforcement, and selected community assistance operations.

#### **DEPARTMENT OF COMMERCE (DOC)**

The DOC provides fire and weather forecasting as needed from the NIFC or from a nearby weather forecasting facility. Through the National Oceanic and Atmospheric Administration, it provides scientific support for response and contingency planning in coastal

and marine areas. Support includes hazard assessments, trajectory modeling, and information on the preparedness and sensitivity of coastal environments to hazardous substances. Based on its responsibilities and capabilities, DOC can provide support in both disaster and environmental assistance operations.

#### **DEPARTMENT OF EDUCATION (DOEd)**

The DOEd establishes policy for, administers, and coordinates most federal assistance to education. It supports information and planning for disaster and environmental assistance operations. The DOEd may also become involved in selected Army community assistance programs that address education and training.

#### **DEPARTMENT OF ENERGY (DOE)**

As the FRP's lead agency for energy, the DOE provides the framework for a comprehensive and balanced national energy plan through the coordination and administration of the federal government's energy functions. The DOE—

- Provides nuclear technical assistance and executive national coordination with the oil, gas, electric power, and solid fuels industries.
- Coordinates international emergency responses with the International Energy Agency and with the International Atomic Energy Agency.
- Coordinates supporting resources for the energy industries involved with catastrophic disaster response and recovery.
- Plays a supporting role in disaster and environmental assistance operations.

#### **ENVIRONMENTAL PROTECTION AGENCY (EPA)**

As the lead agency for hazardous material response under the FRP, the EPA has a significant role and responsibilities in both disaster and environmental assistance operations. It provides for a coordinated response by federal departments and agencies, state and local agencies, and private parties to control oil and hazardous substance discharges or substantial threats of discharges. In selected operations, it coordinates closely with the US Coast Guard (USCG), which is responsible for conducting hazardous material operations over coastal and inland waterways.

**FEDERAL EMERGENCY MANAGEMENT AGENCY (FEMA)**

The FEMA is the federal government’s executive agent for implementing federal assistance to a state and its local governments. In most cases, it implements assistance in accordance with the FRP. Organized into ten federal regions that provide support on a national basis, FEMA may be involved in either disaster or environmental assistance operations. Figure 2-1 depicts those regions.

**GENERAL SERVICES ADMINISTRATION (GSA)**

The GSA is the lead agency for resource support under the FRP. Having extensive expertise both in

contracting and providing services, GSA is an invaluable player in both disaster and environmental assistance operations.

**DEPARTMENT OF HEALTH AND HUMAN SERVICES (DHHS)**

The DHHS is the lead agency for health and medical services under the FRP. The Public Health Service (PHS), an agency under the DHHS, leads this effort by directing the activation of the National Disaster Medical System (NDMS). The DHHS is also responsible for assisting with the assessment of health hazards at a response site and the protection of both response workers and the general public. Agencies

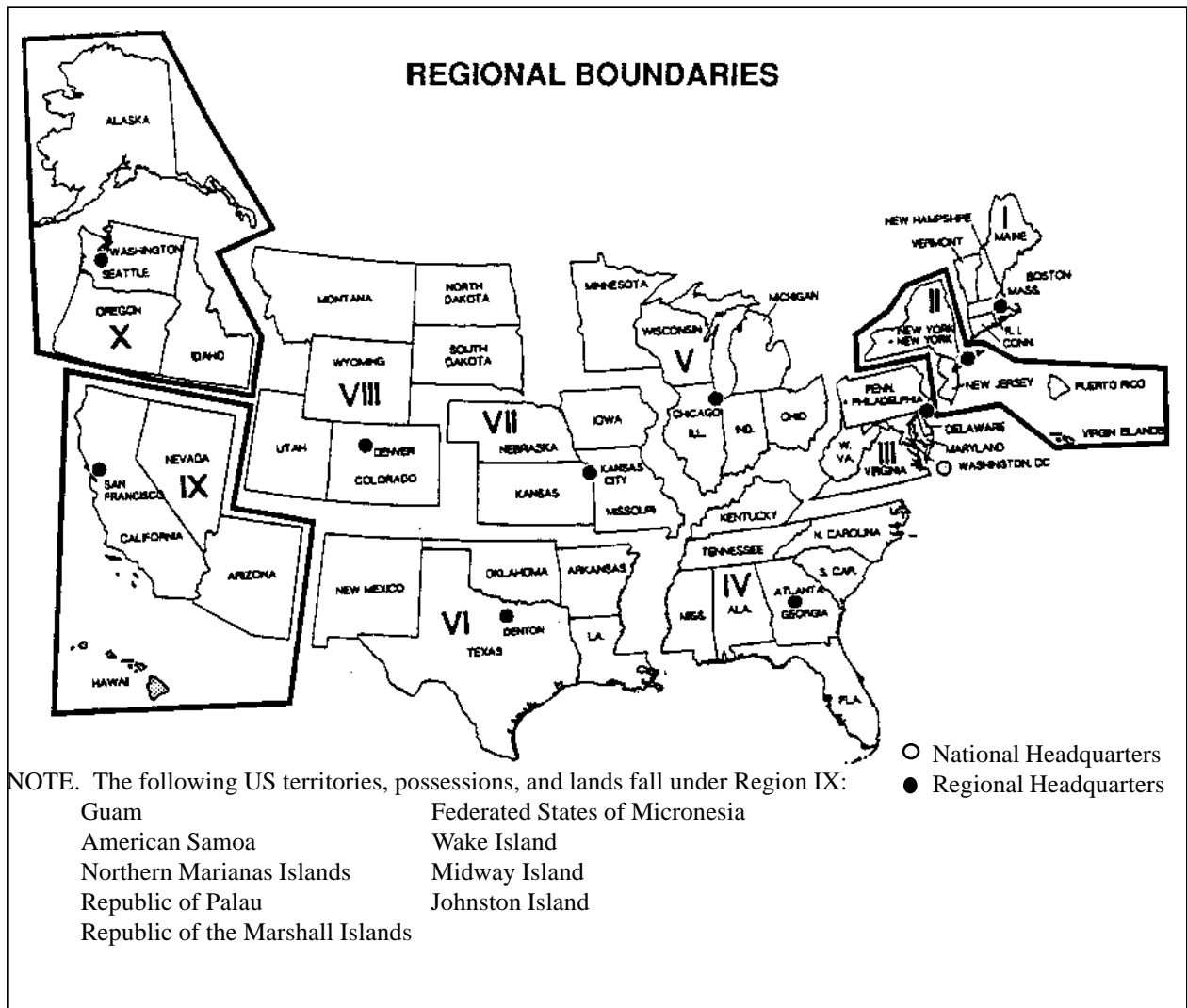


Figure 2-1. Federal Emergency Management Agency

within DHHS that have relevant responsibilities, capabilities, and expertise are the Agency for Toxic Substances and Disease Registry and the National Institute for Environmental Health Sciences. The DHHS provides support for both disaster and environmental assistance operations and may also become involved in selective Army community assistance operations that provide medical support to disadvantaged communities.

### **DEPARTMENT OF INTERIOR**

As a support agency under the FRP, the DOI provides support for disaster and environmental assistance operations. It also has major responsibility for American Indian reservations and for people who live in island territories under United States administration. Operating the NIFC jointly with the Department of Agriculture, the DOI has expertise on, and jurisdiction over, a wide variety of natural resources and federal lands and waters.

### **DEPARTMENT OF JUSTICE (DOJ)**

The DOJ plays a significant role in law enforcement and counterdrug operations. The Drug Enforcement Administration (DEA) is DOJ's lead agency for counterdrug operations. As the government's representative in legal matters, the DOJ may become involved in law enforcement operations, community assistance operations, and disaster and environmental assistance operations, providing legal advice on questions arising from oil and hazardous substance spills. The Attorney General supervises and directs US attorneys and US marshals in the various judicial districts. The DOJ has oversight authority for the Immigration and Naturalization Service (INS) and serves as the lead agency for operations involving illegal mass immigration. The Federal Bureau of Investigation (FBI) is an arm of DOJ.

### **DEPARTMENT OF LABOR (DOL)**

The DOL, through the Occupational Safety and Health Administration, conducts safety and health inspections of hazardous waste sites and responds to emergencies. It must assure that employees are being protected and determine if the site is in compliance with safety and health standards and regulations. The DOL can thus become a support agency for disaster and environmental assistance operations.

### **NATIONAL COMMUNICATIONS SYSTEM (NCS)**

As the lead agency for communications under the FRP, the NCS consists of representatives of 23 federal agencies and operates under the authority of the General Services Administration. The NCS provides communications support to federal, state, and local response efforts and is charged with carrying out the National Telecommunications Support Plan to ensure adequate communications following a disaster. It also provides technical communications support for federal fire control. Administratively structured, the NCS consists of an executive agent, a manager, a committee of principles, and the telecommunications assets.

### **NUCLEAR REGULATORY COMMISSION (NRC)**

Responsible for the Federal Radiological Emergency Response Plan (FRERP), the NRC responds to the release of radioactive materials by its licensees. It provides advice in identifying the source and character of other hazardous substance releases when the commission has licensing authority for activities using radioactive materials. The NRC may serve in a support role in disaster and environmental assistance operations.

### **DEPARTMENT OF STATE (DOS)**

The DOS advises the President in the formulation and execution of foreign policy. Its primary mission in the conduct of foreign relations is to promote the interests of the United States overseas. In this capacity, the DOS manages the US Agency for International Development and the US Information Agency. The DOS also has a support role in disaster or environmental assistance events or domestic counterdrug operations having international implications.

### **DEPARTMENT OF TRANSPORTATION (DOT)**

As the lead agency for transportation under the FRP, the DOT coordinates federal transportation in support of federal agencies, volunteer agencies, and state and local governmental entities. It has support roles in ten other ESFs of the FRP. A subordinate agency of the DOT during peacetime, the US Coast Guard conducts counterdrug operations and, in conjunction with the EPA, hazardous material operations. The DOT and the USCG have major roles in disaster and environmental assistance operations. The DOT provides expertise regarding transportation of oil or hazardous substances by all modes of transportation.

## DEPARTMENT OF TREASURY

The Department of Treasury, through its agency, the US Customs Service (USCS), regulates goods, people, and vehicles entering or leaving the United States and its territories. The USCS assesses and collects duties on imports and controls merchandise to prevent smuggling of contraband, including narcotics. As one of the primary federal agencies involved in support of law enforcement, the USCS plays a support role in planning for disaster or environmental assistance operations. Through the US Secret Service (USSS), the Department of Treasury is responsible for providing security for the President, the Vice-President, and visiting heads of state. The USSS can request the aid of the military—in particular, military police, military working dogs, and explosive ordnance disposal and signal personnel—in the conduct of security and protection missions.

## NATIONAL WEATHER SERVICE (NWS)

The NWS predicts, tracks, and warns of severe weather and floods. It plays a support role in disaster or environmental assistance operations.

## DEPARTMENT OF DEFENSE

The DOD is the lead agency for public works and engineering, as well as urban search and rescue under the FRP. It has support roles in the 10 other ESFs, frequently becoming involved in disaster or environmental assistance operations. If directed by the President, DOD may provide support to law enforcement operations and selected community assistance initiatives. A diagram of DOD is at Figure 2-2.

### SECRETARY OF DEFENSE (SECDEF)

The SECDEF has designated the Secretary of the Army (SA) as the DOD executive agent for providing DOD domestic support operations. These responsibilities are outlined in existing policies, procedures, and directives.

### SECRETARY OF ARMY

As the DOD executive agent for domestic support operations, the SA develops necessary planning guidance, plans, and procedures. The SA has authority to task DOD

components to plan for and to commit DOD resources in response to requests for military support from civil authorities. Any commitment of military forces of the unified and specified commands must be coordinated in advance with the Chairman, Joint Chiefs of Staff (CJCS). The SA uses the inherent authority of his office to direct Army assistance to domestic support operations. A diagram of the Department of the Army is at Figure 2-3.

### DIRECTOR OF MILITARY SUPPORT (DOMS)

The DOMS, a general officer appointed by the SA, is the DOD primary contact for all federal departments and agencies during periods of domestic civil emergencies or disaster response. On behalf of the DOD, the DOMS and his supporting staff, serving as a joint staff, ensure the planning, coordination, and execution of many domestic support operations.

### UNIFIED COMMANDS

Selected commanders-in-chief (CINCs) have domestic support responsibilities, some of which are addressed below. More specific CINC responsibilities for civil assistance missions are identified in appropriate DOD directives, guidelines, and operational plans.

#### Commander-in-Chief, Forces Command (CINCFOR)

The CINCFOR serves as the DOD principal planning and operating agent for military support to civil authorities for all DOD components in the 48 contiguous states and the District of Columbia.

#### Commander-in-Chief, Atlantic Command (CINCLANT)

The CINCLANT serves as the DOD principal planning and operating agent for military support to civil authorities for all DOD components within the Atlantic command area of operations (AO).

#### Commander-in-Chief, Pacific Command (CINCPAC)

The CINCPAC serves as the DOD principal planning and operating agent for military support to civil authorities for all DOD components within the Pacific command AO.

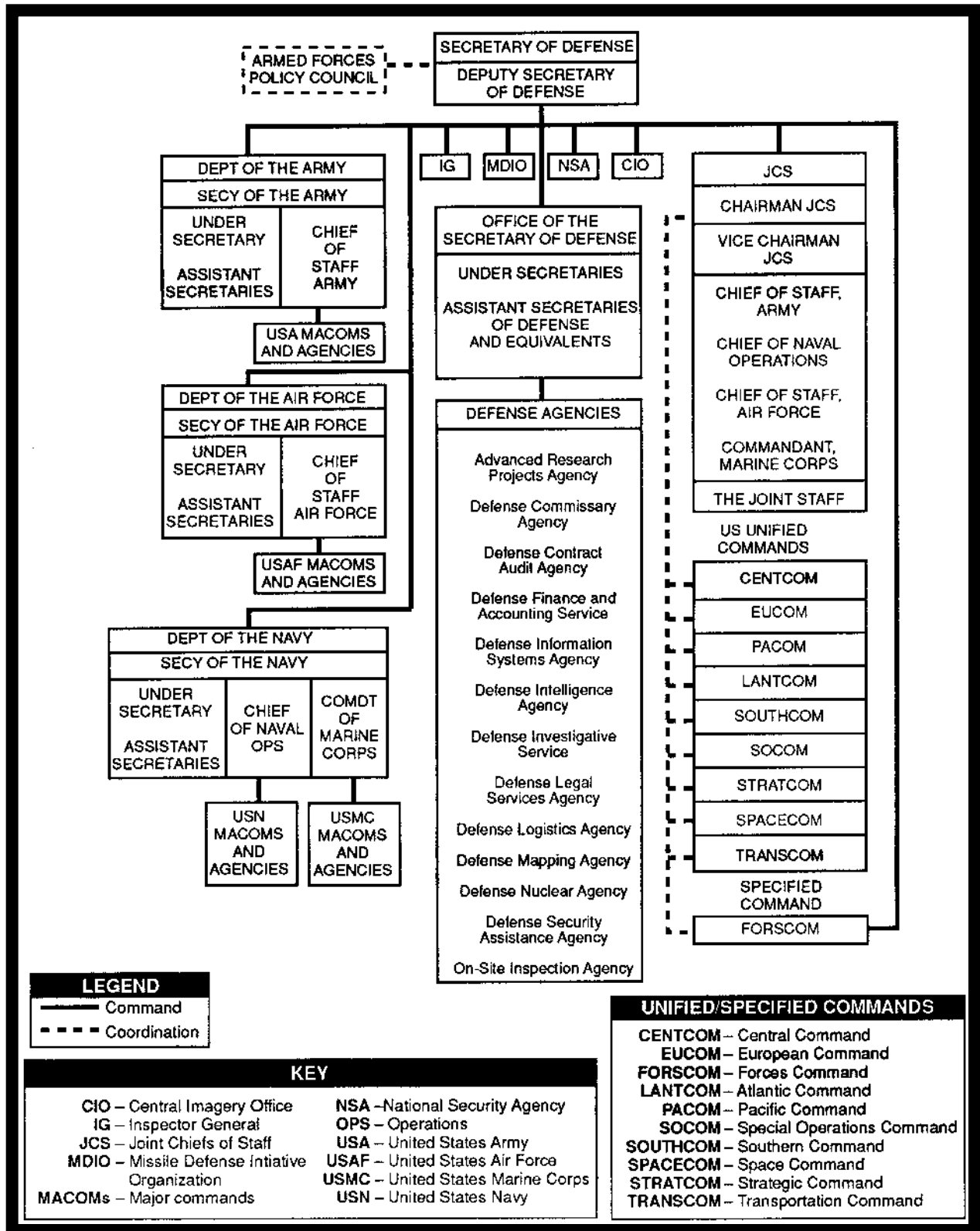


Figure 2-2. Department of Defense



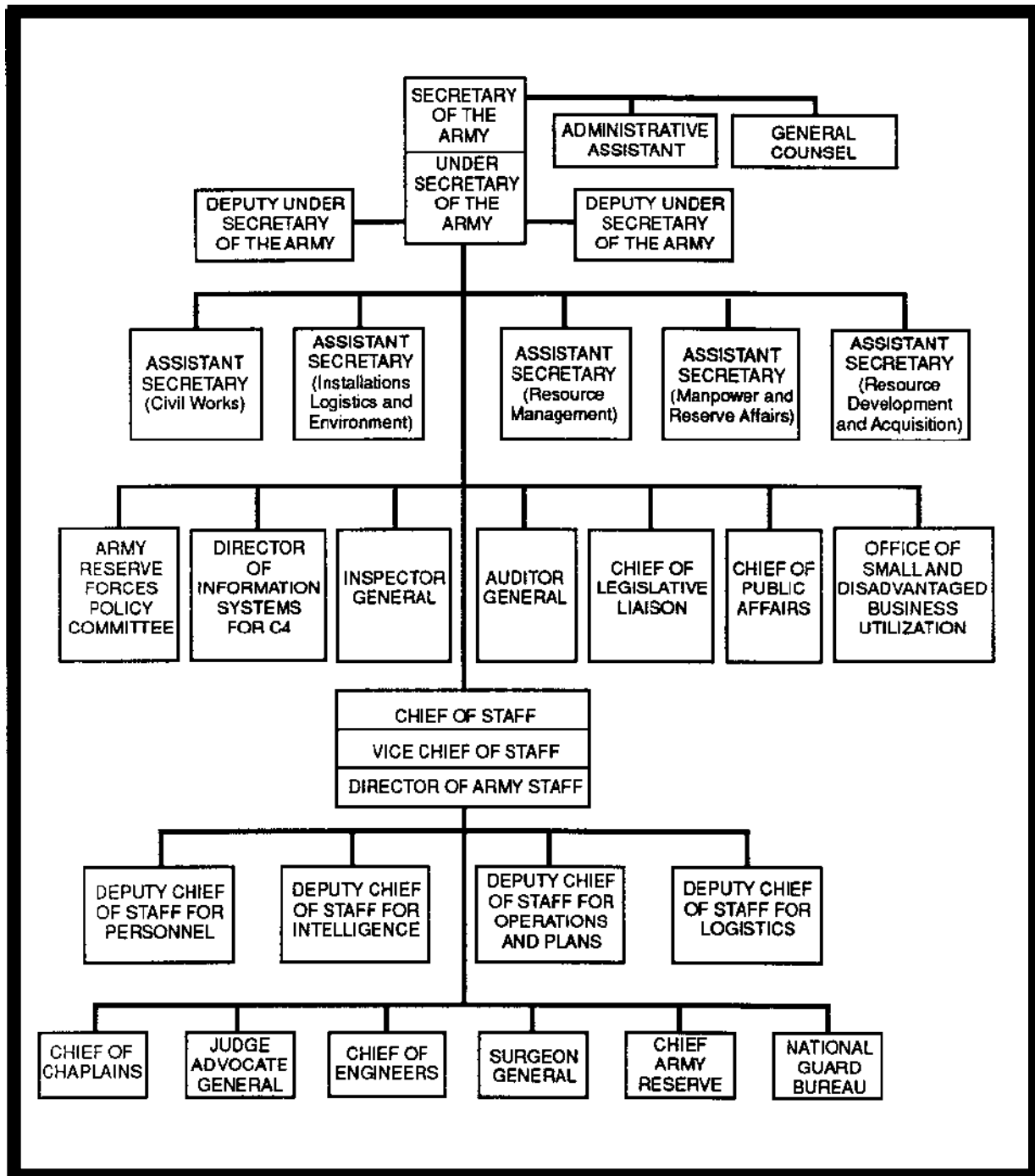


Figure 2-3. Department of Army

### **Commander-in-Chief, Transportation Command (CINTRANS)**

The CINTRANS serves as the DOD single manager for transportation, providing air, land, and sea transportation to meet national security objectives. The CINTRANS has combatant command (COCOM) of the Military Traffic Management Command, Air Mobility Command, and Military Sealift Command, collectively known as the transportation component commands.

### **Defense Logistics Agency (DLA)**

The DLA supports civil disturbance operations under the provisions of OPLAN GARDEN PLOT, the National Civil Disturbance Plan, with wholesale logistics support for military assistance in disasters.

### **DEFENSE COORDINATING OFFICER (DCO)**

A CINC appoints the DCO to serve as the DOD single point of contact to the federal coordinating officer for providing DOD resources during disaster assistance. The DCO should collocate with the FCO and coordinates all FEMA mission assignments for military support. The DCO usually has operational control of all DOD forces deployed to support the federal effort. A defense coordinating element (DCE) will be organized to provide support staff for the DCO in the disaster area. The size and composition of the DCE is situation-dependent.

### **NATIONAL GUARD**

#### **National Guard Bureau (NGB)**

The NGB is the federal coordination, administrative, policy, and logistical center for the Army and the Air National Guard (ANG). It serves as the legal channel of communication among the United States Army, the United States Air Force, and the National Guard in the 54 states and territories. The Chief, National Guard Bureau, has executive agent responsibility for planning and coordinating the execution of military support operations. The Director, Army National Guard (DARNG), in coordination with the Director, ANG, is responsible to the Chief, NGB. NG commanders are responsible for planning and training their forces for both their federal and state missions.

### **State Area Command (STARC)**

The STARC is a mobilization entity in each state and territory. It organizes, trains, plans, and coordinates the mobilization of NG units and elements for state and federal missions. The STARC is responsible for emergency planning and response using all NG resources within its jurisdiction. It directs the deployment and employment of ARNG units and elements for domestic support operations, including military support to civil authorities. As with active duty forces, emergency response may be automatic or deliberate. When the NG is in a nonfederal status, the governor serves as commander-in-chief of the NG in his state or territory and exercises command through the state adjutant general (TAG). While serving in state status, the NG provides military support to civil authorities, including law enforcement, in accordance with state law. Federal equipment assigned to the NG may be used for emergency support on an incremental cost-reimbursement basis.

### **US Property and Fiscal Officers (USPFOs)**

USPFOs are Title 10 officers assigned to the NGB and detailed for duty at each state or territory. They are accountable for all federal resources (equipment, dollars, and real estate) provided to the NG of each state. The USPFO staff provides supply, transportation, internal review, data processing, contracting, and financial support for the state's NG. When required, the USPFO can operate as a support installation for active component or USAR forces on a reimbursable basis.

### **Emergency Preparedness Liaison Officers (EPLOs)**

Representatives from the services are EPLOs to each state NG. As service planning agents' representatives to TAGs and STARCs, they plan and coordinate the execution of national security emergency preparedness (NSEP) plans, performing duty with the STARCs. EPLOs are Army, Navy, and Air Force Reservists who have been specifically trained in disaster preparedness and military support matters. Each reports to an active duty program manager or planning agent in his or her respective service who has responsibility and authority to provide (or seek further approval of) military support to the state.

EPLOs must have a comprehensive knowledge of their respective service facilities. They must also monitor and update their portion of the DOD Resource Data

Base (DODRDB). Upon appointment of the DCO, EPLOs may be ordered to active duty to serve as liaison representatives to the STARCs and their respective services.

### **US ARMY RESERVE**

The USAR is capable of extensive domestic support operations. This assistance and support may include the use of equipment and other resources, including units and individuals. USAR personnel may be activated in a volunteer status when ordered to active duty in lieu of annual training or after the President has declared a national emergency.

### **MAJOR COMMANDS (MACOMs)**

MACOM commanders may provide domestic support operations in accordance with authorized agreements they have reached with civil authorities in their surrounding communities or as directed by higher headquarters. Specifically, they may provide resources for disaster relief upon request, generally placing these resources under the operational control of the military commander in charge of relief operations.

### **US Army Health Services Command (HSC)**

The HSC, as requested by the supported CINC, provides health service support (HSS) resources, including clinical personnel under the Professional Officer Filler System (PROFIS), for all categories of domestic support operations. These resources are normally attached to, or placed under the operational control of, a supported CINC HSS unit for the duration of the operation.

### **Continental US Army (CONUSA) Commanders**

CONUSA commanders provide regional military support to civil authorities by planning for and conducting disaster relief operations within their areas of responsibility. They also establish and maintain disaster relief liaison with appropriate federal, state, and local authorities, agencies, and organizations.

### **US Army Corps of Engineers (USACE)**

The USACE is organized into geographically dispersed (CONUS and OCONUS) division and district subordinate commands. The USACE commander also serves as the chief of engineer soldier forces and in that

capacity guides the Army staff in their utilization. The USACE's mission is to provide quality, responsive engineering service to the nation. The command applies substantial expertise to the areas of operation and maintenance of the national waterway infrastructure, environmental restoration and remediation, project planning and management, coordination of complex interagency or regional technical issues, and disaster planning and response. The USACE serves as DOD's lead agent, in direct support of FEMA, for public works and engineering in the FRP. Figure 2-4 depicts USACE division and district regulatory boundaries.

### **US Army Materiel Command (USAMC)**

The USAMC may organize and deploy a logistics support element for domestic support operations. It provides supply, maintenance, technical assistance, and other services to the units. In addition, the logistics support element may organize a humanitarian depot to receive, store, and distribute relief supplies. The USAMC is the Army's executive agent for chemical and nuclear accidents and incidents.

## **STATE AND LOCAL GOVERNMENT**

This section addresses general state and local government responsibilities for responding to disaster assistance operations. Responsibilities for environmental assistance, support of law enforcement, and community assistance are discussed in chapters specifically addressing those operations. State and local government officials, operating under authority granted by state constitutions and local charters, are responsible for most of the daily safety and security issues that impact on their citizens' quality of life. State and local officials have primary responsibility for emergency preparedness planning and responding to emergencies.

Historically, NG units, under control of state governors and TAGs, have been the primary military responders in emergencies. Using federal military forces to support state and local governments is the exception rather than the norm. Federal forces are normally used only after state resources have been exhausted.

**STATE RESPONSIBILITIES**

**Governor**

A state governor is empowered by the US Constitution and each respective state constitution to execute the laws of the state and to command the state's NG when it is serving in state status. Governors are also responsible for issuing Executive Orders declaring "states of emergency" and ensuring that state agencies plan for actions in the event of a disaster.

Once a disaster occurs, the governor assesses its extent and determines if local government requests for assistance should be honored. If appropriate, the governor declares a state of emergency, activates the state response plan, and may call up the NG. The governor gives the NG its mission and determines when Guard forces can be withdrawn. In the event a disaster exhausts state resources, the governor may petition the President for federal assistance.

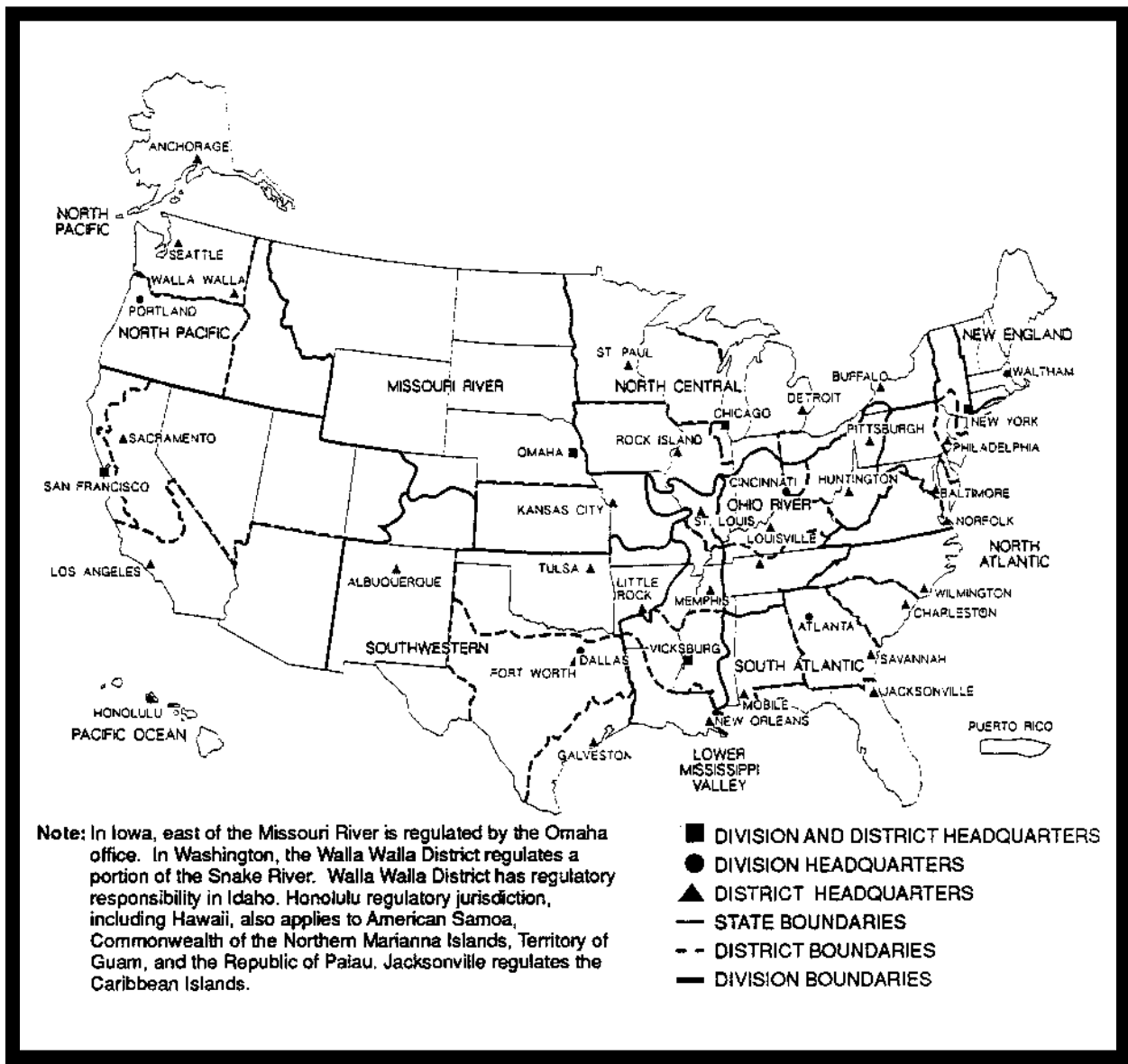


Figure 2-4. Corps of Engineers Division and District Regulatory Boundaries

**Office of Emergency Services (OES)**

All states have a specific agency that coordinates emergency preparedness planning, conducts emergency preparedness training and exercises, and serves as the governor’s coordinating agency in an emergency. The titles of these offices vary from state to state, for example, Division of Emergency Government, Emergency Management Agency, Department of Public Safety, or Office of Emergency Preparedness. This manual refers to this office using the generic term Office of Emergency Services. A diagram depicting a typical structure for state and local operational emergency services organizations and their linkages with equivalent federal organizations is at Figure 2-5.

Generally, the OES is either organized as a stand-alone office under the governor or aligned under TAG or the state police. It operates the state emergency operations center during a disaster or emergency and coordinates with federal officials for support if required. A diagram depicting typical organizations involved in state and local emergency response is at Figure 2-6.

**The Adjutant General.** The state NG is the governor’s primary response force in an emergency. The TAG, through the STARC (specifically the Plans, Operations and Military Support Officer (POMSO)) coordinates emergency response plans for

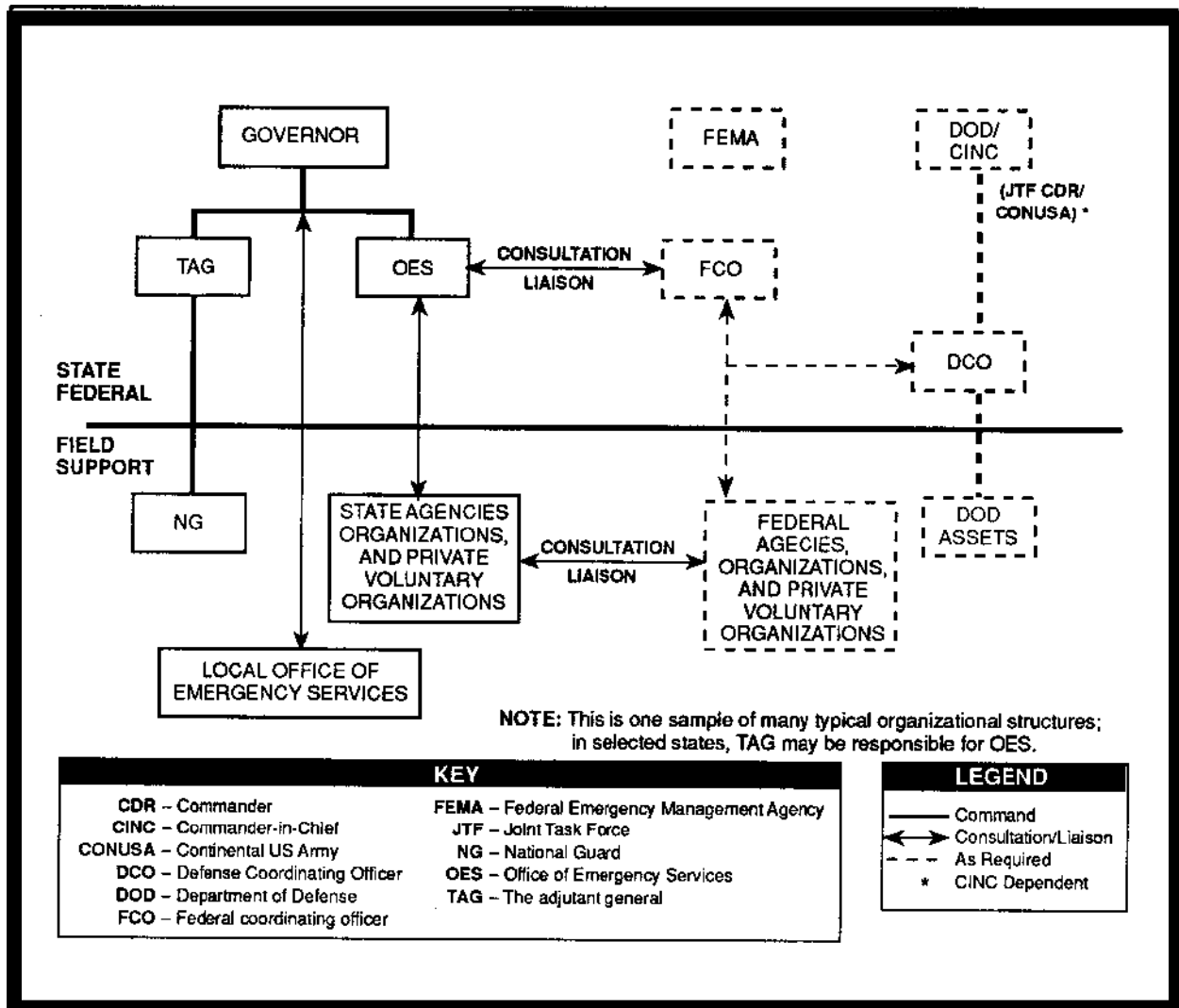


Figure 2-5. State/Local Operation Emergency Services Organization

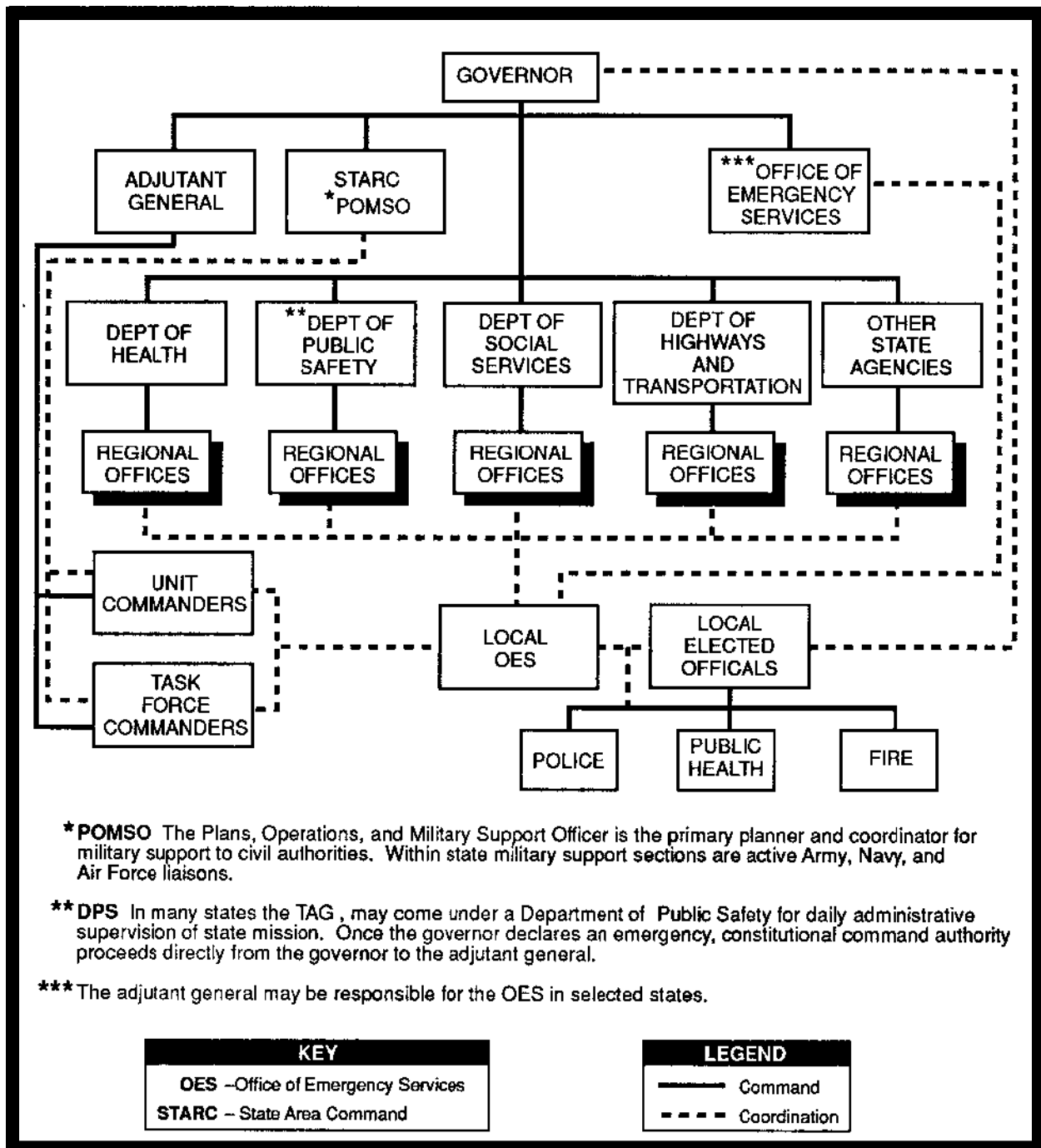


Figure 2-6. State and Local Emergency Response

disasters and emergencies. TAG is in command of state NG forces called to state active duty.

### **Plans, Operations, and Military Support Officer**

The POMSO plans for disaster response and recovery operations within the full spectrum of military support missions. Within each state, the POMSO coordinates training plans and exercises between the state NG and federal, state, and local emergency management agencies. The POMSO will serve as the NG point of contact with DOD officials during a federal emergency or disaster.

### **State Government Agencies**

State government departments and agencies prepare emergency response plans for their areas of specialization. They also participate in emergency preparedness exercises and respond according to plan.

### **LOCAL RESPONSIBILITIES**

Within their respective communities, mayors, city managers, local police and fire protection officials, county executives, sheriffs, prosecuting attorneys, and public health officials are some of the people responsible for law enforcement, safety, health, and fire protection on a daily basis. They are responsible for developing appropriate emergency response plans and responding to emergencies within their jurisdictions. Most local jurisdictions have an OES to plan and coordinate actions in an emergency. In many cases, local jurisdictions have mutual aid agreements with other jurisdictions that allow for firefighter and police assistance. Once local officials determine that an emergency is beyond the scope of their resources or ability to respond, the senior local official is responsible for requesting additional assistance from the state governor.

## **SUMMARY**

*The Army may support or coordinate with many federal, state, and local governmental departments and agencies as it conducts domestic support operations. Although the Army is seldom the lead agency in disaster assistance operations, it is a support agency for all the FRP's emergency support functions. Almost all Army domestic support operations will be conducted in a joint or interagency environment. Throughout our history, the Army has provided community support at the national level and support to its surrounding communities. The Army also has a long history of providing domestic support and will continue to provide that assistance in the future.*

---



## CHAPTER 3

# LEGAL CONSIDERATIONS AND CONSTRAINTS

*The Constitution, laws, regulations, policies, and other legal issues limit the use of federal military personnel in domestic support operations. This chapter presents an overview of those considerations and constraints.*

### CIVILIAN CONTROL OF THE MILITARY

**Commanders should discuss plans, policies, programs, exercises, funding, and operations with their**

**legal advisors.**

Under the Constitution of the United States, Congress has the authority to raise and support an army, provide and maintain a navy, and make rules for governing and regulating the land and naval forces. The Constitution places the military under civilian control and designates the President as commander-in-chief. Statutes provide for civilian leadership in the form of a secretary of defense, service secretaries, and various other civilian authorities.

The unique capabilities of the military enable it to support federal, state, or local civilian agencies. In most circumstances, the DOD is one of many federal agencies reacting to a domestic emergency or crisis, playing a subordinate, supporting role to a lead, civilian agency.

### THE ROLE OF THE ARMY

Traditionally, nations have raised and maintained armies to provide for the national defense. Today, the United States calls upon its Army to perform various other functions as well, for example, controlling civil disturbances, assisting with disasters, and providing essential services.

- During the civil disturbances of the late 1960s and early 1970s, civilian authorities called upon the Army to help restore order.
- Soldiers provided assistance during times of natural disaster, such as the Hurricane Andrew cleanup in Florida in 1992. Civil authorities can call upon the Army to render assistance if a



major accident occurs at a nuclear power plant. The Army can also help prevent a major environmental disaster by assisting in the cleanup of petroleum or chemical spills.

- During the postal strike of 1970, the federal government called upon the Army to help operate post offices in several cities. Army air traffic controllers manned control towers during the 1981 air traffic controller walkout.

## THE LAW

Within the United States, civilian agencies, not the military, provide for the needs of citizens. Civilian, federal, state, and local government and law enforcement agencies execute US laws. Laws governing use of the military in domestic operations are complex, subtle, and ever-changing. For this reason, commanders should discuss plans, policies, programs, exercises, funding, and operations with their legal advisors. They should scrutinize each request for aid, whether it be for equipment or training, to ensure that it conforms with statutory requirements.

## SUPPORT TO CIVILIAN LAW

### ENFORCEMENT: *The Posse Comitatus Act*

Generally, federal military forces may not give law enforcement assistance to civil authorities without running afoul of *The Posse Comitatus Act*. However, Constitutional and statutory exceptions to this prohibition do exist. The recent emphasis on drug interdiction has led to an increase in those exceptions.

*The Judiciary Act of 1789* allowed United States marshals to call upon the military as a *posse comitatus*. This continued until after the Civil War, when the federal government used the Army to execute Reconstruction Era policies. The southern states regarded the use of the military for this purpose as abusive and repressive, and in 1878 President Rutherford B. Hayes signed the original bill ending the practice. The current wording contained in 18 USC 1385 is:

*Whoever, except in cases and under circumstances expressly authorized by the Constitution or act of Congress, willfully uses any part of the Army or the Air Force as a posse comitatus or otherwise to execute the laws shall be fined not more than \$10,000 or imprisoned not more than two years, or both.*

The *Posse Comitatus Act* prescribes criminal penalties for use of the US Army or Air Force to execute the laws of or to perform civilian law enforcement functions within the US. DOD policy extends this prohibition to the US Navy and Marine Corps. Prohibiting the military from executing the laws means that military personnel may not participate directly—

- In arrest, search and seizure, stop and frisk, or interdiction of vessels, aircraft, or vehicles.
- In surveillance or pursuit.
- As informants, undercover agents, or investigators in civilian legal cases or in any other civilian law enforcement activity.

The *Posse Comitatus Act* does not apply to—

- Members of the National Guard when not in federal service.
- Members of a reserve component when not on active duty or active duty for training.
- DOD civilians, unless under the direct command and control of an active duty officer.
- A soldier when off duty and acting only in a private capacity.
- Soldiers taking action for the primary purpose of furthering a military or foreign affairs function of the US, for example, enforcing military justice, maintaining law and order on military installations, protecting classified materials.

**There are specific actions in which military personnel may not participate.**

## Constitutional Exceptions

Under its inherent authority, the United States Government is responsible for preserving public order and carrying out governmental operations within its territorial limits, by force, if necessary. Under the Constitution, two exceptions allow the use of the military to execute or enforce the law: when necessary to protect civilian property and functions and when necessary to protect federal property and functions.

**When Necessary to Protect Civilian Property and Functions.** A sudden and unexpected civil disturbance, disaster, or calamity may seriously endanger life and property and disrupt normal governmental functions to such an extent that local authorities cannot control the situation. At such times, the federal government may use military force to prevent loss of life or wanton destruction of property and to restore government functions and public order. This exception has rarely been used.

**When Necessary to Protect Federal Property and Functions.** The federal government may use military force to protect federal property and federal government functions when local authorities cannot or decline to provide adequate protection.

The President may order the armed forces to aid state civil authorities who are suffering from an insurrection or civil disturbance—

- At the request of a state.
- To enforce federal authority.
- To protect federal property.
- To protect the Constitutional rights of citizens within any state.

The President must act personally by first issuing a proclamation calling upon insurgents to disperse and retire peaceably within a limited time (10 USC 331-333; 10 USC 3500; 10 USC 8500). Note: Not one of these authorities, in and of itself, provides sufficient legal basis to order the reserve components to active federal service.

### **Statutory Exceptions**

Other statutory exceptions (10 USC 371-380) allow military personnel to provide limited support to civilian law enforcement agencies (LEAs) indirectly. Under these laws, the military may share certain information and provide equipment, facilities, and other services to LEAs. The annual DOD Authorization Act also contains exceptions concerning military support to civilian authorities fighting illegal drugs. DOD policies for providing support to civilian LEAs, including personnel and equipment, are contained in DOD Directive 5525.5. AR 500-51 contains related US

Army policies. Examples of support that does not violate *The Posse Comitatus Act* follow:

- Loan of equipment and training to operate or repair the equipment. Certain customs and other laws—*The Controlled Substances Act*, *The Immigration and Nationality Act*—permit direct operation of this equipment.
- Civilian LEAs' use of installation research facilities.
- Transfer of information acquired during normal military operations.

### **DOMESTIC DISASTER RELIEF:**

#### ***The Robert T. Stafford Disaster Relief Act***

The Stafford Act, 42 USC 5121, et seq, as amended, is the statutory authority for federal domestic disaster assistance. It empowers the President to establish a program for disaster preparedness and response, which the President has delegated to FEMA. The Stafford Act provides procedures for declaring an emergency or major disaster, as well as the type and amount of federal assistance available. The Act authorizes the President to provide DOD assets for relief once he formally declares an emergency or a major disaster. He may also provide DOD assets for emergency work on a limited basis prior to the declaration. DOD policy for providing domestic disaster assistance is contained in DOD Directive 3025.1, Military Support to Civil Authorities. Army policy is found in AR 500-60, Disaster Relief.

### **Emergencies and Major Disasters**

The difference between an emergency and a major disaster is one of duration, severity, and the extent of assistance required. Examples are hurricanes, floods, tornadoes, storms, tidal waves, earthquakes, volcanic eruptions, landslides, droughts, explosions, or other natural or man-made catastrophes. Emergencies are less severe than major disasters, requiring a shorter time to recover and to provide adequate relief. Both may require federal assistance to augment state and local resources and relief agencies. From a DOD perspective, an emergency and a major disaster may require the same type of work, that is, removal of debris, preservation of health and safety, and restoration of essential services.

**The difference between an emergency and a major disaster is one of duration, degree of damage, and extent of assistance needed.**

**The Federal Response Plan**

Once a state requests aid, the President may declare an emergency or a major disaster, enabling the FEMA to act under the FRP. The FRP is a memorandum of understanding (MOU) between the FEMA and other federal agencies, including the DOD, to provide domestic disaster assistance. Under the FRP, a single federal agency is assigned primary responsibility for each of twelve ESFs. The FEMA orchestrates disaster relief through these ESFs. Each primary agency orchestrates the federal effort within its sphere of responsibility and may, if authorized by the FEMA, task other agencies for support.

The DOD has primary responsibility for ESF 3, Public Works, and ESF 9, Urban Search and Rescue, and is a supporting agency for the remaining ten. The FEMA reimburses the DOD for the incremental costs of providing the tasked assistance. Without specific FEMA tasking, DOD units lack authority to provide domestic disaster assistance and, if provided, risk not being reimbursed for its cost. If in doubt, commanders should seek clarification from the FEMA through the defense coordinating officer.

**Emergency Work**

To save lives or to preserve property, the President may commit DOD resources to perform emergency work on public or private lands prior to his official declaration of an emergency or major disaster. Emergency work is defined as clearance and removal of debris and wreckage and temporary restoration of essential public facilities and services. Such work may not last more than 10 days.

**CIRCUMSTANCES CONCERNING ELECTIONS**

US law (18 USC 592) prescribes criminal penalties for US troops being at or near polling places.

Commanders should determine if elections are scheduled during disaster assistance operations. For example, during JTF Andrew operations, the FEMA asked the DOD, at the request of Florida election officials, to erect 66 tents, with generators and light sets, to serve as temporary polling sites during a general election. They further tasked DOD to maintain the equipment. Several other polling sites were located near DOD personnel performing disaster relief duties. The Department of Justice opined that so long as DOD personnel did all they could to respect the integrity of the sites, they would not violate 18 USC 592. This was true as they provided tasked support and as they continued relief operations in their vicinity.

*Hurricane Iniki left the Hawaiian island of Kauai devastated; one result was inoperative county polling places. Soldiers from the Hawaii Army National Guard (serving on state active duty) helped a state primary election take place as scheduled by providing tents and transportation assets to Kauai County polling officials.*

**COMBATting TERRORISM,  
AIRCRAFT PIRACY,  
AND OTHER OPERATIONS**

**COMBATting TERRORISM**

Various DOD directives outline the policies for maintaining security and combatting terrorism. Because the DOD retains responsibility for protecting its resources, DOD domestic actions to combat terrorism do not always fall within the category of providing assistance to civilian authorities. OPLAN GARDEN PLOT contains DOD procedures for assisting the FBI in combatting terrorism on and off of US military installations.

**The FBI's Responsibility**

The FBI has overall jurisdiction at the scene of a terrorist incident wherever it occurs, including military

installations. The President has directed federal departments and agencies to cooperate to thwart terrorist incidents.

### The DOD's Responsibility

Commanders are responsible for the maintenance of law and order on their installations. They must take all actions to respond to and terminate any terrorist incident occurring on the installation and to protect the installation's personnel and equipment from attack. Installation commanders should coordinate protective measures with appropriate civilian LEAs.

**Commanders who perform disaster assistance missions not tasked by FEMA risk the Army's not being reimbursed for its cost.**

DOD components are authorized to respond to reasonable requests from the FBI for military resources for use in combatting acts of terrorism. Assistance may include material, facilities, and technical personnel in an advisory capacity. Without Presidential approval, military personnel may not be used in a law enforcement role outside of a military installation. With that approval, soldiers may perform missions designated by the FBI pursuant to its responsibilities during a terrorist incident. However, command and control of the soldiers always remain with their military chain of command.

DOD resources may be provided only upon request of the Director, FBI, or the senior FBI official at the scene of a terrorist incident. Commanders may accept the judgment of the requesting official if the official's determination is consistent with available facts. Commanders must forward requests for resources not based upon an actual or imminent terrorist incident—for example, requests for training or longterm equipment loans—to the DOD for processing in accordance with OPLAN GARDEN PLOT.

### AIRCRAFT PIRACY

The Federal Aviation Administration (FAA) has exclusive responsibility for directing law enforcement activity affecting the safety of persons on board in-flight aircraft involved in aircraft piracy. The DOD is required, upon request of the Administrator, FAA, to provide necessary assistance to carry out the air piracy laws. The DOT and the DOD have a memorandum of understanding concerning aircraft piracy that covers DOD aircraft, regardless of location, and any non-DOD aircraft on DOD installations.

### OTHER OPERATIONS

DOD support to civilian agencies for other emergencies, such as hazardous substance cleanup, radiological threats, emergency evacuation, and flood control, may be under specific authority, for example, The Flood Control Act. Such support may also be executed in conjunction with other laws, policies, procedures, or regulations. It is not possible to discuss all situations within the constraints of this publication. For example, Army Corps of Engineers civil engineering projects exceed the scope of this discussion. Applicable references are listed at the back of this manual.

#### 10 USC 672(b), The 15-Day Rule.

The secretary concerned may order reserve component units—and personnel not assigned to units—to active duty for a period not to exceed 15 days per year. Activating NG units and personnel requires the governor's consent. USAR units and ARNG units performing annual training outside the US and its territories, however, use such orders as authority for their annual training period. If a reserve component unit ordered to active duty under this authority uses it to perform annual training, the authority is no longer available for that unit until the next fiscal year.

#### 10 USC 672(d), Volunteers

The secretary concerned may order to active duty reserve component personnel who volunteer. The governor must consent to activating NG personnel. Normally, as a matter of policy, USAR personnel are ordered to active duty for a period of more than 30 days

Ordinarily, no USAR or NG personnel will be ordered to active duty as volunteers unless active duty and state ARNG personnel cannot perform the duty and the appropriate CINC validates the requirement.

## **USE OF PERSONNEL, MATERIEL, AND EQUIPMENT**

### **USE OF MILITARY INTELLIGENCE (MI) PERSONNEL**

Use of MI personnel during domestic support operations is restricted as a direct result of lessons learned from their improper use in the 1960s. Consequently, LEA requests for MI personnel or material for counterdrug support must be approved by the Secretary of the Army General Counsel and coordinated through the Department of the Army Office of the Deputy Chief of Staff for Intelligence.

During disaster assistance operations, MI personnel may be used for liaison as well as other MI support activities. However, a specific MI mission statement, coordinated through proper authorities, must authorize MI personnel to collect, analyze, and disseminate information. When so authorized, MI personnel may

- Acquire information that may threaten the physical security of DOD employees, installations, operations, or official visitors, or that may be needed to protect the safety of any person, that is, force protection.
- Analyze and disseminate information to disaster relief personnel and emergency operations centers (EOCs).
- Support EOC operations using intelligence preparation-of-the-battlefield (IPB) skills.

Information that MI personnel gather without using or retaining it is considered not to have been collected. Commanders and MI personnel will ensure that all such material is handed over to appropriate authorities before departing the disaster area.

When OPLAN GARDEN PLOT is executed in response to civil disturbance operations, MI activities

fall under the jurisdiction of law enforcement policies and regulations. Commanders must ensure that MI support missions, other than normal liaison with LEAs for force protection, have been coordinated with and approved by appropriate authorities.

### **USE OF RESERVE COMPONENT PERSONNEL**

Several statutes permit the President, the SECDEF, or the service secretaries to use portions of the reserve components. For domestic disaster assistance, generally only two apply: 10 USC 672(b) and 10 USC 672(d).

### **USE OF MATERIEL AND EQUIPMENT**

AR 700-131 provides HQDA guidance for the loan or lease of US Army materiel. The SA must approve the loan of arms, ammunition, combat vehicles, vessels, and aircraft. Ordinarily, when the DOD loans equipment, the borrowing agency must reimburse them for all DOD costs incident to its delivery, return, and repair. In addition, the borrower must reimburse the full purchase price for consumable or nondurable items, such as batteries, and for depreciation if it is significant.

DOD directives tightly regulate use of reserve component equipment. The MACOM commander approves temporary loans for 90 days or less. The Secretary or Deputy Secretary of Defense approves withdrawals of equipment for more than 90 days. Replacement plans must accompany requests for withdrawals.

## **REIMBURSEMENT**

In addition to the authorities mentioned above, The Economy Act (31 USC 1535) permits federal agencies to provide goods and services to other federal agencies on a reimbursable basis. The Stafford Disaster Relief Act requires reimbursement to the DOD for the incremental costs of providing support. Approval authority and reporting requirements vary depending upon the duration and type of support requested. OPLAN GARDEN PLOT contains procedures for reimbursing DOD for assistance during civil disturbances. Reimbursement for use of NG personnel and assets to assist state counterdrug operations and programs is authorized by 32 USC 112.

Other statutes permit federal agencies to seek waiver of reimbursement. For example, federal law enforcement agencies are not required to reimburse DOD if support—

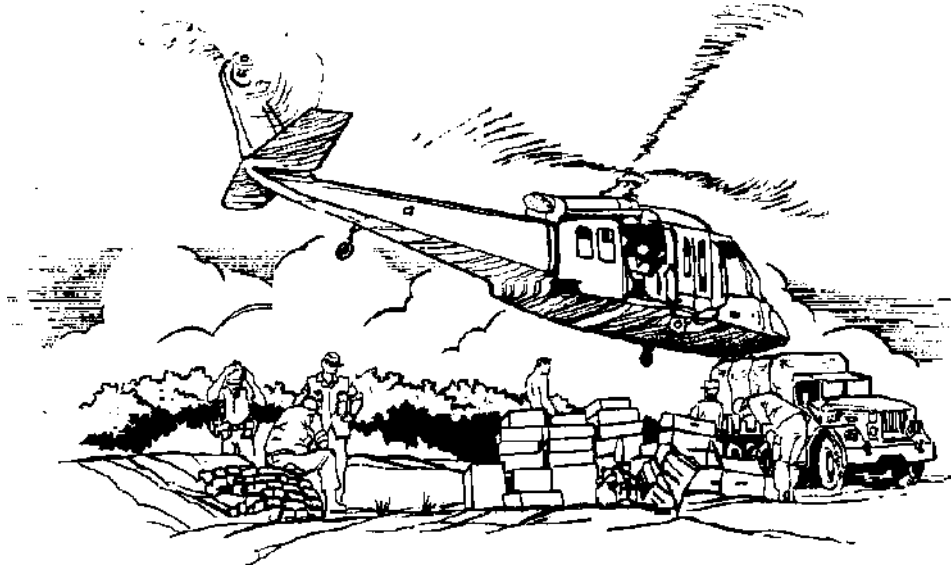
- Is provided in the normal course of military training or operations.

- Results in a benefit to DOD that is substantially equivalent to that which would otherwise result from military training (10 USC 377). Ordinarily, the DOD makes this determination.

### SUMMARY

Domestic support operations raise many legal issues. The Constitution, statutes, and regulations strictly govern the relationship of the military to civilian authorities. The basic rule is that the military plays a subordinate and supporting role to civilian authority, which is different from the wartime role they would have in a foreign theater of operations. Questions of posse comitatus, use of force, disaster assistance, and federalization of troops raise issues that require timely legal advice. Commanders must be aware of the legal implications of domestic support operations, ensure that they are appropriately advised by competent legal counsel, and act accordingly.

---



## CHAPTER 4

# LOGISTICS AND SUPPORT OPERATIONS

---

*Most domestic support operations are logistical in nature. Support is based on actual requests or requirements, rather than on standard support packages. In planning for support of national objectives amid growing complexities, military planners face ambiguities about how to prepare for and predict types of contingencies our forces will confront. However, certain support functions always apply, whether for combat forces or civil authorities. To avoid duplication, support planners must consider military and civil requirements and capabilities concurrently. This chapter addresses support common to all domestic operations, as well as specifics for tailoring a support force for particular purposes.*

### PLANNING

**Most domestic support operations are logistical in nature.**

In most crises, ARNG units under the control of the respective state governments will be the first military units to provide support. Although the military commander retains command and control of Army forces, a federal, state, or local official may control the overall operation. Detailed planning and familiarization

with the various levels of federal, state, and local government will help synchronize assistance efforts. Coordination and synchronization will avoid confusion and duplication of effort. A knowledge of other agencies' capabilities will help to avert adversarial situations.

Logistics assessment personnel should carefully identify requirements before US Army support assets are deployed. Before deployment, logistics commanders can form emergency response teams to react immediately to emergency situations. These teams would arrive on the scene early to assess the impact and severity of a crisis before commitment of operational forces.

Commanders must ensure that support to troops and to civil authorities is planned for and executed simultaneously. They must also ensure that—

- Logistics command and control cells arrive early.
- Deploying units have access to assured communications and to all Standard Automated Management Information Systems (STAMISs) directly at the support base (local installation).
- Support and supplies flow smoothly and continuously.
- Termination standards (end states) for all types of support are established early in the operation.
- Resource management is fully integrated into all phases of the operation.

### SOURCES OF SUPPORT

The four primary sources of logistical support are contracting, negotiated support, military support, and support from other federal agencies. See Figure 4-1.

#### CONTRACTING

Contracting—purchasing, renting, or leasing supplies or services from nonfederal sources—is a highly effective and efficient way to provide rapid support in a crisis. Included are all classes of supply, labor, mortuary affairs, laundry, showers, food service, sanitation, billeting, transportation, maintenance and repair, access to communications networks, temporary real property leasing, and limited minor construction.

Contracting can augment organic military unit support capabilities and provide new sources of critically required supplies, services, and real estate. It can also bridge gaps that may occur before the deployment of sufficient Army support. Contracting should always be the preferred method of support, beginning as soon as requirements are known.

Decentralized contracting provides a means to respond rapidly to immediate demands. As operations stabilize, centralized contracting becomes more important, allowing Army units to gradually diminish support, to transfer functions to civil agencies, and to disengage and redeploy.

**Warranted contracting officers will be needed early in domestic support operations.**

During the initial stages of a crisis operation, warranted contracting officers will be needed immediately to procure validated emergency supplies and services. Contracting officers may be brought in with federal forces or they may be provided by the ARNG from its property and fiscal offices, by the designated support installation, the USACE, or by a civil agency.

#### NEGOTIATED SUPPORT

In some cases, civil authorities may have enough logistical resources to support not only themselves but also the Army personnel providing assistance. For example, civil authorities may provide housing, food, and fuel to troops assisting in a counterdrug or firefighting operation. Such support is negotiated on a case-by-case basis with the appropriate civil authorities.

#### MILITARY SUPPORT

Whenever possible, installations will continue habitual support to units tasked to conduct domestic support operations. Installations may also have to support personnel with whom they have no established support relationship. These personnel may include civil authorities, elements from other services, and Army elements from other stations.

If an installation or one of the other sources discussed below cannot provide required support directly, planners will tailor a support force for that purpose. Most considerations for tailoring a support force are the same as they are for any operation: requirements, available resources, estimated length of the operation, and so on.

#### SUPPORT FROM OTHER FEDERAL AGENCIES

The GSA also provides support to civil authorities. GSA provides general supplies and services that are



common to more than one department of the federal government. GSA can provide an extensive amount of support to DOD for such commonly used items as office furniture and supplies, machine and hand tools, photo supplies and other items. Other federal agencies and organizations may be able to provide assistance depending on the nature, scope, and duration of the operation.

### LOGISTICS COMMAND AND CONTROL CELLS

Logistics command and control cells are critical to successful support operations. A materiel management center (MMC) can operate in a split-based mode. This concept provides for part of the MMC to remain in a secure location (out of harm's way), while a force projection MMC element deploys with the force it is supporting. The forward deployed MMC element would

provide a conduit for the electronic transmission of logistics data, messages, and voice communications traffic, resulting in inventory asset visibility. Such visibility is vital to logistics support operations.

**Logistics command and control cells must arrive early in domestic disaster operations.**

Combat service support units must continue to support units awaiting redeployment. Resource accountability remains critical during this phase to prevent waste, fraud, and abuse. At or near the

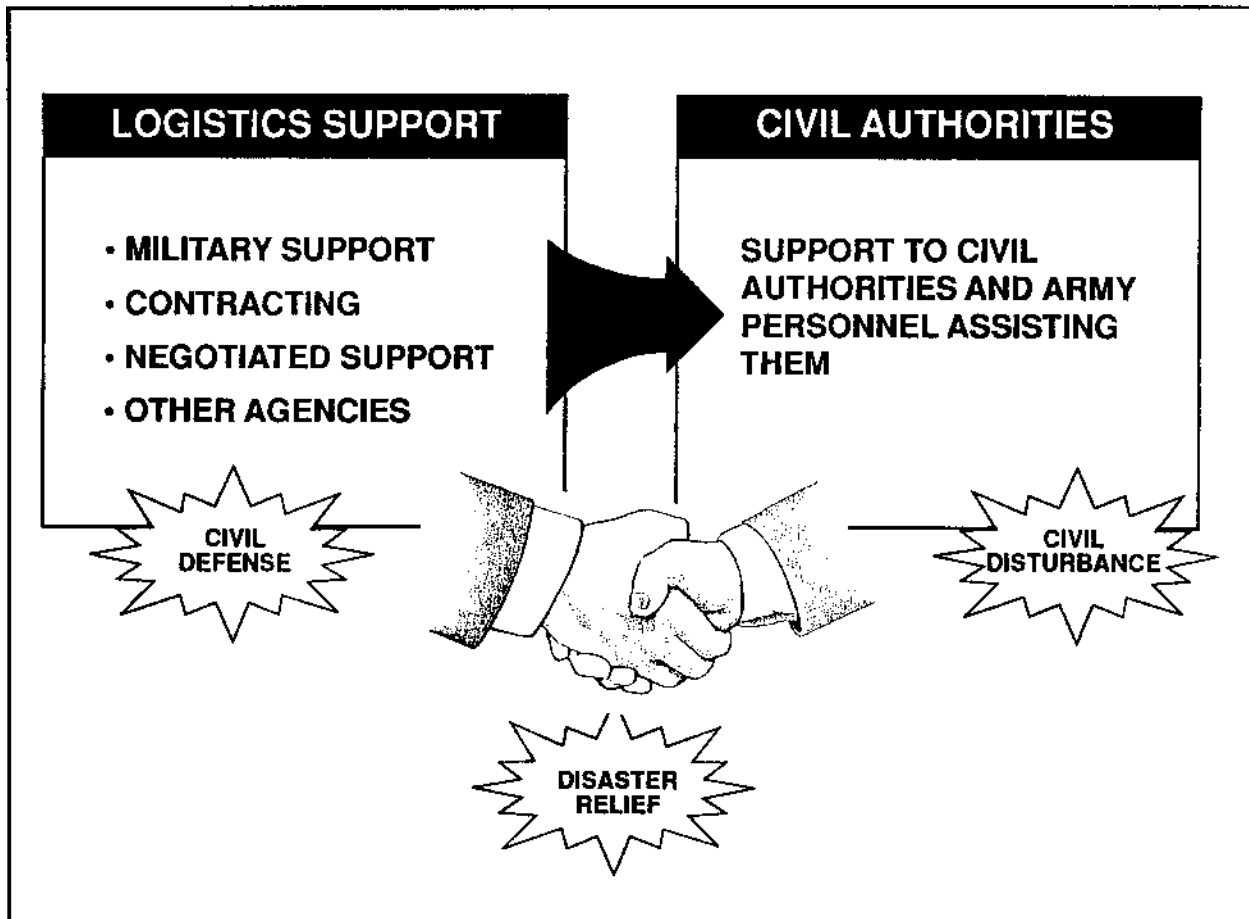


Figure 4-1. Source of Support

completion of domestic operations, redeployment will be phased to allow for continued and uninterrupted support to civil authorities. Military support should not be curtailed before civil authorities assume the function. When state-activated ARNG units remain on site, special efforts should be undertaken to assist them. Transportation must be arranged through the appropriate movement control organization in accordance with established priorities.

*In the past three years (1989-92), US military forces have responded to three hurricanes and two typhoons that struck densely populated areas. After the most recent storms, Hurricane Andrew in Florida and Louisiana and Hurricane Iniki in Hawaii, Army soldiers provided relief services, prepared meals, cleared and hauled debris, produced and distributed water, restored power, and constructed life support centers. These missions provided important lessons in preparedness, leadership, organization, equipment, and safety.*

### RESOURCE MANAGEMENT

The commander is responsible for maintaining the readiness of the command to execute missions and operations. Any unprogrammed requirement may result in spending resources intended for other use. To request reimbursement for lost resources, the commander must be able to account for them. Equipment and supplies misused, improperly maintained, damaged, lost, or issued to others will adversely affect future readiness and timely deployment.

Judicious management and accountability should be an early and constant focus. When possible, resource management analysis should precede key operational and logistics decisions and actions. Army resource managers should seek early guidance as to reimbursement. For example, will the operation be reimbursable from civilian

sources, should specific Army accounting codes be used for the operation, and so forth. Project codes for use in accumulating costs should be requested at the onset of a disaster relief effort. Designating logistics organizations, for example, US Army Materiel Command corps support command (COSCOM), divisional support command (DISCOM), to receive, store, issue, and account for DOD material must also be considered.

**Judicious management and accountability should be an early and constant focus.**

State, local, or federal agencies; DOD; or other military services will normally reimburse the Army for assistance. The reimbursement process requires accurate billing for legitimate costs. Discrepancies must be resolved with the supported and/or reimbursing agency. Supported agencies should keep records of services and support received from the Army. To distinguish costs from those related to training or normal operating expenses, Army resource managers must maintain accountability throughout an operation for costs of equipment and supplies dedicated to operational support.

Commanders and managers should fully integrate resource management into all phases of the operation. Establishment of a resource management element to review procedures and advise the commander is also required. Positive resource management calls for planning to account for the expenditure of all resources supporting an operation with the expectation of being audited. By requesting early on-site involvement and advice from external functional experts, for example, Army Audit Agency (AAA) and General Accounting Office (GAO), resource managers can head off major accounting problems that could occur later in the support operations.

### SUPPLIES AND FIELD SERVICES

Supplies and services are critical to the life-threatening needs of some types of civil emergencies and to the sustainment of operations in others. Basic guidelines for support are to tailor the package for the

mission, to contract for services early on, and to utilize local resources when possible.

**DEFENSE LOGISTICS AGENCY**

The DLA may provide common supplies and services used by the military services when supporting domestic operations. The agency’s mission is to provide effective logistics support to the operating forces of all military services and to federal civil agencies as assigned. DLA provides support at the lowest feasible cost to the taxpayer. It provides contract administration services in support of the military departments, other DOD components, and other government agencies upon request. The DLA

organization is shown in Figure 4-2. Its defense distribution depots are shown in Figure 4-3.

**QUARTERMASTER (QM) UNITS**

QM supply and field service units, which should be among the first logistics elements deployed, will satisfy immediate needs and establish receipt, storage, and distribution of incoming supplies. QM units can make food, water, clothing, and shelter available and coordinate required contractual services. The Army’s field service companies provide personal hygiene services such as showers, laundry, and, if required, delousing.

The Army has various options for feeding people, even though no unit is specifically designed for mass

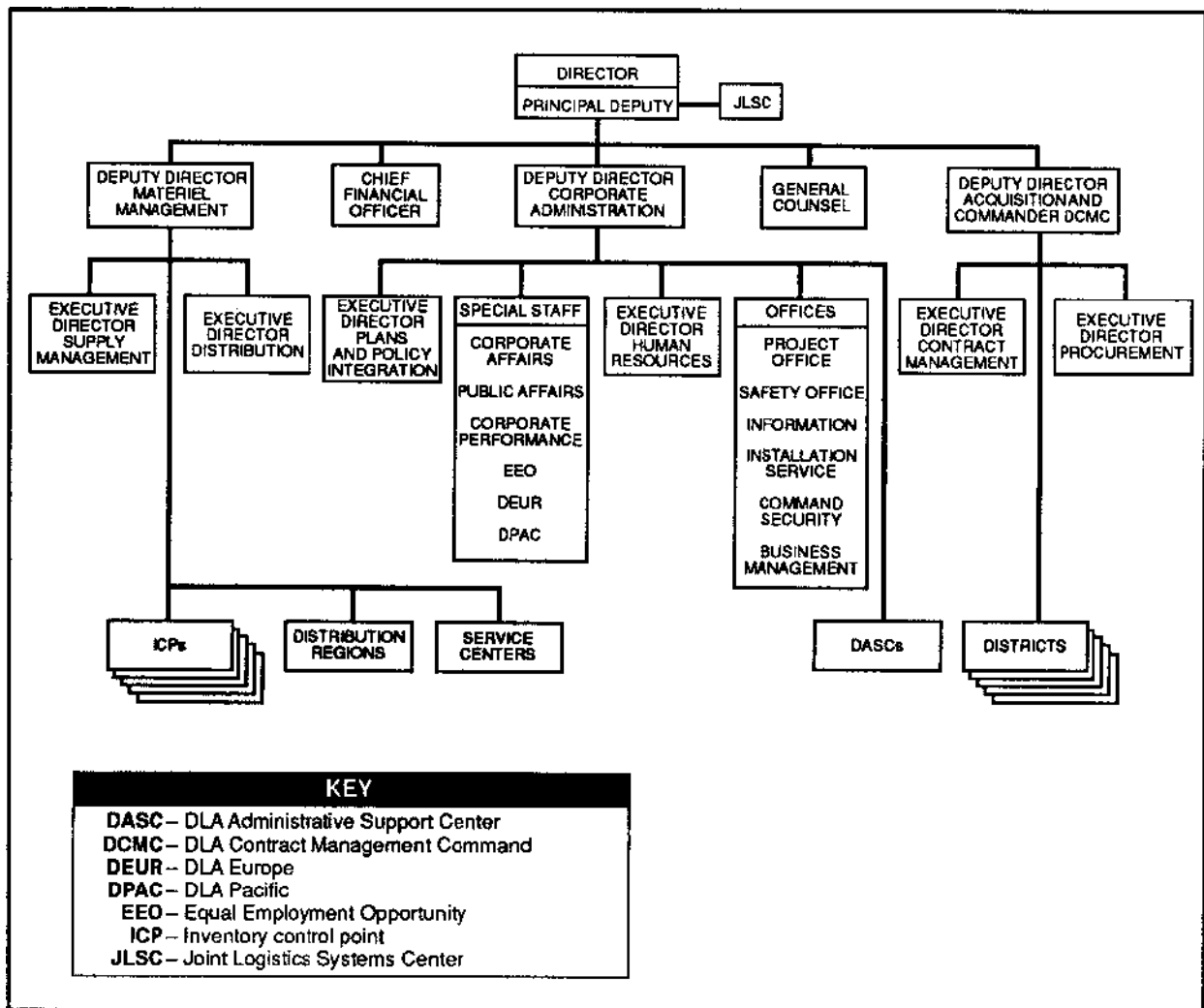


Figure 4-2. Defense Logistics Agency

feeding. Options range from distributing meals, ready-to-eat (MRE) to preparing and providing hot meals in a climate-controlled dining facility. Under certain conditions, contract feeding may be a viable means of support. However, local circumstances will dictate the method chosen to feed both supporting military personnel and the supported civilian population. To the extent available, QM units should use established structures suitable for feeding.

**MORTUARY AFFAIRS UNITS**

Because disasters usually occur without warning, they create considerable confusion, as well as a shortage of personnel to handle the sensitive, unpleasant task of caring for the dead—a job that must be done quickly and efficiently. At such times, Army mortuary affairs forces can provide valuable assistance. When the requirement for such services exceeds

a community’s capabilities, Army mortuary affairs units can provide search, recovery, evacuation, and identification services.

**FORCE PROVIDER UNIT**

The Army’s Force Provider Unit is specifically designed to provide logistical support in a consolidated location. It is also ideally suited for supporting disaster and humanitarian aid operations. This system, which can provide support for 3300 people, is designed in modules. Each module is capable of independent operations. The unit includes billeting facilities with heating/cooling, kitchens, latrines, showers, laundries, power generation, and water purification. It also includes facilities and equipment and material for religious support as well as morale, welfare, and recreation (MWR). Figure 4-4 shows a 550-person Force Provider module.

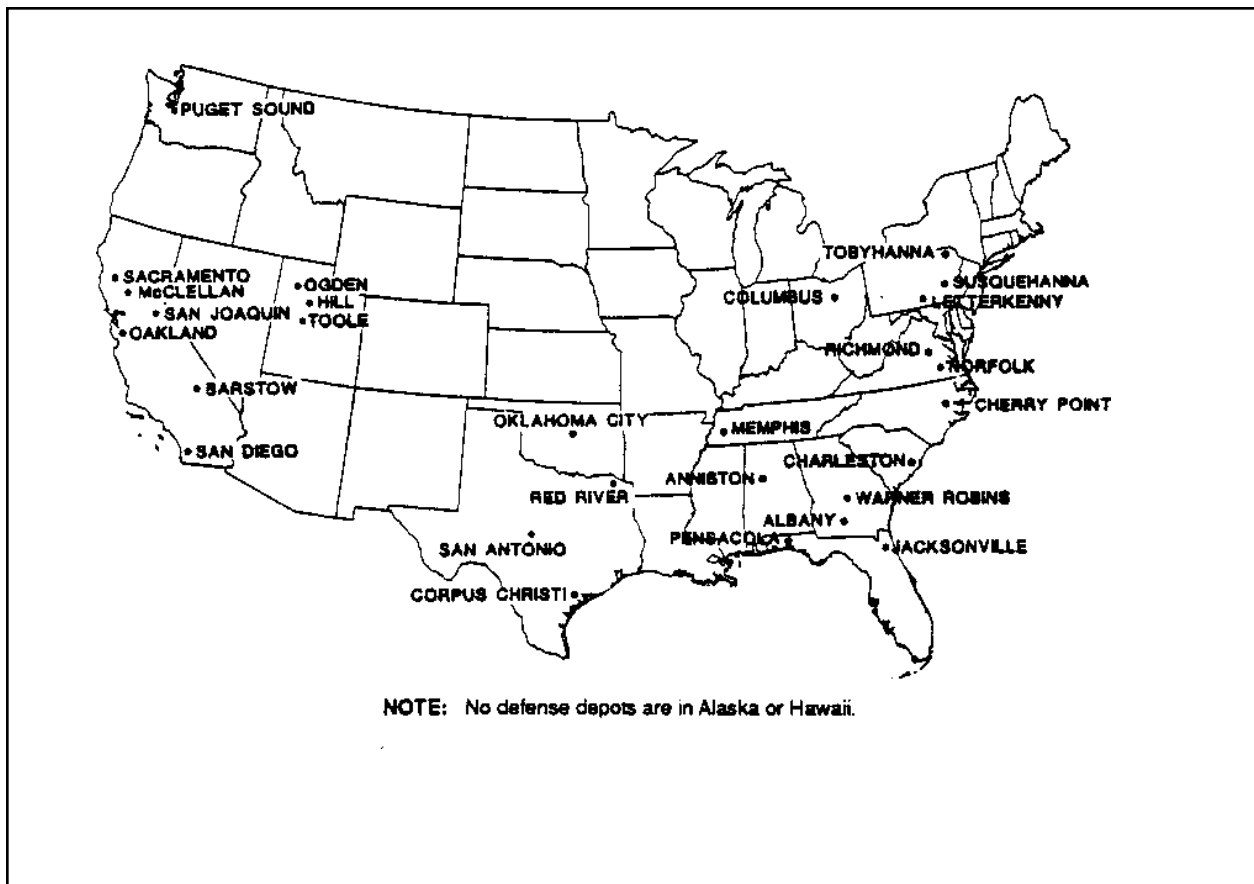


Figure 4-3. Defense Distribution Depots

**OTHER SUPPORT**

Depending on the magnitude of need and the flow of supplies, Army units may require an extensive storage complex.

In emergencies, large quantities of goods are routinely contributed to the affected populace. Normally, civil agencies handle these donated goods; however, they may request that Army forces do the job. Commanders must recognize the requirement for supply accountability and reimbursement for goods and services in accordance with applicable Army regulations. Likewise, they must honor their responsibility to provide designated common supplies to other services in accordance with regulatory guidance. Such efforts apply equally to US civil authorities and traditional military operations.

**Real Property**

Civil emergency service organizations and the NG should jointly coordinate the use of real property. Facilities should be selected based on their potential for support and the anticipated scale of assistance operations. Vacant warehouses, parking lots, potential staging areas, and other facilities that could be used for

supply activities should be acquired to enable receipt, storage, and distribution operations.

**Facilities must be identified to accommodate the receipt, storage, and transshipment of supplies to an impacted area.**

**Equipment**

The nature of the emergency and prevailing conditions will determine the proper mix of equipment needed. In many cases, military equipment is well-suited for domestic support operations. However, additional equipment may be required, either temporary loans from other units or civilian equipment. When civilian equipment is needed, the commander must convey the requirement to higher headquarters. The supporting contracting element (SCE) determines

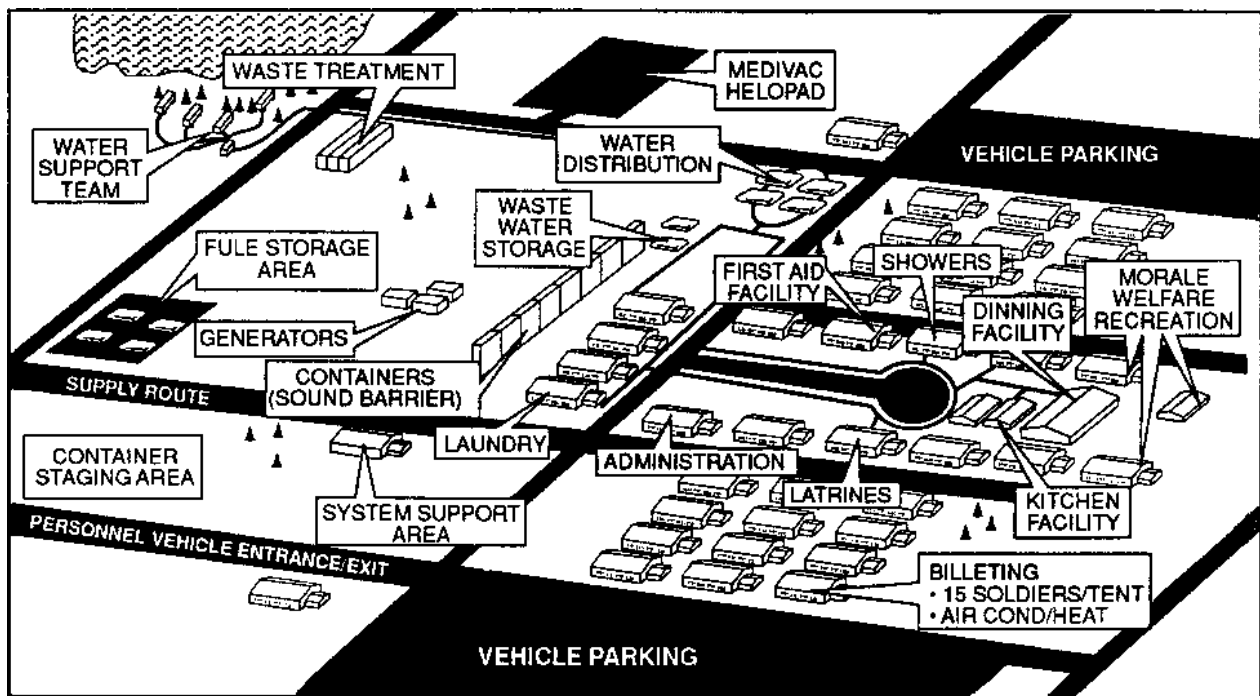


Figure 4-4. 550-Soldier Force Provider Module

market availability and processes local purchases or hires. In some cases, unit commanders will have the authority to commit funds.

Army equipment may be loaned between active and reserve units, to other services, or to federal government and law enforcement agencies to supplement their capabilities. With proper authorization, loans may be made to nonfederal agencies; state, county, local civil authorities; or private agencies. Normally, consumable supplies and repair parts are not loaned.

*As a result of Hurricane Andrew, the 16th Field Supply Co (FSC), 240th QM battalion, was deployed to provide support. The 16th FSC mission provided laundry, bath, and light textile renovation support to disaster victims and deployed forces. Overall, the 16th FSC processed 5000 bundles of laundry and provided showers for more than 22,000 soldiers and civilians.*

The borrower must sign a statement assuming liability for equipment during the period of the loan, to include care, custody, security and safeguarding, proper use and maintenance, and responsibility for all incremental costs accrued to the Army. Prior to issue, the Army should clearly define condition standards for return.

Requests from nonfederal agencies must state that a commercial source for an item is not reasonably available. Loan of firearms, weapons, combat or tactical vehicles, water vessels, and aircraft must be approved by the Assistant Secretary of the Army.

### MAINTENANCE

The number and type of maintenance units deployed will depend on the operational requirements of the crisis. Military maintenance personnel will remain under military command and control throughout the assistance operation. Whenever possible, the normal planning and execution chain of command should remain in place.

Maintenance commanders should identify supporting vendors; organize maintenance elements; and organize assets from other agencies, contractors, and local maintenance resources. Commanders must consider not only support of their own equipment but support of diverse civilian equipment such as buses, trucks, ambulances, power generation equipment, and so forth.

Commanders must plan on maintenance being performed under field conditions. Disaster relief vehicles such as ambulances, firefighting equipment, buses, power generation and construction equipment will receive priority. As facilities are reactivated following a disaster, maintenance of local infrastructure equipment might be conducted in fixed facilities on an ever-increasing scale.

The types and quantities of Class III and Class IX supplies to be carried or constructed for support of local infrastructure equipment will depend largely on the type of disaster and the equipment being supported. Standard prescribed load lists (PLLs) and authorized stockage lists (ASLs) should be adequate for unit military type equipment committed to domestic support operations. However, this may need to be tailored to support equipment for units in attached or under operational control (OPCON) status.

A priority consideration is the early reestablishment of the local government's infrastructure. Maintenance units are particularly adept at providing this support, whether repairing the local television and radio stations or emergency vehicles. Emergency or quick-fix type repairs similar to the Army's Battle Damage Assessment and Repair (BDAR) System may be required in the early stages of disaster relief, allowing time for repair parts procurement and establishment of a maintenance program.

### TRANSPORTATION

Early assessment of transportation requirements is essential. Transportation support will be tailored to both the deployed military force and civil authorities under centralized control. The Army can provide numerous capabilities depending upon the mission. Transportation planners should be deployed early as part of the logistical assessment element.

Movement control units plan, schedule, and control Army movements into, within, and out of an area of

operations. They also support joint force movement control requirements and coordinate support with civil authorities. In this capacity, an Army movement control unit can provide the nucleus of a joint movement center (JMC) and effectively meet all requirements. The JMC is a proven concept and can be tailored to meet the operational transportation requirements. A notional JMC is depicted in Figure 4-5.

**The JMC is a proven concept and can be tailored to meet operational requirements.**

Transportation units may be organized under a multifunctional or pure transportation headquarters depending upon the tailored support package. Truck companies can distribute large quantities of essential cargoes over terrain normally impassable to most civilian trucking. Cargo transfer companies prepare cargo for transshipment at distribution centers. Terminal service companies operate water ports, load and offload ships, or assist civilian port operators. Watercraft companies move units, supplies, and equipment along intracoastal or inland waterways.

*Asked to provide a JMC during Hurricane Andrew, the US Army Transportation Center deployed a JMC nucleus to the JTF headquarters. With augmentation, the JMC succeeded in providing a combination of air, land, and sea transportation to DOD forces, disaster victims, and relief workers.*

## DEPLOYMENT

Deployment to the area of operations will normally be under the centralized control of the US Transportation Command (USTRANSCOM) and will often be conducted under crisis action procedures. Units will deploy according to port-call instructions using

military and commercial transportation. Deploying units or teams follow existing policies, procedures, and regulations. When deployment control is not centralized under USTRANSCOM, the servicing installation arranges transportation to final destination.

## CONVOYS

Military convoys are coordinated between the deploying unit's installation and the defense movement coordinators (DMCs) in states where the convoys originate. The DMC coordinates military movements with his state transportation, civil defense, and law enforcement officials. During domestic support operations, the DMC should provide liaison to the senior movement control organization in the joint force.

## REDEPLOYMENT

Redeployment will be centrally controlled to provide for orderly movement out of the area in compliance with approved termination standards. The deployed force must be prepared to redeploy on commercial transportation since redeployment normally carries a lower priority for military lift than does deployment. The servicing installation transportation office (ITO) in the area of operations will procure the commercial transportation, prepare and issue shipping documentation, and monitor carrier performance. If an ITO is unavailable to service the area, a joint transportation office (JTO) must be organized to provide this support.

## AVIATION

Army aviation support to domestic operations includes air movement support of logistics and transportation operations; command and control support to federal, state, and local authorities; and reconnaissance and surveillance support of law enforcement operations. Active duty and National Guard aviation units provide support to civil authorities for counterdrug programs, civil disturbances, and border surveillance operations.

Unmanned aerial vehicles (UAVs) have tremendous potential in surveillance and reconnaissance operations of US border areas. Army aviation's inherent flexibility and responsiveness are ideally suited to support military and civil authorities.

Aviation support during disaster assistance operations will concentrate on air movement,

aeromedical evacuation, and command and control. Disasters may temporarily close ground lines of communication due to debris or higher priority traffic. Large metropolitan areas will experience traffic gridlock. Aviation units should include medium lift assets in the initial response to enhance distribution of critical personnel, supplies, and equipment over these obstacles. Early aerial reconnaissance of the disaster area by federal, state, and local authorities will help to assess relief priorities.

Aviation operations in a particular area will include various DOD aviation assets and many civilian and public aircraft. Coordination with the FAA and DOD representatives is imperative to delineate disaster area airspace procedures, management, and safety. Recent aviation operations in support of civil authorities point out the critical need to form airspace management cells and an aviation liaison cell within the first 24 hours.

Relationships among military services and the FAA air traffic services (ATS) must be succinctly addressed. The development of an aviation procedure guide (APG) will assist airspace management. These guidelines must extend to all prospective airspace users. Planners should provide guidance on flying civilians (law enforcement and government officials, Red Cross, news media, and non-DOD relief workers) and allocating critical aviation assets at the very beginning of the operation.

## ENGINEER

Engineer assistance to civil authorities will vary with each type of operation. Engineers may become involved in these operations as individuals, teams, or complete units. Individuals may technically assist in assessing damage or estimating engineer work. They

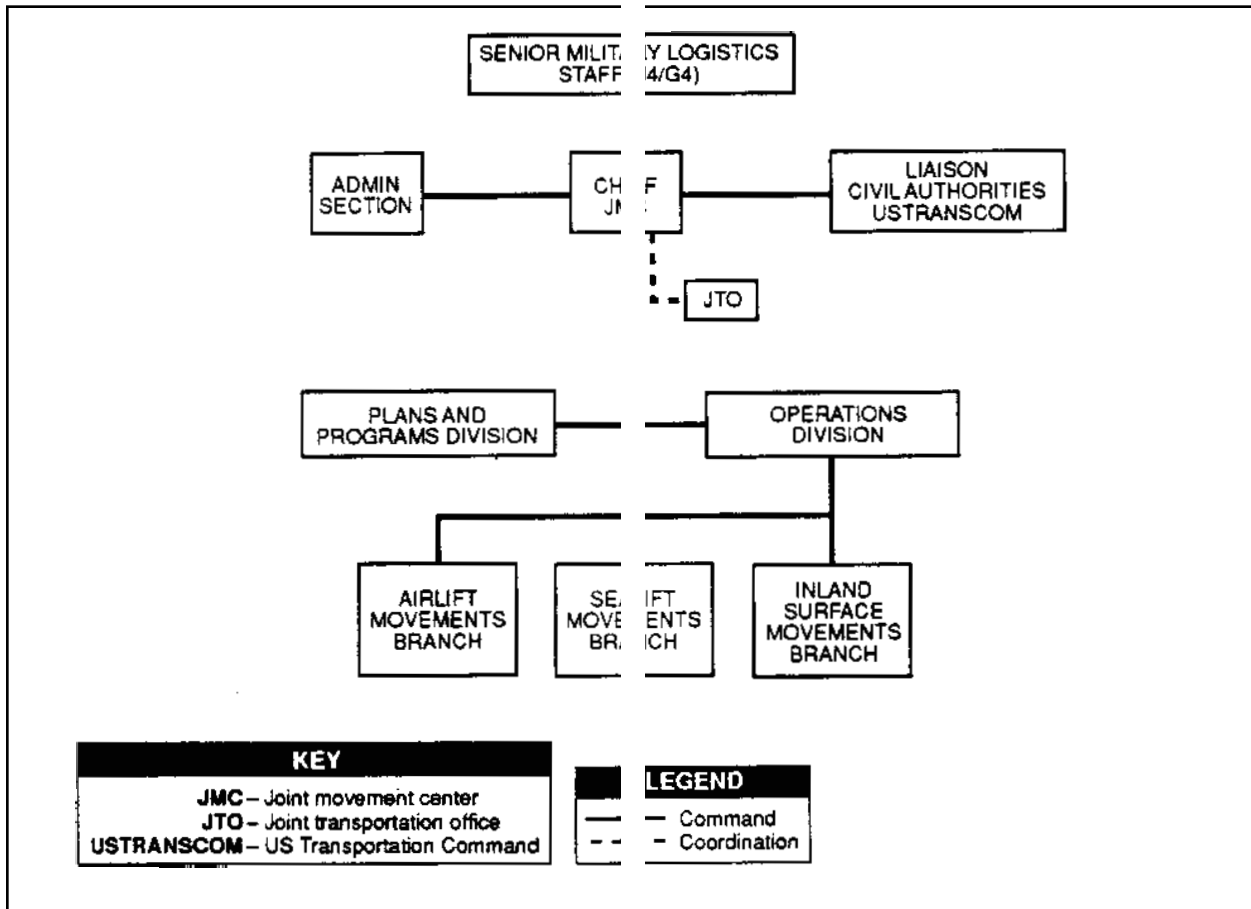


Figure 4-5. Typical Joint Movement Center Organization



may provide specialized support such as power supply and distribution or utilities repair and reconstruction.

The USACE provides expertise through its engineer districts and divisions. Support can include damage survey and assessment teams, contracting support, and technical advice. The US Army Engineering and Housing Support Center (USAEHSC), a field operating agency of USACE, provides prime power teams and equipment. These power teams restore temporary electrical power to key locations. Planners must resolve funding issues with USACE early in the assistance process.

Army engineer units provide a wide variety of skills and capabilities, including limited construction, structure repair, clearing and hauling debris, limited temporary electrical and plumbing facilities, and construction of life support centers. Engineer units possess heavy construction equipment, exterior lighting capability, and generators for temporary electrical power. Soldiers in engineer units are skilled in a variety of tasks useful during the response to and the recovery from natural disasters.

## **MAPS AND CHARTS**

In domestic support operations, map coverage is critical to provide a common frame of reference for all military and civil agencies. Paper maps, image-based substitute products, Geographic Information System (GIS) data bases, or a combination that provides total coverage is acceptable. Common maps and GIS data bases should be provided to all agencies and headquarters that are operationally involved. All controlling headquarters should operate from the same geographic frame of reference to coordinate support.

When locally produced products are available on a larger scale, they should be used. Maps or charts at a scale of 1:10,000 or 1:5,000 are extremely useful in assisting civil authorities. Products at these scales are better able to portray street names, local landmarks, and other commonly used reference points that are not usually portrayed on Defense Mapping Agency (DMA) or US Geological Survey (USGS) maps at smaller scales. Local planning agencies, realtor associations, travel agencies, or utility company records may be able

to provide such detailed map coverage. US Army topographic engineer units, federal mapping agencies, or local activities may be able to reproduce these products as required.

If map coverage does not exist over the area of operations, agencies can request image-based products, which can be produced in a relatively short time using unique imagery capabilities. US Army Engineer channels handle requests for such products.

## **INTELLIGENCE**

The importance of timely, focused information cannot be overstated. Military intelligence offers a disciplined and trained cadre of specialists who can quickly collect, integrate, analyze, and disseminate information that decision makers need to respond immediately to a situation. The first step is to sensitize military planners and operators to crucial needs of civilian authorities. Concurrently, they must keep in mind the distinction between the employment of military intelligence assets outside the US and the application of legal guidelines within the US. The best use of intelligence capabilities is through the skills and techniques employed in the IPB and liaison with law enforcement agencies.

## **MILITARY POLICE**

Military police have special expertise in counterdrug, terrorism, and civil disturbance operations. They are highly mobile and capable of providing search, rescue, and evacuation support; physical and area security; and traffic circulation control. Due to their decentralized operations and density of communications equipment, they are also valuable for notification and area damage control.

## **MILITARY HEALTH SERVICE SUPPORT**

Commanders may use medical forces and resources in domestic support operations when directed by the NCA. They may provide medical personnel and resources to support interregional military medical plan (IRMMP) missions before any NCA allocation

decisions. Commanders may withdraw this support, which is temporary, to meet higher priority military missions if they occur. The health services' goal in disaster operations is to assist the local and state health services organization return to normal. Figure 4-6 depicts levels of effort.

Medical support can range from local domestic support to a full-scale regional disaster. Guidance for DOD medical support for domestic operations will normally be based on priorities established by the DHHS at both regional and national levels.

### **TASK-ORGANIZED MEDICAL TEAMS**

When civilian authorities are unable to provide or are required to request medical support, the NCA can direct the deployment of medical teams. These task-organized teams will enter the affected area to assess the medical situation, determine treatment and evacuation requirements, establish treatment elements, and facilitate evacuation.

In situations where civil medical services are not available, for example in isolated areas, assistance includes, but is not limited to, personal hygiene, immunizations, chemical prophylaxis, pest management, nutritional programs, and epidemiological surveys. HSS encompasses several functional areas that call for immediate and sustained assessment of the public health status and local medical infrastructure.

### **KEY PLANNING GUIDANCE**

After the initial response, a mission analysis is conducted so that the HSS response can be tailored to meet the needs of the community in both the short and long term. Domestic emergency experience has shown that the senior US Army medical commander must locate his headquarters near the FCO's offices. Coordination between these two organizations is essential to unity of effort. Both should also centralize the location of HSS specific supply items from multiple sources (private and government). A medical logistics unit can provide assistance to non-DOD federal and civilian agencies in dispensing materiel.

### **NATIONAL DISASTER MEDICAL SYSTEM**

The NDMS was jointly developed by the DOD, the FEMA, the DHHS, and the VA to serve as a backup for the VA/DOD Contingency Hospital System for military casualties. NDMS is also the primary recipient of

casualties in the event of a catastrophic national disaster.

Depending upon the magnitude of the disaster, the local civilian hospitalization system and resources may become saturated, and NDMS may be activated. DHHS is responsible for ensuring sufficient available hospitalization capability. It considers a number of options to meet this requirement. First, the Army could deploy hospital resources such as a combat support hospital (CSH) or a mobile army surgical hospital (MASH) to the immediate disaster area. Second, the Army could coordinate the evacuation of patients to Army Medical Department Activities (MEDDACs) community hospitals or medical centers throughout the US. Third, Army medical units can use hospitalization resources from the other services.

During domestic national emergencies, the NDMS also depends on existing resources that will remain under the control of parent agencies. One of these is a nationwide network of more than 100,000 standby nonfederal acute care hospital beds. The NDMS depends on other in-place resources, including communication networks, transportation, and medical regulation systems to evacuate casualties to receiving hospitals. The national medical mutual aid response network provides patient clearing and staging services. It uses disaster medical assistance teams (DMATs), available military medical units, and supplementary medical supplies and equipment to carry out its functional support.

### **SYSTEM ACTIVATION**

The system may be activated in two ways. In the event of a domestic disaster, the governor of the affected state may request federal assistance under the authority of The Disaster Relief Act of 1974. This may result in the activation of NDMS. A state health officer may request that the Secretary of Health and Human Services (HHS) activate the NDMS in situations where the President has not declared a disaster.

In a civil emergency, the principal interface will be through FEMA and HHS regional coordinators to the state disaster medical and health coordinator. If the system is activated, the lead agency will be the DHHS; in a national security emergency, the lead agency will be the DOD. Each agency will be responsible for managing its own resources in accordance with general policy.

## PERSONNEL SERVICES

Personnel units and soldiers will primarily be used to support soldiers conducting the domestic support operation. While this personnel support is provided during any operation, a domestic support operation may require additional planning and preparation. For example, maintaining accurate strength accountability may be more demanding due to unusual tailoring of units to fit the particular mission. In addition, personnel soldiers may support military and family members who are victims or are otherwise affected by the operation.

Personnel units and soldiers may be brought into an operation to assist civil authorities in accomplishing their

mission using civilian agency systems. Assistance in personnel identification, classification, and accounting may be needed. Personnel soldiers may also assist in receiving and interviewing civilians to collect information and identify unique skills. They may account for casualties. Military personnel services units also assist civil personnel in recognizing outstanding contributions from members of the supported population. Assistance is provided to the US Postal Service if it is not able to conduct essential mail operations. Morale, welfare, and recreation services are provided in limited scope or as part of a force provider package.

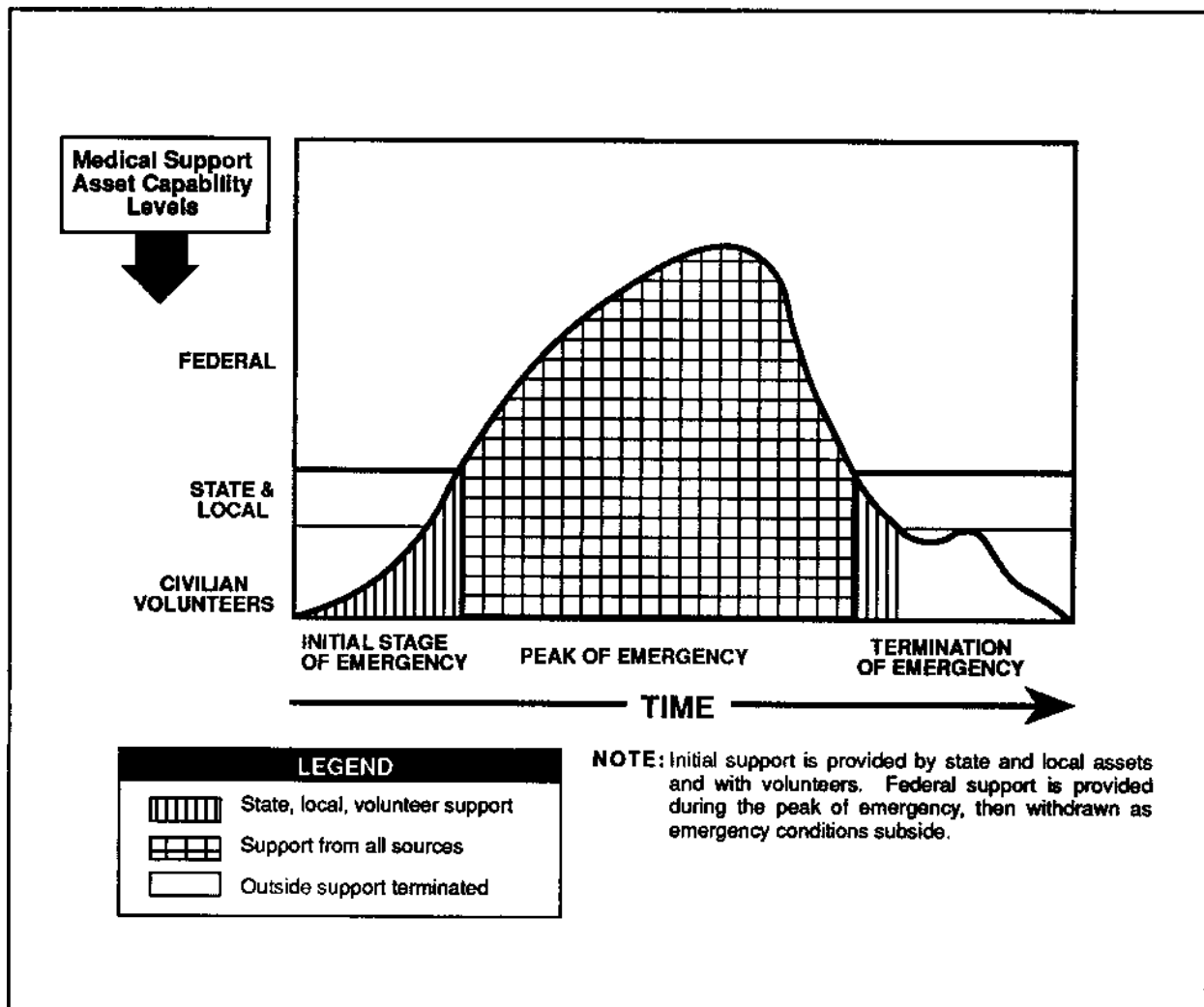


Figure 4-6. Military Medical Relief Support

## FINANCE

The finance mission is to sustain operations by providing timely commercial vendor and contractual payments, various pay and disbursing services, and all essential accounting. Organizational support is provided to organization units as required. It includes payment for local procurement of supplies and services, legal claims, and so forth. Finance units must provide accurate cost descriptions for initial input into the accounting system for all transactions.

Procurement support, the most critical finance mission, covers two areas. Contracting support involves the payment of commercial accounts for goods and services obtained through formal contracting procedures. Finance units can disburse currency and checks, which can alleviate shortages and delays in the procurement of various supplies and services. Commercial vendor services (CVS) meet immediate needs that cannot reasonably be met by normal logistics. Imprest fund cashiers, finance support teams (FST), and Class A agents may pay CVS in cash. Units must appoint Class A agent officers to make cash payments when they will be delayed.

*The 312th Army reserve Band from Lawrence, Kansas, developed a counterdrug program for school kids. During their summer 1992 annual training (AT), band members designed a mixed program of music, dance, and testimonials that told the children, in terms they could understand, that drug use is wrong and leads nowhere. The band expanded its AT effort and now regularly visits local schools, playing for and talking to young students.*

## BAND

The Army also provides band support. Bands contribute effectively to commanders' community relations programs. Patriotic and popular music instill feelings of well-being and pride and provide respite from worries and problems. The band stationed nearest

the involved area should be the one tasked to support civil authorities with musical programs.

## LEGAL

Judge advocates provide advice and assistance in the functional areas of the law, including administrative, contract, international, and operational law, as well as claims, legal assistance, and military justice. Historically during military operations, the duties of the judge advocate have concentrated on the military justice system. During support operations to US civilian authorities, this military justice mission may take a secondary role to the mission of providing advice on the laws dealing with military and civilian relationships. Questions concerning the scope and source of the commander's authority, liability of soldiers, and contingency contracting may come to the forefront. For example, after-action reports from Hurricane Andrew identified a greater need for judge advocate support for claims and contingency contracting.

## CHAPLAINCY

When federal units are called in, a high probability exists that a significant amount of devastation and trauma will be associated with the emergency. Early deployment of unit ministry teams (UMTs), which consist of one chaplain and one chaplain's assistant, will put care givers on the scene to deal with trauma.

Particularly at risk are soldiers who are confronted with the emotional impact of the disaster as they arrive on the scene. The chaplain's key role is to provide spiritual care and perspective to enable the soldiers to deal with the situation as they find it.

Early deployment is particularly critical when civilian care givers, such as pastors and social workers, are themselves traumatized victims of the disaster. During the initial response phase, these people will be extremely limited in their ability to provide care. Although the UMTs may not provide direct care to affected people, they can identify those in need of care and refer them to those who can help. Through consultation with local civilian religious leaders, faith groups, and organizations, the senior chaplain of the response force will assess physical and spiritual needs and determine ways to meet both.

During the aftermath of Hurricane Andrew, UMTs provided religious support to military personnel who were providing food, water, shelter, and medical care

to civilian victims. They also talked with victims, distributed food, counseled children, picked up debris alongside other relief workers, and visited the elderly. As they met civilians in the affected area, UMTs provided religious support. They also coordinated with civilian clergy to provide religious services for civilians remaining in the life support centers. UMTs became key coordinators with local religious organizations.

## **PUBLIC AFFAIRS (PA)**

Public affairs is a critical consideration in Army domestic support operations, where commanders must operate in an environment of complex information demands. Domestic support operations impart a lasting impression relative to the commitment of the civil-military teams. Ultimately, the impression of the assistance effort depends to a great extent on the media. The public's perception will also be influenced by the cooperation and coordination between commanders and civilian leaders and the efforts of the public affairs personnel.

**Commanders must be prepared to operate in an environment of complex information demands.**

The news media will have unrestricted access to domestic support operations. Army public affairs officers (PAOs) must operate under any constraints imposed by the government agency that has jurisdiction. The lead agency will have release authority. The Army must coordinate all PA activities with the lead agency and comply with public affairs guidance. Public affairs officers must establish an Army information bureau to work with the Joint Information Center (JIC).

The PAO advises the commander on the information demands that he can anticipate, the information strategies available, and the effect of the communication effort. It is sometimes necessary to create an *ad hoc* PA organization to support the operation. Regardless of how Army units provide PA support, it is critical that leaders involve their PA

personnel in planning and decision making.

Commanders should be prepared to provide timely and pertinent information to the media on developing issues and changing perceptions. They must be prepared to appear on camera, answer questions, and provide explanations in order to tell the story as completely, accurately, honestly, and openly as possible.

Commanders must also fill the information needs of their soldiers. Providing effective command information is a critical element in maintaining soldier morale and unit esprit. Soldiers need information about the environment in which they are operating. They need to know that their work is valid, moral, and supported by the American people.

## **SPECIAL OPERATIONS FORCES (SOF)**

Army special operations forces are particularly suited to domestic support missions. They are trained and experienced in operating in austere environments. Many are cross-trained in various disciplines. Three types of SOF units are especially well-suited to domestic support missions: civil affairs (CA), psychological operations (PSYOP), and special forces (SF).

### **CIVIL AFFAIRS**

CA units are specifically organized to use the civil sector functions and skills and to provide support to various levels of government in 20 specific functional areas. This working knowledge is especially useful in disasters. The units will tailor their capabilities to particular situations. CA units should be employed to advise the military commander on the impact of military activities on the civil sector. They assess damage to the civil infrastructure, assist in the operation of temporary shelters, and manage a civil-military operations center (CMOC). CA units may also serve as liaison between the military and the various civil organizations.

### **PSYCHOLOGICAL OPERATIONS**

The rapid production and dissemination of accurate information to the population in crisis situations are important. This information may include safety and health messages, location of water or food distribution

points, and designation of restricted areas and temporary shelters. Since the normal civilian facilities may be disrupted, these units may have to employ alternative methods. Equipment assets of PSYOP units (portable printing presses, loudspeakers, and radio broadcasting stations) have often been needed in disaster operations. PSYOP personnel can provide a commander with real-time analysis of the perceptions and attitudes of the civilian population and the effectiveness of the information being disseminated.

### **SPECIAL FORCES**

The SF team's organization, training, capability, and adaptability allow them to operate effectively in remote and urban areas isolated by disaster events. They may be able to provide detailed reports and assessments on conditions in the area. The teams are rapidly deployable, have excellent radio communications capabilities, and are suited to working with culturally dissimilar ethnic groups.

### **SIGNAL**

Forces deployed in domestic support operations must carefully plan their communications packages. Communications objectives must be determined, responsibilities defined, and types of support identified. The level of information mission area (IMA) support required depends on the nature of the assigned mission. In all likelihood, a combination of military and commercial communications support will be required. A major concern for the signal planner will be the interface between military and commercial communications and information systems and networks.

If the commercial communication infrastructure is incapable of supporting civil and military communication requirements, the Army signal planner must coordinate with his civilian counterpart to determine what communication capabilities are required. This information is essential to tailoring the signal support package.

Most civil and military communications systems are incompatible for various reasons, for example, equipment, frequency allocation, and usage. Though possible, it is highly unlikely that either element will have sufficient assets on hand to equip both with compatible communications equipment. For these reasons, military and civil communication planners must exchange knowledgeable communication support personnel and compatible equipment to ensure connectivity is maintained between military and civilian operation centers. This exchange of personnel and equipment can occur at any level and should be implemented and modified as the situation dictates.

### **CHEMICAL CORPS**

Army chemical units are trained and equipped to provide support in many technological accident or incident situations. Although the current focus is on chemical or nuclear accidents or incidents, the present technologies and doctrine allow for greater flexibility in responding to any mission associated with the FRP. Chemical units can support domestic support operations as individuals, teams, or units.

**Chemical units can support domestic support operations as individuals, teams, or units.**

The Army Technical Escort Unit (TEU), as a DOD executive agent, has the primary mission of responding to incidents that include hazardous and toxic substances. TEU and associated explosive ordnance disposal, security, and command and control elements routinely deploy to support the movement and demilitarization of toxic chemical munitions and substances. Nuclear accident/incident (NAI) and chemical accident/incident (CAI) during domestic support operations require coordinated efforts through

DOD, and with the DOE, EPA, and LEAs. DOD and FEMA have established joint policy for a coordinated response to a nuclear material accident. Army policy and the Federal Radiological Emergency Response Plan describe duties of these agencies and organizations.

A chemical battalion headquarters can provide command, control, and communications resources, as well as training support, for any technological and consultative operation involving nuclear, biological, and chemical (NBC) defense and operations. Chemical reconnaissance units are equipped to conduct surveys and determine the type and extent of toxic contamination with mobile spectral analysis. Chemical decontamination units can deploy with high-mobility vehicles allowing off-road employment of a wide range of equipment and capabilities. Both reconnaissance and decontamination unit capabilities allow for chemical and nuclear hazard surveying, detection, identification, monitoring, and personnel and equipment decontamination. Additional capabilities provide local security, vector control, and limited water transfer, spray, and storage, allowing a limited personnel shower and a firefighting capacity. Chemical smoke units also possess high-mobility capabilities as well as equipment for the employment of smoke and obscurants.

Technical support available to other agencies includes surveying radiological and hazardous material, monitoring, determining downwind contamination hazards, and assessing vulnerability and area damage as may be required for environmental missions or for disaster assistance operations. Training and consultation in NBC defense and operations, including the use of defoliants, the employment of riot control agents, and the construction and employment of flame field expedient devices, are also available for civil preparedness. Chemical units are capable of providing NBC defense training in law enforcement and counterdrug operations.

If chemical units deploy as self-sustaining entities, they are capable of at least 72 hours of operations without additional support. Follow-on support requires coordination for resupply of chemical defense equipment and material and life support. Military, federal, or contracted logistics support can provide the required resources.

## **SAFETY**

Installation or unit safety professionals may be required to provide safety services to a community in support of assistance operations. Whereas military support is intended to provide aid and comfort, the potential for a catastrophic accident is greatly increased if equipment designed for combat is used for disaster assistance. If, due to expediency, soldiers are tasked to perform services in which they have little or no formal training, for example, civil disturbances, flood control, or firefighting, the result could be the loss of soldiers or military equipment and additional damage to the community the soldiers are trying to support. Army safety services must be focused toward both the Army unit providing the support and the civilian community receiving it.

The Army commander's primary responsibility is to accomplish the assigned mission and to provide for force protection. He accomplishes this through the systematic use of risk management techniques and the total integration of safety throughout all aspects of the operation. He must use the same philosophy and techniques to ensure that Army services provided to the civilian community are free of unnecessary risk. The safety (risk management) staff officer advises the commander and his staff on all applications of the risk management process and recommends how to integrate the safety function. He also maintains liaison with, and provides assistance to, other Army, joint, or combined elements as required or directed by the commander.

### SUMMARY

Most domestic support operations are logistical in nature. Leaders and managers must understand the basic considerations and concerns necessary to accomplish those missions. Basic guidelines are to make a careful assessment of the mission, tailor the force for the mission, maintain accountability for resources expended, contract for support at the earliest opportunity, and transition support operations to local authorities as soon as possible. Force protection is a primary consideration and is implemented by identifying and eliminating unnecessary risks to the force and public.

---





## CHAPTER 5

# DISASTERS AND DOMESTIC EMERGENCIES

---

*The American people have come to expect Army support during times of critical need. Combat readiness, combined with organizational mobility, permits the Army to respond rapidly to crisis situations. This chapter describes how the Army provides support to federal, state, and local civil authorities during disasters and domestic emergencies.*

---

### THE ROLE OF THE ARMY

**The National Guard has primary responsibility for providing military assistance to its state.**

A fundamental principle for employing military resources is recognizing that civil authorities have the primary authority and responsibility for disaster assistance. The National Guard, in state active duty status, has primary responsibility for providing military disaster assistance in its state. The Army, as part of DOD, plays a supporting role to lead civil agencies during domestic emergencies.

As the DOD executive agent, the Secretary of the Army—through his Army Staff agent, the Director of Military Support—has both the responsibility and the authority to task the services, defense agencies, and the CINCs to support other federal, state, or local agencies. The SA will coordinate the commitment of unified and specified command forces with the CJCS. The chain of command is depicted at Figure 5-1.

### DISASTERS

A federal disaster is any event, either natural or man-made, whose severity or magnitude overwhelms the capabilities of local and state authorities to respond. Examples of natural disasters are hurricanes, earthquakes, floods, and fires. Hazardous chemical spills, radiological accidents, and massive electrical power disruptions are typical man-made disasters.

Each state has a plan and an Office of Emergency Services, or similar agency, that is responsible to the governor for coordinating its disaster response efforts. Local emergency organizations will be the first to provide disaster relief assistance; next are state organizations, including the state NG.

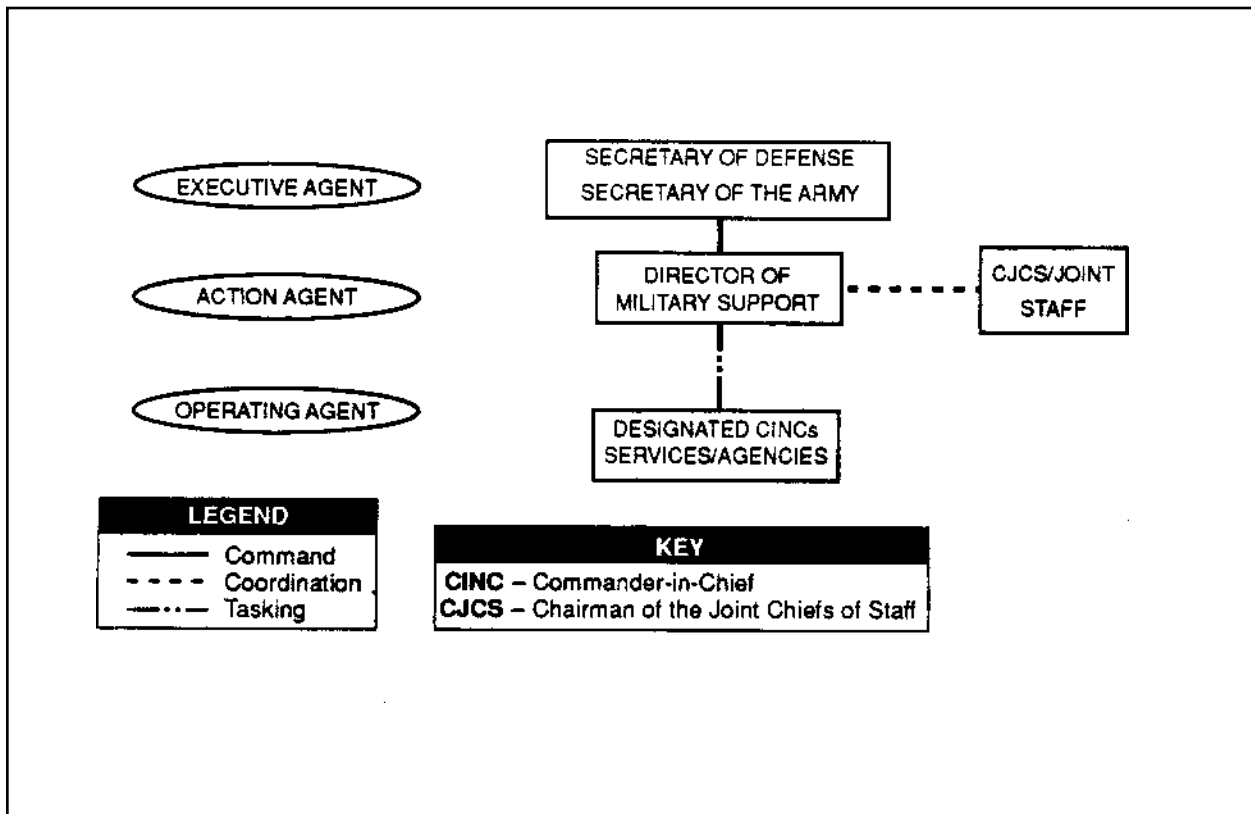
Prior to or immediately following a disaster, the state will activate an Emergency Operations Center to gather information, assess damage, and advise the governor. The state OES, through its EOC, coordinates the local and state disaster response operations. The state's adjutant general and NG also play key roles in disaster assistance.

**RESPONSE FOLLOWING  
A PRESIDENTIAL DECLARATION**

When the severity of a situation exceeds local and state capabilities, the governor can request that the President declare a disaster, leading to the commitment of federal resources. At that time, the FEMA takes the lead in coordinating federal assistance. The FEMA coordinates the federal government's response to state

and local authorities for disasters and civil emergencies under the authority and provisions of The Robert T. Stafford Disaster Relief and Emergency Assistance Act. While the FEMA is the lead federal agency in most disasters, the DOE has the lead for civil radiological emergencies, and the EPA and the USCG share responsibility for chemical contaminations.

Regardless of the disaster scenario, DOD can expect to support the lead federal agency. The SA will issue an Execute Order, coordinated with the Chairman of the Joint Chiefs and the Joint Staff, through the DOMS to the appropriate CINCs, services, and agencies. The Execute Order will designate a supported CINC and specify the supporting CINCs, services, and agencies as well as the command relationships. The Army has designated CINCFOR as the DOD operating agent and the supported CINC for CONUS disaster assistance operations. CINCLANT and CINCPAC are operating agents and supported CINCs for US states, territories, and possessions within their respective areas of operations.



**Figure 5-1. Chain of Command**

**The CINC will appoint a defense coordinating officer to coordinate all requests for military assistance.**

After declaring an emergency or disaster, the President will appoint an FCO to manage the federal assistance efforts under provisions of the FRP. The FRP addresses disaster or emergency situations in which federal response assistance is needed under the authority of The Stafford Act. The plan describes basic

mechanisms and structures by which the federal government mobilizes resources and conducts activities to augment state and local response efforts. The defense coordinating officer, appointed by the supported CINC, serves as the principal DOD point of contact for military support. The decision sequence for disaster support is illustrated at Figure 5-2.

**RESPONSE PRIOR TO A PRESIDENTIAL DECLARATION**

Military commanders may act before a Presidential declaration when an immediate life-threatening situation develops. When a disaster or emergency is imminent and awaiting instructions from higher authority—military or civil—would preclude responding effectively, military commanders may act. They

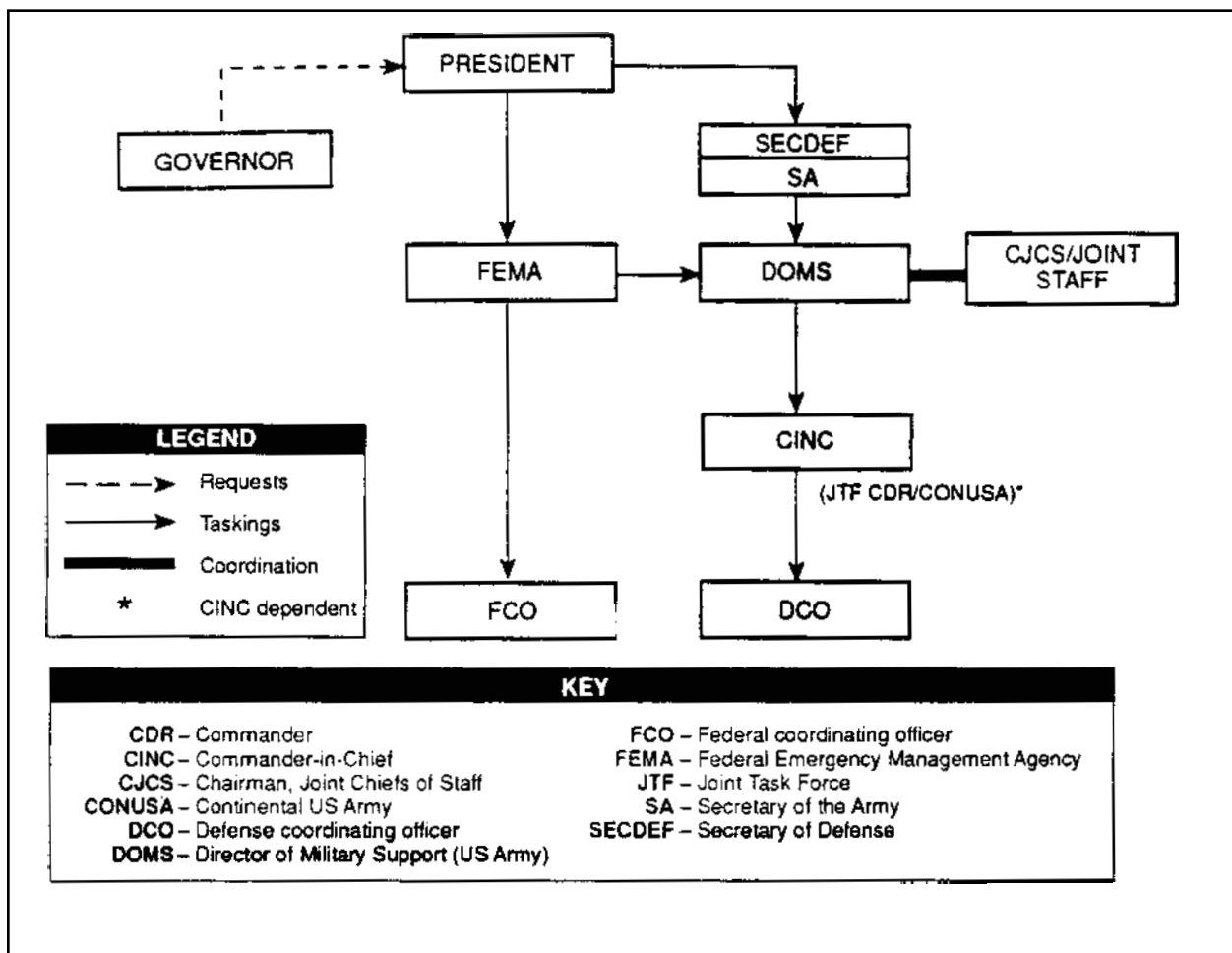


Figure 5-2. Decision Sequence for Disaster Support

may do what is required to save lives, alleviate human suffering, and mitigate major property damage within the proximity of their installations.

**Military commanders may act before a Presidential declaration when an immediate life-threatening situation develops.**

Commanders may use immediate response authority to assist in the rescue, evacuation, and emergency treatment of casualties; to restore emergency medical capabilities; and to safeguard public health. They may also provide essential public services and utilities. This list is not inclusive. Commanders use their assessment of mission requirements and the capabilities of their commands to judge the extent of immediate assistance they choose to provide.

Immediate response is a short-term emergency supplement to government authorities. It does not supplant established Army plans for supporting civil authorities, nor does it take precedence over a primary mission. Commanders notify their senior commanders and seek guidance for continuing assistance whenever Army resources are committed under immediate response circumstances. Immediate assistance is given with the understanding that its costs will be reimbursed; however, it should not be delayed or denied when the requestor is unable to make a commitment to reimburse.

When the President determines federal assistance will be provided in response to a natural or man-made disaster, the military commander will continue to provide immediate response assistance. He will adjust operations to conform with the tasks assigned by his higher headquarters, within the FRP.

### **PREPARING FOR DISASTER ASSISTANCE SUPPORT**

Commanders can best prepare for disaster assistance operations by understanding the appropriate laws, policies, and directives that govern the military in these emergencies. The military's role is well-defined and by law is limited in scope and duration. Military resources

temporarily support and augment—they do not replace—the local, state, and federal civilian agencies that have primary authority and responsibility for domestic disaster assistance.

The military does not stockpile resources solely for domestic disaster assistance. Disaster planning and coordination must occur between the appropriate agencies at the appropriate levels, for example, between DOMS and FEMA, between CINCs and CONUSA, between the federal, state, and regional agencies.

The Army's structure and training in command and control, deployability, and sustainment operations offer ready and robust capabilities for disaster assistance support. Those same skills that soldiers and leaders use day to day often translate to the types of tasks required during disasters.

Domestic disaster operations are normally conducted in stages: response, recovery, and restoration. The role of the military is most intense in the response stage, decreasing steadily as the operation moves into the recovery and restoration stages.

Response operations focus on those life-sustaining functions required by the population in the disaster area. Recovery operations begin the process of returning the community infrastructure and services (both municipal and commercial) to a status that satisfies the needs of the population. Restoration is a long-term process that returns the community to pre-disaster normalcy. While the military has an important role in the relief and recovery stages, restoration is primarily a civilian responsibility. Military forces will redeploy as operations transition from the response and recovery stage to the restoration stage. The overlap of military support and effort during the three stages is depicted in Figure 5-3.

### **Assessment**

Assessment is a fundamental task for providing effective disaster assistance. The assessment process requires the integration and analysis of information from many different sources. This process is not exclusively a DOD responsibility. It is first and foremost a local and state agency task. Federal agencies, including DOD, assist and cooperate in the information-gathering and assessment process.

Laws limit the types and ways military agencies can gather information in domestic situations. Commanders must ensure that all requests for information, both

before and during a domestic emergency, comply with the applicable laws and are handled in the appropriate military channels.

Responsibility for assessments is shared by federal, state, local, and military agencies. When a disaster occurs the damage and the anticipated military support requirements must be assessed before resources are committed. This ensures that the committed resources and forces will be appropriate for the mission and that they will be used efficiently.

The earliest information needed for the assessment process is the impact on the population, available critical infrastructure facilities, and any serious environmental hazards. Because saving lives is an immediate priority within the first 72 hours, especially in US&R operations, collapsed or badly damaged buildings that may contain trapped people must be identified. Mobile home communities, if not evacuated prior to the disaster, are especially vulnerable and likely to contain injured people. The status of the road

and rail systems, airports, and seaports must be determined. Identifying major fires, hazardous chemical spills, ruptured petroleum and natural gas pipelines, and downed electrical power lines—especially in populated areas—is a priority. Also essential is determining the status of local emergency services; police, firefighters, and health service providers.

As the federal relief effort escalates, including the deployment and employment of federal military resources in the disaster area, critical relief facilities must be made operational and accessible. These facilities include municipal offices, hospitals, water treatment plants, ice manufacturing and storage plants, electrical power stations or lines, and telecommunications nodes. Sites for the emergency shelter, feeding, and medical treatment of displaced civilians must be identified and prepared. These life support centers will be required within the first few days after a disaster. Sites for the reception, storage, and distribution of supplies in the affected area must be identified.

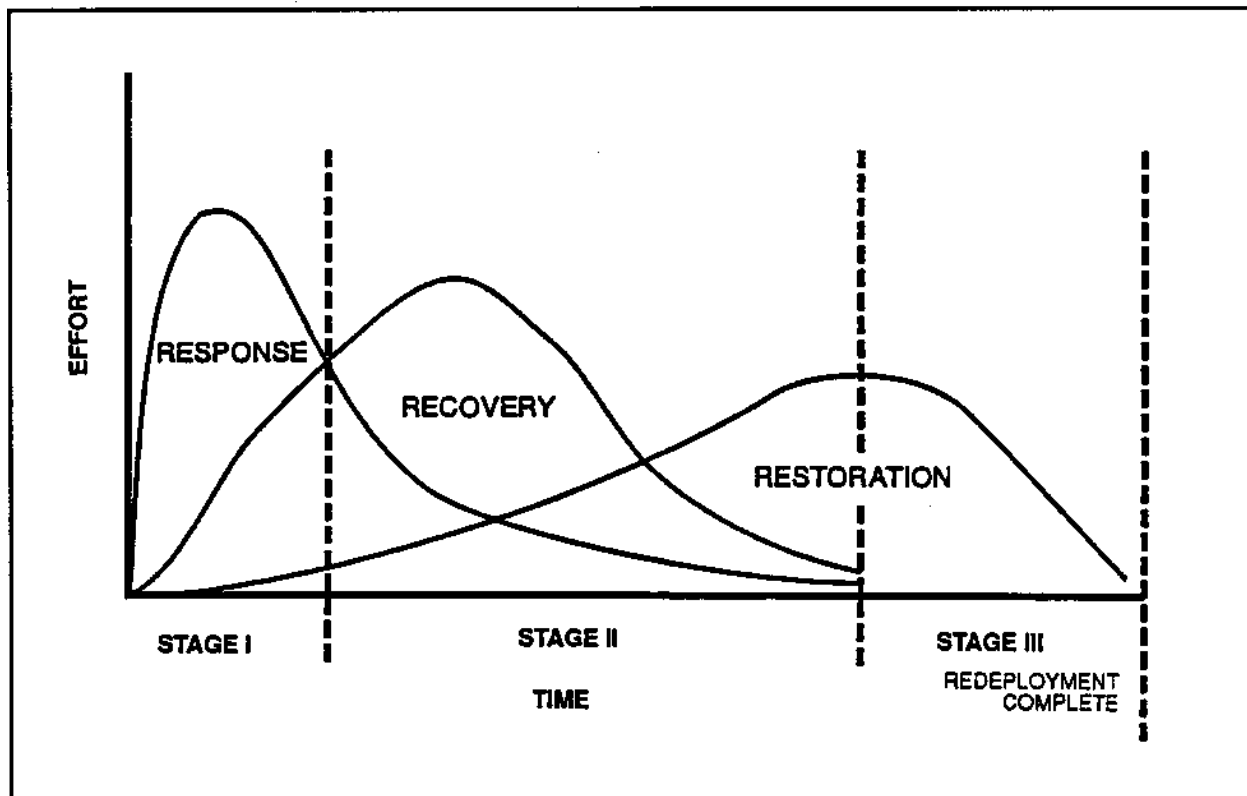


Figure 5-3. Military Stages and Levels of Effort

## Terminating Support

The military's role in disaster assistance must end as soon as practical. The ultimate task of the federal disaster response effort is to assist the local community in returning to a normal, predisaster status. Consequently, the military should expect to be heavily committed during the response phase of the operation, and progressively less during the recovery phase. As a principle, the military does not compete with civilian commercial enterprises. As a commercial enterprise becomes more available in the community, the military's provision of support and services can diminish.

**The military's role in disaster assistance operations must be transferred to civilian organizations as soon as practical.**

Disaster assistance operations require that end states or conditions be established to mark the completion of disaster assistance missions. Conditions must be definable and attainable. End states must be developed from the highest (national) perspective to the lowest county and municipal levels. They must provide a road map that can be followed by all government and nongovernment agencies involved. The affected population must know when military operations will cease and local support organizations are to continue the mission. Mission success will be tied directly to the military's ability to accomplish specific end-state objectives.

In conjunction with federal, state, and local officials, commanders at all levels must understand the desired community objectives or goals. They will affect the termination standards for the military as well as other federal agencies. The return to normalcy requires a progressive downsizing of the military's role.

Termination standards, which are established in coordination with the FCO and state and local

authorities, must be clearly stated and understood by all. They can usually be expressed in terms of percentage of predisaster capability by specific function, for example, 70 percent of electrical power restored. In an operation such as disaster assistance, redeployment of forces becomes a sensitive issue since it can create misperceptions and anxiety in the population with respect to sustained support needed and the ability of local government and contractors to handle the support as federal forces are withdrawn.

The criteria for mission success and completion must be defined, articulated, and disseminated as soon as possible. Civil authorities and Army personnel should know when the operation has reached completion or when Army assets will be withdrawn. It is important to understand that the mission may not be fully complete from the civilian authorities' perspective. Army support may have to be replaced by civilian assets and local support organizations, which will continue the restoration mission. Mission success should be directly proportional to the military's ability to accomplish specific milestones. Planners need to identify these milestones in their functional areas and use them, when accomplished, to reduce further military support requirements. These norms should be coordinated and validated for each of the possible missions, operations, and activities.

## THE FEDERAL RESPONSE PLAN

The Army and the DOD most often provide disaster assistance to other agencies in accordance with the FRP. This plan describes how the federal government responds to a declared disaster. When the plan is fully implemented, DOD and 26 other federal agencies provide support. The FRP groups disaster assistance into 12 functional areas called emergency support functions. During disaster response operations, some or all of these ESFs may be activated. The FRP assigns responsibility for each of the ESFs to a lead agency based on that agency's authority or capability. Each ESF will also have assigned supporting agencies. DOD has been designated the lead federal agency for ESF 3, Public Works and Engineering, and ESF 9, Urban Search and Rescue; a supporting agency in the remaining ten. Consequently, the Army may have resources committed in all 12 ESFs. The FRP emergency support assignment matrix is at Figure 5-4.

#	1	2	3	4	5	6	7	8	9	10	11	12
ESF			<b>PUBLIC WORKS AND ENGINEERING</b>		<b>INFORMATION AND PLANNING</b>			<b>HEALTH AND MEDICAL SERVICES</b>	<b>URBAN SEARCH AND RESCUE</b>	<b>HAZARDOUS MATERIALS</b>		
ORG	<b>TRANSPORTATION</b>	<b>COMMUNICATIONS</b>		<b>FIREFIGHTING</b>		<b>MASS CARE</b>	<b>RESOURCE SUPPORT</b>				<b>FOOD</b>	<b>ENERGY</b>
USDA	S	S	S	P	S	S	S	S	S	S	P	S
DOC		S	S	S	S	S	S			S		
DOD	S	S	P	S	S	S	S	S	P	S	S	S
DOEd					S							
DOE	S		S		S		S			S		P
DHHS			S		S		S	P	S	S	S	
DHUD						S						
DOI		S	S	S	S	S				S		
DOJ					S			S		S		
DOL			S				S		S	S		
DOS	S									S		S
DOT	P	S	S		S	S	S	S	S	S	S	S
TREAS					S							
VA			S			S	S	S				
AID								S	S			
ARC					S	P		S			S	
EPA			S	S	S			S	S	P	S	
FCC		S										
FEMA		S		S	P	S	S	S	S	S	S	
GSA	S	S	S		S	S	P	S	S	S		S
ICC	S											
NASA					S							
NCS		P			S		S	S				S
NRC					S					S		S
OPM							S					
TVA	S		S									S
USPS	S					S		S				

**LEGEND**

P – Primary agency responsible for management of the ESF.  
S – Support agency responsible for supporting the primary agency.

ESF – Emergency support function.  
ORG – Organization.

Figure 5-4. Emergency Support Assignment Matrix

### **Public Works and Engineering**

Public works and engineering support includes technical advice and evaluations, engineering services, potable water, construction management and inspection, emergency contracting, emergency repair of waste water and solid waste facilities, and real estate support. Activities within the scope of this ESF include emergency clearance of debris, temporary construction of emergency access routes, emergency restoration of critical public services and facilities, emergency demolition or stabilization of damaged structures and facilities, technical assistance and damage assessment, and support to other ESFs. The USACE is DOD's operating agent for planning, preparedness, and response operations for this ESF.

### **Urban Search and Rescue**

US&R activities include locating, extricating, and providing for the immediate medical treatment of victims trapped in collapsed structures. Designated operating agents for US&R in their respective areas of operation are the CINCFOR, the CINCLANT, and the CINCPAC. The DOMS will designate the appropriate operating agent as supported CINC.

The supported CINC will coordinate federal US&R operations and employ one or more task forces to conduct "light" (wood frame-type structures) US&R. The supported CINC will also manage military support for civilian US&R task forces. FEMA-sponsored teams provide the necessary expertise and equipment for "heavy" (masonry/concrete and steel, multistory structures) US&R. The USACE has structural specialists trained to assist in US&R. Transportation, medical, billeting, and maintenance are the types of support that civilian US&R teams may require.

### **Support to Other ESFs**

DOD support to other ESFs may come from one of two sources. First, when the primary agency for an ESF determines that it requires support or resources from outside its own agency, that agency may coordinate its requirements with the FEMA through its regional and national headquarters. The FEMA will then determine how to provide the required support or resources from any nationwide source. DOD, a designated supporting agency, may be tasked. Second, an FCO may task DOD to provide the required support or resources from military assets already within the disaster area or available through DOD channels. The FCO gets this

support through coordination with the defense coordinating officer.

## **RESPONSIBILITIES**

### **FEDERAL COORDINATING OFFICER**

An affected state or area will receive federal assistance through the management of FEMA and the overall coordination of an FCO, usually the FEMA regional director. The FCO is the on-scene commander for all federal resources supporting local and state authorities in the assistance effort.

### **DEFENSE COORDINATING OFFICER**

In the field, the DCO, appointed by the supported CINC, is the central point of contact to the FCO and ESF managers for all requests for military support. At the discretion of the CINC, the DCO may assume control of all federal military units involved in a disaster. The DCO's expertise and constant liaison with the FCO, local officials, and other ESF managers are critical to the effective coordination and integration of the federal and state disaster assistance efforts. Traditionally, CINCFOR has tasked the CONUSAs to plan for disasters and domestic emergencies and to appoint DCOs following a disaster declaration. The DCO supervises the DCE, a staff that can support both the administrative and the ESF functional areas for all coordination and decisions.

### **STATE COORDINATING OFFICER (SCO)**

As the governor's representative, the SCO is responsible for emergency management, disaster response, and recovery activities. The SCO is the primary point of contact for the FCO in facilitating disaster assistance. The STARC has developed disaster emergency plans in coordination with other state and local agencies. The STARC and the DCO will establish liaison so that local, state, and federal activities can be coordinated and managed effectively. The STARC can assist the federal forces with contracting support as well as logistical support from Guard resources not otherwise committed.

## **JOINT TASK FORCE (JTF)**

Military support to civil authorities in disasters and domestic emergencies is a DOD, not a service component responsibility. The supported CINC may decide that the severity and scope of a disaster require a joint



response. In disaster assistance, as in operational level warfighting, the CINC uses the different and complementary capabilities of each service to accomplish the mission. Such use requires knowledge of both the capability and the availability of all service component assets, to include their agencies and installations.

**The CINC may establish a joint task force to provide comprehensive military support.**

Establishing a JTF may provide the best DOD response in a disaster. The DOD's response to Hurricanes Andrew and Iniki in 1992 demonstrated that a JTF is effective in providing the comprehensive support needed in most catastrophic situations. A JTF is established to execute a specific mission limited in scope and duration. The JTF's objective in a disaster is to deploy forces to the disaster area rapidly, to assist immediately in saving lives and safeguarding property, and to continue providing assistance required by the FRP and the particular situation.

The CINC has the authority to determine the command relationship between the DCO and JTF commander. The DCO serves as the DOD's central point of contact for all requests from the FCO and ESF managers for military support. If the size of the JTF expands and the CINC decides to designate another, more senior officer as the JTF commander, the DCO becomes a special staff officer for the JTF commander.

The JTF is configured for each specific mission. In disasters, the JTF may require a greater proportion of combat service-support-type units and capabilities than in typical warfighting deployments. The JTF must be able to provide emergency assistance across all lines of support. All classes of supply and all types of services may be required. Because DOD has a supporting responsibility in all ESFs, close cooperation between the JTF and all other ESF agencies is required through the FCO, DCO, and state emergency structure. Command relationships between these authorities and organizations are illustrated at Figure 5-5.

*When Typhoon Omar struck the American territory of Guam in August 1992, the CINCPAC appointed the Commander, Naval Forces Marianas (COMNAVMAR), as the DCO and the JTF commander. In response to Hawaii's Hurricane Iniki less than one month later, the CINCPAC appointed the Commander, US Army, Pacific (USARPAC), as Commander, JTF Hawaii and the DCO.*

The military has been involved in such diverse disaster relief activities as the preparation and distribution of food, removal of debris and garbage, restoration of electrical power and water systems, management of donated goods and services, and establishment of life support centers that provide shelter, security, medical care, counseling, bath and laundry, and recreation activities. The JTF commander may establish joint cells to manage specific functional or technical areas, such as a joint movement center.

## DOMESTIC EMERGENCIES

### CIVIL DEFENSE EMERGENCIES

Civil defense emergencies result from the devastation following an enemy attack, although they may be proclaimed by appropriate authority in anticipation of an enemy attack. Specific plans and orders at the appropriate command levels provide general guidance for responding to an enemy attack. Local Army commanders are authorized to respond to civil defense emergencies under immediate response and to deal with immediate emergency conditions that would be created by such attacks or disasters.

In the event of an attack on the US, the scope of military support to the civil authorities in each affected area would depend on the requirements of military operations, the extent of damage sustained in the civilian community, and the status and reconstitution priorities of the active and reserve component forces. The Army National Guard STARC, when ordered to federal service, will become the DOD's focal point for providing military assistance at the state and local

levels. CONUSA commanders must coordinate the response to these civil emergencies with the STARCs.

**ENVIRONMENTAL DISASTERS**

DOD may be called on to support other federal agencies during major environmental disasters. For example, the DOE has responsibility for civil radiological emergencies and the EPA and USCG

share responsibility for chemical contamination accidents, such as major oil spills. The FEMA may also be involved in a complementary role, managing federal relief operations associated with a disaster. Regardless of the disaster scenario, the Army and DOD should expect to provide military support appropriate to the nature of the disaster and the needs of the people affected.

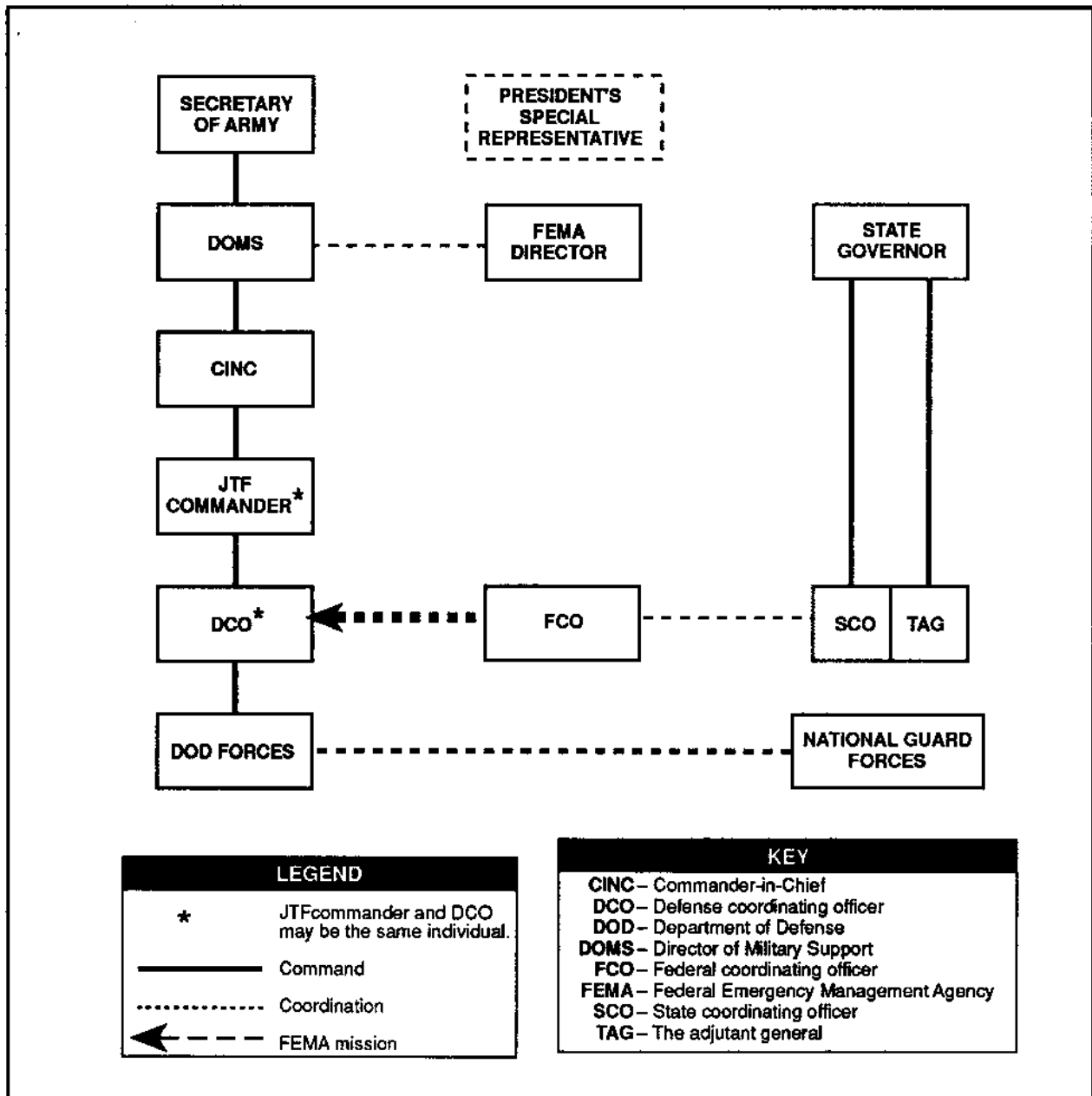


Figure 5-5. Command Relationships

## MASS IMMIGRATION EMERGENCY SUPPORT OPERATIONS

The DOD may be called on to provide support to the DOJ and its INS. The DOJ is the lead federal agency; INS is its action agency. In the event of an immigration emergency, the SA is the DOD executive agent, DOMS the action agent. The DOD may be tasked to assist in the reception, processing, transportation, and detention of the immigrants. DOD installations and facilities may be required to house immigrants for extended periods of time. These installations may have to provide a full range of services, either by DOD or by contracted agencies. Even on DOD installations and facilities, however, the DOJ and INS have the primary responsibility for the legal processing, custody, and eventual deportation or resettlement of the immigrants.

*During Operation Provide Refuge in February 1993, a task force from the 25th Infantry Division provided security and humanitarian assistance to 535 Chinese nationals who attempted to illegally enter the United States. The Chinese were fed, clothed, and housed in a US facility on Kwajalein Atoll, Republic of the Marshall Islands, until the People's Republic of China agreed to their repatriation.*

## OTHER DIRECTED MISSIONS

The DOD receives many diverse missions requiring military assistance to civil authorities. They include planning to use DOD personnel in the event of a large disruption to US mail service and air traffic control assistance in the event of a federal air traffic controller strike. The type and level of military support will be as diverse as the missions. The general concepts, principles, and guidelines for disasters, emergencies, and other assistance operations may be useful to Army commanders located OCONUS, but are subject to applicable CINC guidelines and host nation laws and agreements.

*Guardsman in Alabama, Georgia, Kansas, Kentucky, Maine, New York, North Carolina, Ohio, South Carolina, Virginia, and Wisconsin were called up in Operation Haylift to deliver relief to farmers throughout the southeast during the drought of 1987.*

## SUMMARY

The Army and the Department of Defense provide military support to civil authorities, especially in disaster assistance operations. DOD is a supporting agency, providing military support to other lead federal agencies. The SA is DOD's executive agent, and the DOMS is the SA's agent for disaster assistance support. In most cases, the Army will participate in disaster assistance operations as part of a DOD effort managed by the DOMS serving as a joint staff and commanded by a supported CINC. The Army is committed to providing timely and effective disaster assistance support to other federal agencies and the American people.



## CHAPTER 6

# ENVIRONMENTAL MISSIONS

---

*The Army has developed and fielded an integrated environmental program that employs a variety of resources to assist US civil authorities in environmental activities. The Army's environmental strategy rests on the pillars of compliance, restoration, prevention, and conservation. The pillars rest on a bedrock of shared national values that support the essential foundation of people, resources, communication, and organization. They also support the vision and ethic of environmental stewardship that underlies the Army program. Figure 6-1 depicts this strategy.*

---

### PLANNING AND EXECUTION

**The ethic of environmental stewardship underlies the Army's environmental strategy.**

If consistent with the unit's mission, commanders can allocate people and resources for the planning, technical assistance, oversight, and execution of environmental assistance missions.

- Planning focuses on environmental resource management and contingencies for incidents that adversely affect human health or the environment. It includes preassistance efforts such as developing local agreements and memorandums of understanding and integrating mutually supporting plans.
- Technical assistance covers a broad array of activities. The Army can help develop off-the-shelf plans and scopes of work, conduct on-site assessments, provide procurement advice, and augment local staffs with technical personnel.
- Oversight focuses on support roles such as administering contracts and providing staff support for operations.

- Execution employs US Army manpower and equipment to perform a mission.

*A CH-54 "Skycrane" from Company D, 113th Aviation Battalion, Nevada National Guard, carried a slingload of construction materials from Mount Rushmore. The material had been on the mountain since 1941. The 113th removed the materials during Golden Coyote '92 in the Black Hills of South Dakota.*

### CHARACTERISTICS

Environmental support missions are characterized by the time required to accomplish them:

- Short-term or immediate-response missions require 30 days or less. They include oil and hazardous materials spills, removal of materials that contain military specific chemicals, and support in fighting wildland fires.
- Mid-term missions require 30 to 180 days. They include environmental compliance-related matters and responses requiring longer-term assistance.
- Long-term missions require more than 180 days. They include remediation or research and development support that requires contracted effort.

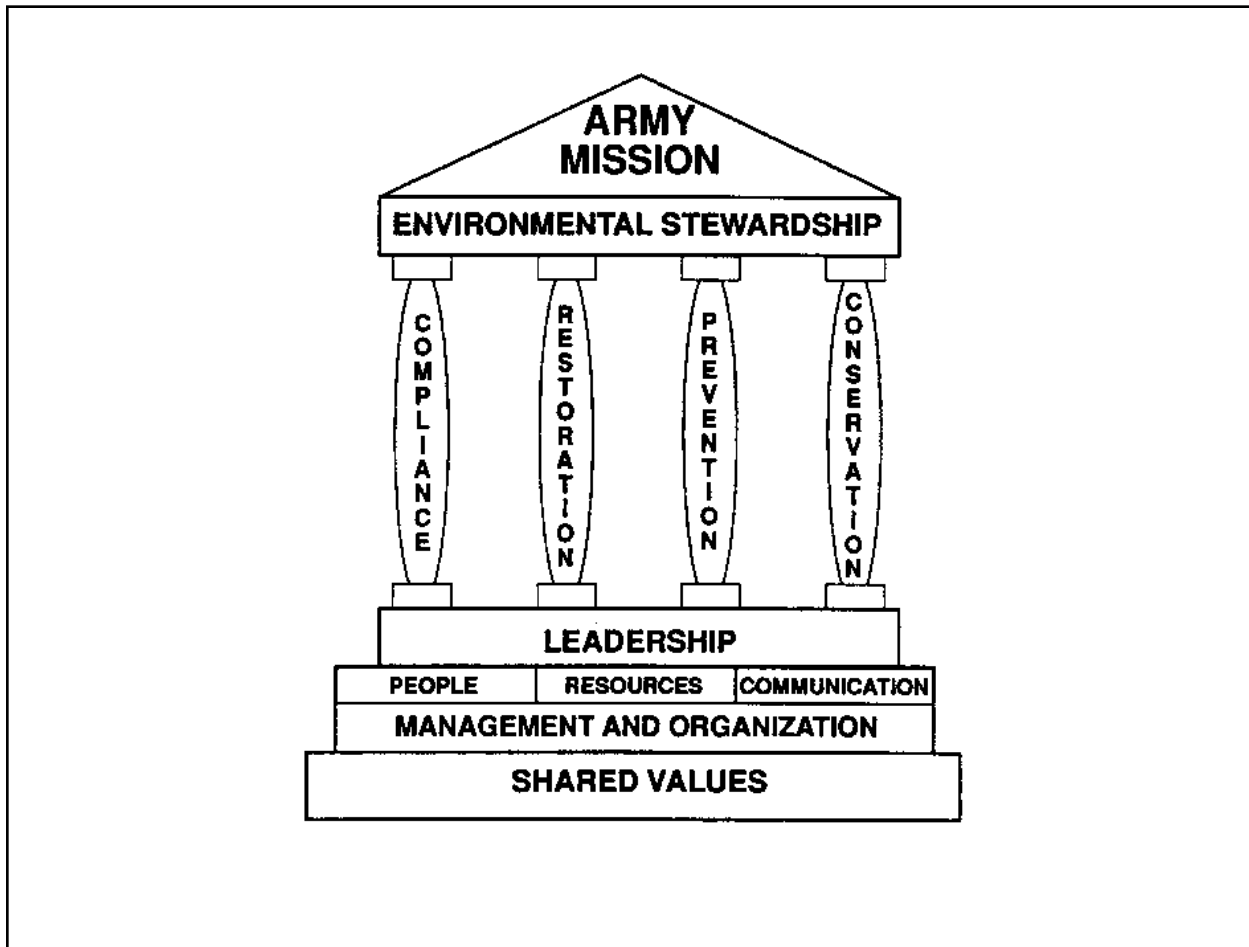


Figure 6-1. Pillars of Army Environmental Strategy

**CLASSIFICATIONS**

The Army classifies environmental support as compliance, restoration, prevention, and conservation. These four classifications correspond to the pillars of the Army environmental strategy, which provide direction for attaining and sustaining environmental resources stewardship.

**COMPLIANCE**

As an environmental leader, the Army works with regulators and citizens' groups, a cooperative approach that is necessary for successful relations with the local community and other government agencies. Army assistance responds to immediate needs or is provided as a general service.

Response includes support to correct oil and hazardous material spills under the National Contingency Plan (NCP) and control of chemical incidents. General services include support to improve compliance with environmental laws and regulations. The primary compliance missions are listed in Figure 6-2.

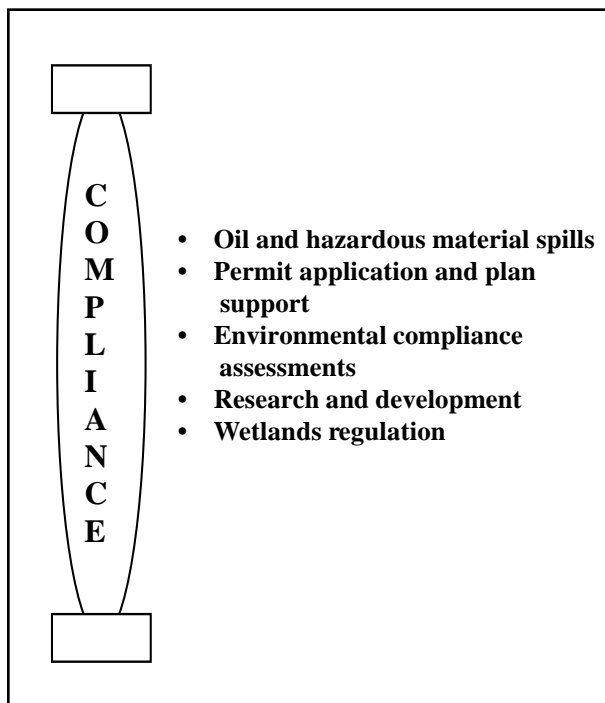


Figure 6-2. Compliance Missions

**OIL AND HAZARDOUS MATERIAL SPILLS**

Oil and hazardous material spills are common occurrences. Any release of a reportable quantity of oil or hazardous material requires an immediate response. Larger-scale, catastrophic releases may occur as a result of man-made or natural disasters. Under the NCP for response to oil and hazardous material spills, the Army provides representatives to the national response team and the 10 regional response teams for both planning and response.

*On 5 January 1993, potentially volatile World War I-era liquid-filled munitions were unearthed in a residential area of Washington, DC. The location had been a chemical research site between 1917 and 1919. With support from the 101st Chemical Company, Fort Bragg, NC, the Army Environmental Hygiene Agency, the Army Armament, Munitions, and Chemical Command, the Corps of Engineers, and other local, state, and federal agencies, the cleanup began. By the last day of excavation, a total of 141 munitions had been safely unearthed.*

The director of military support coordinates Army response for large-scale spills based on requests from the EPA/USCG on-scene coordinator (OSC). Small-scale releases are more common. The Army can respond directly to small-scale releases when the spill is beyond the capability of civilian response assets or the Army has jurisdiction over the spill area.

**The Army can respond to oil and hazardous material spills under**

**established procedures.**

An installation commander may assist in identifying, surveying, containing, and cleaning up small-scale releases of oil and hazardous materials. The commander’s installation spill response group typically consists of trained personnel from the fire department or environmental staff. When the Army employs chemical units, it does so under the Nuclear and Chemical Accident and Incident Response and Assistance (NAIRA and CAIRA) Program.

Under the NAIRA and CAIRA Program, the Army can provide an immediate or planned response to a crisis or situation involving radiological or hazardous materials. Nuclear or chemical accident or incident control (NAIC/CAIC) emergency response elements organized as an initial response force (IRF) can respond immediately to the spill site to save lives, preserve health and safety, and prevent further damage to the environment.

If further action is needed, the service response force (SRF), a DA-level emergency response force, will deploy to the site. The SRF continues response operations, provides command and control of all military forces, and coordinates the activities of federal, state, and local response agencies. The Army SRF commander, executing the role of the federal OSC, executes coordinating duties per Army policy and the NCP.

**PERMIT APPLICATIONS AND PLANS**

Some government facilities may not be sufficiently staffed to address all applicable compliance requirements. Army personnel can assist these facilities in successfully completing and submitting applications and plans for permits. Depending on the size and mission of the environmental staff, a local commander can support short-term local missions. The USACE can best handle more extensive efforts on a cost-reimbursable basis. Typical compliance support projects include:

- Preparing Resource Conservation and Recovery Act (RCRA) Part B permit applications, closure plans, waste analysis plans, and underground storage tank site assessments.
- Preparing spill prevention, control, and countermeasures and spill contingency plans.
- Preparing National Pollutant Discharge Elimination System (NPDES) permit applications.

- Preparing air quality permit applications.

**ENVIRONMENTAL COMPLIANCE ASSESSMENTS (AUDITS)**

The Army can assist other government facilities in attaining and sustaining compliance with environmental laws and regulations. USACE districts provide comprehensive environmental compliance assessments that identify deficiencies and requirements for corrective action.

*The Army developed the Geographic Resource Analysis Support System (GRASS) that allows Army environmental and land managers to analyze, store, update, model, and display data quickly and easily. Analysis and display can be created for an entire geographic region. More than 100 Army installations, the National Park Service, and the Soil Conservation Service are currently using GRASS.*

**RESEARCH AND DEVELOPMENT**

The Army emphasizes joint technology development and use with the EPA, the DOI, and other government agencies. This transfer of information improves compliance throughout the nation. The Army conducts an extensive environmental research and development program that focuses on developing methods and equipment to meet the growing compliance requirements of new laws and regulations. The Army has developed technical products independently and transferred them to other government agencies. The Army has also developed them jointly with other federal agencies. Within the Army, most environmental research and development occurs through the USAEC and USACE laboratories.

**WETLANDS**

The USACE administers the National Wetlands Protection Program for the federal government. In this capacity, the Army serves as a regulator and oversees the

restoration and mitigation of wetlands within the US.

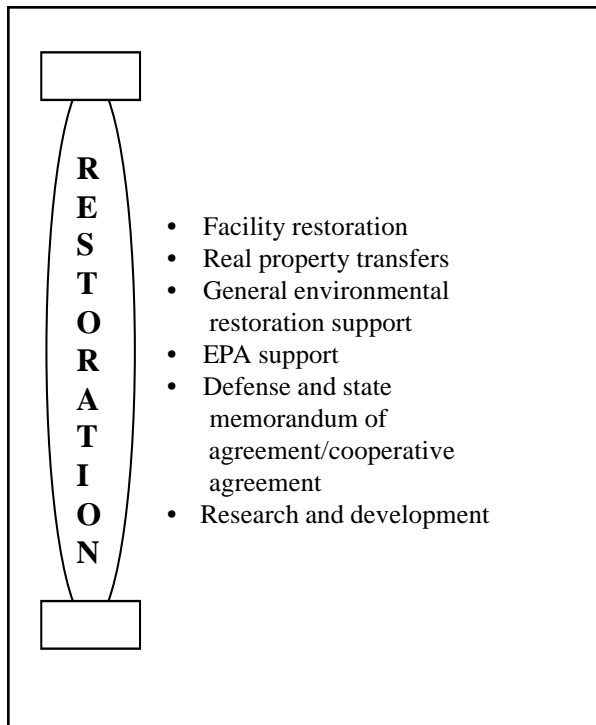
*In Illinois, an Army National Guard engineer battalion detonated 5600 pounds of explosives as part of its training and built a home for ducks at the same time. The explosions were intentionally set off near a lake to create a series of duck ponds.*

**RESTORATION**

Environmental restoration missions include correcting contamination problems resulting from past operations. Environmental investigations and remediation conducted by the Army mitigate adverse impacts to human health and the environment. Restoration efforts maximize the amount of property available for reuse and redevelopment.

Restoration missions fall into three categories: facility restoration, real property transfers, and general support. The USAEC and USACE can provide assistance in these areas. The USACE can provide longer-term assistance on a cost-reimbursable basis, while USAEC may provide short-term assistance. The primary restoration missions are depicted in Figure 6-3.

**The Army conducts environmental investigations and remediation to protect human health and the**



**Figure 6-3. Restoration Missions**

**environment.**

**FACILITY RESTORATION**

The Army has extensive expertise in investigating and restoring sites under their control. In the Installation Restoration Program (IRP), the Army investigates sources of contamination, extent of contamination, exposure pathways to potentially impacted people and ecosystems, and potential health and ecological risks. Activities routinely conducted at Army sites include:

- Assessing current site conditions, identifying past operations contributing to current site contamination, and determining whether further investigations are needed.
- Developing and implementing public involvement and public relations programs.
- Characterizing the nature and extent of contamination at suspected sites.
- Quantifying the risk to human health and the environment from contaminated sites and



- determining appropriate cleanup levels.
- Developing and evaluating alternatives for site remediation.
- Designing and implementing appropriate cleanup actions.

On request, USACE provides technical support to other federal agencies in the Work-for-Others Program. In this program, the other federal agency retains control and responsibility for the action but uses the technical capabilities of the Corps to accomplish the task.

### **REAL PROPERTY TRANSFERS**

The storage, release, and disposal of hazardous materials and wastes directly affect the transfer of real property. The Army has gained considerable experience in mitigating these issues for unexploded ordnance (UXO), lead base paints, radon, asbestos, and polychlorinated biphenyls (PCBs). The Army assists local committees in developing reuse options that fully consider all appropriate environmental issues, identifying clean parcels, and remediating contaminated parcels. The Army can provide this support in any real estate transfer that other government agencies may consider.

### **GENERAL SUPPORT**

The Army supports both state and federal agencies through specifically negotiated agreements. It provides direct support to the EPA in implementing The Comprehensive Environmental Response, Compensation, and Liability Act (CERCLA) of 1980. The Army supports state regulatory agencies through the Defense and State Memorandum of Agreement/Cooperative Agreement (DSMOA/CA) Program. It conducts cooperative efforts in developing innovative technologies with other government agencies.

### **EPA Support**

The Army has entered into an interagency agreement with the EPA to provide assistance in executing CERCLA, also known as the Superfund. Under this agreement, USACE serves as the program manager for execution activities assigned by EPA. These assignments include—

- Providing technical assistance during the EPA's remedial investigations feasibility studies.
- Acting as the contracting officer for federal lead remedial design and remedial action activities.
- Providing technical assistance during the EPA's

- enforcement activities.
- Providing technical assistance and oversight of the EPA's alternative remedial contracting strategy (ARCS) contractors.
- Assisting in real estate and other support activities.

### **Defense and State Memorandum of Agreement/Cooperative Agreement Program**

The DSMOA/CA Program was established to facilitate state and US territory involvement in cleanup activities conducted under the Defense Environmental Restoration Program. DSMOAs/CAs provide a mechanism to involve states in installation restoration activities by establishing the terms and conditions by which they are reimbursed for the cost of providing technical support.

### **Research and Development**

As a part of its environmental research and development program, the Army pursues cost-effective restoration technologies that can be transferred to any user. The US Army Environmental Center can provide consultations in such areas as analytical chemistry and industrial hygiene. The USAEC and USACE laboratories can provide assistance in applying technology.

*The Army demonstrated an innovative idea for recovering heat lost at boiler plants at the Louisiana Army Ammunition Plant. The teflon-covered heat exchangers will pay back the investment in 5.2 years. This process saved the plant \$13,000 in FY 88 and has potential for widespread application in military and civilian boiler plants.*

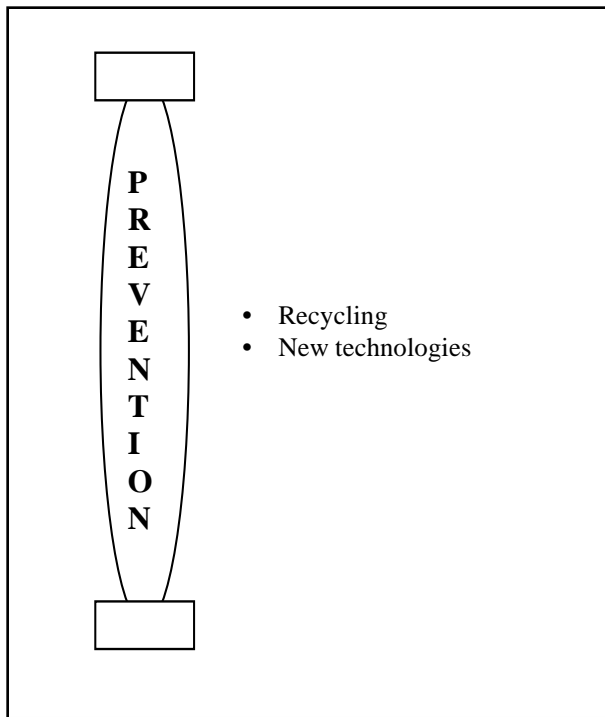
## **PREVENTION**

Prevention assistance missions focus primarily on participating in pollution prevention programs with other agencies. The Army also shares information and technologies that reduce the discharge of pollutants into the environment. Pollution prevention is an ethic that must be learned at all levels of an organization. As a result of implementing its own pollution prevention

program, the Army has gained considerable experience from recycling solid waste to manufacturing process changes.

**The Army has gained valuable experience in preventing pollution.**

Installation commanders can help local communities develop community recycling programs and support them. The local commander can work with local, county, or regional solid waste management organizations to integrate recycling efforts. Possible prevention missions are shown in Figure 6-4.



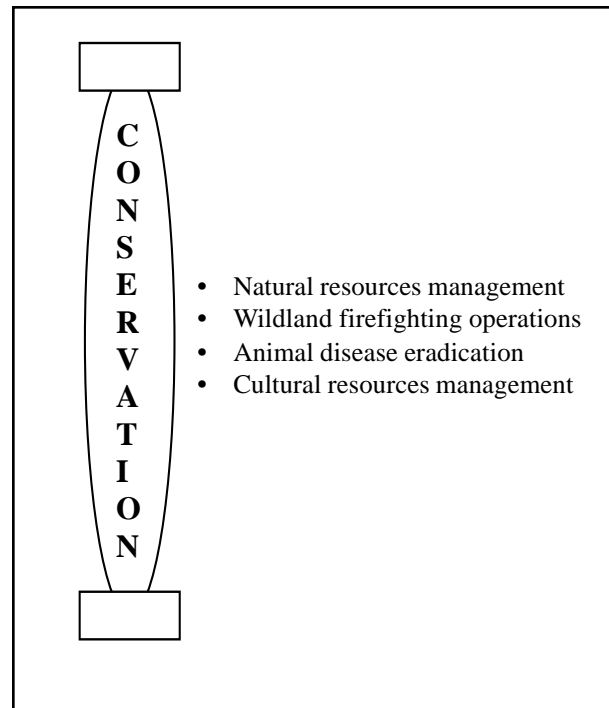
**Figure 6-4. Prevention Missions**

Pollution prevention is another driving force in the Army's environmental research and development program. Its efforts focus on changing or replacing existing processes to reduce and ultimately stop pollutant discharges. Examples of these technical innovations are the new generation of metal-plating procedures and advances in solid waste recycling.

Once again, the Army may develop these technologies in concert with other government agencies or alone, then share their findings with other agencies.

**CONSERVATION**

Conservation assistance missions address the preservation and protection of America's natural and cultural resources for future generations. The Army works to conserve and protect natural and cultural resources on a daily basis. Typical Army conservation missions are listed at Figure 6-5.



**Figure 6-5. Conservation Missions**

**NATURAL RESOURCES MANAGEMENT**

With vast acreages, the Army conducts intensive military training while providing many sanctuaries for a wide variety of plants and animals. In so doing, the Army has gained experience in the proper care, repair, restoration, and management of these resources.

The Army often works with state and federal agencies in managing soils, vegetation, fish, wildlife, and water resources. The Army and the public both benefit from this cooperative effort because the

protection of natural resources enhances the mission and preserves the environment for all.

**The Army has vast experience in advanced land management techniques.**

*Approximately 300 breeding pairs of the red Cockade woodpecker and other endangered bird species were on Fort Bragg, NC. To save them, the Army closed off areas to vehicles, marked bird colony nesting boundaries, taught soldiers to recognize and observe training restrictions, built beams to absorb rifle fire on ranges, and set up artificial nests to attract more birds.*

### WILDLAND FIREFIGHTING

The Army may provide manpower and equipment to assist the NIFC in suppressing wildland fires. Initially, the NIFC contacts DOMS and requests military assistance. The DOMS tasks the appropriate CINC to appoint a DCO to confirm military support requirements. Once the DCO is appointed, the NIFC passes all resource requests to him. The Army may provide aviation, engineer, and communications support in addition to firefighters. The federal land manager trains soldiers before they are employed to fight fires. The NIFC provides the needed firefighting equipment and reimburses DOD from either the USDA or the USDOJ. The wildland firefighting tasking and resourcing channels are depicted at Figure 6-6.

### ANIMAL DISEASE ERADICATION

In the event of an emergency arising from an actual or imminent outbreak of a foreign plant or animal disease, the DOD provides assistance to the USDA's

Administrator for Animal and Plant Health Inspection Service (APHIS). The Secretary of the Army, as DOD's executive agent, designates the Commander-in-Chief, Forces Command, as the operating agent supported CINC for DOD support to the USDA.

CINCFOR, as directed by the director of military support, provides personnel, equipment, supplies, and services to support the Regional Emergency Animal Disease Eradication Organization (READEO) task force. The READEO is the USDA organization responsible for completing all containment and eradication missions.

Included in CINCFOR's support is designating the base support installations (BSIs); tasking supporting CINCs, services, and agencies; developing contingency plans; and participating in exercises. Upon direction of CINCFOR, the BSI commanders provide personnel and logistics to the task force. USDA reimburses DOD for actual costs, less pay and allowances.

The BSIs may be outside FORSCOM and the Army. Resources provided by the BSIs can include technically qualified personnel to assist the USDA; the LSO; minimum essential TOE, TDA, and individual equipment; and procurement support.

The two key liaison officers are the veterinary support officer (VSO) and the LSO. The VSO, who is designated by Health Services Command, serves as the military point of contact with the READEO task force for veterinary support requirements. The LSO coordinates with the READEO task force director and determines the personnel, administrative, and logistical support requirements in the area of operations. The LSO provides the support requirements to the BSI and oversees the employment of DOD personnel and equipment. Figure 6-7 depicts command relationships for animal disease eradication operations.

### CULTURAL RESOURCES MANAGEMENT

The Army works to preserve cultural resources for present and future generations. The Army may provide experts in the field of historic preservation from the USAEC, USACE, and the local installations. Many communities are involved or are interested in preservation of historic buildings and similar properties but may lack expertise. This is especially true in many rural areas.

Installations or other Army activities may provide some assistance to local communities at no charge. Army experts may assist in developing local historic

preservation committees and ordinances, identifying historic properties, and providing technical advice on the proper treatment of historic properties. For more involved projects, USACE districts and laboratories can provide assistance on a cost-reimbursable basis.

**ARMY RESOURCES**

Upon request, the Army can provide national-level resources for state and local environmental problems.

The Army offers a breadth of experience and the ability to provide solutions from regions throughout the United States to local environmental managers.

**DEPARTMENT OF THE ARMY**

At the DA level, the Director of Environmental Programs is responsible for policy guidance and program oversight. His primary source of technical expertise is the US Army Environmental Center, a field operating agency of the DA staff.

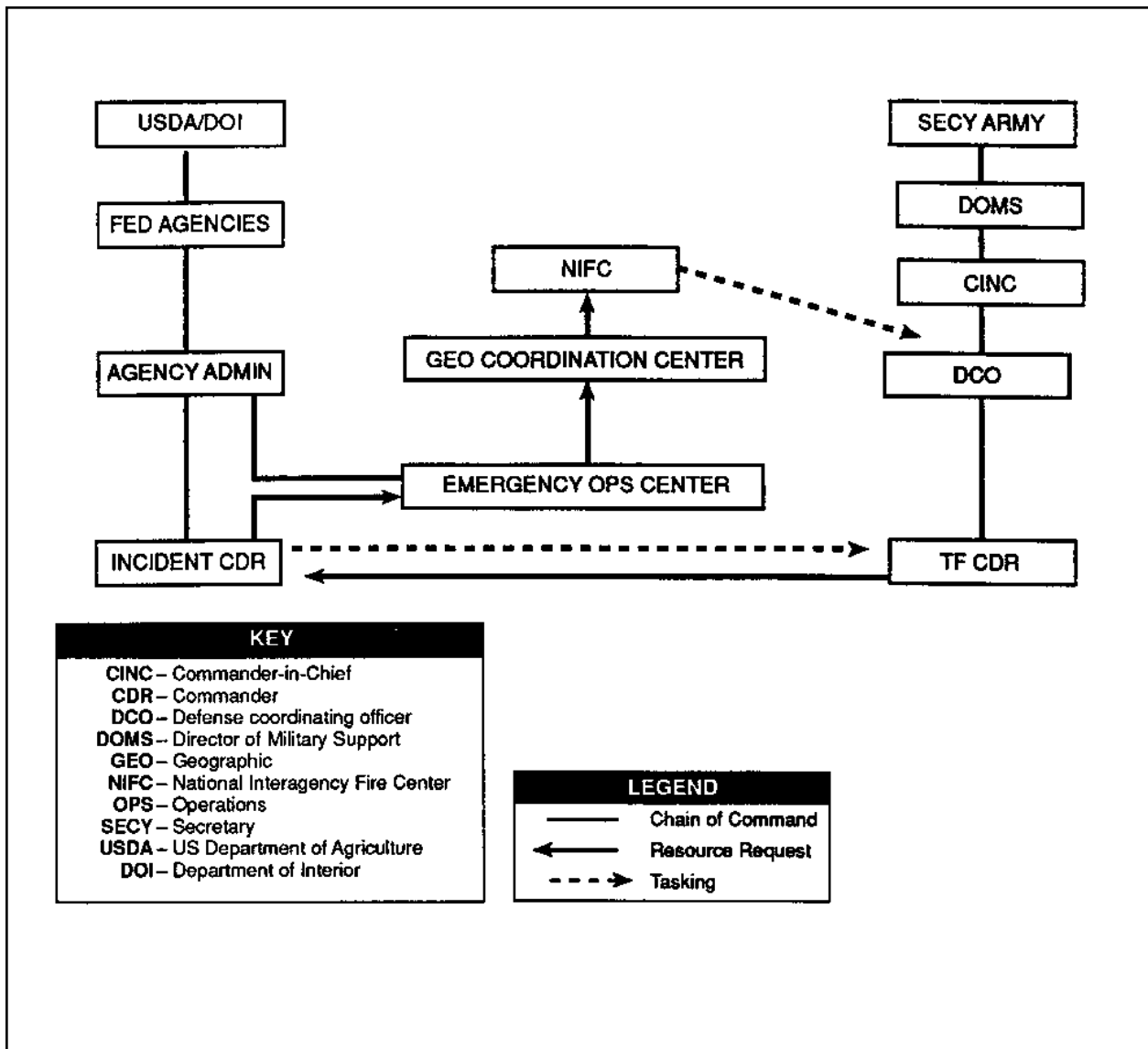


Figure 6-6. Wildland Firefighting and Resourcing Channels

### TECHNICAL SUPPORT ORGANIZATIONS

A network of Army organizations provides a wide variety of technical support to installations. These organizations include the MACOM staffs; the USACE laboratories, districts, and divisions; and field operating agencies (FOAs) such as the US Army Environmental Hygiene Agency and the US Army Engineering and Housing Support Center.

MACOM staffs can execute many environment-related missions. The USACE organizations can provide specific technical services and contracting capabilities on a cost-reimbursable basis. Army FOAs

can provide technical experts in environmental engineering or science.

### INSTALLATIONS AND STATE AREA COMMANDS

At this level, commanders can commit manpower and equipment to assist civil authorities in protecting, restoring, and preserving the environment. Environmental professionals at installations and STARCs focus on daily operations. These staffs are generally small. They concentrate on managing environmental resources and meeting regulatory requirements imposed

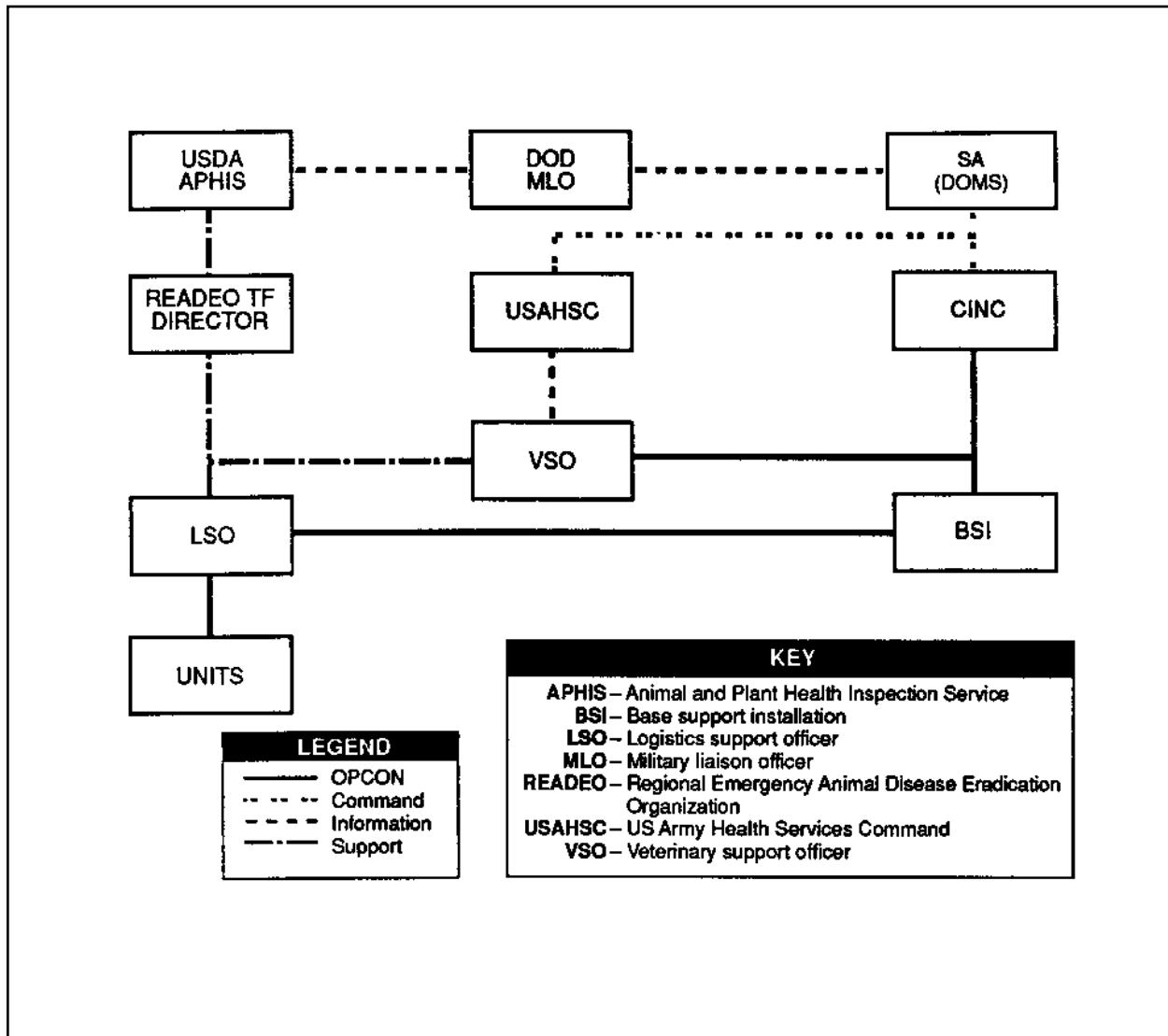


Figure 6-7. Animal Disease Eradication Command Relationships

by federal, state, and local regulations. In addition to addressing daily requirements, they develop contingency plans for potential hazardous material spills or similar incidents or accidents. The various internal Army environmental agencies and their relationships are shown in Figure 6-8.

COMMANDERS

Commanders tailor forces to meet specific environmental support time requirements. Commanders may augment their forces with other related environmental professionals, including attorneys, public affairs specialists, safety specialists, and others who understand

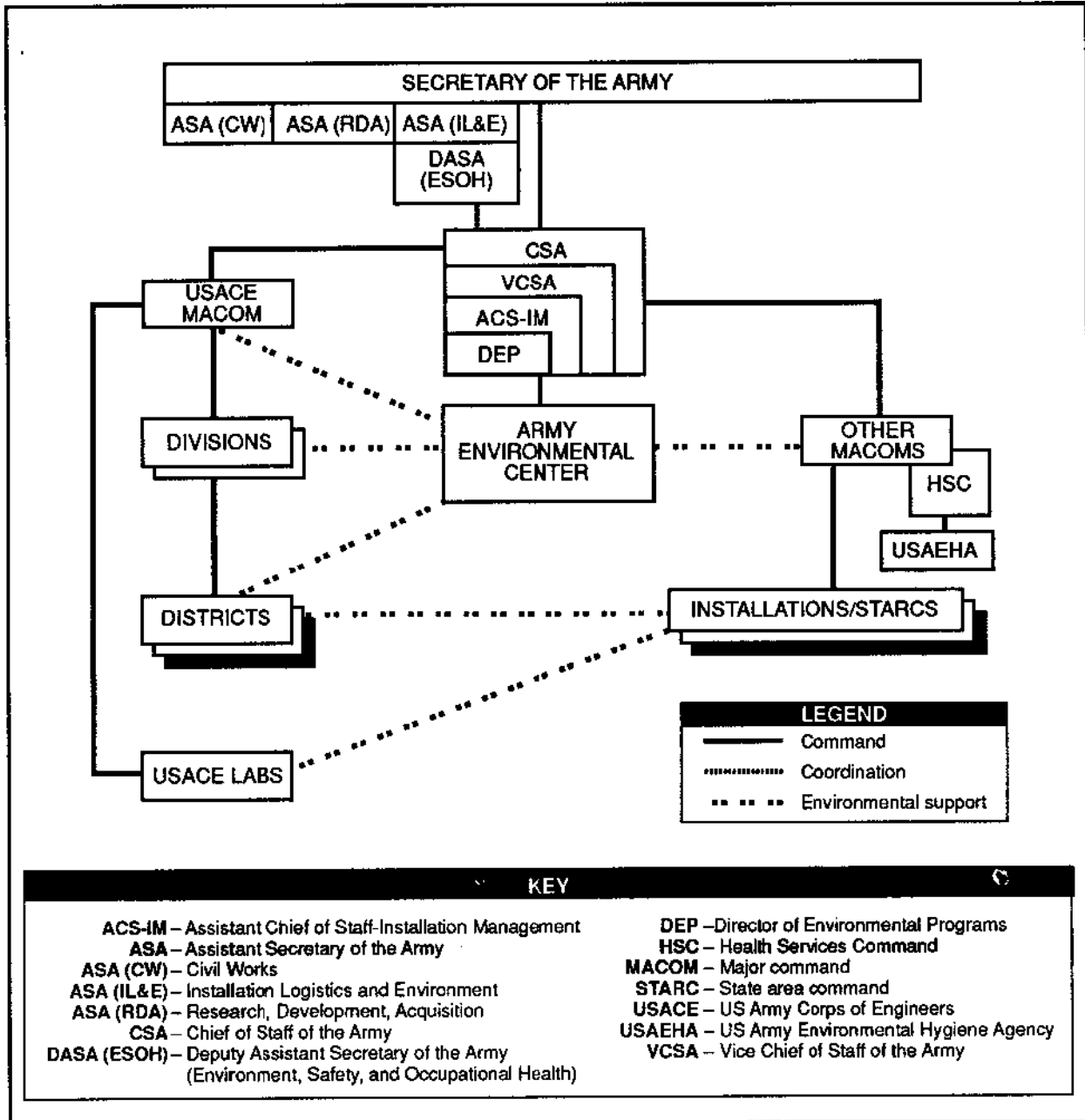


Figure 6-8. Internal Army Environmental Support Relationships

and work daily with environmental issues. Short-, mid- and the long-term missions on the local and regional levels

and the recommended organizations that may provide assistance are shown in Figure 6-9.

AREA	LOCAL			REGIONAL		
	SHORT-TERM	MID-TERM	LONG-TERM	SHORT-TERM	MID-TERM	LONG-TERM
Installation Level	P <sup>1</sup> AOE	E				
STARC Level	P <sup>1</sup> AOE	E				
MACOM Level		PAO				
USACE Districts		PAO	PAO		PAO	PAO
USACE Labs	AO	P		PAO	P	
USAEC	AO	PAO	PAO	PAO	PAO	PAO

LEGEND	
P – Planning	O – Oversight
A – Assistance	E – Execution

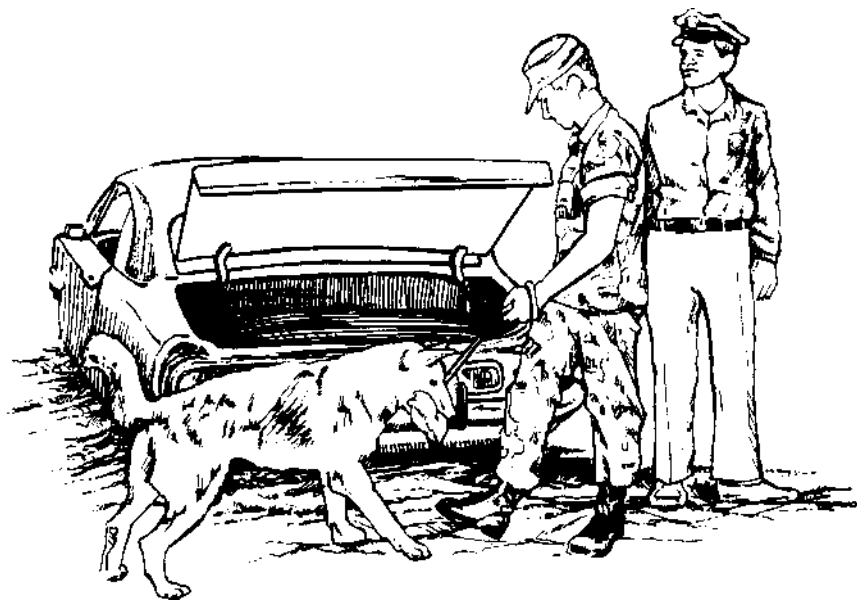
KEY
MACOM – Major command
STARC – State area command
USACE – US Army Corps of Engineers
USAEC – US Army Environmental Center

<sup>1</sup> Augmented by experts from USAEC and USACE laboratories.

Figure 6-9. Recommended Actions for Commanders Providing Environment Assistance to US Civilian Authorities

## SUMMARY

The Army may support or coordinate with many federal, state, and local governmental departments and agencies as it conducts domestic support operations. Although the Army is seldom the lead agency in disaster assistance operations, it is a support agency for all the FRP's emergency support functions. Almost all Army domestic support operations will be conducted in a joint or interagency environment. Throughout our history, the Army has provided community support at the national level and support to its surrounding communities. The Army also has a long history of providing domestic support and will continue to provide that assistance in the future.



## CHAPTER 7

# MISSIONS IN SUPPORT OF LAW ENFORCEMENT

---

*Army forces may conduct missions in direct support of US federal, state, or local law enforcement agencies. Counterdrug, civil disturbance, and terrorism operations are missions that typically require such support. This chapter addresses the tasks necessary to plan for and provide this support.*

---

### COUNTERDRUG OPERATIONS

**Army support to the counterdrug effort requires the sustained commitment of trained and equipped soldiers.**

Directives from the President, Congress, and the DOD have resulted in an expanded role for military forces in attacking illegal drugs in every phase of their flow: at the source, in transit, and in the US.

While this manual focuses on Army domestic counterdrug support and operations, a major portion of the DOD and Army counterdrug effort is conducted OCONUS, particularly in Central America and South

America under the supervision of the CINC US Southern Command (USSOUTHCOM). The Department of State has primary oversight responsibilities for all support provided OCONUS. The CONUS Drug Law Enforcement System is depicted at Figure 7-1.

#### ROLES

Military support to the national counterdrug effort requires sustained deployment of appropriately trained and equipped members of the armed forces. The effort also requires continuing cooperation and coordination among the military and federal, state, and local drug law enforcement agencies (DLEAs).

The DOD counterdrug support organization that receives and validates requests from LEAs and considers the actual resources to support those requests is illustrated at Figure 7-2.

The Army's counterdrug support program includes operational support provided by active and reserve component forces and nonoperational support such as



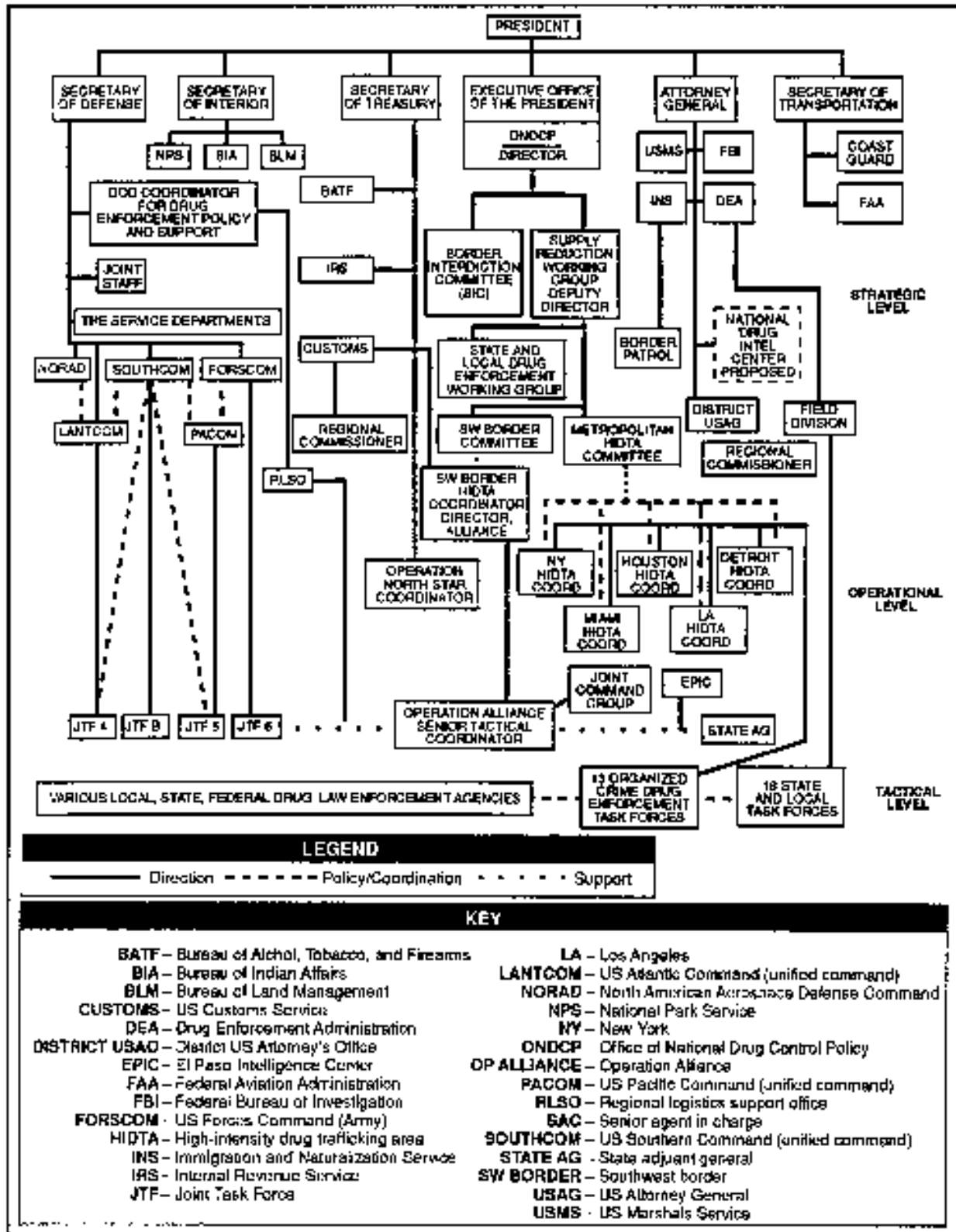


Figure 7-1. CONUS Drug Law Enforcement System

the provision (loan or transfer) of military equipment and facilities and training in formal schools.

The Army also plans and executes programs to reduce demand for illegal drugs. The Army executes its counterdrug missions with the same dedication, skill, and professionalism that it applies to all national security missions. The Army's organization for counterdrug support is illustrated in Figure 7-3.

**CATEGORIES OF SUPPORT**

The Army conducts counterdrug support operations that generally fall within 11 DOD counterdrug mission categories. A critical factor in the program is that the Army provides support, rather than taking a lead role or directly participating in civil law enforcement activities such as performing searches or seizures or making arrests. The DOD counterdrug mission categories are illustrated in Figure 7-4.

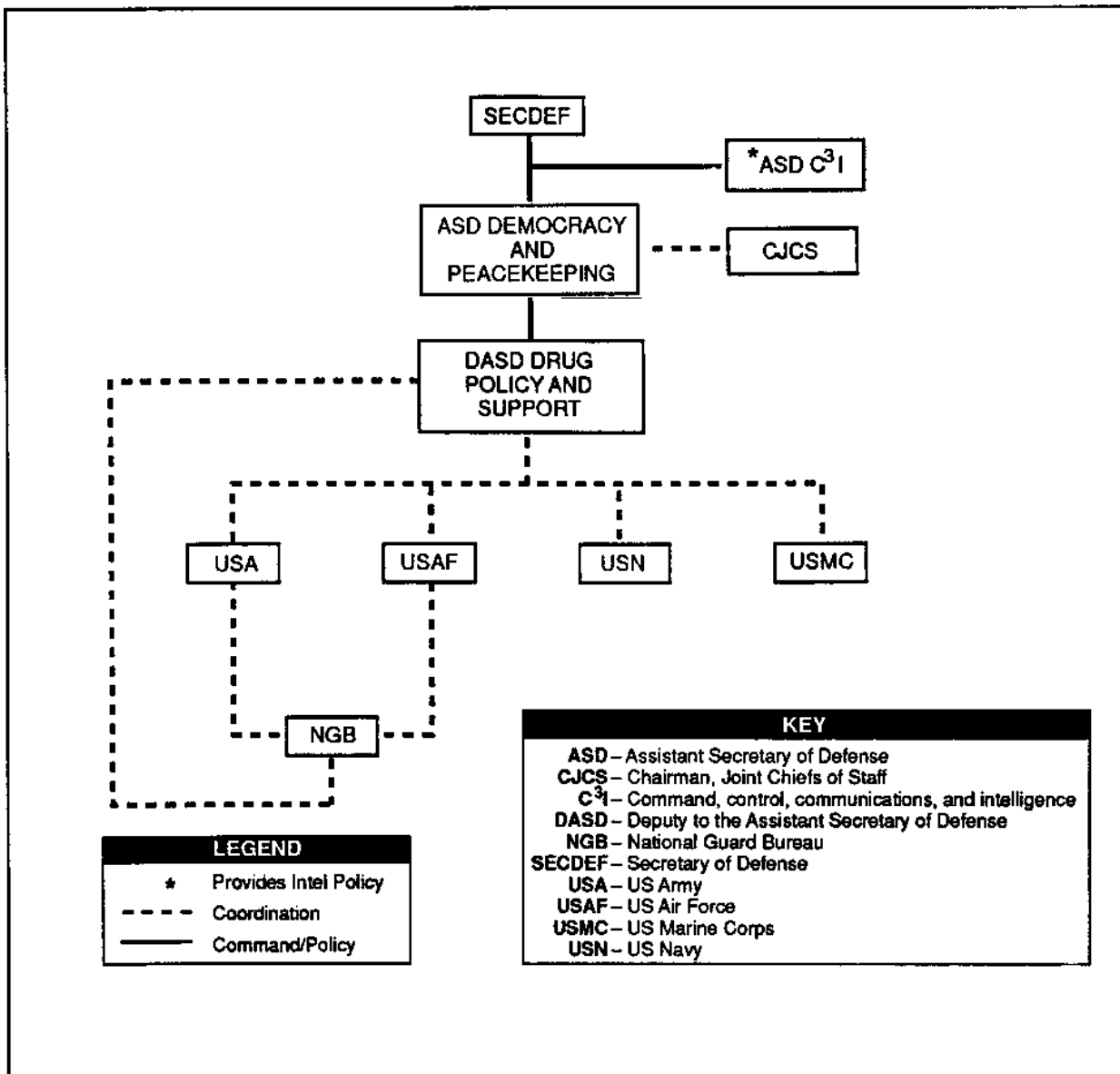


Figure 7-2. Present DOD Counterdrug Support Organization

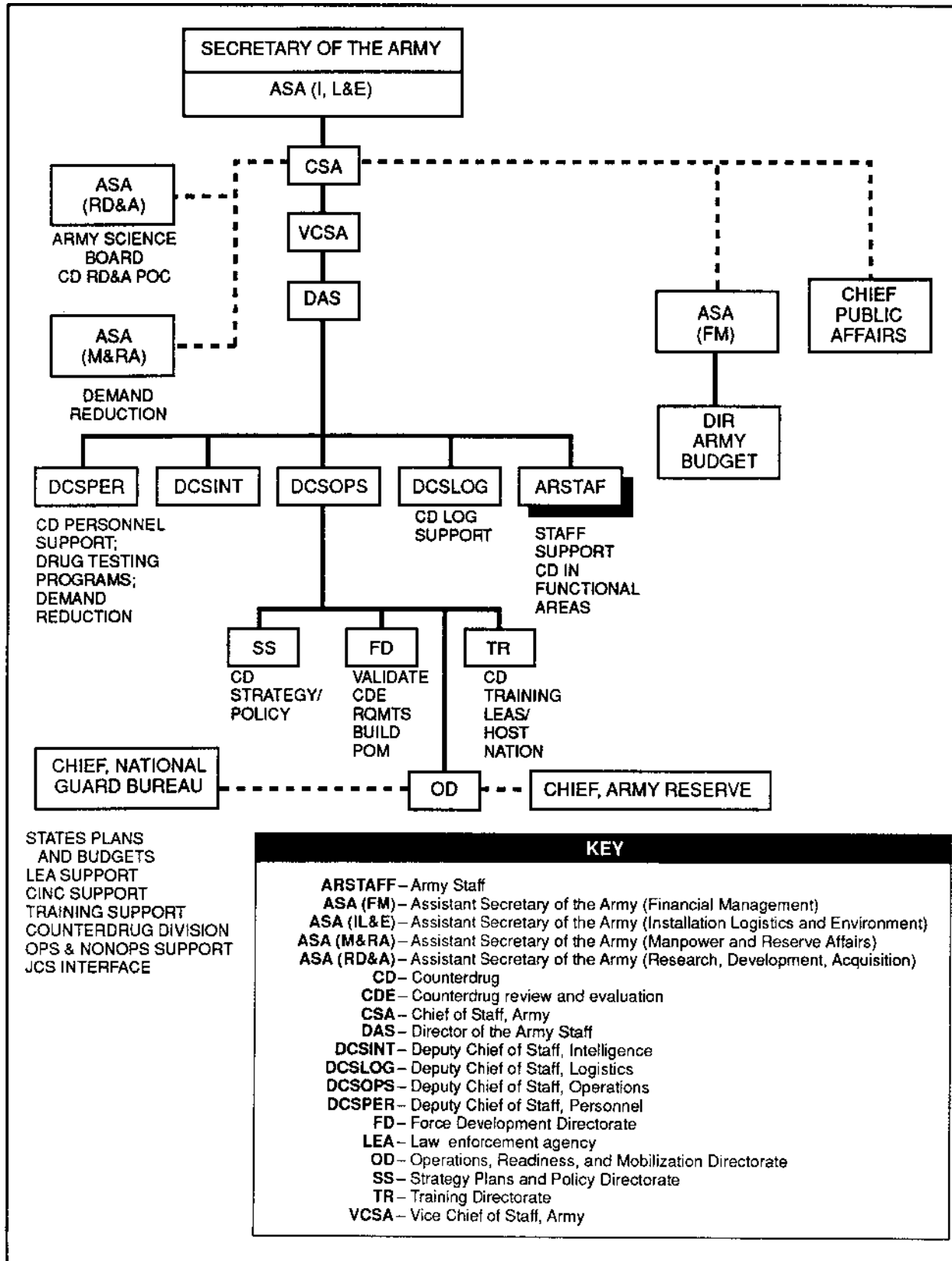


Figure 7-3. Army Organization For Counterdrug Support

## Detection and Monitoring

DOD is the lead agency for the detection and monitoring of the air, sea, and ground transit of illegal drugs bound for the US. The Army supports these missions with ocean-based aerostats, land-based aerostats, land-based radars (such as air defense radars), and OCONUS reconnaissance and surveillance activities. Responsibility for the subsequent interdiction (arrest and seizure) of suspects and contraband remains with LEAs.

*On 20 May 1991, a California National Guard counterdrug task force in Oakland, CA, was assisting the US Customs Service in inspecting warehouse cargo. While examining plastic produce bags from Taiwan, a task force member noticed inconsistencies in packaging and weight. A thorough examination of the complete shipment uncovered high-grade Southeast Asian heroin. The nearly 1100 pounds, the largest seizure in US history, reportedly had a wholesale value of more than \$2 billion.*

## Command, Control, Communication, and Computers

Army personnel and equipment may assist LEAs in designing, implementing, and integrating C4 systems. Army personnel support national and departmental drug operations and LEA analytical centers. In addition, the Army provides liaison to LEAs to facilitate the smooth and successful integration of military support.

## Intelligence

The DA Deputy Chief of Staff for Intelligence (DCSINT), establishes policy for use of Army intelligence personnel or material. The DCSINT receives approval of policy statements and guidelines from the Secretary of the Army General Counsel. Commanders should ensure all use of Army intelligence personnel or material is in accordance with established policy and guidelines coordinated through the DCSINT and

approved by the Secretary of the Army General Counsel.

Army personnel can provide multidiscipline support to joint task force intelligence organizations or to individual drug enforcement agencies. Types of support normally provided are basic and advanced techniques used in the intelligence-preparation-of-the-battlefield process; linguists to translate counterdrug materials; and imagery collection, processing, and analysis. Also, the Army provides and participates in LEA intelligence training to facilitate an understanding of the military capabilities and support relationships.

Commanders must ensure that Army personnel are aware of and comply with legal and policy restrictions. Military personnel performing domestic counterdrug support duties are generally prohibited from collecting information on specific individuals. The supported LEA must retain data processed by intelligence augmenters. Army personnel will not maintain or store gathered counterdrug information files on specific individuals in military facilities or data bases. Additionally, Army intelligence personnel can provide assistance to LEAs by providing operations security (OPSEC) evaluations and training.

**Commanders and analysts must ensure that Army personnel comply with legal and policy restrictions.**

## Planning

Planning support consists of planning and coordinating counterdrug operations, determining resource requirements, and gathering information for operations financial support. Planning support can range from assisting a multiagency task force with developing long-range strategy, to facilitating campaign planning between LEA jurisdictions, to helping to write an operations order (OPORD) for a specific operation or mission.

Early planning is critical prior to missions using military operational support. Many LEAs are unfamiliar with military capabilities and limitations. Therefore, early coordination and liaison are vital to ensure maximum effectiveness of joint military-LEA

efforts. Because military and law enforcement communications systems are often incompatible, extensive communications planning is usually required prior to conducting joint military-civilian operations.

**Logistics**

Logistics support includes loaning equipment; providing engineering, air, and surface transportation; providing maintenance; and providing facilities. Loans and transfers of equipment are arranged through the four DOD regional logistics support offices (RLSOs). Army personnel may be tasked to provide MOS-related maintenance support on LEA equipment. Engineer operations can include construction of roads or structures, repairs, or terrain denial operations.

**Transportation**

Military vehicles and aircraft can be used, with some legal constraints, to transport personnel, cargo, or equipment. If evidence, seized property, or contraband is transported, a law enforcement officer must be present at all times to maintain the chain of custody. Precautions must be taken to ensure that Army aircraft and personnel are not placed in positions where they are likely to be fired upon.

**Training**

Army personnel may be tasked to train LEAs. This will often involve the use of mobile training teams (MTTs). As their title suggests, MTTs provide military trainers to instruct LEAs on-site. Subjects trained may include common soldier skills (especially field craft), planning, analysis, maintenance, languages, and physical security. For example, military police can provide training in counterdrug, civil disturbance, terrorism, and mass immigration operations.

*In fiscal year 1991, DOD trained 1471 military personnel and 253 police personnel, primarily in riverine operations, operational missions planning, intelligence management, communications planning and support, and civic action.*

*DOD continues to be the government leader in drug testing. The department certifies the operations of nine DOD and two civilian drug-testing labs.*

<b>1. Detection and Monitoring (D&amp;M)</b>
<b>2. Command, Control, Communications, and Computers (C<sup>4</sup>)</b>
<b>3. Intelligence</b>
<b>4. Planning</b>
<b>5. Logistics</b>
<b>6. Transportation</b>
<b>7. Training</b>
<b>8. Manpower</b>
<b>9. Research, Development, and Acquisition</b>
<b>10. Demand Reduction</b>
<b>11. Land Reconnaissance</b>

Figure 7-4. DOD Counterdrug Mission Categories

Commanders may support LEAs by providing soldiers to conduct military-specific tasks that would otherwise require civilian law enforcement personnel. Law enforcement officers freed from this requirement can devote their efforts to arresting growers or collecting evidence.

Soldiers may also provide clerical and administrative support. National Guard personnel in state status may be used to assist the US Customs Service with inspections of cargo, vehicles, vessels, aircraft, baggage, and/or mail at ports of entry.

*On 28 October 1991, combat divers from the 3d Battalion, 20th Special Forces Group, conducting ship-bottom inspections in support of the US Customs in Florida, discovered an unusual package behind an intake grate of a 600-foot banana freighter from Turbo, Colombia. The divers ascertained that the package and grate were not booby-trapped and assisted customs agents in its recovery. Customs inspection revealed 75 pounds of cocaine packaged in an exceptionally waterproofed container.*

Army personnel may also provide military skills such as diver, EOD, linguist, dog team, and chemical support. Divers may visually inspect subsurface hulls of vessels but may not enter, search, or alter them. EOD teams can be called on to disarm explosive booby traps placed to protect contraband or equipment. Linguists may be used to translate documents or taped conversations. They may not conduct real-time translations of wire or oral intercepts.

Army forces may provide military dog teams to assist LEAs in detecting illegal drugs and contraband. Chemical liaison teams can advise on the use of

defoliants and identification of drug-producing hazardous chemicals.

### **Research, Development, and Acquisition**

The Army Counterdrug RDA Office provides technical liaison between the Army development community and the counterdrug community. The purpose of the office is to define technical requirements and facilitate technical transfer within the counterdrug community. The efforts of the Army counterdrug RDA office help to provide LEAs access to new and emerging technologies and equipment. This office may also assist LEAs with contracting and procurement.

### **Demand Reduction**

Prevention or reduction of drug abuse requires a combination of education, deterrence, and treatment or rehabilitation. Drug abuse awareness education includes programs for all the DOD schools and DOD civilian personnel. Also, to the maximum extent possible, the DOD provides drug education assistance programs to local community organizations. Drug deterrence for DOD personnel is provided through scheduled and random urinalysis testing. The DOD treatment and rehabilitation program is designed to diagnose, treat, and return to full productivity as many people as possible.

### **Land Reconnaissance**

While reconnaissance is an essential aspect of the DOD detection and monitoring mission, land reconnaissance refers specifically to support provided to US LEAs inside the US. This distinction is made due to legal and policy restrictions concerning the use of the military within our borders.

Army forces may execute a variety of aerial-based and land-based counterdrug reconnaissance missions. These can include the use of fixed wing aircraft, rotary wing aircraft, and unmanned aerial vehicles. Groundbased reconnaissance operations can be accomplished through establishing listening posts and observation posts, on foot or mounted patrols, operation of ground surveillance or air defense radars, and the emplacement and monitoring of remote sensors. Thermal images and other night vision devices may be used to conduct these missions.

*US Army, Pacific and Hawaii Army National Guard soldiers combined to provide support to Hawaii and federal DLEAs during Operation Wipeout in the early 1990s. Working together, these forces succeeded in eliminating more than 90 percent of Hawaii's visible marijuana crop, valued at more than \$6 billion.*

**REQUESTS FOR SUPPORT**

Law enforcement agencies may request support through either the state National Guard counterdrug coordinator, the appropriate CONUSA, the FORSCOM counterdrug support cell, the National Guard Bureau counterdrug task force, or the DOD coordinator for drug enforcement policy and support. The preferred method for requesting support is through the state NG counterdrug coordinator. If the NG is unable to provide support, the request will be passed to the appropriate CONUSA. Requests for CONUS military counterdrug operational support are illustrated in Figure 7-5.

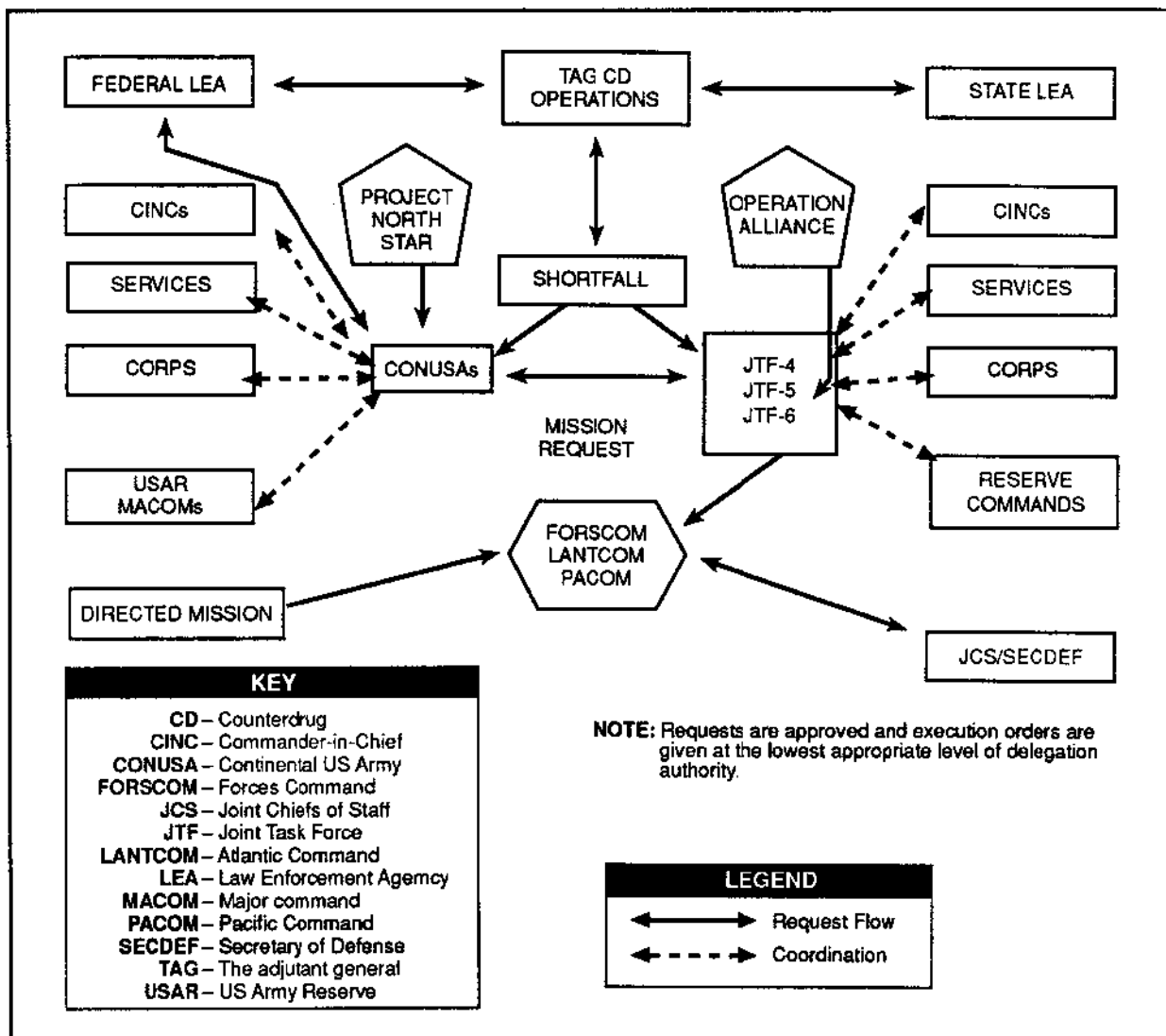


Figure 7-5. Requests for Military Domestic Counterdrug Operational Support

## PROVISION OF SUPPORT

Within the United States, the National Guard is the primary source of military support to federal, state, and local LEAs. Support is also provided to LEAs by both USAR and active duty units. This Army support to counterdrug operations is another aspect of the Army's traditional role of providing military support to civil authorities. Army National Guard forces execute these missions under control of the governor, while USAR and active duty units operate under the control of a regional joint task force, for example, JTF 6 in the US southwest, or in support of a CONUSA.

Each state or territory has a National Guard counterdrug coordinator to receive LEA requests for support and coordinate the execution of support as directed by the state adjutant general (or commanding general). Army National Guard counterdrug operations are conducted in accordance with state law and applicable National Guard regulations. Drug interdiction and eradication operations are conducted in all 54 states and territories. In fiscal year 1992, the National Guard helped confiscate drugs with a street value of \$69 billion.

The National Guard has categorized its support into 16 missions (approved by SECDEF) that are essentially subdivisions of the eleven DOD categories. These missions are depicted in Figure 7-6. Coordination Requirements

The Joint Staff reviews all DOD operational support requests and the Secretary of Defense or delegatee approves them. The CINCFOR coordinates counterdrug land operations in CONUS. Figure 7-7 illustrates the counterdrug operational support approval process. Nonoperational Support Requests

In accordance with current DOD policy and service regulations, the appropriate regional logistics support office will process LEA requests for equipment, facilities, and formal school training. The Director of Operations, Readiness, and Mobilization, in coordination with the Assistant Secretary of the Army for Installations, Logistics, and Environment, administers such actions for the Department of the Army.

## CONSIDERATIONS FOR PLANNING

### STAND-ALONE CAPABILITY

Whenever possible, Army support will be packaged to provide a complete stand-alone capability. Units

tasked with providing counterdrug support should perform a mission analysis to ensure the requested forces or capabilities are sufficient to meet requirements.

### DECISION-MAKING PROCESS

Planning for a counterdrug support mission entails the same decision-making process as any other military operation. The conduct of counterdrug operations should be consistent with Army doctrine. Unlike combat operations where the massing of firepower is appropriate, however, the guiding principle for Army personnel during counterdrug operations is to avoid contact and use minimum necessary force.

Leaders at the lowest echelons will perform troop-leading procedures and analysis based on the factors of METT-T. Leaders at higher echelons will perform command and staff estimates. To the greatest extent possible, estimates should be coordinated with the supported LEA.

### LEGAL AND TACTICAL ASPECTS

In developing a threat estimate, the military counterdrug planner may have to rely heavily upon law enforcement sources for information. IPB should be performed before each mission but must be modified to account for less predictable drug traffickers, rather than for a doctrinally rigid threat. Also, planners must consider legal as well as tactical aspects when developing courses of action.

**Legal constraints are a major concern in planning counterdrug missions.**

### LEGAL CONSTRAINTS

Legal constraints constitute a major concern during counterdrug mission planning. Use of military support may require special procedures to ensure that legal proceedings resulting from joint military-LEA counterdrug operations can be effectively prosecuted in court. Counterdrug plans should be reviewed by a staff judge advocate. The supported LEA is responsible for obtaining any required warrants or determining instances in which warrants are not required.



**RULES OF ENGAGEMENT**

Rules of engagement (ROE) and use-of-force policies will usually be detailed and restricted by US law. Soldiers conducting counterdrug support missions must be familiar with and completely understand the ROE. Commanders routinely provide a precommitment briefing outlining the mission, legal considerations, and ROE to soldiers engaging in counterdrug operations.

**OPERATIONS SECURITY**

OPSEC during counterdrug support operations cannot be overemphasized. The mere appearance of military personnel or strangers in an area can cause drug traffickers to alter or delay their activities.

Planners must identify security vulnerabilities and implement measures to protect weaknesses. Commanders must take steps to preserve counterdrug force intentions and capabilities.

**COMMAND AND CONTROL**

Command and control relationships must be clearly established. The relationship between a military unit providing counterdrug support and the supported LEA is similar to a unit providing direct support (DS) and a supported unit. However, the military chain of command must always be maintained. US soldiers will not be placed under the command of law enforcement officers.

<b>1. Surface Reconnaissance</b>
<b>2. Surface Transportation Support</b>
<b>3. Aerial Surveillance</b>
<b>4. Ground Radar Support</b>
<b>5. Training Programs</b>
<b>6. Engineer Support</b>
<b>7. Coordination, Liaison, and Management</b>
<b>8. Marijuana Greenhouse/Drug Lab Detection</b>
<b>9. Film Processing for Photo Reconnaissance</b>
<b>10. Administration, Information, Logistics, and Maintenance Support</b>
<b>11. Surface Surveillance</b>
<b>12. Aerial Reconnaissance</b>
<b>13. Aerial Transportation Support</b>
<b>14. Cargo Inspection</b>
<b>15. Aerial Photo Reconnaissance</b>
<b>16. Aerial Interdiction</b>

Figure 7-6. National Guard Counterdrug Support Categories

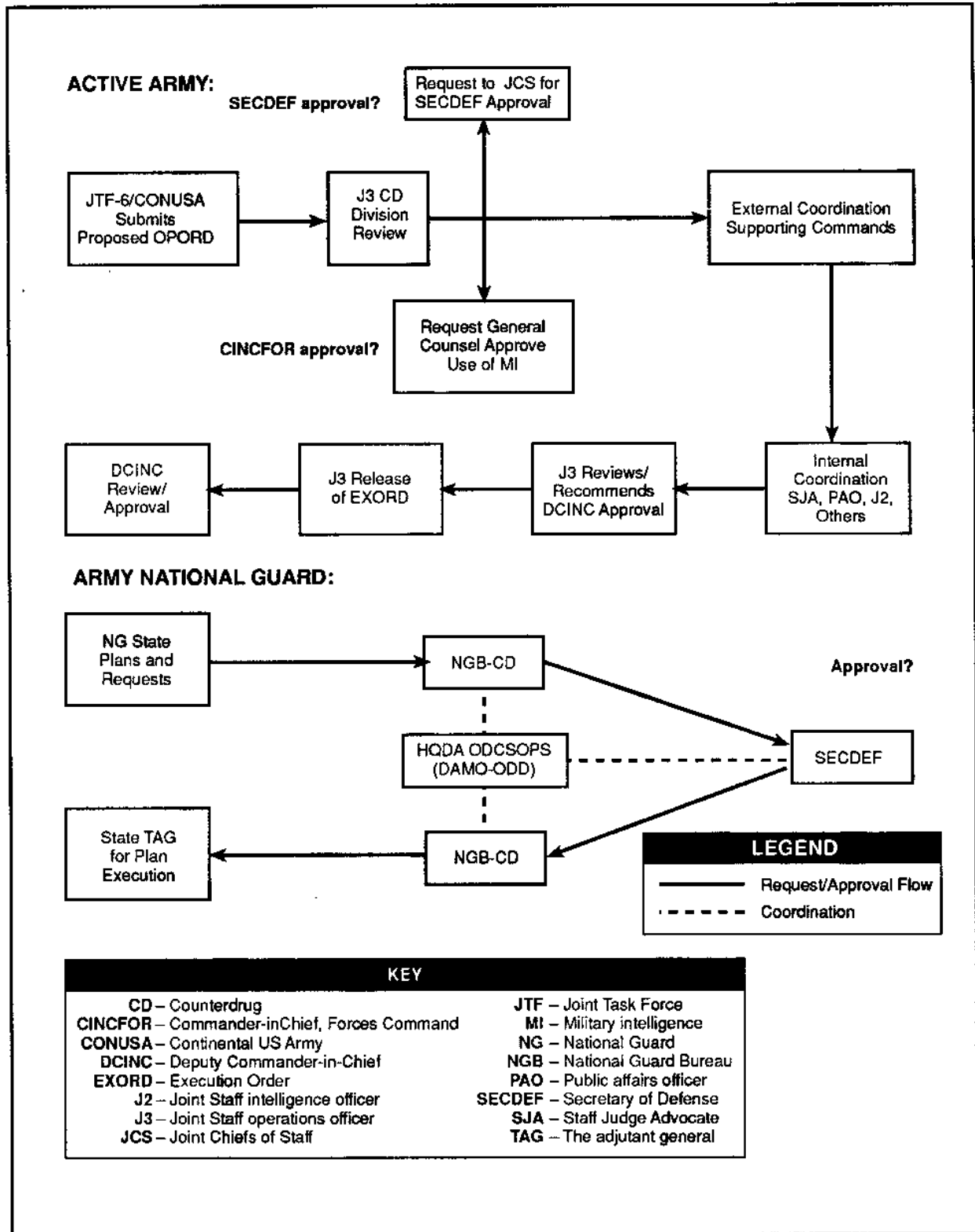


Figure 7-7. Counterdrug Operational Support Approval Process

*On 15 December 1992, members of the Oregon National Guard (ORNG) Counterdrug Support Program assisted the DEA, BATF, US marshals, and two IRS criminal investigation divisions in executing a search warrant in Hermiston, Oregon. With the support of the ORNG, the agencies seized a number of fully automatic weapons, 42 other weapons, and more than 3000 rounds of ammunition, including .50-caliber armor-piercing rounds.*

*LEA arrested four individuals and seized illegal drugs, \$115,000 cash, a 48-foot yacht, eight vehicles, military explosives, grenades, and booby traps.*

*From 1 to 19 June 1991, the New York National Guard counterdrug program was responsible for seizing \$24,589,110 in illegal drugs and \$3,192,106 worth of cash and travelers checks.*

## COMMUNICATIONS

Communications plans must be detailed. Since military and civilian systems are often incompatible, military and supported LEA communications planners must coordinate as early as possible.

## PUBLIC AFFAIRS

The lead for public affairs rests with the supported LEA. Army public affairs officers will coordinate any release of information with the supported LEA. Commanders should ensure their public affairs officers are included in the planning process for all counterdrug operations. Unwanted disclosure of operations by the media can render a plan ineffective. It can also negate the favorable results of an operation such as arrests and seizures.

A good public affairs plan can minimize these risks by providing the media with only the information the

operational commander wishes to release. A good public affairs plan will serve the public's right to know while minimizing risk through effective security at the source and OPSEC awareness. The identity of soldiers providing counterdrug support will not be released to the media.

## THREAT AWARENESS AND RISK ASSESSMENT

Commanders should perform a risk assessment prior to the deployment of troops. Threat awareness and risk assessments are a critical part of counterdrug planning. While soldiers should not be placed in situations where they will likely be fired upon or come into direct contact with suspected drug traffickers, such a possibility always exists. Units and soldiers may face an armed adversary. They should be prepared for actions related to combat, even when conducting training or other noncombat operations. Commanders should also be aware of the chemical hazards associated with drug production.

## SUPPORT FOR CIVIL DISTURBANCE OPERATIONS

Civil disturbances may range from unruly demonstrations to widespread rioting with looting and arson. In extreme cases, civil disturbances may include criminal acts of terrorism and violence. Civil disturbances in any form are prejudicial to public law and order. The Army has a role in assisting civil authorities to restore law and order when local and state law enforcement agencies are unable to quell civil disturbances.

## ROLES

The National Guard, as a state organization, responds to the governor in accordance with state law for civil disturbance operations. National Guard regulations direct planning and training for the civil disturbance mission. During most civil disturbance situations, the National Guard will be the first military responder and will usually remain in state active duty status throughout the operation. The National Guard can be brought on federal service for civil disturbance operations when so ordered under appropriate federal statute by the President. This will normally be done at the request of the state governor.

*The LA riots of 1992 were unquestionably the most costly civil disturbance in US history (\$800 million plus). At 2230 on 29 April 1992, as part of the response to this disorder, the 3d Battalion, 160th Infantry (Mechanized), 40th Infantry Division, California National Guard, was ordered to mobilize. Between 2100 and 2400 the following day, all 3d Battalion companies deployed to their assigned areas. It was the first tactical battalion to be mobilized, the first to deploy to the streets of LA, and the last to redeploy.*

The role of federal Army forces is to assist civil authorities in restoring law and order when the magnitude of the disturbance exceeds the capabilities of local and state law enforcement agencies, including the National Guard. Under the provisions of the Constitution and selected federal statutes, the President may order the employment of the federal armed forces to aid local and state civil authorities to protect the Constitutional rights of citizens. Federal military forces may also protect federal facilities and installations in any state, territory, or possession. The Department of the Army civil disturbance plan, nicknamed GARDEN PLOT, provides direction for Army forces directed to quell civil disturbances.

### **REQUESTS FOR FEDERAL MILITARY ASSISTANCE**

Requests for federal military assistance normally originate with the state and are forwarded to the President of the United States. The Attorney General is responsible for coordinating and managing all requests for federal military assistance for civil disturbance operations. The Attorney General advises the President whether and when to commit federal military forces. The President orders the employment of federal military forces in domestic civil disturbance operations.

The Attorney General, as the head of the lead federal agency responsible for law enforcement, will appoint a senior civilian representative of the Attorney General (SCRAG). The SCRAG is responsible for

coordinating federal civil disturbance operations and assisting the state civil authorities.

The SCRAG has the authority to assign missions to federal military forces. The SCRAG exercises this authority in coordination with the commander of the federal military forces committed to civil disturbance operations. Civilian officials remain in charge of civil disturbance operations.

The Secretary of the Army is the DOD executive agent for federal military operations in response to civil disturbances. Within the Department of the Army, the Director of Military Support coordinates the functions of all the military services when federal military assistance for civil disturbances is required. The executive agent, through DOMS, serving as a joint staff, publishes an execute order designating a supported CINC for civil disturbance operations. This execute order also designates the supporting CINCs, services, and agencies (see Figure 7-8).

The CINC will determine the organization and forces required to accomplish the civil disturbance mission. The CINC may establish a joint task force in order to make best use of the forces available for the mission.

### **CONDUCT OF CIVIL DISTURBANCE OPERATIONS**

The JTF commander exercises control of all federal military forces (including National Guard in federal status) committed to assist civil authorities. Federal military forces remain under the military chain of command during civil disturbance operations. Federal forces will not be placed under the command of either civil officials or National Guard commanders in nonfederal status. Civilian authorities retain control of their state and local law enforcement agencies. The JTF commander establishes liaison with the SCRAG and other appropriate federal, state, and local civil authorities.

Federal military forces must be tailored to the specific civil disturbance situation. Sufficient combat support and combat service support units will be required to sustain the force throughout the deployment. Coordination with civil officials may allow the force to draw on resources available from state and local agencies. Close and continuous coordination between the federal military forces and the LEAs will

provide the commander the detailed information required to employ and protect the force effectively.

In supporting OPLAN GARDEN PLOT, intelligence personnel may conduct close and continuous liaison with LEAs and the military police to ensure that their units receive the information needed to allow the commander to adequately protect the force. The JTF commander should staff intelligence support missions with his senior intelligence officer and legal counsel prior to approving the mission.

**Federal military forces remain under the military chain of command during civil disturbance operations.**

Federal military forces must be employed in tasks or missions appropriate to their organization and training; they must not be employed in ways that violate the legal restrictions in effect. Military forces may be used to disperse unlawful assemblies and to patrol disturbed areas to prevent unlawful acts. They may be used to assist in the distribution of essential goods and the maintenance of essential services. Forces may also establish traffic control points, cordon off areas, release smoke and obscurants, and serve as security or quick-reaction forces. Certain types of missions are always inappropriate for military forces during civil disturbance operations, for example, gathering intelligence on civilians.

Requests for the conduct of specific military missions are typically passed through a single state or federal law enforcement coordinating officer, as approved by the SCRAG. Validated requests are transmitted to the JTF commander and his headquarters

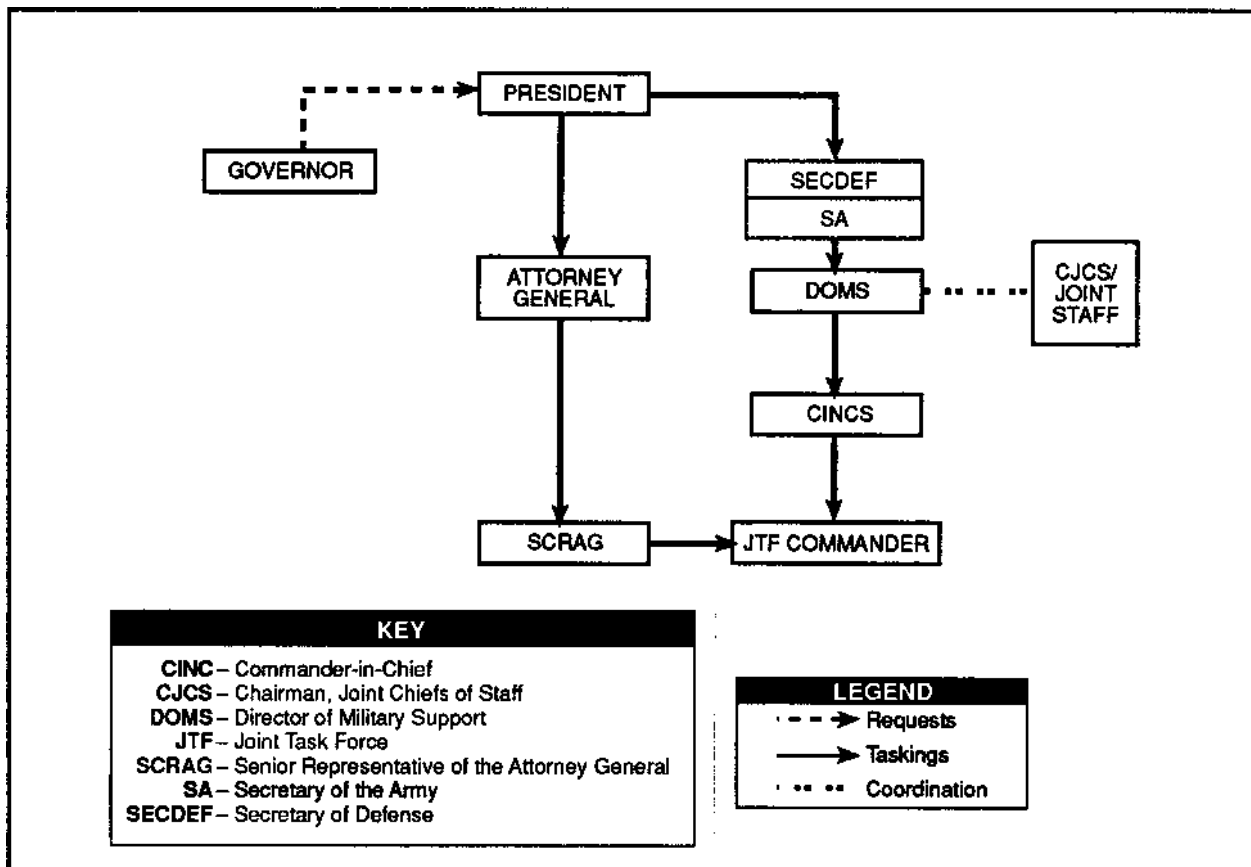


Figure 7-8. Decision Sequence for Law Enforcement Support

for staffing and coordination. Approved missions are assigned through the military chain of command to the appropriate element or unit for execution. Units and soldiers will not accept taskings or missions directly from law enforcement or civilian officials, except in a direct support relationship as approved and ordered through the military chain of command.

Military liaison should be provided to each LEA headquarters generating requests for support. This liaison can assist LEA officials in determining the types and quantities of military support to be requested. The JTF headquarters can facilitate this mission assignment process by providing LEAs with a detailed listing of the types of missions military forces may conduct.

A deployed unit's area of operation should coincide with the jurisdiction or subdivision boundaries of the law enforcement agency it supports. This arrangement facilitates liaison and coordination between law enforcement and military chains of command.

## **SUPPORT FOR COMBATTING TERRORISM**

### **ANTITERRORISM ASSISTANCE**

Antiterrorism is the term encompassing defensive measures, to include limited response and containment of a terrorist incident involving DOD personnel and facilities. Since the FBI has the lead role in most matters concerning terrorism in the US, the Army's function in AT is essentially to reduce the vulnerability of Army personnel and property to terrorist attack.

Selected Army and civilian personnel may attend established AT training courses. Additionally, Army organizations may develop memorandums of understanding with civilian agencies for mutual support in the event of a terrorist incident. Such agreements may include arrangements for firefighting or EOD support, providing assistance in site isolation, security engineering and assisting in hostage negotiation.

### **COUNTERTERRORISM ASSISTANCE**

Counterterrorism includes means taken to prevent, deter, and respond to terrorism. Assistance provided in counterterrorism is essentially a subset of civil disturbance operations. The Federal Bureau of Investigation is the lead law enforcement agency concerning incidents of terrorism in the US. The Secretary of the

Army remains the executive agent for the employment of military support.

### **TYPES OF SUPPORT**

Support provided by Army forces may include material, facilities, and personnel acting in an advisory capacity. Presidential authorization is required before military personnel can perform law enforcement functions outside the military installation. At the request of the director of the FBI or the senior FBI official at the scene of a terrorist incident, the Secretary of the Army and OCONUS CINCs may provide the FBI military resources (barrier materials, smoke and obscurants, body armor, protective masks, clothing, communications equipment, firefighting equipment and operating personnel, and explosive detection dog teams for the purpose of combating terrorism). The Secretary of the Army has delegated this authority down to installation commanders. The approval of the Secretary of the Army or his designated representative is required to authorize the provision of arms, ammunition, combat tactical vehicles, vessels aircraft, and personnel (other than firefighting and EOD personnel).

### **Explosive Ordnance Disposal**

The EOD mission is to assist public safety and law enforcement agencies in developing a capability to deal with the improvised explosive device (IED) threat and, when necessary, to provide EOD service in the interest of public safety. Army EOD personnel will not participate in bomb or IED search operations (except to support the US Secret Service) or assist in the enforcement of civil law. Army EOD personnel will respond to requests when a suspected or actual device has been located and when the responsible agency has no EOD capability or its capability is overextended.

**Army EOD personnel may  
support the US Secret  
Service or assist local law  
enforcement.**

EOD personnel do not normally respond to incidents involving commercial explosives or chemicals but may be authorized to provide technical assistance to preserve life or to prevent severe property

assistance to preserve life or to prevent severe property damage. Army EOD units may not transport, store, or dispose of commercial explosives or chemicals for agencies other than the DOD.

EOD personnel train military personnel, Defense Civil Preparedness Agency personnel, and civil authorities in—

- Explosive ordnance reconnaissance.
- Responding to bombings and sabotage.
- Combatting bombings and sabotage.
- Identification and dangers of ordnance.

**Department of  
Defense Key Asset Protection Program (KAPP)**

CINCFOR is designated the DOD executive agent for the DOD Key Asset Protection Program. CINCFOR develops and promotes the security of key assets within the US by providing to the owners or managers of such assets appropriate advice, guidance,

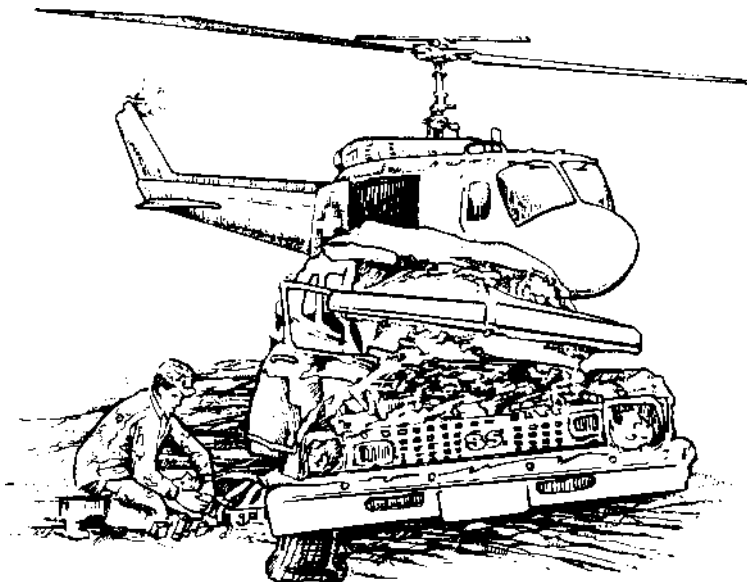
and planning assistance on the application of physical security and emergency preparedness measures. Such assistance is designed to protect key assets from sabotage, espionage, and other hostile or destructive acts and to minimize the effect of attack damage.

USACE provides security engineering advice for government installations. Examples of facilities selected for this program include, but are not limited to, munitions plants, production facilities producing critical national defense items, communication nodes, and power plants.

The DOD will not replace the primary responsibility of others for the physical security of any privately owned assets; federally owned assets under the control of any other federal department, agency, or contractor; or assets owned by any state or political subdivision of any state. The DOD will ensure that actions to protect key assets are included in military contingency plans for CONUS security.

## SUMMARY

The US Army can perform many tasks in support of civil law enforcement. Efforts to combat the flow and use of illegal drugs in the US have shown that the Army can provide effective assistance to LEAs. Army personnel and equipment can also help civilian law enforcement authorities quell civil disturbances and terrorist activities. By providing both operational and nonoperational support to law enforcement, the the Army can be a formidable force multiplier for civil authorities.



## CHAPTER 8

# COMMUNITY ASSISTANCE

---

*Community assistance applies the skills, capabilities, and resources of the Army to the needs and interests of America and local communities. Supporting and participating in events and activities that benefit the Army and the civilian community build on a long tradition of America's Army helping American communities. Community assistance can have a large scale impact because active component, National Guard, and Army Reserve units are located in thousands of towns and cities across the nation. What a command does, or fails to do, for the community will affect the attitudes of the American people, upon whom the Army depends for its support and existence. Every commander should identify opportunities to conduct initiatives that meet specific needs, have specific start points and end states, enhance readiness, and advance the interests of the nation, the Army, and local communities.*

---

### PRINCIPLES

**America's Army has a long tradition of helping American communities.**

Community assistance projects and operations must enhance the Army's image, have a positive impact on

the unit or individual soldier, and contribute to the common good of the nation and local communities. Army commanders must be sure that their initiatives are not competitive with local resources or services, do not benefit any particular interest group, and will not result in monetary or service remuneration in any form. Army commanders located OCONUS may find these principles useful in fostering their established relationships with adjoining host nation commanders. However, they must consider applicable CINC guidelines and host nation laws and agreements before implementing community assistance programs.



### COMMAND EMPHASIS

Commanders should take an active interest in their relationships with civilian officials, encouraging appropriate community assistance programs. Establishing long-term, harmonious, productive relationships with national, state, and community officials can significantly benefit both the Army and the nation's civilian communities.

### INDIVIDUAL AND UNIT ENHANCEMENT

Community assistance activities increase public awareness and understanding of the Army, inspire patriotism, and enhance the Army's reputation as a good neighbor. They positively influence public opinion toward the Army while also enhancing the combat readiness of the organization. They help build unit morale and esprit de corps. Community assistance activities are an excellent opportunity for soldiers to serve as role models, which not only enhances recruiting but motivates other soldiers. These activities promote their self-esteem and further their sense of service to the nation.

### READINESS ENHANCEMENT

Community assistance activities should enhance individual and unit combat readiness. They should make the best use of assets and foster a positive training environment where soldiers can become involved in realistic, hands-on training opportunities. Whenever possible, community assistance projects should exercise individual soldier skills, encourage teamwork, challenge leader planning and coordination skills, and result in measurable, positive accomplishments. Finally, they should enable a unit to use its equipment, providing training opportunities that increase operator proficiency.

### COMMUNITY BENEFIT

Community assistance activities should contribute to the health and welfare of the nation and local communities, making the Army an integral partner in progress and development. These activities enhance the ability of the nation and communities to provide the best possible services to the citizenry. They promote a positive, healthy, safe environment, as well as an understanding of the basic principles, values, and ideals upon which America is built. This results in increased awareness of America's history and the Army's role in a continuously changing world.

*During the summer of 1992, units from the 89th US Army Reserve Command helped a nonprofit, community action organization in Kansas City, Kansas, lift, transport, and relocate 81 houses from Fort Leavenworth to the Kansas City area to provide housing for elderly, handicapped, and lower income families.*

### COMMON INTEREST AND BENEFIT

Because the Army belongs to the American people, it should support only events and activities of common interest and benefit. Commanders should avoid providing assistance and support to one sponsor that it cannot also provide to other sponsors. Army assistance should not selectively benefit any person, group, or corporation, whether profit or nonprofit, religious or sectarian, ideological or quasireligious, fraternal, political, or commercial.

### NONCOMPETITIVE

Army community assistance projects should not compete with resources and services commercially available in the community. Commanders must not authorize assistance activities when local businesses can provide the same or similar assistance and support.

**Assistance projects  
must be noncompetitive  
and nonprofit.**

### NONPROFIT

Army support for or participation in community assistance activities cannot be provided on a for-monetary-profit basis. Commanders must ensure that no Army person or unit realizes a monetary profit, a gratuity, or a remuneration in any form not provided for by public law or regulation.

## TYPES OF COMMUNITY ASSISTANCE

Community assistance activities can be national efforts focused on developing public support for the Army and its contribution to the nation. They can also be state or local community efforts focused on improving the community, its infrastructure, and its ability to serve the local population. Both types improve the lives of American citizens, foster the values and purposes of democracy, and give the American people hope and confidence in a changing world.

### NATIONAL EFFORTS

The goal of national efforts is to develop an open, cooperative relationship between the Army and the American people. National efforts take advantage of the technical, vocational, and group skills of military professionals to enhance the lives of American people. They supplement programs available in the civilian sector and through other government agencies, not replace them. They provide opportunities for the Army to contribute to the growth and welfare of the nation, improving its perception of the Army, its capabilities, and its personnel. Army and DOD regulations provide detailed guidance on national effort programs. Examples of national efforts are described in the following paragraphs.

#### Public Works Maintenance and Management

The Army exercises its federal engineering executive oversight responsibilities through the US Army Corps of Engineers. The USACE manages myriad components of the nation's public works infrastructure. Executed principally, but not solely, through the civil works directorate, this unique Army national assistance program has developed an integrated understanding of complex federal, state, and local regulations and policies governing the national infrastructure, the national waterways, environmental remediation and recovery operations, real estate, disaster recovery operations, and general project management functions. The Army's efforts help maintain and improve the nation's infrastructure. Many federal, state, and local agencies engage the USACE on a reimbursable basis when they lack the expertise to manage the engineering dynamics of a particular project.

#### Assistance Programs

Army involvement in a wide variety of national assistance programs focuses on economic and social issues having national security implications. Large segments of our society face an unfulfilling lifetime of marginal existence, creating the potential for disorder in our nation. Army participation in programs designed to provide the nation's citizens opportunities to fulfill their potential is effective use of our resources and capabilities. Examples of national assistance programs in place or under consideration are described below.

**Civilian Community Corps.** This program provides managerial, organizational, and technical skills for disadvantaged Americans seeking the skills they need to succeed. Through this program, the Army helps participants become productive citizens. In exchange, participants perform a wide range of community service activities that improve the foundation of American society. This program encourages intragovernmental cooperation on the federal level. It also encourages partnerships with industry, education, state, federal, and local governments.

**Science and Technology Academies Reinforcing Basic Aviation and Space Exploration (STARBASE) Program.** This program is an innovative partnership of professional educators, military personnel, and corporate sponsors. It promotes science, mathematics, and technology basics for primary through secondary schools. Using NG resources to spark student interest, the program develops strong self-esteem, provides excellent role models, promotes positive attitudes, and develops goal-setting skills.

**Civilian Youth Opportunities Program (Challenge).** This is a youth program directed at attaining a high school diploma, providing job training and placement, improving personal and social skills, and providing health and hygiene education and physical training. Soldiers work with civilian leaders to provide a comprehensive support package, ranging from choosing appropriate clothing to attending residential training facilities.

**Drug Demand Reduction Programs.** These are activities in which soldiers work with community agencies and organizations to reach at-risk individuals. Program activities include presentations on drug

awareness and prevention, sponsorship of drug-free activities and events, leadership camps, fitness programs, and cultural exchange programs. One of the specific programs in this general category is the Drug Abuse Resistance Education (DARE) Program. Military police provide instructor support to law enforcement agencies teaching elementary students how to stay drug-free. This support is provided either on or off military installations based on the requests of local law enforcement agencies.

**Youth Physical Fitness Clinic Program.** The National Guard encourages fitness and combines academic and athletic achievement by helping schools conduct competitions in selected athletic events. This program also establishes a separate scholar-athlete category for those students with a 3.5 or higher grade point average.

*Crews from the 57th Medical Command (Air Ambulance), 1st Corps Support Command, Fort Bragg, provide emergency rescue support to the local community. In March 1993, they responded to a call to assist two 19-year-old canoeists who had been forced to climb a tree after losing their boat in the rampaging waters of the Eno River near Durham, North Carolina, which was swollen as a result of three inches of rain.*

**Medical Readiness Program.** The Medical Readiness Program is an activity in which Army medical unit personnel, together with state medical emergency officials, plan and provide support in the form of diagnosis, treatment, and preventive medical, dental, and veterinary care to citizens in remote areas of the US or its territories. The program is designed to enhance the unit's medical readiness, provide unit training opportunities, and serve the public in locations where medical care is not otherwise available. The

program may not compete with local private medical care that may be available.

**Air Ambulance Participation.** The Military Assistance to Safety and Traffic (MAST) Program is a proven example of Army support to civil authorities. This program permits the utilization of Army aviation assets to conduct emergency air evacuation and recovery efforts.

#### National Events

When directed, the Army provides support to national events and activities that promote the image of the country. Examples of such missions include support to national and international supporting events such as the Olympics and the Super Bowl, or political events such as the Presidential inauguration and other national celebrations and commemorations.

*Fort Eustis started a pilot program in 1992 called Operation Self-Enhancement to give high-risk middle school students the opportunity to visit the post and focus on careers, teamwork, and self-esteem. The program was so successful that it has become an annual event. Students receive light military training through an array of "testable" tasks and obstacles presented by members of a cadre team. This training helps students build their self-esteem and self confidence and affords them the opportunity to interact with positive role models.*

#### STATE AND LOCAL EFFORTS

The guiding principle behind state and local efforts is that the installation and the community have a common interest in providing the best possible support for each other. A cooperative relationship exists, because soldiers stationed at the installation receive life support from the community while many of the civilians who make up the community receive life

support from the installation. The interdependence of the military installation and the civilian community can involve economics, education, health care, basic services, quality-of-life issues, and many others.

The goal of local commanders should be to develop an open, mutually satisfactory, cooperative relationship between the installation and the community. Good state and local efforts improve the community's perception of the Army, the installation and the soldiers, family members, and civilians who are part of the installation.

Commanders should consider appointing a committee or small agency to act as a clearing house for community assistance requests. This committee might be headed by the garrison commander or Director of Plans, Training, and Mobilization (DPTM). It should include the public affairs officer, the staff judge advocate, the chaplain, and representatives from the Directorate of Resource Management (DRM), the Directorate of Installation Support (DIS), and the Directorate of Personnel and Community Activities (DPCA). Units that play a major role in the activity should be represented. Key community leaders should also be invited to serve on this committee. A diagram depicting a typical flow of community assistance requests through command channels and the assistance committee is at Figure 8-1.

Many community activities and efforts can be established in a more formalized manner. These efforts permit both the installation and local community to expand and enhance their services to their respective residence. Examples of these efforts are explained in the following paragraphs.

### **Memoranda Of Agreement (MOA) or Memoranda Of Understanding**

An installation or organization can enter into an agreement with the local community to provide critical services not available in the community, to augment community services unable to meet demand, or to ensure that emergency services are available in the shortest possible time. Examples include arrangements to provide air ambulance support, search and rescue, firefighting capability, explosive ordnance disposal, emergency or broad-based medical care, wildlife and domestic animal management, assistance in safety and traffic control, emergency snow removal, and temporary supplemental housing for the displaced or disadvantaged.

### **Speakers Bureaus**

Speakers are an especially effective means of developing understanding of the Army and stimulating patriotic spirit. They inform the public about the activities of the installation, its units, and its soldiers. Commanders should establish an installation speakers bureau and encourage soldiers of all ranks to participate in the program.

### **Community Liaison**

Maintaining liaison through informal community relations councils can enhance open communications with community officials and organizations. Councils have a variety of responsibilities, such as developing and promoting new ways for members of the command to participate actively in local community activities and resolving potential and actual areas of conflict. Community liaison can also recognize, with public service awards, private citizens, local community leaders, citizen groups, and organizations for their support of the Army. Commands can further community liaison through membership in civic, business, and professional organizations when the goals and objectives of those organizations are beneficial to the Army and their programs and projects are consistent with Army interests.

### **Band, Color Guard, and other Ceremonial Unit Participation**

Participating in public events and memorials is an excellent way to accomplish community relations objectives. These representatives of the Army serve as ambassadors to the civilian community and promote patriotism, interest in the Army, and awareness of our forces' professionalism.

*Elements of the 489th Engineer Battalion, 420th Engineer Brigade (USAR), helped a rural community near Little Rock, Arkansas, plan, develop, and build a local recreational area for the general public.*

**Exhibits**

Exhibits and displays of Army equipment, historical materials, models, devices, and other information can enhance understanding of the Army and the installation. They can also promote patriotism and educate the public. They provide an excellent opportunity for interaction between our soldiers and members of the local community, communicating the professionalism, readiness, and standards of our forces.

**Physical Improvements**

Community service physical improvements focus on ensuring that the physical infrastructure is as safe as possible and provides the fullest possible range of support to the population. These activities encompass a wide range of programs that do not compete with the services provided by contractors and businesses in the local civilian community. Examples include—

- Construction projects that enhance the recreational, educational, environmental, or cultural facilities of the community, such as building community picnic areas and hiking and biking trails.

- Demolition projects that enhance the safety and appearance of the community, such as the removal of unstable playground equipment.
- Projects that create or enhance a safe, clean environment, such as the removal of debris from a community wildlife area or painting a community recreation center.

**SOCIAL IMPROVEMENTS**

Community service social improvements, which focus on making the social environment as healthy as possible, provide the widest range of support to the population. They encompass myriad projects, including—

- Support to youth programs, such as scouting, and programs that provide assistance to special need audiences, such as special olympics.
- Involvement in ventures and projects that enhance the educational or cultural climate of the community, such as adult literacy, school reading, or community theater programs.

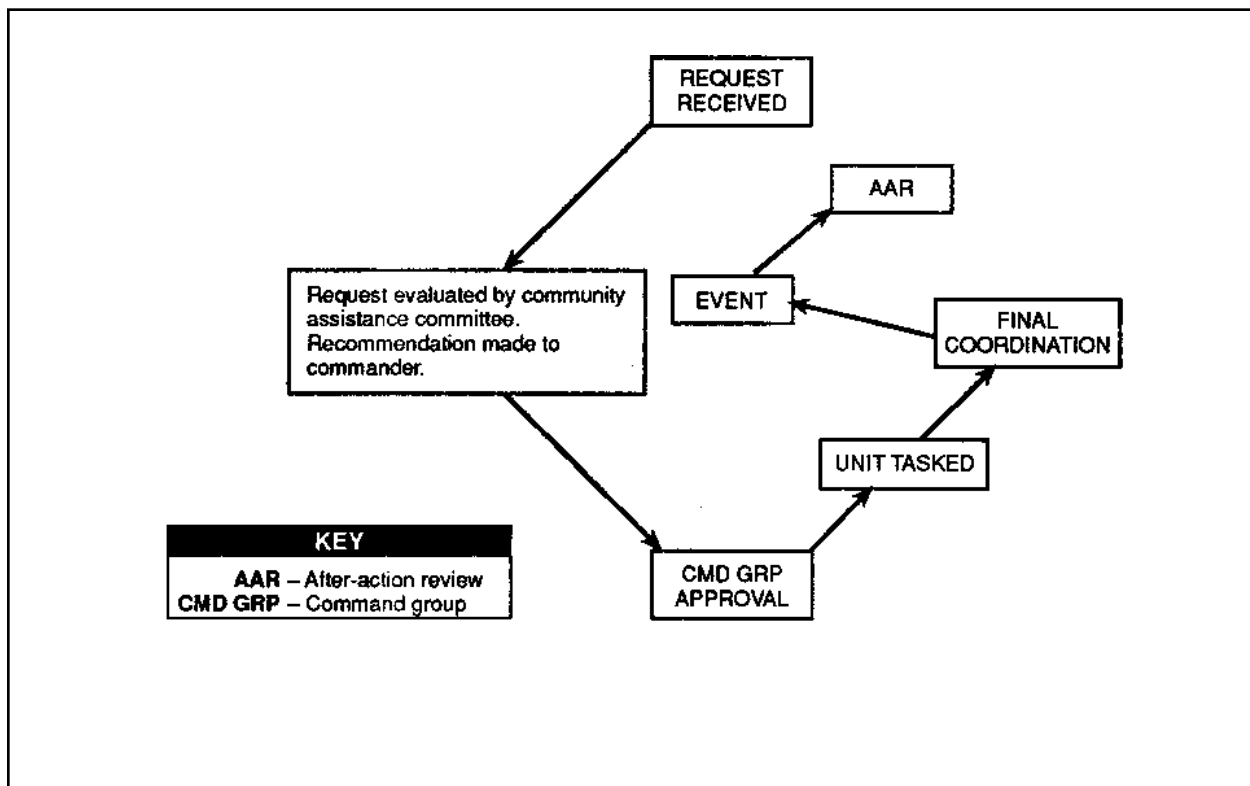


Figure 8-1. Community Assistance Request Flow

- Participation in special events, such as law enforcement or fire prevention awareness programs, which enhance the welfare of the community.

*The Fort Sill Public Affairs Office has worked with the local community college to establish an intern program for students in the communications and journalism programs. The students receive credit for work they do in the installation PAO office, providing the college with a valuable education asset and the students with an opportunity to get real-world experience in their academic fields.*

Commanders should consider the contributions that all organizations and personnel associated with their installation can make in community assistance activities. For example, Army Reserve Officers Training Corps (ROTC) cadets may be a valuable resource for participating in or supervising selected community assistance projects. ROTC cadets, particularly those in the final two years of training, can gain valuable leadership experience by participating in community activities. Communities will benefit from the dedication of intelligent, reliable, and energetic future Army leaders in their community efforts.

Another example of Army personnel that can contribute to community assistance activities is Army recruiters who are dispersed throughout the United States. These noncommissioned officers serve as positive role models and leaders who may be called on to assist in DOD-approved community activities as recruiting duties permit. Specific programs executed by Army recruiters include—

- The National Stay-in-School/Stay-Off-Drugs Program. Recruiters, supported by visual and print materials, serve as role models for youth at

risk of dropping out of school or using drugs. Recruiters assist school counselors and community leaders in fighting local drug problems through education and positive encouragement.

- The USAR Scholar-Athlete Program. With more than 13,000 high schools participating, the program honors the top male and female scholar and athlete selected by each school based on guidelines suggested by the Army.
- Planning for Life. This Army initiative, developed in concert with the Committee for Economic Development, recognizes excellent career planning at state and national levels. The Planning for Life award will be presented to the coalition of schools, business, labor, and communities that do an excellent job of preparing students for the work world.

### **PUBLIC AFFAIRS CONSIDERATIONS**

Almost all community assistance activities are conducted in public view. For this reason, PA officers are a valuable resource for commanders involved in community assistance activities. They can provide advice and assistance in determining the propriety, suitability, and appropriate level of support to be provided. They are experienced in working with civilian leaders and organizations and in planning and conducting programs involving the civilian community. They should be part of the commander's community assistance committee.

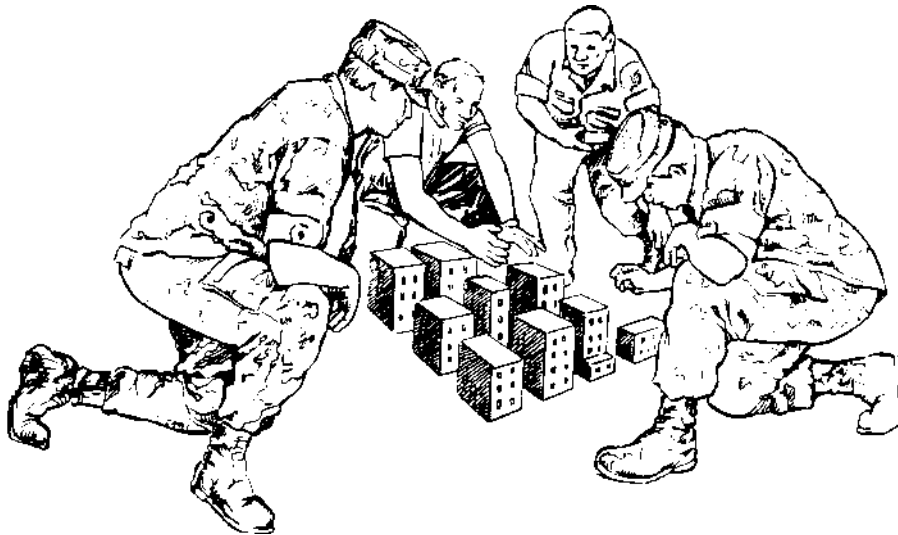
### **LEGAL IMPLICATIONS**

Army participation in community service activities is limited by law, regulation, and policy. Commanders must consider the objective and purpose of the proposed community assistance. They must consider the limitations under which Army participation in community assistance activities is authorized. They should ensure the SJA is an important element in the consideration and development of any community assistance programs.

## **SUMMARY**

Participation in community assistance activities is an effective method for projecting a positive Army image, making the best use of assets, providing alternative training opportunities, and enhancing the relationship between the Army and the American public. Activities vary widely, ranging from individual soldier involvement to full Army participation. They are characterized by detailed coordination between the military command and community authorities. They fulfill community needs that would not otherwise be met, enhance soldier and unit morale, skills, and readiness, and improve the mutual support between the military and civilian communities.

---



## CHAPTER 9

# EDUCATION AND TRAINING

---

*Training for war is the Army's top priority. With the exception of the training required in OPLAN GARDEN PLOT, the Army does not normally do specific training for domestic support missions until after a mission is assigned. Most domestic support missions can be accomplished by a disciplined force, proficient in its warfighting tasks, as described in its mission-essential task list (METL). However, in some cases unique training may be required to successfully complete an assigned domestic support mission. This chapter provides a guide to leaders on training for essentially non-METL-supported missions.*

---

### CONCEPT

**The basis of the Army's capability to provide domestic support is wartime mission training.**

Commanders should be familiar with the requirements and limitations peculiar to domestic support operations. They must ensure that leaders

and staffs are trained in the organization and processes of supporting civilian agencies. Units should be selected to perform specific domestic support missions consistent with known levels of training and military skills. The Army could be tasked to provide domestic support under a variety of missions and circumstances. The Army will seldom be tasked to provide such support independent of other services or civil agencies. All personnel require mission orientation and introduction to civil assistance techniques specific to the mission. Figure 9-1 provides insight into the factors that affect training for assigned domestic support missions.

Training required for domestic support is conducted within the tenets of current Army training doctrine.



Many tasks common to warfighting and domestic support exist at all levels. Senior commanders should make every effort to use domestic support missions as skill enhancers for subordinate units. They accomplish this by assigning domestic support missions to units whose combat skills and capabilities match the mission's requirements. Also, execution of domestic missions should mirror, as closely as possible, the execution of the same or similar tasks in combat. Such assignments will often favor selecting combat support and combat service support units. As an example, medical units may find little difference in the type of medical support required after a natural disaster from that required following a battlefield engagement. Commanders can exploit the relationship between METL and domestic missions to save time and training resources while maintaining combat readiness.

A unit's METL is the focus of the commander's training plan. While using unit METLs to focus training toward combat readiness, a number of factors, as seen in Figure 9-2, impact on readiness.

Commanders able to emphasize the positive aspects of these impacts when training for an assigned domestic support mission are able to improve readiness while supporting domestic needs. In many cases, specialized mission-oriented training will have to be accomplished prior to committing forces. The lead federal, state, or municipal agency may provide training information and requirements to Army forces. Training may be provided through cadre instructional programs or to entire units. The FEMA operates an Emergency Management Institute in Emmitsburg, Maryland. Courses that are of interest to Army planners include Integrated Emergency Management, Multi-hazard Planning, and Hazardous Material Spill

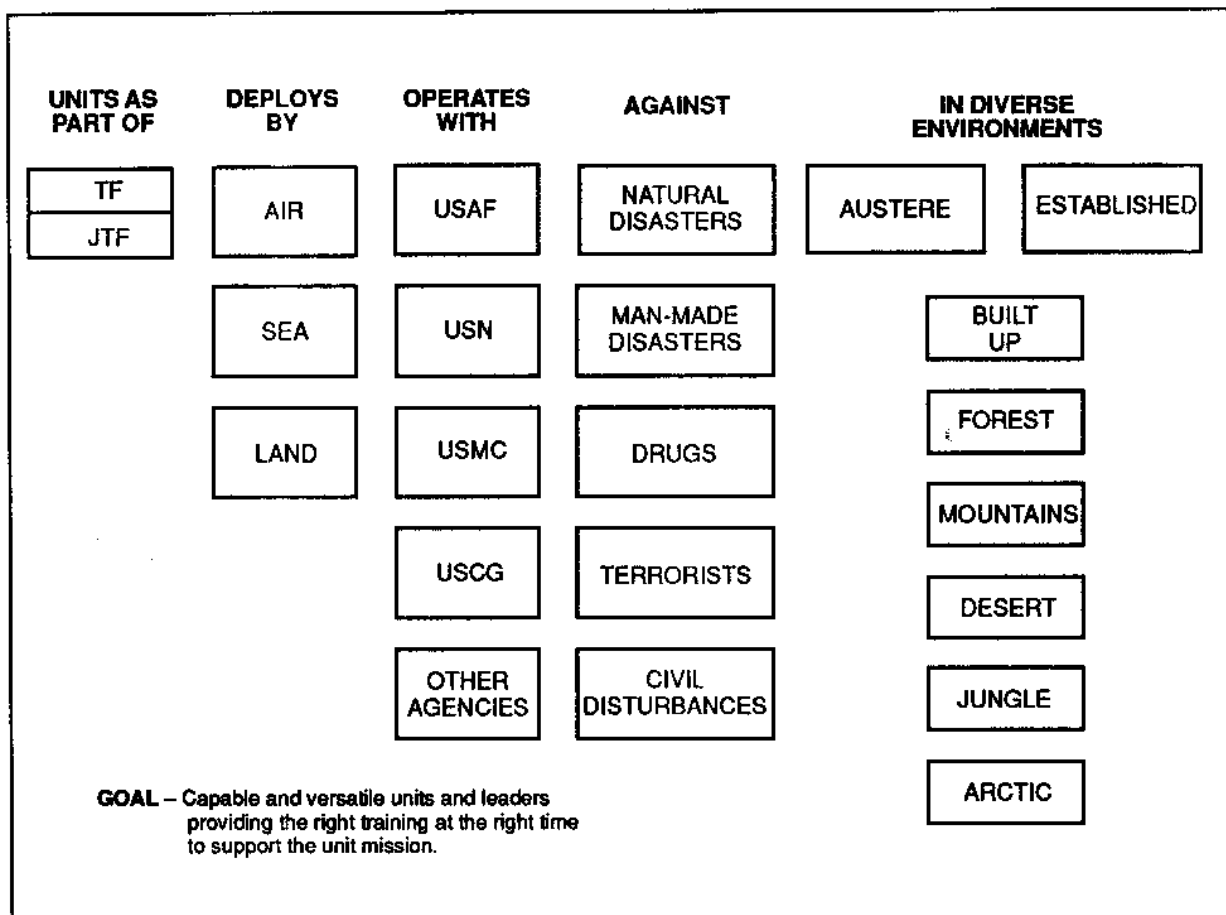


Figure 9-1. Dealing with a Variety of Missions In Domestic Support Operations

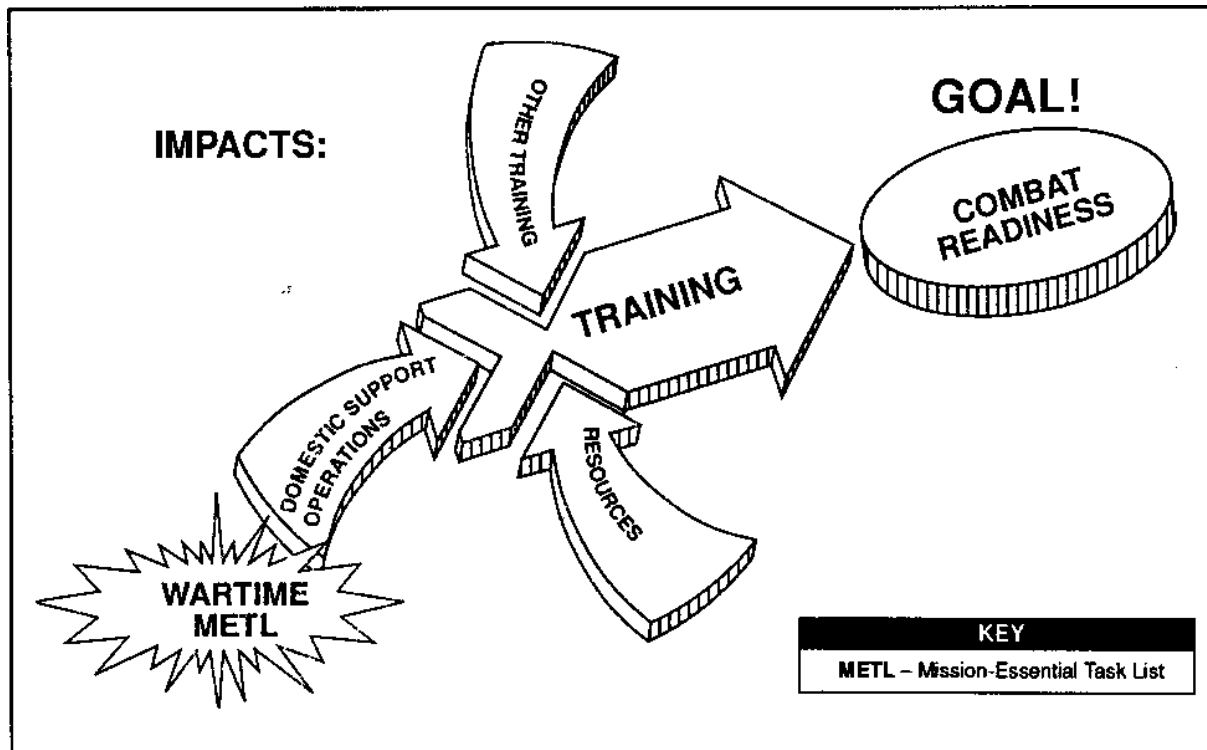
Response. The National Guard operates the National Interagency Counterdrug Institute in San Louis Obispo, California. It offers training to federal, state, and local agencies in counterdrug operations and techniques. An example of training provided to entire units is the three-day course in firefighting skills that the US Forest Service provides to units tasked to assist their efforts each summer. Interagency government training may be available in a variety of areas, such as counterdrug operations.

**TRAINING TECHNOLOGIES**

Unit training is integrated into existing individual and collective events. Many conventional training exercises provide the opportunity to include interaction with federal, state, or municipal agencies. Exercises such as HURRICANE POLLY and RESPONSE 93

were developed and conducted to improve the coordination needed to respond to hurricanes and earthquakes. These exercises were developed by non-DOD agencies, but they can provide an opportunity to improve military capabilities for domestic support with minimal resources. These exercises emphasize interoperability requirements and stress staff coordination. A number of exercises are supported by Army organizations, such as the Louisiana Maneuvers Task Force.

The recent development of distributed simulation provides training technology that permits multiple organizations or agencies to participate in the same simulation exercise without having to be at the same location. It offers the potential for selected leaders to develop effective interagency communication and mutual understanding without having to be physically present at a specific exercise site.



**Figure 9-2. Impacts on Training Readiness**

*The tiny Eskimo village on Diamede Island had not received any supplies for more than four months. Personnel from the 558th QM Company (Aerial Resupply), operating from the Alaskan General Depot, devised hasty rigging procedures. They rigged 25,000 pounds of food and fuel and air-dropped it to villagers in February 1956.*

---

## READINESS

Combat readiness is the primary focus of all military forces. Execution of domestic support missions should have minimal impact on unit readiness or mission essential task list proficiency, but it may adversely impact readiness of units given extended domestic support operations. Units committed to long-term domestic support may require significant resources, beyond that which the unit would normally be allocated, to regain warfighting standards after completion of their domestic support mission.

## RISK MANAGEMENT

Commanders realize that protecting soldiers and equipment is an implied aspect of any mission. Normal METL training will satisfy most protection requirements. Domestic support missions, however, could require the employment of personnel and equipment in roles other than those for which they were trained or designed. Consequently, leaders at all levels must make risk assessments. Commanders must ask four questions prior to and during any operation:

- Do my soldiers need specialized training for the mission?
- Will my soldiers be required to use their equipment in a manner other than that for which it was designed?
- Are my soldiers and their equipment operating under the conditions they had during training?

- Do my soldiers or their equipment endanger the civilians we are supporting?

Commanders and staffs must do everything possible to protect the force, regardless of the mission. In many cases it may be challenging to do so during some domestic support missions.

*Elements of the 391st Engineer Battalion, 120th US Army Reserve Command, assisted in the construction of a new training area for the County Sheriff's Department in Greenville, South Carolina.*

---

## PUBLIC AFFAIRS

Personnel in units conducting domestic support operations must become familiar with public affairs principles and procedures. Their activity will be of great interest to the news media. Commanders may capitalize on this interest by assisting the media in telling the Army story.

Commanders must be trained to accomplish their mission under the close scrutiny of the media. They will have to satisfy the media appetite for information. They will have to react rapidly to developing issues and changing perceptions while simultaneously fulfilling the information needs of their soldiers.

Public affairs training should be of a dual nature. PA staff elements must train themselves to identify the information expectations and requirements of internal and external audiences, evaluate the potential impact of information, develop information communication strategies, assess the effectiveness of information communication, and serve as the interface between the military and the media. They must also train commanders, staff, and soldiers to deal with the media. This includes providing information on First Amendment rights of the media to have access to and report news, soldier rights concerning media interviews, and OPSEC considerations.

**Assistance to local communities by Army units can provide training opportunities to soldiers of supporting units.**

**ENVIRONMENTAL ASSISTANCE**

Environmental awareness instruction has been developed for inclusion in all leadership courses. The intent is to counter environmental apathy and integrate environmental awareness into operations and training. Training focuses on the four pillars of the Army Environmental Awareness Program, which are compliance, restoration, prevention, and conservation. This training will sensitize leaders to environmental considerations during domestic support operations. It will further enhance the image of the Army’s stewardship of the environment.

Training soldiers and civilians to provide environmental assistance to domestic authorities generally requires no special efforts except the training needed to perform their Army jobs.

**DISASTER ASSISTANCE OPERATIONS**

The Corps of Engineers has DOD-designated responsibilities for disaster assistance operations. It routinely conducts disaster response and recovery missions. Engineers, both military and Army civilian, must be educated and trained to accomplish unique responsibilities directed by the Federal Response Plan. All committed engineer units must be prepared to perform general engineering tasks necessary to establish temporary life-support facilities or to restore basic municipal services.

Commanders may encounter a variety of radiological and chemical hazardous materials (HAZMAT) during the conduct of domestic support operations.

Trained Chemical Corps HAZMAT specialists are available to advise commanders on the identification, avoidance, containment, and neutralization of these substances. Training can be provided by Chemical Corps personnel to emergency response personnel at the federal, state, or local level in several NBC areas. These areas include monitoring, surveying, detecting, identifying, and decontaminating chemical and nuclear hazards. Also, technical expertise is available to provide training to determine the type and extent of toxic contamination, to determine downwind contamination hazard, and to assess vulnerability.

Training for disaster assistance will primarily focus on light urban search and rescue. Selected units may achieve some degree of proficiency while conducting normal METL training. The urgency of response rarely affords commanders the ability to train after the alert notification is issued. Although CS and CSS units will routinely be expected to execute this mission, combat units could also be tasked. In all cases, unit METLs incorporate tasks which prepare personnel to perform this operation. For example, a supply company may have the METL task to receive, store, and distribute supplies. This same task could apply to disaster assistance operations, even though the supplies may be donated food and clothing and not military supplies. Figure 9-3 provides some additional examples of normal METL training that support disaster assistance.

The senior commanders involved must understand the DOD role in the Federal Response Plan. They then ensure subordinate leaders are familiarized with civil and municipal operations. For units to be quickly and smoothly deployed for domestic support they must know the specific rules for their employment. They must know the reporting channels, have a clear understanding of who is in charge, and know how the unit will receive necessary supplies. All leaders receive introductory contracting and ordering procedures training in professional development courses. However, they may require additional or refresher training in order to obtain supplies when operating outside the normal military logistics support arena. Some leaders may need to be trained as contracting and ordering officers.

Mass immigration emergency support is another form of humanitarian assistance. Again, routine

conduct of common skills training will prepare units to execute this operation. Any specialized training requirements will have to be identified by tasked commanders in conjunction with the Department of Justice and the Immigration and Naturalization Service.

#### LAW ENFORCEMENT SUPPORT OPERATIONS

The three distinct missions grouped under law enforcement support are counterdrug, civil disturbance, and combatting terrorism. Many tasks on which units train to meet wartime mission requirements are directly applicable. In cases where requirements are unrelated to the wartime METL, commanders must employ mission focus to define new training needs. Civilian law enforcement agencies must understand that very specific laws govern the use of the military to support civilian law enforcement activities.

The National Guard conducts a great deal of training and maintains a viable force to support law enforcement in counterdrug, civil disturbance, combatting terrorism, and key asset protection. The National Guard Bureau provides funding to the states to develop key asset security plans and to train leaders in civil disturbance operations. Hurricane Andrew is an excellent example where the Florida National Guard was on the street within hours after passage, providing security support with trained personnel to law enforcement agencies.

Counterdrug missions present unique training opportunities. Units formulate plans to conduct training in high-intensity drug trafficking areas. If appropriate, units will be integrated into federal or state Drug Enforcement Agency operations.

*Elements of the 854th Engineer Battalion, 77th US Army Reserve Command, provided the manpower and equipment to clear and grade 20 acres for construction of a new softball and Little League fields in Hyde Park, New York.*

Commanders are responsible for civil disturbance operations training. As an exception to most domestic support operations, OPLAN GARDEN PLOT requires that Army units conduct civil disturbance training. Assigned missions and command guidance determine the frequency of training. Specific training for commanders and staffs should address legal and psychological considerations. Training for soldiers should address legal and psychological considerations, rules of engagement, search and seizure, use of special equipment, and crowd control techniques.

**Commanders are responsible for civil disturbance operations training.**

Combatting terrorism includes defensive measures against terrorist attack. All soldiers must train on the fundamentals necessary to defend installations, units, and individuals against terrorist attack. Combatting terrorism is a force protection measure and the responsibility of commanders at every level. Military police have the capability to conduct specialized training for combatting terrorism for both the Army and civil authorities. The use of explosives and booby traps is a common tool employed by terrorists. EOD personnel can provide training and planning assistance for combatting terrorism operations.

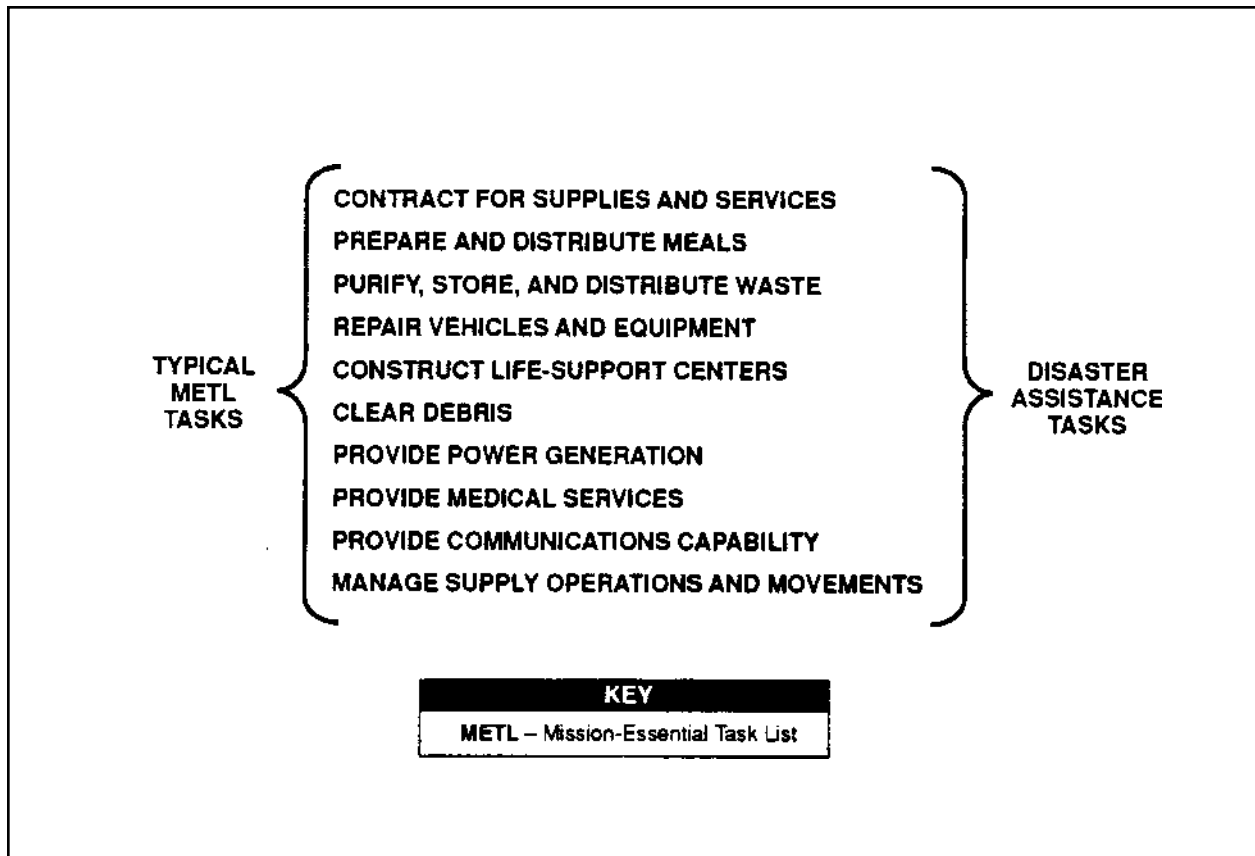


Figure 9-3. Disaster Assistance Supporting Tasks

### SUMMARY

Wartime mission training is the basis of the Army’s capability to provide domestic support. Specialized training, when directed by the respective CINC or MACOM commander, will be conducted for selected operations. Leader training for domestic support operations is vital to provide unit responsiveness to the community without reducing proficiency in warfighting tasks.

---

# APPENDIX

## ANALYSIS OF THE AREA OF OPERATIONS FOR DISASTER ASSISTANCE

---

The analysis of the area of operations is a detailed study conducted within time constraints to serve as the basis for developing specific courses of action. It includes an analysis of weather, terrain, and other factors such as the political boundaries, governmental structures, economy, social groups, location, scope, and severity of damage throughout the commander's projected area of operations.

The civil-military operations (CMO) team is responsible for initiating, coordinating, completing and disseminating the final analysis of the area of operations, which represents a coordinated staff effort with federal and state agencies. Considerations for area analysis may also apply to other types of operations. In any event, the assigned mission will dictate what essential elements of information (EEI) are needed.

### ESSENTIAL ELEMENTS OF INFORMATION

In most cases, the EEI about the area of operations can be readily determined by consulting several FORSCOM automated systems. One of these is the FORSCOM Automated Intelligence Support System (FAISS), a geographic information system that uses Defense Mapping Agency maps and a variety of data bases to locate and display many of the EEI. A second automated system available at FORSCOM is a DOD resource data base that contains information about military resources and points of contact that might be used or called upon to respond to domestic support operations. The FEMA also has automated systems, such as their Disaster Analysis System (an automated mapping program), which they make available to military commanders to facilitate analyses and mapping of the closest critical resources. Typical EEI are discussed briefly below.

In preparing the analysis of the area of operations, the information that the CMO team gathers to satisfy the commander's EEI normally includes:

- Location of victims needing rescue, evacuation, and emergency medical treatment and status of local emergency medical capabilities. Of particular importance are severe weather and terrain conditions that may significantly displace the population. Existing facilities or locations for temporary housing of displaced persons should be identified.
- Description and status of lines of communication (LOCs), including major roads, railroads, waterways, ports, and airports. Typically, the detailed status of airfields, ports and harbors, rail facilities, facilities for maintenance and storage, and electronic media and telephone towers is unknown during the first hours or day after the event. If possible, information on these infrastructure facilities within the impacted area should state the nature and extent of damage and projected repairs.
- Weather conditions. List or refer to other documents containing, for the period under study, meteorological conditions, including precipitation, fog, cloud conditions, temperature, relative humidity, light data (including moon phases, moonrise and moonset, beginning and end of nautical and civil twilights), magnetic phenomena, extended forecast, and other data as appropriate.
- Characteristics of physical damage in specific disaster areas, that is, housing, commercial, industrial, public utilities, and so forth. In

residential areas, damage assessment should start in high-density and low-income areas. Mobile homes are especially vulnerable and may contain a larger proportion of the elderly and children than other areas. High-rise apartment buildings and business offices are potential areas of risk in no-warning events (earthquakes and tornados), depending on the time of the occurrence.

- Numbers and locations of displaced persons. Economically distressed areas are characterized by higher residential density, lower maintenance, and older structures, which combine to increase the probability of victims. These areas are frequently adjacent to manufacturing or industrial areas containing potentially hazardous materials. Identifying fires, chemical spills, or ruptured pipelines near residential areas is a priority.
- Population of discrete areas such as trailer parks, apartments, and subdivisions. Residents of economically distressed areas are more likely to remain in the area and require a greater level of support after the event than those in more affluent areas. School buildings and warehouses in these areas are excellent candidates for shelter, feeding, and life-support sites. Generally, the more affluent population live in less densely populated areas with better construction. If not trapped, they have the economic resources to seek alternative living arrangements.
- General age distribution of population in above areas.
- General ethnic distribution of population in disaster areas; include types of linguists required.
- Areas without electricity.
- Areas without water, status of water purification systems, and availability of commercial purification equipment and products.
- Location and capabilities of medical facilities (hospitals, clinics, nursing homes, and so forth).
- Status of sanitation systems.
- Relief and drainage systems. Determine effects on trafficability for unit vehicles involved in rescue and relief efforts. Estimate time to improve drainage in flooded areas; include bridging requirements if applicable.

- Obstacles. Identify areas where debris impedes trafficability.
- Surface materials. Identify type and distribution of soils and subsoils in area and soil trafficability.
- Man-made features. Identify man-made changes in the topography, including roads, railroads, bridges, tunnels, mines, towns, industrial areas, and piers. Identify unsafe structures requiring demolition.
- Sources of all classes of supply needed for critical restoration activities.
- Local sources of media reproduction, especially high-speed, large-format printing.
- Availability of civilian engineer equipment and personnel.

The above EEI will be significantly modified after the first 72 hours and will be replaced by increasing demands for specific information on other aspects of the event. The management of information may become more difficult as the quantity and quality of information increase. As additional state and federal assets arrive in the area of operations, coordination and communication become more complicated.

New information requirements are generated by the need to deploy the resources efficiently and effectively. DOD planners and operators at this point should be integrated, if possible, with the FEMA's ESF-5, Information and Planning Operations, which focuses on establishing a centralized repository of data for executing relief operations.

### **SOURCES OF INFORMATION**

Sources of information that will satisfy many of the commander's EEI include:

- Information provided by federal, state, and local governments and commercial and private agencies.
- National and local media and their reports.
- Aerial reconnaissance.
- The engineer's terrain analysis.
- The staff weather officer's meteorological data.



- The provost marshal's analysis of route reconnaissance, state of law and order, and other information.
- Analysis prepared by other headquarters.
- Information on city, county, and state government; city, county, and state police; utility districts; fire, ambulance, and hospital districts; and federal/national agencies (USACE, Red Cross, and so forth). Intelligence personnel can be used for liaison as well as other intelligence support activities, but their use must be in accordance with governing directives.
- Maps. The US Geological Service and the Defense Mapping Agency are two sources for maps. DOD customers requiring USGS products may process requests through the DMA. Maritime and coastal maps may be obtained from the USCG as required. Local topography and maps can be provided by state land-use master plans, state pollution control, state water management, local public works departments, local water and sewer works, zoning boards, county recorder, local map printers, local tourism

departments, local geographic information systems, chambers of commerce, and university departments.

- Imagery Products. Imagery or imagery-derived products supporting domestic operations can be obtained from commercial or government sources. The USACE district offices can provide imagery products for floodplain areas. A request can also be forwarded through the chain of command to the Army Operations Center. Civilian aircraft imagery should be obtained wherever possible. If commercial capabilities are not available, aerial assets may be used.
- Demographics and business data for metropolitan areas. These are provided by the US Bureau of Census, the US HUD Community Block Grant Program, state agency or local housing authority, and commercial data base products.

The above list is not all-inclusive. As the operation progresses, changes in the mission or receipt of additional or more accurate information will require revision of the analysis and modification of the EEL.

## GLOSSARY

---

**AAA**

Army Audit Agency

**AAR**

after-action review

**AC**

active component

**ACS-IM**

Assistant Chief of Staff-Installation Management

**AFR**

Air Force regulation

**AID**

Agency for International Development

**ANG**

Air National Guard

**ANGR**

Air National Guard regulation

**AO**

area of operations

**AOC**

Army operations center

**AOR**

area of responsibility

**AP**

assembly point

**APG**

aviation procedure guide

**APHIS**

Animal and Plant Health Inspection Service

**AR**

Army regulation

**ARC**

American Red Cross

**ARCS**

alternative remedial contracting strategy

**Area of assistance**

The geographical location for which a civil authority has requested some form of military assistance.

**Army**

The term "Army" includes the active component, the

Army National Guard, the US Army Reserves, and Department of Army civilians.

**Army support to civil law enforcement**

The authorized use of Army assets to support civilian law enforcement officials and organizations.

**Army support for disaster assistance**

The authorized use of Army physical and human resources to support civilian disaster relief.

**Army support for environmental assistance missions**

The authorized use of Army assets to support civil authorities in the preservation and protection of human health and the environment.

**ARNG**

Army National Guard

**ARSTAFF**

Army Staff

**ASA**

Assistant Secretary of the Army

**ASA (CW)**

Assistant Secretary of the Army for Civil Works

**ASA (FM)**

Assistant Secretary of the Army for Financial Management

**ASA (IL&E)**

Assistant Secretary of the Army for Installation Logistics and Environment

**ASA (M&RA)**

Assistant Secretary of the Army for Manpower and Reserve Affairs

**ASA (RD&A)**

Assistant Secretary of the Army for Research, Development, and acquisition

**ASD**

Assistant Secretary of Defense

**ASL**

authorized stockage list

**Assembly point**

The designated location near a disaster-affected area where newly arriving personnel register, are oriented to the situation, and are assigned to a specific duty

station. Once established, the AP can be located at the POA or at the DFO.

**AT**

annual training

**Attack**

Sabotage or the use of bombs, shellfire, or nuclear, radiological, chemical, bacteriological, or biological means, or other weapons or processes by an enemy causing, or that may cause, substantial damage or injury to persons or property in the United States (or its territories) in any manner.

**B**

**Base camp**

The designated location under local or state control within a disaster area that is equipped and staffed to provide sleeping facilities, food, water, and sanitary services for response personnel.

**BATF**

Bureau of Alcohol, Tobacco, and Firearms

**BDAR**

battle damage assessment and repair

**BIA**

Bureau of Indian Affairs

**BLM**

Bureau of Land Management

**BSI**

base support installation

**C**

**C<sup>3</sup>I**

command, control, communications and intelligence

**C4**

command, control, communications, and computers

**CA**

civil affairs

**CAI**

chemical accident/incident

**CAIC**

chemical accident or incident control

**CAIRA**

chemical accident and incident response and assistance

**CARDA**

Continental US airborne reconnaissance for damage assessment

**CCG**

crisis coordination group

**CD**

counterdrug

**CDE**

counterdrug review and evaluation

**CDR**

commander

**CENTCOM**

Central Command

**CERCLA**

The Comprehensive Environmental Response, Compensation, and Liability Act

**CFR**

Code of Federal Regulation

**CINC**

Commander-in-Chief

**CINCFOR**

Commander-in-Chief, Forces Command

**CINCLANT**

Commander-in-Chief, Atlantic Command

**CINCPAC**

Commander-in-Chief, Pacific Command

**CINCSpace**

Commander-in-Chief, Space Command

**CINCTRANS**

Commander-in-Chief, Transportation Command

**CIO**

Central Imagery Office

**Civil authorities**

Those elected and appointed officers and employees who constitute the government of the United States, of the 50 states, the District of Columbia, the Commonwealth of Puerto Rico, US possessions and territories, and political subdivisions thereof.

**Civil defense**

All those activities and measures designed or undertaken to minimize the effects caused, or that would be caused, by an attack upon the United States or by a natural or technological disaster; to deal with the immediate emergency conditions that would be created; and to effect emergency repairs to, or the emergency restoration of, vital utilities and facilities destroyed or damaged by any such attack or disaster.

**Civil disturbances**

Riots, acts of violence, insurrections, unlawful obstructions or assemblages, or other disorders prejudicial to public law and order. The term includes all domestic conditions requiring or likely to require the use of federal armed forces pursuant to the provisions of Chapter 15, Title 10, United States Code.

## **Civil emergency**

Any natural or man-made disaster or emergency that causes or could cause substantial harm to the population or infrastructure. This term can include a “major disaster” or “emergency” as those terms are defined in The Stafford Act, as amended, as well as consequences of an attack or a national security emergency. “Major disasters” and “emergencies” are defined substantially by action of the President in declaring that extent circumstances and risks justify his implementation of the legal powers provided by statute.

## **Civil emergency preparedness**

The nonmilitary actions taken by federal agencies, the private sector, and individual citizens to meet essential human needs, to support the military effort, to ensure continuity of federal authority at national and regional levels, and to ensure survival as a free and independent nation under all emergency conditions, including a national emergency caused by threatened or actual attack on the United States.

## **Civil government resources**

Civil resources owned by, controlled by, or under the jurisdiction of civilian agencies of the US Government, or of state and local government agencies. Civilian law enforcement official An officer or employee of a civilian agency with responsibility for enforcing the laws within the jurisdiction of the agency. These may include the DEA, the FTA, the FBI, or state police.

## **Civil resources**

Resources that normally are not controlled by the government, including the work force, food and water, health resources, industrial production, housing and construction, telecommunications, energy, transportation, minerals, materials, supplies, and other essential resources and services. No one except authorized civil government authorities can order such resources to support the needs of the public.

## **CJCS**

Chairman of the Joint Chiefs of Staff

## **CMO**

civil-military operations

## **CMOC**

Civil-Military Operations Center

## **COCOM**

combatant command

## **Community assistance**

The authorized use of Army assets to provide support, enhance relations, and promote mutual understanding between the Army and the civilian community.

## **COMNAVMAR**

Commander, Naval Forces Marianas

## **Continental US airborne reconnaissance for damage assessment**

A system of aerial reconnaissance of the Continental United States for determining the effects of a nuclear attack. CARDA integrates the combined resources of all government agencies and military services for the National Command Authorities.

## **CONUS**

Continental United States

## **CONUSA**

Continental United States Army

## **COSCOM**

corps support command

## **CS**

combat support

## **CSA**

Chief of Staff, Army

## **CSH**

combat support hospital

## **CSS**

combat service support

## **CVS**

commercial vendor services

## **CW**

civil works

## **D**

## **DA**

Department of the Army

## **DACS-PAE**

Deputy Assistant Chief of Staff for Program Analysis and Evaluation

## **DARE**

drug abuse resistance education

## **DARNG**

Director, Army National Guard

## **DAS**

Director of the Army Staff

## **DASA**

Deputy Assistant Secretary of the Army

## **DASA (ESOH)**

Deputy Assistant Secretary of the Army for Environment, Safety, and Occupational Health

## **DASC**

Defense Logistics Agency Administration Support Center

**DASD**

Deputy to the Assistant Secretary of Defense

**DCAS**

Defense Contract Administration Service

**DCE**

defense coordinating element

**DCINC**

deputy commander-in-chief

**DCMC**

Defense Contract Management Command

**DCO**

defense coordinating officer

**DCS**

Defense Communications System

**DCSINT**

Deputy Chief of Staff for Intelligence

**DCSLOG**

Deputy Chief of Staff for Logistics

**DCSOPS**

Deputy Chief of Staff for Operations

**DCSPER**

Deputy Chief of Staff for Personnel

**DEA**

Drug Enforcement Administration

**Defense coordinating officer**

A military or civilian official of any DOD component to whom the DOD executive agent has delegated authority to coordinate MSCA activities. Each DCO's authority will be defined in documentation issued or authorized by the DOD executive agent and will be limited either to the requirements of a specified interagency planning process or to a specified geographic area or emergency.

**Defense Emergency Response Fund**

Established by Public Law No. 101-165 (1989), "The Fund shall be available for providing reimbursement to currently applicable appropriations of the Department of Defense for supplies and services provided in anticipation of requests from other federal departments and agencies and from state and local governments for assistance on a reimbursable basis to respond to natural or man-made disasters. The fund may be used upon determination by the Secretary of Defense that immediate action is necessary before a formal request for assistance on a reimbursement basis is received.

**DEP**

Director of Environmental Programs

**DEUR**

Defense Logistics Agency, Europe

**DFO**

disaster field office

**DHHS**

Department of Health and Human Services

**DHUD**

Department of Housing and Urban Development

**DIS**

Directorate of Installation Support

**Disaster Field Office**

The primary field location in each affected state for the coordination of response and recovery operations. The DFO houses the FCO and staff comprising the ERT. It will operate 24 hours a day, as needed, or with a schedule sufficient to sustain federal response operations. Except where facilities do not permit, the FCO will be collocated at the DFO with the state coordinating officer.

**DISCOM**

division support command

**DLA**

Defense Logistics Agency

**DLEA**

drug law enforcement agency

**DMA**

Defense Mapping Agency

**DMAT**

disaster medical assistance team

**DMC**

defense movement coordinator

**DOC**

Department of Commerce

**DOD**

Department of Defense

**DODD**

Department of Defense directive

**DOD executive agent**

The individual designated by position to have and to exercise the assigned responsibility and delegated authority of the Secretary of Defense.

**DOD planning agent**

An individual designated by position to facilitate and coordinate civil assistance contingency planning and operations when ordered for all DOD components within an assigned geographic area.

**DODRDB**

Department of Defense resource data base

**DOD resources**

Military and civilian personnel, including selected and ready reservists of the military services,

and facilities, equipment, supplies, and services owned by, controlled by, or under the jurisdiction of a DOD component.

**DOE**

Department of Energy

**DOEd**

Department of Education

**DOI**

Department of Interior

**DOJ**

Department of Justice

**DOL**

Department of Labor

**Domestic support operations**

The authorized use of Army physical and human resources to support domestic requirements.

**DOMS**

Director of Military Support (US Army)

**DOS**

Department of State

**DOT**

Department of Transportation

**DPAC**

Defense Logistics Agency, Pacific

**DPCA**

Directorate of Personnel and Community Activities

**DPS**

Department of Public Safety

**DPTM**

Director of Plans, Training, and Mobilization

**DRM**

Directorate of Resource Management

**DS**

direct support

**DSMOA/CA**

defense and state memorandum of agreement/  
cooperative agreement

**DWI**

disaster welfare information

## E

**EEI**

essential elements of information

**EEO**

Equal Employment Opportunity

**Emergency Support Function (ESF)**

A functional area-of-response activity established to facilitate the delivery of federal assistance during the immediate response phase of a disaster to save lives, to protect property and public health, and to maintain public safety.

**EOC**

Emergency Operations Center

**EOD**

explosive ordnance disposal

**EPA**

Environmental Protection Agency

**EPIC**

El Paso Intelligence Center

**EPLO**

emergency preparedness liaison officer

**ERT**

emergency support team

**ESF**

emergency support function

**ESF 1 Transportation**

This ESF coordinates federal transportation support to state and local government entities, voluntary organizations, and federal agencies requiring transportation to perform disaster assistance missions following a catastrophic earthquake, significant natural disaster, or other event requiring federal response.

**ESF 2 Communications**

This ESF assures the provision of federal telecommunications support to federal, state, and local response efforts following a Presidentially declared emergency, major disaster, extraordinary situation, and other emergencies under the Federal Response Plan.

**ESF 3 Public Works and Engineering**

Public works and engineering support includes technical advice and evaluations, engineering services, potable water, construction management and inspection, emergency contracting, emergency repair of wastewater and solid waste facilities, and real estate support as required.

**ESF 4 Firefighting**

The purpose of this ESF is to detect and suppress wildland, rural, and urban fires resulting from, or occurring coincidentally with, a catastrophic earthquake, significant natural disaster, or other event requiring federal response assistance.

**ESF 5 Information and Planning**

The purpose of this ESF is to collect, process, and disseminate information about a potential or actual disaster or emergency to facilitate the overall activities

of the federal government in providing response assistance to an affected state.

**ESF 6 Mass Care**

This ESF coordinates efforts to provide shelter, food, and emergency first aid following a catastrophic earthquake, significant natural disaster, or other event requiring federal assistance; to operate a DWI System to collect, receive, and report information about the status of victims and to assist with family reunification within the disaster area; and to coordinate bulk distribution of emergency relief supplies to disaster victims following a disaster.

**ESF 7 Resource Support**

This ESF provides logistical/resource support following a catastrophic earthquake, other significant natural disaster, or other event requiring federal response, including emergency relief supplies, space, office equipment, office supplies, telecommunications, contracting services, transportation services (in coordination with ESF 1), and personnel required to support immediate response activities.

**ESF 8 Health and Medical Services**

This ESF provides government-coordinated assistance to supplement state and local resources in response to public health and medical care needs following a significant natural disaster or man-made event.

**ESF 9 Urban Search and Rescue**

The US&R activities include locating, extricating, and providing for the immediate medical treatment of victims trapped in collapsed structures.

**ESF 10 Hazardous Materials**

This ESF provides federal support to state and local governments in response to an actual or potential discharge and/or release of hazardous materials following an earthquake or other disaster.

**ESF 11 Food**

This ESF identifies, secures, and arranges for the transportation of food to affected areas following a major disaster or emergency or other event requiring federal response.

**ESF 12 Energy**

This ESF facilitates restoration of the nation's energy systems following a catastrophic earthquake, natural disaster, or other significant event requiring federal assistance.

**EUCOM**

European Command

**EXORD**

Execution Order

**Explosive Ordnance Disposal**

Detecting, identifying, evaluating, rendering safe, recovering, and finally disposing of unexploded explosive ordnance.

**F**

**FAA**

Federal Aviation Administration

**FAISS**

FORSCOM Automated Intelligence Support System

**FBI**

Federal Bureau of Investigation

**FCC**

Federal Communications Commission

**FCO**

federal coordinating officer

**FED**

federal

**Federal coordinating officer**

The FCO is the senior federal official appointed to coordinate overall response and recovery activities. The FCO represents the President in coordinating the federal relief activities in a designated area.

**Federal function**

Any function, operation, or action carried out under the laws of the United States by a department, agency, officer, or employee of the United States.

**Federal property**

Property that is owned, leased, possessed, or occupied by the federal government.

Federal region A grouping of states and territories by which FEMA coordinates responsibilities of the state governments with those of federal departments and agencies for disaster relief, civil defense, and planning for both civil and national security emergencies. These regions are sometimes referred to as "FEMA regions" to distinguish them from any one of the various alignments of other federal departments and agencies, all of which are circumscribed by FEMA's coordination authority.

**Federal Response Plan (FRP)**

The interdepartmental planning mechanism, developed under FEMA leadership, by which the federal government prepares for and responds to the consequences of catastrophic disasters. Federal planning and response are coordinated on a functional group basis, with designated lead and support agencies for each identified functional area.

**FEMA**

Federal Emergency Management Agency

**FESC**

federal emergency support coordinator

**FM**

field manual

**FOA**

field operating agency

**Force protection**

Security program developed to protect soldiers, civilian employees and family members, facilities and equipment, in all locations and situations. This is accomplished through the planned integration of terrorism, physical security, OPSEC, protective services, and law enforcement operations, supported by foreign intelligence, counterintelligence, and other security programs.

**Force provider**

A transportable support system, operated by a company-size unit, equipped to provide services (food, hygiene, billeting, morale support) for up to 3300 soldiers.

**FORSCOM**

Forces Command

**FRERP**

Federal Radiological Emergency Response Plan

**FRP**

Federal Response Plan

**FSC**

field supply company

**FST**

finance support teams

**G**

**GAO**

General Accounting Office

**GARDEN PLOT**

DOD and subordinate headquarters OPLAN addressing civil disturbance operations.

**GEO**

geographic

**GIS**

Geographic Information System

**GRASS**

Geographic Resource Analysis Support System

**GSA**

General Services Administration

**H**

**Hazard**

A condition with the potential of injuring personnel, damaging equipment or structures, losing material, or reducing ability to perform a prescribed function.

**HAZMAT**

hazardous materials

**HHS**

health and human services

**HIDTA**

high-intensity drug trafficking area

**High-tech Improvised explosive device**

An item with an explosive or special filler designed to cause extensive death or destruction. It may be complex or sophisticated in design, including many intricate arming or firing systems, including booby traps.

**HQ**

headquarters

**HQDA**

Headquarters, Department of the Army

**HRMSI**

high-resolution multispectral stereo imager

**HSC**

Health Services Command

**HSS**

health services support

**HUD**

Housing and Urban Development

**I**

**ICC**

Interstate Commerce Commission

**ICP**

inventory control point

**ICS**

Incident Command System

**IED**

improvised explosive device

**IG**

Inspector General

**IL&E**

installation logistics and environment

**IMA**

information mission area

**Immediate response**

Any form of immediate action taken by a DOD component or military commander under the authority



of the FRP and any supplemental guidance to assist in saving lives, preventing human suffering, or mitigating great property damage under imminently serious conditions where there has not been an attack or any declaration of major disaster or emergency by the President.

**Imminently serious conditions**

Emergency conditions in which, in the judgment of the military commander or responsible DOD official, immediate and possibly serious danger threatens the public and prompt action is needed to save lives, prevent human suffering, or mitigate great property damage. Under these conditions, timely prior approval from higher headquarters may not be possible before action is necessary for effective response.

**Improvised explosive device**

A nonstandard item, usually crude and simple in design, containing an arming or timing system, an initiator, and an explosive filler. A homemade bomb.

**INS**

Immigration and Naturalization Service

**Insurrection.**

The act of unlawfully rising in open resistance against established authority or government or against the execution of the laws of government.

**IPB**

intelligence preparation of the battlefield

**IRF**

initial response force

**IRMMP**

interregional military medical plans

**IRP**

installation restoration program

**IRR**

individual ready reserve

**IRS**

Internal Revenue Service

**ITO**

installation transportation office

**J**

**JCS**

Joint Chiefs of Staff

**JIC**

Joint Information Center

**JLSC**

Joint Logistics System Center

**JMC**

joint movement center

**Joint movement center**

A jointly staffed movement control organization attached to a joint force headquarters to plan, apportion, allocate, and coordinate transportation support for the joint force; deconflict priorities; and provide intransit visibility of movements.

**Joint transportation office**

An office established under a JMC to procure commercial transportation, issue documentation, manage commercial funding, and provide quality assurance.

**JP**

joint publication

**JRS**

joint reporting structure

**JTF**

joint task force

**JTO**

joint transportation office

**JTTP**

joint tactics, techniques, and procedures

**K**

**KAPP**

Key Asset Protection Program

**L**

**LA**

lead agency

**LANDSAT US System**

Formal designation for the Multispectral Imagery System. LANDSAT-7 will include the thematic mapping plus (TM+) and the HRMSI.

**LANTCOM**

United States Atlantic Command

**Law enforcement agency—drug related**

Those federal, state, or local agencies empowered to enforce civil laws and engage in official activities against the illegal production, transport, sale, or use of illegal drugs.

**LEA**

law enforcement agency

**LOC**

lines of communication

**Local government**

Any county, city, village, town, district, or other political subdivision of any state.

**LSO**

logistics support officer

**M**

**MACOM**

major command

**Major disaster**

Any disaster caused by flood, drought, fire, earthquake, storm, hurricane, or environmental hazard of catastrophic magnitude that has major impact on life and property.

**Marshaling area**

An area used for the mobilization and assemblage of personnel and resources prior to their being sent to the disaster-affected area.

**MASH**

mobile army surgical hospital

**MAST**

military assistance to safety and traffic

**MC**

mobilization center

**MDIO**

Missile Defense Initiative Organization

**MEDDAC**

medical department activity

**METL**

mission-essential task list

**METT-T**

mission, enemy, troops, terrain, and time available

**MI**

military intelligence

**Military resources**

Military and civilian personnel, facilities, equipment, and supplies under the control of a DOD component.

**Military support to civil authorities**

Those activities and measures taken by the DOD components to foster mutual assistance and support between the Department of Defense and any civil government agency in planning or preparing for, or in the application of resources in response to the consequences of civil emergencies or attacks, including national security emergencies.

**MLO**

military liaison officer

**MMC**

Material Management Center

**MOA**

memorandum of agreement

**Mobilization center**

The designated location at which response personnel and resources are received from the POA and pre-positioned for deployment to a local staging area or

an incident site. An MC also provides temporary support services, such as food and billeting, for response personnel prior to their deployment.

**MOU**

memorandum of understanding

**M&RA**

manpower and reserve affairs

**MRE**

meals, ready-to-eat

**MSCA**

military support to civil authorities

**MTT**

mobile training team

**MWR**

morale, welfare, and recreation

**N**

**NAI**

nuclear accident/incident

**NAIC**

nuclear accident or incident control

**NAIRA**

nuclear accident or incident response and assistance

**NASA**

National Aeronautical and Space Administration

**National Disaster Medical System.**

An interdepartmental mutual aid system developed by federal departments and agencies to provide for the medical needs of victims of major disasters and to provide backup support for DOD and VA medical systems in caring for casualties from military conflicts. The DHHS serves as the lead federal agency for administering NDMS and coordinates NDMS operations in response to civil emergencies. The DOD could activate and coordinate NDMS operations in support of military contingencies. National security emergency Any occurrence, including natural disaster, military attack, technological emergency, or other emergency, that seriously degrades or threatens the national security of the United States.

**NBC**

nuclear, biological, and chemical

**NCA**

National Command Authorities

**NCP**

National Contingency Plan

**NCS**  
National Communications System

**NDMS**  
National Disaster Medical System

**NG**  
National Guard

**NGB**  
National Guard Bureau

**NGR**  
National Guard regulation

**NIFC**  
National Interagency Fire Center

**NORAD**  
North American Aerospace Defense Command

**NPDES**  
National Pollutant Discharge Elimination System

**NPS**  
National Park Service

**NRC**  
Nuclear Regulatory Commission

**NSA**  
National Security Agency

**NSEP**  
national security emergency preparedness

**NWS**  
National Weather Service

**O**

**OCONUS**  
outside the Continental United States

**ODCSOPS**  
Office of the Deputy Chief of Staff for Operations

**OES**  
Office of Emergency Services

**ONDCP**  
Office of National Drug Control Policy

**OP ALLIANCE**  
Operation Alliance

**OPCON**  
operational control

**OPLAN**  
operation plan

**OPLAN GARDEN PLOT**  
DOD and subordinate headquarters' OPLANs addressing civil disturbance operations.

**OPM**  
Office of Personnel Management

**OPORD**  
operation order

**OPS**  
operations

**OPSEC**  
operations security

**ORG**  
organization

**ORNG**  
Oregon National Guard

**OSC**  
on-scene coordinator

**P**

**PA**  
public affairs

**PACOM**  
United States Pacific Command

**PAO**  
public affairs officer

**PCB**  
polychlorinated biphenyl

**PHS**  
public health service

**PL**  
public law

**Planning agent**  
A military or civilian official of any DOD component who has been designated by the head of that component to exercise delegated authority for civil assistance planning for the entire component (i.e., "principal planning agent") or for certain subordinate elements or a specified geographic area (e.g., "region planning agents"). Authority and responsibilities of each planning agent will be defined by the component and may include civil assistance response as well as planning at the election of any component. Planning agents' actual authority will be communicated to others as determined by the DOD component, or when requested by the DOD executive agent.

**PLL**  
prescribed load lists

**POA**  
point of arrival

**POC**  
point of contact

**Point of arrival**  
The designated location (typically an airport) within or near the disaster-affected area where newly arriving

staff, supplies, and equipment are initially directed. Upon arrival, personnel and other resources are dispatched to either the DFO, a mobilization center, a staging area, or a disaster site.

**Point of departure**

The designated location (typically an airport) outside of the disaster-affected area from which response personnel and resources will deploy to the disaster area.

**POMSO**

Plans, Operations, and Military Support Officer

**POTO**

plans, operations, and training officer

**Primary agency**

The federal department or agency assigned primary responsibility for managing and coordinating a specific ESF.

**PROFIS**

Professional Officer Filler System

**PSYOP**

psychological operations

**Q**

**QM**

quartermaster

**R**

**RC**

reserve component

**RCRA**

The Resource Conservation And Recovery Act

**RDA**

research development and acquisition

**READEO**

Regional Emergency Animal Disease Eradication Organization

**RECA**

residual capability assessment

**Regional military emergency coordinator**

An individual designated on behalf of the Secretary of Defense and the DOD executive agent to coordinate, exchange, information, and perform liaison functions on behalf of the DOD with any federal emergency management structure established at the regional level.

**Regional Operations Center (ROC)**

The facility established at a FEMA regional office (or a federal regional center) in response to (or in

anticipation of) an event that may require federal assistance under the FRP. The ROC is staffed by FEMA regional personnel and representatives from the ESF primary agencies as required. It serves as an initial point of contact in the region for the affected state(s), the national emergency support team, and federal agencies.

**Residual capability assessment**

An assessment of the effects of a nuclear or conventional attack on US resources or of a major peacetime disaster that results in the declaration of a national security emergency. Such an assessment is made (through all appropriate means) to determine the remaining capabilities of the United States, with emphasis on military preparedness.

**Resource claimancy**

The procedure, employed during any period of attack or national security emergency, whereby authorized federal agencies determine definitive requirements and justify the allocation of civil government and civil resources needed to support programs under their cognizance. It does not imply procurement activity, nor does it involve the government as an intermediary in the normal mechanisms of trade other than in expediting essential activities and ensuring equitable distribution of civil resources. Resource claimancy occurs at both the national and regional levels.

**Risk**

An expression of possible loss over a specific period of time or number of operating cycles.

**Risk assessment**

The process of detecting hazards and systematically assessing their overall risk. It is a part of the risk management process.

**Risk management**

The process whereby decisions are made and actions implemented to eliminate or reduce the effects of identified hazards.

**RLSO**

regional logistics support office

**RMEC**

regional military emergency coordinator

**ROC**

regional operations center

**ROE**

rules of engagement

**ROTC**

Reserve Officers Training Corps

**S**

**SA**  
Secretary of the Army

**SAC**  
senior agent in charge

**SCE**  
support contracting element

**SCO**  
state coordinating officer

**SCRAG**  
senior representative of the Attorney General

**SECDEF**  
Secretary of Defense

**SECY**  
secretary

**SF**  
special forces

**SJA**  
Staff Judge Advocate

**SOCOM**  
Special Operations Command

**SOF**  
special operations forces

**SOUTHCOM**  
United States Southern Command

**SPACECOM**  
Space Command

**SRF**  
service response force

**Staging area**  
The facility at the local jurisdictional level near the disaster site where personnel and equipment are assembled for immediate deployment to an operational site within the disaster area.

**STAMIS**  
Standard Automated Management Information System

**STARBASE**  
Science and technology academies reinforcing basic aviation and space exploration.

**STARC**  
state area command

**State**  
Any state of the United States, the District of Columbia, Puerto Rico, the Virgin Islands, Guam, American Samoa, Northern Mariana Islands, and the Trust Territory of the Pacific Islands.

**State area commands**

Specific headquarters units of the Army National Guard for each state, the District of Columbia, Guam, Puerto Rico, and the Virgin Islands.

**STRATCOM**

Strategic Command

**Support agency**

A federal department or agency designated to assist a specific primary agency with available resources, capabilities, or expertise in support of ESF response operations under the coordination of the primary agency.

**T**

**TAG**

The state adjutant general; the adjutant general

**TC**

training circular

**Technological hazard**

A range of hazards emanating from the manufacture, transportation, and use of such substances as radioactive materials, chemicals, explosives, flammables, agricultural pesticides, herbicides, and disease agents; oil spills on land, coastal waters, or inland water systems; and debris from space.

**Terrorism.**

The calculated use of violence or the threat of violence to attain goals that are political, religious, or ideological in nature. This can be done through intimidation, coercion, or instilling fear. Terrorism includes a criminal act against persons or property that is intended to influence an audience beyond the immediate victims.

**TEU**

technical escort unit

**TF**

task force

**TM +**

thematic mapping plus

**TREAS**

Department of the Treasury

**TVA**

Tennessee Valley Authority

**U**

**UAV**

unmanned aerial vehicles

**UMT**

unit ministry team

**Unit ministry team**

A team consisting of a chaplain and a chaplain's assistant with the mission of providing religious support.

**USA**

United States Army

**USACE**

United States Army Corps of Engineers

**USAEC**

United States Army Environmental Center

**USAEHA**

United States Army Environmental Hygiene Agency

**USAEHSC**

United States Army Engineering and Housing Support Center

**USAF**

United States Air Force

**USAG**

United States Attorney General

**USAHSC**

United States Army Health Services Command

**USAMC**

United States Army Materiel Command

**USAR**

United States Army Reserve

**USARPAC**

United States Army, Pacific

**USC**

United States Code

**USCG**

United States Coast Guard

**USCS**

United States Customs Service

**USDA**

United States Department of Agriculture

**USFS**

United States Forest Service

**USGS**

United States Geological Service

**USMC**

United States Marine Corps

**USMS**

United States Marshall Service

**USN**

United States Navy

**USPFO**

United States property and fiscal officers

**USPS**

United States Postal Service

**US&R**

urban search and rescue

**USSOUTHCOM**

United States Southern Command

**USSS**

United States Secret Service

**USTRANSCOM**

United States Transportation Command

**UXO**

unexploded ordnance

**V****VA**

Department of Veterans Affairs

**VCSA**

Vice Chief of Staff, Army

AR 500-70. Military Support of Civil Defense. October 5267).

## REFERENCES

---

### STATUTES

- 10 USC, § 101, 102, 401, 672, 673, 2300 *et seq.* Mobilization/Contracting Statutes
- 10 USC, § 331-35. *Insurrection.*
- 10 USC, § 371-80. *Military Support for Civilian Law Enforcement Agencies.*
- 10 USC, § 410. *Civil Military Cooperative Action Program.*
- 14 USC, § 1-894. *US Coast Guard.*
- 18 USC, § 592. Outlaws federal troops at polling places.
- 18 USC, § 1385. *The Posse Comitatus Act.*
- 28 USC, § 2671, *et seq.* *The Federal Tort Claims Act.*
- 31 USC, § 1301. Purpose Statute.
- 31 USC, § 1535. *The Economy Act.*
- 32 USC, § 112. *Authority to Use Army and Air National Guard in Certain Counterdrug Operations.*
- 32 USC, § 502, 3500. Mobilization Statutes (Army and Air National Guard).
- 33 USC, § 701n, *et seq.* *The Flood Control Act of 1941.*
- 42 USC, § 5121, *et seq.*, as amended. *The Robert T. Stafford Disaster Relief Act.*
- 49 USC, § 1200, *et seq.*, as amended. *The Federal Aviation Act.*
- 50 USC, § 797. *The Internal Security Act.*
- 50 USC, § Appendix 2251, *et seq.*, as amended. *The Federal Civil Defense Act of 1950.*

### EXECUTIVE ORDERS

- Executive Order 12556. *Assignment of Emergency Preparedness Responsibilities.*
- Executive Order 12333, *US Intelligence Activities.*

### FEDERAL PUBLICATIONS

- 5 CFR, Part 2635. *Standards of Ethical Conduct for Employees of the Executive Branch.*
- 44 CFR, Part 206. *Federal Emergency Management Agency Regulations.*
- The Federal Acquisition Regulation.*
- The Federal Response Plan.* April 1992.

*National Military Strategy.* 1992.

*National Security Strategy of the United States.* January 1993.

### **DOD PUBLICATIONS**

DODD 1225.6. *Equipping the Reserve Forces.* November 1992.

DODD 2000.12. *DOD Combatting Terrorism Program.* April 1983.

DODD 3020.36. *Assignment of National Security Emergency Preparedness Responsibilities to DOD Components.* November 1988.

DODD 3025.1. *Military Support to Civil Authority.* January 1993.

DODD 3025.10. *Military Support of Civil Defense.* July 1991.

DODD 3025.12. *Employment of Military Resources in Event of Civil Disturbances.* August 1971.

DODD 3025.13. *Employment of DOD Resources in Support of the US Secret Service.* September 1985.

DODD 3150.5. *DOD Response to Improvised Nuclear Device (IND) Incidents* March 1987.

DODD 5030.41. *Oil and Hazardous Substances Pollution Prevention and Contingency Program.* June 1977.

DODD 5100.1. *Functions of DOD and its Major Components.* September 1977.

DODD 5100.52. *DOD Response to an Accident or Significant Incident Involving Radioactive Materials.* March 1981.

DODD 5122.8. *Use of Military Carriers for PAO.* December 1963.

DODD 5160.54. *DOD Key Assets Protection Program.* June 1989.

DODD 5200.8. *Security of Military Installations and Resources.* April 1991.

DODD 5210.56. *Use of Deadly Force and the Carrying of Firearms by DOD Personnel Engaged in Law Enforcement and Security Duties.* February 1992.

DODD 5240.1. *DOD Intelligence Activities.* April 1988.

DODD 5240.1 R. *Procedures Governing Activities of DOD Intelligence Components that Affect United States Persons.* December 1982.

DOD 5500.7-R. *DOD Ethics Program Regulation.* May 1987.

DODD 5525.5. *DOD Cooperation With Civilian Law Enforcement Officials.* January 1986.

DODD 6055.13. *Transportation Accident Prevention and Emergency Response Involving Conventional DOD Munitions and Explosives.* May 1988.

DODR 4500.43-R. *Operation Support Airlift Regulation.* October 1985.

DODR 4515.13-R. *Air Transportation Eligibility Regulation.* January 1980.

DOD Civil Disturbance Plan. *GARDEN PLOT.*



## **JOINT PUBLICATIONS**

- JP 1-03. *Joint Reporting Structure*. November 1983.
- JP 1-03.6. *JRS, Event/Incident Reports*. April 1981.
- JP 1-03.8. *JRS, Situation Monitoring*. February 1988.
- JP 1-03.17. *JRS, Personnel*. (In development).
- JP 1-03.18. *JRS, Logistics*. March 1990.
- JP 1-03.25. *JRS, Aerial Ports and Air Operations Bases*. (In revision).
- JP 1-03.26. *JRS, Port Characteristics Report*. (In revision).
- JP 3-0. *Doctrine for Joint Operations*. (In development).
- JP 3-00.1. *Joint Doctrine for Contingency Operations*. (In development).
- JP 3-07. *Joint Operations Other Than War*. (In development).
- JP 3-07.2. *Joint Tactics, Techniques, and Procedures for Antiterrorism*. (In development).
- JP 3-07.3. *Joint Tactics, Techniques, and Procedures for Peacekeeping Operations*. (In development).
- JP 3-07.4. *Joint Doctrine and Joint Tactics, Techniques, and Procedures for Counter-Drug Operations*.  
(In development).
- JP 3-50.1. *National Search and Rescue Manual*. February 1991.
- JP 3-53. *Doctrine for Joint Psychological Operations*. (In revision).
- JP 3-57. *Doctrine for Joint Civil Affairs*. (In development).
- JP 4-01.3. *Joint Tactics, Techniques, and Procedures for Movement Control*. (In development).
- JP 4-02. *Doctrine for Health Service Support in Joint Operations*. (In development).
- JP4-05. *Mobilization*. (In revision).
- JP 4-06. *Joint Tactics, Techniques, and Procedures for Mortuary Affairs in Joint Operations*. (In development).
- JP 5-00.2. *Joint Task Force Planning Guidance and Procedures*. September 1991.

## **ARMY PUBLICATIONS**

### **Army Regulations**

- AR 1-4. *Employment of DA Resources in Support of the US Secret Service*. October 1979.
- AR 11-2. *Internal Control Systems*. September 1990.
- AR 15-1. *Committee Management*. June 1978.
- AR 15-13. *Subsistence Review Committee*. December 1975.
- AR 30-1. *The Army Food Service Program*. January 1985.
- AR 30-5. *Food Cost and Feeding Strength Summary*. November 1985.

- AR 30-7. *Operational Rations, Health and Comfort Items*. March 1979.
- AR 30-16. *Food Service Data Feedback Program*. April 1988.
- AR 30-18. *Army Troop Issue Subsistence Activity Operating Procedures*. September 1984.
- AR 30-21. *The Army Field Feeding System*. September 1990.
- AR 37-1. *Army Accounting and Fund Control*. April 1991.
- AR 40-3. *Medical, Dental and Veterinary Care*. February 1985.
- AR 40-5. *Preventive Medicine*. June 1985.
- AR 40-61. *Medical Logistics Policies and Procedures*. October 1988.
- AR 71 -13. *DA Equipment Authorization and Usage Program*. January 1988.
- AR 75-15. *Responsibilities and Procedures for Explosive Ordnance Disposal*. November 1978.
- AR 95-1. *Army Aviation: Flight Regulations*. May 1990.
- AR 95-3. *Aviation: General Provisions, Training, Standardization, and Resource Management*.  
September 1990.
- AR 130-5. *National Guard Bureau Organization and Functions*. October 1983.
- AR 190-10. *Threats to the President and Other Government Officials*. June 1987.
- AR 190-14. *Carrying of Firearms and Use of Force by Law Enforcement and Security Duties*.  
September 1988.
- AR 190-40. *Serious Incident Report*. September 1981.
- AR 200-1. *Environmental Protection and Enhancement*. April 1990.
- AR 310-49. *The Army Authorization Documents System*. December 1980.
- AR 340-21. *The Army Privacy Program*. July 1985.
- AR 350-7. *Training and Evaluation of Forces for Civil Disturbances*. February 1973.
- AR 360-61. *Community Relations*. October 1980.
- AR 360-80. *Release of Information When More Than One Service is Involved in Accidents or Incidents*.  
August 1961.
- AR 360-81. *Command Information Program*. October 1989.
- AR 381-10. *US Army Intelligence Activities*. July 1984.
- AR 381-20. *US Army Counterintelligence Activities*. September 1986.
- AR 405-80. *Granting Use of Real Estate*. February 1979.
- AR 500-1. *Aircraft Piracy Emergencies*. October 1972.
- AR 500-2. *Search and Rescue (SAR) Operations*. January 1980.
- AR 500-4. *Military Assistance to Safety and Traffic*. January 1982.
- AR 500-5. *The Army Mobilization and Operations Training System (AMOPS)*. June 1986.
- AR 500-50. *Civil Disturbances*. April 1972.
- AR 500-51. *Emergency Employment of Army and Other Resources Support to Civilian Law Enforcement*.  
July 1973.

- AR 500-60. *Disaster Relief*. August 1981.
- AR 500-70. *Military Support of Civil Defense*. October 1982.
- AR 525-13. *Combatting Terrorism*. June 1993.
- AR 600-20. *Command Policy*. March 1988.
- AR 600-38. *The Meal Card Management System*. March 1988.
- AR 700-131. *Loan of Army Material*. September 1987.
- DA Pamphlet 27-21. *Administrative and Civil Law Handbook*. March 1992.
- DA Pamphlet 360-3. *Army Hometown News Program*. August 1984.
- FM 5-114. *Engineer Operations Short of War*. 13 July 1992.
- FM 8-10. *Health Service Support in Theater of Operations*. March 1991.
- FM 8-10-6. *Medical Evacuation in a Theater of Operations—Tactics, Techniques, and Procedures*.  
October 1991.
- FM 8-33. *Control of Communicable Diseases in Man*. May 1991.
- FM 8-55. *Planning for Health Service Support*. February 1985.
- FM 8-250. *Preventive Medicine Specialist*. January 1986.
- FM 8-285. *Treatment of Chemical Agent Casualties and Conventional Chemical Injuries*. February 1990.
- FM 9-15. *Explosive Ordnance Disposal Service and Unit Operations*. March 1987.
- FM 10-23. *Basic Doctrine for Army Field Feeding*. December 1991.
- FM 10-23-1. *Commander's Guide to Food Service Operations*. March 1992.
- FM 10-23-2. *Tactics, Techniques, and Procedures for Garrison Food Preparation and Class I Operations Management*. March 1992.
- FM 16-1. *Religious Support Doctrine*. November 1989.
- FM 19-15. *Civil Disturbances*. November 1985.
- FM 21-10. *Field Hygiene and Sanitation*. November 1988.
- FM 25-100. *Training the Force*. November 1988.
- FM 31-20. *Doctrine for Special Forces*. April 1990.
- FM 33-1. *Psychological Operations*. June 1989.
- FM 34-1. *Intelligence and Electronic Warfare Operations*. July 1987.
- FM 34-130. *Intelligence Preparation of the Battlefield*. May 1989.
- FM 41-10. *Civil Affairs Operations*. December 1985.
- FM 46-1. *Public Affairs Operations*. July 1992.
- FM 55-10. *Movement Control in a Theater of Operations*. July 1986.
- FM 100-5. *Operations*. June 1993.
- FM 100-25. *Doctrine for Army SOF*. December 1991.

- NGB Regulation 350-2. *Reserve Component Training*. May 1989.
- NGB Pamphlet 95-5. *Use of Army National Guard Aircraft*. November 1984.
- NGB Pamphlet 360-5/ANGP 190-9. *National Guard Public Affairs Guidelines*. May 1978.
- NGB Study. *Military Support to Civil Authorities for Continuance of Vital Public Services*. FY 79-1.
- NGB Study. *Terrorism and Hazardous Material Incidents*. August 1980.
- NGR 10-2. *State Area Command, Army National Guard*. November 1992.
- NGR 350-1. *Army National Guard Training*. June 1991.
- NGR 500-1. *Military Support to Civil Authorities*. October 1991.
- NGR 600-85. *Drug Abuse Prevention and Control*. March 1990.
- TC 19-6. *Countering Terrorism*. October 1991.

### **OTHER MILITARY PUBLICATIONS**

- AFR 55-3. *Operations*. December 1990.
- AFR 208-1. *Federal Tort Claims Act*. June 1987.
- AFR 355-1. *Disaster Preparedness Planning and Operation*. December 1989.
- ANGR 23-01. *State Air National Guard Headquarters*. August 1983.
- ANGR 35-03. *Full-Time Military Duty Personnel Program-Air National Guard*. June 1989.
- ANGR 55-03. *Operations Event/Incident Report*. December 1990.
- ANGR 67-1. *Loan/Use of Air National Guard Property*. July 1988.
- ANGR 355-1. *Planning and Operations*. December 1989.



[RDL](#)

[Document](#)

[Download](#)

[Homepage](#) [Information](#) [Instructions](#)

---

\*FM 3-19.40 (FM 19-40)

**Field Manual**  
**No. FM 3-19.40**

**Headquarters**  
**Department of the Army**  
**Washington, DC, 1 August 2001**

# FM 3-19.40

# MILITARY POLICE INTERNMENT/RESETTLEMENT OPERATIONS

## *Table of Contents*

---

### PREFACE

### PART ONE

### FUNDAMENTALS OF INTERNMENT/RESETTLEMENT OPERATIONS

### Chapter 1

### INTRODUCTION

[Procedures](#)

[Definitions](#)

[Objectives](#)

[Agencies](#)

[Protection of Captives and Detainees](#)

[Protection of Enemy Prisoners of War and Civilian Internees](#)

[Protection of Refugees](#)

**Chapter 2**

**COMMANDER AND STAFF RESPONSIBILITIES**

**Section I — Commanders**

[Procedures](#)

[Principles and Policies](#)

[Security](#)

**Section II — Staff Officers**

[Adjutant General](#)

[Finance Officer](#)

[Civil-Military Operations Officer](#)

[Chaplain](#)

[Engineer Officer](#)

[Public Affairs Officer](#)

[Signal Officer](#)

[Staff Judge Advocate](#)

[Medical Operations](#)

[Movement Control Officer](#)

[Inspector General](#)

[Psychological Operations](#)

[\*\*Section III — Training\*\*](#)

[\*\*PART TWO\*\*](#)

[\*\*ENEMY PRISONERS OF WAR AND CIVILIAN INTERNEES\*\*](#)

[\*\*Chapter 3\*\*](#)

[\*\*DIVISION COLLECTING POINTS AND CORPS HOLDING AREAS\*\*](#)

[Overview](#)

[Processing Captives](#)

[Evacuating Captives](#)

[Division Collecting Points](#)

[Corps Holding Areas](#)

[Collocated Screening Sites](#)

[Collecting Points in Other Operations](#)

[\*\*Chapter 4\*\*](#)

[\*\*ENEMY PRISONERS OF WAR\*\*](#)

[Evacuation](#)

[Receiving and Processing Areas](#)

[Assignment to Internment Facilities](#)

[Control and Discipline](#)

[Clothing](#)

[Subsistence](#)

[Medical and Sanitation Considerations](#)

[Correspondence](#)

[Canteens](#)

[Social Programs](#)

[Security](#)

**Chapter 5**      **CIVILIAN INTERNEES**

General Protection

Administrative Responsibilities

Principles and Policies

Clothing

Subsistence

Receiving and Processing Areas

Control and Discipline

Internee Committee

Correspondence

Complaints and Requests

Medical Treatment

Sanitation

Transfer

Release

Social Programs

Employment

Security

Disturbances

Facility Markings

**Chapter 6**      **INTERNMENT/RESETTLEMENT FACILITIES**

Planning

Security Requirements



[Layout](#)

[Receiving and Processing Centers](#)

[Medical and Sanitation Considerations](#)

**PART THREE UNITED STATES MILITARY PRISONERS**

**Chapter 7 ARMY CORRECTIONS SYSTEM**

[Levels of Confinement](#)

[Correctional Facilities](#)

[Legal Rights and Requirements](#)

[Segregation](#)

[Custody and Control](#)

[Correctional-Treatment Programs](#)

[Employment and Education](#)

[Recreation](#)

[Compensation, Clemency, and Parole](#)

[Correctional Staff](#)

[Prisoner Services Branch](#)

[Personal Property and Funds](#)

[Mail and Correspondence](#)

[Support Personnel](#)

[Transfer and Disposition Procedures](#)

[Logistics](#)

[Medical and Dental Treatment](#)

**Chapter 8 BATTLEFIELD CONFINEMENT OF UNITED STATES MILITARY PRISONERS**

[Planning](#)

[Field Detention Facility](#)

[Field Confinement Facility](#)

[Transfer and Disposition of Prisoners](#)

**PART FOUR**      **MILITARY POLICE SUPPORT TO CIVIL-MILITARY OPERATIONS**

**Chapter 9**      **POPULACE AND RESOURCE CONTROL**

[Dislocated-Civilian Operations](#)

[Planning Dislocated-Civilian Operations](#)

[Military Police Support to Dislocated-Civilian Operations](#)

**Chapter 10**      **HUMANITARIAN ASSISTANCE AND EMERGENCY SERVICES**

[Section I - Humanitarian Assistance](#)

[Operational Environment](#)

[Rules of Engagement](#)

[Legal Considerations](#)

[Military Police Support](#)

[Section II - Emergency Services](#)

[In Continental United States](#)

[Outside Continental United States](#)

**Appendix A**      **METRIC CONVERSIONS**

**Appendix B**      **USE OF FORCE AND RIOT CONTROL MEASURES**

[Use of Force](#)

[Deadly Force](#)

[Rules of Engagement](#)

[Nonlethal Weapons](#)

[Crowd Dynamics](#)

[Riot Control Measures](#)

[Riot Control Agents](#)

[Positions](#)

[Formations](#)

[Appendix C](#) [\*\*EQUIPMENT GUIDE\*\*](#)

[Appendix D](#) [\*\*MILITARY POLICE INTERNMENT/RESETTLEMENT UNITS\*\*](#)

[\*\*GLOSSARY\*\*](#)

[\*\*BIBLIOGRAPHY\*\*](#)

[\*\*AUTHENTICATION\*\*](#)

**DISTRIBUTION RESTRICTION:** Approved for public release: distribution is unlimited

---

\*This publication supersedes FM 19-40, 27 February 1976, and FM 19-60, 27 May 1986.

# **FM 3-19.40**

**(formerly FM 19-40)**

**Military Police**

# **Internment/ Resettlement Operations**

**Headquarters,  
Department of the Army**

DISTRIBUTION RESTRICTION: Approved for public release; distribution is unlimited.

# Military Police Internment/Resettlement Operations

## Contents

	Page
PREFACE .....	v
<b>PART ONE FUNDAMENTALS OF INTERNMENT/RESETTLEMENT OPERATIONS</b>	
<b>Chapter 1 INTRODUCTION .....</b>	<b>1-1</b>
Procedures.....	1-1
Definitions .....	1-2
Objectives .....	1-5
Agencies .....	1-6
Protection of Captives and Detainees.....	1-11
Protection of Enemy Prisoners of War and Civilian Internees .....	1-12
Protection of Refugees.....	1-13
<b>Chapter 2 COMMANDER AND STAFF RESPONSIBILITIES .....</b>	<b>2-1</b>
<b>Section I - Commanders</b> .....	<b>2-1</b>
Procedures.....	2-1
Principles and Policies .....	2-2
Security .....	2-5
<b>Section II - Staff Officers</b> .....	<b>2-9</b>
Adjutant General .....	2-9
Finance Officer.....	2-9
Civil-Military Operations Officer.....	2-9
Chaplain .....	2-10
Engineer Officer .....	2-10
Public Affairs Officer.....	2-10
Signal Officer.....	2-10
Staff Judge Advocate .....	2-10
Medical Operations .....	2-11

**Distribution Restriction:** Approved for public release; distribution is unlimited.

\*This publication supersedes FM 19-40, 27 February 1976, and FM 19-60, 27 May 1986.

	Page
Movement Control Officer.....	2-12
Inspector General.....	2-12
Psychological Operations.....	2-12
<b>Section III - Training</b> .....	<b>2-13</b>
<b>PART TWO ENEMY PRISONERS OF WAR AND CIVILIAN INTERNEES</b>	
<b>Chapter 3 DIVISION COLLECTING POINTS AND CORPS HOLDING AREAS</b> .....	<b>3-1</b>
Overview.....	3-1
Processing Captives.....	3-2
Evacuating Captives.....	3-8
Division Collecting Points.....	3-10
Corps Holding Areas.....	3-15
Collocated Screening Sites.....	3-17
Collecting Points in Other Operations.....	3-18
<b>Chapter 4 ENEMY PRISONERS OF WAR</b> .....	<b>4-1</b>
Evacuation.....	4-1
Receiving and Processing Areas.....	4-1
Assignment to Internment Facilities.....	4-9
Control and Discipline.....	4-12
Clothing.....	4-15
Subsistence.....	4-17
Medical and Sanitation Considerations.....	4-17
Correspondence.....	4-17
Canteens.....	4-18
Social Programs.....	4-18
Security.....	4-21
<b>Chapter 5 CIVILIAN INTERNEES</b> .....	<b>5-1</b>
General Protection.....	5-1
Administrative Responsibilities.....	5-2
Principles and Policies.....	5-3
Clothing.....	5-5
Subsistence.....	5-5
Receiving and Processing Areas.....	5-6
Control and Discipline.....	5-10
Internee Committee.....	5-12
Correspondence.....	5-13
Complaints and Requests.....	5-13
Medical Treatment.....	5-13
Sanitation.....	5-13
Transfer.....	5-14
Release.....	5-15
Social Programs.....	5-15
Employment.....	5-16
Security.....	5-17
Disturbances.....	5-18
Facility Markings.....	5-18

	Page
<b>Chapter 6</b>	
<b>INTERNMENT/RESETTLEMENT FACILITIES</b> .....	6-1
Planning .....	6-1
Security Requirements .....	6-2
Layout .....	6-3
Receiving and Processing Centers .....	6-5
Medical and Sanitation Considerations .....	6-7

**PART THREE UNITED STATES MILITARY PRISONERS**

<b>Chapter 7</b>	
<b>ARMY CORRECTIONS SYSTEM</b> .....	7-1
Levels of Confinement .....	7-1
Correctional Facilities .....	7-3
Legal Rights and Requirements .....	7-3
Segregation .....	7-4
Custody and Control .....	7-5
Correctional-Treatment Programs .....	7-8
Employment and Education .....	7-10
Recreation .....	7-10
Compensation, Clemency, and Parole .....	7-11
Correctional Staff .....	7-12
Prisoner Services Branch .....	7-16
Personal Property and Funds .....	7-18
Mail and Correspondence .....	7-19
Support Personnel .....	7-20
Transfer and Disposition Procedures .....	7-21
Logistics .....	7-22
Medical and Dental Treatment .....	7-23
<b>Chapter 8</b>	
<b>BATTLEFIELD CONFINEMENT OF UNITED STATES MILITARY PRISONERS</b> .	8-1
Planning .....	8-1
Field Detention Facility .....	8-3
Field Confinement Facility .....	8-3
Transfer and Disposition of Prisoners .....	8-19

**PART FOUR MILITARY POLICE SUPPORT TO CIVIL-MILITARY OPERATIONS**

<b>Chapter 9</b>	
<b>POPULACE AND RESOURCE CONTROL</b> .....	9-1
Dislocated-Civilian Operations .....	9-2
Planning Dislocated-Civilian Operations .....	9-3
Military Police Support to Dislocated-Civilian Operations .....	9-7
<b>Chapter 10</b>	
<b>HUMANITARIAN ASSISTANCE AND EMERGENCY SERVICES</b> .....	10-1
<b>Section I - Humanitarian Assistance</b> .....	10-1
Operational Environment .....	10-1
Rules of Engagement .....	10-3
Legal Considerations .....	10-3
Military Police Support .....	10-4

	Page
<b>Section II - Emergency Services</b> .....	10-14
In Continental United States .....	10-14
Outside Continental United States .....	10-17
<b>Appendix A METRIC CONVERSIONS</b> .....	A-1
<b>Appendix B USE OF FORCE AND RIOT CONTROL MEASURES</b> .....	B-1
Use of Force .....	B-1
Deadly Force .....	B-1
Rules of Engagement .....	B-2
Nonlethal Weapons .....	B-3
Crowd Dynamics .....	B-6
Riot Control Measures .....	B-9
Riot Control Agents .....	B-11
Positions .....	B-14
Formations.....	B-16
<b>Appendix C EQUIPMENT GUIDE</b> .....	C-1
<b>Appendix D MILITARY POLICE INTERNMENT/RESETTLEMENT UNITS</b> .....	D-1
<b>GLOSSARY</b> .....	Glossary-1
<b>BIBLIOGRAPHY</b> .....	Bibliography-1
<b>INDEX</b> .....	Index-1



## Preface

In 1996, the United States (US) Army Military Police (MP) Corps restructured its four combat support (CS) missions into the following five CS functions. These functions adequately describe MP capabilities in support of US forces deployed worldwide.

- Maneuver and mobility support.
- Area security.
- Law and order (L&O).
- Internment/resettlement (I/R).
- Police intelligence operations.

Field Manual (FM) 3-19.40 depicts the doctrinal foundation, principles, and processes that MP will employ when dealing with enemy prisoners of war (EPWs), civilian internees (CIs), US military prisoner operations, and MP support to civil-military operations (populace and resource control [PRC], humanitarian assistance [HA], and emergency services [ES]). FM 3-19.40 is not a standalone manual, and it must be used in combination with other publications. These publications are pointed out throughout the manual, and a consolidated list is provided in the bibliography.

This manual provides guidance that can be used by US Army service schools, students, sister services, and federal agencies. It is fully compatible with current joint, multinational, and interagency doctrine.

The proponent of this publication is HQ TRADOC. Send comments and recommendations on Department of the Army (DA) Form 2028 directly to Commandant, US Army Military Police School, ATTN: ATSJ-MP-TD, 401 MANSCEN Loop, Suite 2060, Fort Leonard Wood, Missouri 65473-8926.

This publication implements Standardization Agreement (STANAG) 2044, Procedures for Dealing With Prisoners of War (PW) (Edition 5), 28 June 1994. **NOTE: The DA term EPW is interchangeable with the term PW used in STANAG 2044. The DA uses the term PW when referring to US soldiers who are prisoners of the enemy and uses the term EPW when referring to enemy soldiers who are prisoners of the US.**

Appendix A contains a metric conversion chart.

Unless this publication states otherwise, masculine nouns and pronouns do not refer exclusively to men.

## PART ONE

# Fundamentals of Internment/Resettlement Operations

Part One provides information that is critical in understanding the I/R function. Chapter 1 introduces the manual by providing key definitions, establishing the I/R objectives and principles, and providing a list of agencies concerned with I/R operations. Chapter 2 describes commander and staff responsibilities that are unique to I/R operations. Together, these chapters provide leaders and soldiers with the foundation necessary for successful implementation of national military objectives as they relate to I/R operations.

---

## Chapter 1

### Introduction

This chapter provides key definitions as set forth by the Geneva and Hague Conventions, Army regulations (ARs), and the Uniform Code of Military Justice (UCMJ). These definitions explain personnel categories that the MP commander may be tasked to handle, protect, and account for. He must ensure that personnel are treated according to established laws, regulations, and international agreements. The MP leaders and soldiers conducting I/R operations must maintain task proficiency for each category.

### PROCEDURES

1-1. Unlike EPW/CI operations in the past, I/R operations include additional detained persons. The I/R operations include handling, protecting, and accounting for dislocated civilians (DCs) and conducting battlefield confinement of US military prisoners. With the alignment of these additional categories, leaders and soldiers must ensure that they understand and are prepared to apply the rules of engagement (ROE) and the rules of interaction (ROI) that apply to each category. The keys to a successful I/R operation are getting the mission accomplished and performing the mission under the correct mind-set. For example, the ROE that may apply to an EPW may not apply to a refugee or a US military prisoner. However, an MP may be tasked to handle each category during the course of an operation. This dimension is addressed throughout the manual to increase the MP commander's situational awareness (SA) as it relates to this aspect of I/R operations.

## DEFINITIONS

1-2. The following terms are defined below:

- Combat zone (CZ).
- EPW.
- CI.
- Retained person (RP).
- Other detainee (OD).
- DC.
  - Displaced person (DP).
  - Refugee.
  - Evacuee.
  - Stateless person.
  - War victim.
  - Migrant.
  - Internally displaced person (IDP).
  - Expellee.
- US military prisoner.

## COMBAT ZONE

1-3. The CZ is the area required by combat forces to conduct operations. It normally extends forward from the land force's rear boundary. The communications zone (COMMZ) is the rear part of the theater of operations (TO). It is behind and contiguous to the CZ. The COMMZ contains lines of communication (LOC), supply and evacuation areas, and other agencies required for the immediate support and maintenance of field forces. It reaches to the continental United States (CONUS), to a supporting combatant command's area of responsibility (AOR), or to both. An EPW must be moved as quickly as possible from the CZ to the COMMZ where an I/R unit interns him.

**NOTE: For a complete discussion on the operational framework of a CZ, see FM 3-0.**

## ENEMY PRISONER OF WAR

1-4. As defined in the Geneva Convention Relative to the Treatment of Prisoners of War (GPW), 12 August 1949, an EPW is—

- A member of an enemy armed force or a member of a militia or a volunteer corps forming part of an enemy armed force.
- A member of a militia or a volunteer corps (including an organized resistance movement) that (1) belongs to an enemy power, (2) operates in or outside its own territory (even if the territory is occupied), and (3) fulfills the following conditions:
  - The organization is commanded by a person responsible for his subordinates.
  - The organization has a fixed, distinctive sign that is recognizable at a distance.
  - The members are carrying arms openly.

- The organization is conducting operations according to the laws and customs of war.
- A member of an enemy armed force who professes allegiance to a government or an authority not recognized by the detaining power (the US).
- A person who accompanies an enemy armed force without actually being a member (a civilian member of a military aircraft crew, a war correspondent, a supply contractor, a member of a labor unit, or a member of a service that is responsible for enemy welfare) if he has authorization and an identification (ID) card from the armed force.
- A crew member (a master, a pilot, or an apprentice of a merchant marine or a member of a civil aircraft under the enemy's power) who does not benefit from more favorable treatment under other provisions of international law.
- Inhabitants of an unoccupied territory who spontaneously take up arms to resist invading US armed forces (without having time to form themselves into a regular armed unit) if they carry arms openly and respect the laws and customs of war.

1-5. The following persons are treated as EPWs:

- A person who qualifies for EPW status under paragraph 1-4 (if the US is a party to the conflict) and falls into the hands of the US as a neutral or nonbelligerent power.
- A person belonging to or having belonged to an armed force of a country occupied by the US (if the US considers it necessary by reason of such allegiance to intern him) even though he may have been originally liberated from EPW status by the US while hostilities were going on outside the occupied territory. Particular application is made to a person who has made an unsuccessful attempt to join an armed force that is engaged in combat or who has failed to comply with a summons for internment.

1-6. Captured enemy personnel are presumed to be EPWs immediately upon capture if the circumstances are unmistakable (armed, uniformed enemy). If questions arise as to whether captured personnel belong in the EPW category, they receive the same treatment as EPWs until their status is determined by a competent military tribunal according to AR 190-8.

### **CIVILIAN INTERNEE**

1-7. A CI is a person who is interned during armed conflict or occupation if he is considered a security risk or if he needs protection because he committed an offense (insurgent, criminal) against the detaining power. A CI is protected according to the Geneva Convention Relative to the Protection of Civilian Persons in Time of War (GC), 12 August 1949.

### **RETAINED PERSON**

1-8. An RP is an enemy who falls within one of the following categories:

- A person who is a member of the medical service of an enemy armed force.

- A medical person exclusively engaged in—
  - Searching, collecting, transporting, or treating wounded or sick personnel.
  - Preventing disease.
  - Administering a medical unit or establishment.
- A chaplain attached to an enemy armed force.
- A member of the International Federation of Red Cross and Red Crescent Societies (IFRC) or another voluntary aid organization. The organization must be duly recognized and authorized by its government. The staff may be employed in the same duties as medical personnel if the organization is subject to military laws and regulations.

1-9. An RP is a special category for medical personnel and chaplains because of their special skills and training. They may be retained by the detaining power (see FM 27-10) to aid EPWs, preferably those of the armed force to which the RP belongs. Per the Geneva Conventions, RPs receive the same benefits and protection as EPWs. The following privileges and considerations are extended to RPs due to their professions:

- Correspondence privileges that are over and above those afforded to EPWs.
- Facilities to provide medical care, spiritual assistance, and welfare services to EPWs.
- Transportation for periodic visits to EPW branch I/R facilities and hospitals outside the EPW I/R facility to carry out medical, spiritual, and welfare duties.
- Work assignments that are restricted to medical and religious duties they are qualified to perform.
- Quarters that are separate from EPW quarters when practicable.

**NOTE: For a complete discussion on RPs, see AR 190-8.**

## **OTHER DETAINEE**

1-10. A person in the custody of US armed forces who has not been classified as an EPW (Article 4, GPW), an RP (Article 33, GPW), or a CI (Article 78, GC) is treated as an EPW until a legal status is ascertained by competent authority.

## **DISLOCATED CIVILIAN**

1-11. A DC is a civilian who left his home for various reasons. His movement and physical presence can hinder military operations. He most likely requires some degree of aid (medicine, food, shelter, or clothing). A DC may not be native to the area (local populace) or to the country where he resides. A DC is a generic term that is further subdivided into the following categories:

- **DP.** A DP has been dislocated because of war, a natural disaster, or political/economic turmoil. Consequently, the motivation for civilians to flee and their status under international and domestic laws vary, as does the degree of assistance required and the location for relief

operations. Likewise, the political, geographical, environmental, and threat situations also vary.

- **Refugee.** The Geneva Convention Relative to the Status of Refugees (1951) states that a refugee is a person who “owing to a well-founded fear of being persecuted for reasons of race, religion, nationality, membership in a particular social group, or political opinion, is outside the country of his nationality, and is unable to or, owing to such fear, is unwilling to avail himself of the protection of that country.”
- **Evacuee.** An evacuee is a civilian who is removed from his place of residence by military direction because of personal security or other requirements of the military situation.
- **Stateless person.** A stateless person is a civilian who has been denationalized, whose country of origin cannot be determined, or who cannot establish his right to nationality claimed.
- **War victim.** A war victim is a civilian who suffered an injury, a loss of a family member, or damage to or destruction of his home because of war.
- **Migrant.** A migrant is a worker who moves from one region to another by chance, instinct, or plan.
- **IDP.** An IDP may have been forced to flee his home for the same reasons as a refugee, but he has not crossed an internationally recognized border.
- **Expellee.** An expellee is a civilian who is outside the boundaries of his country of nationality or ethnic origin and is being forcibly repatriated to that country or a third country for political or other purposes.

## UNITED STATES MILITARY PRISONER

1-12. A US military prisoner is sentenced by a court-martial to confinement or death and ordered into confinement by competent authority, whether or not the sentence has been approved by the convening authority. A person placed into confinement by competent authority pending trial by court-martial is a pretrial prisoner or a pretrial detainee.

## OBJECTIVES

1-13. The objectives of I/R operations are to process, handle, care for, account for, and secure—

- EPWs.
- CIs.
- RPs.
- ODs
- DCs.
- US military prisoners.

1-14. The principles employed to achieve the objectives are according to the Hague Convention (1907), the Geneva Conventions (1949), the Geneva Convention Relative to the Status of Refugees (1951) and its protocol (1967), and current STANAGs. These principles include—

- Humane treatment and efficient care.
- Prompt evacuation from the CZ.
- Provisions for captive or detainee interrogation.
- Procedures for evacuation, control, and administration of internees with other CS and combat service support (CSS) operations.

**NOTE: The principles employed for US military prisoners are outlined in AR 190-47 and Department of Defense (DOD) Directive 1325.4.**

## **AGENCIES**

1-15. The expanded MP functions of I/R involve certain international and domestic organizations not previously considered during MP operations. There are numerous private relief organizations, foreign and domestic, that are involved in humanitarian relief and I/R operations. Likewise, the media normally provides extensive coverage of I/R operations. In many instances, the DOD will not be the lead agency in I/R operations, which adds to the complexity. For instance, the DOD could be tasked in a supporting role, with the Department of State (DOS) or another agency in the lead.

## **DEPARTMENT OF DEFENSE**

1-16. Under the Geneva Conventions and subsequent protocols, a capturing power is responsible for proper and humane treatment of detainees from the moment of capture or other apprehension. The Secretary of the Army is the executive agent for DOD I/R operations and administration. He is responsible for plans, policy development, and operational coordination for persons captured and interned by US armed forces. Navy, Marine, and Air Force units that detain or capture persons turn them over to the Army at designated receiving points after initial classification and administrative processing.

1-17. Per DOD Directive 3025.1, the Secretary of the Army tasks DOD components to plan and commit DOD resources in response to requests for military support from civil authorities. The Director of Military Support (DOMS) provides leadership in this effort.

1-18. Examples of DOD decision makers are the Under Secretary of Defense (USD) for Policy and the Deputy Assistant Secretary of Defense (DASD) for Humanitarian and Refugee Affairs (H&RA). The USD for Policy develops and administers military policies and programs for international HA and foreign relief operations. The DASD for H&RA executes the policies and tasks the services accordingly.

## **DEPARTMENT OF STATE**

1-19. The DOS is organized into functional and regional bureaus. It represents the US via embassies throughout the world.

## **FEDERAL EMERGENCY MANAGEMENT AGENCY**

1-20. Per the Stafford Act, the federal government responds to disasters and emergencies to save lives and protect public health, safety, and property. The

Federal Emergency Management Agency (FEMA) is responsible for the nation's emergency management system. Local and state programs are the heart of the nation's emergency management system, and most disasters are handled by local and state governments. When devastations are especially serious and exceed local and state capabilities and resources, states turn to the federal government for help.

1-21. When the President declares a major disaster, FEMA coordinates response activities for federal agencies that may participate. The agencies help states and localities recover from disasters by providing services, resources, and personnel. They transport food and potable water, provide medical aid, assist with temporary housing, and furnish generators for hospitals and other essential facilities. The FEMA also works with states and territories during nondisaster periods to plan for disasters, develop mitigation programs, and anticipate requirements.

1-22. The Federal Response Plan addresses the consequences of disasters and emergencies. It applies to natural disasters (earthquakes, hurricanes, typhoons, tornadoes, and volcanic eruptions), technological emergencies (radiological and hazardous material [HM] releases), and other incidents. The plan describes the basic mechanisms and structures to mobilize resources and conduct activities that augment state and local efforts. It uses a functional approach to group the types of federal assistance that a state is most likely to need under emergency support functions (ESFs). Each ESF is headed by a primary agency based on its authorities, resources, and capabilities in the functional area. The ESFs are the primary mechanisms through which federal assistance is provided. Federal assistance is provided to affected states under the overall coordination of a federal coordinating officer, who is appointed by the FEMA director on behalf of the President.

## MISCELLANEOUS AGENCIES

1-23. Other federal agencies provide advice, assistance, and resources to plan, implement, and accomplish I/R operations. They are the—

- **Department of Transportation (DOT).** Its technical capabilities and expertise in public transportation are available to assist in specific operations.
- **United States Department of Agriculture (USDA).** It has projects and activities ongoing in foreign countries and provides technical assistance and expertise.
- **United States Agency for International Development (USAID).** Although not directly under the control of DOS, USAID coordinates activities at the department and country levels within the federal government.
- **Office of Foreign Disaster Assistance (OFDA).** It provides prompt nonmilitary assistance to alleviate death and suffering of foreign disaster victims. The OFDA may request DOD assistance for I/R operations. The coordination and determination of forces required is normally accomplished through DOD and the joint task force (JTF).
- **United States Information Agency (USIA).** The USIA helps achieve US objectives by influencing public attitudes overseas. It



advises the US government on the possible impacts of policies, programs, and official statements on foreign opinions. The USIA helps HA forces gain popular support and counters attempts to distort and frustrate US and JTF objectives.

- **Department of Justice (DOJ).** The I/R forces may contact the DOJ Community Relations Service for assistance in domestic HA operations. It provides on-site resolution assistance through a field staff of mediators and negotiators.
- **Public Health Service (PHS).** It promotes protection and advancement of the nation's physical and mental health. The US forces work with the PHS during refugee operations in and near the US and its territories.
- **Immigration and Naturalization Service (INS).** It provides information and services to the public while enforcing immigration control. The INS is essential for processing and settling migrants and refugees in the US and its territories.

## CIVILIAN ORGANIZATIONS

1-24. Civilian organizations are responsible for a wide range of activities encompassing HA; human rights; the protection of minorities, refugees, and DPs; legal assistance; medical care; reconstruction; agriculture; education; arts; science; and project funding. The commander must understand the mandate, role, structure method, and principles of civilian organizations. Without this understanding, it is impossible to establish an effective relationship with them.

1-25. These organizations may already be in the area of operations (AO), providing HA or some type of relief when I/R operations are planned and implemented. The principle coordinating federal agency is the USAID, and civilian organizations are required to register with the USAID to operate under US auspices.

### Types of Civilian Organizations

1-26. There are three principle types of civilian organizations:

- **International organization (IO).** An IO is established by intergovernmental agreements and operates at the international level. Examples of IOs include the—
  - United Nations (UN).
  - United Nations High Commissioner for Refugees (UNHCR).
  - United Nations Development Program (UNDP).
  - United Nations Office for the Coordination of Humanitarian Affairs (UNOCHA).
  - World Food Program (WFP).
  - International Medical Corps (IMC).
- **Nongovernmental organization (NGO).** An NGO is a voluntary organization that is not funded by a government. It is primarily a nonprofit organization that is independent of a government, an IO, or

a commercial interest. It is legally different than an IO because it writes its own charter and mission.

The NGOs are increasingly numerous and sophisticated, and they can number in the hundreds in any conflict. They remain strongly independent from political control to preserve their independence and effectiveness. In many cases, their impartiality has been of great benefit, forming the only available means of rebuilding relations when political dialog has broken down. They are often highly professional in their field and extremely well motivated and prepared to take physical risks in appalling conditions. Examples of NGOs include the—

- Save the Children Foundation (SCF).
- Médecin Sans Frontières (Doctors Without Borders) (MSF).
- Catholic Relief Services (CRS).
- National Council of Catholic Bishops (NCCB).

An NGO is mandated or nonmandated:

- **Mandated.** A mandated NGO has been officially recognized by the lead IO in a crisis and has been authorized to work in the affected area.
- **Nonmandated.** A nonmandated NGO has no official recognition or authorization and, therefore, works as a private concern. A nonmandated NGO can be subcontracted by an IO or a mandated NGO. It can also obtain funds from private enterprises or donors.
- **International humanitarian organization (IHO).** An IHO is an impartial, neutral, and independent organization whose mandate is to assist and protect victims of conflict. It carefully guards its neutrality and does not desire to be associated with or dependent upon the military for fear of losing its special status in the international community that allows it to fulfill its mandate. Examples of IHOs include the—
  - International Organization for Migration (IOM).
  - International Committee of the Red Cross (ICRC).
  - IFRC.

### Civilian Lead Agencies

1-27. A lead agency is mandated by the international community to initiate the cooperation of civilian organizations that volunteer to participate in an operation. The lead agency is normally a major UN agency, such as the UNHCR or the UNOCHA, and it—

- Acts as the point of contact (POC) for other agencies.
- Coordinates field activities to avoid duplicating effort and wasting resources.

### Understanding Civilian Organizations

1-28. A good working relationship can be established with NGOs, IOs, and IHOs through trust and understanding. The most effective way for military forces to understand an organization's knowledge, skills, and abilities is to

establish and maintain a liaison with it. This understanding can also be gained through educating military leaders in military schools and courses.

## UNITED NATIONS

1-29. The UN is involved in the entire spectrum of HA operations from prevention to relief. Typically, UN relief agencies establish independent networks to execute their humanitarian-relief operations. The UN system delegates as much as possible to agency elements located in the field, with supervisory and support networks traced from field officers back to UN headquarters. Military planners must be familiar with UN objectives to ensure compatibility with military plans and orders. The UN agencies include the United Nations Disaster Relief Coordinator (UNDRC) and the UNHCR:

- **UNDRC.** It coordinates assistance to persons compelled to leave their homes because of disasters.
- **UNCHR.** It—
  - Provides international protection to refugees. It promotes the adoption of international standards for the treatment of refugees and supervises implementation of the standards.
  - Seeks permanent solutions for refugee problems. It facilitates voluntary repatriation and reintegration of refugees into their country of origin. Where practical, it facilitates their integration into a country of asylum or a third country.
  - Provides other activities that include emergency relief counseling, education, and legal assistance. These activities entail a very active role in monitoring human rights.
  - Helps governments meet their obligations concerning refugees under various international statutes.

## INTERNATIONAL RED CROSS AND RED CRESCENT MOVEMENTS

1-30. Three organizations make up the International Red Cross and Red Crescent Movement. They are the—

- **IFRC.** It provides relief operations to help victims of natural and man-made disasters. It has a unique network of national societies throughout the world. The IFRC is the umbrella organization for the ICRC.
- **ICRC.** It acts as a monitoring agent for the proper treatment of EPWs and other detained persons. It coordinates National Red Cross and Red Crescent Societies' international relief operations for victims of conflict. The ICRC reports violations of international humanitarian laws and promotes awareness and development of humanitarian laws among nations.
- National Red Cross and Red Crescent organizations.

### NOTES:

**1. These organizations are distinctly different and have separate mandates and staff organizations. Do not consider them to be one organization.**

---

**2. Red Crescent organizations are found in predominately Muslim countries. They have the same goals and missions as Red Cross organizations.**

1-31. Although the ICRC is essentially Swiss, it has worldwide operations and acts as a neutral intermediary in armed conflicts. The ICRC ensures that conflict victims receive appropriate protection and assistance within the scope of the Geneva Conventions, their protocols, and the ICRC mandate. The ICRC undertakes protection and assistance activities for the benefit of detainees and civilian populations by—

- Visiting detainees and attempting, through confidential contacts, to ensure compliance with the Geneva Conventions.
- Supervising prisoner releases and exchanges.
- Providing emergency relief to civilians who are affected by an armed conflict or a natural disaster.
- Tracing individuals who are displaced because of an armed conflict or a natural disaster.
- Organizing family contacts and reunions.

## **PROTECTION OF CAPTIVES AND DETAINEES**

1-32. The provisions of the Geneva Conventions are applicable to captives and detainees from the time they are captured until they are released or repatriated. AR 190-8 is the implementing regulation. When a person is captured during the heat of battle, he is entitled to protection as a detainee.

1-33. Detainees receive humane treatment without distinction of race, nationality, religious belief, political opinion, or similar criteria. Captives and detainees are not murdered, mutilated, tortured, or degraded. They are not punished for alleged criminal acts without previous judgment pronounced by a legally constituted court that has accorded them judicial guarantees which are recognized as indispensable to a fair trial. Individuals and capturing nations are responsible for acts committed against detainees if the acts violate the Geneva Conventions.

1-34. Captives and detainees are entitled to respect, and they are treated with honor and as human beings. They are protected against violence, insults, public curiosity, and reprisals. They are not subjected to physical mutilation or medical or scientific experimentation that is not required for normal medical, dental, or hospital treatment. Coercion is not inflicted on captives and detainees to obtain information. Those who refuse to answer are not threatened, insulted, or exposed to unpleasant or disadvantageous treatment. Female captives and detainees are treated with respect and accorded fair and equal treatment.

## **PROTECTING POWER**

1-35. A neutral state or a humanitarian organization, such as the ICRC, is designated as a protecting power. The protecting power monitors whether detainees are receiving humane treatment as required by international law. Representatives or delegates of a protecting power are authorized to visit detainees where they are interned or confined and to interview them

regarding their internment, welfare, and rights. The interview may be conducted without witnesses. Such visits cannot be prohibited except for imperative military necessity.

### **UNITED STATES POLICY TOWARDS DETAINEES**

1-36. Basic US policy underlying the treatment of detainees and other captured or interned personnel during the course of a conflict requires and directs that all personnel be accorded humanitarian care and treatment from the moment of custody until their final release or repatriation. The US personnel are fully and equally bound to observe this policy whether capturing troops, custodial personnel, or anyone else, regardless of the capacity they may be serving. This policy is equally applicable for protecting detained and interned personnel whether they are known to have committed or are suspected of committing a serious offense that could be characterized as a war crime. The punishment of such persons is administered by the due process of law and under legally constituted authority. Inhumane treatment, even if committed under stress of combat and with deep provocation, is a serious and punishable violation under national law, international law, and the UCMJ.

### **PROTECTION OF ENEMY PRISONERS OF WAR AND CIVILIAN INTERNEES**

1-37. The Geneva Conventions, comprised of four treaties, form part of the supreme law of the land and provide the internationally recognized humanitarian standards for the treatment of war victims. The US ratified the Geneva Conventions for the Protection of War Victims, 12 August 1949. It recognizes the spirit and intent of these treaties in its treatment of EPWs, CIs, and detained and interned persons. The Geneva Conventions became effective in 1956, and the US observes and enforces the terms of these conventions. They are collectively referred to as the Geneva Conventions and include the—

- **GPW.** This convention provides humane treatment of EPWs. It regulates the treatment of internees (care, food, clothing, and housing), discipline and punishment, labor and pay, external relations, representation, the international exchange of information, and the termination of captivity.
- **GC.** This convention deals with the protection for populations against the consequences of war, the status and treatment of protected persons, and the treatment of CIs.
- **Geneva Convention for the Amelioration of the Condition of the Wounded and Sick in Armed Forces in the Field, 12 August 1949 (GWS).** This convention provides protection for members of the armed forces and other persons on the battlefield who are wounded or sick. Members in the conflict search for and collect wounded and sick persons, protect them against pillage and ill treatment, and ensure their adequate care. They also search for dead persons and prevent them from being despoiled.
- **Geneva Convention for the Amelioration of the Condition of Wounded, Sick, and Shipwrecked Members of Armed Forces at**

---

**Sea, 12 August 1949 (GWS [SEA]).** This convention provides humane treatment and protection for members of the armed forces and other persons at sea who are wounded, sick, or shipwrecked. It also protects hospital ships and burial at sea.

1-38. STANAG 2044 prescribes concepts and procedures for the control and administration of EPWs by US armed forces operating in Europe under operational control (OPCON) of the North Atlantic Treaty Organization (NATO), in coordination with one or more NATO allies, and supported by the doctrine contained in this manual. STANAG 2044 provides—

- Terms and definitions relating to EPWs.
- Procedures for using EPW personnel record forms.
- Procedures for handling EPWs, their personal property, and their money.

## **PROTECTION OF REFUGEES**

1-39. The Geneva Convention Relative to the Status of Refugees (1951) and its protocols (1967) provide a general, universally applicable definition of refugee. They address the minimum standards for the treatment of refugees, specifying the obligations of the host nation (HN) and the refugees to one another. Among the important provisions of the 1951 Convention is the principle of nonrefoulement (Article 33). The principle of nonrefoulement is often referred to as the cornerstone of international protection. This principle prohibits the return or expulsion of a refugee to the territory of a state where his life, freedom, or personal security would be in jeopardy. Through widespread practice, the principle is considered to be a rule of customary law, binding nations whether or not they are signatories.

1-40. The 1951 Convention also provides protection of refugees. A refugee has the right to safe asylum; however, international protection comprises more than physical safety. Refugees receive the same rights and help as any other foreigner who is a legal resident, including certain fundamental entitlements of every individual. Refugees have basic civil rights, including freedom of thought and movement and freedom from torture and degrading treatment. Similarly, refugees have economic and social rights. Every adult refugee has the right to work, and no child refugee is deprived of schooling. In certain circumstances, such as large-scale inflows of refugees, asylum states may feel obliged to restrict certain rights, such as freedoms of movement, work, and education. Such gaps should be filled by the international community when possible. When resources are unavailable from the government of the asylum country or other agencies, the UNHCR will assist.

**NOTE: For further details, see the UNHCR Handbook for the Military on Humanitarian Operations, First Edition, 1995.**

## Chapter 2

# Commander and Staff Responsibilities

All MP commanders and staff members must be familiar with applicable ARs, Army directives, and international laws necessary for the successful operation of I/R and confinement facilities. This chapter discusses areas of greatest concern when performing the I/R function.

### SECTION I - COMMANDERS

2-1. An MP battalion commander tasked with operating an I/R facility is also the facility commander. As such, he is responsible for the safety and well-being of all personnel housed within the facility. Since an MP unit may be tasked to handle different categories of personnel (EPW, CI, OD, refugee, and US military prisoner), the commander, the cadre, and support personnel must be aware of the requirements for each category.

### PROCEDURES

2-2. Commanders are familiar with applicable regulations, directives, international laws, and administrative procedures. The servicing staff judge advocate (SJA) provides legal advice and training on I/R matters. Regulations and other guidance relative to the administration, employment, and compensation of internees are prescribed in—

- AR 190-8.
- Defense Finance and Accounting Service—Indianapolis (DFAS-IN) 37-1.
- FM 14-100.
- DA Pamphlet (Pam) 37-100-95.
- FM 27-10.

2-3. Copies of the Geneva Conventions and compound regulations, orders, and notices relating to internee conduct and activities are posted in each facility, in the language of internees who are housed there. If internees do not have access to posted copies, the facility commander makes copies available to them.

2-4. The commander is responsible for the administrative processing of each internee. When processing is complete, he submits a DA Form 2674-R to the servicing internment/resettlement information center (IRIC), which functions as the field operations agency for the national IRIC located in CONUS.

## PRINCIPLES AND POLICIES

2-5. The following principles apply to I/R facilities:

- Use housed personnel for internal maintenance and operation.
- Use captured supplies and equipment (excluding weapons and ammunition).
- Maintain control.

2-6. An EPW/CI has the right to—

- Submit requests and complaints regarding the conditions of confinement.
- Elect representatives.
- Send and receive correspondence.

**NOTE: The rights of US military prisoners are outlined in AR 190-47 and DOD Directive 1325.4.**

## STANDING ORDERS

2-7. Standing orders provide uniform, orderly administration of an I/R facility. The orders to be obeyed by housed personnel are published in their language and posted where they can read the orders and refer to them. Standing orders include rules, procedures, and instructions (see Figure 2-1) governing the following activities and other matters as deemed appropriate:

- Schedule of calls, including—
  - Reveille.
  - Morning roll.
  - Readiness of quarters for inspection.
  - Sick.
  - Mess.
  - Evening roll.
  - Lights out.
- Housed personnel actions that support the emergency action plans of the internment facility, such as—
  - Fire drills.
  - Air raid drills.
  - Emergency evacuations.
  - Natural disaster drills.
  - Blackouts.
  - Escapes.
- Hours for religious services, recreation activities, and so forth.
- Procedures for emergency sick call.
- Designated smoking areas.



1. You must comply with rules, regulations, and orders. They are necessary for safety, good order, and discipline.
2. You must immediately obey all orders of US personnel. Deliberate disobedience, resistance, or conduct of a mutinous or riotous nature will be dealt with by force.
3. You are subject to disciplinary or judicial punishment if you disobey a rule, a regulation, or an order or if you commit any act, conduct, disorder, or neglect that is prejudicial to good order or discipline.
4. You will not receive disciplinary or judicial punishment until you have an opportunity to explain your conduct and to defend yourself. If you commit an offense for which judicial punishment may arise, investigation of the offense will be coordinated with the SJA before being undertaken to ensure that it is conducted according to the Geneva Conventions. You may call witnesses, and if necessary, you will be provided with the services of a qualified interpreter.
5. You may receive disciplinary punishment that includes discontinuing privileges over and above the treatment provided for by the Geneva Conventions. You may receive a fine up to one half of your 30-day advance and working pay. Privates may be assigned fatigue (extra) duty up to 2 hours daily, noncommissioned officers (NCOs) may be required to perform supervisory duties only, and officers may not be compelled to work.
6. You may not establish courts or administer punishment over other captives.
7. You may not have knives, sticks, metal pieces, or other articles that can be used as weapons in your possession at any time.
8. You may not drill or march in military formation for any purpose except as authorized and directed by the facility commander.
9. You may not meet or issue propaganda for political purposes.
10. You may not wear or display national political items.
11. You may not gamble.
12. You may not possess or consume alcoholic beverages.
13. You may retain personal effects and property that are authorized by the facility commander.
14. You may smoke at times and places specified by the facility commander.
15. You will follow the required courtesies toward your army's officers. If you are an enlisted captive, you will salute all US commissioned officers. If you are an officer captive, you will salute US commissioned officers of a higher grade and the facility commander, regardless of his grade.

**Figure 2-1. Sample Standing Orders**

## **NOTICE OF PROTECTION**

2-8. To protect persons from acts of violence, bodily injury, and threats of reprisals at the hand of fellow internees, post a notice of protection (Figure 2-2) in the internees' language in every compound.

<b>NOTICE</b>
<p>A detainee who fears that his life is in danger, or fears that he may suffer physical injury at the hands of another detainee, should immediately report to a US member of the facility without consulting his representative. The facility commander ensures adequate protection for the victim by segregation, transfer, or other means. A detainee who mistreats a fellow detainee will be punished.</p> <p style="text-align: right;">(Signed by the Commanding Officer)</p>

**Figure 2-2. Sample Notice of Protection**

## RECORDS AND REPORTS

2-9. The commander establishes local records and reports necessary for the effective operation of the I/R facility. They provide information about the control, supervision, and disposition of personnel housed in the facility. He determines the type (administrative, operational, logistical, intelligence, and personnel) of reports and the frequency (routine or as required). Normal reports (duty officer logs, worksheets, and situation maps) are also required.

## MEDICAL AND SANITATION CONSIDERATIONS

2-10. Commanders consider the following when establishing medical care (see AR 190-8):

- A medical officer, a physician's assistant (PA), or a nurse practitioner examines each internee monthly and—
  - Records his weight on DA Form 2664-R.
  - Monitors his general health, nutrition, and cleanliness.
  - Examines him for contagious diseases, especially tuberculosis (TB), venereal disease, lice, louse-borne disease, and human immunodeficiency virus (HIV).
- The medical treatment facility provides isolation of communicable diseases, disinfection, and inoculations. Use retained medical personnel and EPWs with medical training to the fullest extent possible when caring for sick and wounded EPWs. When medical care is inadequate, transfer housed personnel to military or civilian medical facilities where the required treatment is available.

2-11. Certain sanitation standards must be met to prevent disease and ensure cleanliness. These standards include—

- Ensuring that internees receive as much water as US soldiers.
- Providing adequate space within housing units to prevent overcrowding.
- Providing sufficient showers and latrines and ensuring that they are cleaned and sanitized daily.
- Teaching dining-facility workers the rules of good food sanitation and ensuring that they are observed and practiced.
- Disposing of human waste properly to protect the health of all individuals associated with the facility according to the guidelines established by preventive medicine (PVNTMED).
- Providing sufficient potable water for drinking, bathing, laundry, and food service.
- Providing materials for personal hygiene.
- Training personnel on proper garbage disposal to prevent insects and vermin that can contribute to health hazards.

## SOCIAL PROGRAMS

2-12. Encourage and support active education, religious, recreation, and employment programs when practical. If possible, provide adequate facilities, instruction material, and recreation equipment.

2-13. Accredited representatives of protecting powers and the ICRC are allowed full access to the I/R facility and internees. Representatives of approved religious organizations, relief societies, NGOs, IHOs, and other organizations assisting housed personnel are permitted to visit according to policies and procedures prescribed by the DA.

2-14. Advanced coordination is encouraged by representatives of NGOs, IOs, and IHOs who want access to internees. This avoids confusion when representatives arrive at the facility. Likewise, the facility staff coordinates in advance with organizations to establish an access roster of representatives and a means of verifying their identity.

### **Religion**

2-15. Housed personnel are allowed freedom of worship, including attendance at services of their respective faith held within the facility. Retained chaplains and other EPW clergymen are permitted to devote their time to ministering to members of their faith. The MP commander may permit other ordained clergymen, theological students, or chaplains to conduct services within the compound. The US personnel will not attend services with EPWs, RPs, CIs, or ODs.

### **Recreation**

2-16. Participation in recreation activities promotes general health and welfare and alleviates tension and boredom. In addition to athletic contests, group entertainment can be provided by concerts, plays, recorded music, and motion pictures.

### **SAFETY PROGRAM**

2-17. Set up and administer a safety program for housed personnel in each I/R facility. Follow the procedures outlined in AR 385-10 and associated circulars and pamphlets to establish the safety program. Maintain records and reports for the internee safety program separate from those for the Army safety program.

### **AGRICULTURAL PROGRAM**

2-18. The EPWs are allowed to raise vegetables for their use. Subsequently, commanders must be aware of resources, procedures, and HN guidelines applicable to this program.

### **SECURITY**

2-19. The MP commander establishes security measures that effectively control housed personnel with minimal use of force. The same use of force that is employed for one category of housed personnel may not be applicable to another. Commanders protect housed personnel from threats outside the facility. The physical construction of the facility and the presence of guard personnel create the most obvious means of providing internal and external security. Maintaining a high state of discipline, a system of routines, and

required standards of behavior are all measures that enhance effective security and control.

2-20. Many housed personnel will actively cooperate with US authorities or will assume a passive, compliant role. They will be composed, in part, of individuals with ideologies favorable to the US. Others, through resignation or apathy, will simply adapt themselves to the conditions of their internment.

2-21. Some housed personnel will engage in a campaign of embarrassing and harassing US personnel to create propaganda of value to their cause. The EPWs want to force the use of maximum US troops for other-than-combat missions. The leaders of the uncooperative faction may try to establish a united effort and blind obedience by all its members. They will not be content with merely planning and attempting to escape or using normal harassment tactics. The leaders will assign duties and missions to individuals so that resistance will not stop while they are interned. Any relaxation of security will be immediately detected and fully exploited.

2-22. Maintain firm control at all times. Adapt policies, tactics, techniques, and procedures (TTP) to achieve this end state.

## **FACILITY GUARD FORCE**

2-23. The facility guard force provides internal and external security. The force has a commander of the guard, one or more sergeants of the guard, a relief commander for each shift, and the necessary number of guards. There are two types of orders for guards:

- **General orders.** All guards are required to know, understand, and comply with the general orders outlined for sentinels in FM 22-6.
- **Special orders.** They apply to particular posts and duties. Special orders supplement general orders and are established by the commander.

2-24. The facility guard force is the primary source of security for the I/R facility. Its responsibilities include—

- Internal.
  - Sally port.
  - Search teams.
  - Receiving and processing lines.
  - Escorts.
  - Facility gates.
- External.
  - Holding area.
  - Towers.
  - Transfer area.
  - Work site.
  - Perimeter.
  - Brigade tactical operations center (BTOC).

---

## Standby Guards

2-25. Standby guards are soldiers who are not on duty. The standby guard force is large enough to reinforce tower and sally port guards; however, it is not normally used as a quick-reaction force (QRF) to enter enclosures and quell disturbances or conduct searches.

## Tower Guards

2-26. Tower guards are posted in towers and positioned so that they have overlapping fields of vision of the entire perimeter. This allows one or more guards to observe activities within enclosures. A tower guard's primary duties are to prevent escape and to observe and report unauthorized or suspicious activities.

## Walking Patrols

2-27. Walking patrols supplement the perimeter security when weather conditions or electrical failure prevents tower guards from clearly observing the entire perimeter. Gate guards are posted at perimeter gates and the sally port to—

- Exercise control over personnel, vehicles, and work details.
- Conduct shakedown searches according to facility standing operating procedures (SOPs), special orders, and security regulations.
- Prevent the smuggling of weapons or other contraband items into the facility.
- Prevent escapes.

## Military Working Dogs

2-28. Military working dogs (MWDs) offer a psychological and real deterrent against physical threats presented by housed personnel. However, they cannot be used as security measures against US military prisoners. The MWDs reinforce security measures against penetration and attack by small enemy forces that may be operating in the area. They also provide a positive, effective alternative to using firearms when preventing disturbances. The various techniques for employing MWDs are—

- **Demonstrations.** Hold periodic demonstrations in full view of housed personnel to increase the psychological deterrent of MWDs. Emphasize how easily and quickly an MWD can overtake a fleeing individual, highlight his ability to attack and overcome physical resistance, and demonstrate his tracking ability. To ensure a successful demonstration, use only the best qualified MWD teams.
- **Perimeter security.** Use an MWD team as an adjunct to perimeter security by making periodic, unscheduled patrols around the perimeter fence during periods of darkness. During inclement weather, a temporary blackout, or an electrical failure, increase the number and frequency of patrols. Ensure that housed personnel are aware of MWD presence by having dogs bark at infrequent intervals during the night.

- **Inspections.** Walk an MWD team through living areas to search for contraband. Depending on the type of MWD team available, it can search for explosive devices and components and/or illegal drugs.
- **Work details.** Position an MWD between the work detail and the area offering the greatest avenue of escape. The MWDs provide a valuable adjunct to work detail guards, particularly those employed in areas offering the greatest potential for escape.

## USE OF FORCE AND RULES OF ENGAGEMENT

2-29. An MP commander ensures that soldiers understand use-of-force guidelines and the ROE established by higher headquarters for each mission. Because the use of force and the ROE vary depending on the category of housed personnel and the operational environment, the commander develops SOPs that follow the guidance provided. He balances the physical security of forces with mission accomplishment and the protection of deployed forces.

**NOTE: For more information on the use of force, see Appendix B.**

2-30. The restrictions on combat operations and the use of force are clearly explained in the ROE and are understood and obeyed at all levels. Soldiers study and train on the use of the ROE and discuss them for their mission. The ROE address the distinctions between internee categories and the instruments of control available for each category. Use the following issues to develop ROE guidelines:

- What is considered lethal force?
- Under what conditions is lethal force used?
- Under what conditions is nonlethal force used?
- What are the required warnings, if any, before using force (lethal or nonlethal)?

## TYPES OF DISTURBANCES

2-31. Housed personnel may organize a disturbance within the facility to weaken the guard force. At the beginning of a disturbance, initiate a record of events. Commanders must be concerned with two types of disturbances—riots and disorders:

- Riots.
  - **Organized.** Leaders of housed personnel organize the internee population into quasi-military groups.
  - **Unorganized.** It is spontaneous in nature, although it can be exploited and diverted by leaders into an organized riot.
  - **Multiple.** When housed personnel in one compound start rioting, personnel in other compounds also riot.
- Disorders.
  - **Organized.** It can be a demonstration, a refusal to work or eat, a work slowdown, or the damage or destruction of property.
  - **Unorganized.** It is spontaneous in nature.

**NOTE: For more information on riots and disorders, see Appendix B.**

## SECTION II - STAFF OFFICERS

2-32. Staff officers at tactical headquarters and CSS commands are normally responsible for the same functional areas inside an I/R or confinement facility. However, the emphasis on different aspects and the scope and magnitude of EPW, CI, and US military prisoner activities vary in CS and CSS commands. This section describes additional staff officers that may be found at different echelons of command (primarily I/R MP units) and their areas of responsibility. FM 101-5 describes the roles, relationships, organization, and responsibilities of staffs in the US Army.

### ADJUTANT GENERAL

2-33. The adjutant general (AG) maintains personnel records for EPWs, CIs, and US military prisoners. The AG's personnel and administrative section can inprocess eight persons per hour, depending on the category. It—

- Provides accountability documents to the IRIC if applicable.
- Maintains labor records and time cards for prisoners.
- Submits the required reports on prisoners.
- Prepares documents for administrative court-martial charges for EPWs, CIs, and US military prisoners.

### FINANCE OFFICER

2-34. The finance officer—

- Accounts for impounded financial assets (cash and negotiable instruments) of housed personnel.
- Records pay/labor credits, canteen purchases/coupons, and other transactions.
- Prepares payrolls, makes disbursements, and processes repatriation settlements.
- Advises the commander on finance and accounting issues.

**NOTE: See FM 14-100 for more information.**

### CIVIL-MILITARY OPERATIONS OFFICER

2-35. The civil-military operations (CMO) officer—

- Provides technical advice and assistance on strategies for community relations and information.
- Plans community relations programs to gain and maintain public understanding and goodwill and to support military operations.
- Provides liaison and coordination with other US government agencies; HN civil and military authorities concerned with I/R operations; and NGOs, IOs, and IHOs in the AO.
- Coordinates with the SJA on the ROE for dealing with housed personnel.

- Provides technical advice and assistance on the reorientation of enemy defectors, EPWs, CIs, and detainees.

## **CHAPLAIN**

2-36. The chaplain or the unit ministry team—

- Provides religious support for assigned soldiers and internees.
- Advises the commander on the impact of faiths and practices of indigenous religious groups in the AO and internees within the facility.
- Provides religious support to the command and the community, including confined and hospitalized personnel.
- Exercises supervision and control over internee religious leaders within the facility.

## **ENGINEER OFFICER**

2-37. The engineer officer is a captain in a brigade and a lieutenant in a battalion. He trains and supervises internees who perform internal and external labor (construction and repair of facilities). The engineer officer is responsible for—

- Construction, maintenance, repair, and operation of utilities (water, electricity, heat, and sanitation).
- Construction support.
- Fire protection.
- Insect and rodent control and fumigation.

## **PUBLIC AFFAIRS OFFICER**

2-38. The public affairs officer (PAO)—

- Understands and fulfills the information needs of soldiers, the Army community, and the public in matters relating to internees and the I/R facility.
- Serves as the command's spokesman for all communication with the external media.
- Facilitates media efforts to cover operations by expediting the flow of complete, accurate, and timely information.

## **SIGNAL OFFICER**

2-39. The signal officer is located in the brigade. He is responsible for all matters concerning signal operations, automation management, network management, and information security.

## **STAFF JUDGE ADVOCATE**

2-40. The SJA is located in the brigade and the brigade liaison detachment (BLD). He—



- Provides operational law advice and support for US military prisoner operations and resettlement operations, particularly the interpretation of the Geneva Conventions.
- Provides advice on the application of force to quell riots and other disturbances.
- Provides support and advice during investigations following the death or injury of an internee during internment.
- Serves as the recorder for Article 5 tribunals. (A tribunal determines the status of a person who has committed a hostile act but whose status is doubtful.)
- Serves as the commander's liaison to the ICRC.
- Provides legal advice on—
  - Military justice.
  - Administrative law (investigations and command authority).
  - Civil law (contract, fiscal, and environmental laws).
  - International law (law of land warfare, Geneva Conventions, status of forces, ROE, and treatment of detained persons).
  - Claims.
  - Legal assistance.
- Provides technical advice and assistance on the internee labor policy as it relates to supporting local indigenous requirements not directly advancing the war effort.
- Complies with all treaties and conventions.

## **MEDICAL OPERATIONS**

### **2-41. The surgeon section—**

- Is responsible for the combat health support (CHS) of the command and internees within the facility.
- Advises the commander.
- Plans and directs echelon I CHS.
- Arranges echelons II and III CHS (including air/ground medical evacuation and hospitalization) when required.
- Provides disease prevention through PVNTMED programs.

### **2-42. The medical treatment squad—**

- Provides routine medical care (sick call) and advanced trauma management for duty soldiers and internees.
- Supervises qualified RPs who are providing medical care for internees.
- Performs initial medical exams to determine the physical fitness of arriving internees as stipulated by the Geneva Conventions.
- Is capable of operating as two separate treatment teams.

### **2-43. The PVNTMED section—**

- Provides limited PVNTMED services for the facility.
- Performs sanitary inspections of housing, food service operations, water supplies, waste disposal operations, and other operations that may present a medical nuisance or health hazard to personnel.

- Provides training and guidance to the staff, unit personnel, and others.

## **MOVEMENT CONTROL OFFICER**

2-44. The movement control officer (MCO)—

- Plans and coordinates the movement of internees and their property with the Corps Support Command (US Army) (COSCOM) movement control center.
- Coordinates with brigade operations for daily transportation requirements and evacuation and transfer of internees. This includes determining the transportation requirements for the evacuation of detainees from one level of internment to the next and coordinating the arrangements.

## **INSPECTOR GENERAL**

2-45. The inspector general (IG) is located in the brigade. He—

- Advises the commander on the organization inspection policy (OIP).
- Conducts inspections, surveys, and studies to comply with international, state, and US laws.
- Receives allegations and conducts investigations and inquiries based on reports and information obtained from EPWs, CIs, DCs, US military personnel, and multinational guard and police forces.
- Consults with international and US agencies in matters pertaining to the overall health and welfare of the protected population.
- Determines the MP unit's discipline, efficiency, morale, training, and readiness and provides feedback to the chain of command.
- Assists the protected population in coping with family issues and resolving complaints consistent with military necessity.
- Identifies trends to correct and improve I/R operations consistent with current doctrine, military laws, international laws, UN mandates, and foreign-nation (FN) and state laws.
- Assists in the resolution of systemic issues pertaining to the processing and administration of the protected population.
- Reports allegations of war crimes (from protected personnel or US soldiers) through the chain of command to the SJA or the United States Army Criminal Investigation Command (USACIC). The responsibility for investigating alleged war crimes rests with the SJA and the criminal investigation division (CID), not the IG.

## **PSYCHOLOGICAL OPERATIONS**

2-46. Psychological operations (PSYOP) are not part of the I/R structure; however, the PSYOP officer in charge (OIC) of the EPW/CI PSYOP team supporting I/R operations serves as the special staff officer responsible for PSYOP. The PSYOP officer advises the MP commander on the psychological impact of actions to prevent misunderstandings and disturbances by EPWs and CIs. The EPW/CI PSYOP team—

- Assists the MP force in controlling EPWs and CIs.
- Exposes EPWs and CIs to US and allied policies.
- Develops and executes PSYOP programs to condition EPWs and CIs to accept facility authority and regulations.
- Gains the cooperation of EPWs and CIs to reduce guard needs.
- Identifies malcontents, trained agitators, and political officers within the facility who may try to organize a resistance or create a disturbance.
- Develops and executes indoctrination programs to reduce or remove proenemy attitudes.
- Recognizes political activists.
- Helps the MP commander control EPWs and CIs during emergencies.
- Plans and executes a PSYOP program that produces an understanding and appreciation of US policies and actions.
- Uses comprehensive information, reorientation, educational, and vocational programs to prepare EPWs and CIs for repatriation.

**NOTE: See FMs 3-05.30 and 33-1-1 for additional information about PSYOP support to I/R operations.**

## SECTION III - TRAINING

2-47. The necessary care and control of housed personnel is best achieved with carefully selected and trained personnel. The specialized nature of duty at different facilities requires individuals who can be depended on to cope successfully with behavior or incidents that call for calm, fair, and immediate decisive action. These personnel must possess the highest qualities of leadership and judgment. They are required to observe rigid self-discipline and maintain a professional attitude at all times.

2-48. Personnel assigned or attached to I/R facilities are trained on the care and control of housed personnel. They are fully cognizant of the provisions of the Geneva and UN Conventions and applicable regulations as they apply to the treatment of housed personnel. A formal training program should include—

- Principles and laws of land warfare, specifically provisions of Geneva and UN Conventions and HN laws and customs.
- Supervisory and human relations techniques.
- Methods of self-defense.
- The use of force, the ROE, and the ROI.
- Firearms qualification and familiarization.
- Public relations, particularly CONUS operations.
- First aid.
- Stress management techniques.
- Facility regulations and SOPs.
- Intelligence and counterintelligence techniques.
- Cultural customs and habits of internees.

- The basic language of internees.

2-49. The guard force should receive additional training in—

- Riot control measures, control agents, and dispersers.
- QRF actions.
- Searching techniques, including the use of electronic detection devices.
- Nonlethal equipment and weapons.

2-50. Medical soldiers assigned to the facility may be required to deliver babies and care for infants and small children. Their training should include—

- Delivery procedures.
- Birthing techniques.
- Medical conditions associated with malnutrition and water-, food-, and arthropod-borne diseases.

## PART TWO

# Enemy Prisoners of War and Civilian Internees

Part Two addresses handling, securing, and accounting for EPWs and CIs. The MP performing EPW/CI operations must follow specific ROE and ROI applicable to this category of I/R operations. The EPWs and CIs are not treated as DCs or US military prisoners. Leaders and soldiers must be knowledgeable of the Geneva and Hague Conventions, applicable protocols, ARs, and US laws. During war or military operations other than war (MOOTW) involving US forces, the accountability and safe, humane treatment of captives are essential. The US policy demands that all persons who are captured, detained, or held by US forces during conflict be treated humanely. This policy applies from the moment captives are taken until they are released, repatriated, or transferred. Chapter 3 describes division collecting points (CPs) and corps holding areas (CHAs) that may be established throughout the battlefield. Chapter 4 addresses procedures for EPWs, and Chapter 5 describes procedures for CIs. Chapter 6 addresses unique planning requirements to be considered when operating an I/R facility.

---

## Chapter 3

### Division Collecting Points and Corps Holding Areas

Chapters 3 and 4 implement STANAG 2044.

A large number of captives on the battlefield hampers maneuver units as they move to engage and destroy an enemy. To assist maneuver units in performing their mission—

- Division MP units operate CPs in the division AO.
- Corps MP units operate holding areas in the corps AO.

## OVERVIEW

3-1. The MP units accept captives from capturing units as far forward as possible, and captives are held in CPs and CHAs until they are removed from the battlefield. Normally, CPs are operated in the division AO and CHAs are operated in the corps AO; but they can be operated anywhere they are needed. The CPs and CHAs sustain and safeguard captives and ensure a minimum level of field processing and accountability. Wounded and sick captives receive medical treatment, and captives who require lifesaving medical attention are evacuated to the nearest medical facility.

3-2. The MP establish listening posts (LPs), observation posts (OPs), guard posts, and fighting positions to protect captives and prevent their escape. Captured soldiers are trained to believe that escape from captivity is their duty; therefore, they must be closely guarded. Consider the morale and physical condition of captives when determining the number of guards needed. Guards must be prepared to use and maintain firm control and security.

3-3. The MP work closely with military intelligence (MI) interrogation teams at CPs and CHAs to determine if captives, their equipment, and their weapons have intelligence value. This process is accelerated when MI interrogation teams can observe captives during arrival and processing, and interrogators can also be used as interpreters during this phase. Before a captive is interviewed by MI personnel, he must have a Department of Defense (DD) Form 2745 (Figure 3-1) attached to him and be accounted for on DD Form 2708.

3-4. If the CP or the CHA comes under a nuclear, biological, or chemical (NBC) attack, remove captives from the contaminated area and decontaminate them to the same level as US forces. Request assistance for decontaminating captives through command channels. The supply officer issues NBC protective equipment and clothing to captives, using captured materials (when available) or US materials (if necessary).

## **PROCESSING CAPTIVES**

3-5. Processing begins when US forces capture or detain an individual. The processing is accomplished in the CZ for security, control, intelligence, and the welfare of captives in evacuation channels. This is referred to as *field processing*. The capturing unit begins field processing by using the Five Ss and T procedure (search, segregate, silence, speed, safeguard, and tag). At the CP or the CHA, MP continue processing with the principles of STRESS (search, tag, report, evacuate, segregate, and safeguard).

3-6. After receiving a captive from a capturing unit, MP are responsible for safeguarding and accounting for the captive at each stage of his removal from the battlefield. The processing procedure begins upon capture and continues until the captive reaches the I/R facility and is released. The process of identifying and tagging a captive helps US forces control and account for him as they move rearward from the battlefield. Before a captive is interned, repatriated, or released, MP at the I/R facility must provide full-scale processing.

<p align="center"><b>ENEMY PRISONER OF WAR (EPW) CAPTURE TAG (PART A)</b></p> <p align="center">For use of this form, see AR 190-8. The proponent agency is DCSOFS.</p> <p>Attach this part of tag to EPW. <i>(Do not remove from EPW.)</i></p> <ol style="list-style-type: none"> <li>1. Search - For weapons, military documents, or special equipment.</li> <li>2. Silence - Prohibit talking among EPWs for ease of control.</li> <li>3. Segregate - By rank, sex, and nationality.</li> <li>4. Safeguard - To prevent harm or escape.</li> <li>5. Speed - Evacuate from the combat zone.</li> <li>6. Tag - Prisoners and documents or special equipment.</li> </ol> <p><small>DD FORM 2745 (BACK), MAY 96</small></p>	<table border="1" style="width: 100%; border-collapse: collapse;"> <tr> <td colspan="2">1. DATE AND TIME OF CAPTURE 1113D</td> <td colspan="2">2. SERIAL NO. 0090829</td> <td align="right" colspan="2"><b>A</b></td> </tr> <tr> <td colspan="2">3. NAME DD D</td> <td colspan="4">4. DATE OF BIRTH 12D5</td> </tr> <tr> <td colspan="2">5. RANK D</td> <td colspan="4">6. SERVICE NO. 123-45-6789</td> </tr> <tr> <td colspan="2">7. UNIT OF EPW 122D</td> <td colspan="2">4D</td> <td colspan="2">8. CAPTURING UNIT</td> </tr> <tr> <td colspan="6">9. LOCATION OF CAPTURE (Grid coordinates) D82456</td> </tr> <tr> <td colspan="2">10. CIRCUMSTANCES OF CAPTURE D D</td> <td colspan="2">11. PHYSICAL CON- D D</td> <td colspan="2">12. WEAPONS, EQUIP- D D</td> </tr> </table> <p align="center"><small>DD FORM 2745, MAY 96</small></p> <p align="right"><small>REPLACES DA FORM 5976, JAN 91, USABLE UNTIL EXHAUSTED.</small></p>	1. DATE AND TIME OF CAPTURE 1113D		2. SERIAL NO. 0090829		<b>A</b>		3. NAME DD D		4. DATE OF BIRTH 12D5				5. RANK D		6. SERVICE NO. 123-45-6789				7. UNIT OF EPW 122D		4D		8. CAPTURING UNIT		9. LOCATION OF CAPTURE (Grid coordinates) D82456						10. CIRCUMSTANCES OF CAPTURE D D		11. PHYSICAL CON- D D		12. WEAPONS, EQUIP- D D	
1. DATE AND TIME OF CAPTURE 1113D		2. SERIAL NO. 0090829		<b>A</b>																																	
3. NAME DD D		4. DATE OF BIRTH 12D5																																			
5. RANK D		6. SERVICE NO. 123-45-6789																																			
7. UNIT OF EPW 122D		4D		8. CAPTURING UNIT																																	
9. LOCATION OF CAPTURE (Grid coordinates) D82456																																					
10. CIRCUMSTANCES OF CAPTURE D D		11. PHYSICAL CON- D D		12. WEAPONS, EQUIP- D D																																	
<p align="center"><b>UNIT RECORD CARD (PART B)</b></p> <p align="center">Forward to Unit. <i>(Capturing unit retains for records.)</i></p> <p>Use string, wire, or other durable material to attach the appropriate section of this form to the EPW's equipment or property.</p> <p><small>DD FORM 2745 (BACK), MAY 96</small></p>	<table border="1" style="width: 100%; border-collapse: collapse;"> <tr> <td colspan="2">1. DATE AND TIME OF CAPTURE 1113D</td> <td colspan="2">2. SERIAL NO. 0090829</td> <td align="right" colspan="2"><b>B</b></td> </tr> <tr> <td colspan="2">3. NAME DD D</td> <td colspan="4">4. DATE OF BIRTH 12D5</td> </tr> <tr> <td colspan="2">5. RANK D</td> <td colspan="4">6. SERVICE NO. 123-45-6789</td> </tr> <tr> <td colspan="2">7. UNIT OF EPW 122D</td> <td colspan="2">4D</td> <td colspan="2">8. CAPTURING UNIT</td> </tr> <tr> <td colspan="6">9. LOCATION OF CAPTURE (Grid coordinates) D82456</td> </tr> <tr> <td colspan="2">10. CIRCUMSTANCES OF CAPTURE D D</td> <td colspan="2">11. PHYSICAL CON- D D</td> <td colspan="2">12. WEAPONS, EQUIP- D D</td> </tr> </table> <p align="center"><small>DD FORM 2745, MAY 96</small></p> <p align="right"><small>REPLACES DA FORM 5976, JAN 91, USABLE UNTIL EXHAUSTED.</small></p>	1. DATE AND TIME OF CAPTURE 1113D		2. SERIAL NO. 0090829		<b>B</b>		3. NAME DD D		4. DATE OF BIRTH 12D5				5. RANK D		6. SERVICE NO. 123-45-6789				7. UNIT OF EPW 122D		4D		8. CAPTURING UNIT		9. LOCATION OF CAPTURE (Grid coordinates) D82456						10. CIRCUMSTANCES OF CAPTURE D D		11. PHYSICAL CON- D D		12. WEAPONS, EQUIP- D D	
1. DATE AND TIME OF CAPTURE 1113D		2. SERIAL NO. 0090829		<b>B</b>																																	
3. NAME DD D		4. DATE OF BIRTH 12D5																																			
5. RANK D		6. SERVICE NO. 123-45-6789																																			
7. UNIT OF EPW 122D		4D		8. CAPTURING UNIT																																	
9. LOCATION OF CAPTURE (Grid coordinates) D82456																																					
10. CIRCUMSTANCES OF CAPTURE D D		11. PHYSICAL CON- D D		12. WEAPONS, EQUIP- D D																																	
<p align="center"><b>DOCUMENT/SPECIAL EQUIPMENT WEAPONS CARD (PART C)</b></p> <p>Attach this part of tag to property taken. <i>(Do not remove from property.)</i></p> <p>As a minimum, the tag must include the following information:</p> <p>Item 1. Date and time of capture (YYYYMMDD). Item 8. Capturing unit. Item 9. Place of capture (grid coordinates). Item 10. Circumstances of capture (how the EPW was captured).</p> <p><small>DD FORM 2745 (BACK), MAY 96</small></p>	<table border="1" style="width: 100%; border-collapse: collapse;"> <tr> <td colspan="2">1. DATE AND TIME OF CAPTURE 1113D</td> <td colspan="2">2. SERIAL NO. 0090829</td> <td align="right" colspan="2"><b>C</b></td> </tr> <tr> <td colspan="2">3. NAME DD</td> <td colspan="4">4. DATE OF BIRTH 12D5</td> </tr> <tr> <td colspan="2">5. RANK D</td> <td colspan="4">6. SERVICE NO. 123-45-6789</td> </tr> <tr> <td colspan="2">7. UNIT OF EPW 122D</td> <td colspan="2">4D</td> <td colspan="2">8. CAPTURING UNIT</td> </tr> <tr> <td colspan="6">9. LOCATION OF CAPTURE (Grid coordinates) D82456</td> </tr> <tr> <td colspan="6">10. DESCRIPTION OF WEAPONS, SPECIAL EQUIPMENT, DOCUMENTS D7D</td> </tr> </table> <p align="center"><small>DD FORM 2745, MAY 96</small></p> <p align="right"><small>REPLACES DA FORM 5976, JAN 91, USABLE UNTIL EXHAUSTED.</small></p>	1. DATE AND TIME OF CAPTURE 1113D		2. SERIAL NO. 0090829		<b>C</b>		3. NAME DD		4. DATE OF BIRTH 12D5				5. RANK D		6. SERVICE NO. 123-45-6789				7. UNIT OF EPW 122D		4D		8. CAPTURING UNIT		9. LOCATION OF CAPTURE (Grid coordinates) D82456						10. DESCRIPTION OF WEAPONS, SPECIAL EQUIPMENT, DOCUMENTS D7D					
1. DATE AND TIME OF CAPTURE 1113D		2. SERIAL NO. 0090829		<b>C</b>																																	
3. NAME DD		4. DATE OF BIRTH 12D5																																			
5. RANK D		6. SERVICE NO. 123-45-6789																																			
7. UNIT OF EPW 122D		4D		8. CAPTURING UNIT																																	
9. LOCATION OF CAPTURE (Grid coordinates) D82456																																					
10. DESCRIPTION OF WEAPONS, SPECIAL EQUIPMENT, DOCUMENTS D7D																																					

Figure 3-1. Sample DD Form 2745

## CAPTURING UNIT

3-7. The Five Ss and T procedure is performed by the capturing unit. The basic principles are search, segregate, silence, speed, safeguard, and tag (see Table 3-1).

**Table 3-1. Five Ss and T Procedure**

Procedure	Description
Search	<p>Search captives for weapons and ammunition, items of intelligence value, and other inappropriate items.</p> <p><b>NOTE: Conduct same-gender searches when possible. If mixed-gender searches are necessary for speed or security, conduct them in a respectful manner and avoid any action that could be interpreted as sexual molestation or assault. To prevent allegations of sexual misconduct, the on-site supervisor carefully controls soldiers who perform mixed-gender searches.</b></p>
Segregate	Segregate captives by rank, gender, nationality, and status.
Silence	Do not allow captives to speak or allow anyone to speak to them. Speak to captives only to give orders.
Speed	Remove captives from the battlefield as quickly as possible.
Safeguard	Safeguard captives according to the Geneva Conventions and the US policy. Provide medical care as needed.
Tag	<p>Tag captives with a DD Form 2745 or a field-expedient capture tag that includes the following information:</p> <ul style="list-style-type: none"> <li>• Date of capture.</li> <li>• Location of capture (grid coordinates).</li> <li>• Capturing unit.</li> <li>• Special circumstances of capture (how the person was captured, if he resisted, if he gave up, and so forth).</li> </ul> <p><b>NOTE: The capturing unit must complete a capture tag because failure to do so hinders further processing and disposition.</b></p>

## COLLECTING POINTS AND HOLDING AREAS

3-8. When a captive arrives at a division CP or a CHA, he is processed by the STRESS method. The basic principles are search, tag, report, evacuate, segregate, and safeguard (see STANAG 2044).

### Search

3-9. Search and inspect each captive and his possessions. Conduct same-gender searches when possible. If mixed-gender searches are necessary for speed or security, conduct them in a respectful manner and avoid any action that could be interpreted as sexual molestation or assault. To prevent allegations of sexual misconduct, the on-site supervisor carefully controls soldiers who perform mixed-gender searches. Some items can be retained during captivity, some items are impounded and eventually returned, and certain items are confiscated and never returned, even if the captive is released or repatriated.

3-10. **Retained Items.** A captive is allowed to keep certain items during his captivity. They are generally divided into two groups. The first group consists



of items taken during the receiving portion of inprocessing and returned later in the process. The second group consists of items that the captive can keep at all times. **NOTE: These lists are not all inclusive.**

- Group 1.
  - Military mess equipment (except knives and forks).
  - Helmet.
  - Protective clothing and equipment (NBC suits, helmets, and protective masks) for use during evacuation from the CZ.
  - Personal clothing.
  - Badges of rank and nationality.
  - Military decorations.
  - ID cards and tags.
  - Rations (in the early stages of captivity).
- Group 2.
  - Religious literature (within reason).
  - Personal items having no intelligence value (jewelry and pictures).

3-11. **Impounded Items.** A captive is not allowed to keep impounded items during his internment. They can make escape easier or can compromise US security interests. Impounded items normally include—

- Cameras.
- Radios.
- Currency.
- Negotiable instruments.

3-12. **Confiscated Items.** The following items are confiscated when searching a captive:

- Weapons.
- Ammunition.
- Items of intelligence value (maps and orders).
- Other inappropriate items.

3-13. The MP coordinate with MI interrogation teams to determine which confiscated items have intelligence value. Personal items (diaries, letters from home, and family pictures) can be taken by MI teams for review and then returned to the proper owner via MP.

**NOTES:**

**1. Currency is only confiscated on a commissioned officer's order (see AR 190-8), and it must be accounted for on DA Form 4137.**

**2. For an in-depth discussion on impounded and confiscated property, see AR 190-8 and DFAS-IN 37-1.**

3-14. **Property Accountability.** When seizing property from a captive—

- Bundle it or place it in a bag to keep it intact and separate from other captives' possessions.
- Prepare DA Form 4137 for confiscated and impounded property.

- Prepare a receipt for currency and negotiable instruments to be signed by the captive and the receiver. Use cash collection vouchers so that the value can be credited to each captive's account. List currency and negotiable instruments on the captive's personal-property list, but treat them as impounded property.
- Keep the original receipt with the property during evacuation. Give the captive a copy of the receipt, and tell him to keep it to expedite the return of his property.
- Have MI sign for property on DA Form 4137 and for captives on DD Form 2708.
- Return confiscated property to supply after it is cleared by MI teams. Items kept by MI because of intelligence value are forwarded through MI channels.
- Evacuate retained items with the captive when he moves to the next level of internment.
- Maintain controlled access to confiscated and impounded property.

## Tag

3-15. Tag each captive with a DD Form 2745. The MP at CPs and CHAs check each tag for the—

- Date and time of capture.
- Capturing unit.
- Place of capture.
- Circumstances of the capture.

The remaining information on the tag is included as it becomes available.

3-16. A DD Form 2745 is a perforated, three-part form that is individually serial-numbered. It is constructed of durable, waterproof, tear-resistant material with reinforced eyeholes on Parts A and C. Part A is attached to the captive with wire or string, Part B is maintained by the capturing unit for their records, and Part C is attached to confiscated property so that the owner can be identified later.

3-17. The MP at division CPs ensure that a DD Form 2745 is placed on each captive who arrives at the CP without one. They may direct the capturing unit to complete a capture tag before accepting the prisoner into the CP. The MP—

- Make a statement on the tag if the captive arrived without it.
- Instruct the captive not to remove or alter the tag.
- Annotate the tag's serial number and the captive's name on a locally developed manifest.

**NOTE: See Soldier Training Publication (STP) 21-24-SMCT for more information on DD Form 2745.**

## Report

3-18. Report the number of captives at each CP through MP channels. This aids in the transportation and security planning processes.

## Evacuate

3-19. Evacuate captives from the CZ through appropriate channels as humanely and quickly as possible. Do not delay movement to obtain names, ranks, service numbers, or dates of birth. When moving captives, give them clear, brief instructions in their own language when possible. Military necessity may require a delay in movement beyond a reasonable time. When this occurs, ensure that there is an adequate supply of food, potable water, appropriate clothing, shelter, and medical attention available.

3-20. The MP ensure that the proper paperwork (DA Form 4137, DD Form 515, and DD Form 2708) is complete before captives are evacuated. If necessary, a DD Form 2708 (annotated with the number of prisoners) and a manifest will suffice. Do not expose captives to unnecessary danger, and protect them while they are awaiting evacuation. For seriously wounded or sick captives, medical personnel determine if prompt evacuation is more dangerous than retaining them in the CZ.

## Segregate

3-21. The OIC or the noncommissioned officer in charge (NCOIC) is responsible for the custody of captives. He designates segregation procedures and levels to ensure their security, health, and welfare. Segregate captives into the following categories:

- **Officers, NCOs, and enlisted members (male and female).** Deserters and those who gave up without a fight may be further segregated for their protection. Nationally recognized ideologies and ethnic groups can also be segregated.
- **CIs and refugees.** They are separated from EPWs.
- **US military prisoners.** They are separated from all other prisoners/detainees (EPWs, CIs, ODs, and refugees). (See Chapter 8 for a complete discussion on the confinement of US military prisoners.)

3-22. Ultimately, all captives are classified as an EPW, a CI, or an OD. However, it may be impossible to readily classify all captives. If there is any doubt about a captive's status, protect him under the rules of the Geneva Conventions and the US policy until a competent tribunal can determine his status. (See AR 190-8 for further information.)

3-23. Do not use coercion to obtain information from captives. This includes basic information such as name, rank, service number, and date of birth that captives are required to provide under the Geneva Conventions. Coercion or inhumane treatment of captives is prohibited and is not justified by the stress of combat or deep provocation. Inhumane treatment is a serious violation of international law and the UCMJ.

3-24. Do not speak to captives except to give orders or directions. Do not let captives talk to or signal each other. This prevents them from plotting ways to counter security and plan escapes. An uncooperative captive can be gagged in certain tactical situations; however, only use a gag for as long as needed and ensure that it does not harm the captive.

## Safeguard

3-25. To safeguard captives according to the Geneva Conventions and the US policy—

- Provide first aid and medical treatment for wounded and sick captives. Evacuate them through medical channels, using the assets available to evacuate US and allied forces.
- Provide food and water. These supplies must be commensurate to those for US and allied forces (see FM 27-10 and STANAG 2044).
- Provide firm, humane treatment.
- Allow captives to use protective equipment in case of hostile fire or NBC threat.
- Protect captives from abuse by other captives and local civilians.
- Report acts and allegations of inhumane treatment through MP channels (see AR 190-40).
- Do not locate captives near obvious targets (ammunition sites, fuel facilities, and communications equipment).

## EVACUATING CAPTIVES

3-26. Remove captives from the CZ as quickly as possible. The intent is to move them from division CPs to an I/R facility. The goal is for higher echelons to go forward to lower echelons and evacuate captives to the rear as follows:

- Division MP move forward to the forward CP to escort captives to the central CP.
- Corps MP move forward to the central CP to escort captives to the CHA.
- Echelons above corps (EAC) MP move forward to the CHA to escort captives to the I/R facility.

3-27. If escort guard companies are available in the TO, they are placed under OPCON of the MP commander. They—

- Provide supervisory and security personnel during evacuation and/or movement.
- Go forward to the corps and the division to escort captives to the I/R facility.
- Escort captives from the division forward CP to the corps or the EAC (in coordination with the respective echelon provost marshal [PM]).

## SICK AND WOUNDED CAPTIVES

3-28. Medical personnel decide which captives must be medically evacuated or moved within MP channels, while MP or other command-directed nonmedical personnel provide prisoner security. Generally, walking wounded are moved through MP channels and litter patients are moved through medical channels. The US provides the same medical care for wounded and sick captives as it does for its own forces and allied soldiers. The degree of medical care, not status (such as EPW or CI), determines the disposition of wounded soldiers.

3-29. Seriously wounded or ill captives are stabilized and evacuated through medical channels to the rear area as quickly as possible. If the captive requires medical evacuation—

- Report the captive's medical condition through medical channels to the next higher echelon.
- Request disposition instructions from the corps medical regulating officer (MRO).

3-30. The MRO coordinates transportation and identifies the treatment facility where wounded and sick captives are taken. Accountability for captives within medical channels is the responsibility of the MRO and the hospital commander. They coordinate their efforts with the IRIC.

3-31. The MP determine if there is a security risk during medical evacuation of wounded and sick captives. Ordinarily, captives who require medical evacuation are less likely to be a security risk. However, captives well enough to be a security risk are treated and returned to MP control.

3-32. If medical personnel request MP to guard captives at a medical facility in the corps area and the corps commander chooses to delegate that responsibility to the MP, the PM allocates support on a case-by-case basis. The MP structure is not designed to provide MP to guard hospitalized captives on a continuous, uninterrupted basis.

### **ABLE-BODIED CAPTIVES**

3-33. The MP guard able-bodied captives during movement to prevent escape, liberation, or injury. A general planning consideration when determining the number of MP necessary is one for every five to ten captives. An MP unit tasked to escort captives considers the following information when determining the number of guards needed:

- The mission, enemy, terrain, troops, time available, and civilian considerations (METT-TC).
- The number of captives being moved.
- The condition and morale of the captives. Fatigued and/or cooperative individuals require fewer guards than fresh, motivated individuals.
- The type of transportation and its scheduled arrival.
- The type of terrain along the evacuation route. Routes where dense vegetation is close to the road often require more guards than open, clear terrain.
- The threat level along the route. As the threat level increases, so does the need to increase security. Consider the anticipated presence of suspected sympathizers and hostile, local nationals along the route.
- The location of MP units or bases/base clusters along the route.
- The location and number of rest stops. This is based on the transportation, the distance, and the terrain.

3-34. When moving forward to escort captives to the rear area, MP responsibilities begin at the CP or the CHA where custody is accepted. Verify the method of moving captives, the location and time of pickup, and the number of captives contained in orders from higher headquarters. The MP units cannot transport captives with organic assets.

3-35. The preferred method for moving captives through a battlefield is the *backhaul* system. This transportation system relies on assets that have delivered their primary cargo and are available to move personnel and materials to another location. The availability of vehicles will vary, depending on the cargo delivered to the area. The command and control (C<sup>2</sup>) element of the MP unit tasked with evacuation arranges transportation through the local MCO.

3-36. If the backhaul system cannot be employed, the MP unit guarding the captives requests an alternate means of transportation. Captives are moved on foot only as a last resort and upon approval of the MP unit commander.

## **DIVISION COLLECTING POINTS**

3-37. A division operates two types of CPs—forward and central. A division MP company operates forward CPs in each maneuver brigade AO and a central CP in the division rear area. Both CPs are temporary areas designed to hold captives until they are removed from the battlefield. Forward CPs are positioned as far forward as possible to accept captives from maneuver elements. Central CPs accept captives from forward CPs and local units.

### **FORWARD COLLECTING POINTS**

3-38. Forward CPs (Figure 3-2) are needed when a brigade conducts an offensive operation and is likely to take captives. When a maneuver brigade has an MP platoon in direct support (DS), MP teams set up and operate forward CPs. A brigade without an MP platoon in DS sets up and operates its own forward CPs.

3-39. The number of MP teams needed to operate a forward CP is based on the number of captives expected and METT-TC. The projected number of captives is based on mission analysis and intelligence estimates conducted by the brigade Intelligence Officer (US Army) (S2). Division forward CPs are mobile; they can be set up, expanded, and relocated quickly as the tactical situation warrants.

### **Location**

3-40. The brigade operation plan (OPLAN) or operation order (OPORD) provides the general location of forward CPs. They are located near or in the brigade support area (BSA), in an area that prevents captives from observing activities within the BSA. They are also located near main supply routes (MSRs) to make delivery, evacuation, and resupply easier.

### **Medical Support**

3-41. Medical support is provided by the MP company medical section. Additional medical support can be requested through the forward support battalion (FSB) to the brigade medical officer. The brigade OPORD includes specific actions and support (operational requirements) needed from non-MP units.

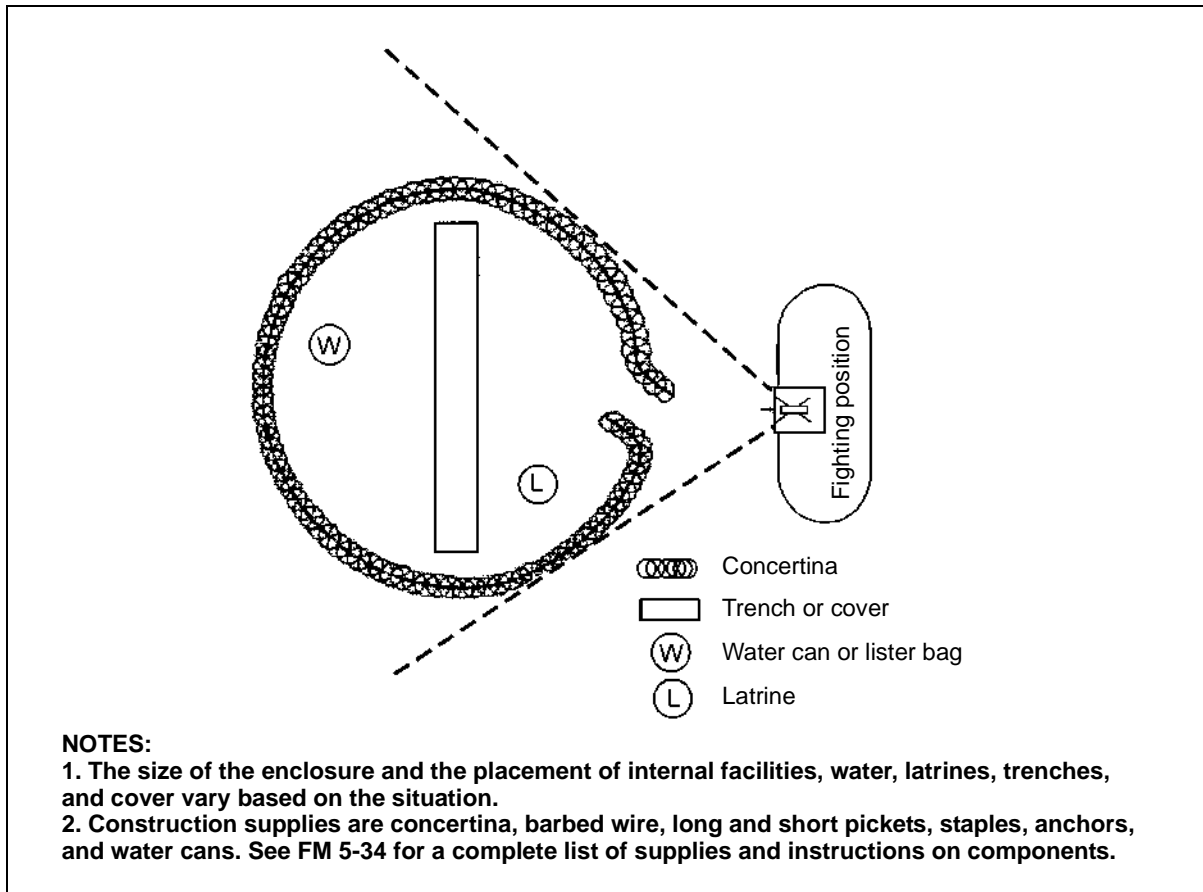


Figure 3-2. Forward CP

### Planning Considerations

3-42. When a division MP company commander is tasked with planning and operating a forward CP, he—

- Coordinates with the unit responsible for the area.
- Conducts a recon of the area before selecting a location.
- Locates it far enough from the fighting to avoid minor shifts in the main battle area (MBA) (normally 5 to 10 kilometers).
- Notifies the BSA tactical operations center (TOC) and the PM operations section of the selected location (grid coordinates). The BSA TOC reports the location to the brigade TOC, and the brigade TOC notifies subordinate units.
- Coordinates with MI on collocating an MI interrogation team at the CP.
- Provides potable water and, if required, food for captives.

3-43. A forward CP is seldom located near the indigenous population to prevent problems caused by the presence of captives in the area. A forward CP is usually a guarded, roped-off area (concertina or razor tape) or a secure, fixed facility. The capture rate and the captive categories determine the size of

the forward CP. If possible, use existing structures (vacant schools, apartments, and warehouses) to conserve resources and provide protection for captives. When selecting a location, consider—

- Security.
- Medical support.
- Food and potable water.
- Field sanitation (latrine facilities).
- Shelter.
- Cover. (Captives can dig or build cover to protect themselves from direct and indirect fire.)
- Access routes.

### **Accountability**

3-44. Account for each captive and his equipment when they arrive at the forward CP.

### **Evacuation**

3-45. Captives should not remain at a forward CP more than 12 hours before being escorted to the central CP. When they have been processed and are ready for evacuation, MP leaders—

- Report the status to the BSA TOC and the PM (through MP channels).
- Request transportation, rations, and water from the FSB Supply Officer (US Army) (S4).
- Ensure that receipts are ready for signature.
- Ensure that property is properly tagged and given to escort guards.

## **CENTRAL COLLECTING POINTS**

3-46. A central CP (Figure 3-3) is larger than a forward CP, but it has a similar setup and operation. The larger holding capacity of a central CP requires additional MP. If sufficient MP are unavailable, it is augmented by a division, corps, or EAC band to assist with perimeter security. Captives are provided food, water, first aid, and medical attention as required.

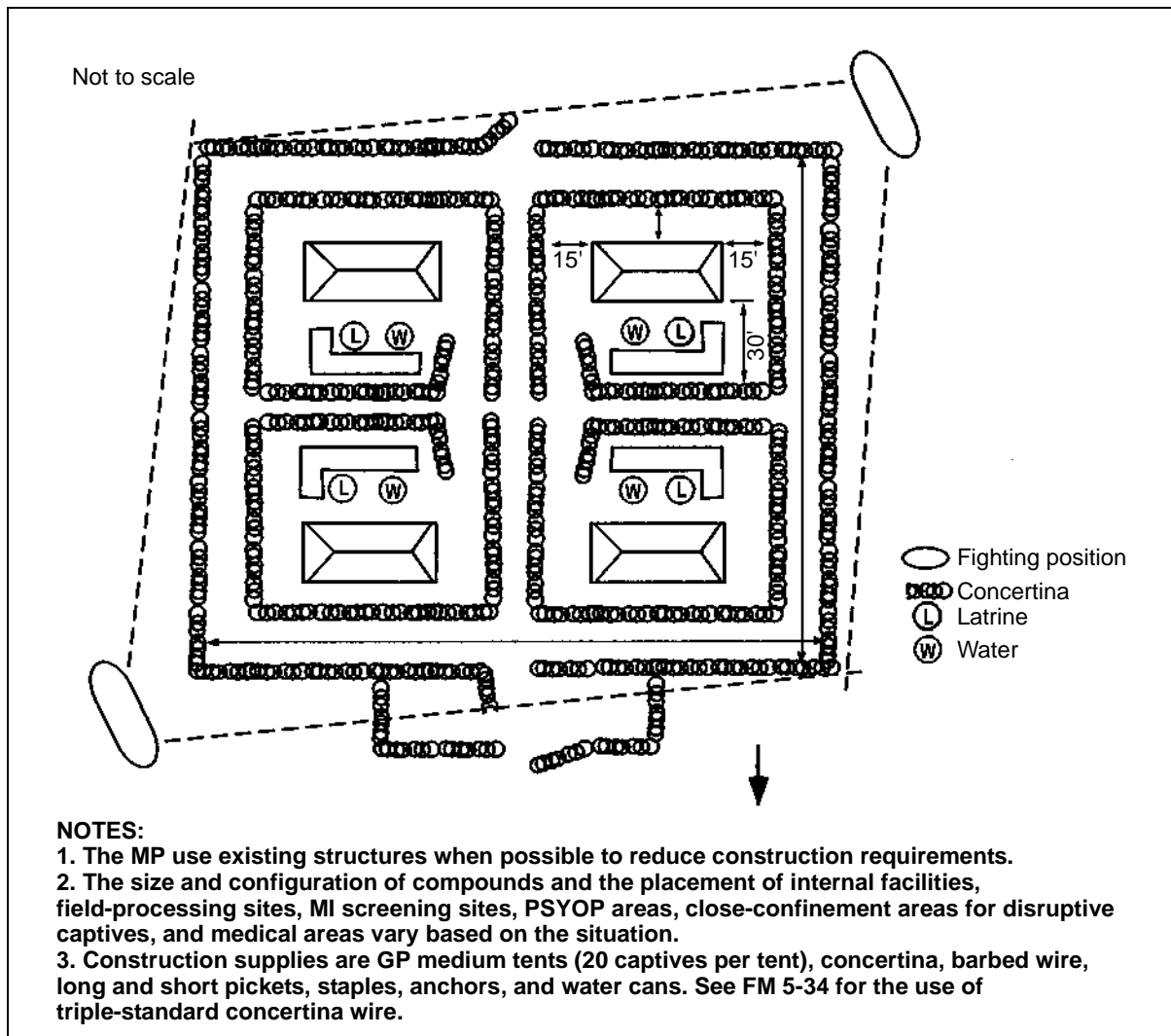
### **Location**

3-47. As stated in the division OPLAN or OPORD, a central CP is located near the division support area (DSA) in an area that prevents captives from observing activities within the DSA. It is also located near MSRs to make delivery, evacuation, and resupply easier.

### **Medical Support**

3-48. Prevent captives from incurring disease and nonbattle injuries (DNBI) (heat and cold injuries or communicable diseases) while in captivity. Isolate captives who exhibit obvious signs of disease (diarrhea, vomiting, or fever) until medical personnel make an evaluation. If a large number of captives appear ill, notify medical and command channels for immediate action/treatment.





**Figure 3-3. Central CP**

- 3-49. The division PVNTMED section supports the central CP by—
- Monitoring drinking water and advising on disinfection procedures.
  - Controlling animals and insects that carry disease.
  - Ensuring that captives help prevent illness by—
    - Drinking enough water.
    - Wearing clothing that is suited for the weather and the situation.
    - Handling heating fuels carefully.
    - Avoiding contact of exposed skin to cold metal.
    - Using insect repellent, netting, and insecticides.
    - Taking approved preventive medication.
    - Using purification tablets when water quality is uncertain.
    - Disposing of bodily wastes properly.
    - Practicing personal hygiene.

## Planning Considerations

3-50. When a division MP company commander is tasked with establishing and operating a central CP, he—

- Coordinates with the unit responsible for the area.
- Conducts a recon of the area before selecting a location.
- Notifies the PM of the exact location (grid coordinates). The PM notifies the division rear CP operations cell, who notifies area units.
- Coordinates with MI on collocating an MI interrogation team at the CP.
- Ensures that the location is accessible to units escorting captives from forward CPs.

3-51. Like a forward CP, a central CP is seldom located near the indigenous population. Use existing structures, when available, to conserve resources. If structures are unavailable, construct the central CP from similar material as forward CPs. However, a central CP is larger and must contain some type of tentage or shelter to protect captives from the elements. A bunker in each compound or free access to a bunker is needed to protect captives from direct and indirect fire. Enlisted captives can be tasked to help construct a central CP (especially bunkers); however, officer captives cannot be used.

3-52. A central CP is as mobile as a forward CP. It must also be set up, expanded, and relocated quickly as the tactical situation dictates. Units within the DSA provide support as stated in the division OPORD. The MP company medical section provides medical support to personnel in the central CP, and additional medical support can be requested from the command surgeon.

## Accountability

3-53. Account for each captive and his equipment when they arrive at the central CP. Use the STRESS method to process captives who are brought directly to the central CP by a capturing unit (see paragraph 3-8).

## Evacuation of Captives

3-54. Captives should not remain at the central CP more than 24 hours before being evacuated to the CHA. When all captives are accounted for, processed, and ready for evacuation to the CHA, MP leaders—

- Report the status to the division rear CP and to the PM (through MP channels).
- Request transportation, rations, and water through logistics channels in the division rear.
- Ensure that receipts are ready for signature.
- Ensure that property is tagged with Part C of DD Form 2745 and given to the escort guards.

## CORPS HOLDING AREAS

3-55. A CHA (Figure 3-4) can hold more captives for longer periods of times than a central CP. Depending on the availability of MP units to establish I/R facilities, corps MP units must be prepared to hold captives at the CHA more than 72 hours. If the CHA keeps captives more than 72 hours, MP must plan and coordinate for the increased logistics and personnel required to operate a long-term facility. The decision to hold captives longer is based on METT-TC and the availability of forces. Captives remain in the CHA until they are evacuated to an I/R facility or until hostilities end.

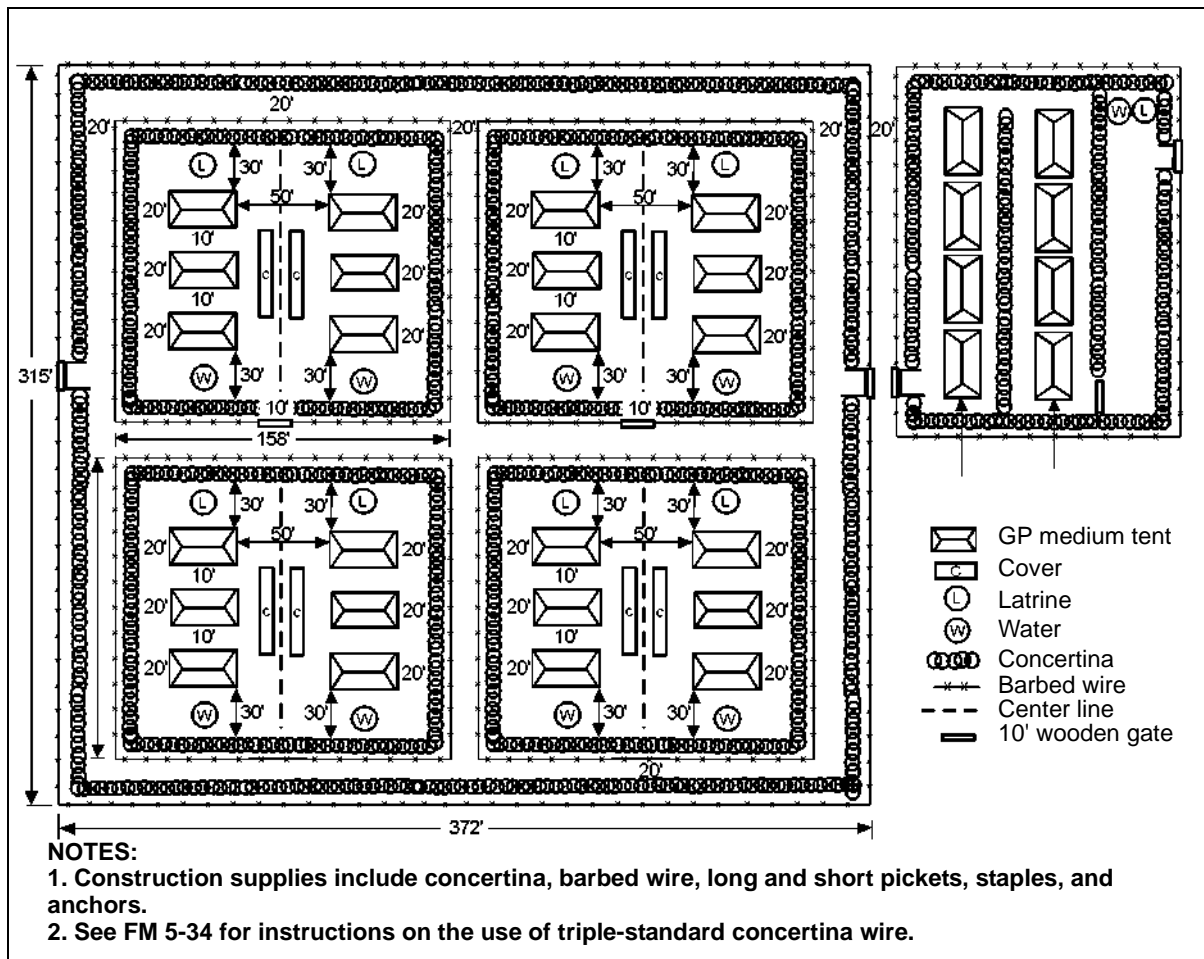


Figure 3-4. Corps Holding Area

3-56. A CHA receives captives from CPs and units that capture them in the rear area. Usually, one CHA is established to support each division conducting operations. However, additional CHAs may be required based on the—

- Size of the corps area.
- Type of terrain.
- Length of the LOC between the CHA and the division central CPs.
- Number of captives being moved.

## LOCATION

3-57. A CHA is usually located near a base or a base cluster in the corps rear area. When selecting a site—

- Coordinate with the unit responsible for the area (terrain) and the corps rear CP.
- Conduct a recon to select a location.
  - Is it adjacent to an MSR, a railroad, or an airfield?
  - Are existing buildings available?
  - Is it close to supply facilities?
  - Is it easily protected from enemy activities?
- Ensure that the location allows division of the site into two or more compounds for segregation, security, and ease of control.
- Report the exact location (grid coordinates) through MP channels to the unit responsible for the area. The MI coordinates with MP on collocating an MI interrogation team at the CP. However, MP may have to contact MI to initiate the action.
- Ensure that the site is accessible to units escorting captives from division central CPs.

## CONSTRUCTION

3-58. A CHA is more permanent than CPs. Existing structures may be used and are preferred. The capture rate and the captive categories determine the size of the CHA. A multistory building has a smaller perimeter to guard; however, it requires using guards on each floor and may present a security risk for the guards. Depending on the tactical situation, perimeter lighting can be used.

3-59. When constructing a CHA, divide it into two or more compounds for segregation, security, and ease of control. Consider providing more than one entrance into the CHA. Include a reception area for further processing, searching, and examining of selected captives by MI. Include sanitary facilities (showers and latrines) and shelter (tentage and existing buildings) from the elements and direct and indirect fire.

## GUARD FORCE

3-60. The exact CHA setup and design depend on many factors, including construction materials, terrain, and forces. An MP platoon or company from a corps MP battalion usually operates a CHA. A platoon can guard 500 captives, while a company can guard 2,000. During mass captures, a guard force augmentation may be required to handle unexpected workload. The corps band can augment MP guards to aid in security. As the population of the CHA increases, evacuations to the I/R facility also increase.

## LOGISTICS

3-61. Request supplies through logistic channels for construction, maintenance, and day-to-day operations of a CHA. Support agreements can be arranged between MP headquarters and a base or base cluster where the CHA is located. Plan ahead to provide food and water.

---

## MEDICAL AND SANITATION CONSIDERATIONS

3-62. The CHA guards isolate wounded captives and captives suspected of having a communicable disease until medical personnel can examine them (see Chapter 2). Take necessary sanitary measures to ensure a clean, healthy CHA and to prevent epidemics. Request PVNTMED units to assist and advise unit field sanitation teams on—

- The survey and control of disease-carrying insects and rodents.
- Sanitary engineering (water treatment and waste disposal).

## EVACUATION

3-63. The procedures used to escort captives from division forward and central CPs to a CHA are also used to escort captives from a CHA to an I/R facility.

## COLLOCATED SCREENING SITES

3-64. To facilitate collecting enemy tactical information, MI may collocate interrogation teams at CPs and CHAs. This provides MI with direct access to captives and their equipment and documents. Coordination is made between MP and MI to establish operating procedures that include accountability. An interrogation area is established away from the receiving/processing line so that MI personnel can interrogate captives and examine their equipment and documents. If a captive or his equipment or documents are removed from the receiving/processing line, account for them on DD Form 2708 and DA Form 4137.

## INTERROGATION TEAMS

3-65. The MI interrogation teams screen captives at CPs and CHAs, looking for anyone who is a potential source of information. Screeners observe captives from an area close to the dismount point or processing area. As each captive passes, MI personnel examine the capture tag and look for branch insignias that indicate a captive with information to support command priority intelligence requirements (PIR) and information requirements (IR). They also look for captives who are willing or attempting to talk to guards; joining the wrong group intentionally; or displaying signs of nervousness, anxiety, or fear.

3-66. The MP assist MI screeners by identifying captives who may have answers that support PIR and IR. Because MP are in constant contact with captives, they see how certain captives respond to orders and see the type of requests they make. The MP ensure that searches requested by MI are conducted out of sight of other captives and that guards conduct same-gender searches.

3-67. The MI screeners examine captured documents, equipment and, in some cases, personal papers (journals, diaries, and letters from home). They are looking for information that identifies a captive and his organization, mission, and personal background (family, knowledge, and experience). Knowledge of a captive's physical and emotional status or other information helps screeners determine his willingness to cooperate.

## LOCATION

- 3-68. Consider the following when planning an MI screening site:
- The site is located where screeners can observe captives as they are segregated and processed. It is shielded from the direct view of captives and is far enough away that captives cannot overhear screeners' conversations.
  - The site has an operation, administrative, and interrogation area. The interrogation area accommodates an interrogator, a captive, a guard, and an interpreter as well as furniture. Lights are available for night operations.
  - Procedures are implemented to verify that sick and wounded captives have been treated and released by authorized medical personnel.
  - Guards are available and procedures are implemented for escorting captives to the interrogation site.
  - Procedures are published to inform screeners who will be moved and when they will be moved.
  - Accountability procedures are implemented and required forms are available.

## COLLECTING POINTS IN OTHER OPERATIONS

- 3-69. The CPs can also be operated during river crossing, amphibious, airborne, armored, and air assault operations:
- **River crossing operations.** Establish temporary CPs on entry and exit sides of the river (corps MP often take control of CPs). Return from the exit bank and evacuate captives to the rear, preventing interference with tactical operations and protecting captives from hostile fire. Coordinate with traffic control personnel at the crossing site to prevent interference with assault forces who are moving forward. Use a secondary crossing site if available.
  - **Amphibious operations.** The assault force initially operates CPs in the beachhead and then escorts captives to designated ships. The MP coordinate with the support force for handling captives after they are escorted from the beachhead. When facilities, supplies, and personnel permit, retain captives in the objective area if they can be protected from enemy fire.
  - **Airborne operations.** The METT-TC considerations for collecting captives include the geographical location of the airhead, the tactical plan, the availability of transportation, and plans for linking up with ground forces. Captives are primarily moved by air during the early stages of the operation, which requires CPs to be established near landing zones (LZs). Consider attaching additional MP elements from area EAC to guard captives during evacuation.
  - **Armored operations.** Armored units can penetrate deep into hostile territory, bypassing pockets of enemy resistance on their way to the objective. This leaves isolated enemy units on the battlefield, which may hinder the normal evacuation of captives to the rear area. Hold captives at the CP until they can be safely evacuated from the battlefield.

- **Air assault operations.** Organic MP elements accompany assault elements to the objective. Establish CPs near LZs and airfields where the evacuation process begins. If necessary, attach nondivisional MP elements to guard captives during evacuation.

## Chapter 4

# Enemy Prisoners of War

Chapters 3 and 4 implement STANAG 2044.

The MP are responsible for evacuating EPWs from division CPs to CHAs and then to internment facilities (normally located in the COMMZ). This chapter addresses procedures for properly handling, processing, and safeguarding EPWs. The procedures outlined in this chapter are also applicable to RPs. (See Chapter 1 for complete definitions and AR 190-8 for more details.)

### EVACUATION

4-1. Corps MP commanders evacuate EPWs from CHAs to internment facilities promptly and safely. Their responsibilities include security, accountability, and support. They also account for equipment and documents and provide escort guards if an escort guard company is unavailable.

4-2. Escort guard companies are responsible for EPW operations in the TO, and they escort EPWs from CHAs to internment facilities. They are assigned to MP I/R battalions and brigades. However, if they arrive before MP I/R units, they are attached to MP CS brigades. To expedite prompt, full evacuation of EPWs, escort guards can be pre-positioned in CHAs so that they are continuously available.

4-3. The evacuation chain normally moves EPWs from a division forward CP to a division central CP, to a CHA, and then to an internment facility. When circumstances permit, such as taking advantage of available transportation, evacuation procedures may bypass one or more echelons below corps (EBC) facilities.

### RECEIVING AND PROCESSING AREAS

4-4. Receiving and processing begin when EPWs arrive. However, due to limited manning, these functions are not operational 24 hours a day. An internment facility receives, secures, houses, and feeds EPWs until receiving and processing lines are operational. The EPWs are then brought forward, and the internment process begins.

4-5. Use a controlled-flow format to escort EPWs through the processing line. Normally, four EPWs are processed at a time and the average is eight per hour. These numbers may increase or decrease based on the capture rate and the nature of the operation. Secure unprocessed EPWs in a holding area.



4-6. Request interpreters from MI, PSYOP, allied forces, or local authorities as necessary. This may require identifying and clearing trusted EPWs or local nationals to interpret. Interpreters are usually necessary when entering data into the Internment/Resettlement Information System (IRIS).

4-7. The preparation and dispatch of DA Forms 2674-R are governed by AR 190-8, and they are prepared at each internment facility. Brigade or internment facility commanders may require feeder reports from various compounds to facilitate the preparation of internee strength reports.

**NOTE: See STANAG 2044 for more information on reports and accountability as they apply to NATO TOs.**

4-8. Table 4-1 outlines the internment process for EPWs. It shows who is responsible for each step and what actions they must accomplish. Based on METT-TC, the commander may tailor stations to meet the situation. Stations 1 through 4 are in the receiving line, and Stations 5 through 9 are in the processing line.

**Table 4-1. Processing Actions at the EPW Processing Area**

Station	Purpose	Responsible Individuals*	Actions
<b>Receiving Line</b>			
1	Search	MP	Assign ISNs. Follow accountability procedures. Escort EPWs and their property. Strip-search EPWs (by MP of the same sex) before entering the processing area unless prohibited by conditions. Remove and examine property, place it in a container or a tray, mark it with a control number, and take it to a temporary storage area. (Some property may be returned in the processing line.) Supervise the movement of EPWs to the next station.
2	Personal hygiene	MP and processed EPWs (when possible)	Allow EPWs to shower, shave, and get haircuts. Disinfect EPWs using the guidelines established by the PVNTMED officer. Supervise the movement of EPWs to the next station.
*The number of people used to perform tasks depends on the number of EPWs and the amount of time available. Other soldiers assigned to the unit may perform non-MP-specific tasks if necessary.			

Table 4-1. Processing Actions at the EPW Processing Area (continued)

Station	Purpose	Responsible Individuals*	Actions
3	Medical evaluation	Medical personnel and MP	<p>Inspect EPWs for signs of illness or injury.</p> <p>Evacuate EPWs who need treatment at a medical facility.</p> <p>Give immunizations or request immunization support from the supporting medical unit before internment or evacuation.</p> <p>Initiate treatment and immunization records.</p> <p>Place control numbers on medical records to reduce linguist support. (Names, service numbers, and ISNs are entered at Station 1 with the aid of an interpreter.)</p> <p>Annotate medical records with the date and place EPWs were inspected, immunized, and disinfected.</p> <p>Weigh EPWs and establish a weight register.</p> <p>Supervise the movement of EPWs to the next station.</p>
4	Personal items	MP	<p>Issue personal-comfort items (toilet paper, soap, toothbrush, and toothpaste).</p> <p>Issue clothing (clean and distinctive, like brightly colored jumpsuits if available) that is—</p> <ul style="list-style-type: none"> <li>• Taken from EPWs at Station 1.</li> <li>• Obtained from captured enemy supplies.</li> <li>• Obtained through normal supply channels.</li> </ul> <p>Ensure that clothing is marked "PW" as required.</p> <p>Escort EPWs to the processing area (Station 5).</p>
<b>Processing Line</b>			
5	Administrative accountability	Processing clerk (assisted by an interpreter, MI, or others) and MP	<p>Ensure that ISNs are assigned to EPWs. Note the capture tag numbers that ISNs are replacing so that late-arriving property can be matched to its owner.</p> <p>Initiate personnel records, ID documents, and property receipts.</p> <p>Use digital equipment to generate forms and records.</p> <p>Prepare forms and records to maintain the accountability of EPWs and their property (STANAG 2044).</p> <p>Prepare forms for repatriation or international transfer as specified in local regulations or SOPs.</p> <p>Supervise the movement of EPWs to the next station.</p>
*The number of people used to perform tasks depends on the number of EPWs and the amount of time available. Other soldiers assigned to the unit may perform non-MP-specific tasks if necessary.			

**Table 4-1. Processing Actions at the EPW Processing Area (continued)**

Station	Purpose	Responsible Individuals*	Actions
6	Photography and fingerprinting	MP	<p>Fingerprint EPWs. Identify and record the information on fingerprint cards.</p> <p>Take two photographs (with instant film or digital technology). Have EPWs look straight ahead, and fill the frame with their face.</p> <p>Use photograph name boards (black background with white characters). List ISNs and names (translated into English) at the bottom center.</p> <p>Attach one photograph to the EPW's personnel record.</p> <p>Give a completed, laminated ID card (which contains the second photograph) to the EPW.</p> <p>Supervise the movement of EPWs to the next station.</p>
7	Personal property	MP	<p>Inventory and record property (in the presence of EPWs) brought from temporary property storage areas.</p> <p>Make separate lists for returned, stored, impounded, and confiscated property. List property to be returned to EPWs or stored during internment on a separate list.</p> <p>Provide receipts for property placed in temporary storage.</p> <p>Provide receipts for money placed in EPW accounts (AR 190-8 and DFAS-IN 37-1).</p> <p>Return retained property that was taken from the EPW at Station 1.</p> <p>Supervise the movement of EPWs to the next station.</p>
8	Records review	MP	<p>Review processed records for completeness and accuracy.</p> <p>Escort EPWs back to processing stations to correct errors if necessary.</p> <p>Let EPWs prepare notification-of-capture cards. If being interned at the same place as processing, let EPWs prepare notification-of-address cards. If EPWs are unable to write their own cards, have someone authorized by the commander to do it for them.</p> <p>Prepare and maintain an accountability roster of all EPWs.</p>
9	Accountability transfer	MP	<p>Sign for and take custody of EPWs (can use movement manifest), their records, and their impounded property if moving to another facility.</p> <p>Evacuate or ship impounded property separately according to JTRs.</p>
<p>*The number of people used to perform tasks depends on the number of EPWs and the amount of time available. Other soldiers assigned to the unit may perform non-MP-specific tasks if necessary.</p>			

---

## RECEIVING LINE

4-9. When EPWs arrive at the internment facility, segregate them from those who arrived earlier and those who are partially processed. Count the EPWs and match them against the manifest and the receipts for them and their equipment.

4-10. Field-process each EPW if the capturing unit or the CP did not field-process him (Chapter 3). Ensure that he receives the serial number from his capture tag (DD Form 2745). (The number is used to track him until he receives an internment serial number [ISN]).

4-11. Record his capture tag serial number and last name on an ID band. Use a banding kit to attach the band to his left wrist. Match his capture tag serial number with the number on his personal property, or if necessary, mark his capture tag serial number on his personal property.

4-12. Store personal property in a temporary storage area until EPWs are fully processed, and control access to the storage area. Ensure that EPWs receive food and water and, if necessary, first aid and medical treatment. Take them to the processing area as soon as the receiving process is complete. If they cannot be processed immediately, hold them in the receiving area.

## PROCESSING LINE

4-13. After EPWs have completed the receiving portion of their processing, move them to the processing line, where they are formally processed into the facility. They are entered into the IRIS database, and the IRIC forwards the information to the national IRIC for dissemination to the protecting power. The processing element—

- Keeps segregated EPWs apart as much as possible during processing.
- Conducts administrative processing.
- Expedites the processing of EPWs selected by MI teams for interrogation.
- Assigns each EPW an ISN.
- Replaces the control number on each EPW's wrist with his ISN.

## PERSONNEL FILE

4-14. Ensure that the following forms are included in each EPW's personnel file:

- DA Form 1131-R. Use this voucher to verify the balance of funds.
- DA Form 1132-R. List the EPW's personal property on this form.
- DA Form 2662-R. Issue this card if the EPW does not hold one from his country.
- DA Form 2663-R. Prepare this card for each EPW upon processing into the facility.
- DA Form 2664-R. Initiate this form upon inprocessing and update it monthly.
- DA Form 4137. Record confiscated currency on this form.
- DA Form 4237-R. Prepare this form for each EPW processed into the facility.

- DD Form 2708. Use this form to account for evacuated EPWs, regardless of the evacuation channel.
- DD Form 2745. File Part B of this tag in the personnel record.

### **INTERNMENT SERIAL NUMBER**

4-15. The national IRIC forwards blocks of ISNs to designated IRICs in the TO and CONUS as required. The ISNs are used to identify EPWs in US custody. Each ISN is a unique, individual number; no two are alike. An ISN consists of two parts:

- The first part contains the letters "US," a number indicating the TO where the EPW came into US custody, and two letters representing the EPW's country of origin.
- The second part is a series of six numbers that are assigned (in sequential order) to each EPW processed in the command. The numbers are followed by the letters "EPW," "CI," "RP," or "OD" to denote the EPW's category.

For example, the first EPW processed by the US Army in TO 9, whose country designation is AB, is assigned ISN US9AB000001EPW.

4-16. If the situation permits, the IRIC processes EPWs at division CPs and CHAs. Assign ISNs as early as possible. However, if an ISN is not assigned until Station 1 (see Table 4-1, page 4-3), use the capture tag number, the manifest number, or another control number until an ISN is assigned.

**NOTE: See STANAG 2044 and AR 190-8 for additional information on ISNs.**

### **IDENTIFICATION BAND**

4-17. The EPW ID bands are used to—

- Verify EPW rosters against the compound population.
- Identify compound work details.
- Match EPWs with their medical records.
- Check identities of EPWs being transferred or repatriated against transfer rosters.
- Permit rapid, reliable ID of EPWs.
- Enhance facility administration and operation.

4-18. An EPW can remove his ID band, but doing so destroys the band so that someone else cannot use it without being detected. The MP cannot prevent EPWs from destroying bands; however, most EPWs accept the use of the band for ID purposes.

4-19. Record the EPW's ISN and last name on his ID band, and secure it to his left wrist. To enhance facility administration and operation, use various colored bands to further identify EPWs by category. For example, use—

- Blue for officers.
- Red for NCOs.
- Yellow for enlisted soldiers.
- Black for RPs.

- Green for CIs.
- White for ODs.

If EPW ID bands are unavailable, use a medical wristband or something similar.

4-20. When serious deterioration is detected or the ISN and name is obscured, replace the ID band with a new one. Conduct periodic, random checks to detect wear and tear and efforts to destroy the band. In addition, look for efforts to exchange bands between EPWs (removing the ID band results in damage that is easily detected). When firm ID is needed, such as transfer or hospitalization, carefully examine the ID band for evidence of having been removed. Conduct periodic, routine inspections of randomly selected ID bands in dining-facility lines, during compound inspections, and at other opportune times.

## FLOW OF INFORMATION

4-21. Regard the information collected from EPWs as sensitive to protect them and the soldiers who are guarding them. If belligerent nations discover how many EPWs are in a facility or discover the location of a facility, it may be targeted to silence the sources of information. Maintain proper security throughout the information flow, and disseminate information through proper channels. The IRIC acts as a hub for information that CHAs and internment facilities produce. Report personnel records electronically on the IRIS or, if necessary, as a paper file.

4-22. The information flow begins when the EPW is captured and a DD Form 2745 is initiated. The ISN, which is assigned upon arrival at a CHA or an internment facility, is the key to tracking EPWs throughout the I/R system.

4-23. Information collected during processing (initial and full) and entered into the IRIS (CHA or internment facility) is sent to the IRIC. The IRIC collects the entire personnel file; it is normally electronic with a hard-copy backup. The internment facility reports the information to the IRIC, who disseminates it as appropriate. The strength report (DA Form 2674-R) is the only information passed up the internment facility's chain of command. Questions regarding the information or EPW flow in the TO are directed to the IRIC.

**NOTE: Hasty processing can be initiated if normal processing cannot be done in a reasonable amount of time (normal processing is completed later).**

## Initial Processing

4-24. During initial processing (at the point of capture), gather critical information from EPWs and assign ISNs. The minimum information needed during initial processing is the—

- Complete name (first, middle, and last).
- Service number.
- Rank.
- Capturing unit.

- Date of capture.
- Place of capture (grid coordinates).
- Circumstances of capture.

4-25. The above information (along with the capturing country, the TO, the power served, the sequence number, and the EPW category) is enough to move the EPW into an internment facility where additional information is gathered. Much of the information is gleaned from the capture tag. The IRIC provides block ISNs, and other information is theater- and situation-driven. The initial processing is quick and effective.

### **Intermediate Processing**

4-26. Per AR 190-8, the national IRIC is responsible for collecting the following items to complete the intermediate processing:

- The date of birth.
- The city of birth.
- The country of birth.
- The name and address of next of kin (NOK) (father/mother).
- The location of confiscated property.
- The nationality.
- A general statement of health.
- The nation in whose armed services the individual is serving.
- The name and address of a person to be notified of the individual's capture.
- The address to which correspondence may be sent.
- Certificates of death or authenticated lists of the dead.
- The location of war graves (grid coordinates) and particulars of the dead.
- The notification of capture (including the date sent).
- The list of personal articles of value not restored upon repatriation.

### **Full Processing**

4-27. Remember, an EPW is only required to give his name, rank, and service number. However, collect additional information if possible. An EPW is considered fully processed when the personnel file is complete. This includes the fields completed during initial and intermediate processing and those listed below:

- Education.
- Religion.
- Marital status.
- Internment facility unit identification code (UIC).
- Sex.
- Languages spoken.
- Internment facility location.
- Enemy unit.
- Arm of service.

- 
- Military occupational specialty (MOS).
  - Civilian occupational specialty (COS).
  - Corps area of capture.
  - Mother's maiden name.
  - Permanent home address.
  - Other particulars from the ID card.
  - Distinguishing marks.
  - Impounded personal property and money.
  - Photograph.
  - Prepared by, date prepared, place prepared, and signature.
  - Immunizations.
  - Internment employment compensation.
  - Serious offenses, punishments, and escapes (including dates).
  - Transfers.
  - Financial status at the time of first and second international transfers.
  - Repatriation.
  - Financial status at the time of repatriation.
  - Remarks.

## **ASSIGNMENT TO INTERNMENT FACILITIES**

4-28. Selectively assign EPWs to internment facilities that best meet their needs and the needs of the detaining power. To prevent problems, isolate EPWs from the general population if they hold violent, opposing ideologies. After EPWs are assigned to a facility, they may be further segregated due to nationality, language, and so forth. Normally, EPWs are segregated into the following categories:

- Officer.
- NCO.
- Enlisted.
- CI.
- RP.
- Male.
- Female.

4-29. The EPWs may be further assigned to separate compounds. Always intern females in compounds that are separate from males. Further separation of EPWs may be necessary depending on security issues. (See Chapter 6 for further information on I/R facilities.)

## **CLASSIFICATION AND REASSIGNMENT**

4-30. The initial classification of an EPW is based on unsupported statements or documentation provided by them. Assignment to a specific compound within the internment facility is based on the assumption that the identity provided by the EPW is correct.



4-31. After an EPW is assigned to a facility, expect a continuing need for further reclassification and reassignment. Because the identity of the EPW was based on unsupported statements or documentation supplied by him, it may be necessary to reclassify him a second time as his identity becomes apparent. Agitators, enemy plants, or EPW leaders are eventually uncovered by their activities. They may be reclassified according to their new identity or ideology and reassigned to a more appropriate facility.

4-32. Anticipate the reclassification and reassignment of EPWs within the facility or to other facilities. The initial classification may be challenged by the EPW or MP assets. An individual may provide statements or documents that indicate he should be reclassified, or observations made by MP or MI may determine that an individual was incorrectly classified.

## **TRIBUNAL**

4-33. A tribunal is held according to Article 5, GPW. It determines the status of an individual who does not appear to be entitled to EPW status but—

- Commits a belligerent act to aid enemy armed forces.
- Engages in a hostile activity to aid enemy armed forces.
- Asserts that he or she is entitled to treatment as an EPW.

## **TRANSFER BETWEEN FACILITIES**

4-34. A transfer may be a result of reclassification or another situation requiring the movement of an EPW. Transfer an EPW from one facility to another under conditions that are comparable to those for a member of the US armed forces when possible. Security measures are determined by MP and are influenced by the type of EPW being transferred, the mode of transportation used, and other pertinent conditions.

4-35. The facility commander—

- Publishes a transfer order and informs EPWs of their new postal addresses in time for them to notify their NOK and the IRIC.
- Verifies the accuracy and completeness of EPW personnel records and provides records (in a sealed envelope) to MP accompanying the movement.
- Verifies that EPWs possess their authorized clothing and equipment.
- Prepares impounded personal property for shipment with escorting MP or separate shipment as appropriate.
- Briefs escort MP on their duties and responsibilities, including procedures to be followed in case of an escape, a death, or another emergency.
- Provides or arranges for rations, transportation, and notifications according to prescribed procedures.
- Ensures that EPWs are manifested by name, rank/status, ISN, power served, nationality, and physical condition. Attach the manifest to the original receipt and forward it to the IRIC.
- Prepares paperwork in English and other languages (if required) before transferring EPWs.

4-36. Each EPW can transfer personal property not exceeding 55 pounds. Chaplains and EPWs who have been serving as clergymen are permitted to transfer an additional 110 pounds to cover communion sets, theological books, and other religious material. If an EPW's personal property exceeds 55 pounds, he selects the items he is going to transfer and disposes of the rest according to established policies.

#### **TRANSFER TO HOST NATION OR ALLIED FACILITIES AND INTERSERVICE**

4-37. The permanent transfer of an EPW from the custody of US forces to the HN or other allied forces requires the approval of the Secretary of Defense (SECDEF). The permanent transfer of an EPW to FN control is governed by bilateral national agreements. An EPW can only be transferred from US custody to a power that is a party to the Geneva Conventions. A US representative visits the power's internment facilities and ensures that the power is willing and able to comply with the Geneva Conventions.

4-38. The temporary transfer of EPWs is authorized to accommodate surges in EPW population beyond US capacity. The TO commander develops measures to ensure accountability and humane treatment of EPWs who are temporarily transferred.

4-39. An EPW who is captured or detained by the US Marine Corps, Navy, Air Force, or Coast Guard is turned over to the US Army at receiving points designated by the TO commander. Interservice transfers are effected as soon as possible following initial classification and administrative processing.

#### **REPATRIATION**

4-40. Repatriation is the process of returning an EPW to his country of birth or citizenship. An EPW who is not sick or wounded is repatriated or released at the end of hostilities as directed by the Office of the Secretary of Defense (OSD). The keys to a successful repatriation process are control and accountability. Table 4-2, page 4-12, outlines repatriation procedures.

4-41. To complete the transfer, the escort guard company forwards the official receipt of transfer to the IRIC. Upon notification from the IRIC that the transfer is complete, the losing internment facility forwards official records and unreleased confiscated property to the IRIC for final disposition. The IRIC—

- Notifies the national IRIC of the final status of released and repatriated EPWs.
- Forwards EPW records and reports according to AR 25-400-2.
- Disposes of confiscated property according to the national IRIC and applicable regulations.

4-42. The eligibility for repatriation or accommodation of sick and wounded EPWs is determined in a neutral country by a mixed medical commission. The commission is established by Headquarters, Department of the Army (HQDA) according to AR 190-8 and the GPW. Sick and wounded EPWs are not repatriated against their will during hostilities.

**Table 4-2. Repatriation Procedures**

Step	Actions
Control and accountability	Maintain control and accountability until EPWs are received by the serving power or the designated protecting power.  Maintain a manifest that contains the— <ul style="list-style-type: none"> <li>• Name.</li> <li>• Rank/status.</li> <li>• ISN.</li> <li>• Power served/nationality.</li> <li>• Physical condition.</li> </ul> <p><b>NOTE: A manifest is used as an official receipt of transfer and becomes a permanent record to ensure accountability of each EPW until his final release.</b></p>
Records	Ensure that copies of appropriate personnel, finance, and medical records accompany released and repatriated EPWs. Transfer the records to the designated official receiving EPWs.
Personal property	Ensure that confiscated personal property (that can be released) accompanies released and repatriated EPWs.  Conduct an inventory and identify discrepancies.  Ensure that EPWs sign property receipts.

## CONTROL AND DISCIPLINE

4-43. Treat EPWs fairly and firmly. Ensure that orders are decisive, clear, concise, reasonable, capable of being obeyed, and given in an understood language. Promptly report refusals and failures to obey orders, and take appropriate disciplinary action.

### CONTROL

4-44. Maintain humane, firm control of EPWs. To control EPWs—

- Observe rigorous self-discipline.
- Maintain a professional, impersonal attitude.
- Cope with hostile or unruly behavior and incidents calmly.
- Take judicious, immediate, and decisive action.

4-45. The MP establish daily and periodic routines and responses that are conducive to good EPW discipline and control. They—

- Require compliance with policies and procedures.
- Use techniques that provide firm control of EPWs.
- Give reasonable, decisive orders in a language that EPWs understand.
- Post copies of the Geneva Conventions in the compound where EPWs can read them in their own language.
- Post rules, regulations, instructions, notices, orders, and other announcements that EPWs are expected to obey. Ensure that posted information is printed in a language that EPWs understand. Provide copies to EPWs who do not have access to posted copies.
- Ensure that EPWs obey rules, orders, and directives.

- Report refusals and failures to obey orders and regulations.

## **Treatment**

4-46. Equitable treatment enhances the control of EPWs. According to the Geneva Conventions, all EPWs are treated humanely and are protected against violence, intimidation, insults, and public curiosity. Treat all EPWs alike, regardless of rank, sex, and privileged treatment (which may be accorded due to their health, age, or professional qualifications).

4-47. An EPW officer is afforded the following privileges and considerations:

- Quarters and facilities that are commensurate with his grade.
- The privilege of not being compelled to work.
- Enlisted orderlies. They are assigned at a ratio of 1 for each general officer (GO) and 1 for every 12 officers of a lower grade.

4-48. An RP is extended additional privileges and considerations due to his profession and special skills:

- Correspondence privileges for chaplains and senior medical officers that are over and above those afforded EPW officers.
- Facilities necessary to provide EPWs with medical care, spiritual assistance, and welfare service.
- Authority and transportation for periodic visits to hospitals and other internment facilities.
- Work assignments that are restricted to medical or religious duties he is qualified to perform.
- Quarters that are separate from those of other EPWs when practical.

## **Representation**

4-49. A limited system of representation improves communication between US forces and EPWs, thus improving control. According to AR 190-8 and the Geneva Conventions, the senior EPW officer assigned to each facility is recognized as the senior EPW representative, unless he is declared incompetent or incapacitated by US authorities. Enlisted EPWs may elect an enlisted representative if there is no officer representation at the facility. In officer facilities, EPWs choose one or more advisors to assist the senior representative. In officer/enlisted facilities, EPWs elect one or more enlisted advisors to assist the officer representative.

4-50. Elected and appointed representatives have the same nationality, customs, and language as those they represent. Each group of EPWs interned in separate facilities due to language, customs, or ideology is permitted to have an elected representative.

4-51. The primary duties of elected representatives are to promote spiritual, physical, and intellectual well-being of EPWs. Representatives are given freedom of movement within security requirements. They do not have the authority to discipline EPWs, but they are allowed to—

- Inspect labor detachments.
- Receive supplies.
- Communicate with—

- US military authorities.
- Protecting powers. (Protecting powers periodically inspect the internment facility and interview EPWs regarding the conditions of their internment, their welfare, and their rights under international law.)
- The ICRC and its delegates.
- Medical commissions.
- Other organizations authorized to assist EPWs.
- Use postal and other appropriate facilities.

4-52. Representatives do not perform any other work if it interferes with their representative duties. Each representative is elected by secret ballot and serves a 6-month term. The EPWs are permitted to consult freely with their representatives, and representatives are allowed to represent EPWs before—

- The ICRC.
- Protecting powers.
- US military authorities.
- Other relief or aid organizations (NGOs and IOs).

4-53. The facility commander is the final approving authority for each elected EPW representative. After the approval process is complete, a representative assumes his duties. When the commander denies, approves, or dismisses an elected representative, he sends a notice through channels to HQDA, the national IRIC (forwarded to the IRIC), or the protecting power. The notice includes the reason(s) for refusal if applicable. The EPWs are then permitted to elect another representative. Each elected representative can appoint assistants, as approved by the facility commander.

4-54. Medical and chaplain personnel are classified as RPs and are not considered EPWs. They receive, at a minimum, the benefits and protection afforded EPWs by the Geneva Conventions. However, EPW representatives do not represent them. The senior US or FN medical officer at each internment facility is responsible for the activities of retained medical personnel. The senior retained medical officer and the chaplain have the right to correspond and consult with the facility commander on all questions concerning their duties.

## **RULES OF INTERACTION AND ENGAGEMENT**

4-55. The ROI provide soldiers with a guide for interacting with the EPW population. The following directives may be included in the ROI:

- Speak to EPWs only when giving orders.
- Treat all EPWs equally and with respect.
- Respect religious articles and materials.
- Treat all medical problems seriously.
- Do not discuss politics or the conflict with EPWs.
- Do not make promises.
- Do not make obscene gestures.
- Do not make derogatory remarks or political comments about EPWs and their cause.

- Do not engage in commerce with EPWs.

4-56. Commanders balance the physical security of forces with mission accomplishment and the ROE. The basic guidelines on ROE (Chapter 2) apply to EPWs. The employment of nonlethal weapons (NLWs) is clearly stated in the ROE (see Appendix B and FM 90-40).

4-57. The ROE vary from operation to operation. The commander in chief (CINC) establishes ROE in coordination with the SJA and the joint staff. Special ROE can be developed for use in internment facilities, but they must have CINC approval. Specific ROE may evolve to fit the changing environment and to ensure continued protection and safety for US personnel and EPWs. As a general principle, the ROE should remain simple and understandable.

## **DISCIPLINE**

4-58. The facility commander establishes and enforces the rules needed to maintain discipline and security. The EPWs may not establish their own court system. The following actions are not permitted between EPWs and US military or civilian personnel:

- Fraternization.
- Favoritism.
- Donation or receipt of gifts.
- Engagement in commerce.

4-59. If necessary, the MP commander or his appointed officer initiates general court-martial proceedings against EPWs using Miscellaneous Publication (Misc Pub) 27-7; the UCMJ; and US laws, regulations, and orders. Do not deliver an EPW to civil authorities for an offense unless a member of the US armed forces would be delivered for committing a similar offense.

4-60. Do not discipline an EPW until he is given precise information regarding the offense(s). Allow the accused to explain his conduct and defend himself. Permit him to call witnesses, and use an interpreter if necessary. Maintain a record (on a locally produced form if available) of disciplinary punishment administered to EPWs. Disciplinary measures include—

- Discontinuance of privileges that are granted over and above those allowed by the Geneva Conventions (not to exceed 30 days).
- Confinement (not to exceed 30 days).
- A fine (not to exceed one-half of the advance and working pay that an EPW receives during a 30-day period).
- Fatigue duty (extra duty) (not to exceed 2 hours per day for 30 days). Fatigue duty does not apply to officers, and NCOs are only required to supervise.

## **CLOTHING**

4-61. Supply EPWs with sufficient clothing, underwear, and footwear; and allow for the climate where EPWs are housed. Use captured uniforms of enemy armed forces if they are suitable for the climate. Ensure that clothing is replaced and repaired as necessary. Working EPWs receive clothing that is

appropriate to the nature and location of the work. Clothing worn by EPWs at the time of capture is worn until it is no longer serviceable, and then it is exchanged. (Appendix C provides a synopsis of clothing and equipment that can be issued to EPWs.)

4-62. Mark outer garments with the letters "PW." Use black letters, about 4 inches high; if the clothing is a dark color, use white letters. Mark shirts, coats, and similar items across the back and on the front of each sleeve (between the elbow and the shoulder). Mark trousers, walking shorts, and similar items across the back (slightly below the belt) and on the front of each leg (slightly above the knee). Do not mark hats and other accessories. Sample EPW clothing markings are shown in Figure 4-1.

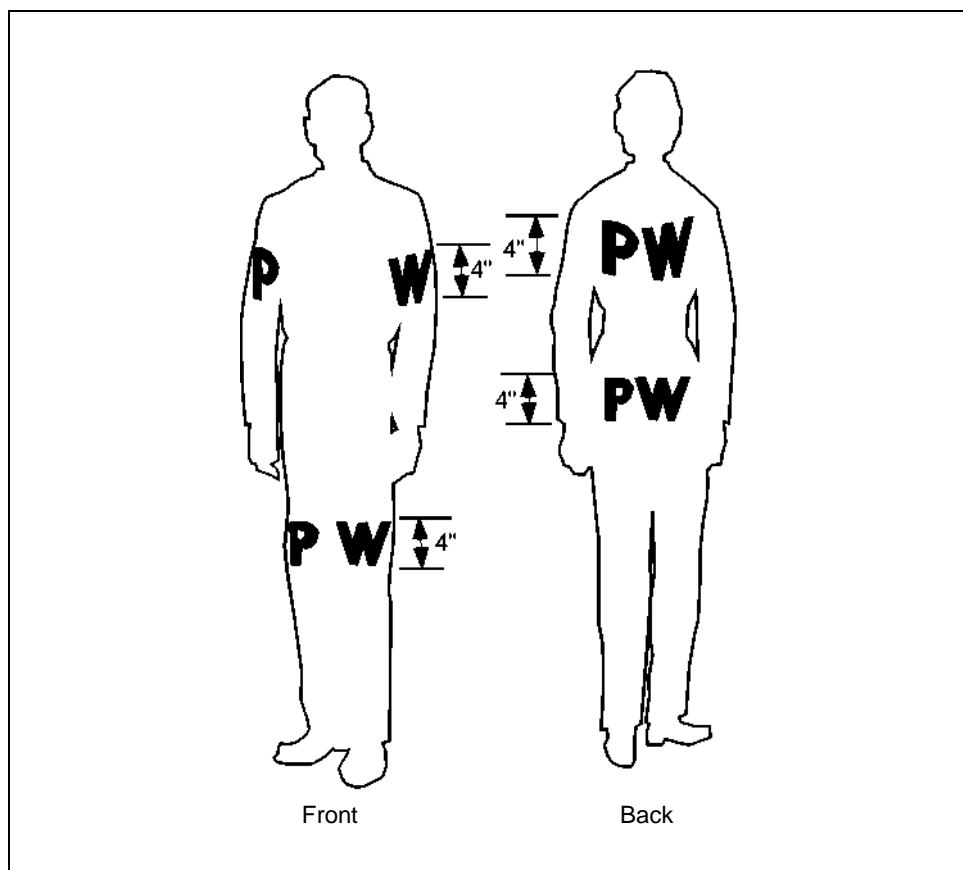


Figure 4-1. EPW Clothing Markings

4-63. An RP wears a water-resistant armband on his left sleeve bearing a distinctive emblem (such as Red Cross or Red Crescent). It is issued and stamped by the military authority of the power with which he has served. An authorized person who does not have an armband in his possession is provided a Geneva Convention brassard (see AR 670-1).

---

## **SUBSISTENCE**

4-64. The detaining power feeds EPWs a basic, daily food ration that is sufficient in quantity, quality, and variety to keep them in good health and to prevent weight loss and nutritional deficiencies. A medical officer, a PA, or a nurse practitioner keeps the commander apprised of situational needs and the nutritional health of EPWs. Supply working EPWs with extra rations to compensate for their labor. Sustain the health of EPWs at a level that is equal to that of the US forces guarding them.

4-65. If dining facilities are unavailable, feed EPWs meals, ready-to-eat (MREs). These rations are easily stored and require no additional dietary supplements. However, when perishable food supplies (fresh vegetables, fruit, and meat) are available, substitute them for nonperishable items. Always provide sufficient drinking water. Do not issue extra rations because EPWs can stockpile food and use it for escapes. The commander may authorize EPWs to prepare their own meals under the supervision of US personnel.

4-66. During the early stages of captivity (in brigade and division areas), allow EPWs to retain their own rations. However, arrange for collective feeding of EPWs according to the terms of the Geneva Conventions at the earliest opportunity.

## **MEDICAL AND SANITATION CONSIDERATIONS**

4-67. Ensure that adequate medical and sanitation standards are met. Chapters 2 and 6 contain additional information on these responsibilities.

## **CORRESPONDENCE**

4-68. Within one week of arrival at the internment facility, an EPW completes a DA Form 2665-R. When an EPW is transferred from one internment facility to another, he completes a DA Form 2666-R.

## **OUTGOING CORRESPONDENCE**

4-69. Outgoing correspondence is allowed as follows:

- May mail two letters (DA Form 2667-R) and four postcards (DA Form 2668-R) free of charge as prescribed in AR 190-8.
- May address complaints in writing to US military authorities and the protecting power. Complaints are not limited in length or in number, and they are not charged against an EPW's correspondence allotment. All complaints are transmitted immediately.
- Cannot write letters for other EPWs. If an EPW is unable to write, the facility commander appoints someone to write and countersign the letter.
- Cannot send parcels.

4-70. The facility commander or his designated representative examines and reads letters and postcards. The facility commander requisitions, reproduces, and supplies correspondence forms. If EPWs are prevented from writing



monthly letters due to the lack of forms, allow them to make up their allotment when forms become available.

### **INCOMING CORRESPONDENCE**

4-71. An EPW can receive unlimited letters, cards, and parcels. Censors thoroughly inspect all parcels for unauthorized items and concealed or coded messages. If deemed necessary, the facility commander can request that censors also examine incoming correspondence. Parcels are forwarded to EPWs who have been transferred.

### **TELEGRAMS AND TELEPHONE CALLS**

4-72. The EPWs may send and receive telegrams as determined by the facility commander, and the cost of sending telegrams is deducted from the EPW's account. The EPWs cannot make telephone calls.

### **CANTEENS**

4-73. Provide EPWs with sundry, health, and comfort packs. The packs can be supplemented with items tailored to EPWs' cultural needs as a temporary substitute for establishing canteen operations.

4-74. Canteens are operated according to the GPW and are installed as directed by the TO PM or senior MP officer. The EPWs can procure foodstuffs, soap, tobacco, and other items in canteens. The tariff for items available for EPWs never exceeds local market price, and payment procedures are outlined in DFAS-IN 37-1.

4-75. Profits made by the facility canteen are used to benefit the EPWs, and a special fund is created for this purpose. When an internment facility closes, transfer the credit balance of the special fund to another US internment facility in the TO. When all facilities are closed, transfer funds to an international welfare organization. The special fund is employed for the benefit of EPWs of the same nationality as those who have contributed to the fund. In case of a general repatriation, profits are kept by the US.

**NOTE: The EPW representatives can make suggestions regarding the management of canteens and special funds.**

### **SOCIAL PROGRAMS**

4-76. Encourage and support active education, employment, and agriculture programs for EPWs. Like other internees, EPWs have active programs for religious worship, recreation, protecting-power visits, and safety. These programs are discussed in Chapter 2. Provide adequate facilities, instruction materials, and agriculture equipment for these activities.

### **EDUCATION**

4-77. Develop education programs according to DA policy. Within the framework of DA guidance and directives issued by other headquarters, develop a separate education program for each EPW facility. Each program reflects the individual attitudes and political orientations of those interned in

the facility. The following factors and considerations may influence an education program:

- Levels of education throughout the EPW population.
- Attitudes toward education and the education program.
- Requirements for essential and necessary EPW work details.
- The availability of qualified instructors (may include EPWs, indigenous personnel, and US Army military and civilian personnel).
- Security considerations that may restrict or prohibit the use of EPWs or indigenous personnel.

4-78. In addition to an academic program, ensure that vocational training is an integral part of the education program. The immediate objective of vocational training is to develop skills that are useful during internment. The long-range goal is for EPWs to learn trades that are useful in civilian life.

## **EMPLOYMENT**

4-79. The EPW population constitutes a significant labor force of skilled and unskilled workers. Employ EPWs to construct, administer, manage, and maintain the facility. The EPWs will be employed in other essential work permitted by AR 190-8 only when qualified civilian labor is unavailable.

4-80. The commander organizes and manages the EPW population in a manner that permits proper, ready employment of each EPW. He—

- Establishes and maintains a current occupational-skill record for each EPW and includes new skills as they are acquired.
- Assigns individual EPWs to a work detail or a job on a regular or permanent basis.
- Establishes vocational-training projects.
- Encourages EPWs to study and develop skills.

4-81. The EPW labor that is external to DOD is regulated through contract. (See AR 190-8 for more information on the employment of and compensation for EPWs.)

## **Labor Considerations**

4-82. The following restrictions apply when employing EPWs:

- An officer cannot be compelled to work.
- An NCO can only be required to supervise the work of enlisted personnel.
- An EPW cannot be compelled to engage in work that is purely military in nature and purpose.
- An EPW cannot be employed on a work detail that is unhealthy or dangerous because of the work's nature or the individual's lack of physical fitness or technical skill. (See the GPW and AR 190-8 for guidance on this type of employment.)
- An EPW/RP cannot be assigned to labor that is considered humiliating or degrading for members of the US armed forces. This prohibition does not include unpleasant, necessary tasks that are connected to administering and maintaining the facility.

- An EPW cannot be employed or retained in an area where he may be exposed to direct or indirect fire.

4-83. If in doubt as to whether work is authorized, request that the SJA review the proposed tasks. This review assures compliance with AR 190-8 and the law of land warfare.

### **Paid Work**

4-84. The EPWs are compensated when they perform work for which pay is authorized. The rate of pay is not less than that prescribed in the GPW. Compensation for work is authorized from US Army appropriated funds, canteen funds, or EPW funds. The EPWs are paid for various types of authorized work, such as—

- Labor performed for a contract employer or a federal agency.
- Services as orderlies and cooks for officer EPWs.
- Services to construct, administer, manage, and maintain EPW facilities, branch facilities, and hospitals when such services are performed by EPWs permanently assigned to certain duties or occupations.
- Labor performed by RPs.
- Spiritual or medical duties.
- Services as EPW representatives or assistants. These individuals are paid from the EPW fund. If an EPW fund does not exist, they are paid from US Army appropriated funds.
- Services as detail leaders or interpreters.

### **Advance Pay**

4-85. The Geneva Conventions state that the detaining power shall grant EPWs a monthly advance of pay, the amount of which shall be fixed by conversion into the currency of the said power, of the following amounts:

- Category I (EPWs below the rank of sergeant [SGT]): 8 Swiss francs.
- Category II (SGTs, other NCOs, and EPWs of equivalent rank): 12 Swiss francs.
- Category III (warrant officers [WOs], commissioned officers below the rank of major [MAJ], and EPWs of equivalent rank): 50 Swiss francs.
- Category IV: (MAJs, lieutenant colonels [LTCs], colonels [COLs], and EPWs of equivalent rank): 60 Swiss francs.
- Category V (GOs and EPWs of equivalent rank): 75 Swiss francs.

**NOTE: The facility commander consults with the SJA and the finance office when setting up EPW advance-pay accounts.**

### **AGRICULTURE**

4-86. When practical, EPWs should raise vegetables for their use; the labor is classified as paid work. Do not overlook the importance of developing an agriculture program. Agriculture and gardening projects are particularly desirable because they provide gainful employment for several individuals. The food produced by gardening projects provides a valuable supplement to

diets at minimal expense. The produce from gardens operated with EPW labor is US property. It is used for the benefit of EPWs and US armed forces personnel, and it is not sold or traded in civilian markets.

4-87. The types and quantities of agriculture supplies required (seeds, fertilizers, and implements) are procured through local purchase or Army supply channels. Ensure that necessary supplies are ordered in a timely manner.

## **SECURITY**

4-88. The commander is responsible for security measures that effectively control EPWs with minimal use of force. A general discussion of the commander's security responsibilities is found in Chapter 2. The information contained in this chapter applies specifically to EPW security.

## **ADVERSE ACTIONS**

4-89. Dissident actions by EPWs vary from acts of harassment to acts of violence. Enemy forces may support resistance activities, such as EPWs—

- Refusing to eat, work, or attend formations.
- Working in an unsatisfactory manner.
- Malingering.
- Sabotaging equipment or facilities.
- Assaulting other EPWs or guard personnel.
- Taking hostages to secure concessions.
- Escaping or participating in mass breakouts.
- Intimidating other EPWs.
- Fabricating weapons or other illegal items.
- Printing or circulating propaganda material.
- Creating embarrassing situations or making false accusations to influence international inspection teams or members of the protecting power or the ICRC.
- Instigating disturbances and riots to place the facility staff in unfavorable positions (this allows EPWs to gain concessions and influence custodial policies).

4-90. Enemy forces may—

- Establish communications with EPWs by using agents, smuggled radios, and foreign-language newspapers.
- Order members to submit to capture so that they can become agitators in the internment facility.
- Liberate EPWs through direct military action by regular or irregular forces.

## **PLANNING**

4-91. Ensure that security planning is continuous and complete and that it reflects current intelligence information on uprisings, outbreaks, and escapes.

Provide an immediate-response plan that is capable of meeting all internal and external threats to security.

4-92. The EPWs may try to communicate with EPWs from other compounds and facilities. The most common places for communication are—

- **Dispensary and food distribution points.** Messages can be hidden where EPWs from neighboring compounds can find them. Alert observations and periodic searches minimize the possibility of communication in these areas.
- **Hospitals.** If an EPW is sick or injured, examine him carefully to ensure that hospitalization is required. Do not inform the EPW patient of his discharge until the last possible moment. Conduct a complete search of each EPW and his personal effects upon admission and discharge from a hospital.
- **Work details.** Maintain an adequate distance between work details to prevent EPWs from exchanging information.

## INTELLIGENCE INFORMATION

4-93. The first objective of MI is observing activities to accurately classify EPWs as cooperative or uncooperative. This minimizes security and control problems by allowing early segregation of hard-core, uncooperative EPWs to maximum-security internment facilities.

4-94. Timely information relative to attitudes and activities enables the facility commander to forecast disturbances and other clandestine activities. This information is an important means of countering resistance movements, minimizing the use of force, and maintaining control. An effective information-gathering system identifies dissident elements, including leaders, plans, and methods.

4-95. All facility personnel must detect and report significant information. They can acquire important information through observation and insight, even though they are not trained intelligence specialists.

4-96. In compounds that house cooperative EPWs, a special intelligence organization is not needed. Tap ordinary sources of information continually and assess them sensitively. These sources include communications, observations, and reports of military, administrative, and security personnel; criminal investigation data; disciplinary reports; and grievance statements.

4-97. Intelligence requirements incorporate information required by the commander to ensure the continued control of EPWs and information requested by higher headquarters and other agencies. The S2 prepares PIR and coordinates intelligence requirements to maintain a constant flow of intelligence to the commander.

4-98. Identify the following essential elements of information (EEI):

- EPW agitators and leaders and their followers.
- Clandestine EPW organizations, including their strength, objectives, and members.
- Underground communications systems and overt attempts to communicate—

- Between EPW compounds and internment facilities.
- With indigenous civilian personnel.
- Suspicious activities by local people near the internment facility (photographing or sketching the facility).
- Fabricated weapons, stores of food, and clothing supplies in the compound.
- Plans to conduct demonstrations, including—
  - The date and time.
  - The number of EPWs involved (by compound).
  - The nature of the demonstration (passive, harassing, or violent act).
  - Objectives (distributing propaganda, weakening or testing authority and security, establishing control, or planning mass escapes or outbreaks).

4-99. Use the following methods to obtain information on clandestine EPW activities:

- Provide opportunities for EPWs to volunteer information of intelligence value and offer protection from reprisal by removal or transfer to safe facilities.
- Conduct periodic, unannounced searches and patrols.
- Search EPWs on departure from and return to the facility.
- Train personnel on the techniques and importance of observing, recognizing, and reporting information that may have intelligence value, such as—
  - Unusual activities, especially before holidays or celebrations.
  - Messages being passed between groups of EPWs on work details.
  - Messages being passed to or from local civilians while EPWs are on work details.
  - Messages being signaled from one compound to another.

4-100. Developing an EPW intelligence network that extends to each compound is invaluable. The reliability of the network depends on the information provided and the verification of that information. Establishing an informant system is subject to local consideration of special hazards that may be involved. Take every precaution to provide safety for EPW informants.

### **WORK DETAIL GUARDS**

4-101. Keep work detail guards to the minimum number necessary to assure reasonable security and prevent EPW escape. Guards maintain a reasonable distance from work details and properly position themselves to provide the best observation of the area. Rest breaks for guards are taken separately while EPWs are working.

### **MILITARY WORKING DOGS**

4-102. The MWDs offer a viable deterrent against EPW escapes, because their tracking capabilities can be used to recapture escapees. Chapter 2 provides more information on MWDs and their use in internment facilities.

## ESCAPE PREVENTION

4-103. Minimize escapes by—

- Conducting periodic, unannounced, and systematic searches to detect tunneling, caches of food or clothing, weapons, maps, and money or other valuables.
- Maintaining strict accountability for tools and equipment that EPWs can access or use.
- Examining perimeter fencing daily to detect cuts or other weaknesses.
- Examining the lighting system during darkness to detect poorly lighted areas along the perimeter. (Replace burned out or broken light bulbs immediately.)
- Conducting training and refresher training to ensure that all security and guard personnel are familiar with security precautions, techniques, and procedures.
- Searching vehicles and containers taken into or out of the internment facility.
- Supervising the disposition of unconsumed rations (in the internment facility and on work details) to prevent caching of food.

### Early Detection of Escape Attempts

4-104. To detect escape attempts, conduct—

- Roll calls and head counts on regular and unannounced bases.
- Roll calls twice daily, preferably early morning and late evening.
- Head counts immediately after witnessing a mass disturbance, discovering an open tunnel, or detecting a hole or break in a fence.
- Head counts frequently while on work details and when en route to another facility.

### Escape Prevention and the Use of Force

4-105. The facility commander ensures that US soldiers understand the ROE, including the use of the term *halt*, the use of deadly force, and the ban on physical or imaginary deadlines. Per AR 190-8, he also ensures that EPWs understand the use of the English word *halt* and its implications.

4-106. When an EPW tries to escape, a guard shouts *HALT* three times; thereafter, the guard uses the least amount of force necessary to halt the EPW. If there is no other effective means of preventing escape, deadly force can be used. If an EPW tries to escape from a fenced enclosure, do not fire unless he clears the outside fence (barrier, concertina wire, or razor tape) and makes further effort to escape. If an EPW tries to escape outside a fenced enclosure, fire if he does not halt after the third command.

4-107. An escape is successful if an EPW—

- Reaches the lines of his forces or the allies of that power.
- Leaves the territory that the US or its allied powers control.

Per the unit SOP, notify commands and interested agencies of escapes and recaptures.

## Chapter 5

# Civilian Internees

A civilian whose status cannot be determined is treated as an OD. All rules, regulations, and privileges applicable to an EPW apply to an OD. When an OD is adjudicated by a military tribunal and determined to be a CI, he is removed from the EPW facility and treated as a CI. This chapter discusses the internment process after a military tribunal adjudicates a civilian and determines that he should be interned. A CI internment facility runs parallel to an EPW internment facility, with some differences. A CI—

- Is protected under the provisions of the GC.
- Does not meet the criteria for classification as an EPW or an RP.
- Is considered a security risk.
- Needs protection because he committed an offense against the detaining power (insurgents, criminals, or other persons).

**NOTE: AR 190-8 provides detailed information on the administration of a CI internment facility and the treatment of CIs.**

### GENERAL PROTECTION

5-1. Do not physically torture or use moral coercion against CIs. This does not prevent the use of minimum force necessary to enforce measures authorized or directed by AR 190-8. Ensure that CIs are treated with respect and protected against—

- Violence.
- Insult.
- Public curiosity.
- Bodily injury.
- Reprisal.
- Sexual attack (molestation, prostitution, or any form of indecent assault).

5-2. Treat CIs considerately, without adverse distinction based on race, religion, political opinion, sex, or age. The following are prohibited:

- Measures that may cause physical suffering or death.
- Intimidation.
- Terrorism.
- Reprisal.
- Hostage acts.



- Deportation from the occupied territory to the territory of the occupying power or any other country (occupied or not).

5-3. The CIs can apply for assistance from protecting powers, the ICRC, approved religious organizations, relief societies, and others. Within the limits of military and security considerations, these organizations are allowed access and facilities to assist CIs.

### **AUTHORIZATION TO INTERN**

5-4. The internment of protected civilians is authorized and directed if the following requirements are met:

- Internment is necessary (as determined by competent US military authority) for the security of US armed forces in the occupied territory.
- Internment is directed (by a properly constituted US military court in the occupied territory) as the sentence for an offense that violates penal provisions issued by the occupying US armed forces.

5-5. A protected civilian in the occupied territory is accepted for internment upon receipt of one of the following:

- An internment order for imperative security reasons authenticated by a commissioned officer who is delegated authority by the TO commander.
- An order of an authorized commander, approving and ordering into execution, a sentence to internment pronounced by a properly constituted US military court in the occupied territory.

5-6. A CI can request compassionate internment of his dependent children who are without parental care in the occupied territory. This is normally granted after coordination with SJA when both parents or the only surviving parent is interned.

### **SAFETY**

5-7. Establish and administer a safety program for CIs according to pertinent safety directives. (See AR 385-10 for more information.)

### **ADMINISTRATIVE RESPONSIBILITIES**

5-8. An I/R facility housing CIs is commanded by a commissioned officer of the US armed forces, and he is responsible for the safety and well-being of all housed personnel. He ensures that copies of the Geneva Conventions and facility regulations, orders, and notices relating to the conduct and activities of internees are posted in each facility, in the language of internees housed there. He provides copies to internees who do not have access to posted copies.

5-9. Regulations and other guidance relative to the administration, employment, and compensation of internees are prescribed in detail in AR 190-8 and DFAS-IN 37-1. The commander ensures that all members of his staff and command are familiar with applicable ARs, directives, international laws, and administrative procedures.

5-10. The commander is responsible for administratively processing each internee. When processing is complete, a strength report (DA Form 2674-R) is

transmitted to the IRIC, which functions as the field operations agency for the national IRIC located in the TO.

## PRINCIPLES AND POLICIES

5-11. The following principles apply to CI internment facilities:

- Use housed personnel for internal maintenance and operation.
- Use captured supplies and equipment (excluding weapons and ammunition).
- Maintain control.

5-12. A CI has the right to—

- Submit requests and complaints regarding the conditions of his confinement to detaining and protecting powers.
- Elect representatives to the internee committee.
- Send and receive correspondence.

**NOTE: Commanders are authorized to impose disciplinary punishment according to the Geneva Conventions and AR 190-8.**

## STANDING ORDERS

5-13. Standing orders are used to provide uniform, orderly administration of the I/R facility. The orders to be obeyed by housed personnel are published in their language and posted where they can read and refer to them. Standing orders include rules, procedures, and instructions governing the following activities and other matters as deemed appropriate:

- Schedule of calls, including—
  - Reveille.
  - Morning roll.
  - Readiness of quarters for inspection.
  - Sick.
  - Mess.
  - Evening roll.
  - Lights out.
- Housed-personnel actions that support emergency action plans of the internment facility, such as—
  - Fire drills.
  - Air raid drills.
  - Emergency evacuations.
  - Natural-disaster drills.
  - Blackouts.
  - Escapes.
- Hours for religious services, recreation activities, and so forth.
- Procedures for emergency sick call.
- Designated smoking areas.

## RECORDS AND REPORTS

5-14. The commander establishes local records and reports necessary to operate the facility effectively. The reports provide information concerning control, supervision, and disposition of the CI population. The commander determines the type (administrative, operational, logistical, intelligence, and personnel) of reports and the frequency (routine or as required). Normal command records and reports, such as duty officer logs, worksheets, and situation maps, are also required.

### Processing

5-15. Internees who meet the requirements in the Geneva Conventions and AR 190-8 are entitled to the protected CI status. Process them as follows:

- Issue an ISN to each processed CI using the procedures in Chapter 4 for EPWs. Ensure that the letters "CI" follow the last number of the ISN.
- Complete DA Form 2663-R in duplicate for each CI and each dependent child. Place one copy in the CI's personnel file, which is transferred with him; and forward the other copy to the IRIC.
- Prepare DA Form 2674-R for each facility housing CIs and for each hospital where CIs are assigned. Account for all captives classified as CIs, captives who had a DA Form 4237-R prepared, and dependent children who received compassionate internment.
- Issue DA Form 2677-R to each processed CI. Direct him to retain the card at all times.
- Complete DA Form 2678-R in duplicate. Forward one copy to the CI information agency and the other copy to a relative.
- Prepare DA Form 4237-R for each protected civilian processed in the occupied territory as a CI or a dependent child. Stamp the letters "CI" on the top and bottom of each form.

### Dependent Children

5-16. Dependent children who are interned with their CI parents are not classified as CIs or processed, except as required on DA Forms 2663-R, 2674-R, and 4237-R. When dependent children reside in the facility with their parents, they are cared for, accounted for, and managed like their parents. House children and parents together in facilities that allow them to lead a normal family life. Children under the age of 12 are identified by wearing an ID badge or wristband. Ensure that children under the age of 15, who are orphaned or separated from their families as a result of the war, are not left to their own resources.

### Assignments

5-17. Assign CIs to appropriate internment facilities, and intern those with violently opposed ideologies in separate facilities. When possible, assign CIs according to their nationality, language, and customs. Do not separate CIs who are nationals of the same country merely because they speak different languages; however, consider political and cultural differences as grounds for

separation. Maintain segregation of males and females, with the following exceptions:

- House members of the same family together (particularly parents and children), allowing them to lead a near-normal family life.
- Provide quarters to a parent (if single or interned without a spouse) and children that are separate from those for single persons.

## Identification

5-18. The reasons for identifying CIs are many and varied; among them are—

- Verifying facility rosters against the actual population.
- Identifying family members to allow timely reunification.
- Matching CIs with their medical records in case of a medical emergency or an evacuation.
- Checking identities of CIs being transferred against the transfer roster.

5-19. An ID band (see Chapter 4) permits rapid, reliable ID of CIs. Assign each CI an ISN according to the procedures in Chapter 4 and AR 190-8. Substitute the letters “CI” for “EPW;” for example, US9AB-000001CI. The ID card contains the CI’s name, photograph, and ISN. When serious deterioration of an ID band or card occurs, replace it immediately. Use a DA Form 2677-R to facilitate ID.

## CLOTHING

5-20. Allow CIs to retain their clothing and footwear. Provide clothing, equipment, supplies, subsistence, and fuel as necessary. Issue work clothing and, as required by circumstances and climatic conditions, replacement clothing. Account for health and comfort items, such as razors and toothbrushes, with a direct-exchange program.

5-21. Mark outer garments with the letters “CI.” Use black letters, about 4 inches high; if the clothing is a dark color, use white letters. Mark shirts, coats, and similar items across the back and on the front of each sleeve (between the elbow and the shoulder). Mark trousers, walking shorts, and similar items across the back (slightly below the belt) and on the front of each leg (slightly above the knee). Do not mark hats and other accessories. The commander can also direct that a CI’s ISN be placed on the inside of his clothing. (See Figure 4-1, page 4-16.)

## SUBSISTENCE

5-22. Issue food items based on the master CI menu prepared by the TO commander. The CI menu includes a daily food ration that is sufficient in quantity, quality, and variety to maintain good health and to prevent nutritional deficiencies. Consider the customary diet when developing a CI menu. Ensure that—

- Facilities are available to CIs for preparing additional food received or procured from authorized sources.

- CIs performing labor receive increased rations based on the type of work performed.
- Expectant and nursing mothers and children under the age of 15 years receive additional food in proportion to their needs.

5-23. If CIs receive MREs as the main source of nourishment, provide them with at least one hot meal per day. Supplement MREs with fruit, milk, and bread.

## RECEIVING AND PROCESSING AREAS

5-24. Use a controlled-flow format to escort CIs through the processing line. Normally, four CIs are processed at a time and the average is eight per hour. Secure unprocessed CIs in a holding area.

5-25. Request interpreters (linguists) from MI, PSYOP, allied forces, or local authorities as necessary. This may require identifying and clearing trusted internees or local nationals to interpret. Interpreters are particularly helpful when entering required data into the IRIS.

5-26. The preparation and dispatch of internee strength reports (DA Form 2674-R) are governed by AR 190-8, and they are prepared at each internment facility. Brigade or facility commanders may require feeder reports from various compounds to facilitate the preparation of internee strength reports.

5-27. Escort internees to the receiving area where the internment process begins. Table 5-1 outlines the internment process for CIs. It shows who is responsible for each step and what actions they must accomplish. Based on METT-TC, the commander may tailor stations to meet the situation. Stations 1 through 4 are in the receiving line, and Stations 5 through 9 are in the processing line.

## RECEIVING AREA

5-28. When CIs arrive at the facility—

- Segregate them from those who arrived earlier and those who are partially processed.
- Ensure that a valid internment order was issued and accompanies each CI.
- Verify that receipts for each CI and his equipment match the CI's control number.
- Secure personal property in a temporary storage area until CIs are fully processed. Issue a DA Form 4137 for temporarily and permanently stored property. Do not allow CIs access to storage areas.
- Ensures that CIs receive food, water, access to sanitation facilities and, if needed, first aid.
- Escort CIs to the processing area as soon as the receiving process is complete.
- Hold CIs in the receiving area until they can be processed.

Table 5-1. Processing Actions at the CI Processing Area

Station	Purpose	Responsible Individuals*	Actions
<b>Receiving Line</b>			
1	Search	MP	<p>Assign ISNs.</p> <p>Follow accountability procedures.</p> <p>Escort CIs and their property.</p> <p>Conduct a same-gender search of CIs before entering the processing area unless prohibited by conditions. <b>NOTE: Upon initial apprehension, a mixed-gender search can be conducted; but it is discouraged due to possible negative repercussions. The same-gender search restrictions are based on the detainee being officially adjudicated and declared a CI.</b></p> <p>Remove and examine property, place it in a container or a tray, mark it with a control number, and take it to a temporary storage area. Issue a DA Form 4137 for stored property.</p> <p>Supervise the movement of CIs to the next station.</p>
2	Personal hygiene	MP	<p>Allow CIs to shower, shave, and get haircuts.</p> <p>Allow CIs access to sanitation facilities.</p> <p>Supervise the movement of CIs to the next station.</p>
3	Medical evaluation	Medical officer and MP	<p>Examine CIs for signs of illness or injury to discover health problems that may require medical treatment or evacuation.</p> <p>Provide medical and dental care according to AR 40-3.</p> <p>Give initial radioscopic chest examinations to look for active diseases.</p> <p>Perform a TB skin test on children up to 14 years of age.</p> <p>Weigh CIs and establish a weight register.</p> <p>Immunize and reimmunize CIs as prescribed by TO policy.</p> <p>Place control numbers on medical records to reduce linguist support. (Names, service numbers, and ISNs are entered at Station 1 with the aid of an interpreter.)</p> <p>Disinfect CIs as prescribed by TO policy.</p> <p>Annotate medical records with the date and place of inspection, immunization, and disinfection.</p> <p>Supervise the movement of CIs to the next station.</p>
4	Personal items	MP	<p>Issue personal-comfort items (toilet paper, soap, toothbrush, and toothpaste).</p> <p>Ensure that clothing is marked "CI." <b>NOTE: The CIs must provide their own clothing and footwear.</b></p> <p>Escort CIs to the processing area (Station 5).</p>
*The number of people used to perform tasks depends on the number of CIs and the amount of time available.			

**Table 5-1. Processing Actions at the CI Processing Area (continued)**

Station	Purpose	Responsible Individuals*	Actions
<b>Processing Line</b>			
5	Administrative accountability	Processing clerk (assisted by an interpreter, MI, or others) and MP	<p>Verify the internment order and the authentication, including the signature.</p> <p>Assign ISNs to CIs. Note the temporary control numbers that ISNs are replacing so that late-arriving property can be matched to its owner.</p> <p>Initiate personnel records (DA Form 4237-R), ID documents (DA Form 2677-R), and property receipts.</p> <p>Prepare forms and records to maintain the accountability of CIs, their families, and their property (see STANAGs 2033, 2044, and 2084).</p> <p>Supervise the movement of CIs to the next station.</p>
6	Photography and fingerprinting	MP	<p>Fingerprint CIs. Identify and record the information on fingerprint cards (DA Form 2663-R).</p> <p>Take two photographs (with instant film or digital technology). Have captives look straight ahead, and fill the frame with their face.</p> <p>Use photograph name boards (black background with white characters). List ISNs and names (translated into English) at the bottom center.</p> <p>Attach one photograph to the CI's personnel record.</p> <p>Give a completed, laminated ID card (which contains the second photograph) to the CI.</p> <p>Supervise the movement of CIs to the next station.</p>
7	Personal property	MP	<p>Inventory and record property (in the presence of CIs) brought from temporary storage areas.</p> <p>Make separate lists for returned, stored, impounded, and confiscated property. List property to be returned to CIs or stored during internment on a separate list.</p> <p>Update DA Form 4137, or provide the CI with a new one.</p> <p>Supervise the movement of CIs to the next station.</p>
8	Records review	MP	<p>Review processed records for completeness and accuracy.</p> <p>Escort CIs back to processing stations to correct errors if necessary.</p> <p>Allow CIs to prepare DA Form 2678-R. If CIs are unable to write their own cards, have someone authorized by the commander to do it for them.</p> <p>Prepare and maintain an accountability roster of all internees.</p>
9	Movement to living area	MP	<p>Brief CIs on facility rules and regulations.</p> <p>Escort CIs to their new living areas.</p>
<p>*The number of people used to perform tasks depends on the number of CIs and the amount of time available.</p>			

5-29. A medical officer—

- Examines CIs upon arrival at the facility and monthly thereafter.
- Determines medical fitness, state of health, nutrition, and cleanliness.
- Checks for communicable diseases (vermin infestations, TB, malaria, sexually transmitted diseases [STDs], and HIV), and isolates CIs with communicable diseases.
- Records weight on DA Form 2664-R. This process monitors abrupt changes in weight that may affect health.

**NOTE: When possible, use qualified CI personnel for the medical and hygiene work necessary for the well-being of CIs.**

## PROCESSING AREA

5-30. After CIs have completed the receiving portion of their processing, move them to the processing area where they are formally processed into the internment facility. They are entered into the IRIS database, and the IRIC forwards the information to the national IRIC for dissemination to protecting powers. The processing element—

- Keeps CIs segregated as much as possible during processing.
- Conducts administrative processing.
- Expedites the processing of CIs (suspected spies and saboteurs) selected by MI teams for interrogation.
- Assigns each CI an ISN.
- Replaces the control number on each CI's wrist with the ISN.

## FLOW OF INFORMATION

5-31. Regard the information collected from CIs as sensitive to protect them and the soldiers who are guarding them. If belligerent nations discover how many internees are in a facility or discover the location of a facility, it may be targeted to silence the sources of information. Maintain proper security throughout the information flow, and disseminate information through proper channels. The IRIC acts as a hub for information that CHAs and I/R facilities produce. Report personnel records electronically on the IRIS or, if necessary, as a paper file.

5-32. The information flow begins when the prisoner is captured and a DD Form 2745 is initiated. The ISN, which is assigned upon arrival at a CHA or an I/R facility, is the key to tracking CIs throughout the I/R system.

5-33. A CI was initially processed as an EPW (see Chapter 4), and the information gleaned during that process is used to process him as a CI. Once an individual is adjudicated by a military tribunal as a CI, specific information must be electronically entered on DA Forms 2674-R and 4237-R:

- **DA Form 2674-R.** Enter the following information in Section B:
  - The first and last names of the CI and his dependent children who are given compassionate internment.
  - The ISN. Assign an ISN if the individual does not have one. (Dependent children are not assigned an ISN.)
  - The grade, the civilian capacity, and/or the title.



- The sex of the CI and his dependent children.
- The nationality. This is the name of the country that the CI claims for citizenship.
- The occupational skill.
- The name of the person who approved the internment order, the headquarters, and the date.
- **DA Form 4237-R.** Prepare a DA Form 4237-R for each protected civilian processed in an occupied territory as a CI or a dependent child. Enter all available pertinent information and information that the CI is willing to give. Note information that the CI is unable or unwilling to give.

5-34. Information collected during processing (initial and full) and entered into the IRIS (CHA or I/R facility) is sent to the IRIC. The IRIC collects the entire personnel file (it is normally electronic with a hard-copy backup). The I/R facility reports the information to the IRIC, who disseminates it as appropriate. The strength report (DA Form 2674-R) is the only information passed up the I/R facility's chain of command. Information also flows to the ICRC, the state department, and other federal agencies as required. Questions regarding the information or internee flow in the TO are directed to the IRIC.

## CONTROL AND DISCIPLINE

5-35. Treat all CIs fairly. Ensure that directions are reasonable, capable of being obeyed, and given in an understood language. Promptly report refusals and failures to obey facility rules through the chain of command.

## CONTROL

5-36. The MP maintain control of CIs and efficiently administer internment facilities. This includes reducing waste and avoiding duplication of effort. Facility personnel quickly and fairly establish and maintain discipline. For example, they—

- Observe rigorous self-discipline.
- Maintain a professional, impersonal attitude.
- Follow the guidelines established in the ROI and the ROE.
- Cope with hostile or unruly behavior or incidents calmly.
- Take fair, immediate, and decisive action.

5-37. Guards take positive action to establish daily and periodic routines and responses that are conducive to good discipline and control. They—

- Enforce policies and procedures.
- Give reasonable, decisive orders in a language that CIs understand.
- Post copies of the Geneva and UN Conventions in a language that CIs understand and ensure that copies are easily accessed. The internee committee provides copies to CIs who do not have access to posted copies.
- Post rules, regulations, instructions, notices, orders, and announcements that CIs are expected to obey. They ensure that the

information is easily accessed and is in a language that CIs understand. The internee committee provides copies to CIs who do not have access to posted copies.

- Ensure that CIs obey orders, rules, and directives.
- Report refusals and failures to obey orders and regulations.

**NOTE: Per AR 190-8, single CI females are directly supervised or guarded by female personnel. A parent with children, if single or interned without a spouse, is provided quarters that are separate from those for single persons.**

5-38. The CIs can be searched for security purposes, but only same-gender searches are allowed. A strip search can be conducted to recover contraband and to report injuries and signs of drug use.

5-39. To protect CIs from violence, bodily injury, and threats of reprisal at the hand of fellow internees, post a notice of protection (Figure 5-1) in every compound. Ensure that the notice is posted in a language that internees understand.

<b>NOTICE</b>
<p>An internee (regardless of faith or political belief) who fears that his life is in danger or that he may suffer physical injury at the hands of another internee, should immediately report the fact to a US Army officer of this facility without consulting the internee committee. The facility commander provides adequate protection to the internee (such as segregation or transfer). An internee who mistreats a fellow internee will be punished.</p> <p style="text-align: right;">(Signed by the Commanding Officer)</p>

**Figure 5-1. Sample Notice of Protection**

## **DISCIPLINE**

5-40. Maintain and enforce discipline and security, and deal with offensive acts promptly. Maintain a record of disciplinary actions, which may be inspected by protecting powers. The internee committee does not have disciplinary power over and cannot administer punishment to fellow internees. The following actions are not permitted between CIs and US military or civilian personnel:

- Fraternization.
- Donation or receipt of gifts.
- Engagement in commercial activity.

5-41. The facility commander is authorized to order disciplinary punishment for a CI under the provisions of AR 190-8 and the Geneva Conventions. Before imposing disciplinary punishment, provide an interpreter if necessary and—

- Provide the CI with precise information regarding the offense.
- Give the CI an opportunity to defend the allegation.
- Permit the CI to call witnesses.

5-42. The following disciplinary actions are authorized:

- Discontinuance of privileges that are beyond those granted by AR 190-8 and the Geneva Conventions.
- Confinement.
- A fine (not to exceed one-half of the wages received during a 30-day period).
- Extra fatigue duty to maintain the internment facility (not to exceed 2 hours per day).

5-43. The duration of a single disciplinary punishment will not exceed 30 consecutive days—even if the CI is answerable for several breaches of discipline (related or not) at the time punishment is imposed. The period lapsing between pronouncing the disciplinary punishment and completing its execution will not exceed 30 days. After a disciplinary action has been executed, another disciplinary action cannot be imposed on the same CI until 3 days has lapsed between the execution of any two punishments, if the duration of one of the two punishments is 10 days or more.

## **CONFINEMENT**

5-44. A CI accused of an offense for which disciplinary punishment is contemplated will not be confined unless it is essential to facility order and discipline. If a CI does spend time in confinement awaiting a hearing, it will not exceed 14 days and it will be deducted from his sentence.

5-45. A CI who is subject to confinement serves the time in a facility stockade. Females and males are confined in separate quarters, and females are supervised by females. While undergoing confinement for pretrial, for posttrial, or in connection with disciplinary or judicial proceedings, a CI is—

- Allowed to exercise and stay in the open air at least 2 hours a day.
- Allowed to attend daily sick call, receive medical attention and, if necessary, be transferred to a hospital.
- Given enough food to maintain health.
- Permitted to confer with visiting representatives of the protecting powers and the ICRC.
- Permitted to receive spiritual assistance.
- Treated with proper regard.
- Provided hygienic living conditions.
- Provided adequate bedding, supplies, and facilities necessary for personal cleanliness.
- Allowed to send and receive letters, cards, and telegrams. (Parcels and remittance of money can be withheld from a CI until his punishment is complete.)

## **INTERNEE COMMITTEE**

5-46. One of the best ways to ensure cooperation within a facility is to establish a form of self-government. This minimizes the impression that CIs are prisoners under the control of a foreign government and allows them to feel a sense of control over their lives. The internee committee represents the local CI population to the detaining power, protecting powers, the ICRC, and

other authorized relief and aid organizations. The committee's communications with these organizations are unlimited.

5-47. The internee committee has two or three elected members, and each member can have an assistant who acts as an interpreter. The facility commander approves each elected member and assistant. Members are elected by secret ballot every 6 months, and they can be elected to more than one term. When the commander disapproves an election, it is submitted in writing and states the reason for disapproval. He forwards the disapproval through channels to the IRIC, who forwards it to the national IRIC and protecting powers.

5-48. Duties of a internee committee include—

- Furthering spiritual, physical, and intellectual well-being.
- Being responsible for and having jurisdiction over mutual assistance organizations set up by CIs.
- Visiting outside labor details.
- Checking the management of the canteen and the canteen fund.
- Presenting and transmitting petitions and complaints to appropriate authorities.
- Distributing and disposing of collective relief shipments.
- Receiving briefings about ongoing and final judicial proceedings.

## **CORRESPONDENCE**

5-49. The correspondence system for CIs parallels that for EPWs (Chapter 4). The exceptions are that DA Form 2679-R is used for letters and DA Form 2680-R is used for postcards.

## **COMPLAINTS AND REQUESTS**

5-50. A CI can make a complaint or a request to the facility commander, who tries to resolve the issue. If the CI is not satisfied with the resolution, he may address it to HQDA. A CI can make a complaint by mail, in person to a visiting representative of protecting powers, or through the internee committee.

## **MEDICAL TREATMENT**

5-51. Provide personnel, material, and facilities for routine and emergency medical treatment. Ideally, transfer patients requiring inpatient care to a civilian hospital. If a civilian hospital is unavailable or if its use is infeasible due to security considerations, transfer patients to a US military hospital. Ensure that the treatment they receive is as good as that provided for the general population, and provide guards as necessary.

## **SANITATION**

5-52. Proper sanitation and cleanliness of a facility prevents the spread of disease among the CI population and the US forces guarding them. The facility commander—

- Conducts periodic, detailed sanitary inspections.
- Publishes a detailed sanitary order in a language that CIs understand and posts it in each compound.
- Provides sanitary supplies, services, and facilities necessary for personal cleanliness and sanitation.
- Ensures that—
  - Hygiene and sanitation measures conform to AR 40-5 and related regulations.
  - Latrines are available 24 hours a day.
  - Separate showers and latrines are available for males and females.
  - Adequate space is allocated to prevent overcrowding within housing units, while maintaining proper segregation and family integrity.
  - Good food sanitation and personal hygiene is observed by food service personnel.
  - Waste is disposed of properly.
  - Sufficient potable water is available for drinking, bathing, doing laundry, and preparing food.
  - Materials are available for personal hygiene, including products for female hygiene and infant care.

## **TRANSFER**

- 5-53. The CIs may be transferred, subject to the following conditions:
- They cannot be transferred outside the borders of the occupied country where they are interned, except when material reasons prevent displacement.
  - They will be transferred if they are exposed to greater risk by remaining at the facility if the CZ moves closer to the location.
  - Sick, wounded, infirmed, or maternity cases are not transferred if the transfer would be detrimental to their health.
- 5-54. The facility commander—
- Informs CIs of their impending transfer and new postal address so that they have enough time to pack and notify NOK.
  - Verifies the accuracy and completeness of personnel records and provides records (in a sealed envelope) to escort guards.
  - Verifies that CIs have authorized clothing and equipment.
  - Prepares impounded personal effects and property for forwarding with escort guards or by separate shipment as appropriate.
  - Instructs escort guards on their duties and responsibilities, including procedures to be followed in case of an attack, an escape, a death, or another emergency.
  - Provides or arranges for rations, transportation, and notifications according to prescribed procedures.
  - Ensures that CIs are manifested by name, ISN or ID number, nationality, and physical condition.

- 
- Notifies the IRIC and the national IRIC of CI transfers immediately.
- 5-55. The transfer of personal effects and property parallels that of EPWs (Chapter 4), except—
- Belongings that exceed the 55-pound limit are shipped separately.
  - Parcels and mail are forwarded to the new facility.
  - Items donated by welfare agencies and items used in religious services are forwarded as community property.

## RELEASE

5-56. A CI can be released to a representative of his country of residence or a designated protecting power if control and accountability are maintained. He can be released after hostilities cease (subject to pending judicial proceedings) if the reasons for his internment no longer exist as determined by the TO commander. A CI who is eligible for release but has judicial proceedings pending for offenses not exclusively subject to disciplinary punishment is detained until the close of proceedings. The TO commander may decide that a CI must serve his penalty before being released, and a CI already serving a penalty may be similarly detained. Rosters of detained CIs are forwarded to the IRIC and the national IRIC for transmittal to protecting powers.

## SOCIAL PROGRAMS

5-57. The commander coordinates social programs. He provides premises and facilities for these activities and procures needed materials and supplies through normal supply channels. The CIs are encouraged to participate, but they are not required to do so.

5-58. Carefully selected and qualified civilian nationals and CIs (supervised by US military personnel) can be used to guide social activities. The selected individuals will not introduce political overtones or further enemy propaganda objectives while conducting these activities.

## EDUCATION

5-59. Encourage and support an active, intellectual education program for CIs. Coordinate adequate facilities and instruction material through local agencies. Consider the following when developing an education program:

- Levels of education throughout the CI population.
- Basic courses of education, including—
  - Reading.
  - Writing.
  - Geography.
  - Mathematics.
  - Language.
  - Literature.
  - History.
  - Music.
  - Art.

- The education of dependents who reside with their CI parents.
- Vocational training to develop skills that may be useful during internment.

## **RELIGION**

5-60. Allow CIs the freedom of worship, including attendance at services of their faith held within the internment facility. Permit chaplains and other clergy to minister freely to those who request their help. The facility commander may permit ordained clergy or theological students to conduct services.

## **VISITS**

5-61. Permit close relatives and other persons authorized by the TO commander to visit CIs according to TO regulations. All visitors are subject to security precautions. Under emergency conditions and subject to the TO commander's policy, a CI may visit a close relative who is seriously or terminally ill and may attend the funeral of a close relative.

5-62. Allow accredited representatives of protecting powers and the ICRC full access to the internment facility and the internees. Per DA policies and procedures, permit visits of approved religious organizations, relief societies, NGOs, IOs IHOs, and other organizations who assist housed personnel. Organizations who want access to internees should coordinate visits in advance to avoid confusion upon arrival at the facility. The facility staff establishes an access roster of representatives and develops a method to verify their identity.

## **RECREATION**

5-63. Encourage and support active participation in recreation activities to promote general health and welfare and to alleviate tension and boredom. In addition, provide athletic contests and group entertainment (concerts, plays, music, and motion pictures). Provide playgrounds for dependent children of CIs.

## **AGRICULTURE**

5-64. When practical, CIs should raise vegetables to supplement their diet. Do not overlook the importance of developing an agriculture program. Gardening projects are particularly desirable because they provide gainful employment for large numbers of individuals. The food produced is used for the benefit of the CI population, and it provides a valuable supplement to diets at minimal expense.

5-65. Procure the types and quantities of agriculture supplies required (seeds, fertilizers, and implements) through local purchase. Ensure that the supplies are procured in a timely manner.

## **EMPLOYMENT**

5-66. The TO commander may issue instructions governing the employment and compensation of CIs for labor. The CIs can be employed to construct,

administer, manage, and maintain the facility; and they are compensated according to DFAS-IN 37-1. The CIs are required to work if the labor is consistent with their age and physical condition. Their fitness for work is determined in the same manner as EPWs (Chapter 4). The CIs cannot be compelled to work if they are under the age of 18. They can be compelled to perform the following types of work and may volunteer to perform other types of work:

- Administrative, maintenance, and domestic work within the compound.
- Duties relative to protecting CIs against aerial attack or other war risks.
- Medical duties if they are professionally and technically qualified.

## **SECURITY**

5-67. The facility commander is responsible for security measures that effectively control CIs with minimal use of force. The physical construction of the facility and the presence of guard personnel (Chapter 2) constitute the most obvious means of providing security. Maintaining a high state of discipline, a system of routines, and required standards of behavior enhance effective security and control.

5-68. Most CIs actively cooperate with US internment facility authorities or assume a passive, compliant role. Cooperative CIs are composed, in part, of individuals with ideologies favorable to the US. Others, through resignation or apathy, will simply adapt themselves to the conditions of their internment.

5-69. Some CIs will engage in a campaign of embarrassing and harassing US personnel to create propaganda of value to their cause that would have negative ramifications on the US. The leaders of the uncooperative faction may try to establish a united effort and blind obedience by all its members. Any relaxation of security is immediately detected and fully exploited.

## **ADVERSE ACTIONS**

5-70. Dissident actions by CIs vary from acts of harassment to acts of violence. Such actions may include—

- Sabotaging equipment or facilities.
- Assaulting other CIs or custodial personnel.
- Taking hostages to secure concessions.
- Intimidating other CIs.
- Fabricating weapons or other illegal items.
- Creating embarrassing situations or making false accusations to influence international inspection teams or members of protecting powers.
- Instigating disturbances or riots to place the facility staff in unfavorable positions (this allows CIs to gain concessions and influence custodial policies).



5-71. Paramilitary forces may—

- Establish communications with internees by using agents, smuggled radios, or foreign-language newspapers.
- Order members of its armed forces to infiltrate the facility and become agitators.

## **PLANNING**

5-72. Ensure that security planning is continuous and complete and that it reflects current intelligence information on CIs. Implement an immediate-response plan that is capable of meeting all internal and external threats to security. Security planning for a CI compound is similar to that for an EPW compound (Chapter 4). (See Chapter 2 for more information on security planning.)

## **RULES OF ENGAGEMENT**

5-73. The CINC establishes the ROE in coordination with the SJA and the joint staff. Special ROE can be developed for use in I/R facilities, but they must have CINC approval.

## **MILITARY WORKING DOGS**

5-74. The MWDs enhance the security and safety of an I/R facility. They can be used for patrolling and detecting explosives and narcotics. (See Chapter 2 and AR 190-12 for more information.)

## **DISTURBANCES**

5-75. Disturbances within the compound may range from riots to less violent disorders, and they can be organized or unorganized. (See Chapter 3 and Appendix B for more information.)

## **FACILITY MARKINGS**

5-76. When military considerations permit, mark CI facilities with the letters “CI.” Place the letters so that they are clearly visible in the daytime from the air.

## Chapter 6

# Internment/Resettlement Facilities

The TO commander is responsible for EPW/CI operations, and he provides engineer and logistical support for the MP commander to establish and maintain I/R facilities. Facility construction is included in the planning phase of an operation, and MP leaders take part in the planning process. Planning, coordinating, and establishing facilities begins during the build-up phase of an operation. Each facility provides appropriate segregation, accountability, security, and support of internees. An I/R facility is semipermanent in nature and normally consists of one to eight compounds, each capable of interning 500 people. (Appendix D provides a synopsis of the various MP I/R units that may be assigned to a TO.)

### PLANNING

6-1. Planning for the construction of I/R facilities must be projected into the future. This provides timely notification of engineers, selection and development of facility sites, and procurement of construction materials.

### LOCATION

6-2. The MP coordinate the location with engineers, logistical units, higher headquarters, and the HN. The failure to properly consider and correctly evaluate all factors may increase the logistical and personnel efforts required to support operations. If an I/R facility is improperly located, the entire internee population may require movement when resources are scarce. When selecting a site for an facility, consider the following:

- Will the interned population pose a serious threat to logistical operations if the tactical situation becomes critical?
- Is there a threat of guerrilla activity in the area?
- What is the attitude of the local population?
- What classification of internees will be housed at the site?
- What type of terrain surrounds the site, and will it help or hinder escapes?
- What is the distance from the MSR to the source of logistical support?
- What transportation methods are required and available to move internees, supplies, and equipment?

6-3. In addition, consider the—

- METT-TC.
- Proximity to probable target areas.
- Availability of suitable existing facilities (avoids unnecessary construction).

- Presence of swamps, mosquitoes, and other factors (including water drainage) that affect human health.
- Existence of an adequate, satisfactory source of potable water. The supply should meet the demands for consumption, food sanitation, personal hygiene, and sewage disposal.
- Availability of electricity. Portable generators can be used as standby and emergency sources of electricity.
- Distance to work if internees are employed outside the facility.
- Availability of construction material.
- Soil drainage.

## CONSTRUCTION

6-4. The type of construction necessary depends on the—

- Climate.
- Anticipated permanency of the facility.
- Number of facilities to be established.
- Availability of labor and materials.
- Conditions under which the detaining power billets its forces in the same area.

6-5. Use local, vacant buildings to reduce the requirements for engineer construction materials and personnel. Use internees and local sources of materials to modify and construct structures. In the absence of existing structures, tents are the most practical means for housing internees.

6-6. The Engineer Corps' Theater Construction Management System (TCMS) contains basic plans, specifications, and material requirements for I/R facilities based on the anticipated internee population. The plans can be easily modified for temperate, frigid, tropic, and desert climates. The TCMS also provides specifications and material requirements for the facilities when dimension and/or population requirements are supplied.

## SECURITY REQUIREMENTS

6-7. Separate the compounds from each other to prevent communication between internees. Take advantage of irregular terrain features as obstacles to communication. Locating compounds in close proximity increases efficiency and security; however, distances of a mile may be required between compounds on level terrain. Minimal security requirements include—

- **Clear zones.** A 12-foot clear zone surrounds each facility housing EPWs or CIs. The clear zone is free of vegetation and shrubbery between the inside and outside perimeter fences, and it is constructed around the circumference of the facility.
- **Guard towers.** Locate guard towers on the perimeter of each facility. Place them immediately outside the wall or, in case of double fencing, where they permit an unobstructed view of the lane between the fences. The space between towers must allow overlapping observation and fields of fire. During adverse weather, it may be necessary to augment security by placing fixed guard posts between towers on the

outside of the fence. Ensure that towers are high enough to permit an unobstructed view of the compound and low enough to permit an adequate field of fire. Tower platforms should have retractable ladders and be wide enough to mount crew-served weapons.

- **Lights.** Provide adequate lighting, especially around compound perimeters. Illuminating walls and fences discourages escapes, and illuminating inner strategic points expedites the handling of problems caused by internees. Protect lights from breakage with an unbreakable-glass shield or a wire mesh screen. Ensure that lights on walls and fences do not interfere with guards' vision. Provide secondary emergency lighting.
- **Patrol roads.** Construct patrol roads for vehicle and foot patrols. They should be adjacent to outside perimeter fences or walls.
- **Sally ports.** A sally port (a series of gates) is required to search vehicles and personnel entering or leaving the main compound. Consider placing a sally port at the back entrance to the facility.
- **Communications.** Ensure that communication between towers and operation headquarters is reliable. Telephones are the preferred method; however, ensure that alternate forms of communication (radio and visual or sound signals) are available in case telephones are inoperable.

## LAYOUT

6-8. The facility layout depends on the nature of the operation, the terrain, building materials, and HN support. A standard 4,000-man I/R facility consists of eight 500-man compounds. A sample 500-man compound is shown in Figure 6-1, page 6-4. Each compound has—

- Barracks (may be general purpose [GP] medium tents in the early stages of an operation).
- Kitchen facilities (may include providing internees with culinary equipment and provisions or using military cooks).
- Bath houses.
- Latrines.
- A recreation area.

6-9. The administrative area of each facility has—

- A command post.
- An administrative building.
- Religious and educational buildings.
- A dispensary and an infirmary to treat minor illnesses and injuries.
- A supply building for storage and issue of expendable supplies.
- Latrines.
- Parking areas.
- Trash collection points.
- Potable-water points.
- Storage areas (open and covered).
- Generator and fuel areas.

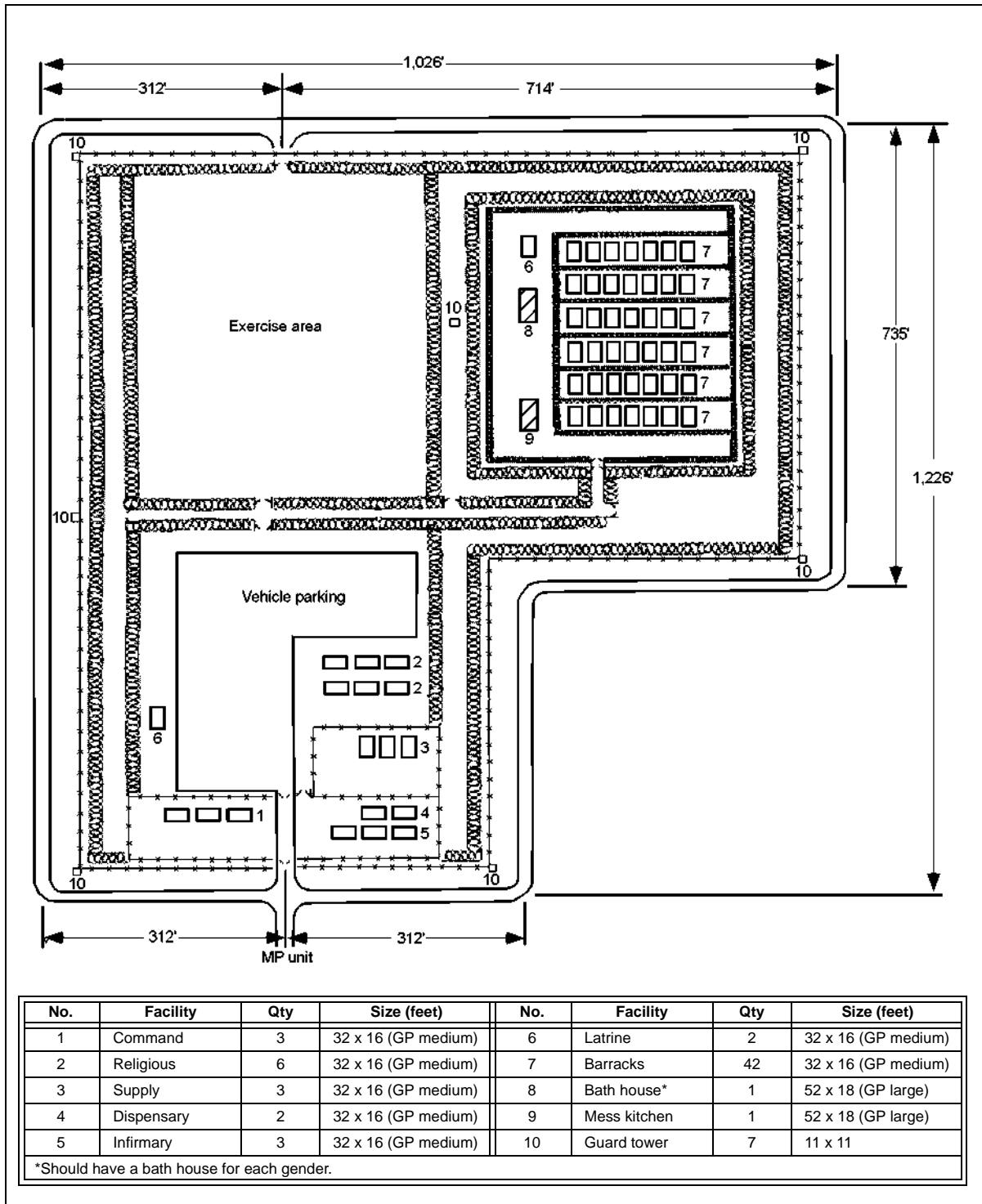


Figure 6-1. Sample 500-Man Enclosure With One Compound

## RECEIVING AND PROCESSING CENTERS

6-10. Captives must be fully processed before being interned, evacuated, or repatriated. The size of a processing center depends on the anticipated number of internees. It may be set up near overseas terminals, international transfer points, and medical facilities. There is no set design for a processing center (Figure 6-2), and a processing center may also have minimal internment capabilities (Figure 6-3, page 6-6).

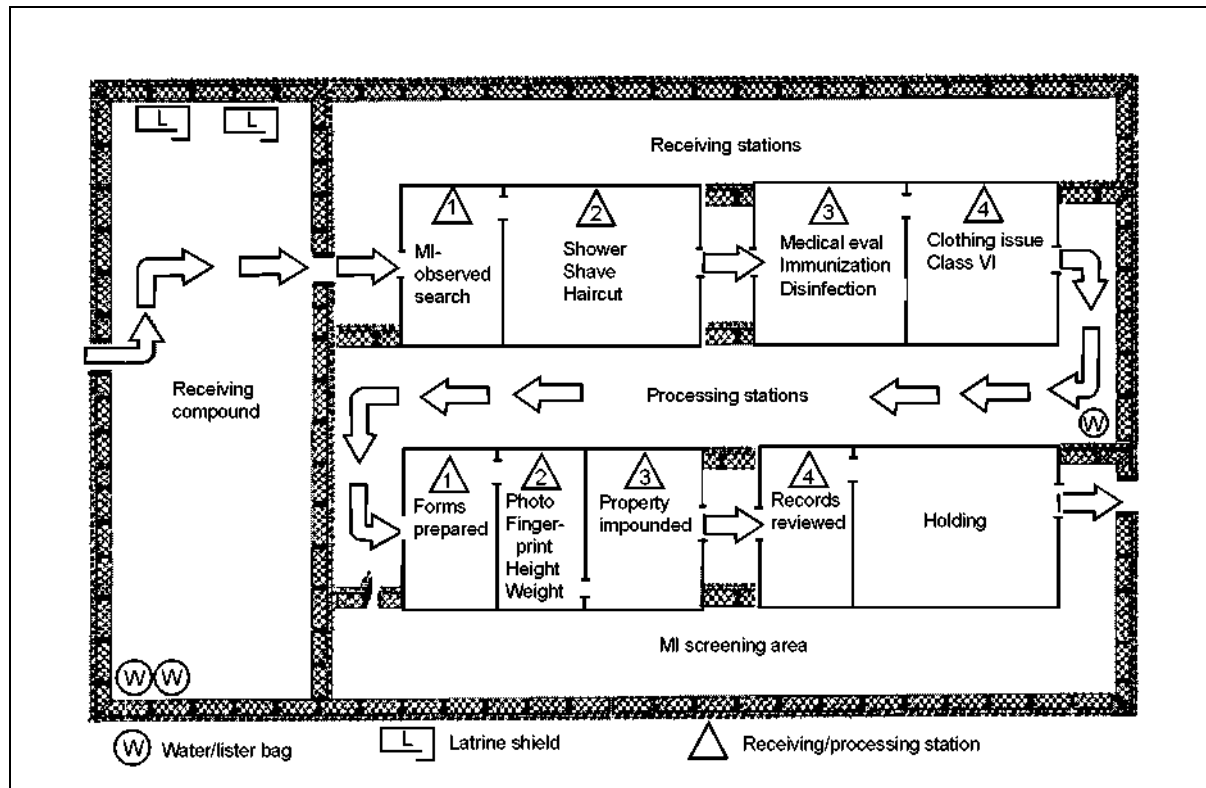


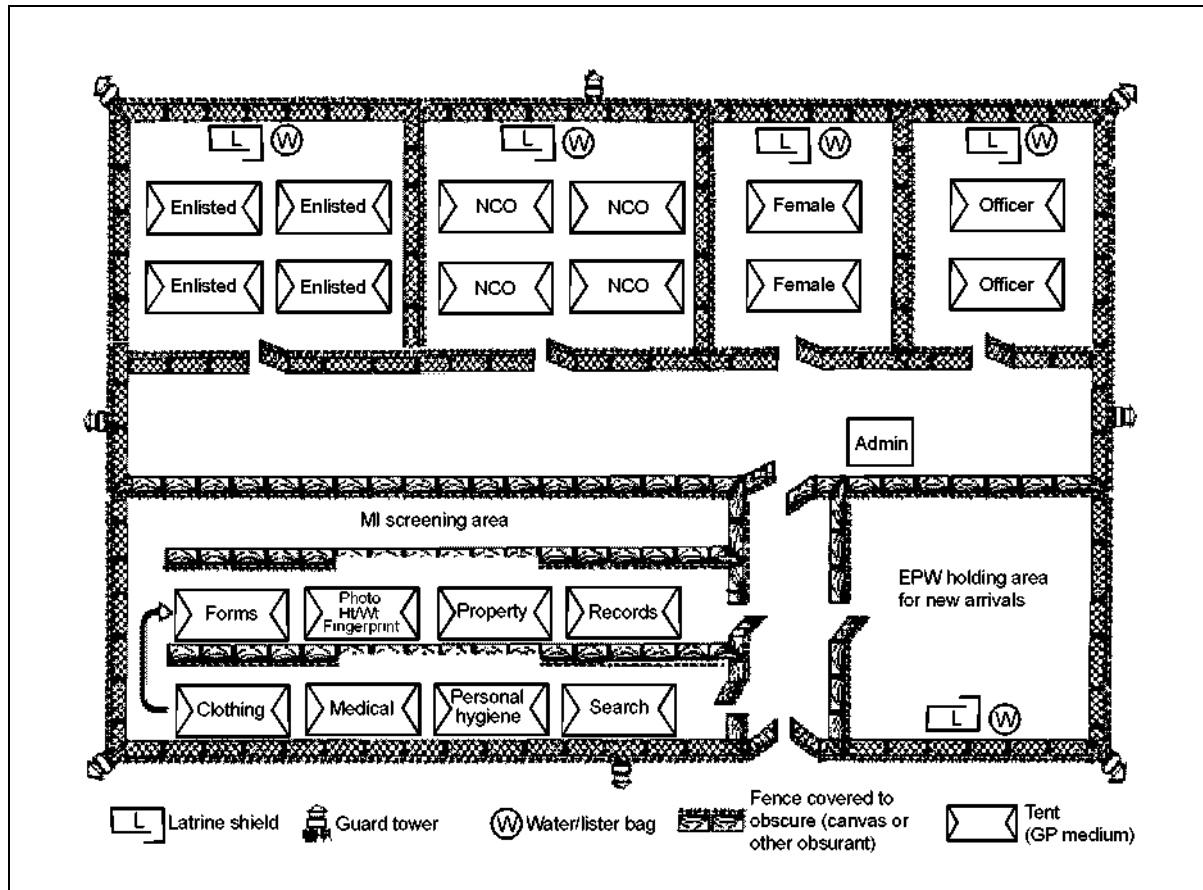
Figure 6-2. Sample Processing Center (Theater)

6-11. When establishing a processing center, coordinate with engineers for construction. If structures are available, use them; otherwise, use tents. Ensure that shelter, water, and latrines are available and that the processing center is equal in quality to facilities used by US forces. Arrange the processing center so that internees are not aware of what is taking place in the next station.

6-12. The prescribed standards of treatment and care place a great demand on the logistical system. When possible, use captured supplies and equipment and ensure that internees wear captured clothing. Properly secure and account for all supplies and equipment to avoid exploitation by internees.

## SUBSISTENCE

6-13. Ensure that daily food rations are sufficient in quantity, quality, and variety to maintain good health and prevent weight loss and nutritional



**Figure 6-3. Sample Processing Center with Internment Capability**

deficiencies. Medical personnel apprise the commander of situational needs and the nutritional health of the internee population. Provide working internees with additional rations when required. Ensure that internees have sufficient drinking water and latrine facilities. Sustain the health of internees at a level that is equal to that of guarding US forces.

6-14. If dining facilities are unavailable, feed internees MREs. They can be stored easily and require no additional dietary supplements. If fresh fruits and vegetables are available, substitute them for nonperishable items. Consider the habitual diet of internees, and allow them to prepare their own meals under the supervision of US personnel (see AR 190-8). Ensure that internees do not stockpile rations to use for escapes.

6-15. Food service equipment requirements vary depending on internees' habitual diets and customs. The commander may authorize local procurement of cooking equipment instead of requiring internees to use standard-issue kitchen equipment. One food operations sergeant and one first cook will be assigned to each 19547AB MP detachment (I/R) (EPW/CI). Food service personnel train and supervise selected internees to perform food service operations.

---

## **CHAPEL FACILITIES**

6-16. Provide chapels and religious materials in I/R facilities. Allow internees to make chapel fixtures from available material or, if necessary, obtain material through supply channels.

## **RECREATION EQUIPMENT**

6-17. Obtain recreation equipment through supply channels if possible. If necessary, secure equipment through local purchase.

## **CLEANING SUPPLIES**

6-18. Each I/R facility requires housekeeping supplies. The types and quantities required vary depending on the environment, the housing, and the food service facility. Common Table of Allowance (CTA) 50-970 contains an extensive list of housekeeping supplies. Use it as a guide to develop allowances for janitorial and cleaning supplies. Ensure that there is plenty of potable water available in each compound.

## **MEDICAL AND SANITATION CONSIDERATIONS**

6-19. Ensure that medical treatment is available for all internees. Each I/R facility has an infirmary where internees with contagious diseases, mental conditions, or other illnesses can be isolated from other patients. Internees have 24-hour access to latrines, which are clean and conform to the rules of hygiene. Provide separate latrines for male and female internees. Provide internees with facilities, soap, and water for their personal needs and laundry. Consider the following sanitation standards to prevent disease and ensure cleanliness of the facility:

- Distributing information to internees (in their language) on the importance of proper hygiene, sanitation, and food sanitation.
- Teaching food sanitation procedures and ensuring that they are observed and practiced.
- Disposing of human waste properly to protect the health of everyone associated with the facility according to the guidelines established by PVNTMED.
- Providing—
  - Adequate space to prevent overcrowding.
  - Sufficient showers and latrines and ensuring that they are cleaned and sanitized daily.
  - Enough potable water for drinking, bathing, doing laundry, and conducting food service operations.
  - Personal-hygiene materials.



## **PART THREE**

# **United States Military Prisoners**

The US military prisoner operations are conducted under the umbrella of the Army Corrections System (ACS). The ACS is an integral part of the military justice system, which provides incarceration and correctional services for US military personnel. The ACS provides custody and control of military offenders, while providing access to basic education, offense-related counseling, selected academic courses, and training necessary for return to military duty or the civilian community. Specific use-of-force guidelines and the ROI apply to US military prisoner operations. On the battlefield, US military prisoner operations parallel the internment and evacuation systems for EPWs, CIs, RPs, ODs, and DCs. However, US military prisoners are not treated as or confined with them.

Chapter 7 contains information on the ACS and provides the foundation and guidance for conducting US military prisoner operations during wartime. Chapter 8 discusses the short-term confinement of US military prisoners abroad during wartime, the field detention facility (FDF), and the field confinement facility (FCF).

---

## **Chapter 7**

# **Army Corrections System**

The ACS provides confinement and correctional treatment for US military prisoners. It operates on a corrective basis, rather than a punitive basis, and its goal is to help prisoners become responsible, productive citizens. The ACS facilities are staffed with carefully selected, well-trained, professional personnel. Prisoners have access to programs that provide education and rehabilitation. The staff and the programs are dedicated to helping prisoners recognize and resolve their problems, correct their behavior, and improve their attitudes.

## **LEVELS OF CONFINEMENT**

7-1. The Army maintains a three-tiered correctional system to meet the needs of prisoners. Although the mission at all levels is to confine and provide correctional treatment, the mission emphasis differs at each level. These differences are based on the length of time prisoners are confined and the facilities and services required by the confinement.

**LEVEL I—CONFINEMENT FACILITIES**

7-2. Confinement facilities provide—

- Pretrial confinement.
- Short-term posttrial confinement (normally 90 days or less).
- Custody.
- Control.
- Administrative support.
- Limited counseling.

7-3. Installations without ACS facilities can contract to incarcerate pretrial prisoners in federally approved civilian jails. Agreements must provide for segregation of prisoners by rank (officer, NCO, and enlisted), sex, and posttrial status. Forward copies of agreements with civilian jurisdictions to HQDA (DAMO-ODL-C). A sentenced prisoner who is pending transfer to an ACS facility cannot be confined in a civilian jail for more than 10 days. However, an installation commander can notify HQDA (DAML-ODL-C) and authorize exceptions for prisoners sentenced to 30 days or less.

**LEVEL II—REGIONAL CORRECTIONS FACILITIES**

7-4. Regional corrections facilities (RCFs) provide—

- Pretrial confinement support.
- Multifaceted correctional-treatment programs.
- Vocational and military training to prepare prisoners for return to duty or, if determined suitable, return to civilian society.
- Administrative support.
- Basic educational opportunities.
- Employment.
- Selected mental-health programs.
- Custody.
- Control.

**LEVEL III—UNITED STATES DISCIPLINARY BARRACKS**

7-5. The United States Disciplinary Barracks (USDB) is a maximum-custody facility that provides long-term incarceration for prisoners. It is the only ACS facility authorized to permanently incarcerate posttrial prisoners who are sentenced to death.

7-6. Although federal civilian penal institutions are not a part of the ACS, they may be used to confine prisoners. The Federal Bureau of Prisons administers and operates the federal penal system. Military prisoners whose disciplinary and adjustment records indicate a need for treatment that is available in a federal penal institution may be transferred to that system. Those scheduled for incarceration in a federal institution are first confined at the USDB and then transferred to the federal institution. (See AR 190-47 for more information.)

---

## **CORRECTIONAL FACILITIES**

7-7. Based on operational requirements and programs, HQDA (DAMO-ODL-C) determines where prisoners are incarcerated if they are sentenced to more than 30 days. The RCF provides short- and medium-term confinements, and the USDB provides long-term confinement.

7-8. The facility commander is responsible for the administration and operation of specialized correctional programs. The programs provide the professional evaluation, counseling, education, and administration needed to prepare prisoners for return to military or civilian life. Chapter 8 discusses procedures and guidelines for establishing FDFs and FCFs.

## **LEGAL RIGHTS AND REQUIREMENTS**

7-9. The UCMJ and local and service regulations govern the restraint and confinement of military personnel. The ACS provides legal, humane, and just treatment of prisoners throughout the confinement process, from pretrial confinement to sentence expiration.

## **PRISONERS' RIGHTS**

7-10. Soldiers do not automatically forfeit all of their rights upon confinement. Prisoners retain most of the rights guaranteed by the US Constitution, although perhaps to a lesser degree. The most important constitutional rights for prisoners are:

- First Amendment (freedom of speech and religion).
- Fourth Amendment (freedom against unreasonable search and seizure).
- Fifth Amendment (right against self-incrimination [Miranda Rights]).
- Sixth Amendment (right to counsel).
- Eighth Amendment (prohibition of cruel and unusual punishment).

## **CONFINEMENT REQUIREMENTS**

7-11. Prisoners in pretrial confinement are informed of the charges causing their confinement. Within 48 hours of their confinement (via their chain of command), a US magistrate reviews the circumstances of the confinement and determines whether continued pretrial confinement is necessary.

7-12. Individuals are accepted for confinement only on receipt of a court-martial order, a report of the trial results, or a confinement order. The convening authority ordering the execution of the sentence must issue the court-martial order. If a commissioned or warrant officer is placed in pretrial confinement, the confinement order originates with his commander. The confinement order is read to the soldier by a commissioned officer. An enlisted soldier may be pretrial confined by order of his commanding officer or any commissioned officer who has personal knowledge of the offense or has made inquiry into it.

7-13. Specific procedures for pretrial confinement are contained in local SOPs and local supplements to AR 27-10. A new confinement order is not needed to reconfine a soldier who is convicted at trial by court-martial following pretrial

confinement. A commander or the trial counsel, if such authority is delegated to him, can order the soldier into posttrial confinement with a report of the trial results.

## PRISONER STATUS

7-14. A prisoner or a pretrial detainee is informed of his status upon arrival at a confinement facility. His status is necessary in response to judicial proceedings and other actions. The following statuses pertain to US military prisoners:

- **Casual.** A casual prisoner is confined awaiting—
  - Further instructions from another command or military service.
  - Transfer to another facility.
  - Return to his unit.
- **Detained.** A detained prisoner (pretrial detainee) is an enlisted service member who is confined awaiting—
  - Charges to be filed.
  - The disposition of charges.
  - A trial by court-martial.
  - A trial by a foreign court.
- **Adjudged.** An adjudged prisoner has been sentenced in open court, but the convening authority has not approved the sentence.
- **Approved-adjudged.** An approved-adjudged prisoner's sentence has been approved and adjudged, but it has not been ordered into execution.
- **Sentenced.** A sentenced prisoner is serving a sentence that has been ordered into execution.
- **Officer.** An officer prisoner or an officer pretrial detainee is a commissioned or warrant officer on active duty who has been placed in confinement, but his sentence has not been ordered into execution.

## SEGREGATION

7-15. Segregate prisoners as follows:

- **Pretrial detainee.** A pretrial detainee is not treated the same as a posttrial prisoner whose status is adjudged, approved-adjudged, or sentenced. He has not been proven guilty of an offense. His confinement is not a punishment, but it ensures his presence for trial and prevents further misconduct. If possible, segregate his living and working areas from all other prisoners.
- **Officer.** An officer prisoner whose sentence has not been ordered into execution is entitled to certain rights and privileges. These privileges end when an officer's sentence begins and his status changes from an officer prisoner to a sentenced prisoner. House a posttrial officer prisoner in the general prisoner population.
- **Female.** A female prisoner or a female pretrial detainee is confined in a facility that is approved for housing women. If an on-post facility is unavailable, coordinate confinement with local officials who have a federally approved detention facility for women. A civilian facility may

---

only be used for pretrial or short-term, posttrial confinement. Segregate female prisoners from male prisoners except when they are participating in supervised classes, vocational education, or group counseling. Female correctional personnel supervise and control female prisoners in administration or disciplinary segregation. If two female guards are unavailable, use precautions when escorting a female prisoner. For example, use two male guards or one male guard and one female guard. Female prisoners are incarcerated in ACS facilities when directed by HQDA (DAMO-ODL-C).

## **CUSTODY AND CONTROL**

7-16. Custody and control are basic functions for every confinement or correctional facility. Facility personnel achieve and maintain custody and control by subjecting prisoners to a structured schedule of calls 24 hours a day.

### **CUSTODY MEASURES**

7-17. Custody is restricting a prisoner's freedom of movement by placing physical barriers on or around him. It is maintained within a facility by the presence of guards, walls, fences, protective lighting, alarms, and locking devices. Outside a facility, custody is maintained by the presence of supervisors and guards. Prisoners designated as trustees are afforded custody and control by the conditions placed on their parole agreement.

### **CUSTODY GRADES**

7-18. Each prisoner is assigned a custody grade (trustee, minimum, medium, or maximum) that designates the degree of supervision required to control his movements. The facility commander assigns custody grades to prisoners based on signs of emotional disturbance and instability, history of escape, drug addiction, violence, and access to sensitive material.

7-19. Custody grades are assigned based on the minimum level of control necessary. A custody grade can be changed at any time, and reclassification is based on continual observation and evaluation of the prisoner. Each prisoner is promptly advised of his custody grade.

7-20. For example, each incoming RCF prisoner is assigned a maximum custody grade for the first 72 hours of confinement. During that time, the correctional staff observes and evaluates the prisoner's behavior. At the end of the evaluation period, the staff reviews the prisoner's behavior and assigns the appropriate custody grade.

### **ADMINISTRATIVE SEGREGATION**

7-21. Sometimes, prisoners must be separated from the larger population for more intense custodial supervision. Facility commanders may authorize the segregation of prisoners individually or by groups. Administrative segregation is imposed for the benefit of the segregated prisoner(s) or the prisoner population. Prisoners may be placed in administrative segregation while awaiting the results of an investigation or for protective measures, medical reasons, or homosexual behavior.

7-22. Segregated prisoners requiring increased supervision are placed in close confinement and are escorted when they leave their cells. Privileges for administratively segregated prisoners are the same as those of prisoners not in close confinement. However, exceptions to this requirement are suicidal and disciplinary segregated prisoners (see the facility SOP for details).

7-23. Prisoners placed in administrative segregation can be kept in close confinement 24 hours a day or only at night. They must receive at least 60 minutes of exercise daily and can be employed if the work is consistent with the purpose of the segregation. A qualified mental-health professional interviews and prepares a written report on each inmate who is segregated more than 30 days.

### **CONTROL MEASURES**

7-24. Control is placing limitations on a prisoner's actions and behaviors. It is invoked by the correctional staff's insistence on a state of order and military discipline among the prisoners. Control is sustained by a consistent routine in daily lives. For example, prisoners are routinely required to provide a daily display of their clothing, equipment, and health and comfort supplies. Control is reflected in the disciplined appearance, bearing, and conduct of the prisoners and by their prompt obedience to rules, regulations, and orders.

### **DISCIPLINARY MEASURES**

7-25. Disciplinary measures are imposed on prisoners to correct deviant behavior and to protect other prisoners, the staff, and government property. Abusive measures are not imposed in the ACS. Prisoners are medically cleared before being placed in disciplinary segregation, which may not exceed 60 consecutive days. Prisoners undergoing disciplinary measures are not employed, except to clean their own quarters. They must receive at least 30 minutes of exercise each day if their behavior is manageable. Hand and leg irons or other restraining devices are used during movement outside the cell. Guards inspect prisoners in close confinement according to the facility SOP.

7-26. The imposition of disciplinary measures often begins with an objective disciplinary report. The report presents a detailed summary that addresses the who, what, when, where, why, and how of an incident. The facility commander has several options when he receives a disciplinary report. He may reduce the report to a memorandum of record, refer the prisoner for counseling, refer the case to a discipline and adjustment board, or recommend action under the UCMJ.

### **PROHIBITED PUNITIVE MEASURES**

7-27. The following punitive measures are prohibited:

- Clipping a prisoner's hair excessively close.
- Ordering the lockstep.
- Requiring silence at meals.
- Requiring a prisoner to break rocks.

- Using hand or leg irons, restraining straps or jackets, or shackles as punishment. (The FCF SOP gives authority for the use of these devices and specifies the circumstances warranting their use.)
- Removing a prisoner's underclothing or clothing or using other debasing practices.
- Flogging, branding, tattooing, or using any other cruel or unusual punishment.
- Requiring domicile in a tent as punishment.
- Ordering strenuous physical activity or body positions designed to place undue stress on a prisoner.
- Using hand or leg irons or belly chains that give the appearance of a chain gang.

## **EMERGENCIES**

7-28. Confinement facilities provide custody and control of prisoners during emergencies (fires, escape attempts, and other disturbances). Develop a formal emergency action plan and periodically review it to ensure that it is complete and current. Properly training custodial personnel and reviewing facilities and restraints can prevent or greatly reduce the possibility of escapes. Escapes result in emergency actions being executed and guards and prisoners taking immediate action according to the facility SOP.

7-29. Disturbances among prisoners may be a minor disorder, a major disorder, or a full-scale riot. Disorders and riots may be spontaneous disturbances or organized diversions for escape attempts. How a facility staff handles a minor disorder determines whether it is brought under control or escalates to major proportions. Disperse prisoners who are involved in a disturbance so that they cannot organize as a cohesive group. Once dispersed, prevent participants from rejoining the disturbance. Identify, isolate, and remove ringleaders from the disturbance as soon as possible.

## **MOVEMENT**

7-30. Prisoners have the best opportunity for escape while being moved from one place to another (outside the facility). Established and stringent custody and control measures reduce the likelihood of escapes. Procedures and techniques for moving prisoners can be modified as needed by the facility commander or the commander directing the movement.

7-31. When a prisoner is in pretrial confinement, his unit is responsible for escorting him to the confinement facility unless custody and control become integrity issues. The unit coordinates with the RCF for a briefing on custody and control procedures, future escort requirements, and the use of force.

7-32. Frisk each prisoner before he leaves the facility. Complete a DD Form 2708 (hard copy or electronic) for each prisoner escorted out of the facility. Move prisoners by motor vehicle, rail, air, or foot (if the distance is short enough to justify it and when other means of transportation are unavailable) (see STP 19-95C14-SM-TG).

## **CORRECTIONAL-TREATMENT PROGRAMS**

7-33. Correctional-treatment programs are based on and tailored to the custody, employment, education, and treatment needs of prisoners. Each prisoner and his treatment is professionally monitored. The goal of correctional-treatment programs is to return prisoners to civilian life as productive citizens or to the Army as productive soldiers.

7-34. Correctional-treatment programs provide a professional evaluation and study of each prisoner and his background. They provide for prisoners' health and welfare, include constructive work that teaches work skills, and administer individual and group counseling and therapy.

7-35. Each program specifies the custody grade and disciplinary requirements needed to achieve goals. The goals can be achieved by receiving no disciplinary reports, being involved in an established correctional-treatment plan, or obtaining other program objectives.

## **EVALUATION**

7-36. The facility commander, in conjunction with an evaluation board, determines a prisoner's custody grade and treatment program by a two-phase system. The first phase is to identify the needs that require immediate intervention, and the second phase is an ongoing evaluation of the prisoner while he is in confinement.

7-37. The board uses the following tools to begin its initial evaluation:

- The guard's observation report.
- The mental health's evaluation.
- The chaplain's evaluation.
- The medical officer's evaluation.
- The prisoner's personnel file.

7-38. The prisoner's custody grade and treatment program may change as additional information becomes available during his incarceration. The following aspects are considered and closely monitored during his entire confinement period:

- Employment.
- Education.
- Medical condition.
- Religious participation.
- Family and financial problems.

## **COUNSELING**

7-39. Counseling is a process in which behavioral problems are observed and guidance is provided to induce productive, useful behavior. Counseling programs are based on the type, size, and mission of a confinement facility, its staffing abilities, and AR 190-47. At a minimum, counseling is available for problem solving and crisis intervention. The ACS regional facilities and the USDB provide the following:

- Chemical abuse treatment.



- Anger management.
- Stress management.
- Adjunct therapy (such as Alcoholics Anonymous [AA] and Narcotics Anonymous [NA]).
- The impact of crimes on victims.
- Other programs consistent with staffing, professional support, and prisoner needs.

7-40. The RCF primarily relies on counseling/treatment programs available to all soldiers. Installations unable to provide basic regional counseling services request a waiver from HQDA (DAMO-ODL).

7-41. The counseling program in a correctional facility has two goals:

- Help prisoners set realistic goals and adjust to the confinement environment.
- Help prisoners gain problem-solving techniques and develop acceptable behavior.

7-42. The facility commander can choose counselors from assigned cadre. When possible, he selects experienced, mature NCOs who do not have a corrections background. He ensures that counselors are oriented to the missions, objectives, and operational procedures of the facility before they begin their counseling duties. Counselors must understand and be able to apply certain principles and concepts of human behavior and social values. They—

- Believe in the dignity and worth of an individual.
- Recognize that individuals are different.
- Understand that all behavior has meaning.
- Understand that individuals are the result of their environment and life experiences.
- Understand that attitude and behavior are related.
- Understand that there are always reasons or causes for changes in behavior.
- Believe that people have the capacity to change.
- Believe that people have a right to participate in decisions affecting their welfare.
- Understand that judging individuals in terms of right and wrong is not within their purview.
- Are objective and unbiased.
- Are alert for situations that exceed their capabilities and responsibilities, and if necessary, refer the prisoner for specialized counseling or problem solving.

7-43. Staff members identify and report prisoners who are—

- Escape-minded.
- Dangerous.
- Alcoholic.
- Drug-addicted.
- Sexually deviant.

- Suicidal.
- Emotionally disturbed (refer prisoners to mental health for evaluation).

7-44. Continuity is essential to a successful counseling program. Ideally, a counselor is assigned to a prisoner and continues to work with him throughout his confinement. The counselor makes contact with the prisoner within 48 hours of his inprocessing. The counselor completes necessary records (journal and worksheet) and initiates a follow-up plan. He maintains a case file on each prisoner that contains a record of counseling sessions, a personal-data sheet, observation reports, or other correspondence. High prisoner morale and the lack of disciplinary problems reflect a successful counseling program. The final test is a prisoner's satisfactory adjustment on his return to society. (See FMs 8-51 and 22-100 for more information on counseling.)

## **EMPLOYMENT AND EDUCATION**

7-45. Prisoners can be employed in tasks that benefit them and meet the needs of the facility. Education activities take priority over work projects. The USDB employment and education programs are key correctional tools for preparing prisoners to return to civilian life. The programs provide prisoners with marketable skills and self-confidence, and they teach the value of self-discipline. Job training opportunities range from unskilled, manual labor to highly skilled trades.

7-46. Close coordination between the facility commander and the garrison commander or his equivalent is maintained to establish worthwhile work projects for prisoners. The facility commander approves work projects and the assignment of prisoners to work projects. The employment section determines the best type of employment for each prisoner. The needs of the facility are considered along with the prisoner's—

- Education.
- Aptitude and achievement scores.
- MOS.
- Attitude and interests.

## **RECREATION**

7-47. Nonduty activities fill gaps between work and education activities and take up idle time that might otherwise be used for undesirable activities. Encourage prisoners to develop nonduty time interests, and when possible, set up a program to guide and direct nonduty activities. A prisoner's involvement in nonduty activities indicates that he is adjusting to confinement. Note and report soldiers who are not participating in nonduty activities.

7-48. Ensure that prisoners have access to a library and recreation facilities. Based on the commander's approval, prisoner recreation programs may include sporting events, hobbies, motion pictures, videotapes, and religious activities. Encourage prisoners to further their academic education by taking part in the facility's education program or through self-study courses offered by the Army Correspondence Course Program (ACCP).

## COMPENSATION, CLEMENCY, AND PAROLE

7-49. Prisoners who respond well to correctional treatment can be rewarded in several ways. The severity of their sentences may be lessened, their sentences may be reduced, or they may be granted greater freedom and more privileges. These rewards help maintain morale, discipline, and welfare.

### COMPENSATION

7-50. An inmate who is serving a sentence to confinement (other than a life sentence) can earn time off the sentence term by taking part in selected activities for which extra good-conduct time (EGCT) is authorized. The EGCT is an additional incentive to prisoners who demonstrate excellence in work, education, or vocation. It is awarded at the rate shown in Table 7-1. Only those prisoners who demonstrate ability, initiative, and productivity and meet the eligibility criteria for their assigned duties are recommended for EGCT.

**Table 7-1. Rates for EGCT**

Level	Description	EGCT
1	Prisoners continuously employed 1 to 5 months	1 day per month
2	Prisoners continuously employed 6 to 10 months	2 days per month
3	Prisoners continuously employed 11 to 15 months	3 days per month
4	Prisoners continuously employed 16 to 20 months	4 days per month
5	Prisoners continuously employed 21 to 25 months	5 days per month
6	Prisoners serving as assistant instructors or supervisor assistants (following attainment of Level 5) <sup>1</sup>	6 days per month
7	Trustees who have maintained Level 6 for 6 months <sup>2</sup>	7 days per month
<p><sup>1</sup>A prisoner (including a trustee) who loses his position as an assistant instructor or a supervisor assistant is reduced to Level 5 or the earning level held prior to elevation, whichever is less.</p> <p><sup>2</sup>The Level 7 increase is removed if a prisoner is removed from trustee status. He is reduced to Level 6 or the earning level held prior to elevation, whichever is less.</p>		

7-51. Additional EGCT can be authorized for participation in community service programs and special projects that support institutional goals or missions. It is awarded in a lump sum and does not exceed 3 days for any event or 5 days in any month.

### CLEMENCY

7-52. Clemency modifies the severity of a court-martial sentence and can be achieved through mitigation, suspension, or remission as follows. The facility commander makes recommendations concerning each prisoner's sentence if he has responded in a positive manner to correctional programs.

- **Mitigation.** Mitigation lessens the severity of a sentence.
- **Suspension.** Suspension is the granting of a probationary period that results in remission if it is completed successfully.
- **Remission.** Remission cancels the unexecuted part of a sentence to which the remission applies.

## PAROLE

7-53. A parole is based on conduct during confinement or on special circumstances. There are three types of paroles that a prisoner may be awarded—a parole, a temporary home parole (THP), and an emergency home parole (EHP):

- **Parole.** A parole serves as a transition between the strict supervision of confinement and the conditions most likely to ensure a prisoner's earliest assumption of responsibilities as a productive, law-abiding citizen.
- **THP.** A THP is a temporary release from confinement granted to strengthen family relationships, and it provides incentive and reinforcement to positive behavior and morale.
- **EHP.** An EHP is a temporary release from confinement due to an emergency, such as the death or critical illness of an immediate family member or a disaster.

7-54. The facility commander notifies victims and witnesses who are identified in the prisoner's correctional-treatment file (CTF) that a prisoner is being released from confinement (see AR 190-47, DOD Directive 1030.1, and DOD Instruction 1030.2). Notify victims and witnesses by the most direct means practicable before releasing a prisoner on THP or EHP. This allows the victim or witness the opportunity to respond, favorably or negatively, to the proposed release.

## CLEMENCY AND PAROLE BOARD

7-55. The facility commander appoints a permanent board that consists of at least three voting members (one officer and two enlisted). He may also assign nonvoting members to the board. The board considers factors involved in a prisoner's request for clemency or parole and recommends acceptance or rejection of the request to the Army Clemency and Parole Board.

## CORRECTIONAL STAFF

7-56. The ACS correctional staff consists of dedicated professionals who serve as positive role models for prisoners. Staff members include corrections NCOs and specialists (MP who have entered the corrections career program and received resident training in MOS 95C at the US Army Military Police School). Due to their close contact with prisoners, corrections NCOs and specialists must be firm, fair, and decisive. Their behavior and attitude form an integral part of the correctional-treatment process. Support personnel are experts in areas other than corrections, but their expertise plays an important role in the facility.

## CORRECTIONAL-SUPERVISION BRANCH

7-57. The chief, correctional-supervision branch (CSB) (senior corrections NCO)—

- Assists in the custodial operations of the facility.
- Supervises correctional and custodial personnel within the facility.

- Informs the facility commander of matters that affect the custody, control, and security of the facility.
- Ensures that rules, regulations, and SOPs are followed and enforced.

### **Guard Commander**

7-58. The guard commander—

- Supervises custodial personnel.
- Is responsible for prisoner activities during his tour of duty.
- Monitors custody, control, and security measures.
- Ensures compliance with the schedule of calls.
- Initiates emergency control measures.
- Maintains the facility blotter.
- Deals with situations involving prisoner admission in the absence of the chief, CSB, and the chief, prisoner services branch (PSB).

### **Prisoner Control Team**

7-59. The prisoner control team NCOIC performs many of the same duties in an I/R battalion module as in a garrison confinement facility. This specialized environment requires the same corrections background to respond to behavioral incidents requiring calm, decisive action. During I/R operations, the NCOIC is responsible for—

- Security.
- Accountability.
- Intelligence. Intelligence is information obtained through observation and reports submitted by guards who are in daily contact with prisoners. The best source of intelligence gathering for the CSB is the guard force.
- The guard force. There are two types of orders for the guard force—general and special. General orders apply to all guards, and special orders apply to particular posts and duties.
- Escape prevention. The MWDs can be used to track an escapee, but they cannot be used to apprehend him.

### **Cellblock Guards**

7-60. Cellblock guards—

- Maintain custody, control, and discipline of prisoners under their supervision.
- Supervise all activities according to the schedule of calls.
- Supervise the response to emergency action plans.
- Conduct periodic inspections, searches, head counts, roll calls, and bed checks.

### **Close-Confinement Guards**

7-61. Close-confinement guards—

- Maintain custody and control of prisoners who are segregated from the general population due to inprocessing or administrative or disciplinary reasons.
- Accomplish activities within the schedule of calls, as applicable to the close-confinement area.
- Conduct 30-minute checks (or 15-minute checks for special-status prisoners) when a DD Form 509 is required.
- Ensure that all required signatures on DD Form 509 are obtained on a daily basis.

### **Dining-Facility Guards**

#### 7-62. Dining-facility guards—

- Maintain custody and control of prisoners during mealtime.
- Ensure that the dining-facility traffic plan is followed.
- Prevent congestion at condiment and juice areas.
- Account for silverware before and after a meal.
- Search prisoners before they leave the dining facility.

### **Employment Detail Guards**

#### 7-63. Employment detail guards—

- Maintain custody, control, and supervision of prisoners while on details.
- Ensure that work details are accomplished and safety precautions are observed.
- Maintain strict accountability of equipment and tools.
- Assist with frisks and strip searches of prisoners returning from details.
- Account for prisoners on details according to the schedule of calls.
- Track prisoners' locations at all times while on details.

### **Escort and Absent-Without-Leave Apprehension Guards**

#### 7-64. Escort and absent-without-leave (AWOL) apprehension guards—

- Maintain custody and control of prisoners while moving them to and from designated places.
- May be armed with a pistol if required and authorized by the facility commander.
- Are qualified with a pistol and trained in the use of force and the ROE.
- Are trained in firearms safety procedures necessary to transport prisoners by land, air, and sea.

### **Main Gate and Sally Port Guards**

#### 7-65. Main gate and sally port guards—

- Maintain custody and control of prisoners.
- Ensure that only authorized persons enter the facility.
- Inspect vehicles entering and exiting the facility.

- Inspect packages.
- Conduct inventories of items entering and exiting the facility.
- Require noncustodial personnel to register on sign-in logs.

### **Visitor Room Guards**

- 7-66. Visitor room guards—
- Maintain custody and control of prisoners during visits by family members and other authorized persons.
  - Detect violations of rules and regulations, improper behavior, and contraband.
  - Position themselves in inconspicuous places and observe conversations rather than listening to them.
  - Identify and report infractions, which may be grounds for terminating visits.

### **Hospital Guards**

- 7-67. Hospital guards—
- Maintain custody and control of prisoners while escorting them to and from medical appointments and during hospitalization.
  - Ensure that rooms are clear of contraband.
  - Prevent unauthorized communications.

### **Tower Guards**

- 7-68. Tower guards—
- Maintain custody and control by observing specific sectors of the perimeter.
  - Are briefed on the use of force and are familiar with a 12-gauge shotgun.
  - Ensure that contraband is not passed through the fence.
  - Provide protection for compound guards.

## **TRAINING**

- 7-69. Personnel assigned to a confinement facility are oriented and trained in the procedures of custody and control. The formal training program includes—
- Supervisory and interpersonal communications skills.
  - Self-defense techniques.
  - Use of force (priorities of force).
  - Weapons qualification (see DA Pam 350-38).
  - First aid.
  - Emergency action plans.
  - Facility regulations.
  - Riot control techniques.

## **SUPPORT PERSONNEL**

7-70. Support personnel in a confinement facility include chaplains, medical personnel, the SJA, and the IG. They perform the same functions as support personnel in a garrison.

## **PRISONER SERVICES BRANCH**

7-71. The chief, PSB—

- Supervises the administrative concerns of the facility.
- Maintains records and forms.
- Computes sentences.
- Manages property and funds.
- Processes prisoners for transfer or release.
- Monitors admissions, services, THPs, EHPs, and the victim/witness program.
- Advises the facility commander of administrative concerns involving prisoners.

7-72. Some administrative procedures at ACS facilities are unique to confinement and corrections operations. Key procedures include inprocessing prisoners, maintaining records and forms, computing sentences, managing property and fund accounts, and transferring and releasing prisoners. In addition to ensuring the day-to-day functioning of facilities, these procedures have a direct impact on prisoner discipline and morale. A prisoner's first contact with the facility staff is during admissions processing, when he is briefed on the facility rules and his legal rights.

## **ADMISSION PROCEDURES**

7-73. Prisoners begin their confinement by inprocessing. Segregate newly confined prisoners from the main prisoner population until they are processed according to the following guidelines:

- Check the DD Form 2707 for accuracy.
- Search and segregate authorized and unauthorized property.
- Strip-search each prisoner.
- Issue appropriate health and comfort supplies to each prisoner, and complete DD Form 504.
- Photograph and fingerprint each prisoner.
- Complete individual prisoner forms.
- Inform prisoners of their visitation rights.
- Arrange for a medical officer to examine each prisoner within 24 hours of confinement, and complete DD Form 503.

## **CORRECTIONAL-REPORTING SYSTEM**

7-74. The Correctional-Reporting System (CRS) is the primary means of information management within the ACS. (See AR 190-47 for more information.)



---

## REQUIRED REGULATIONS AND FORMS

7-75. Each facility must have a complete, current set of regulations covering correctional administration. The facility commander ensures that the facility is part of the publications distribution system. The following regulations and publications must be available:

- AR 15-130.
- AR 190-14.
- AR 190-47.
- AR 210-174.
- AR 633-30.
- Misc Pub 27-7.
- UCMJ.

7-76. Confinement facilities use a variety of forms to maintain records and reports. The following forms must be available:

- DA Form 1124.
- DA Form 1125-R.
- DA Form 1128.
- DA Form 1129-R.
- DA Form 1130-R.
- DA Form 1131-R.
- DA Form 1132-R.
- DA Form 1134-R.
- DA Form 1135-R.
- DA Form 3078.
- DA Form 3955.
- DA Form 3997.
- DD Form 2 (ACT).
- DD Form 499.
- DD Form 503.
- DD Form 504.
- DD Form 506.
- DD Form 509.
- DD Form 515.
- DD Form 2707.
- DD Form 2710.
- DD Form 2718.
- Federal Bureau of Investigation (FBI) Form FD-249.

## CORRECTIONAL-TREATMENT FILE

7-77. Establish a CTF within the first 72 hours of confinement, and maintain it throughout the confinement period. (See AR 190-47 for more information.)

## SENTENCE COMPUTATION

7-78. Compute sentences according to AR 633-30 and DOD Directive 1325.4. The facility commander ensures that selected corrections NCOs working in the PSB are properly trained to compute sentences. Incorrect computations result in incorrect release dates and can violate a prisoner's legal rights. The rate of earnings for good-conduct time is calculated based on the prisoner's length of confinement, including pretrial time (see Table 7-2).

**Table 7-2. Rates for Good-Conduct Time**

Length of Sentence	Good-Conduct Time
Less than 1 year	5 days for each month of the sentence
1 year to less than 3 years	6 days for each month of the sentence
3 years to less than 5 years	7 days for each month of the sentence
5 years to less than 10 years	8 days for each month of the sentence
10 years or more, excluding life	10 days for each month of the sentence
<b>NOTE: If the term of confinement is reduced or if an additional sentence increases the term of confinement, recompute the good-conduct time at the abatement appropriate to the new term of confinement.</b>	

## PERSONAL PROPERTY AND FUNDS

7-79. Prisoners are permitted to place personal property in safekeeping if it is not authorized for retention by the facility commander. Without an exception, the number of items stored cannot exceed the capacity of a 12- by 16-inch envelope. Account for personal property and funds according to AR 210-174, and place the funds in the prisoners' deposit fund. The facility commander appoints (in writing) a commissioned officer, a warrant officer, or a DA civilian as the custodian of the prisoners' property and funds. The appointee must be bonded as outlined in AR 600-13.

7-80. The custodian safeguards prisoners' property and funds in trust. With few exceptions, any action involving property or funds requires the prisoner's authority and consent. The exceptions to this rule are as follows:

- The Internal Revenue Service (IRS) can levy a prisoner's personal deposit fund to satisfy delinquent federal income taxes.
- Property that has evidentiary value is subject to impounding. When the property is taken from a prisoner, disposition is made only by instructions received from a competent authority. (See AR 190-22 for more information.)
- Property of an escapee is disposed of according to DOD 4160.21-M.

## PROCEDURES

7-81. A system of internal controls is used to protect prisoners' property and funds, to ensure the accuracy of records, and to promote efficiency in operations. The custodian and the correctional staff must ensure that prisoners are denied access to property and funds (their own and other prisoners'). Staff members inventory the prisoners' property and list the items

---

on DA Form 1132-R (five copies). (See ARs 190-47 and 210-174 for detailed procedures.)

7-82. Dispose of an escapee's or a deceased prisoner's personal property according to ARs 630-10 and 700-84. The facility commander or the installation commander appoints a disinterested officer to audit the prisoner's personal property. When the audit is complete, the officer signs a DA Form 1132-R in lieu of and for the prisoner.

7-83. A prisoner's sentence determines if and how much he is paid. Prisoners are not allowed to have money in their possession. All money received while in confinement is deposited in the prisoners' deposit fund, which is a trust fund. It contains the personal funds of all the prisoners in the facility. The fund's balance equals the total of the individual accounts on the ledger.

7-84. Take all money from each prisoner during processing. Deposit US currency and US government paychecks in his deposit fund. Prepare a DA Form 1124 (in triplicate) that lists all the money received for deposit, and issue a receipt for personal checks surrendered by the prisoner.

7-85. Deposit all cash receipts in the name of the fund, and make daily deposits when practical. Ensure that checks received by prisoners while in confinement are endorsed immediately for deposit to the fund, and promptly deposit the checks in the bank for collection.

7-86. When a prisoner is transferred from one confinement facility to another, transfer his personal deposit fund to the receiving facility. When a prisoner is released and his personal deposit fund is \$50 or less, pay the entire amount to him in cash. If the balance is more than \$50, issue the balance of his personal deposit fund in the form of a check.

### **PETTY-CASH FUND**

7-87. The USDB commandant and the RCF commander are authorized to set up a petty-cash fund, which provides prisoners with cash to make minor purchases. The commandant or the commander determine each prisoner's contribution to the petty-cash fund, and the amount is drawn from each prisoner's personal deposit fund. The commandant or the commander sets the limit, in writing, on the amount of money in the petty-cash fund.

7-88. Expenditures from the petty-cash fund may not exceed \$50 for anyone authorized expenditures except when the prisoner is released from confinement. When a petty-cash disbursement is made to a prisoner, he submits a DA Form 1128 to the cashier of the petty-cash fund.

### **MAIL AND CORRESPONDENCE**

7-89. The correctional staff keeps a record of each prisoner's mail, correspondence, and authorized correspondents on DD Form 499. They conduct inspections to control trafficking of contraband, money, and valuables. Incoming and outgoing mail is normally inspected but not read. However, it can be read, rejected, or censored if the facility commander has probable cause to believe that it contains plans for criminal activities or escapes, codes or plans for activities in violation of facility rules, requests for prohibited gifts or

money, or obscenity. If a prisoner's mail is being censored or rejected, notify him of the decision and provide the author of the letter a reasonable opportunity to appeal the decision. An official, other than the person who originally disapproved the correspondence, decides appeals, and the appellate official's decision is final. (See AR 190-47 for more information.)

7-90. Different rules apply to inspecting and reading privileged mail. Privileged mail can be opened and inspected to control contraband, money, and valuables and to verify authenticity; but it cannot be read. If a letter qualifies as privileged mail, it is usually delivered to the prisoner unopened. If privileged mail is opened, it must be opened in the presence of the prisoner and a commissioned officer, an NCO (E7 and above), or a civilian (GS7 and above). Privileged mail consists of correspondence between prisoners and—

- The President or his representative.
- The Vice President or his representative.
- A member of Congress or his representative.
- The US Attorney General or his representative.
- The Judge Advocate General or his representative.
- The prisoner's defense counsel or an attorney of record.
- A chaplain or a clergy when recommended by the installation chaplain.

## SUPPORT PERSONNEL

7-91. Support personnel aid the correctional process in numerous areas as follows:

- **Chaplain.** The chaplain promotes the spiritual and moral welfare of prisoners through worship services; special religious activities; counseling; and emphasis on moral, ethical, spiritual, and social values.
- **Medical activity.** The commander of the local medical activity provides medical services for prisoners. Medical services include the services of psychiatrists, psychologists, and social workers. They provide professional evaluations of prisoners and help develop correctional-treatment programs. The medical-activity commander coordinates with the PM and the facility commander to ensure that custody and control measures conform to medical requirements.
- **IG.** The IG may assist the facility commander by investigating complaints, allegations, and charges. These actions frequently provide a basis for corrective action and discourage unfounded allegations by prisoners. The PM and the facility commander establish and maintain close liaison with the IG.
- **SJA.** The SJA serves as the legal advisor to the commander and the staff. The SJA plays a major role in correctional treatment and administrative activities. He provides legal advice and assistance to the PM and the facility commander, legal assistance to prisoners when consistent with professional responsibility requirements, and official information to prisoners about the status of cases and sentences as prescribed by law and regulation. The SJA coordinates with the US

Trial Defense Service, an independent legal organization, to ensure that prisoners have independent legal advice relating to military justice.

- **AG.** The AG processes recommendations for administrative elimination of prisoners without a punitive discharge from the service. He advises the facility commander and unit commanders on processes and procedures.
- **Technical service.** Technical service provides support to education and employment programs. Work programs permit on-the-job training for prisoners in carpentry, mechanics, painting, and masonry. They may also include skilled tasks required to maintain and operate the installation.

## TRANSFER AND DISPOSITION PROCEDURES

7-92. The transfer of a prisoner or a pretrial detainee refers to his relocation from one confinement facility to another to continue a sentence. AR 190-47 provides detailed guidance on the administrative and operational processing required for a prisoner transfer.

7-93. A prisoner or a pretrial detainee is released from confinement only with the proper authorization. At the USDB and the RCF, the installation commander can authorize the facility commander to authenticate DD Form 2718. A prisoner or a pretrial detainee is released for the following reasons:

- A causal prisoner is returned to his unit.
- The charge is dismissed.
- Parole or clemency is granted.
- Pretrial confinement is no longer deemed necessary.
- The sentence expires.
- The sentence is mitigated, suspended, or remitted.

7-94. A confined prisoner—

- Can be kept in confinement and a new confinement order can be issued if he completes a sentence and has additional charges pending.
- Is released from confinement if he is adjudged and completes a sentence before determination is made to punitively discharge him. However, he remains subject to military jurisdiction until the sentence is approved and the discharge is executed.
- Is released from confinement when he completes a sentence that includes a punitive discharge or a dismissal.
- Is released from confinement if his sentence is mitigated or remitted by the convening authority or another competent authority.
- Cannot be released from confinement until a release order is executed if a court-martial renders a decision of not guilty while he is confined.
- Cannot be released from confinement until a release order is executed if the charges are withdrawn.
- Can be retained under military jurisdiction after release for treatment of an illness or an injury that occurred or was aggravated during military service or confinement.

## **LOGISTICS**

7-95. Confinement facilities provide supplies for prisoners during their incarceration and for the correctional staff during their daily tour of duty. The quality of treatment programs and the morale of prisoners and staff are directly affected by the availability of supplies.

7-96. Unit commanders ensure that soldiers in pretrial status have the necessary clothing when they enter confinement. Prisoners confined in outside continental United States (OCONUS) confinement facilities wear a battle dress uniform (BDU), and those confined in CONUS facilities wear a distinctive prisoner uniform as prescribed in CTA 50-900. Prisoners are also issued two blankets, two sheets, one pillow, and one pillowcase.

7-97. The supply branch issues general and janitorial items to prisoners and staff as needed. Items include mops, buckets, brooms, cleansers, and office supplies.

## **FOOD SERVICE SUPPLIES**

7-98. Food service operations are important for maintaining morale and discipline. Provide prisoners wholesome, sufficient food that is prepared from the Army master menu. Supply them with a full complement of eating utensils (fork, knife, and spoon). Prisoners in close confinement and those who have lost privileges can be denied supplemental rations as described in the Army master menu.

## **HEALTH AND COMFORT SUPPLIES**

7-99. The facility commander ensures that basic supplies are available for prisoners to maintain personal hygiene and comfort. Health and comfort supplies are issued to new prisoners during inprocessing and regularly thereafter. Prisoners request additional supplies on DD Form 504, and they receive the supplies gratuitously if they are in a nonpay status. Basic supplies include haircuts, postage stamps, safety razors, bath soap, toothbrushes, toothpaste, and shoe polish.

7-100. A physical inventory is reconciled and balanced monthly (minimum) with the previous inventory, supplies received, and supplies issued to prisoners. The facility commander or a designated representative verifies the inventory in writing.

## **SUPPLY SERVICES**

7-101. Supply functions in a confinement facility are the same as those in other military units. However, stronger security measures are necessary to prevent certain supplies and equipment from falling into the hands of prisoners.

7-102. Weapons, ammunition, and emergency equipment (protective masks and hand and leg irons) must be stored in maximum-security, locked racks or cabinets in a room that is located away from prisoner areas. Guards draw weapons and ammunition as needed, and the staff keeps records of all transactions. To reduce hazards, set up an area for loading and unloading weapons outside the facility.

## **MEDICAL AND DENTAL TREATMENT**

7-103. The facility commander establishes a close liaison with commanders of local medical and dental facilities to ensure their full support of the confinement facility. He ensures that prisoners receive the same medical and dental care as other soldiers.

7-104. Medical officers or other medically trained personnel conduct sick call, perform emergency medical treatment, and dispense medication. Hold sick call daily at a time that does not interfere with duties and training of prisoners. Medical examinations and treatment usually require using instruments and medications that can cause custody and control problems. Secure medications and equipment when they are not in use, and inventory them frequently.

7-105. Corrections NCOs dispense medication to prisoners in cellblocks, supervise the ingestion or application of the medication, and maintain a medication issue register. When possible, use qualified medical personnel to dispense prescription medication.

## Chapter 8

# Battlefield Confinement of United States Military Prisoners

In a mature TO, MP may operate FDFs and FCFs to hold US military prisoners and pretrial detainees in short-term pretrial or posttrial confinement. Posttrial confinement includes temporary custody of prisoners until they are evacuated to permanent facilities and custody of prisoners with short-term sentences as determined by the combatant commander. Leaders tasked with performing US military prisoner operations must be familiar with the doctrine in this chapter and Chapter 7, the policies outlined in AR 190-47, the ACS, and the tasks described in STP 19-95C14-SM-TG.

## PLANNING

8-1. There are two types of battlefield facilities—FDF and FCF. When the combatant commander makes the decision to retain prisoners in the TO, FDFs are set up in the CZ and an FCF is set up in the COMMZ. Prisoners are evacuated from one facility to another according to established guidelines and available facilities (see Figure 8-1, page 8-2).

8-2. The MP plan US military prisoner operations to meet the needs of the combatant commander. The commander may decide to establish facilities throughout the TO if he encounters any of the following:

- The projected or actual amount of prisoners exceeds the unit's handling capability and may interfere with military operations.
- The distance between the TO and the CONUS/OCONUS facility is too great and makes evacuation impractical.
- Transportation assets are unavailable for expeditious evacuation to other facilities.
- The length of military operations and the maturity of the TO enable facilities to be established.
- The facilities are necessary to meet other operational needs.

8-3. The PM is a key player and assumes an important role by keeping the combatant commander informed throughout the planning process. The PM coordinates with the SJA, civil affairs (CA), the HN, the appropriate echelon coordinating staff, and the major subordinate commands before recommending that US military prisoner facilities be established. During the planning process, the PM must determine—

- The date a facility is required.
- The location of an FCF in the COMMZ.
- The resources and logistical support needed to construct and operate a facility.



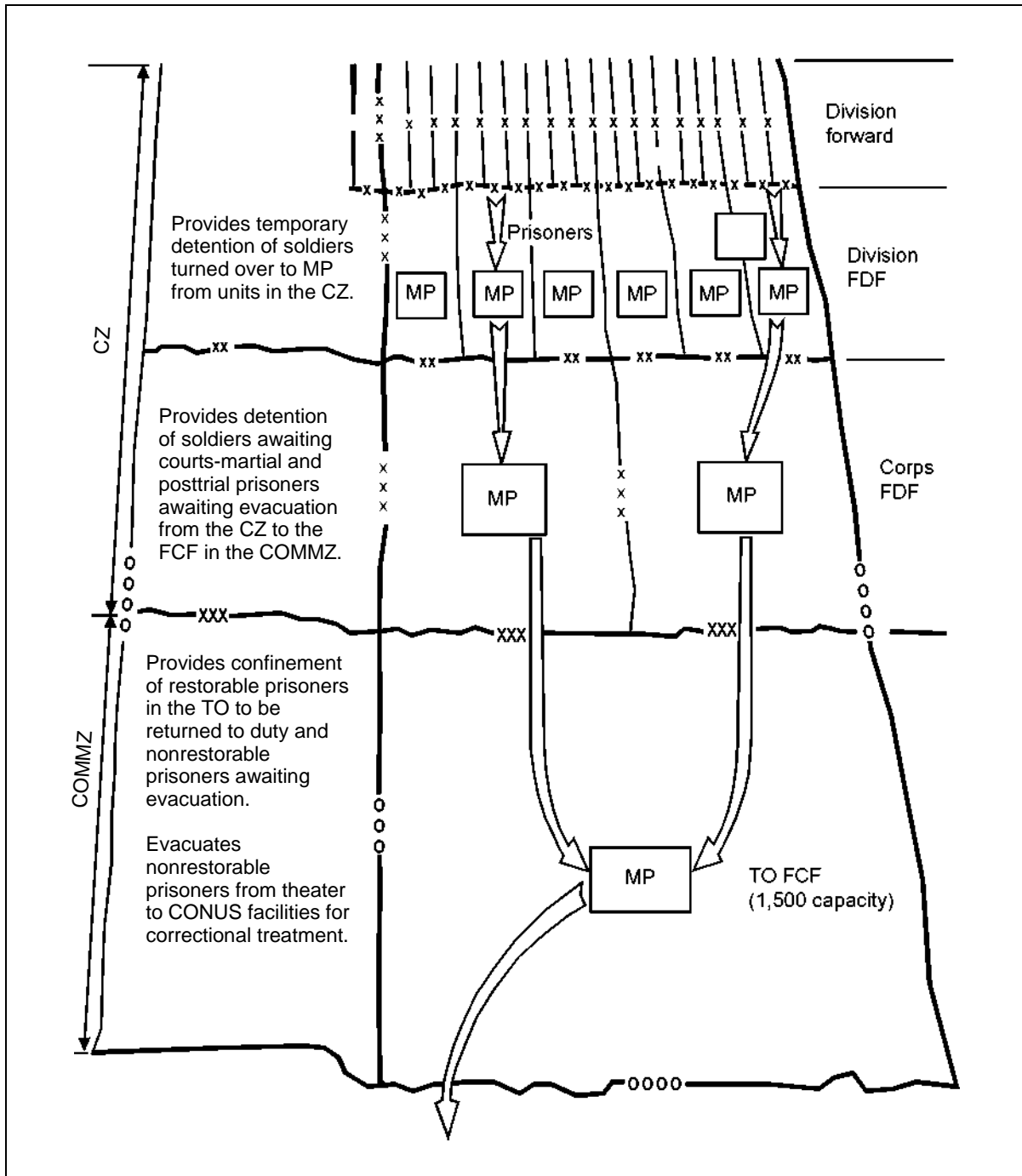


Figure 8-1. TO Confinement Evacuation Flow

- The availability of MP forces (CS MP forces in the TO or an I/R MP unit deployed from CONUS).
- The type of prisoners to be interned (pretrial, posttrial, and multiservice).
- The evacuation requirements and other prisoner-specific considerations.
- The requirements of division and corps FDFs and other requirements that may impact on the operation.

## **FIELD DETENTION FACILITY**

8-4. In the CZ, division and corps PMs are responsible for the location, setup, and operation of FDFs for as long as necessary. The MP use FDFs to detain soldiers until they can be tried, sentenced to confinement, and evacuated from the area. Soldiers awaiting trial remain in their units if possible. When the UCMJ requirements of Rules for Courts-Martial (RCM) 305 are met, soldiers are placed in pretrial confinement and retained by MP. Per RCM 305, no one can be ordered into pretrial confinement except for probable cause. Probable cause to order pretrial confinement exists when there is a reasonable belief that—

- An offense triable by court-martial has been committed.
- The person confined committed it.
- Confinement is required by the circumstances. For example, less severe forms of restraint are inadequate or it is foreseeable that the prisoner will engage in serious criminal misconduct or will not appear at trial, pretrial hearing, or investigation.

8-5. When operating an FDF, MP sign a receipt for each prisoner (DD Form 2708) and his property (DA Form 4137). Use existing structures for FDFs if possible. If tents are used, they should be as large as a GP medium tent. Plans for establishing an FDF should include the following list of equipment and supplies:

- Barbed wire and concertina.
- Fence posts.
- Gates and doors.
- Floodlights and spotlights.
- A generator.
- Food service and cleaning equipment.
- Water cans or lister bags.
- First aid equipment and supplies.
- Clothing and bedding.

## **FIELD CONFINEMENT FACILITY**

8-6. The MP establish an FCF in the COMMZ to detain soldiers placed in short-term custody during pretrial or posttrial or while in transit to another facility. An FCF can be a semipermanent or permanent facility, and it is more complex and elaborate than an FDF. A CS MP unit or an I/R MP unit can be tasked with operating an FCF. The respective unit commander uses the

military decision-making process (MDMP) to determine tasks that are necessary to accomplish the mission. Some considerations are—

- Location.
- Construction.
- Setup.
- Processing.
- Classification.
- Identification.
- Clothing.
- Subsistence.
- Dining facilities.
- Medical facilities.
- Sanitation.
- Discipline.
- Control.
- Administration.
- Emergency planning and investigations.
- ROI.
- Use of force.
- Escape.
- Transportation.
- Transfer and disposition of prisoners.

## **LOCATION**

8-7. The PM coordinates with engineers, the SJA, the HN, and the coordinating staff before selecting an FCF site. He ensures that the FCF is located away from perimeter fences, public thoroughfares, gates, headquarters, troop areas, foliage, and wooded areas. The location depends on several factors, such as—

- The availability of logistical assets (transportation and medical facilities).
- The availability of terrain and preexisting structures.
- The enemy situation.
- The battlefield layout.
- LOC.
- METT-TC.

## **CONSTRUCTION**

8-8. The construction of an FCF depends on the availability of existing structures, the work force, and materiel. Use preexisting facilities to the maximum extent possible. If they are unavailable, coordinate with engineers to construct a facility that meets security and safety requirements. If a CS MP unit is tasked to construct an FCF, request supplies and materiel through the established supply channels. An I/R MP unit requires engineer support to

construct guard towers, fences, and perimeter roads and to repair unimproved roads.

## SETUP

8-9. The FCF setup corresponds with established standards as outlined in AR 190-47. The physical layout includes facilities for administration, housing, and training (if required) as well as recreation and work areas (if available). The facilities and areas are secure against escape. Figure 8-2 shows a sample FCF setup.

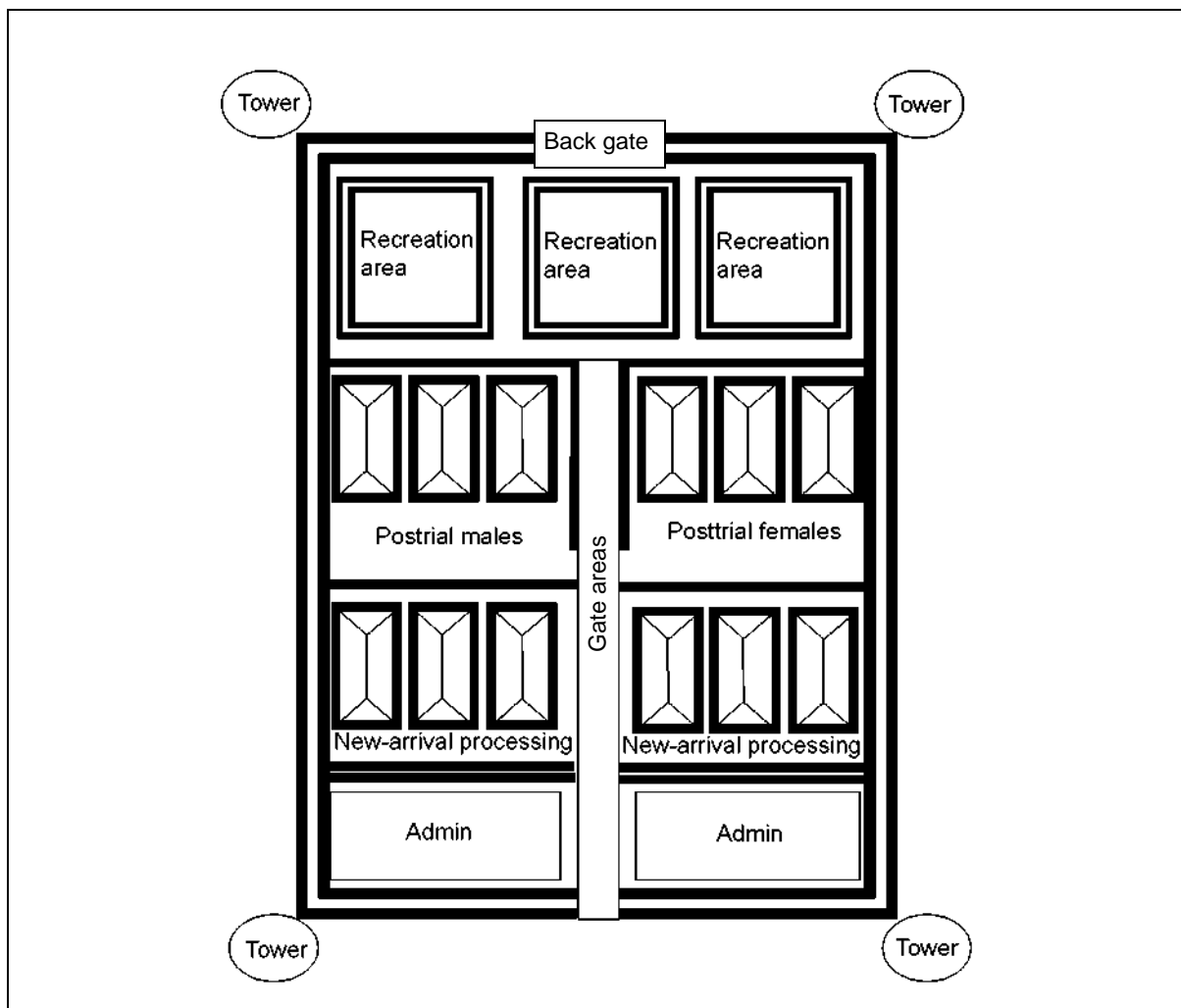


Figure 8-2. Sample FCF Setup

## PROCESSING

8-10. Processing begins when the control of a prisoner is transferred from a non-MP unit to an MP unit or from an MP unit to another MP unit. Each time control is transferred, the receiving organization signs a receipt for each prisoner (DD Form 2708) and his property (DA Form 4137).

8-11. Prisoners begin their confinement by inprocessing into the facility. If a confinement detachment is available, it performs all tasks related to inprocessing prisoners. Otherwise, the MP unit commander performs inprocessing with organic assets. Part of the inprocessing procedure is to help prisoners integrate into the confinement environment. Process each newly confined prisoner according to the guidelines in Table 8-1.

**Table 8-1. Processing a US Military Prisoner**

Station	Purpose	Responsible Individuals*	Actions
1	Search	MP	Escort prisoner and property. Conduct same-gender strip search. Accomplish this before he enters the processing area unless conditions prohibit it. Supervise his movement to the next station.
2	Property inventory	MP	Inventory personal property. List items on DA Form 1132-R. Place items in a container or on a tray. Mark items with his name and SSN. Secure items in a storage area. Confiscate his money, and record it on DA Form 1124. Supervise his movement to the next station.
3	Administrative processing	Processing clerk and MP	Initiate a CTF. Complete individual prisoner forms (see Chapter 7). Supervise his movement to the next station.
4	Photography and fingerprinting	MP	Fingerprint and identify him, and record the information on a fingerprint card. Photograph him with instant film. Use a photographic name board (black background with white characters). List his SSN and name at the bottom center. Attach the photograph to his CTF. Supervise his movement to the next station.
5	Personal hygiene	MP	Allow him to shower, shave, and get a haircut. Supervise his movement to the next station.
6	Medical evaluation	Medical personnel and MP	Examine him within 24 hours of arrival at the confinement facility. Complete DD Form 503. Supervise his movement to the next station.
7	Records review	MP	Review processed records for completeness. Escort him back to processing stations as needed. Prepare and maintain an accountability roster. Supervise his movement to the next station.
*The number of people used to perform tasks depends on the number of prisoners and the time available.			

**Table 8-1. Processing a US Military Prisoner (continued)**

Station	Purpose	Responsible Individuals*	Actions
8	Briefing	MP	Brief him on rules and regulations and visitation and correspondence rights. Supervise his movement to the next station.
9	Movement	MP	Move him to a secure area.

\*The number of people used to perform tasks depends on the number of prisoners and the time available.

8-12. Ensure that all newly assigned prisoners complete training, as soon as possible, that explains the—

- Facility rules and regulations.
- Counseling procedures.
- UCMJ.
- Disciplinary authority and procedures.
- Work assignments.
- Complaint and grievance procedures per AR 20-1.

8-13. Orient pretrial prisoners and officers on their status, rights, and privileges, including the following:

- They are required to participate in correctional orientation and treatment programs that ensure their control, custody, employment, training, health, and welfare as determined by the facility commander.
- Officer and NCO prisoners will not exercise command or supervisory authority over others. They will comply with facility rules and regulations to the same extent as other prisoners. They are not permitted special privileges normally associated with their rank.

## **CLASSIFICATION**

8-14. Prisoners are classified into two categories—pretrial and posttrial. Separate pretrial prisoners (males and females) from posttrial prisoners. Posttrial prisoners include those retained during short-term sentences and in-transit prisoners who are being evacuated to another facility.

## **IDENTIFICATION**

8-15. Take two front and two profile photographs of each prisoner. Use a name board, if available, and place his last name, first name, and middle initial on the first line and his social security number (SSN) on the second line. Add a prisoner registration number on the third line if desired. (See AR 190-47 for fingerprint card requirements.)

## **CLOTHING**

8-16. Prisoners wear a BDU without rank insignia during incarceration. Return personal clothing and other articles to prisoners per AR 700-84 as determined by the facility commander. Issue clothing to prisoners, except officers, according to AR 700-84 and CTA 50-900. Maintain a DA Form 3078 on prisoners with less than 6 months active-duty service and prisoners who

receive clothing on an issue-in-kind basis. Provide organizational clothing within the allowances prescribed in AR 710-2 and CTA 50-900. Launder and dry-clean clothing for prisoners (except officers on pay status) without charge per AR 210-130. Dispose of clothing and personal property according to AR 190-47.

## **SUBSISTENCE**

8-17. Provide prisoners with wholesome, sufficient food that is prepared from the Army master menu, and supply them with a full complement of eating utensils. The facility commander can deny eating utensils for security or other reasons. Prisoners in close confinement and those who lost privileges associated with approved disciplinary action can be denied supplemental rations as described on the Army master menu. The facility commander can authorize alternate meal control procedures to prevent injury when a prisoner abuses food. The procedures require documentation in the facility blotter and concurrence of a medical officer, and they will not exceed 7 days.

## **DINING FACILITIES**

8-18. Dining facilities can be organic to the unit operating the FCF, or they can be set up through the appropriate contracting procedure. The facility commander decides the best feeding method to sustain prisoners based on the available dining facilities and the logistical and HN support.

## **MEDICAL TREATMENT**

8-19. Medical personnel in support of the FCF provide medical, dental, and mental-health care or referral; limited counseling; and social services. Except in matters requiring protection of medical information, the facility commander provides medical observations and recommendations concerning correctional-treatment requirements. Medical officers, nurse clinicians, or PAs—

- Conduct a daily examination of each prisoner in close confinement.
- Perform a medical examination to determine the fitness of a newly confined prisoner or a prisoner who has been outside military control for more than 24 hours. Complete the examination within 24 hours of a prisoner's arrival or return to confinement.
- Test each prisoner for HIV and TB within 3 duty days after initial incarceration. Record test results on DD Form 503.

## **SANITATION**

8-20. An Army Medical Department (AMEDD) representative, a PVNTMED NCO or officer, an environmental-science officer, a sanitary engineer, or a medical entomologist inspects the facility monthly. This inspection ensures that the operation meets PVNTMED standards. The inspector provides a copy of the inspection results to the facility commander. (See AR 190-47 for further guidance.)

8-21. Ensure that all prisoners bathe and follow basic personal-hygiene practices to prevent communicable diseases. Enforce high sanitation standards in facilities where prisoners share latrines and showers.

---

## DISCIPLINE

8-22. Public law and AR 190-47 authorize facility commanders to—

- Restrict the movement and action of prisoners.
- Take action to maintain control as required.
- Protect the safety and welfare of prisoners and other personnel.
- Ensure orderly operation and administration of the FCF.

8-23. A prisoner is considered in an on-duty status except during mandatory sleeping hours, mealtimes, and reasonable periods of voluntary religious observations (as determined by the facility commander in coordination with the facility chaplain). A prisoner who is denied recreation time as part of an administrative disciplinary action may be required to perform recreation time duties as deemed necessary by the appropriate authority. Recreation time duties are not considered extra duty. Privileges are withheld from prisoners on an individual basis, without regard to custody requirements or grade and only as an administrative disciplinary measure authorized by AR 190-47. The attractiveness of living quarters and the type and amount of material items that can be possessed by prisoners may differ by custody grade to provide incentives for custody elevation. Prisoners are denied the privilege of rendering the military salute. Pretrial prisoners will salute when they are in the appropriate service uniform.

8-24. Authorized forms of administrative disciplinary action and punishment are described in AR 190-47 and the UCMJ. Constantly review procedures, rules, regulations, living conditions, and similar factors affecting discipline for violations and disciplinary problems. Physical and mental punishments are strictly prohibited. Authorized administrative disciplinary actions (listed in ascending order) and are as follows:

- A written or oral reprimand or warning.
- Deprivation of one or more privileges. Visits can be deprived or restricted as a disciplinary action only when the offense involves a violation of visitation privileges. Restrictions on mail cannot be imposed as a disciplinary measure.
- Extra duty. Extra duty on work projects cannot exceed 2 hours per day for 14 consecutive days. It cannot conflict with regular meals, sleeping hours, or attendance at regularly scheduled religious services.
- Reduction of custody grade or classification.
- Segregation. Segregation can be imposed for an indefinite period, but it normally should not exceed 60 consecutive days. Tell prisoners why they are being segregated and that they will be released when the segregation has served its intended purpose. Segregated prisoners receive the same diet as other prisoners. Withhold nonessential food items, such as soft drinks and candies, that are in addition to the diet stipulated by the Army master menu.
- Forfeiture of all or part of earned good-conduct time or EGCT according to AR 633-30. The forfeiture need not specify whether it is good-conduct time or EGCT. Both forms of abatement satisfy forfeiture; however, take good-conduct time before taking EGCT.



8-25. The facility commander is authorized to administer punishment, and he can delegate the authority to a subordinate officer (captain [CPT] or above) for minor punishments. The first field grade commander in the chain of command can impose major punishment when delegated authority by the first general officer in the chain of command. The following are prohibited punitive measures:

- Clipping a prisoner's hair excessively close.
- Ordering the lock-step.
- Requiring silence at meals.
- Requiring a prisoner to break rocks.
- Using hand or leg irons, restraining straps or jackets, or shackles as punishment. (The FCF SOP gives authority for the use of these devices and specifies the circumstances warranting their use.)
- Fastening a prisoner to a fixed or stationary object.
- Removing a prisoner's underclothing or clothing or using other debasing practices.
- Flogging, branding, tattooing, or using any other cruel or unusual punishment.
- Requiring domicile in a tent as punishment.
- Ordering strenuous physical activity or body positions designed to place undue stress on a prisoner.
- Using hand or leg irons or belly chains that give the appearance of a chain gang.

8-26. The following are prohibited security measures:

- Using dogs to guard prisoners. Dogs can be used to track escaped prisoners.
- Using chemicals except as riot control agents.
- Using machine guns, rifles, or automatic weapons at guard towers except to protect the facility from enemy or hostile fire by a belligerent power. Selected marksmen who are equipped with rifles can be used when directed as part of a disorder plan and when specifically authorized by a higher echelon commander other than the facility commander.
- Using an electrically charged wire.
- Securing a prisoner to a fixed object except in emergencies or when specifically approved by the facility commander to prevent potential danger to the facility staff or the outside community. Consult medical authorities to assess the health risk to prisoners.

**NOTE: See AR 190-47 for additional guidance and procedures on disciplinary measures.**

## CONTROL

8-27. The facility commander follows control and custody guidelines as outlined in AR 190-47. The inspecting officer's report includes the verification of prisoner strength. He conducts a physical count of prisoners daily that includes a—

- Roll call or a similar accounting method during morning, noon, and evening formations.
- Head count immediately upon the return of prisoners from work detail.
- Bed check between 2300 and 2400 and again between 2400 and 0600.

8-28. The degree of custodial supervision necessary for an individual prisoner is based on a review his records, the Army Inmate Correction System (AICS), and the recommendations of correctional supervisors and professional-services support personnel. Prisoners are not assigned a permanent custody grade based solely on the offenses for which they were incarcerated. Classification is the minimum custody grade necessary based on security requirements and the AICS. Custody grades include trustee and minimum, medium, and maximum security. Facility commanders can subdivide the custody grades as required to facilitate additional security controls.

## ADMINISTRATION

8-29. The FCF is administered by a CS MP unit or an I/R MP unit with an MP I/R confinement detachment if available. The facility commander appoints a guard commander who—

- Supervises facility guards and correctional and custodial personnel within the facility.
- Monitors custody, control, and security measures and informs the facility commander on matters that affect the facility.
- Ensures that rules, regulations, and SOPs are followed and enforced.
- Is responsible for prisoners' activities and the facility blotter.
- Ensures compliance with the schedule of calls.
- Initiates emergency control measures.

**NOTE: CSB personnel assigned to the FCF may also perform these duties.**

8-30. Facility guards are responsible for the custody, control, and discipline of prisoners under their supervision. See Table 8-2, page 8-12, for a complete list of their duties.

**NOTE: Control team guards assigned to the FCF may also perform these duties.**

**Table 8-2. Guard Duties**

Position	Actions
Close-confinement guards	<p>Maintain custody and control of prisoners who are segregated from the general population due to inprocessing or administrative or disciplinary reasons.</p> <p>Accomplish activities within the schedule of calls, as applicable to the close-confinement area.</p> <p>Conduct 30-minute checks (or 15-minute checks for special-status prisoners) when a DD Form 509 is required.</p> <p>Ensure that all required signatures on DD Form 509 are obtained on a daily basis.</p>
Dining-facility guards	<p>Maintain custody and control of prisoners during mealtime.</p> <p>Ensure that the dining-facility traffic plan is followed.</p> <p>Prevent congestion at condiment and juice areas.</p> <p>Account for silverware before and after a meal.</p> <p>Search prisoners before they leave the dining facility.</p>
Employment detail guards	<p>Maintain custody, control, and supervision of prisoners while on details.</p> <p>Ensure that work details are accomplished and safety precautions are observed.</p> <p>Maintain strict accountability of equipment and tools.</p> <p>Assist with frisk and strip searches of prisoners returning from details.</p> <p>Account for prisoners on details according to the schedule of calls.</p> <p>Track prisoners' locations at all times while on details.</p>
Escort and AWOL apprehension guards	<p>Maintain custody and control of prisoners while moving them to and from designated places.</p> <p>May be armed with a pistol if required and authorized by the facility commander.</p> <p>Are qualified with a pistol and trained in the use of force and the ROE.</p> <p>Are trained in firearms safety procedures for transporting prisoners by land, air, and sea.</p> <p><b>NOTE: If available, an escort guard MP company may perform these duties.</b></p>
Main gate and sally port guards	<p>Maintain custody and control of prisoners.</p> <p>Ensure that only authorized persons enter the facility.</p> <p>Inspect vehicles entering and exiting the facility.</p> <p>Inspect packages.</p> <p>Conduct inventories of items entering and exiting the facility.</p> <p>Require noncustodial personnel to register on sign-in logs.</p> <p><b>NOTE: If available, an MP guard company may perform these duties.</b></p>
<p><b>NOTE: The facility commander adjusts the number and type of guards based on the available personnel.</b></p>	

**Table 8-2. Guard Duties (continued)**

<b>Position</b>	<b>Actions</b>
Visitor room guards	Maintain custody and control of prisoners during visits by family members and other authorized persons. Detect violations of rules and regulations, improper behavior, and contraband. Maintain positions in inconspicuous places and observe conversations rather than listening to them. Identify and report infractions, which may be grounds for terminating visits.
Hospital guards	Maintain custody and control of prisoners while escorting them to and from medical appointments and during hospitalization. Ensure that rooms are clear of contraband. Prevent unauthorized communications.
Tower guards	Maintain custody and control by observing specific sectors of the perimeter. Are briefed on the use of force and are qualified with a 12-gauge shotgun or their assigned weapon. Ensure that contraband is not passed through the fence. Provide protection for compound guards.
<b>NOTE: The facility commander adjusts the number and type of guards based on the available personnel.</b>	

**Required Regulations and Forms**

8-31. Each facility must have a complete, current set of regulations covering correctional administration. The facility commander ensures that the facility is part of the publications distribution system. The following regulations and publications must be available:

- AR 15-130.
- AR 190-14.
- AR 190-47.
- AR 210-174.
- AR 633-30.
- Misc Pub 27-7.
- UCMJ.

8-32. Confinement facilities use a variety of forms to maintain records and reports. The following forms must be available:

- DA Form 1124.
- DA Form 1125-R.
- DA Form 1128.
- DA Form 1129-R.
- DA Form 1130-R.
- DA Form 1131-R.
- DA Form 1132-R.
- DA Form 1134-R.
- DA Form 1135-R.

- DA Form 3078.
- DA Form 3955.
- DA Form 3997.
- DD Form 2 (ACT).
- DD Form 499.
- DD Form 503.
- DD Form 504.
- DD Form 506.
- DD Form 509.
- DD Form 515.
- DD Form 2707.
- DD Form 2710.
- DD Form 2718.
- FBI Form FD-249.

**Correctional-Treatment File**

8-33. Establish a CTF within the first 72 hours of confinement, maintain it throughout the confinement period, and transfer it with the prisoner when he is evacuated to another facility. (See AR 190-47 for more information.)

**Sentence Computation**

8-34. Based on the type of operation and its projected duration, the theater commander may determine that certain sentences will be served in the TO. The FCF commander computes sentences according to AR 633-30 and DOD Directive 1325.4. He ensures that NCOs working in the personnel section are properly trained to compute sentences. Incorrect computations result in incorrect release dates and can violate a prisoner’s legal rights. The rate of earnings for good-conduct time is calculated based on the prisoner’s length of confinement, including pretrial time (see Table 8-3).

**Table 8-3. Rates for Good-Conduct Time**

Length of Sentence	Good-Conduct Time
Less than 1 year	5 days for each month of the sentence
1 year to less than 3 years	6 days for each month of the sentence
3 years to less than 5 years	7 days for each month of the sentence
5 years to less than 10 years	8 days for each month of the sentence
10 years or more, excluding life	10 days for each month of the sentence
<b>NOTE: If the term of confinement is reduced or if an additional sentence increases the term of confinement, recompute the good-conduct time at the abatement appropriate to the new term of confinement.</b>	

**Mail and Correspondence**

8-35. The FCF staff keeps a record of inspection of each prisoner’s mail, correspondence, and authorized correspondents on DD Form 499. The

---

guidance outlined in Chapter 7 and AR 190-47 also applies to the battlefield confinement of US military prisoners.

### **Prisoner Personal Property and Funds**

8-36. Prisoners in the FCF are permitted to place personal property in safekeeping if it is not authorized for retention by the facility commander. The guidance outlined in Chapter 7 and AR 190-47 also applies to the battlefield confinement of US military prisoners.

### **Support Personnel**

8-37. Support personnel organic to a CS MP unit or an I/R MP unit provide support to the FCF. Support personnel include medical officers, chaplains, and social-service workers. They may help administer the facility and are oriented and trained in custody and control procedures. Establish a formal training program that includes—

- Supervisory and interpersonal communications skills.
- Self-defense techniques.
- The use of force.
- Weapons qualification (see DA Pam 350-38).
- First aid.
- Emergency action plans.
- Facility regulations.
- Riot control techniques.

### **Supply Services**

8-38. Supply functions in an FCF are the same as in other military operations. However, stronger security measures and accountability procedures are necessary to prevent certain supplies and equipment from falling into the hands of prisoners. Weapons, ammunition, and emergency equipment, such as hand and leg irons, must be stored in maximum-security, locked racks or cabinets in a room that is located away from prisoner areas.

8-39. The unit logistics officer ensures that a sufficient amount of general and janitorial items are available to keep the facility sanitary and free of potential diseases. Issue the items under strict control procedures and on an as-needed basis to prisoners and staff. Items include mops, buckets, brooms, cleansers, and office supplies.

8-40. Issue health and comfort items to new prisoners during inprocessing and regularly thereafter. Prisoners request additional supplies on DD Form 504, and they receive the supplies gratuitously if they are in a nonpay status. Basic supplies include safety razors, bath soap, toothbrushes, toothpaste, and shoe polish.

8-41. Conduct a physical inventory monthly to reconcile and balance the records of the previous inventory, supplies received, and supplies issued to prisoners. The facility commander or his designated representative verifies the inventory in writing.

## EMERGENCY PLANNING AND INVESTIGATIONS

8-42. The facility commander publishes formal plans for the apprehension of escaped prisoners, fire prevention, facility evacuation, prisoner riots and disorders, NBC evacuation, mass casualty, quarantine, special confinements, and prisoner processing. The plans must form part of the unit's SOP and be tailored to the operational environment where the FCF is located. Test the plans at least every six months, and record tests of emergency action plans in the facility blotter. The EEI are as follows:

- Alarm, notification, and escape validation procedures.
- The manning of critical points outside the facility; for example, crowd control procedures, likely escape routes, observation points, and defensive positions.
- Procedures to secure the prisoner population while executing an emergency action plan.
- Prisoner and cadre recall procedures and a means for organizing forces; for example, search parties and riot control teams.
- Procedures to terminate the plan and follow-up actions.
- The mass casualty plan, including how to secure prisoners.

8-43. The facility commander organizes a reactionary force that is trained in the use of force, riot control procedures, and other emergency actions. The size of the reactionary force depends on the personnel assets available and the nature of the emergency.

8-44. Where appropriate or legally required, use AR 15-6 to investigate reported incidents of misconduct, breaches of discipline, or violations of the UCMJ. Before interviewing prisoners suspected or accused of violations, advise them of their rights under Article 31, UCMJ, against self-incrimination. Any statement made may be used as evidence against them in a criminal trial or disciplinary-and-adjustment board proceeding. They have the right to consult with counsel and to have counsel present during questioning. A request to consult with counsel at this point does not automatically result in the case being referred to a three-member board. If requested, make arrangements for the prisoner to meet with an attorney as soon as practical. Interview relevant witnesses, including those identified by the prisoner, as deemed appropriate; and obtain written, sworn statements when possible. Complete the investigation expeditiously, and submit a disciplinary report to the facility commander.

8-45. Upon receipt of the disciplinary-and-adjustment board report, the facility commander reduces the report to a memorandum for record. He refers the case for counseling or reprimand, refers it to the disciplinary-and-adjustment board, or takes other appropriate action. (See AR 190-47 for more information.)

## RULES OF INTERACTION

8-46. The facility commander establishes and enforces the ROI that allow humane treatment and care of prisoners, despite the reason they are incarcerated. The ROI are established by the facility commander, and some include—

- Remaining professional and serving as positive role models for prisoners.
- Being firm, fair, and decisive in actions concerning prisoners.
- Refraining from being too familiar or too belligerent with prisoners.
- Avoiding becoming emotionally or personally involved with prisoners.
- Not gambling, fraternizing, or engaging in any commercial activities with prisoners.
- Not showing favoritism to any prisoners.

## **USE OF FORCE**

8-47. Guidance on the use of force is incorporated in orders, plans, SOPs, and instructions at FDFs and FCFs. Using firearms or other means of deadly force is justified only under conditions of extreme necessity and as a last resort. Do not use physical force against a prisoner except in self-defense, to prevent escape, to prevent injury to others, to prevent damage to property, to quell a disturbance, to move an unruly prisoner, or as otherwise authorized in AR 190-47.

8-48. In the event of an imminent group or mass breakout from the FCF or another general disorder, ensure that prisoners know authority prevails, order will be restored, and means are available to restore order by force if necessary. Before applying force, try to reason with prisoners if the situation permits. If reasoning fails or if the existing situation does not permit reasoning, issue prisoners a direct order to terminate the disorder. Do not give the order until it can be enforced effectively by applying force as the situation requires. Before escalating beyond a show of force, allow uninvolved prisoners to voluntarily assemble in a controlled area away from the disturbance.

8-49. When force is necessary, apply it according to the priorities of force and limit it to the minimum degree necessary. The use of deadly force is prescribed by AR 190-14. The application of the priorities of force, or the application of a higher numbered priority without first employing a lower numbered one, depends on and is consistent with the situation encountered during any particular disorder. The priorities of force for an FCF are as follows:

- First: Verbal persuasion.
- Second: Show of force.
- Third: Chemical aerosol irritant projectors (subject to local and HN restrictions).
- Fourth: Use of physical force other than weapons fire.
- Fifth: Presentation of deadly force capability.
- Sixth: Deadly force.

8-50. The facility commander coordinates with the higher echelon commander and the SJA. He designates representatives who are authorized to direct the use of firearms and riot control agents in the event of a riot or other disturbance. Orders, plans, SOPs, and instructions include use-of-force rules and specify the types of weapons to be used.



## ESCAPE

8-51. Provide each guard with a whistle or other suitable alarm. Per AR 190-14, using firearms to prevent an escape is justified only when there is no other reasonable means available. If a prisoner tries to escape from the facility, the guard—

- Alerts other guards of the attempted escape by blowing three short blasts on a whistle or delivering the signal with another alarm.
- Orders the prisoner to halt three times in a loud voice.
- Fires only when the prisoner has passed all barriers of the facility and is continuing to escape. (The location of a barrier is determined by the physical arrangement of the facility. It normally includes fences or walls enclosing athletic, drill, recreation, housing, and administrative areas.)

8-52. Do not fire on an escapee if it endangers others. When firing is necessary, aim shots to disable the prisoner rather than kill him. Guidance for the use of firearms by guards escorting prisoners outside the facility are the same as those for using firearms in the facility. (See AR 190-47 for more information.)

8-53. The facility commander ensures that guards are trained in the use of their assigned weapons. Orient all personnel on policies regarding the use of force and the provisions of AR 190-14. Issue 12-gauge shotguns with cylinder (unchoked) barrels to facility guards, and ensure that barrels do not exceed 20 inches in length. Authorized ammunition for armed guards (perimeter and escort) is number 9 shot in trap loads of 2 3/4 grams of powder and 1 1/8 ounces of shot. Tower guards use number 00 buckshot ammunition.

8-54. Instruct tower and escort guards not to fire at less than 20 meters to prevent prisoner escapes. Ensure that these instructions appear in training programs and special instructions for guards.

8-55. Guards use a 9-millimeter pistol when escorting prisoners. Do not use rifles, machine guns, or submachine guns when guarding prisoners. Do not take weapons inside the controlled areas of an FCF except as directed by the facility commander.

## TRANSPORTATION

8-56. The facility commander maintains safety and security for prisoners under his control. He is also responsible for transportation requirements when prisoners are in his custody. Ensure that guard and escort personnel are familiar with the use-of-force guidelines above and the movement tasks outlined in STP 19-95C14-SM-TG. Some of the tasks are as follows:

- **Motor vehicle transport.** Escort guards—
  - Know the type of vehicle, the departure time, the number of prisoners and their status, the number of assigned escorts, and the type of weapon and restraint (if applicable), and the release procedures at the final destination.
  - Know the actions to take in case of a disorder or an escape attempt.

- Conduct a thorough vehicle search and remove or secure all items that can be used as weapons.
- Do not handcuff two escape risk prisoners together or handcuff prisoners to any part of the vehicle.
- Sign DD Form 2708 for each prisoner escorted out of the facility and frisk him before he enters the vehicle.
- Follow the loading procedures for the vehicle.
- **Aircraft transport.** Escort guards—
  - Know the type of aircraft, the departure time, the number of prisoners and their status, the number of assigned escorts, and the type of weapon and restraint (if applicable), and the release procedures at the final destination.
  - Follow the procedures outlined in AR 190-47 for transporting prisoners via a commercial aircraft.
  - Sign for each prisoner on DD Form 2708.
  - Do not secure prisoners to any part of the aircraft.
  - Know latrine, beverage, meal, loading, and unloading procedures as outlined in AR 190-47.
- **Rail transport.** Use two escort guards (one armed and one unarmed) when transporting prisoners by rail. If possible, transport prisoners in enclosed accommodations or compartments (day and night). If they are unavailable, use coach class or standard sleeping cars. Escort guards seat themselves in such a way that they block avenues of escape. The unarmed guard accompanies prisoners who use latrine facilities and remains in visual contact with them.

## TRANSFER AND DISPOSITION OF PRISONERS

8-57. The FCF commander is prepared to transfer US military prisoners from his facility to other confinement facilities outside the TO or back to their units. He releases prisoners from confinement with proper authorization. He coordinates with the SJA and the next higher commander to determine release authority and for authentication of DD Form 2718. (See Chapter 7 and AR 190-47 for detailed guidance on transferring prisoners.)

## PART FOUR

# Military Police Support to Civil-Military Operations

The CMO establish, maintain, influence, or exploit relations between the civilian populace and military forces or government and nongovernment civilian organizations and authorities. Operations are conducted in friendly, neutral, and hostile AOs to facilitate military operations and to consolidate and achieve US objectives. Military forces may perform activities and functions that a local, regional, or national government normally performs. Activities may occur before, during, or after military operations or, if directed, in the absence of military operations. The CMO may be performed by designated CA forces and/or other military forces.

The CA forces help plan, coordinate, and supervise CA activities to support CMO. The activities are mission-dependent and are determined after careful evaluation of mission requirements and the force mix and time available. Under the umbrella of CMO, CA forces perform FN support, civil-administration support, PRC, HA, and ES.

If required, I/R units are deployed and employed to support CMO in CONUS and OCONUS. The I/R units provide an array of significant capabilities by performing their wartime mission in peace and during conflicts. The MP must understand the intent of CMO because SA and the correct mind-set are critical. Since forces may be called upon to relieve human suffering, such as that encountered after a natural disaster, strict discipline measures and control may not be appropriate.

In Parts Two and Three, this manual addressed MP units' capabilities during internment and confinement operations. Part Four expands on these capabilities and addresses resettlement operations in support CMO.

---

## Chapter 9

# Populace and Resource Control

Civilian and military authorities exercise PRC to provide security for the populace, deny personnel and materiel to an enemy, mobilize population and materiel resources, and detect and reduce the effectiveness of enemy agents. Populace control includes curfews, movement restrictions, travel permits, registration cards, and resettlement operations. Resource control includes licenses, regulations, guidelines, checkpoints, ration controls, amnesty programs, and facility inspections. This chapter addresses MP support to DC operations conducted under the umbrella of PRC operations.

## **DISLOCATED-CIVILIAN OPERATIONS**

9-1. The DC operations are a special category of PRC, and they are the most basic collective tasks performed by CA personnel. The DC operations minimize civilian interference with military operations and protect civilians from combat operations. They are normally performed with minimal military resources. Nonmilitary international-aid organizations, NGOs, and IHOs are the primary resources used by CA forces. However, CA forces may depend on other military units, such as I/R MP units, to assist with a particular category of civilians.

9-2. Controlling civilians is essential during military operations because uncontrolled masses of people can seriously impair the military mission. Commanders plan measures to protect civilians in the AO and to prevent their interference with the mission.

### **CATEGORIES**

9-3. During military operations, US forces must consider two distinct categories of civilians—those who remained in place and those who are dislocated. The first category includes civilians who are indigenous to the area and the local populace, including civilians from other countries. They may or may not need help; and if they can take care of themselves, they should remain in place.

9-4. The second category includes civilians who leave their homes for various reasons. They are categorized as DCs, and their movement and physical presence can hinder military operations. They probably require some degree of aid (medicine, food, clothing, water, and shelter) and may not be native to the area or the country. The term *DC* is generic, and it is further subdivided into categories (see Chapter 1).

### **LEGAL OBLIGATIONS**

9-5. All commanders are under the legal obligation imposed by international law, including the Geneva Conventions and other applicable international humanitarian laws. In particular, commanders must comply with the principles and spirit of the law of land warfare during armed conflicts (and other operations unless directed otherwise by competent authorities), regardless of how they are characterized. (See FM 27-10 and the SJA for additional information.)

### **OBJECTIVES AND PRINCIPLES**

9-6. The primary objective of DC operations is to minimize civilian interference with military operations. They also—

- Protect DCs from combat operations.
- Prevent and control the outbreak of disease.
- Relieve human suffering.
- Centralize masses of DCs.

9-7. Although the Assistant Chief of Staff, G5 (Civil Affairs) (G5) or the Civil Affairs Officer (US Army) (S5) is the primary planner of DC operations, all

military planners consider DC operations. The G5 or the S5, in conjunction with supporting CA units, assesses the needs of DCs to ensure that they receive adequate and proper help. He considers the cultural background of DCs and the cultural background of the country where DCs are located. The planning of DC operations differs at each level of command. All commands and national and international agencies involved in DC operations have clearly defined responsibilities within a single overall program. The following principles apply to DC operations:

- Coordinate with the DOS, the UNOCHA, and FN civil and military authorities to determine the appropriate levels and types of aid required and available.
- Minimize outside contributions to meet basic needs as DCs become self-sufficient, and encourage DCs to become as independent as possible.
- Review the effectiveness of humanitarian responses, and adjust relief activities as necessary.
- Coordinate with CA units to use US, HN, international, and third-nation organizations such as the United Nations Children's Fund (UNICEF) and the Cooperative for American Relief Everywhere, Incorporated (CARE). Their use not only capitalizes on experience but also reduces requirements placed on US military forces.
- Restrict the rights of DCs as required. Under international law, DCs have the right to freedom of movement; but in the event of a mass influx, security considerations may require restrictions.

## **PLANNING DISLOCATED-CIVILIAN OPERATIONS**

9-8. The planning scope for DC operations and the actual task implementation differ, depending on the command level and the TO. Before describing how MP units support DC operations, MP leaders must have a basic understanding of how CA forces plan DC operations. Except as specifically noted, planning considerations discussed in this manual are applicable to all tactical scenarios, including logistics operations for units in the COMMZ.

## **POLICES AND PROCEDURES**

9-9. Based on national policy directives and other political efforts, the theater commander provides directives on the care, control, and disposition of DCs. The corps commander integrates the theater commander's guidance with the corps ground tactical plan. The driving force for DC planning must be generated at corps level. At division, COSCOM, and other subordinate command levels, the DC plan must—

- Allow the accomplishment of tasks assigned by higher command echelons.
- Be within the restrictions imposed by higher headquarters.
- Guide subordinate commands in handling and routing DCs.
- Ensure that all concerned parties—including the fire support coordination center and the Assistant Chief of Staff, G3 (Operations and Plans) (G3), or the Operations and Training Officer (US Army)

(S3)—receive information on DC plans, routes, and areas of concentration.

- Help DCs by alleviating their suffering while awaiting status determination.
- Provide security and safety for DCs and soldiers by maintaining proper order and discipline within the facility.
- Provide an aggressive information program by using support agencies and DC leadership.

9-10. The DC plans support the OPLAN. As a minimum, DC plans must address the—

- Authorized extent of migration and evacuation.
- Minimum standards of care.
- Status and disposition of DCs.
- Designation of routes and movement control measures.
- Cultural and dietary considerations.
- Designation and delegation of responsibilities.

## HANDLING CONSIDERATIONS

9-11. The care and control of DCs fulfill a dual purpose—to ensure that DCs receive the minimum essentials to subsist (food, water, clothing, shelter, and emergency medical aid) and to maximize the mobility of tactical forces and minimize civilian interference with military operations. The CA and MP forces coordinate and establish movement control early. Major considerations include a stay-put policy, collection points, and assembly areas (see Figure 9-1):

- **Stay-put policy.** Civilians remain near their homes and under controlled movement. The policy assumes the capability for enforcement, information dissemination, and ES. The HN may have a policy that US forces support, but US forces do not have the authority or the right to enforce the policy. It is not within the authoritative capability of US forces.
- **Collection points.** A collection point establishes control and direction over the movement of the civilian populace, and it is the primary measure for gaining initial control over DCs. It is a temporary area for small numbers of DCs until they can return to their homes or move to a safer area. It is as far forward as possible during the flow of battle. Because a collection point is temporary, screening by CA forces, MI, or MP is quick and may include screening for intelligence information and emergency assistance. Screening takes place to segregate EPWs, CIs, and allied soldiers from DCs. Local civilians or civilian agencies can operate collection points under the supervision of tactical or support troops or CA personnel. The MP become involved in DC operations when civilian congestion along MSRs threatens the mobility of the maneuver force. They may be the first US elements to address DC problems and initiate actions to restore force mobility.
- **Assembly areas.** Assembly areas are temporary holding areas for civilians before they return to their homes or move to a more secure area. Detailed screening or segregation of DC categories takes place at

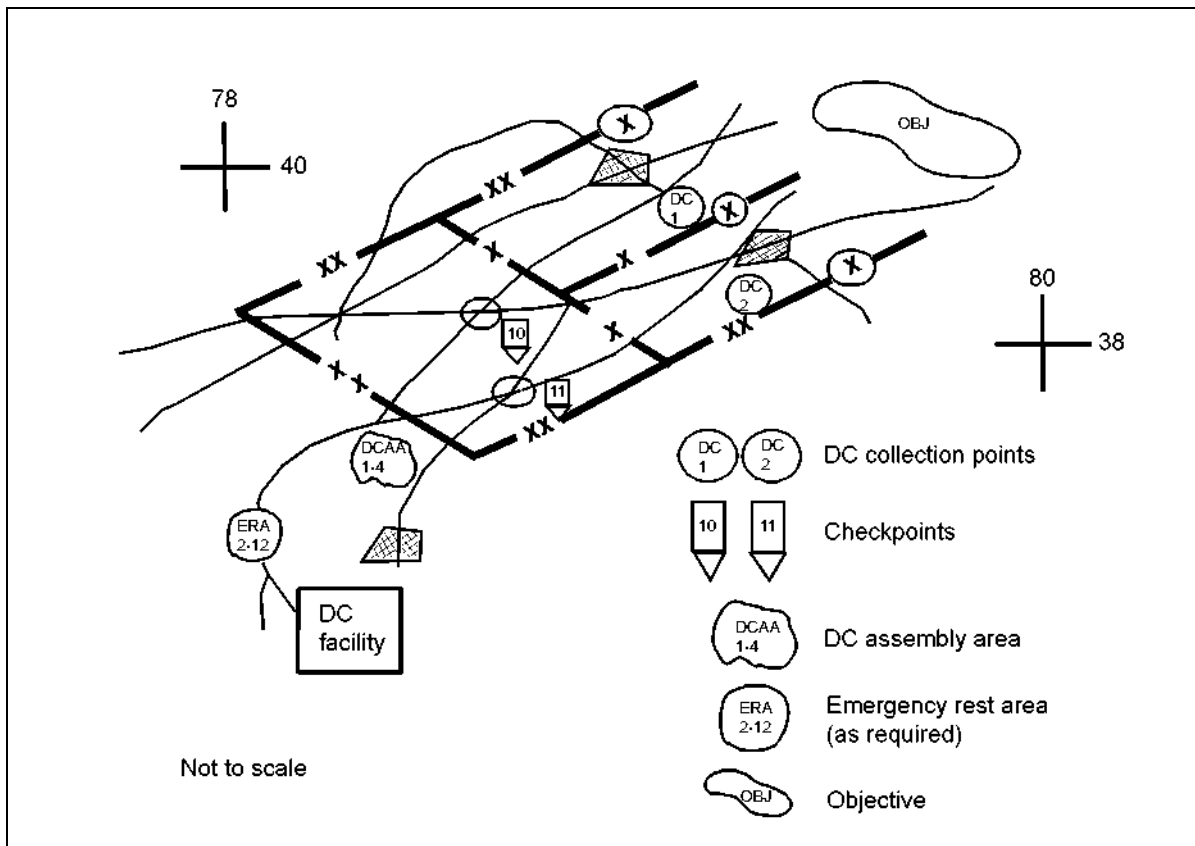


Figure 9-1. Sample DC Overlay

assembly areas. They are usually located in a secure, stable environment and may include schools, churches, hotels, and warehouses. When selecting a specific area, consider the ability to provide overnight accommodations for several days. Local civilians can operate assembly areas under the supervision of tactical or support troops or CA personnel.

**EVACUATION**

9-12. Evacuation creates serious problems and is only considered as a last resort. Per US doctrine, a division or higher commander can order an evacuation. When the decision is made to evacuate a community, CA and MP make detailed plans to prevent uncontrolled groups from disrupting the movement of military units and supplies. Consider the following when planning a mass evacuation:

- **Transportation.** The CA plans for the maximum use of civilian transportation.
- **Security.** The CA helps the Assistant Chief of Staff, G2 (Intelligence) (G2) with security screening and documentation of evacuees. Since the civilians are being removed from the area where they can best take care of themselves, the military provides security for them after

evacuation. They also provide security for property left behind, including farm animals and pets.

- **Documentation.** Evacuees may need ID documents showing their name and the locality from which they were evacuated. As a control technique, CA personnel prepare a manifest that lists evacuees for movement.
- **Briefing.** The MCO briefs evacuees before movement. He uses leaflets, loudspeakers, posters, and other means available. The briefing explains details of the move, such as restrictions on personal belongings and the organization and schedule for the movement.
- **Rations.** For a movement lasting no more than 2 days, supply personnel issue rations to each evacuee at the time of departure or at designated points en route.
- **Health care.** The public health team makes maximum use of civilian medical personnel, equipment, and supplies to provide health care to evacuees. Use military medical personnel, equipment, and supplies as supplements if necessary. Take proper steps to prevent the spread of infectious diseases before movement.
- **Return.** Evacuation plans provide for evacuees' return and the criteria for determining the duration of their absence.

## MOVEMENT

9-13. Directing and controlling movement are vital when handling masses of DCs. The G5 and HN authorities are responsible for mass DC operations, and the MP may help direct DCs to alternate routes. If possible, incorporate HN assets in planning and implementation. Consider the following:

- **Route selection.** When selecting routes for civilian movement, CA personnel consider the types of transportation common to the area. They coordinate the proposed traffic circulation plan with the transportation officer and the PM. All DC movements take place on designated civilian evacuation routes.
- **Route ID.** After designating movement routes, CA personnel mark them in languages and symbols that civilians, US forces, and allied forces understand. The PSYOP units, MP, HN military forces, and other allied military units can help mark routes.
- **Control and assembly points.** After selecting and marking movement routes, CA and HN authorities establish control and assembly points at selected key intersections. The G5 or S5 coordinates locations with the PM, the movement control center, and the Assistant Chief of Staff, G4 (Logistics) (G4) to include control and assembly points in the traffic circulation plan.
- **Emergency rest areas.** The CA personnel set up emergency rest areas at congested points to provide immediate needs (water, food, fuel, maintenance, and medical services). Notify the PM to ensure that these areas are included in MP area security operations.
- **Local and national agencies.** Using local and national agencies conserves military resources and reduces the need for interpreters and translators. Civilian authorities normally have legal status and are best equipped to handle their own people.



## FACILITIES

9-14. When large groups of civilians are quartered temporarily (less than 6 months) or semipermanently (more than 6 months), the commander may task CA units to establish a DC facility. If existing facilities (HN, NGO, IHO, or IO) are suitable for DC facilities and HN personnel are available to administer and operate the facility, MP units may not be required to establish I/R facilities. Under this scenario, CA units provide the HN with technical advice, support, and assistance, depending on the requirements. They may also furnish additional detachments and functional teams or specialists to resolve public health, welfare, and safety problems at the facility.

9-15. If the commander deploys MP units to the TO or tasks them to support DC operations, MP help set up, administer, and operate facilities in close coordination with CA forces, the HN, PSYOP units, NGOs, IHO, IOs, and other interested agencies. The MP unit commander becomes the I/R facility commander.

## MILITARY POLICE SUPPORT TO DISLOCATED-CIVILIAN OPERATIONS

9-16. The support of DC operations begins before an MP unit arrives in the TO or is tasked with the mission. The I/R facility commander has a thorough understanding of international law, the concept of DC operations, and how they apply to the mission. If time permits, he contacts the in-country G5/S5, CA units, and other organizations that may have a role in DC operations (see Chapter 1). The CA forces provide MP leaders and soldiers with expertise on factors that directly affect DC operations. Some of the factors include—

- The availability of HN agencies and the status of infrastructure.
- Ethnic differences and resentments.
- Social structures (family and regional).
- Religious and symbolic systems (beliefs and behaviors).
- Political structures (distribution of power).
- Economic systems (sources and distribution of wealth).
- Links among social, religious, political, and economic dynamics.
- The cultural history of the area.
- Attitudes toward US military forces.
- Logistical requirements.

9-17. When deployed to the TO, MP leaders coordinate with higher headquarters G5/S5, CA, PSYOP, HN, NGOs, IHO, and IOs before setting up and operating the I/R facility. After a clear understanding of the mission, the concept of operations, and other available information, the I/R facility commander uses the MDMP to determine specific tasks the MP unit performs to accomplish the mission. Some considerations include—

- Location.
- Construction.
- Setup.
- Processing.
- Screening.

- Classification.
- ID.
- Clothing and equipment.
- Subsistence.
- Dining facilities.
- Medical and sanitation.
- Self-government.
- Discipline.
- Control.
- Administration.
- L&O.
- ROI.
- ROE.
- Transportation.
- Disposition.

## **LOCATION**

9-18. The I/R facility commander coordinates with CA, the G5/S5, and other military and nonmilitary organizations when selecting a site for DC operations. The location depends on the availability of supply routes, food, water, power, and waste disposal. Avoid sites near vital communications centers, large military installations, or other potential military targets. Also consider the susceptibility of the area to natural and man-made disasters (floods, pollution, and fire) and the use of facility personnel as a source of local labor support.

## **CONSTRUCTION**

9-19. The DCs, local agencies, or government employees construct facilities when possible. The supporting command's logistics and transportation assets acquire and transport materials to build or modify existing facilities. Local sources may provide materials within legal limitations. The supporting command also furnishes medical, subsistence, and other supporting assets to establish DC facilities. Engineer support and military construction materials may be necessary when I/R facilities are set up in areas where local facilities are unavailable; for example, hotels, schools, halls, theaters, vacant warehouses, and unused factories.

9-20. The TCMS contains basic plans, specifications, and material requirements for building EPW/CI facilities based on population. The plans can be easily modified for DC operations in temperate, frigid, tropic, and desert climates.

9-21. If necessary, CS MP units and I/R MP units set up the facility using acquisitioned tentage and additional materials. The I/R facility commander considers the type of construction necessary to satisfy the needs of the DC operation. Some considerations are the—

- Local climate.
- Anticipated permanency of the facility.

- Number of facilities to be constructed.
- Availability of local materials.
- Extent of available military resources and assistance.

## SETUP

9-22. Subdivide the facility into sections or separate compounds to ease administration and DC tension. Each section can serve as an administrative subunit for transacting facility business. Major sections normally include facility headquarters, hospital, dining facility, and sleeping areas. Subdivide sleeping areas for families, unaccompanied children, unattached females, and unattached males. Consider cultural and religious practices, and try to keep families together. Figure 9-2, page 9-10, shows a sample DC I/R facility. Additional facilities, fencing, and other requirements are based on the—

- Number of civilians.
- Diversity of the population.
- Resources available.
- Need for a reactionary force.
- Need to establish an animal compound.
- Need to establish a vehicle-parking area.

## PROCESSING

9-23. The initial reception of DCs begins with their transport from the assembly area to the inprocessing center of the I/R facility. Conduct processing in a positive manner because DCs are fearful. Ensure that DCs clearly understand why they are being processed and know what to expect at each station. The facility commander, a HN representative, or another official conducts an entrance briefing to DCs upon their arrival.

9-24. While the EPW/CI processing procedures discussed in previous chapters provide a foundation, I/R personnel must be aware of unique aspects when processing DCs. Military personnel provide training and support, while NGOs, IHOs, and IOs actually process DCs. The number and type of processing stations vary from operation to operation. Table 9-1, page 9-11, shows stations that may be required during DC operations.

9-25. The I/R facility commander determines the accountability procedures and requirements necessary for DC operations. Translators are present throughout processing. A senior person greets new arrivals and makes them feel welcome. Brief DCs on facility policies and procedures and screen them to identify security and medical concerns. Offer them the use of personal-hygiene facilities, and always maintain family integrity.

9-26. Conduct pat-down searches to ensure that weapons are not introduced into the compound. Conduct same-gender searches when possible, and do not conduct strip searches. Speed and security considerations may require mixed-gender searches. If so, perform them in a respectful manner, using all possible measures to prevent any action that could be interpreted as sexual molestation or assault. The on-site supervisor carefully controls soldiers doing mixed-gender searches to prevent allegations of sexual misconduct. Using HN, NGO, or IHO assets to conduct searches may prevent an intense situation from developing.

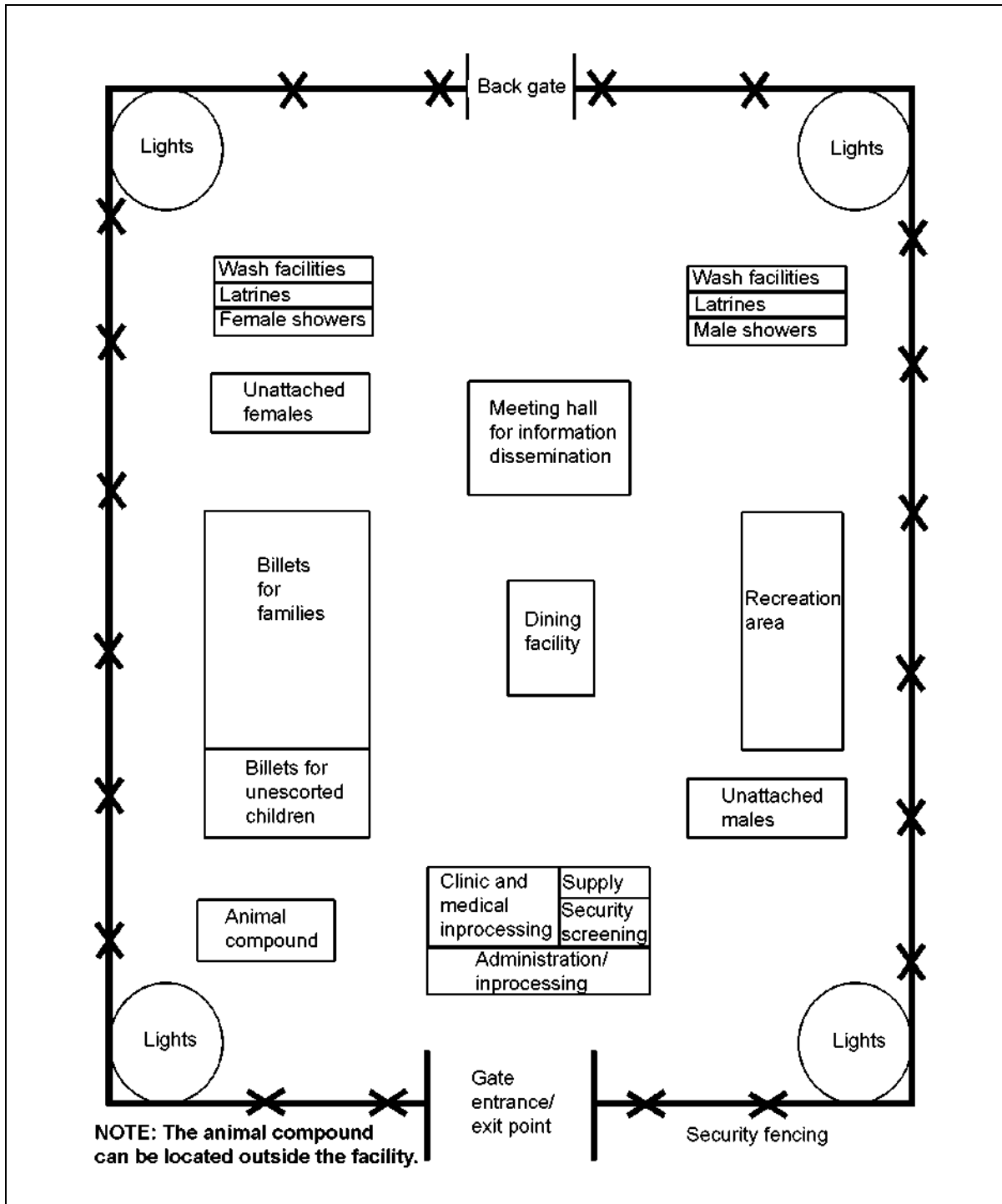


Figure 9-2. Sample DC I/R Facility

**Table 9-1. Actions During Inprocessing**

Station	Purpose	Responsible Individuals*	Actions
1	Search and screening	I/R staff, MI, NGOs, IHOs, and IOs	Conduct a pat-down search to ensure that weapons are not introduced into the facility.  Ensure that the facility is not infiltrated by insurgents.
2	Accountability	I/R staff	Prepare forms and records to maintain accountability of DCs. Use forms and records provided by HN, CA, or those used for EPW/CI operations that may apply to DCs.
3	ID card or band	I/R staff	Issue an ID card or band to each DC if required to ease facility administration and control.
4	Medical evaluation	Medical personnel	Evaluate DCs for signs of illness or injury, and treat them as necessary.
5	Assignment	I/R staff	Assign a sleeping area to each DC.
6	Personal items	I/R staff	Issue personal-comfort items and clothing if available.

\*The number of people performing these tasks depends on the number of DCs and the time available. When possible, allow HN authorities to conduct most of the inprocessing.

## SCREENING

9-27. Screening may be necessary to prevent infiltration by insurgents, enemy agents, or escaped members of hostile armed forces. Although intelligence and other units may screen DCs, friendly and reliable local civilians can perform this function under the supervision of MP and CA personnel. Screeners carefully apply administrative controls to prevent infiltration and preclude alienation of people who are sympathetic to US objectives. The screening process also identifies technicians and professionals to help administer the facility; for example, policemen, schoolteachers, doctors, dentists, nurses, lawyers, mechanics, carpenters, and cooks.

## CLASSIFICATION

9-28. The MP classify DCs during processing. They coordinate with CA, NGOs, IHOs, and IOs to determine proper classifications. Expect a continuing need for reclassification and reassignment of DCs. Statements made by a DC and the information on his ID papers determine his initial classification. Agitators, enemy plants, and individuals who should be classified as EPWs or CIs will be identified by their activities. Reclassify them according to their identity or ideology.

## IDENTIFICATION

9-29. Identifying DCs may or may not be necessary; it depends on guidance from higher headquarters, CA, the HN, and other agencies. The need for ID varies from operation to operation, and it is used to—

- Verify rosters against the actual population.

- Provide timely reunification of family members.
- Match DCs with their medical records in case of a medical emergency or evacuation.
- Check identities of DCs against the transfer roster.

9-30. An ID card can be used to facilitate ID. It contains the DC's name, photograph, and control number. The control number may be an ISN or a sequenced control number specific to the DC. Color-coded IDs permit ID by categories (see Chapter 1). An ID band permits rapid, reliable ID of an individual and may also be used in DC operations. While DCs cannot be prevented from removing or destroying ID bands, most will accept their use for ID purposes. When ID bands or cards deteriorate, replace them immediately.

### **CLOTHING AND EQUIPMENT**

9-31. Supply DCs with adequate, suitable clothing and sleeping equipment if they do not have supplies with them. Requisition clothing and equipment through NGOs, IHOs, IOs, and HN sources when possible. In a combat environment, use available captured clothing and equipment. Ensure that DCs wear clothing until it is unserviceable, and replace it as necessary.

### **SUBSISTENCE**

9-32. Ensure that food rations are sufficient in quantity, quality, and variety to maintain health and prevent weight loss and nutritional deficiencies. Consider the habitual diet of the DC population, and be aware that DCs may bring their own rations and cooking utensils. Allow DCs to prepare their own meals after coordination with CA; the HN; and NGOs, IHOs, IOs who support the facility.

9-33. Ensure that expectant and nursing mothers and children under the age of 15 receive additional food in proportion to their needs. Increase the rations of workers based on the type of labor performed. Provide plenty of fresh water. A good planning factor is 20 gallons per individual per day.

9-34. Make minimal menu and feeding-schedule changes to prevent unrest among the DC population. Inform the DC leadership when changes must be made.

### **DINING FACILITIES**

9-35. Dining-facility requirements vary depending on the number of DCs and the availability of equipment. If deemed necessary, the I/R facility commander can authorize local procurement of cooking equipment. Consult with SJA to determine the purchasing mechanism and the legality of items being purchased. Coordinate with NGOs, IHOs, and IOs for food service support. Train selected DCs to perform food service operations, and ensure that they are constantly supervised by US food service personnel.

### **MEDICAL AND SANITATION CONSIDERATIONS**

9-36. Due to the temporary nature of an I/R facility, the need for medical care and sanitation intensifies. If possible, locate a sick call tent adjacent to each

major compound inside the facility to ensure prompt medical screening and treatment. Enforcement and education measures ensure that the facility population complies with basic sanitation measures. Provide medical care via organic I/R medical personnel or coordinate with the appropriate HN medical authorities. To prevent communicable diseases, follow the guidance in FM 21-10 and other applicable publications. Conduct routine, preplanned health, comfort, and welfare inspections that appear to be random. Inspections ensure that the facility is safe, sanitary, and hazard-free. When conducting inspections—

- Ensure that their purpose is conveyed and emphasized to DC leaders.
- Respect cultural beliefs such as religious tenets and shrines. The INS, international support groups, community leaders, CA, and DC leaders are good sources for information regarding cultural sensitivities.
- Treat DCs and their possessions with respect.

## **SELF-GOVERNMENT**

9-37. One of the best ways to ensure DC cooperation in a facility is to establish a form of self-government. It minimizes the impression that DCs are under the control of a foreign government and allows them to feel a degree of control over their lives. Chapter 5 and AR 190-8 contain procedures for establishing a CI committee. Use the procedures as a model for establishing a DC self-government, and coordinate with CA for assistance.

9-38. Self-government leaders can help solve problems before they become major events. The infrastructure of self-government promotes a stable environment where rapport is built between the facility commander, the DC leadership, and the DC population. This, in turn, reduces tension and provides an effective means of communicating reliable information to the facility population.

9-39. The DCs can submit complaints and requests to the I/R facility commander via—

- An elected DC internment committee.
- A written complaint.
- A visiting representative of the UNHRC or a similar agency.

## **DISCIPLINE**

9-40. Facility commanders establish and strictly enforce measures to maintain discipline and security. Establish rules that can be easily followed by everyone, and coordinate the rules with SJA and HN authorities. Determine how to enforce rules and how to deal with DCs who violate noncriminal rules. Establish daily or periodic routines and responses that are conducive to good discipline and control. Ensure that facility personnel—

- Enforce policies and procedures to control DCs.
- Give reasonable orders decisively and in a language that DCs understand.
- Post copies of the UN mandate relating to the situation in every compound where DCs can easily read them.

- Post facility rules, regulations, instructions, notices, orders, and announcements that DCs are expected to obey in an easily accessed area. Ensure that the information is printed in a language that DCs understand, and provide a copy to DCs who do not have access to posted copies.
  - Ensure that DCs obey orders, rules, and directives.
  - Report DCs who refuse or fail to obey an order or a regulation to DC leaders and HN authorities.
  - Do not fraternize with DCs.
  - Do not donate or receive gifts or engage in any commercial activity with DCs.
- 9-41. Discipline and control also apply to I/R facility personnel. They—
- Observe rigorous self-discipline.
  - Maintain a professional, impersonal attitude.
  - Follow ROI and ROE guidelines.
  - Cope with hostile or unruly behavior and incidents calmly.
  - Take fair, immediate, decisive action.

## **CONTROL**

9-42. Controlling personnel is the key to successful facility operations. The I/R facility commander ensures efficient, effective control that meets US obligations under international law. Facility control includes measures to reduce waste and avoid duplication of effort. The commander—

- Establishes and maintains discipline quickly and fairly.
- Publishes and enforces rules of conduct and updates them as necessary.
- Serves as the single POC, coordinating all matters within the facility and with outside organizations and agencies.
- Establishes and posts barracks rules such as those shown in Figure 9-3.

9-43. Use HN civilians as cadre for facility administration, and encourage DCs to become involved in facility administration. Past experience shows that about 6 percent of DCs should be employed on a full-time basis. If possible, I/R facility and CA personnel organize and train cadre before the facility opens. The HN civilians come from public and private welfare organizations and are under military supervision.

9-44. Problems might stem from DCs' state of mind. The difficulties they experienced may affect their acceptance of authority. They may have little initiative or may be uncooperative because of an uncertain future. They may be angry because of their losses, or they may resort to looting and general lawlessness because of their destitution. The I/R facility commander can minimize difficulties through careful administration and—

- Maintaining different national and cultural groups in separate facilities or sections.
- Keeping families together.



<b>Barracks Rules</b>	
1.	Do not move from assigned barracks without permission.
2.	Maintain the sanitary and physical condition of barracks.
3.	Empty and wash trash cans daily.
4.	Do not bring food or cooking utensils in barracks.
5.	Do not take food, except baby food and fruit, from the dining facility.
6.	Do not have weapons in barracks or surrounding facilities.
7.	Do not have pets in the dining facility.
8.	Turn off indoor lights in barracks by 2300.
9.	Do not play radios, record players, or tape recorders in barracks after 2300.
10.	Do not allow children to play on fire escapes.
11.	Watch children carefully, and do not allow them to wander out of residential areas.
12.	Do not throw diapers or sanitary napkins in toilets. Place these items in trash cans.
13.	Do not allow children to chase or play with wild animals because they bite and carry diseases.
14.	Obtain barracks supplies from the barracks chief.
15.	Do not smoke, use electrical appliances for heating or cooking, or have open fires in barracks.

**Figure 9-3. Sample Barracks Rules**

- Separating unaccompanied males, females, and children under the age of 18 (based on HN laws as to when a child becomes an adult).
- Furnishing DCs with information about their status and future.
- Allowing DCs to speak freely to facility officials.
- Involving DCs in facility administration, work, and recreation.
- Establishing quick contact with agencies for aid and family reunification.

## **ADMINISTRATION**

9-45. Disseminating instructions and information to the facility population is vital. Communications may be in the form of notices on bulletin boards, posters, public address systems, loudspeakers, facility meetings and assemblies, or a facility radio station. The CA teams and area PSYOP units can help disseminate information.

9-46. Another tool for effective administration is using liaison personnel. Liaison involves coordination with all interested agencies. The US government and military authorities, allied liaison officers, and representatives of local governments and international agencies can provide assistance. Implement the following standards related to DC treatment:

- Do not penalize or expose them to unfavorable treatment because their presence in the country is considered unlawful.

- Do not restrict their movement except when necessary for public health and order.
- Allow them to enjoy their fundamental rights.
- Treat them as persons whose plight requires special understanding and sympathy. Provide necessary assistance; and do not subject them to cruel, inhumane, or degrading treatment.
- Do not discriminate because of race, religion, political opinion, nationality, or country of origin.
- Recognize that they are persons before the law who enjoy free access to the courts of law and other competent administrative authorities.
- Base the I/R facility's location on the safety needs and well-being of DCs and the security needs of the receiving state.
- Provide them with necessities (food, shelter, and basic sanitary and health facilities).
- Maintain family units when possible.
- Provide assistance for tracing relatives.
- Protect minors and unaccompanied children.
- Allow them to send and receive mail.

## **LAW AND ORDER**

9-47. The I/R facility commander is also the safety and security officer. He deals with crimes against persons and property, performs security patrols, and conducts reaction team operations. If an L&O team is attached to the organization, it performs L&O-related functions. Otherwise, the commander uses organic resources, such as an MP guard company, to establish an MP desk and blotter and perform other specific functions. The location of the MP station depends on the facility's layout and the commander's needs.

9-48. Some other sources for security officers include local police forces, HN paramilitary and military forces, and the facility population. Police personnel within the population can supplement security teams or constitute a facility police force if necessary. Internal and external patrols are necessary; however, ensure that security does not give the impression that the facility is a prison. Base patrol areas and distribution plans on the size of the facility and the number of DCs in each subdivision. If a DC is apprehended for committing a crime, coordinate with SJA and HN authorities to determine the disposition and the status of the subject and the disposition of the case paperwork, evidence (including crime lab analysis results), and recovered property. Also obtain information on items, procedures, and agreements unique to the supported HN.

9-49. Be prepared to perform civil-disturbance operations to restore L&O. Identify a reactionary force that can be immediately deployed and employed inside the facility to control a disturbance. The size of the reactionary force depends on the facility population and the available military forces. The reactionary force is well trained, well organized, and knowledgeable of applicable ROE, the use-of-force policy, and the use of NLWs and civil-disturbance measures. (See Appendix B and FM 19-15 for more information.)

9-50. Basic guidelines and the foundation for I/R facility L&O are provided in FMs 19-10 and 19-20. The I/R facility commander tailors the forms and procedures to his specific mission.

## RULES OF INTERACTION

9-51. The ROI provide soldiers with a guide for interacting with the DC population. The following points may be included in the ROI:

- Avoid discussing politics or immigration policies with DCs.
- Avoid making promises to DCs. If cornered, reply with, "I will see what I can do."
- Refrain from making obscene gestures at DCs because they may understand the meaning.
- Avoid making derogatory remarks or political comments about DCs. Local linguists understand English, and DCs might understand it.
- Treat DCs equally. They may become offended if they do not receive the same treatment or resources others receive.
- Respect religious articles and materials.
- Treat medical problems seriously.
- Treat DCs with respect.
- Greet DCs in their own language.
- Clear phrases that DCs teach to soldiers through a linguist to ensure that they do not contain obscene language.

## RULES OF ENGAGEMENT

9-52. The DC ROE vary from operation to operation. The CINC establishes ROE in conjunction with SJA and upon joint staff approval. The CINC approves special ROE developed for use in DC facilities that are controlled and secured by MP. The ROE may evolve to fit the changing environment, ensuring continued protection and safety for the DC population and US personnel. Ensure that ROE remain simple and understandable so that soldiers are not confused and do not have to memorize extensive checklists. Key definitions are—

- **Deadly force.** Force that is likely to cause death or serious bodily harm. An attack with an edged weapon and the use of a firearm are examples of deadly force.
- **Hostile act.** An attack or the use of deadly force against a person.
- **Hostile intent.** A threat of deadly force against a person. This term is used to anticipate a hostile act or to react to a threat before it occurs by applying graduated levels of nondeadly force.

9-53. Design ROE around escalating use of force. Resolve a conflict with the minimum force necessary, but allow leaders and soldiers to escalate the level of force as necessary to retain control. For example—

- First: Give a verbal warning.
- Second: Present a show of force, such as pepper spray, a stun gun, or a shotgun.
- Third: Use pepper spray or a stun gun.

- Fourth: Use a riot baton.
- Fifth: Fire a shotgun using nonlethal rounds or bird shot.

9-54. Nonlethal measures can be authorized by the ROE anytime during an operation to protect soldiers and DCs from injury. The NLWs include riot batons, pepper spray, stun guns, and shotguns loaded with nonlethal munitions or bird shot. The ROE may include nondeadly force to protect mission-essential equipment from damage or destruction. Mission-essential equipment includes tactical and nontactical vehicles, communications equipment, weapons, computers, and office and personal equipment.

9-55. The ROE normally authorize the use of deadly force only in extreme situations, such as—

- When there is an immediate or imminent threat of death or serious bodily harm to US personnel, civilians, or DCs.
- When its use would not significantly increase the risk of death or serious bodily harm to innocent persons.
- When lesser, nondeadly force fails or is impractical.
- When it is a last resort.

## **TRANSPORTATION**

9-56. The DC facility requires adequate transportation assets. Since MP units have limited organic transportation assets, the unit MCO or the CA transportation specialist coordinates and determines the types and numbers of vehicles required and makes provisions to have them on hand. The I/R facility commander uses civilian or captured enemy vehicles when possible.

## **DISPOSITION**

9-57. The final step in DC operations is the disposition of DCs. Allowing DCs to return to their homes as quickly as tactical considerations permit lessens the burden on military and civilian economies. It also reduces the danger of diseases that are common among people in confined areas. When DCs return home, they can help restore their towns and can better contribute to their own support. If DCs cannot return home, they may resettle elsewhere in their country or in a country that accepts them. Guidance on the disposition of DCs comes from higher authority upon coordination with US forces, national authorities, and international agencies.

9-58. The most important step in the disposition of DCs is the final handling of personnel and property. Before the DC operation is terminated, the I/R facility commander consults with higher headquarters, the SJA, and other pertinent agencies to determine the proper disposition of records.

## Chapter 10

# Humanitarian Assistance and Emergency Services

The HA operations encompass short-range programs aimed at ending or alleviating human suffering. They are usually conducted in response to natural or man-made disasters. The HA operations are designed to supplement or complement the efforts of HN civil authorities or agencies that have primary responsibility to provide relief. This type of assistance must not duplicate other forms of assistance provided by the US government. Government agencies are primarily responsible for ES operations (police, fire, rescue, and disaster preparedness). The effectiveness of ES plans and organization has a direct impact on CMO, and support to ES agencies can be provided as civil-military assistance. Although HA and ES operations can be conducted OCONUS, they are primarily conducted in CONUS.

### SECTION I - HUMANITARIAN ASSISTANCE

10-1. Military forces provide a secure environment for humanitarian-relief efforts. The HA mission covers a broad range of tasks, and specific requirements are situation-dependent. The HA operations have different meanings to different people, based on their perspective. The operation can encompass reactive programs (disaster relief) and proactive programs (humanitarian and civic assistance [H/CA]).

10-2. The HA operations present a different set of challenges to US military forces. While civilian and military authorities exercise PRC, they may not know the magnitude of the situation requiring HA. In addition, US forces may be tasked to perform HA operations in numerous and complex environments. As with MP support to PRC operations, the MP commander has a clear understanding of the operational environment, the ROE, and legal considerations before setting up an I/R facility to support HA operations.

### OPERATIONAL ENVIRONMENT

10-3. The US force commander coordinates with other responding organizations and assesses the environment where US forces will conduct HA operations. The operational environment includes the political situation, physical boundaries, the potential threat to forces, global visibility, and the media interest climate.

10-4. After the US force commander confirms the operational environment, he determines the types and numbers of forces required to meet the mission.

The operational environment also determines the ROE to be used within the AO. The more permissive the environment, the more predictable the outcome of the mission. The HA operational environments are categorized as permissive, uncertain, and hostile. The distinction between HA conducted in a permissive environment versus a hostile environment is clear. Failure to make this distinction results in inadequate planning and unrealistic expectations.

### **PERMISSIVE ENVIRONMENT**

10-5. A permissive environment is normally associated with relief operations following a natural disaster or an economic collapse. Assistance is provided at the request of the host government. A permissive environment is conducive to HA operations, and little or no opposition or resistance to military forces is expected. Nonhostile, anti-US interests may try to disrupt US military activities. The physical-security environment may be permissive; however, other nonthreatening means (demonstrations) may be employed to impair credibility or to reduce the effectiveness of US military activities. A permissive environment is characterized by—

- A commonality of purpose for all parties.
- A quantifiable problem (often a single, natural disaster).
- Clear objectives (providing support until normalcy returns).
- HN cooperation.

### **UNCERTAIN ENVIRONMENT**

10-6. In an uncertain environment, FN forces do not have effective control of the territory and population in the intended AO. They may or may not be receptive to HA operations.

### **HOSTILE ENVIRONMENT**

10-7. A hostile environment includes conditions, circumstances, and influences ranging from a civil disorder or a terrorist act to full-scale combat. Forces conducting HA must be prepared for a full range of contingencies. Commanders can employ forces to safeguard the populace, defend the perimeter, provide escort convoys, screen the local populace, and assist in personnel recovery operations. A hostile environment is characterized by—

- Multiple conflicting parties.
- Imminent danger to all parties.
- Relief as a weapon manipulated by combatants for political gain.

10-8. The more hostile the environment, the less predictable the outcome of the mission. The HA forces must be prepared to counter actions by hostile forces attempting to disrupt the HA mission and to counter actions by a previously friendly populace. Commanders do not depend on their humanitarian mission to shield them from hostile acts. The joint forces commander (JFC) coordinates with higher authorities and determines the appropriateness of the use of force. The effects of the environment on HA activities are shown in Figure 10-1. As the environment becomes more hostile, the requirement for security increases and the capability for HA (such as food distribution and medical assistance) decreases. (See FM 100-23-1 for more information on HA operations.)

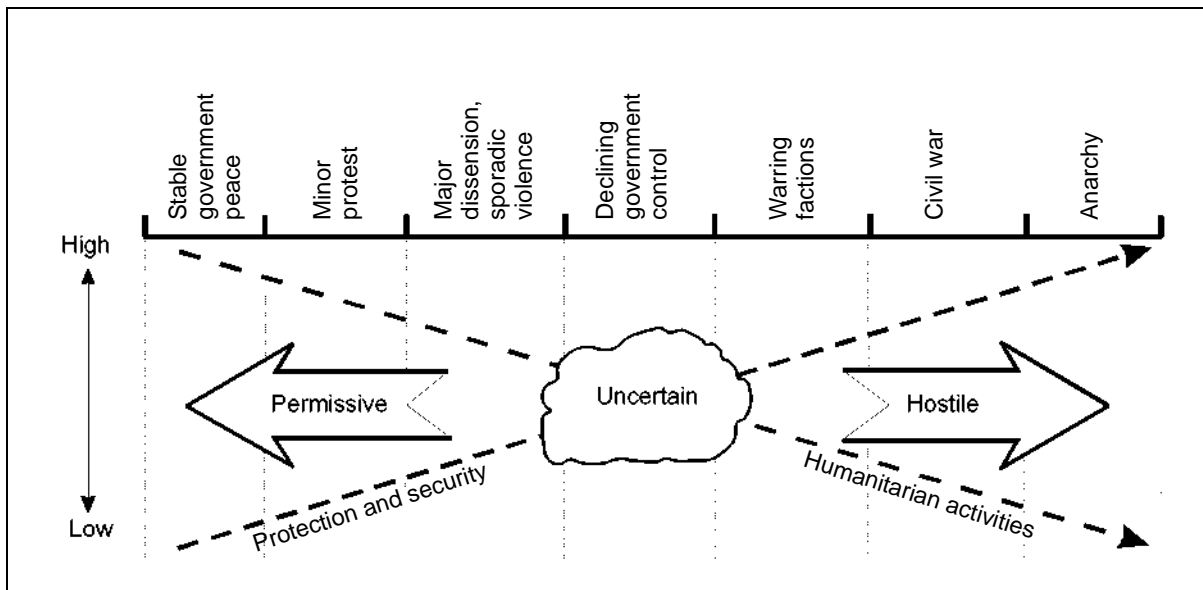


Figure 10-1. HA Environment

## RULES OF ENGAGEMENT

10-9. The sensitive political and international nature of HA operations means that the CINC must coordinate the ROE details (which may change as the operation evolves) with the JFC. Under normal circumstances, the joint chief of staff's (JCS's) standing ROE apply to all military operations. The CINC requests supplemental measures to deal with the specifics of the mission. Actual ROE established for each HA mission depend on the individual situation and the operational environment.

10-10. The ROE development for forces participating in HA operations is essential to mission success and is characterized by restraint. The levels of force, tactics, and weaponry are evaluated and addressed. For multinational operations, all participating military forces establish common HA ROE to provide consistency within the force. Individual nations using separate ROE respond differently to the same situation. The following precepts are essential to the ROE for US military forces:

- The right of self-defense is never prohibited. The two elements of self-defense are necessity and proportionality.
- A unit commander defends against a hostile act or intent. A hostile act must occur or a hostile intent must be apparent. The use of force must be reasonable in intensity, duration, and magnitude to ensure the safety of forces.

## LEGAL CONSIDERATIONS

10-11. Regardless of the circumstances under which US forces are employed, international law obligates the commander with respect to civilians, governments, and economics. Agreements or the law of land warfare usually specify the requirements. The Hague and Geneva Conventions and similar

documents set forth treaty obligations, and FM 27-10 and other service publications explain the commander's legal obligations.

10-12. The JFC must be aware of existing international agreements that may limit the flexibility of the HA mission. Existing agreements may not be shaped to support HA operations. Military HA commanders dealing with HNs and IOs should anticipate the difficulties that international agreements can impose on HA operations.

10-13. Normally, the law of land warfare does not apply to HA operations. However, it is used in conjunction with the Geneva and Hague Conventions, protocols, and custom laws that may provide guidance to the JFC. Commanders, unless otherwise directed by competent authorities, comply with the principles and spirit of the law of land warfare during HA operations. Mission imperatives and tasks must have a sound legal basis, and commanders ensure that personnel conform to internationally accepted standards of behavior and actions—especially as they relate to the humane treatment of civilians, the respect for private property, and the use of force.

## **MILITARY POLICE SUPPORT**

10-14. There are some key differences between MP support to DC operations and MP support to HA. Since HA operations are usually conducted in response to a disaster, the level of property devastation and human suffering may require special attention and planning considerations. One of the special considerations may be the need for temporary shelter. If the JFC determines that the availability of HN shelters or other services is inadequate, he may request the assistance and deployment of CS or I/R units to accomplish the HA mission. When the decision is made to employ an MP unit, the MP commander becomes the I/R facility commander.

10-15. The MP support to HA operations begins before the unit arrives in the TO or is tasked with the mission. The I/R facility commander has a thorough understanding of the legal considerations and the concept of operations, including how they apply to the MP mission. If time permits, the I/R facility commander contacts the JFC G5/S5, SJA, CA, and other organizations that may have a role in HA operations. The CA forces can provide expertise on factors that affect HA operations, such as—

- The availability of HN agencies and the status of infrastructure.
- Ethnic differences and resentments.
- Social structures (family and regional).
- Religious and symbolic systems (beliefs and behaviors).
- Political structures (distribution of power).
- Economic systems (sources and distribution of wealth).
- Links among social, religious, political, and economic dynamics.
- The cultural history of the area.
- Attitudes toward US military forces.

10-16. When deployed to the TO, an I/R facility commander coordinates with and receives updated information from higher headquarters G5/S5, CA, and PSYOP; the HN; and applicable NGOs, IHOs, and IOs before setting up and



---

operating an I/R facility. He uses the MDMP to determine the specific tasks the MP unit performs to accomplish the HA mission. Some considerations include—

- Location.
- Construction.
- Setup.
- Processing.
- Screening.
- ID.
- Clothing and equipment.
- Subsistence.
- Dining facilities.
- Medical and sanitation.
- Self-government.
- Control and discipline.
- Administration.
- L&O.
- ROI.
- Transportation.
- Disposition.

## **LOCATION**

10-17. The location of the I/R facility is extremely important, especially when responding to a disaster. Consider METT-TC, the susceptibility of the area to natural or man-made disasters (flood, pollution, and fire), and the use of HN personnel as a source of local labor support. The location also depends on the availability of supply routes, food, water, power, and waste disposal. The I/R facility commander selects the location of the facility after coordinating with JFC, CA, G5/S5, the HN, and other military and nonmilitary organizations.

## **CONSTRUCTION**

10-18. Try to construct the facility using local agencies or government employees. The goal is to have the facility fully constructed and operational before accepting any civilians. This is important because the civilian population may have suffered total family or property loss and may not be in the best psychological or physical condition to help with construction efforts. Within legal limitations, use local sources and materials if they are available. Otherwise, use the supporting command's logistics and transportation assets to acquire and transport the resources required to build or modify existing facilities for HA operations. The supporting command and the HN also furnish medical, subsistence, and other supporting assets to establish I/R facilities. Engineer support and military construction materials may be necessary when I/R facilities are set up in areas where local facilities are unavailable or destroyed; for example, hotels, schools, halls, theaters, vacant warehouses, unused factories, or workers' camps. The TCMS can be used for HA operations. If necessary, MP units set up a facility using acquisitioned tentage and additional materials. The I/R facility commander considers the type of

construction necessary to satisfy the needs of the HA operation. Some considerations are—

- The local climate.
- The anticipated permanency of the facility.
- The number of facilities to be constructed.
- Local materials available.
- Military resources and assistance available.

## **SETUP**

10-19. Subdivide the facility into sections or separate compounds to ease administration and alleviate stress among civilians. Each section can serve as an administrative subunit for transacting facility business. Major sections normally include facility headquarters, a hospital, a dining facility, and sleeping areas. Subdivide sleeping areas for families, unaccompanied children, unattached females, and unattached males. Consider cultural and religious practices, and try to keep families together. Figure 10-2 shows a sample HA I/R facility. Additional facilities, fencing, and other requirements are based on—

- The number of civilians.
- The diversity of the population.
- Resources available.
- The need for a reactionary force.
- Guidance from higher headquarters, CA, and the HN.
- The need for temporary storage.
- The duration of the operation.
- The number of animals to be housed.
- The number of vehicles.

## **PROCESSING**

10-20. Processing may or may not be required. Coordinate the decision to process civilians with NGOs, IHOs, IOs, the HN, CA, and other interested agencies. The initial reception begins with the transport of civilians from their neighborhoods or other places to the inprocessing center of the I/R facility. The HN (in coordination with NGOs, IHOs and IOs) normally arranges transportation. Civilians may be fearful and in a state of shock, so conduct processing in a positive manner. In most situations, they should clearly understand why they are being processed and know what to expect at each station. The facility commander, an HN representative, or another official conducts an entrance briefing to civilians upon their arrival.

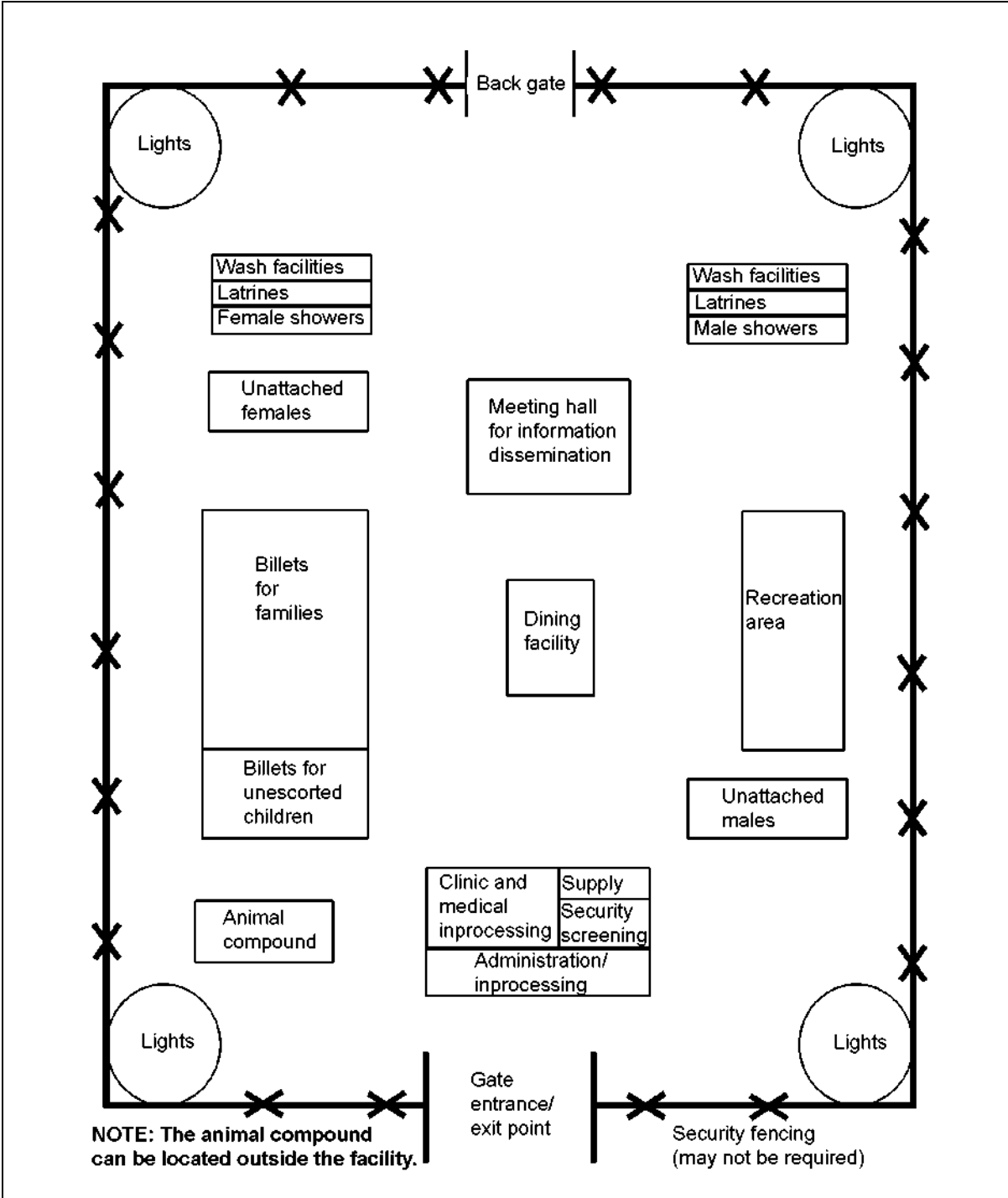


Figure 10-2. Sample HA I/R Facility

10-21. While DC processing procedures in Chapter 9 provide a foundation, I/R facility personnel must be aware of unique aspects when conducting HA operations. Military personnel normally provide training and support, and HN authorities do the actual processing. The number and type of processing stations vary from operation to operation. Table 10-1 shows stations that are required for HA operations.

**Table 10-1. Actions During Inprocessing**

Station	Purpose	Responsible Individuals*	Actions
1	Accountability	HN and I/R staff	Prepare forms and records to maintain accountability of civilians. Use forms and records provided by the HN, CA, or those used for EPW/CI operations that may apply to HA operations.
2	ID card or band	HN and I/R staff	Issue ID cards or bands to facilitate administration and control of the facility if necessary.
3	Medical evaluation	HN, I/R staff, and medical personnel	Evaluate civilians for signs of illness or injury.
4	Assignment	HN and I/R staff	Assign each civilian a sleeping area.
5	Personal items	HN and I/R staff	Issue personal-comfort items and, if available, clothing.

\*The number of people performing these tasks depends on the number of civilians and the time available. Allow HN authorities to conduct most of the inprocessing.

10-22. The I/R facility commander determines the accountability procedures and requirements necessary for HA operations. Translators are present throughout processing. A senior person greets new arrivals and makes them feel welcome. Brief civilians on facility policies and procedures and screen them to identify security and medical concerns. Offer them the use of personal-hygiene facilities, and always maintain family integrity.

10-23. Conduct pat-down searches to ensure that weapons are not introduced into the compound. Conduct same-gender searches when possible, and do not conduct strip searches. Speed and security considerations may require mixed-gender searches. If so, perform them in a respectful manner, using all possible measures to prevent any action that could be interpreted as sexual molestation or assault. The on-site supervisor carefully controls soldiers doing mixed-gender searches to prevent allegations of sexual misconduct.

## SCREENING

10-24. Depending on the environment, screening may or may not be necessary. The screening process also identifies technicians and professionals to help administer the facility; for example, policemen, schoolteachers, doctors, dentists, nurses, lawyers, mechanics, carpenters, and cooks.

## IDENTIFICATION

10-25. Identifying DCs may or may not be necessary; and it depends on guidance from higher headquarters, CA, and the HN. The need for ID varies from operation to operation, and it is used to—

- Verify rosters against the actual population.

- Provide timely reunification of family members.
- Match civilians with their medical records in case of a medical emergency or evacuation.
- Check identities of civilians against the transfer roster.

10-26. An ID card can be used to facilitate ID. It contains the civilian's name, photograph, and control number. The control number may be an ISN or a sequenced control number specific to the civilian. Color-coded IDs may be necessary to permit ID. An ID band permits rapid, reliable ID of an individual and may also be used in HA operations. While civilians cannot be prevented from removing or destroying bands, most will accept their use for ID purposes. When ID bands or cards deteriorate, replace them immediately.

### **CLOTHING AND EQUIPMENT**

10-27. Supply civilians with adequate, suitable clothing and sleeping equipment if they do not have supplies with them. Requisition clothing and equipment through NGOs, IHOs, and IOs when possible. In a hostile environment, use available captured clothing and equipment. Ensure that civilians wear clothing until it is unserviceable, and replace it as necessary.

### **SUBSISTENCE**

10-28. Ensure that food rations are sufficient in quantity, quality, and variety to maintain health and prevent weight loss and nutritional deficiencies. Consider the habitual diet of the civilian population. Ensure that expectant and nursing mothers and children under the age of 15 receive additional food in proportion to their needs. Increase the rations of workers based on the type of labor performed. Provide plenty of fresh potable water. Make minimal menu and feeding-schedule changes to prevent unrest among the population, and inform civilians when changes must be made.

### **DINING FACILITIES**

10-29. Dining-facility requirements for HA operations are similar to those for DC operations. If deemed necessary, the I/R facility commander can authorize local procurement of cooking equipment. Consult with SJA to determine the purchasing mechanism and the legality of items being purchased. Coordinate with NGOs, IHOs, and IOs for food service support. A qualified food service person is authorized in each 19547AB I/R detachment, and a food operations sergeant and a first cook provide food service support for each compound. Train selected civilians to perform food service operations, and ensure that they are constantly supervised by US food service personnel.

### **MEDICAL AND SANITATION CONSIDERATIONS**

10-30. The need for medical care and sanitation intensifies in an I/R environment due to its temporary nature, the lack of proper sanitation facilities, and the lack of basic community services (potable water and sewer). Enforcement and education measures ensure that the facility population complies with basic sanitation measures. Provide medical care via organic I/R medical personnel or coordinate with the appropriate HN medical authorities. To prevent communicable diseases, follow the guidance in FM 21-10 and other

applicable publications. Conduct routine, preplanned health, comfort, and welfare inspections that appear to be random. Ensure that inspections cause minimal disruption of space and privacy. Inspections ensure that the facility is safe, sanitary, and hazard-free. When conducting inspections—

- Ensure that their purpose is conveyed and emphasized to the civilian population.
- Respect cultural beliefs such as religious tenets and shrines. The INS, international support groups, community leaders, CA, and HN authorities are good sources for information regarding cultural sensitivities.
- Treat civilians and their possessions with respect.

### **SELF-GOVERNMENT**

10-31. The I/R facility commander determines whether self-government is required and appropriate. If responding to a natural disaster, such as an earthquake, the civilian government may not be affected and the I/R facility may be used as shelter only. However, if the civilian government cannot be established or is nonoperational, self-government may be appropriate. Chapter 5 and AR 190-8 contain procedures for establishing a CI committee. Use the procedures as a model for establishing a CA self-government, and coordinate with CA for assistance.

10-32. Self-government leaders can help solve problems before they become major events. The infrastructure of self-government promotes a stable environment where rapport is built between the facility commander, the civilian leadership, and the civilian population. This, in turn, reduces tension and provides an effective means of communicating reliable information to the facility population.

10-33. Civilians can submit complaints and requests to the I/R facility commander via—

- An elected civilian internment committee.
- A written complaint.
- A visiting representative of the UNHRC or a similar agency.

### **CONTROL AND DISCIPLINE**

10-34. Controlling people is the key to successful facility operations. Civilians housed in I/R facilities during HA are not prisoners. Consider this fact when drafting rules and guidelines. Establish, maintain, and enforce discipline and security to avoid unstable conditions that may further affect civilians during HA operations. Establish and explain rules that can be easily followed by everyone in the facility. Coordinate with SJA and HN authorities to determine how to enforce rules and how to deal with civilians who violate noncriminal rules. Publish and enforce rules of conduct and update them as necessary. The I/R facility commander serves as the single POC and coordinates all matters with outside organizations or agencies. Keep barracks rules brief and to a minimum (see Figure 9-3, page 9-15).

10-35. Discipline and control also apply to I/R facility personnel. They—

- Observe rigorous self-discipline.

- Maintain a professional, impersonal attitude.
- Follow the ROI and the ROE.
- Cope with hostile or unruly behavior and incidents calmly.
- Take fair, immediate, decisive action.

10-36. The I/R facility commander takes positive action to establish daily or periodic routines and responses that are conducive to good discipline and control. He ensures that I/R facility personnel—

- Enforce policies and procedures.
- Give reasonable orders decisively and in a language that residents understand.
- Post facility rules, regulations, instructions, notices, orders, and announcements that residents are expected to obey in an easily accessed area. Ensure that the information is printed in a language that residents understand, and provide a copy to residents who do not have access to posted copies.
- Ensure that residents obey orders, rules, and directives.
- Report residents who refuse or fail to obey an order or a regulation.
- Do not fraternize with residents.
- Do not donate or receive gifts or engage in any commercial activity with residents.

## **ADMINISTRATION**

10-37. Due to the large number of civilians requiring control and care, use HN civilians as cadre for facility administration when possible. The HN civilians should come from public and private welfare organizations and be under military supervision. Also encourage residents to become involved in facility administration. If possible, CA and I/R facility personnel organize and train cadre before the facility opens.

10-38. Problems might stem from civilians' state of mind. The difficulties they experienced may affect their acceptance of authority. They may have little initiative or may be uncooperative because of an uncertain future. They may be angry because of their losses, or they may resort to looting and general lawlessness because of their condition. The I/R facility commander can minimize difficulties through careful administration and—

- Maintaining different national and cultural groups in separate facilities or sections.
- Keeping families together.
- Separating unaccompanied males, females, and children under the age of 18 (based on HN laws as to when a child becomes an adult).
- Allowing civilians to speak freely to facility officials.
- Involving civilians in facility administration, work, and recreation.
- Establishing quick contact with agencies for aid and family reunification.

10-39. The I/R facility commander administers the facility to ensure that civilians are treated according to the following basic standards:

- Do not restrict their movement except when necessary for public health and order.
- Allow them to enjoy their fundamental rights.
- Treat them as persons whose plight requires special understanding and sympathy. Provide necessary assistance, and do not subject them to cruel, inhumane, or degrading treatment.
- Do not discriminate because of race, religion, political opinion, nationality, or country of origin.
- Recognize that they are persons before the law who enjoy free access to the courts of law and other competent administrative authorities.
- Provide them with necessities (food, shelter, and basic sanitary and health facilities).
- Maintain family units when possible.
- Provide assistance for tracing relatives.
- Protect minors and unaccompanied children.
- Allow them to send and receive mail.
- Permit material assistance from friends and relatives.
- Arrange for the registration of births, deaths, and marriages if possible.
- Grant them the means necessary to obtain a satisfactory, durable solution.
- Permit them to transfer assets to the country where they obtain a durable solution.
- Take steps to facilitate voluntary repatriation.
- Provide humane treatment and protect them against violence, intimidation, insults, and public curiosity.

10-40. Disseminating instructions and information to the facility population is vital. Communications may be in the form of notices on bulletin boards, posters, public address systems, loudspeakers, camp meetings and assemblies, or a facility radio station. The CA teams and area PSYOP units can help disseminate information.

10-41. Another tool for effective administration is using liaison personnel. Liaison involves coordination with all interested agencies. The US government and military authorities, allied liaison officers, and representatives of local governments and international agencies can provide assistance.

## **LAW AND ORDER**

10-42. The I/R facility commander is also the safety and security officer. He deals with crimes against persons and property, performs security patrols, and conducts reaction team operations. If an L&O team is attached to the organization, it performs L&O-related functions. Otherwise, the commander uses organic resources, such as an MP guard company, to establish an MP desk and blotter and perform other specific functions. The location of the MP station depends on the facility's layout and the commander's needs.



10-43. Some other sources for security officers include local police forces, HN paramilitary and military forces, and the facility population. Police personnel within the population can supplement security teams or constitute a facility police force if necessary. Internal and external patrols are necessary; however, ensure that security does not give the impression that the facility is a prison. Base patrol areas and distribution plans on the size of the facility and the number of civilians in each subdivision. Before apprehending a civilian, the commander coordinates with SJA and HN authorities to determine his jurisdiction and authority. He determines the disposition and the status of the subject and the disposition of the case paperwork, evidence (including crime lab analysis results), and recovered property. The commander also obtains information on items, procedures, and agreements unique to the supported HN.

10-44. Be prepared to perform civil-disturbance operations to restore L&O if HN reactionary forces are unavailable. Identify a reactionary force that can be immediately deployed and employed inside the facility to control a disturbance. The size of the reactionary force depends on the facility population and the available military forces. The reactionary force is well trained, well organized, and knowledgeable of applicable ROE, the use-of-force policy, and the use of NLWs and civil-disturbance measures. (See Appendix B and FM 19-15 for more information.)

10-45. Basic guidelines and the foundation for I/R facility L&O are provided in FMs 19-10 and 19-20. The I/R facility commander tailors the forms and procedures to his specific mission.

## **RULES OF INTERACTION**

10-46. The ROI provide soldiers with a guide for interacting with the civilian population. The following points may be included in the ROI:

- Avoid discussing politics or other policies with civilians.
- Avoid making promises. If cornered, reply with, "I will see what I can do."
- Refrain from making obscene gestures because civilians may understand the meaning.
- Avoid making derogatory remarks. Local linguists understand English and civilians might.
- Treat civilians equally. They may become offended if they do not receive the same treatment or resources others receive.
- Respect religious articles and materials.
- Treat medical problems seriously.
- Treat civilians with respect.
- Greet civilians in their own language.
- Clear phrases that civilians teach to soldiers through a linguist to ensure that they do not contain obscene language.

## **TRANSPORTATION**

10-47. The I/R facility requires adequate transportation assets. Since MP units have limited organic transportation assets, the unit MCO, the CA

transportation specialist, the HN, NGOs, and IHOs coordinate and determine the types and numbers of vehicles required and make provisions to have them on hand.

## **DISPOSITION**

10-48. The final step in HA operations is the disposition of civilians. Allowing civilians to return to their homes as quickly as conditions permit lessens the burden on military and civilian economies. It also reduces the danger of diseases that are common among people in confined areas. When civilians return home, they can help restore their towns and can better contribute to their own support. If civilians cannot return home, they may resettle elsewhere in their country. Guidance on the disposition of civilians comes from higher authority upon coordination with US forces, national authorities, and international agencies.

## **SECTION II - EMERGENCY SERVICES**

10-49. Government agencies are primarily responsible for ES (police, fire, rescue, and disaster preparedness). Military support to ES agencies can be provided as civil-military assistance. The ES operations are normally conducted in CONUS, but they can be conducted OCONUS.

## **IN CONTINENTAL UNITED STATES**

10-50. In the US, the federal government is responsible for ES at all levels. It provides planning advice and coordinates research, equipment, and financial aid. State and local governments determine the allocation of these resources. In the event of an emergency, US forces are prepared to help civil authorities restore essential services, repair essential facilities and, if necessary, ensure national survival. Federal statutes and military regulations govern conditions for employing active component (AC) and United States Army Reserve (USAR) military forces. (See FM 100-19 for more information.)

10-51. The DOD components develop appropriate contingency plans for disaster assistance and ensure coordination with the appropriate federal, state, and local civil authorities. When a disaster is so serious that waiting for instructions from higher authority causes unwarranted delays, a military commander can take action under DOD Directive 3025.1. The directive authorizes military forces to respond immediately to save lives, prevent human suffering, and mitigate great property damage. This support cannot exceed 72 hours without DOD approval. The commander promptly reports the action to higher authority and requests guidance if continued support is necessary or beyond his capability.

10-52. The AC and USAR forces used in disaster relief are under the command of their military superiors. Other military participation and the use of military resources occur on a mission-by-mission basis and end at the earliest practicable time. Commanders ensure that personnel participating in domestic assistance are not in violation of the Posse Comitatus Act. This act prohibits the use of federal military personnel to enforce federal, state, or local

---

laws unless expressly authorized by the Constitution or by an act of Congress. The act does not apply to state national guard (NG) forces unless they have been federalized. When placed on state active duty, NG forces (Army and Air) are under the C<sup>2</sup> of state authorities, not federal forces.

10-53. Measures to ensure the continuity of operations, troop survival, and the rehabilitation of essential military bases take precedence over military support of local communities. Consider requests for support on a mission-by-mission basis. With the exception of support directed in response to a nationally declared emergency, the military commander decides the necessity, amount, duration, and employment method of support rendered.

10-54. When committing USAR units or individual reservists to disaster relief operations, ensure that—

- The President's reserve call-up allows CONUS deployment of USAR troops.
- The commitment of USAR volunteers is consistent with Army policy for military assistance and is coordinated with the proper Corps of Engineer district or division to avoid duplication of effort. (The authority to commit USAR volunteers can be delegated no lower than CONUS Army.)
- Civil authorities make a firm commitment to repay active-duty tour (ADT) costs.
- State and local assets (including the NG) are committed if the requested assistance is within their capabilities.

10-55. A USAR commander can approve immediate-response, voluntary USAR participation during imminently serious conditions in a nondrill, nonpay status per DOD Directive 3025.1. The USAR members taking part in such support are performing official duty. The USAR commander—

- Does not order members to participate.
- Approves voluntary participation only when time or conditions do not permit seeking guidance from higher headquarters.
- Ensures that state and local assets are fully committed if the requested assistance is within their capabilities.
- Provides support on a mission-by-mission basis.
- Discontinues support when adequate state and local assets become available.

10-56. The MP units assisting ES operations in CONUS involve DOD-sponsored military programs that support the people and the government at all levels within the US and its territories. These programs and operations are classified as domestic support, and civil law and military regulations closely regulate a commander's authority and responsibilities.

10-57. Protecting life and property within the territorial jurisdiction of a community is the primary responsibility of state and local governments and civil authorities. Federal armed forces can be employed when—

- The situation is beyond state and local capabilities.
- State and local authorities do not take appropriate action.

## **FEDERAL EMERGENCY MANAGEMENT AGENCY**

10-58. The FEMA serves as the single POC within the US government for all emergency planning and management. It establishes and maintains a comprehensive, coordinated emergency management capability in the US. The FEMA plans and prepares for, responds and recovers from, and most importantly, mitigates the effects of emergencies, disasters, and hazards that range from safety and protection in the home to a nuclear attack. Within FEMA, two primary departments provide civil-defense plans and guidance.

### **Plans and Preparedness Department**

10-59. The Plans and Preparedness Department develops and implements overall concepts and policy guidance. It directs activities for nationwide plans and preparedness for emergencies during peace and war. The department develops guidance for federal emergency plans and state and local response capabilities, including tests and exercises for communications, warning, and damage assessment systems. It also develops policy guidance for stockpiling strategic materiel and develops plans, systems, and capabilities—

- To protect the US populace, government, and industry.
- For resource management and stabilization of the economy during emergencies.

### **Disaster Response and Recovery Department**

10-60. The Disaster Response and Recovery Department provides direction and overall policy coordination for federal disaster assistance programs. It advises the FEMA director on the mission, organization, and operation of the agency's disaster assistance program and the federal response and recovery capabilities. It administers federal disaster assistance and provides overall direction and management of federal response and recovery activities. The department develops summaries of existing situations to support the director's recommendation to the President on a state governor's request for a Presidential declaration of a major disaster or an emergency.

## **MILITARY POLICE SUPPORT**

10-61. The MP can be extremely valuable to civil authorities during ES. The CS and I/R MP units can operate an I/R-type facility that may become essential during ES. The MP units may be called upon to provide shelter to people whose community has been struck by a powerful disaster, such as a tornado or a hurricane. When civil authorities request assistance, MP units may be deployed and employed as part of a JTF anywhere in CONUS or its territories.

10-62. The MP support to ES in CONUS varies significantly from other I/R operations. The basic difference is that local and state governments and the federal government and its agencies have a greater impact and role in supporting and meeting the needs of an affected community. In CMO for disaster relief, MP receive missions from the FEMA through the DOMS and the chain of command. The MP commander uses the MDMP to determine the specific tasks necessary to accomplish the mission. Using the same format as

used in HA operations, the commander modifies and tailors the tasks as necessary.

10-63. If tasked to set up and operate an I/R facility, the MP commander retains control of military forces under his command. Depending on the situation, overall control of the facility may or may not be maintained by FEMA or the DOJ. Coordinate the location of the I/R facility with local authorities. The city chief of police, mayor, or ES director may have already selected a site that has easy access, is located on high ground, or is adjacent to other services.

10-64. The I/R facility commander may or may not be able to depend on local labor to help set up the facility. The victims' state of mind and their physical conditions may prevent them from participating in construction efforts. However, assistance may not be required if the Engineer Corps uses the TCMS to build shelters or if other shelters are available. Discuss the facility's setup with local, state, and federal relief agencies. Although the basic setup for HA operations may be adequate, the I/R facility commander can modify the setup to meet local needs. As a minimum, the facility should have stations for processing, medical screening, and distribution of personal-hygiene items.

10-65. Screening, classification, and ID requirements may not be needed in CONUS ES operations. Discuss these capabilities with local authorities to determine the need for them. As with HA operations, clothing requirements may exceed supply. This will be the case during destructive disasters such as tornadoes, fires, and hurricanes. Coordinate clothing, subsistence, medical, and dining-facility requirements with local, state, and federal relief agencies responding to the disaster.

10-66. Since the Posse Comitatus Act prohibits MP from enforcing civilian laws, local, state, and federal law enforcement officials perform discipline, control, and L&O of the facility. The MP can be used in conjunction with local, state, and federal law enforcement officials; but they cannot be directly involved in law enforcement functions such as search, seizure, and arrest. A facility staff member who observes a violation of criminal law reports the incident to civilian law enforcement officials. The ROI, if applicable, are provided by the JFC.

## **OUTSIDE CONTINENTAL UNITED STATES**

10-67. The FNs are responsible for providing ES for their citizens. When requirements exceed their capabilities, they may request assistance through the US Embassy.

10-68. The DOD components support or participate in foreign disaster relief operations when the DOS determines that disaster relief will be provided to the requesting country. Military commanders at the immediate scene of a foreign disaster may provide prompt relief operations to preserve lives and prevent injuries when time is of the essence and when humanitarian considerations make it advisable. Commanders taking such action immediately report operations according to the provisions of DOD Directive 5100.46.

10-69. The Assistant Secretary of Defense (ASD) for Democracy and Peacekeeping is the approval authority for committing DOD resources or services to foreign disaster relief operations. The DASD for H&RA (Global Affairs) is the DOD coordinator for foreign disaster relief operations. The Logistics Directorate (J4) is the joint staff's POC for the DOD Foreign Disaster Relief and Humanitarian Assistance Program.

10-70. The ASD for International Security Affairs approves DOD supplies and services for disaster and humanitarian purposes. He provides supplies and services from the most expedient source, which is normally the geographic command from whose theater the request emanates.

10-71. The geographic CINC assumes the primary coordinating role for providing DOD supplies and services. The military departments and the joint staff support the designated commander of a unified command as required, primarily by coordinating interdepartmental approval and funding processes through the DASD for H&RA (Global Affairs).

10-72. When a request emanates from a country not assigned to a geographic CINC under the Unified Command Plan, the joint staff or the J4 assumes the primary coordinating role in conjunction with the DASD for H&RA. Requests for DOD assistance are received from the DOS or the USAID through the OFDA.

#### **UNITED STATES AGENCY FOR INTERNATIONAL DEVELOPMENT**

10-73. The USAID administers the President's authority to coordinate assistance in response to disasters, as declared by the ambassador within the country or a higher DOS authority. The USAID is authorized to provide assistance, notwithstanding any other provision of law. This authority allows the USAID to expedite interventions at the operational and tactical levels using NGOs and other relief sources. The USAID—

- Organizes and coordinates the US disaster relief response.
- Responds to requests for disaster assistance.
- Initiates procurement of supplies, services, and transportation.

10-74. The Foreign Assistance Act is the authority for providing disaster relief to—

- Preserve life and minimize suffering by providing sufficient warning of natural events that cause disasters.
- Preserve life and minimize suffering by responding to natural and man-made disasters.
- Foster self-sufficiency among disaster-prone nations by helping them achieve some measure of preparedness.
- Alleviate suffering by providing rapid, appropriate responses to requests for aid.
- Enhance recovery through rehabilitation programs.

10-75. The USAID coordinates with the DOD on matters concerning defense equipment and personnel provided to the affected nation and to arrange DOD transportation. DOD Directive 5100.46 establishes the relationship between the DOD and the USAID. The DASD for H&RA is the primary POC. When the

USAID requests specific services from the DOD, typically airlift, it pays for the services. The CINC coordinates with the OFDA to arrange military and civilian assistance efforts. The USAID provides an excellent means for military and civilian operational-level coordination.

10-76. The USAID has operational links and grants relationships with many NGOs and IOs that have relief programs outside the US. These include the ICRC, the IFRC, the UNICEF, and the WFP. The USAID also coordinates with other governments responding to disasters through donor country coordination meetings to solve operational and political problems. The USAID can deploy a disaster assistance response team (DART) into the AOR to manage US relief efforts.

### **DISASTER ASSISTANCE RESPONSE TEAM**

10-77. The DART concept was developed to provide rapid response to international disasters. A DART provides specialists trained in a variety of disaster relief skills who assist US Embassies and the USAID in managing the US government's response to disasters.

10-78. The activities of a DART vary depending on the type, size, and complexity of the disaster. The DARTs coordinate with the affected country, other assisting countries, NGOs, IOs, and US military assets deployed to the disaster. During rapid-onset disasters, DARTs—

- Coordinate the needs assessment.
- Recommend US government response actions.
- Manage US government on-site relief activities.

During long-term, complex disasters, DARTs—

- Gather information on the disaster situation.
- Monitor the effectiveness of current US government-funded relief activities.
- Review proposals of relief activities for future funding.
- Recommend follow-on strategies and actions to the OFDA.

10-79. The number of people assigned to a DART depends on the activities needed to meet the strategic objectives. A DART consists of five functional areas—management, operations, planning, logistics, and administration:

- **Management.** It includes the oversight of DART activities, NGOs, IOs, other assisting countries, and the US military. It also involves the development and implementation of plans to meet strategic objectives.
- **Operations.** It includes all operational activities carried out by a DART, such as search, rescue, and aerial operations; technical support; and medical response. This function is most active during rapid-onset disasters.
- **Planning.** It includes collecting, evaluating, tracking, and disseminating information on the disaster. It also includes reviewing activities, recommending future actions, and developing operational (tactical) plans.
- **Logistics.** It includes providing support to the OFDA and DARTs by managing supplies, equipment, and services and by ordering,

receiving, distributing, and tracking people and US government-provided relief supplies.

- **Administration.** It includes the management of contracts, the procurement of goods and services required by the OFDA and DARTs, and the fiscal activities of DARTs.

10-80. The DART team leader organizes and supervises the DART. He is delegated authority from and works for the Assistant Director for Disaster Response or his designee. The delegation lists the objectives, priorities, constraints, and reporting requirements for the DART.

10-81. Before the DART departs, the team leader contacts the USAID or the US Embassy (if present in the affected country) to discuss the situation; review the structure, size, objectives, and capabilities of the DART; and identify the areas of support needed by the DART. Upon arriving in the affected country, he reports to the senior US official or the appropriate country official to discuss DART objectives and capabilities and to receive additional instructions and authority.

10-82. While in the affected country, the team leader advises the USAID or the US Embassy and receives periodic instructions from the agency. The DART follows instructions unless they conflict with OFDA policies, authorities, and procedures. Throughout the operation, the team leader maintains direct LOC with the OFDA.

10-83. The USAID or the US Embassy and the OFDA determine the duration of a DART operation after reviewing the disaster situation and the progress in meeting operational objectives. The DART is a highly flexible, mobile organization that is capable of adjusting its size and mission to satisfy the changing needs of the disaster situation.

10-84. A DART normally tailors its capabilities to the particular situation. It assesses the damage to the civil infrastructure, helps operate temporary shelters, and manages a CMO center. The CA units serve as liaison between military and local relief organizations, NGOs, IOs, and DARTs.

### **MILITARY POLICE SUPPORT**

10-85. The I/R unit support to ES OCONUS is similar to MP support during HA operations. The location, setup, construction, and tasks are based on the nature of the emergency and the needs of the HN.



## Appendix A

# Metric Conversions

This appendix complies with current Army directives which state that the metric system will be incorporated into all new publications. *Table A-1* is a conversion chart.

**Table A-1. Metric Conversion Chart**

<b>US Units</b>	<b>Multiplied By</b>	<b>Metric Units</b>
Cubic feet	0.0283	Cubic meters
Feet	0.305	Meters
Inches	2.54	Centimeters
Square yards	0.836	Square meters
<b>Metric Units</b>	<b>Multiplied By</b>	<b>US Units</b>
Centimeters	0.0394	Inches
Cubic meters	35.3	Cubic feet
Meters	3.28	Feet
Square meters	1.196	Square yards

## Appendix B

# Use of Force and Riot Control Measures

The I/R facility commander provides guidance to all MP guard forces in the appropriate use of force to protect internees and internment facilities and to control unruly and rebellious internee populations. This includes establishing uniform procedures that govern the use of force, weapons, and restraining devices. He ensures that a QRF is organized and trained to respond to disturbances inside and outside the facility—whether prisoners are creating a disturbance or there is a Level I threat against the facility. Supporting MP units train squad- to platoon-sized QRFs and squad-sized elements for extraction and apprehension teams. (See FM 19-15 for more information on civil disturbances.)

### USE OF FORCE

B-1. When force is necessary, use it according to the priorities of force and limit it to the minimum degree necessary. (See AR 190-14 for the use of deadly force.) The application of any or all of the priorities of force, or the application of a higher numbered priority without first employing a lower numbered one, depends on and will be consistent with the situation encountered. Per AR 190-47, the priorities of force are—

- First: Verbal persuasion.
- Second: Show of force.
- Third: Chemical aerosol irritant projectors (subject to local and HN restrictions).
- Fourth: Use of physical force (other than weapons fire).
- Fifth: Presentation of deadly force.
- Sixth: Deadly force.

B-2. The I/R commander coordinates with the higher echelon commander and the SJA. He designates representatives who are authorized to direct the use of firearms and riot control agents during riots or disturbances. He includes the rules for using these means in appropriate plans, orders, SOPs, and instructions. He specifies the types of weapons to be used, which are not limited to shotguns and pistols for guarding prisoners.

### DEADLY FORCE

B-3. Deadly force causes death or serious bodily harm. It is a destructive physical force against a person using a weapon or equipment that exerts deadly force. Use deadly force in extreme situations, when all lesser means have failed or cannot be used reasonably. Deadly force is authorized for the following reasons:

- **Self-defense and the defense of others.** Deadly force is authorized to protect an MP, a guard, or any person who believes he or others are in imminent danger of death or serious bodily harm.
- **Protection of assets involving national security.** Deadly force is authorized to prevent the theft or sabotage of assets vital to national security.
- **Protection of assets inherently dangerous to others.** Deadly force is authorized to prevent the theft or sabotage of resources, such as operable weapons or ammunition, that are inherently dangerous to others.
- **Serious offenses against persons.** Deadly force is authorized to prevent a serious offense involving violence or a threat of death or serious bodily harm.
- **Arrests and apprehensions.** Deadly force is authorized to arrest or apprehend a person who has committed an offense as specified in bullets 2 through 4 above.
- **Escapes.** The law of land warfare permits deadly force to prevent an EPW or an RP from escaping if he poses a threat of serious bodily harm to security personnel or others. If a CI tries to escape, force can only be used when the ROE authorizes it (see AR 190-8).

**NOTE: See AR 190-14 for more information on the use of deadly force.**

B-4. The I/R facility commander ensures that soldiers understand the ROE, including the use of the term *halt*, the use of deadly force, and the ban on using physical or imaginary deadlines. He also ensures that EPWs and RPs understand the meaning of the English word *halt*.

B-5. When a prisoner tries to escape, the guard shouts *HALT* three times. He then uses the least amount of force necessary to stop the escape. If there is no other effective means of preventing escape, deadly force can be used. **Do not** fire on a prisoner unless he has cleared the outside fence (barrier, concertina wire, or razor tape) and is making a further effort to escape. **Do not** fire on a prisoner attempting to escape outside a fenced enclosure unless he does not halt after the third command. An escape is successful if a prisoner—

- Reaches the lines of a force of which he is a member or the allies of that power.
- Leaves a territory that is not controlled by the US or its allies.

## **RULES OF ENGAGEMENT**

B-6. Commanders balance the physical security of forces with mission accomplishment and the ROE issued for the mission. The unified commander develops ROE for his forces. They are based on guidance from the national command authority; operational, political, diplomatic, and legal considerations; mission requirements; threat assessments; the law of land warfare; and HN or third-country constraints on deployed forces.

B-7. The political situation may influence the ROE and conflict with physical-security needs. In these cases, commanders weigh the political gains against the risk to the force. They clearly state their objectives with defined

operational limits that allow mission accomplishment and protect deployed forces.

B-8. Restrictions on combat operations and the use of force are clearly explained in the ROE and understood and obeyed at all levels. Soldiers study and train in the use of the ROE and discuss the ROE for their mission. Misunderstandings and actions, no matter how minor, may have far-reaching repercussions because friendly and enemy media can exploit incidents rapidly.

B-9. The ROE address specific distinctions between internee categories and the instruments of control available for each. Use the following issues to develop guidelines:

- What is considered deadly force?
- Under what conditions—
  - Will deadly force be used?
  - Will nonlethal technology be used?
- What are the required warnings (see ARs 190-8 and 190-14) before using force (nonlethal or lethal)?

## **NONLETHAL WEAPONS**

B-10. The DOD defines NLWs as weapons that are explicitly designed and primarily employed to incapacitate personnel or material, while minimizing fatalities, permanent injury to personnel, and undesired damage to property and the environment. Unlike conventional weapons that destroy their targets through blast, penetration, and fragmentation, NLWs employ other means to prevent the target from functioning.

B-11. The NLW doctrine and concepts of operation are designed to reinforce deterrence and expand the range of options available to commanders. They enhance the capability of US forces to accomplish the following objectives:

- Discourage, delay, and prevent hostile actions.
- Limit escalation.
- Take military action in situations where the use of lethal force is not the preferred option.
- Protect US forces.
- Disable equipment, facilities, and personnel.

B-12. The zero probability of producing fatalities or permanent injuries is not a requirement of NLWs. Complete avoidance of these effects is not guaranteed or expected; however, NLWs significantly reduce them as compared to lethal weapons. When drafting the ROE, clearly articulate that using NLWs is an additional means of employing force for the particular purpose of limiting the probability of death or serious injury to noncombatants or belligerents. However, the use of deadly force is an inherent right of individuals when they, their fellow soldiers, or personnel in their charge are threatened with death or serious bodily harm. The use of NLWs adds flexibility when controlling disturbances in an I/R facility by providing an environment where guard forces can permissively engage threatening targets with limited risk of noncombatant casualties and collateral damage (see FM 90-40). Table B-1, page B-4, shows lethal, nonlethal, and ineffective zones of NLWs.

**Table B-1. Range of NLWs**

NLW	Meters												
	0	5	15	20	25	30	35	50	55	65	95	100	120
MCCM	█	█	█	█	█	█	█	█	█	█	█	█	█
Stun hand grenade	█	█	█	█	█	█	█	█	█	█	█	█	█
12-gauge point	█	█	█	█	█	█	█	█	█	█	█	█	█
12-gauge area	█	█	█	█	█	█	█	█	█	█	█	█	█
40-millimeter point	█	█	█	█	█	█	█	█	█	█	█	█	█
66-millimeter sting ball	█	█	█	█	█	█	█	█	█	█	█	█	█
66-millimeter flash bang	█	█	█	█	█	█	█	█	█	█	█	█	█
66-millimeter CS grenade	█	█	█	█	█	█	█	█	█	█	█	█	█

Lethal zone  
 Nonlethal zone  
 Ineffective zone

B-13. The use of lethal force under the standing ROE is never denied. Never deploy forces without giving them the ability to defend themselves against a lethal threat. Ensure that they are trained, armed, and equipped for combat. Nonlethal force is a complement to, not a replacement for, lethal force. Expand a proactive response across the range of military operations. Delegate the decision to use NLWs against an adversary during a confrontation to the lowest possible level, preferably to the platoon or the squad. Ensure that all personnel, not just leaders, have a clear understanding of the ROE and the commander’s intent (see FM 90-40).

B-14. Facility commanders consider the use-of-force options discussed in this appendix and AR 190-14 when dealing with disruptions. They substitute nonlethal devices for firearms when they are adequate for MP to safely perform their duties. Currently, MP have the following nonlethal options available for crowd control:

- Riot control agents.
  - O-chlorobenzylidene malonitrile (CS).
  - Oleoresin capsicum (OC).
- MWDs.
- MP clubs.
- Riot batons.

B-15. Commanders and public affairs officers are prepared to address media questions and concerns regarding the use and role of NLWs. They make it clear that the presence of NLWs in no way indicates abandoning the option to employ deadly force in appropriate circumstances.

---

## ADVANTAGES

B-16. The NLWs provide the flexibility to favorably influence a situation with reduced risk of noncombatant fatalities and collateral damage. They are more humane, which is consistent with the political and social intent of humanitarian and peacekeeping missions. The force that properly employs NLWs gains an advantage over forces who rely on lethal options alone because the degree of provocation required to employ these options is substantially less. This advantage provides a proactive posture and a quicker response. It also diminishes the likelihood of a situation escalating to a point where deadly force is required.

B-17. The NLWs are less likely to provoke others; however, they may provoke a negative response. Demonstrated restraint greatly diminishes feelings of anger and remorse when deadly force is required after nonlethal options fail. The NLWs facilitate postincident stabilization by reducing internee alienation and collateral damage.

## TRAINING

B-18. Soldiers and leaders are trained in the correct employment of NLWs. They understand the limited use of these systems in environments with restrictive ROE. Their training is continuous at all levels so that they understand when and how to effectively and properly employ NLWs. The incorrect application of NLWs can have significant operational and political ramifications. Well-trained MP leaders who provide timely, clear guidance to soldiers ensure mission accomplishment.

B-19. Many NLWs have maximum-effective and minimum-safety ranges. Individuals struck short of the minimum safety range often suffer severe injuries or death, while the effects of most nonlethal devices are greatly mitigated at longer ranges. Engage the threat within the nonlethal zone, which is beyond the lethal zone and short of the ineffective zone (see Table B-1).

B-20. When training with and planning for the use of NLWs—

- Never apply them in situations where deadly force is appropriate.
- Never apply them in situations that will place troops in undue danger.
- Always cover them with deadly force.

## TACTICS

B-21. Establish riot control teams that have a minimum response time. Due to the physical nature of riot control, individuals in riot control formations do not carry long rifles. Lethal attachments follow closely behind riot control formations to provide lethal coverage for the entire formation.

B-22. During a nonlethal engagement, a designated marksman supplies lethal overwatch to provide confidence and safety to those facing a riot. The marksman is in an overwatch position and armed with a standard infantry rifle, mounted with a high-powered scope. If a lethal threat is presented, he can scan the crowd to identify agitators and riot leaders for apprehension. He can also fire lethal rounds if warranted. Designated marksmen are ideally suited for flank security and countersniper operations.

**NOTE: See FM 90-40 for an in-depth discussion on the tactics associated with employing NLWs.**

## **CROWD DYNAMICS**

B-23. A commander considers crowd control and the dynamics caused by several people living in close quarters. Generally, he is concerned with two types of disturbances—riots and disorders. Prisoners may organize disturbances within an I/R facility to wear down the guard force.

B-24. Simply being a part of a crowd affects a person. Each person is open to actions that are different from his usual behavior. For example, crowds provide a sense of anonymity because they are large, often temporary, congregations. Crowd members often feel that their moral responsibility has shifted from themselves to the crowd as a whole. Large numbers of people discourage individual behavior, and the urge to imitate is strong in humans. People look to others for cues and disregard their own background and training. Only well-disciplined persons with strong convictions can resist conforming to crowd behavior. Crowd behavior influences the actions of disorderly participants and the authorities tasked to control them.

B-25. Under normal circumstances, a crowd is orderly and does not present a problem to authorities. However, when crowd behavior violates laws or threatens life or property, a disturbance ensues.

## **CROWD BEHAVIOR**

B-26. The presence or absence of social factors (leadership, moral attitudes, and social uniformity) may influence crowd behavior. Leadership has a profound effect on the intensity and direction of crowd behavior. When blocked from expressing its emotions in one direction, a crowd's frustration and hostility may be redirected elsewhere. The first person to give clear orders in an authoritative manner may become the leader. Agitators can exploit the crowd's mood and convert a group of frustrated, resentful people into a vengeful mob. Skillful agitators, using clandestine communications within an I/R facility, can reach large portions of the population and incite them to unlawful acts without having direct personal contact. In an I/R environment, any crowd can be a threat to L&O because it is open to manipulation.

B-27. Crowd behavior may be affected by panic or emotional contagion, which provides psychological unity. The unity is usually temporary, but it may be long enough to push a crowd to mob action. When emotional contagion prevails, normal L&O are suppressed, increasing the potential for violence. Panic can occur during a disturbance when—

- Crowd members perceive that their safety is at risk and they attempt to flee the area.
- Crowd members cannot disperse quickly after exposure to riot control agents.
- Escape routes are limited, blocked, or congested.

B-28. Members of the control force are also susceptible to crowd behavior. They may become emotionally stimulated during a tense confrontation and must exercise individual and collective restraint. Rigorous training, firm and

---

effective leadership, and complete awareness and understanding of the ROE and the ROI are necessary to offset the effect of crowd contagion on the control force.

## CROWD TACTICS

B-29. In disturbances, crowds employ any number of tactics to resist control and achieve their goals. Tactics may be planned or unplanned and violent or nonviolent. The more purposeful the disturbance, the more likely the possibility of well-planned tactics.

### Nonviolent Tactics (Disorders)

B-30. Nonviolent tactics include name calling, conducting demonstrations, refusing to work or eat, participating in a work slowdown, damaging or destroying property, and building barricades. Demonstrators may converse with control force members to distract them or gain their sympathy. They may use verbal abuse such as obscene remarks, taunts, ridicules, and jeers. Crowd members want to anger and demoralize the opposition, and they want authorities to take actions that can later be exploited as acts of brutality.

B-31. In compounds where women, children, and elders are interned, they may be placed in the front ranks of the demonstration to discourage countermeasures by the control force. When countermeasures are taken, agitators try to stir public displeasure and embarrass the control force through the media. Internees may form human blockades to impede movement by sitting down in footpaths or entrances to buildings within the compound. This disrupts normal activity and forces control personnel to remove demonstrators physically. Demonstrators may lock arms, making it hard for the control force to separate and remove them, so that it appears the control force is using excessive force.

B-32. Nonviolent tactics include the following types of disorders:

- **Demonstrations.** Demonstrations are actions by groups of people whose behavior, while not violent, is in conflict with those in authority. They are characterized by unruliness and vocal expressiveness without violence. Demonstrations may be organized in celebration of national holidays or as protests against food, clothing, living conditions, or treatment.
- **Refusal to work or eat.** Housed personnel may refuse to work or eat, collectively or individually, as a means of harassing the detaining power or in an attempt to gain concessions from the detaining power. This type of disorder can normally be controlled by promptly isolating and segregating offenders and ringleaders.
- **Work slowdown.** Housed personnel may initiate a deliberate work slowdown to delay the completion of projects, thereby harassing the detaining power. Disorders of this nature can also be controlled by promptly isolating and segregating offenders and ringleaders.
- **Damage or destruction of property.** Housed personnel often damage or destroy property to harass the detaining power, to impede or prevent normal operation of the facility, or for tactical purposes.



This type of disorder can normally be controlled by identifying, isolating, and segregating offenders.

- **Unorganized disorders.** Unorganized disorders are spontaneous and are started by the actions of a single individual. Like all disturbances, their prompt control is essential.

### **Violent Tactics (Riots)**

B-33. Violent crowd tactics can be extremely destructive. They include attacking other internees, guards, or government property and setting fires or bombings for escape, grievance, tactical, or political advantages. The attitude and ingenuity of crowd members, the training of their leaders, and the materials available are the only limits to violent crowd tactics. Crowd or mob members may commit violence with crude, homemade weapons or anything else that is available. If violence is planned, crowd members conceal makeshift weapons or tools for vandalism.

B-34. Crowd members can erect barricades to impede movement or to prevent the control force from entering an area or a building. They may use vehicles, trees, furniture, fences, or other material to build barricades. In an effort to breach barriers, rioters may throw grapples into wire barricades and drag them. They may use grapples, chains, wires, or ropes to pull down gates or fences to effect a mass escape. They may use long poles or homemade spears (tent poles) to keep control forces back while removing barricades or to prevent the use of bayonets.

B-35. Rioters can be expected to vent their emotions on individuals, troop formations, and control force equipment. They may throw rotten fruits and vegetables, rocks, bricks, bottles, or improvised bombs. They may direct dangerous objects (vehicles, carts, barrels, or liquids) at troops located on or at the bottom of a slope. They may drive commandeered vehicles toward troops to scatter the control force formation and jump out of vehicles before reaching roadblocks and barricades. Rioters may set fire to buildings or vehicles to block the advance of the control force formation, create confusion and diversion, destroy property, and mask escapes. Types of riots include—

- **Organized riots.** Leaders of housed personnel reorganize the internee population into quasi-military groups. The groups are capable of developing plans and tactics for riots and disorders. Riots can be instigated for—
  - **Escapes.** Leaders organize a riot as a diversion for an escape attempt by selected individuals or small groups or for a mass escape attempt.
  - **Political purposes.** Riots are often organized for propaganda or to embarrass the detaining power in its relations with protecting powers and other nations. They may also be organized to intimidate individuals or groups that may have been cooperative with the detaining power.
  - **Grievance protests.** A grievance protest can be organized as a riot. Under normal circumstances, this type of riot is not extremely violent in nature. It may turn violent when leaders try

to exploit the successes of the riot or the weaknesses of the detaining power.

- **Tactical purposes.** Riots are often organized for the sole purpose of diverting the detaining power, thereby limiting its ability to perform the mission.
- **Unorganized riots.** Unorganized riots are spontaneous, although they can be exploited and diverted by leaders into different types of riots. They may begin as a holiday celebration, a group singing, or a religious gathering. Under determined leadership, the pattern of these gatherings can change to an organized riot.
- **Multiple riots.** When housed personnel in one compound start rioting, personnel in other compounds may also riot. To meet this situation with only one riot control force available, the force commander first subdues the most riotous compound. He also employs riot control teams to contain the other compounds where rioting is taking place until the riot control force is free to subdue offenders. If another alert force is available, it channels additional rioters to a different area than the original rioters.

## RECORD OF EVENTS

B-36. Initiate a record of events to provide a basis for preparing and submitting a formal report to higher headquarters. Include the—

- Time the incident was reported and by whom.
- Time the enclosure commander reported to his commander.
- Time the riot control force was alerted.
- Time the riot control force commander reported to the affected enclosure.
- Time the riot control force entered the enclosure.
- Weather conditions as they relate to the use of riot control munitions, the types and amounts used, and their results and effects.
- Number of US personnel injured or killed, a description of how they were injured or killed, and the medical attention they received.
- Number of housed personnel injured or killed, a description of how they were injured or killed, and the medical attention they received.
- Time the operation was completed and when the riot control force cleared the enclosure.

## RIOT CONTROL MEASURES

B-37. The commander exercises effective control of internees by quickly restoring order. Have a well-developed, well-rehearsed plan for defusing tense situations, handling unruly captives, and quelling riots. Because of the differences in I/R facilities, consider the—

- Terrain features.
- Types of structures.
- Number of internees.
- Size of control forces.

B-38. Restore order using the least amount of force possible. The PSYOP resources often play an effective role in restoring order to the compound. If necessary, use riot control agents (CS and OC) and NLWs to incapacitate rioters.

B-39. Preplan riot control measures before a crisis occurs. Control forces will be prepared to react in an emergency and can successfully contain and neutralize the situation. The preplanning process includes training, planning, and intelligence gathering.

## **TRAINING**

B-40. Train the QRF and associated teams in the five basic riot control formations—line, wedge, echelon, diamond, and circle—on a regular basis. Establish a continuous training program that includes—

- Law of land warfare principles, specifically the provisions of the Geneva Conventions.
- Supervisory and human relations techniques.
- Self-defense methods.
- The use of force (riot batons, M16 with and without bayonet, and fatal areas of the body to avoid when using them).
- Weapons familiarization and qualification.
- Public relations.
- First aid.
- Emergency plans.
- Compound regulations.
- Intelligence and counterintelligence techniques.
- Cultural customs, habits, and religious practices.
- Simple training in internees' language.
- The use of riot control agents and the various methods of dispersing them.
- The use of NLWs.

B-41. Ensure that personnel assigned or attached to I/R facilities are oriented and specially trained in the custody and control of EPWs and CIs. Everyone working in the compound must be fully cognizant of the provisions of the Geneva Conventions as they apply to EPWs, CIs, and soldiers who are guarding prisoners.

## **PLANNING**

B-42. The planning process begins during the preplanning process. When the QRF is alerted of a riot situation, leaders and members further develop preplans to fit the situation. This planning process is essential to successfully contain and neutralize a riot. When using riot control agents, ensure that plans are flexible enough to accommodate changes in the situation and weather. Consider the strict accountability and control required when employing riot control agents. They can be employed only when the commander specifically authorizes their use, and their use must be reported.

B-43. Other planning factors to consider are the weather; the cause, nature, and extent of the disturbance; and the demeanor and intent of the gathered EPWs. Based on an analysis of these factors, the commander makes an estimate (as thorough as time permits) of the situation. He considers a course of action, selects riot control agents, and determines munition needs.

B-44. Plans also address the security of riot control agents during storage, transportation, and employment. The wind direction, the size of the area, and the proximity of civilian communities may preclude the use of large quantities of riot control agents. In such cases, it may be necessary to use low concentrations to break up a crowd into smaller groups.

B-45. When dealing with a large group of rioting EPWs, plans should indicate how the control force channels and controls EPW movement in a specific direction. This is usually to an area where another force is waiting to receive, hold, and search them. Include information on how riot control agents are employed to cover the target area with a cloud of sufficient strength to produce desired results. Once the proper concentration is reached, the control force maintains the concentration until rioters are channeled into the predetermined area. When dispersers are used, the dispersal team maintains the concentration by moving along the release line at an even rate and repeating the application as necessary.

B-46. During a riot, another riot may start in a neighboring compound, so ensure that contingency plans are in place to subdue it also. Quell the most riotous compound first, and then move to the next. Employ riot control teams to contain other compounds where rioting is taking place until a riot control force is free to subdue them.

B-47. Include serious-incident reporting procedures in riot control plans. Initiate a record of events to provide a basis for preparing and submitting a formal report to higher headquarters. (See paragraph B-36.)

## **INTELLIGENCE GATHERING**

B-48. The preplanning process also includes intelligence gathering. It includes maintaining updated drawings of the I/R compound and identifying potential threats from within the EPW population. (See Chapter 3.)

## **RIOT CONTROL AGENTS**

B-49. There are two riot control agents used to quell riots and disperse crowds. They are CS and OC.

### **O-CHLOROBENZYLIDINE-MALONITRILE**

B-50. The CS is effective in very small quantities, and its effect on eyes and respiratory systems are realized within seconds. It causes an extreme burning sensation in eyes, an abundant flow of tears, coughing, breathing difficulty, tightness in chest, involuntary closing of eyes, stinging sensation on moist-skin areas, and sinus and nasal drip. High concentrations also cause nausea and vomiting, especially when ingested. The effects last 5 to 10 minutes after individuals are removed from the contaminated area and placed

in a clean area. Exposure to CS makes individuals incapable of executing organized or concerted actions.

B-51. Administer first aid to victims by moving them to uncontaminated areas and facing them into the wind. Caution them not to rub their eyes, and keep affected people well apart. Have victims shower with cool water for 3 to 5 minutes and then proceed with normal showering. For gross contamination, flush victims' bodies with large amounts of cool water, wash them with a 5 percent sodium bisulfite solution (except in and around their eyes), and flush them again with water. (A 1 percent sodium carbonate or sodium bicarbonate solution can be substituted for the sodium bisulfite solution.)

B-52. The CS is delivered by a variety means—bursting, aerosol, 37-millimeter and 12-gauge projectiles, and fogging. It has the greatest effect when there is little or no wind, and effectiveness is greatly diminished by rain. The persistency of CS varies according to wind conditions. The powder form persists longer in still air and in wooded terrain, and it should not be used in areas where lingering contamination could cause problems.

## **OLEORESIN CAPSICUM**

B-53. The OC provides a safe, effective alternative to traditionally employed riot control agents. When used properly, it turns the most violent offender into a docile, cooperative individual who no longer poses a threat to others. It diverts the threat's attention from making or continuing an assault. **NOTE: HN laws may prohibit or restrict the use of certain chemical compounds, such as OC.**

B-54. The OC is not a chemical agent, but it is 750 times more powerful than CS. It is an organic, naturally occurring, inflammatory compound that is derived from a blend of 300 varieties of pepper plants. As an inflammatory agent, OC causes swelling of eyes and breathing passages almost immediately. When inhaled, the respiratory tract is inflamed and breathing is restricted to short, shallow breaths. However, it does not shut down the respiratory system. The physiological response increases OC's effectiveness, regardless of the subject's emotional or physical state. It is effective against emotionally disturbed individuals, persons under the influence of drugs or alcohol, and domestic and wild animals.

B-55. The OC causes intense burning of exposed skin, dilation of capillaries, swelling of eyelids, burning and involuntary closing of eyes, uncontrollable coughing, gagging, gasping for air, temporary loss of strength and coordination, and a change in skin color (slight to bright red). The effects of OC last 30 to 40 minutes after removal to fresh air. There is no permanent damage to the respiratory system, eyes, or skin.

B-56. There is a risk of fatalities in persons with preexisting respiratory or cardiac conditions. Ensure that medical support is readily available when using OC in a civilian/refugee situation to prevent injury or death if an individual fails to recover.

B-57. Disadvantages of OC include—

- Canisters will depressurize over time if they are not checked regularly.
- Criminals have access to OC and may use it against the control force.

- Canisters must be shaken on a regular basis.
- Individuals from cultures that use cayenne pepper on a regular basis may become immune to OC.
- Rain decreases the effectiveness and requires a longer spray duration.
- Strong winds decrease effectiveness and can result in blowback that might contaminate control forces.

## DISSEMINATION OF CHEMICAL IRRITANTS

B-58. There are five methods of dissemination for chemical irritants. They are pyrotechnic, bursting, aerosol, fogging, and a multipurpose grenade.

### Pyrotechnic

B-59. The irritant and an inert material are placed in a canister that is ignited when the device is activated. The irritant is carried into the air on smoke particles of the inert material. This method of dissemination has the following disadvantages:

- May cause a fire.
- Has a very slow saturation time.
- Takes 40 to 45 seconds to completely burn.
- Can be thrown back even while burning.

### Bursting

B-60. The irritant and an inert powder are contained in a serrated canister. After a small detonation, the canister splits and expels the irritant in the form of a cloud. This method of dissemination has the following advantages and disadvantages:

- **Advantages.**
  - Has no risk of fire.
  - Cannot be thrown back.
  - Disseminates quickly.
  - Is very effective, easy to carry, and easy to control.
- **Disadvantages.**
  - The canister may fragment when detonated.
  - The fuse head may separate from the canister.
  - The percentage of irritant disseminated is 50 to 90 percent.
  - The direction of the cloud formation depends on where the device is detonated.

### Aerosol

B-61. The irritant is suspended in an inert liquid located in the rear of a projectile. When the projectile strikes a structure and penetrates, the rear portion splits open and the irritant is disseminated in the form of a mist. The aerosol device is the most appropriate for tactical operations when chemical irritants are used before entry. This method of dissemination has the following advantages and disadvantages:

- **Advantages.**

- Is easy to carry and control.
- Can be deployed with 40-millimeter, 37-millimeter, or 12-gauge ammunition.
- Disperses contents quickly.
- Is accurate (fin-stabilized), but practice firing is necessary.
- **Disadvantages.**
  - May cause injury if fired from close range.
  - May strike a weak portion of a structure.

### **Fogging**

B-62. The irritant is suspended in a fogging solution and dispersed with a fogging machine. It is used for riot control and crowd dispersal. This method of dissemination has the following advantages and disadvantages:

- **Advantages.**
  - Is capable of producing enough irritant to cover 100,000 cubic feet of an enclosed area in 26 seconds.
  - Disseminates very quickly.
  - Has high-volume capabilities.
- **Disadvantages.**
  - Is too noisy for a close-in tactical situation.
  - Is cumbersome and not recommended for tactical operations.

### **Multipurpose Grenade**

B-63. A multipurpose grenade can be hand-thrown or launched from a shotgun with an adapter. It has an extended shelf life of 6 years and an adjustable fuse delay of 2 to 5 seconds. The irritant is located in the cylinder portion of the device and is forced out the bottom of the grenade upon detonation.

**WARNING**

**Injury to your hand may result if a multipurpose grenade is deployed incorrectly. Observe all safety rules.**

### **POSITIONS**

B-64. Riot control formations are usually equipped with riot batons, rifles (with or without bayonets), or shotguns. All personnel use the right hand grip when holding a baton or a weapon. This presents a uniform, formidable appearance to rioters, eliminates weak spots in the formation caused by inconsistent weapon positions, and is safer for soldiers in close movements. (See STP 19-95B1-SM for more information on individual movements and positions.)

---

## BATONS

B-65. Three steps are necessary to obtain a secure grip on the riot baton. This method of gripping the baton provides a secure grasp, and the baton can be released quickly by simply relaxing your hand.

**Step 1.** Place the thong of the baton around your right thumb.

**Step 2.** Hold the baton so that the thong hangs over the back of your hand.

**Step 3.** Roll your hand into the baton handle so that the thong is pressed against the back of your hand.

B-66. There are three baton positions used in riot control. They are parade rest, port, and on guard:

- **Parade rest position.** The parade rest position is a relaxed, ready position. Your feet are shoulder width apart, both arms hang naturally in front of your body, and the baton is horizontal. Your left palm is facing out, and your right palm is facing in toward your body. Your hands are about 6 inches from the ends of the baton.
- **Port position.** The port position is a ready position. It is particularly well suited for individual defense. Your right hand and forearm are parallel to the ground, and your left hand is level with your left shoulder. The striking end of the baton bisects the angle between your neck and left shoulder. The baton is held about 8 inches from your body, and your feet are shoulder width apart.
- **On-guard position.** The on-guard position is a ready position. Do not maintain it for long periods of time, because it is tiring. Your left foot is placed forward of your right foot. Your feet are spread apart, and your knees are slightly bent. Your right hand and the butt end of the baton are placed snugly against your hip. Your body is bent slightly forward at your waist. Your left arm is bent so that your forearm protects your throat area, yet allows a thrust to be made. From the on-guard position, soldiers can execute a—
  - **Short thrust.** Rapidly step forward with your left foot, and drive the striking end of the baton into a vulnerable point of the opponent's body. Return to the on-guard position after delivery.
  - **Long thrust.** Rapidly step forward with your right foot, and thrust the striking end of the baton into a vulnerable point of the opponent's body. Return to the on-guard position after delivery.
  - **Butt stroke.** Advance your body rapidly off your right foot, and snap the butt end of the baton to the left, striking the opponent's shoulder or jaw. Return to the on-guard position after delivery.

### Baton Smash

B-67. A baton smash can be delivered from a parade rest, port, or on-guard position. Hold the baton horizontal to the ground, about chest height. Advance your left foot rapidly, snap both arms straight, and smash the length of the baton across the opponent's chest. Return to the on-guard position after delivery.



## Fatal Areas

B-68. Do not use a riot baton to strike a fatal area (the head, the side of the neck, the throat, the heart area, or the armpit). Do not raise a riot baton above your head to strike an adversary in club fashion. It is likely to cause permanent injury and also projects an unfavorable image of the control force.

B-69. Soldiers use riot batons to defend themselves against armed and unarmed attackers. Use the baton to block or deflect an opponent's blow; then counter with a thrust, a butt stroke, or a baton smash. These defensive techniques can be performed from any position.

**NOTE: See FM 19-15 for detailed information on using a riot baton.**

## WEAPONS

B-70. There are three weapon positions used in riot control—safe-port, safeguard, and on-guard positions.

- **Safe-port position.** The safe-port position is quite effective when making a show of force. It is similar to the port arms position in FM 22-5, except the weapon is raised until your left, upper arm is parallel with the ground. In this elevated position, participants in the rear of the crowd can see bayonets. The sight of bayonets creates an impression of strength and numerical superiority. Do not keep troops in this position long because it is very tiring. The control force moves into and assembles from all riot control formations with weapons in the safe-port position. Upon receiving the preparatory command to move into or assemble from a riot control formation, soldiers assume the safe-port position.
- **Safeguard position.** This is a position of semireadiness. It is less tiring than the on-guard position and is used to rest troops when circumstances permit. As troops advance, they maintain the safeguard position until contact is made or resistance is expected. The safeguard position is also used when troops are pursuing a crowd that is withdrawing without resistance. In the safeguard position, your right hand is against the right side of your waist, and the weapon is pivoted forward until the bayonet is at the crowd's throat level.
- **On-guard position.** This is a position of complete readiness. It is used when troops are in contact with a group that is showing resistance or hesitation to withdraw. Assume the on-guard position from the safeguard position. Place your feet a comfortable distance apart, and align your left heel with your right toe. Bend your knees slightly and lean forward at your waist, keeping the bayonet at throat level. Do not keep troops in this position long because it is very tiring. Rest troops when circumstances permit.

## FORMATIONS

B-71. The five basic formations for riot control operations are line, wedge, echelon, diamond, and circle. Apprehension teams normally use diamond and circle formations. Small teams, squad-sized elements, and augmented squads

are not used for crowds, but they are used by larger riot control forces to snatch or protect.

B-72. Line, wedge, and echelon formations are trained at squad level and above; but they are normally used by platoon- and company-sized units. Squad line, echelon left, echelon right, and wedge formations are the basis for platoon and company formations. Each squad must be adept in the basic formations before practicing in platoon-sized or larger formations. Any size unit can be employed, and a riot control formation can be adapted to fit a unit's organization. (See STP 19-95B1-SM for more information on formations.)

B-73. The platoon headquarters for riot control formations consists of a platoon leader, a platoon sergeant, a selected marksman, and a radio operator or messenger. Figure B-1 shows symbols for a formation element. When directed by the platoon leader, disperser operators, firefighters, and others may augment the platoon headquarters.

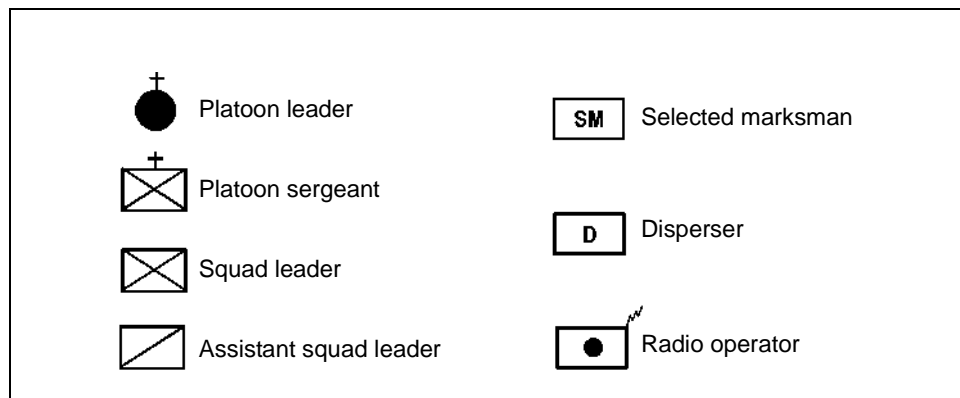


Figure B-1. Symbols for a Formation Element

B-74. The control force moves to the site of a disturbance in a column formation and then executes a riot control formation on site. To form a riot control formation from a column formation, the platoon leader moves to the right of the platoon and faces troops when giving commands. He gives the arm-and-hand signal and the preparatory command. On the execution command *MOVE*, he points to the approximate location where he wants the platoon to form. The platoon leader pauses between the preparatory command and the execution command to allow each squad leader to issue a preparatory command to his squad.

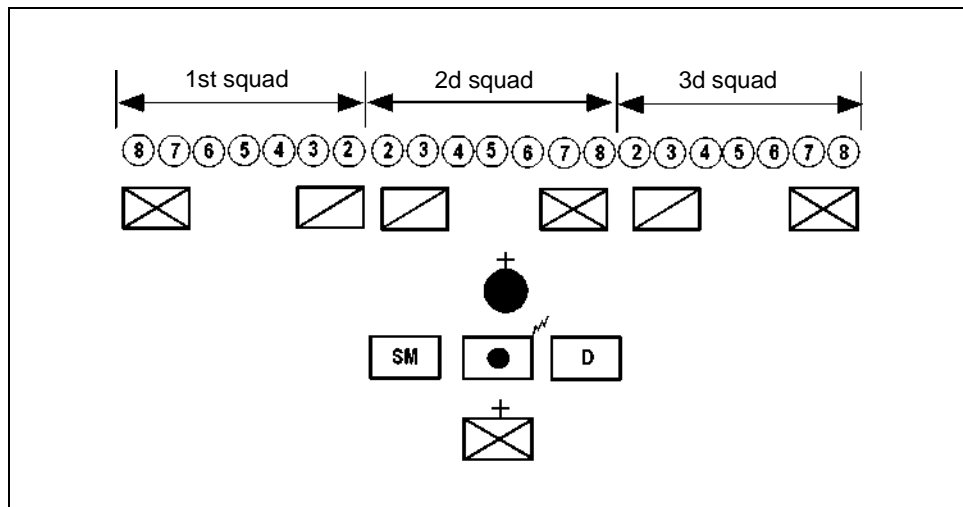
B-75. In a three-squad platoon, the first and third squads are usually the lead elements in formations when one squad provides general or lateral support. The support squad, when held in general support, may be in a single column or a column of twos. The following examples presume that the second squad is the support squad.

B-76. When the support squad moves from general support to lateral support or to extend the existing formation, the even-numbered members move to the right and the odd-numbered members move to the left. The squad leader

usually controls the even-numbered members, and the assistant squad leader controls the odd-numbered members. To assemble the support squad from any position to general support, the platoon leader commands *SECOND SQUAD IN SUPPORT, MOVE*. The second squad then returns to a column behind the line formed by the other two squads.

**LINE FORMATION**

B-77. The line formation (Figure B-2) is used the most because of its offensive and defensive applications. As an offensive formation, it is used to push or drive crowds straight back, across an open area, or up a city street. As a defensive formation, it is used to hold crowds or deny access to restricted streets or areas.



**Figure B-2. Line Formation**

B-78. The command for forming a platoon line is *PLATOON AS SKIRMISHERS, MOVE*. The second squad moves forward to the point designated by the platoon leader. The number two man of the second squad is the baseman for the platoon formation. The—

- Second squad forms a squad line to the right of the baseman.
- First squad forms a squad line to the left of the second squad.
- Third squad forms a squad line to the right of the second squad.
- First and third squads dress on the second squad.

B-79. When assembling a platoon from the line formation, the platoon leader and headquarters personnel take a position to the rear of the platoon. The platoon leader gives the command *PLATOON ASSEMBLE, MOVE*. He raises his right arm and makes a circular motion above his head. The squad leader of the second squad commands *FOLLOW ME* and double-times to the designated spot. Other squad members follow the squad leader. As the second squad clears the line formation, the first and third squad leaders command *FOLLOW ME* and double-time toward the platoon leader, dressing on either

side of the second squad. All squads halt automatically behind the platoon headquarters and dress.

### WEDGE FORMATION

B-80. The wedge formation (Figure B-3) is an offensive formation that is used to penetrate and split crowds. The command for forming the platoon wedge is *PLATOON WEDGE, MOVE*. The second squad executes a squad wedge at the point designated by the platoon leader. The squad wedge consists of an echelon left of the odd-numbered members and an echelon right of the even-numbered members, with the baseman at the apex of the wedge. The first and third squads form echelons left and right, respectively, of the second squad.

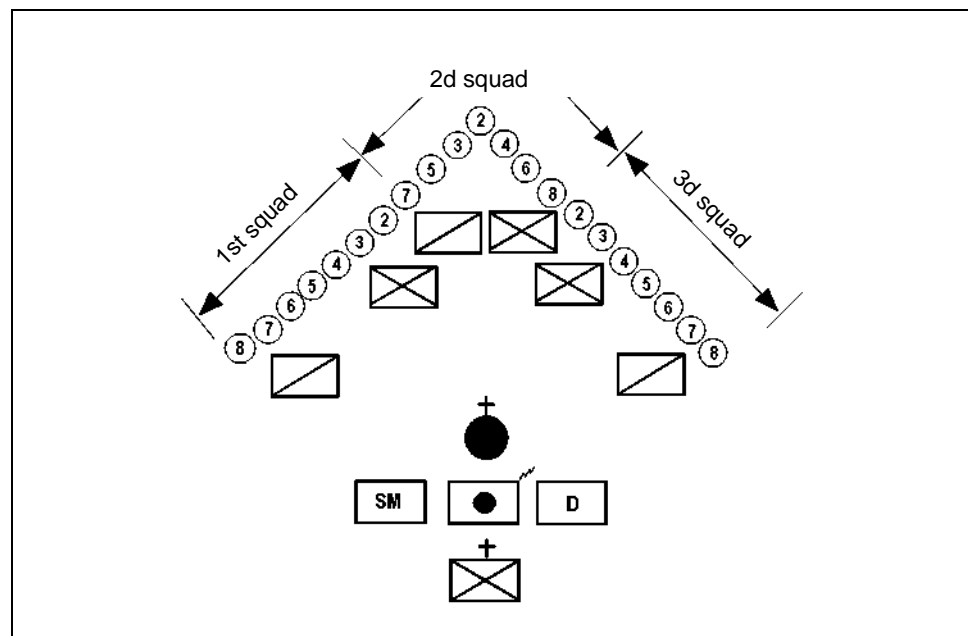


Figure B-3. Wedge Formation

B-81. Assembling from a wedge formation is similar to assembling from a platoon echelon. The second squad assembles first. On the command *PLATOON ASSEMBLE, MOVE*, the second squad leader moves to the point designated by the platoon leader. The second squad assembles behind the squad leader in numerical order. The first and third squads move into column formation to the left and right of the second squad, respectively, and dress on the second squad.

### ECHELON FORMATION

B-82. The echelon formation (Figure B-4, page B-20) is an offensive formation. It is used to turn or divert groups in open or built-up areas and to move crowds away from buildings, fences, and walls. An echelon formation can be an echelon right or an echelon left, depending on the direction in which the crowd is to be moved.

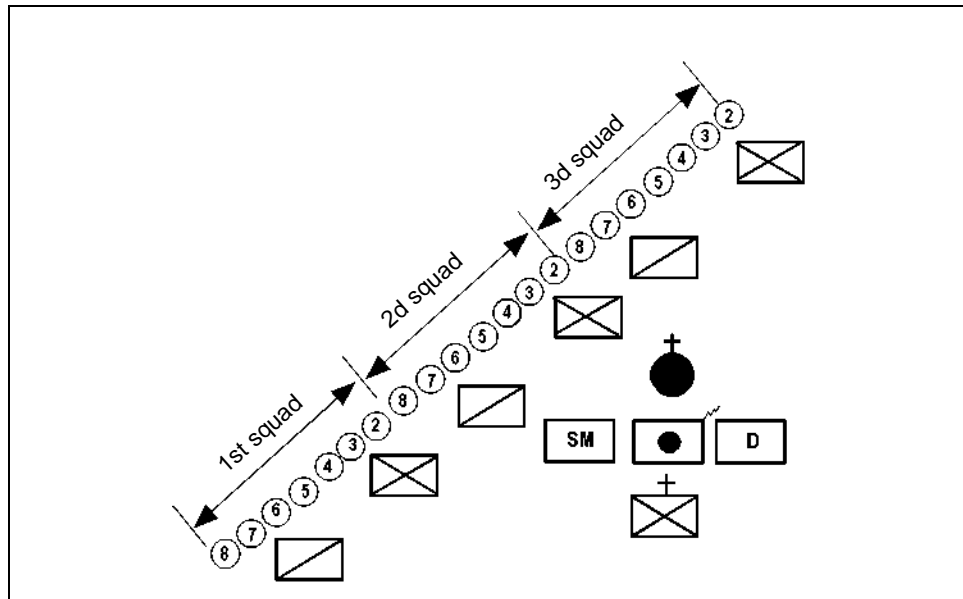


Figure B-4. Echelon Left Formation

### Platoon Echelon Left

B-83. The command for forming a platoon echelon left is *PLATOON ECHELON LEFT, MOVE*. The third squad baseman posts himself at the location designated by the platoon leader. Remaining squad members position themselves one step back and one step to the left of the preceding soldier. As each squad clears the column, the next successive squad moves out and extends the echelon that has been formed.

B-84. To assemble the platoon from an echelon left, the commander takes his position to the rear of the formation with the platoon headquarters. On the command *PLATOON ASSEMBLE, MOVE*, the third squad moves and forms a column at the point designated by the platoon leader. The first and second squads assemble in column formation to the left of and dressed on the third squad.

### Platoon Echelon Right

B-85. The command for forming a platoon echelon right is *PLATOON ECHELON RIGHT, MOVE*. The first squad baseman posts himself at the location designated by the platoon leader. Remaining squad members position themselves one step back and one step to the right of the preceding soldier. As each squad clears the column, the next successive squad moves out and extends the echelon that has been formed.

B-86. To assemble a platoon from an echelon right, the commander takes his position to the rear of the formation with the platoon headquarters. On the command *PLATOON ASSEMBLE, MOVE*, the first squad moves and forms a column at the point designated by the platoon leader. The second and third squads assemble in column formation to the right of and dressed on the first squad.

## DIAMOND FORMATION

B-87. The diamond formation (Figure B-5) can be used as an offensive formation or a defensive formation. It is used by riot control forces when they enter a crowd to apprehend ringleaders. The diamond formation is also useful when 360-degree security is needed.

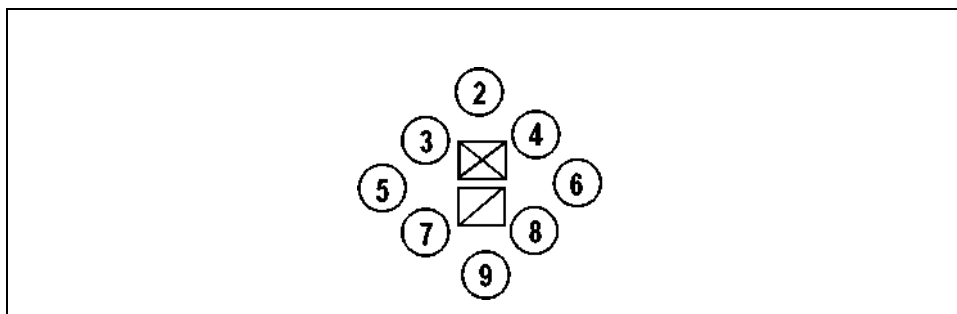


Figure B-5. Diamond Formation

## CIRCLE FORMATION

B-88. The circle formation (Figure B-6) is used for the same purposes as a diamond formation. It is used for dispersed and nonviolent crowds, where the diamond formation is used when the formation must break into or out of a crowd.

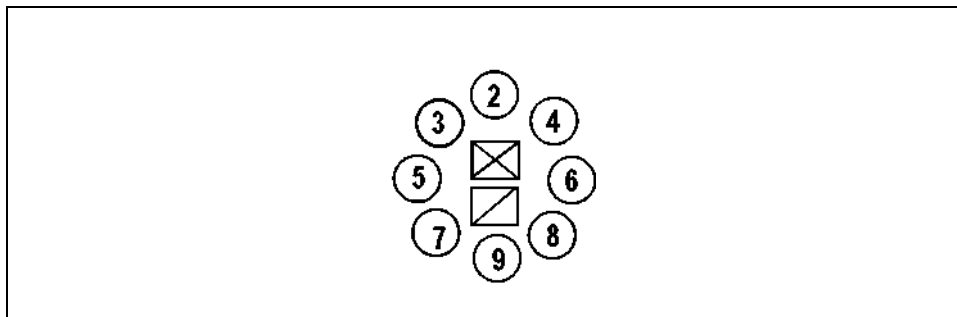


Figure B-6. Circle Formation

## VARIATIONS

B-89. Many suitable variations of riot control formations can be employed. Ensure that appropriate commands and signals are devised to execute the formations. Due to their complicated nature and the coordination required, practice the formations extensively before actually using them in a riot.

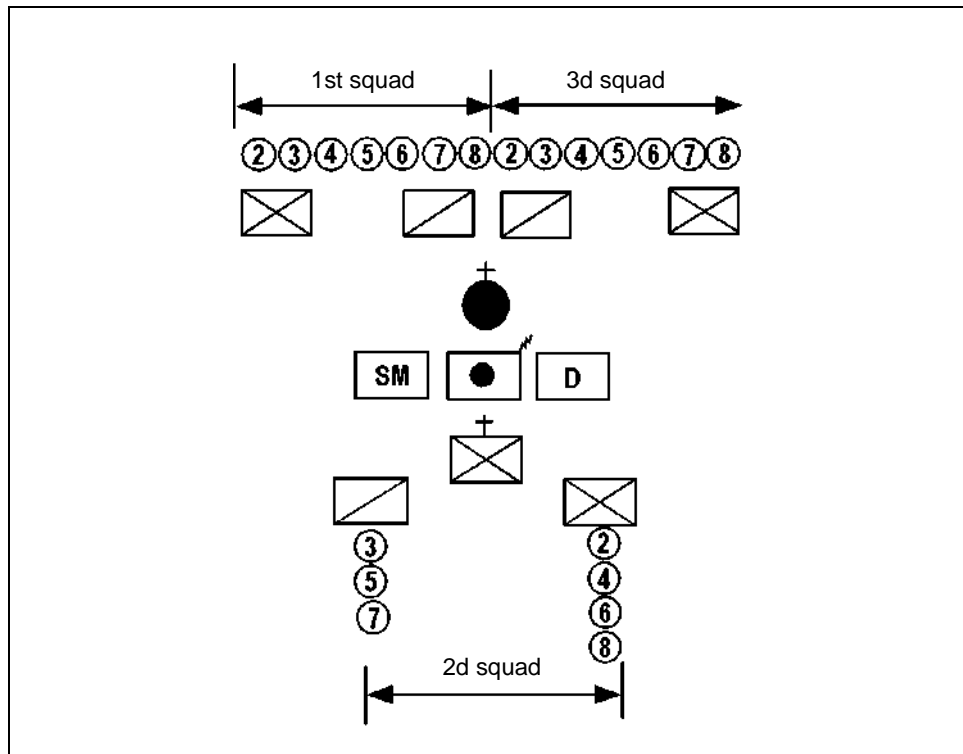
## FORMATION ENHANCEMENTS

B-90. Riot control formations may require enhancement. They can be very tiring and stressful for troops on line, especially when faced with a hostile crowd. The crowd may try to break through the control force to reach a protected facility or to disrupt the efforts of the control force. Likewise, a

determined crowd may refuse to give way to an advancing control force if they believe the line is not solid. Other elements of the control force can be positioned in general, lateral, or close support of the main line as needed. When all the troops in the unit are not required on line at the same time, the remaining elements can be kept in general support. Elements in general support are immediately available to provide lateral or close support as the situation changes.

**Platoon Formation With General Support**

B-91. The command for forming a platoon formation with a squad in general support (Figure B-7) is *PLATOON AS SKIRMISHERS (ECHELON LEFT, ECHELON RIGHT, WEDGE), SECOND SQUAD IN SUPPORT, MOVE*. The first and third squads execute the formation, and the second squad remains in column formation. The number two man of the third squad is the baseman for the formation.



**Figure B-7. Platoon Line, 2d Squad in General Support**

B-92. The command for forming a platoon formation with one squad in general support in a column of twos is *PLATOON AS SKIRMISHERS (ECHELON LEFT, ECHELON RIGHT, WEDGE), SECOND SQUAD IN SUPPORT IN COLUMN OF TWOS, MOVE*. The first and third squads execute the formation. The second squad, at the command of its squad leader, executes a column of twos to the right.

B-93. To assemble a platoon with a squad in general support, the procedure is the same as for a formation without support, except the second squad does a countercolumn. The third squad then dresses on the right of the second squad, and the first squad dresses on the left of the second squad.

### Platoon Formation With Lateral Support

B-94. Troops deployed in lateral support (Figure B-8) extend the sides of a formation and prevent access to the rear of the formation. The command for forming a platoon formation with lateral support is *PLATOON AS SKIRMISHERS (ECHELON LEFT, ECHELON RIGHT, WEDGE), SECOND SQUAD IN LATERAL SUPPORT, MOVE*. The first and third squads execute the formation, while the second squad stands fast. When the formation is formed, the odd-numbered members of the second squad form in column formation behind the last man of the first squad and the even-numbered members form in column formation behind the last man of the third squad.

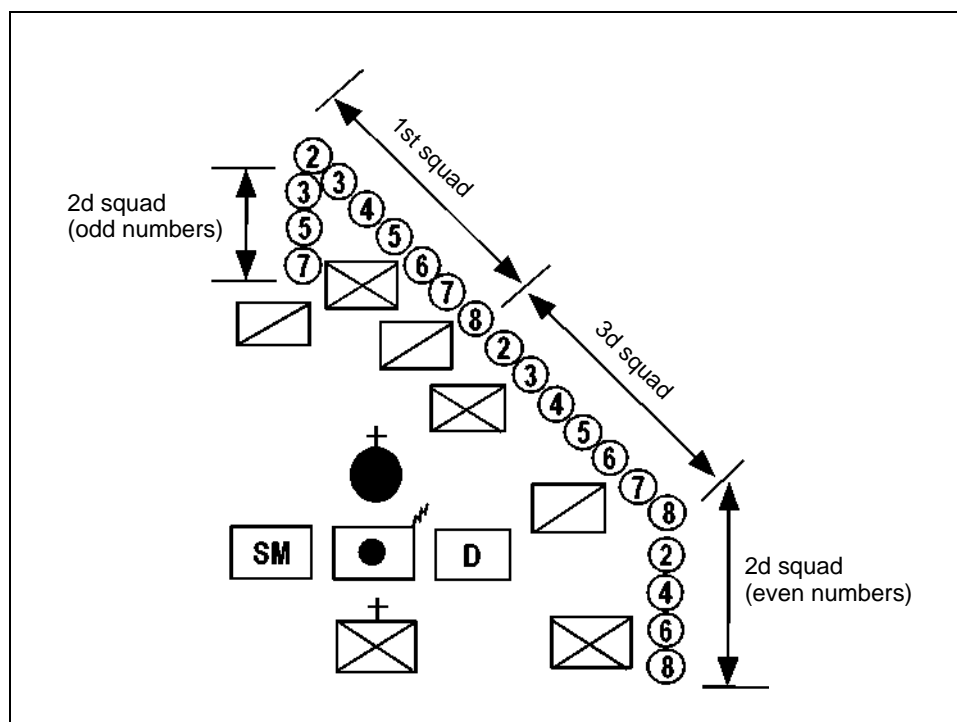


Figure B-8. Platoon Echelon Right, 2d Squad in Lateral Support

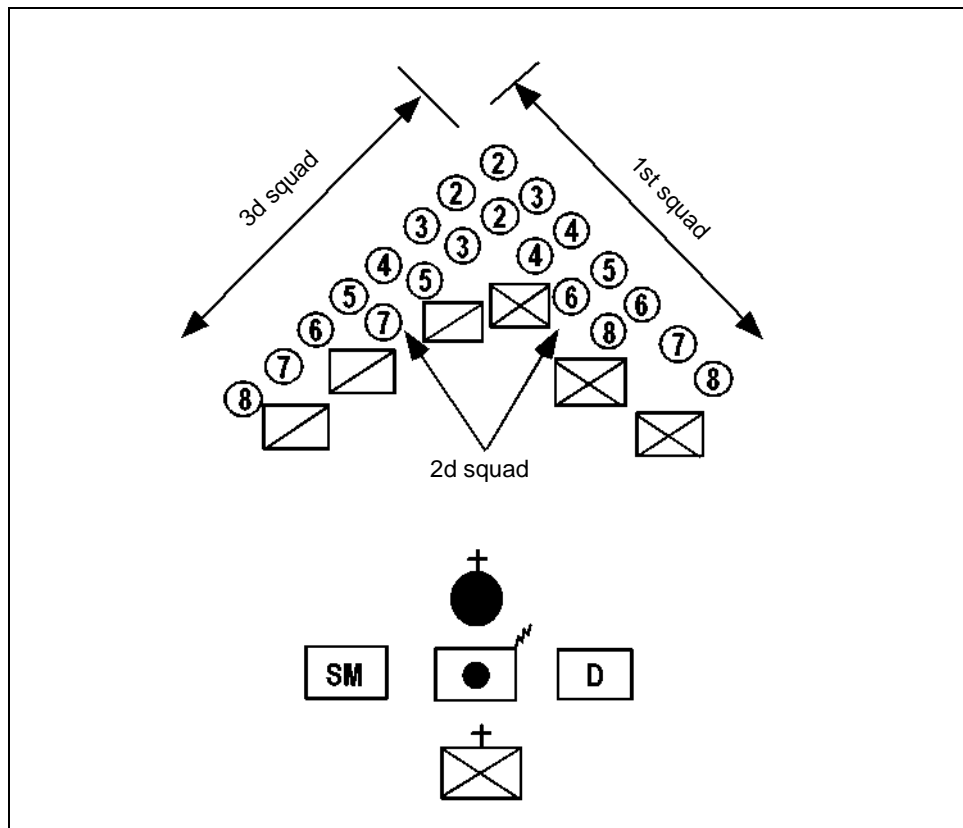
B-95. To move the second squad from general support to lateral support, the platoon leader commands *SECOND SQUAD, LATERAL SUPPORT, MOVE*. To have the second squad join the formation from general or lateral support, the platoon leader commands *SECOND SQUAD, EXTEND THE LINE (WEDGE), MOVE*. The second squad moves out—odd-numbered members to the left and even-numbered members to the right—to extend the formation of the first and third squads.



B-96. To assemble the platoon from a platoon formation with lateral support is nearly the same as for the platoon line. However, the number two men of the second and third squads do a right face and a left face, respectively, toward their squad leaders. On the execution command, the first and third squads move to the point designated by the platoon leader. As the first and third squads clear the formation, the second squad moves.

**Platoon Formation With Close Support**

B-97. Troops in close support (Figure B-9) reinforce the line to prevent the crowd from breaking through the control force. This is done by putting a second line of soldiers at a close interval behind the lead element, covering the interval between the soldiers in the lead formation.



**Figure B-9. Platoon Wedge, 2nd Squad in Close Support**

B-98. The command for forming a platoon formation with a squad in close support is *PLATOON AS SKIRMISHERS (ECHELON LEFT, ECHELON RIGHT, WEDGE), SECOND SQUAD IN CLOSE SUPPORT, MOVE*. The first and third squads execute the primary formation. After the first and third squads are in position, the second squad executes the same formation to the rear of the first formation and closes in on it. The soldiers in the supporting formation shift to cover the intervals between soldiers in the first formation.

## Vehicles

B-99. When a control force encounters large riot groups, they can employ vehicles and troops on foot in riot control formations. Employ armored vehicles when practical because they have a strong psychological effect and offer protection for occupants. Consider the following when using vehicles in riot control formations:

- A windshield with safety glass offers some protection in the upright position and minimizes the danger of injury from glass fragments. However, if paint or other obscurants strike the glass, the operator may be unable to see well enough to operate the vehicle safely.
- A wooden or metal frame strung with razor wire and mounted across the front of a vehicle enhances the vehicle's usefulness as a mobile barrier and increases its psychological impact.
- A dismounted formation walking alongside the vehicle may be needed to keep rioters from reaching the sides and rear of the vehicle.

## Formation Variations

B-100. During riot control operations, the platoon leader may rotate squads in the lead elements of the formation to give them a rest. He is not limited to using only the squads specified in the preceding examples as the lead elements. By changing the preparatory command, he can choose other squads to lead the unit. For example, if he wants the first and second squads to lead a platoon wedge, he issues the command *PLATOON WEDGE, THIRD SQUAD IN SUPPORT, MOVE*. By designating the support squad in the preparatory command, the platoon leader tells the remaining squads that they will lead the formation.

B-101. The platoon leader may also relieve squads in the lead element by forming the same formation with support squads. The support element then passes through the lead element. This procedure is often necessary when soldiers don protective masks to employ riot control agents.

## COMMANDS

B-102. Commands can be given to riot control units in formation orally or with hand signals. Normally, both verbal and nonverbal commands are given. All formation commands are given in two counts—a preparatory command followed by an execution command. All movements into or recovering from riot control formations are performed at the halt.

B-103. The formation commander faces the troops and gives the preparatory oral command, accompanied by the appropriate visual command. On the execution command, the leader drops both arms and points to the position where he wants the element to form. The formation commander gives the following visual commands:

- **Echelon left.** Extends left arm upward at a 45-degree angle and right arm downward at a 45-degree angle, simulating the intended formation.

- **Echelon right.** Extends right arm upward at a 45-degree angle and left arm downward at a 45-degree angle, simulating the intended formation.
- **Line formation.** Extends both arms parallel to the ground.
- **Wedge formation.** Extends both arms downward at a 45-degree angle, forming a wedge.
- **Diamond formation.** Extends both arms above his head, bending elbows slightly and touching fingertips together.
- **Circle formation.** Extends both arms above his head, bending elbows slightly and touching fingertips together, then makes a circular motion with his right hand.
- **Assemble from a riot control formation.** Extends right arm upward and makes a circular motion.

B-104. The oral rifle commands for safe port, safeguard, and on guard and the baton commands for parade rest, port, and on guard are given in one count. Do not rely on oral commands completely, especially with the added noise from vehicles, helicopters, and crowds. Plan to use alternate methods for relaying commands.

B-105. While in the assembly area, each squad leader has his squad count off. The squad leader is always number 1, and the baseman for the formation is number 2. The number each soldier is assigned during the count off determines his position in his unit's control formation. The unit marches in column formation from the assembly area to the disturbance site. It halts a reasonably safe distance from the crowd, within plain view of it. The on-site commander decides the riot control formation to use and the size of the element to commit.

B-106. On the preparatory command, troops assume the safe-port position. On the execution command, troops form the formation with the baseman posting himself at the location pointed to by the element leader. As troops reach their proper positions, they face the direction of the unit's intended advance and come to a halt. They remain halted in the safe-port position and await further orders. Once the troops are in the riot control formation, the commander commands *SAFEGUARD* and issues the proclamation. Following the proclamation, the commander informs disturbance participants that they have a specific time in which to comply with the order to disperse. If participants fail to disperse within the given time, the commander employs measures needed to disperse the crowd.

B-107. When a rifle-equipped formation is commanded to safeguard or on guard, the commands are for the lead element only and the support elements come to port arms. Similarly, when a baton-equipped formation is commanded to port or on guard, the general or lateral support elements assume the port position. Members of support elements give a resounding stomp with their left feet when the lead element goes to on guard. On the command *FORWARD, MARCH*, the support element maintains the same half step as the lead element.

---

## CADENCE

B-108. The usual cadence for moving troops is as follows:

- **Into and out of a riot control formation.** Double time (180 steps per minute). Troops are at safe port with a rifle or at port with a baton when performing these maneuvers.
- **Safeguard position.** Quick time (120 steps per minute).
- **On-guard position.** Cadence is 60 steps per minute. For psychological effect, troops usually accentuate each left step with a stomp.

B-109. The commander may increase or decrease cadence depending on the situation. For example, he may order quick time to keep pressure on a crowd that is withdrawing. He halts a formation moving in the on-guard position by commanding *PLATOON (SQUAD/COMPANY), HALT*. The command of execution is given on the left foot. On the command *HALT*, each soldier in the formation brings his right foot forward, even with his left foot, then takes one more half step with his left foot. He stomps his left foot as he comes to a halt and remains in the on-guard position.

## INTERVAL DISTANCE

B-110. The usual interval distance between soldiers in riot control formations is one pace or 30 inches but it can be adjusted for particular situations. A 30-inch interval may not be sufficient in some situations and may have to be lengthened. Some police forces have found that a greater interval makes formation members less vulnerable to thrown objects.

## COMMANDER AND LEADER POSITIONS

B-111. When a unit is in a column formation, each echelon commander usually takes a position at the head of the column. In riot control formations, the element leader takes a position where he can best direct and control the unit. The senior formation commander normally centers himself and his staff behind the formation. Subordinate leaders position themselves where they can best control their soldiers within the formation. For diamond and circle formations, the squad leader and the assistant squad leader place themselves in the center of the formation. These are only guidelines, and leaders can adjust positions with respect to their units as they see fit.

B-112. In column formations, messengers, radio operators, marksmen, disperser operators, and other platoon headquarters members usually take positions at the front of the column. In riot control formations, headquarters personnel can be positioned near the commander at his discretion. If the situation does not allow this, headquarters personnel can be positioned behind the control element.

## Appendix C

# Equipment Guide

Table C-1 lists equipment that may be issued to EPWs when their clothing becomes unserviceable. (See CTA 50-900 when determining what clothing to issue EPWs.) Sundry packs and recreation equipment are also needed, and the facility commander arranges for them through supply or local purchase.

**Table C-1. Individual Equipment**

Line Item No.	Item, Basis of Issue, and Remarks	Unit	Allowances by Zone						
			I <sup>1</sup>	II <sup>2</sup>	III <sup>3</sup>	IV <sup>4</sup>	V <sup>5</sup>	VI <sup>6</sup>	VII <sup>7</sup>
B60252	Belt, trousers, cotton webbing, 1 1/4", per EPW	EA	1	1	1	1	1	1	1
C06886	Boot, combat, men's, leather, black, 8 1/2" high, per EPW	PR	1	1	1	1	1	1	1
C32182	Buckle, belt, trousers, brass, lacquered finish, per EPW	EA	1	1	1	1	1	1	1
C03750	Cap, hot weather, polyester/rayon, OG 106, per EPW	EA	1	1	1	1	1	1	1
NA	Cap, wool, knit, per EPW	EA	0	0	1	1	1	1	1
G48939	Drawers, men's, cotton, thigh length, white, with elastic waistband, per EPW	PR	2	2	2	2	2	2	2
G49213	Drawers, men's, wool knit, ankle length, silver gray, per EPW	PR	0	0	2	2	2	2	2
J62858	Glove inserts, wool and nylon knit, OG 108, per EPW	PR	0	0	1	1	1	1	1
J63269	Glove shells, leather, black, per EPW	PR	0	0	1	1	1	1	1
K35007	Helmet, sun, adjustment chin strap, adjustment head size, per EPW	EA	1	1	1	0	0	0	0
L70789	Liner, wet weather, poncho, camouflage color, per EPW	EA	0	1	0	0	0	0	0
P17415	Poncho, coated, nylon, OG 207, per EPW	EA	1	1	1	1	1	1	1
T03520	Shirt, men's, cotton sateen, OG 107, per EPW	EA	0	0	2	2	2	2	2
T04205	Shirt, men's, wool, nylon flannel, OG 108, per EPW	EA	0	0	2	2	2	2	2
T93335	Sock, men's, wool, cushion sole, OG 408, stretch type, per EPW	PR	4	4	4	4	4	4	4

**Table C-1. Individual Equipment (continued)**

Line Item No.	Item, Basis of Issue, and Remarks	Unit	Allowances by Zone						
			I <sup>1</sup>	II <sup>2</sup>	III <sup>3</sup>	IV <sup>4</sup>	V <sup>5</sup>	VI <sup>6</sup>	VII <sup>7</sup>
X36358	Trousers, men's, cotton sateen, OG 107, per EPW	PR	2	2	2	2	2	2	2
X37180	Trousers, men's, wool serge, OG 108, per EPW/RP	PR	0	0	2	2	2	2	2
B72225	Blanket, bed, wool, OG, per EPW	EA	1	1	2	2	3	3	3
NA	Brassard, Red Cross, per RP	EA	2	2	2	2	2	2	2
F54817	Cup, water, canteen, steel, per EPW	EA	1	1	1	1	1	1	1
N53095	Pan, mess kit, per EPW	EA	1	1	1	1	1	1	1
<sup>1</sup> Zone I—Warm or hot all year. <sup>2</sup> Zone II—Warm or hot summers, mild winters. <sup>3</sup> Zone III—Warm or hot summers, cold winters. <sup>4</sup> Zone IV—Mild summers, cool winters. <sup>5</sup> Zone V—Warm or hot summers, cold or very cold winters. <sup>6</sup> Zone VI—Mild summers, cold winters. <sup>7</sup> Zone VII—Mild summers, very cold winters.									

## Appendix D

# Military Police Internment/Resettlement Units

Table D-1 provides a synopsis of the various MP I/R units that may be assigned to the TO.

**Table D-1. MP I/R Units**

Unit	TOE	Assigned To	Duties
HHC, MP command (I/R)	19641L000	FORSCOM in CONUS and TSC OCONUS	Provides C <sup>2</sup> , staff planning, and supervision of I/R operations performed by assigned and attached MP elements.
HHC, MP brigade (I/R)	19762L000	TSC	Provides command, staff planning, and supervision of I/R operations performed by assigned and attached I/R MP elements.
MP detachment, I/R team (C <sup>2</sup> )	19543LH	I/R brigade	Provides C <sup>2</sup> , staff planning, and supervision of two or three I/R battalions that process and intern 12,000 or fewer people.
MP detachment, I/R team (I/R brigade liaison team)	19543LD	MP brigade (I/R)	Provides the following when the brigade's span of control is exceeded: <ul style="list-style-type: none"> <li>• Extends the capability of the MP brigade (I/R) to plan and supervise collection, internment, and evacuation operations of EPWs, CIs, DCs, and US military prisoners.</li> <li>• Acts as a coordination link to allied and indigenous organizations to ensure that they are complying with the Geneva Conventions concerning EPWs and CIs.</li> <li>• Ensures that EPW operations in the TO follow US policies and directives, international agreements, and US policies implementing international law.</li> <li>• Is an essential link with HN forces securing EPWs, CIs, and DCs. Ensures that policies favorably consider the intent of the US to comply with international treaties pertaining to the care and handling of EPWs, CIs, and DCs.</li> </ul>
MP detachment, I/R information center	19643L000	I/R command, I/R brigade, or MP brigade	Receives, processes, maintains, disseminates, and transmits required information and data relating to EPWs, American PWs, CIs, and DCs within the TO.

Table D-1. MP I/R Units (continued)

Unit	TOE	Assigned To	Duties
MP detachment, I/R team (EPW/CI branch camp liaison)	19543LE	One per camp (northeast Asia only)	Provides a coordination link to allied and indigenous I/R facilities. Helps maintain proper custody and control of internees. Ensures that the provisions of US policies, publications, and directives; international agreements; US policies implementing international law; and the Geneva Conventions are fulfilled.
MP detachment, I/R team (EPW/CI processing liaison team)	19543LG	MP detachment, I/R team (I/R brigade liaison team)	Provides a coordination link to allied and indigenous forces. Establishes, organizes, and operates an I/R processing element within an I/R facility or, with an I/R battalion support team, at a location other than an I/R facility.
MP detachment I/R team (I/R processing squad)	19543LC	MP detachment, I/R team (I/R brigade liaison team) (for C <sup>2</sup> )	Provides processing capabilities for 8 internees per hour. One squad is assigned for every 200 internees requiring processing per day within a separate/independent corps, division, or brigade force as required.
HHC, MP battalion (I/R) (EPW/CI/DC)	19646L400 or 19546A and 19547AB(4)	I/R brigade in an AO	Provides C <sup>2</sup> , administrative, and logistics support to operate an I/R facility. Provides OPCON of attached units. Is capable of interning and supporting 4,000 EPWs and CIs or 8,000 DCs.
HHC, MP battalion (I/R)	19546A000	MP brigade	Provides command, staff planning, administration, and logistical support to operate an I/R facility for EPWs, CIs, or US military prisoners. Provides OPCON of assigned and attached units. Supervises battalion functions (personnel, medical, supply, and food services).
HHC, MP battalion (confinement)	19656L000	MP brigade	Provides command, staff planning, administration, and logistical support for a confinement facility for US military prisoners.
MP detachment (I/R) (confinement)	19547AA00	HHC, MP battalion (I/R)	Provides supervision, administration, health services, and logistical support for US military prisoners.



Table D-1. MP I/R Units (continued)

Unit	TOE	Assigned To	Duties
MP company (guard)	19667L000	I/R battalion	<p>Provides guards for EPWs, CIs, US military prisoners, DCs, and installations and facilities at an I/R facility.</p> <p>Is capable of securing 500 US military prisoners, 2,000 EPWs, 2,000 CIs, or 4,000 DCs in an I/R facility.</p> <p>Provides static guards at rail terminals and sensitive-material facilities (maximum 240,000 square yards).</p> <p>Provides food support for assigned personnel and collocated units.</p>
MP company (escort guard)	19647L000	I/R MP brigade	<p>Provides supervision and security for evacuating and moving EPWs, CIs, DCs, US military prisoners, and other detained persons via vehicles, trains, planes, and road marches.</p>

## Glossary

<b>AA</b>	Alcoholics Anonymous
<b>AC</b>	active component
<b>ACCP</b>	Army contingency communications package
<b>ACCP</b>	Army Correspondence Course Program
<b>ACS</b>	Army Corrections System
<b>ACT</b>	active duty
<b>admin</b>	administrative
<b>ADT</b>	active-duty tour
<b>AFJI</b>	Armed Forces Journal International
<b>AFR</b>	Air Force regulation
<b>AG</b>	adjutant general
<b>AICS</b>	Army Inmate Correction System
<b>AMEDD</b>	Army Medical Department
<b>AMS</b>	Army management structure
<b>AO</b>	area of operations
<b>AOR</b>	area of responsibility
<b>AR</b>	Army regulation
<b>ASD</b>	Assistant Secretary of Defense
<b>ATTN</b>	attention
<b>AWOL</b>	absent without leave
<b>BDU</b>	battle dress uniform
<b>BLD</b>	brigade liaison detachment
<b>BSA</b>	brigade support area
<b>BTOC</b>	brigade tactical operations center
<b>C<sup>2</sup></b>	command and control
<b>CA</b>	civil affairs

<b>CARE</b>	Cooperative for American Relief Everywhere, Incorporated
<b>CHA</b>	corps holding area
<b>CHS</b>	combat health support
<b>CI</b>	civilian internee
<b>CID</b>	criminal investigation division
<b>CINC</b>	commander in chief
<b>CMO</b>	civil-military operations
<b>co</b>	company
<b>COL</b>	colonel
<b>COMMZ</b>	communications zone
<b>CONUS</b>	continental United States
<b>COS</b>	civilian occupational specialty
<b>COSCOM</b>	Corps Support Command (US Army)
<b>CP</b>	collecting point
<b>CPT</b>	captain
<b>CRS</b>	Catholic Relief Services
<b>CRS</b>	Correctional-Reporting System
<b>CS</b>	o-chlorobenzylidene malonitrile
<b>CS</b>	combat support
<b>CSB</b>	correctional-supervision branch
<b>CSS</b>	combat service support
<b>CTA</b>	common table of allowance
<b>CTF</b>	correctional-treatment file
<b>CZ</b>	combat zone
<b>D</b>	dispenser
<b>D</b>	day
<b>DA</b>	Department of the Army
<b>DART</b>	disaster assistance response team
<b>DASD</b>	Deputy Assistant Secretary of Defense
<b>DC</b>	District of Columbia

---

<b>DC</b>	dislocated civilian
<b>DCAA</b>	dislocated-civilian assembly area
<b>DCSOPS</b>	Deputy Chief of Staff for Operations and Plans
<b>DD</b>	Department of Defense
<b>DFAS-IN</b>	Defense Finance and Accounting Service—Indianapolis
<b>DNBI</b>	disease and nonbattle injuries
<b>DOD</b>	Department of Defense
<b>DOJ</b>	Department of Justice
<b>DOMS</b>	Director of Military Support
<b>DOS</b>	Department of State
<b>DOT</b>	Department of Transportation
<b>DP</b>	displaced person
<b>DS</b>	direct support
<b>DSA</b>	division support area
<b>ea</b>	each
<b>EAC</b>	echelons above corps
<b>EBC</b>	echelons below corps
<b>EEI</b>	essential elements of information
<b>EGA</b>	electronically generated form
<b>EGCT</b>	extra good-conduct time
<b>EHP</b>	emergency home patrol
<b>EPW</b>	enemy prisoner of war
<b>ERA</b>	emergency rest area
<b>ES</b>	emergency services
<b>ESF</b>	emergency support function
<b>eval</b>	evaluation
<b>FBI</b>	Federal Bureau of Investigation
<b>FCF</b>	field confinement facility
<b>FDF</b>	field detention facility
<b>FEMA</b>	Federal Emergency Management Agency

<b>Five Ss and T</b>	search, segregate, silence, speed, safeguard, and tag
<b>FM</b>	field manual
<b>FMFM</b>	Fleet Marine Force manual
<b>FMFRP</b>	Fleet Marine Force reference publication
<b>FN</b>	foreign nation
<b>FORSCOM</b>	United States Army Forces Command
<b>FSB</b>	forward support battalion
<b>ft</b>	foot, feet
<b>G2</b>	Assistant Chief of Staff, G2 (Intelligence)
<b>G3</b>	Assistant Chief of Staff, G3 (Operations and Plans)
<b>G4</b>	Assistant Chief of Staff, G4 (Logistics)
<b>G5</b>	Assistant Chief of Staff, G5 (Civil Affairs)
<b>gal</b>	gallon(s)
<b>GC</b>	Geneva Convention Relative to the Protection of Civilian Persons in Time of War, 12 August 1949
<b>gd</b>	guard
<b>GO</b>	general officer
<b>GP</b>	general purpose
<b>GPW</b>	Geneva Convention Relative to the Treatment of Prisoners of War, 12 August 1949
<b>GWS</b>	Geneva Convention for the Amelioration of the Condition of the Wounded and Sick in Armed Forces in the Field, 12 August 1949
<b>GWS (SEA)</b>	Geneva Convention for the Amelioration of the Condition of Wounded, Sick, and Shipwrecked Members of Armed Forces at Sea, 12 August 1949
<b>H&amp;RA</b>	Humanitarian and Refugee Affairs
<b>H/CA</b>	humanitarian and civic assistance
<b>HA</b>	humanitarian assistance
<b>HHC</b>	headquarters and headquarters company
<b>HIV</b>	human immunodeficiency virus
<b>HM</b>	hazardous material
<b>HN</b>	host nation

---

<b>HQ</b>	headquarters
<b>HQDA</b>	Headquarters, Department of the Army
<b>ht</b>	height
<b>I/R</b>	internment/resettlement
<b>ICRC</b>	International Committee of the Red Cross
<b>ID</b>	identification
<b>IDP</b>	internally displaced person
<b>IFRC</b>	International Federation of Red Cross and Red Crescent Societies
<b>IG</b>	inspector general
<b>IHO</b>	international humanitarian organization
<b>IMC</b>	International Medical Corps
<b>INS</b>	Immigration and Naturalization Service
<b>IO</b>	international organization
<b>IOM</b>	International Organization for Migration
<b>IR</b>	information requirements
<b>IRIC</b>	internment/resettlement information center
<b>IRIS</b>	Internment/Resettlement Information System
<b>IRS</b>	Internal Revenue Service
<b>ISN</b>	internment serial number
<b>J4</b>	Logistics Directorate
<b>Jan</b>	January
<b>JCS</b>	joint chief of staff
<b>JFC</b>	joint forces commander
<b>JTF</b>	joint task force
<b>JTR</b>	joint travel regulation
<b>L&amp;O</b>	law and order
<b>LOC</b>	lines of communication
<b>LP</b>	listening post
<b>LRA</b>	local reproduction authorized
<b>LTC</b>	lieutenant colonel

<b>LZ</b>	landing zone
<b>M</b>	month
<b>MAJ</b>	major
<b>MANSCEN</b>	Maneuver Support Center
<b>MARKS</b>	Modern Army Recordkeeping System
<b>MBA</b>	main battle area
<b>MCCM</b>	modular crowd control munition
<b>MCO</b>	Marine Corps order
<b>MCO</b>	movement control officer
<b>MCRP</b>	Marine Corps reference publication
<b>MDMP</b>	military decision-making process
<b>METT-TC</b>	mission, enemy, terrain, troops, time available, and civilian considerations
<b>MI</b>	military intelligence
<b>misc</b>	miscellaneous
<b>MOOTW</b>	military operations other than war
<b>MOS</b>	military occupational specialty
<b>MP</b>	military police
<b>MRE</b>	meal, ready-to-eat
<b>MRO</b>	medical regulating officer
<b>MSCA</b>	military support to civil authorities
<b>MSF</b>	Médecin Sans Frontières (Doctors Without Borders)
<b>MSR</b>	main supply route
<b>MWD</b>	military working dog
<b>NA</b>	not applicable
<b>NA</b>	Narcotics Anonymous
<b>NATL</b>	national
<b>NATO</b>	North Atlantic Treaty Organization
<b>NBC</b>	nuclear, biological, or chemical
<b>NCCB</b>	National Council of Catholic Bishops
<b>NCO</b>	noncommissioned officer

---

<b>NCOIC</b>	noncommissioned officer in charge
<b>NDC TACNOTE</b>	National Disaster Coalition tactical note
<b>NG</b>	national guard
<b>NGO</b>	nongovernmental organization
<b>NLW</b>	nonlethal weapon
<b>No.</b>	number
<b>NOK</b>	next of kin
<b>NWP</b>	Naval warfare publication
<b>obj</b>	objective
<b>OC</b>	oleoresin capsicum
<b>OCONUS</b>	outside continental United States
<b>OD</b>	other detainee
<b>OFDA</b>	Office of Foreign Disaster Assistance
<b>OG</b>	olive green
<b>OIC</b>	officer in charge
<b>OIP</b>	organization inspection policy
<b>OP</b>	observation post
<b>OPCON</b>	operational control
<b>OPLAN</b>	operation plan
<b>OPNAVINST</b>	Office of the Chief of Naval Operations instruction
<b>OPORD</b>	operation order
<b>OSD</b>	Office of the Secretary of Defense
<b>PA</b>	physician's assistant
<b>PACAFP</b>	Pacific Air Forces pamphlet
<b>pam</b>	pamphlet
<b>PAO</b>	public affairs officer
<b>PHS</b>	Public Health Service
<b>PIR</b>	priority intelligence requirements
<b>PM</b>	provost marshal
<b>POC</b>	point of contact



<b>pr</b>	pair
<b>PRC</b>	populace and resource control
<b>PSB</b>	prisoner services branch
<b>PSYOP</b>	psychological operations
<b>pub</b>	publication
<b>PVNTMED</b>	preventive medicine
<b>PW</b>	prisoners of war
<b>QRF</b>	quick-reaction force
<b>qty</b>	quantity
<b>RCF</b>	regional corrections facility
<b>RCM</b>	rules for courts-martial
<b>reg</b>	regimental
<b>ROE</b>	rules of engagement
<b>ROI</b>	rules of interaction
<b>RP</b>	retained person
<b>S2</b>	Intelligence Officer (US Army)
<b>S3</b>	Operations and Training Officer (US Army)
<b>S4</b>	Supply Officer (US Army)
<b>S5</b>	Civil Affairs Officer (US Army)
<b>SA</b>	situational awareness
<b>SCF</b>	Save the Children Foundation
<b>SECDEF</b>	Secretary of Defense
<b>SGT</b>	sergeant
<b>SJA</b>	staff judge advocate
<b>SM</b>	selected marksman
<b>SOP</b>	standing operating procedure
<b>SSN</b>	social security number
<b>STANAG</b>	Standardization Agreement
<b>STD</b>	sexually transmitted disease
<b>STP</b>	soldier testing program

---

<b>STP</b>	soldier training publication
<b>STRESS</b>	search, tag, report, evacuate, segregate, and safeguard
<b>TB</b>	tuberculosis
<b>TCMS</b>	Theater Construction Management System
<b>THP</b>	temporary home patrol
<b>TO</b>	theater of operations
<b>TOC</b>	tactical operations center
<b>TOE</b>	table(s) of organization and equipment
<b>TRADOC</b>	United States Army Training and Doctrine Command
<b>TSC</b>	Theater Support Command
<b>TTP</b>	tactics, techniques, and procedures
<b>UCMJ</b>	Uniform Code of Military Justice
<b>UIC</b>	unit identification code
<b>UN</b>	United Nations
<b>UNDP</b>	United Nations Development Program
<b>UNDRC</b>	United Nations Disaster Relief Coordinator
<b>UNHCR</b>	United Nations High Commissioner for Refugees
<b>UNICEF</b>	United Nations Children's Fund
<b>UNOCHA</b>	United Nations Office for the Coordination of Humanitarian Affairs
<b>US</b>	United States
<b>USACIC</b>	United States Army Criminal Investigation Command
<b>USAFEP</b>	United States Air Forces Europe pamphlet
<b>USAID</b>	United States Agency for International Development
<b>USAR</b>	United States Army Reserve
<b>USCG</b>	United States Coast Guard
<b>USD</b>	Under Secretary of Defense
<b>USDA</b>	United States Department of Agriculture
<b>USDB</b>	United States Disciplinary Barracks
<b>USIA</b>	United States Information Agency
<b>WFP</b>	World Food Program

**WO** warrant officer  
**wt** weight  
**Y** year

## Bibliography

- AR 15-6. *Procedures for Investigating Officers and Boards of Officers*. 11 May 1988.
- AR 15-130. *Army Clemency and Parole Board*. 23 October 1998.
- AR 20-1. *Inspector General Activities and Procedures*. 15 March 1994.
- AR 25-400-2. *The Modern Army Recordkeeping System (MARKS)*. 26 February 1993.
- AR 27-10. *Legal Services: Military Justice*. 24 June 1996.
- AR 40-3. *Medical, Dental, and Veterinary Care*. 30 July 1999.
- AR 40-5. *Preventive Medicine*. 15 October 1990.
- AR 190-8. *Enemy Prisoners of War; Retained Personnel, Civilian Internees, and Other Detainees {OPNAVINST 3461.6; AFJI 31-304; MCO 3461.1}*. 1 October 1997.
- AR 190-12. *Military Police Working Dogs*. 30 September 1993.
- AR 190-14. *Carrying of Firearms and Use of Force for Law Enforcement and Security Duties*. 12 March 1993.
- AR 190-22. *Searches, Seizures, and Disposition of Property*. 1 January 1983.
- AR 190-40. *Serious Incident Report*. 30 November 1993.
- AR 190-47. *The Army Corrections System*. 15 August 1996.
- AR 210-130. *Laundry and Dry Cleaning Operations*. 15 April 1993.
- AR 210-174. *Accounting Procedures for Prisoners' Personal Property and Funds*. 17 September 1986.
- AR 385-10. *The Army Safety Program*. 23 May 1988.
- AR 600-13. *Army Policy for the Assignment of Female Soldiers*. 27 March 1992.
- AR 630-10. *Absence Without Leave, Desertion, and Administration of Personnel Involved in Civilian Court Proceedings*. 10 June 1992.
- AR 633-30. *Military Sentences to Confinement {AFR 125-30}*. 6 November 1964.
- AR 670-1. *Wear and Appearance of Army Uniforms and Insignia*. 1 September 1992.
- AR 700-84. *Issue and Sale of Personal Clothing*. 15 May 1983.
- AR 710-2. *Inventory Management Supply Policy Below the Wholesale Level*. 31 October 1997.
- CTA 50-900. *Clothing and Individual Equipment*. 1 September 1994.
- CTA 50-970. *Common Items of Nonexpendable Material*. 21 September 1990.
- DA Form 1124. *Individual Receipt Voucher Personal Deposit Fund*. October 1952.

- DA Form 1125-R. *Summary Receipt and Disbursement Voucher Personal Fund*. April 1986.
- DA Form 1128. *Petty Cash Voucher—Personal Deposit Fund*. 1 September 1960.
- DA Form 1129-R. *Record of Prisoners' Personal Deposit Fund (LRA)*. April 1986.
- DA Form 1130-R. *Statement of Prisoner's Personal Deposit Fund and Request for Withdrawal of Personal Funds (LRA)*. April 1986.
- DA Form 1131-R. *Prisoner's Cash Account—Personal Deposit Fund (LRA)*. April 1986
- DA Form 1132-R. *Prisoner's Personal Property List—Personal Deposit Fund (LRA)*. April 1986.
- DA Form 1134-R. *Request for Withdrawal of Personal Property (LRA)*. April 1986.
- DA Form 1135-R. *Personal Property Permit (LRA)*. April 1986.
- DA Form 2028. *Recommended Changes to Publications and Blank Forms*. 1 February 1974.
- DA Form 2662-R. *United States Army EPW Identity Card (LRA)*. May 1982.
- DA Form 2663-R. *Fingerprint Card (LRA)*. May 1982.
- DA Form 2664-R. *Weight Register (Prisoner of War) (LRA)*. May 1982.
- DA Form 2665-R. *Capture Card for Prisoner of War (LRA)*. May 1982.
- DA Form 2666-R. *Prisoner of War Notification of Address (LRA)*. May 1982.
- DA Form 2667-R. *Prisoner of War Mail (Letter) (LRA)*. May 1982.
- DA Form 2668-R. *Prisoner of War (Post Card) (LRA)*. May 1982.
- DA Form 2674-R. *Enemy Prisoner of War/Civilian Internee Strength Report (LRA)*. May 1982.
- DA Form 2677-R. *United States Army Civilian Internee Identity Card (LRA)*. November 1986.
- DA Form 2678-R. *Civilian Internee NATL-Internment Card (LRA)*. November 1986.
- DA Form 2679-R. *Civilian Internee Letter (LRA)*. November 1986.
- DA Form 2680-R. *Civilian Internee NATL-Post Card (LRA)*. November 1986.
- DA Form 3078. *Personal Clothing Request*. May 1993.
- DA Form 3955. *Change of Address and Directory Card*. 1 February 1979.
- DA Form 3997. *Military Police Desk Blotter*. 1 December 1998.
- DA Form 4137. *Evidence/Property Custody Document*. 1 July 1976.
- DA Form 4237-R. *Detainee Personnel Record (LRA)*. August 1995.
- DA Pam 27-1. *Treaties Governing Land Warfare*. 7 December 1956.
- DA Pam 37-100-95. *The Army Management Structure (AMS), Fiscal Year 1995*. 1 July 1994.
- DA Pam 350-38. *Standards in Weapons Training*. 3 July 1997.

- 
- DD Form 2 (ACT). *Armed Forces of the United States Geneva Convention Identification Card (Active) (EGA)*. October 1993.
- DD Form 499. *Prisoner's Mail and Correspondence Record*. 1 October 1967.
- DD Form 503. *Medical Examiner's Report*. 1 December 1955.
- DD Form 504. *Request and Receipt for Health and Comfort Supplies*. 1 April 1976.
- DD Form 506. *Daily Strength Record of Prisoners*. 1 February 1968.
- DD Form 509. *Inspection Record of Prisoners in Segregation*. 1 July 1970.
- DD Form 515. *Roster of Prisoners*. December 1955.
- DD Form 2707. *Confinement Order*. November 1999.
- DD Form 2708. *Receipt for Inmate or Detained Person*. November 1999.
- DD Form 2710. *Inmate Background Summary*. November 1999.
- DD Form 2718. *Inmate's Release Order*. November 1999.
- DD Form 2745. *Enemy Prisoner of War (EPW) Capture Tag*. May 1996.
- DFAS-IN 37-1. *Finance and Accounting Policy Implementation*. January 2000.
- DOD 4160.21-M. *Defense Reutilization and Marketing Manual*. August 1997.
- DOD Directive 1030.1. *Victim and Witness Assistance*. 23 November 1994.
- DOD Directive 1325.4. *Confinement of Military Prisoners and Administration of Military Correctional Programs and Facilities*. 28 September 1999.
- DOD Directive 3025.1. *Military Support to Civil Authorities (MSCA)*. 15 January 1993.
- DOD Directive 5100.46. *Foreign Disaster Relief*. 4 December 1975.
- DOD Instruction 1030.2. *Victim and Witness Assistance Procedures*. 23 December 1974.
- FBI Form FD-249. *Arrest and Institutional Fingerprint Card*. 11 May 1999.
- FM 3-0. *Operations*. To be published within 6 months.
- FM 3-05.30. *Psychological Operations*. 19 June 2000.
- FM 5-34. *Engineer Field Data*. 30 August 1999.
- FM 8-51. *Combat Stress Control in a Theater of Operations Tactics, Techniques, and Procedures*. 29 September 1994.
- FM 14-100. *Financial Management Operations*. 7 May 1997.
- FM 19-10. *The Military Police Law and Order Operations*. 30 September 1987.
- FM 19-15. *Civil Disturbances*. 25 November 1985.
- FM 19-20. *Law Enforcement Investigations*. 25 November 1985.

- FM 21-10. *Field Hygiene and Sanitation*. 11 June 2000.
- FM 22-5. *Drill and Ceremonies*. 8 December 1986.
- FM 22-6. *Guard Duty*. 17 September 1971.
- FM 22-100. *Army Leadership*. 31 August 1999.
- FM 27-10. *The Law of Land Warfare*. 18 July 1956.
- FM 33-1-1. *Psychological Operations Techniques and Procedures*. 5 May 1994.
- FM 90-40. *Multiservice Procedures for the Tactical Employment of Nonlethal Weapons (NLW) {MCRP 3-15.8; NWP 3-07-31; USCG Pub 3-07.31}*. 6 October 1998.
- FM 100-5. *Engineer Operations*. 27 February 1996.
- FM 100-19. *Domestic Support Operations {FMFM 7-10}*. 1 July 1993.
- FM 100-23-1. *Multiservice Procedures for Humanitarian Assistance Operations {FMFRP 7-16; NDC TACNOTE 3-07.6; ACCP 50-56; PACAFP 50-56; USAFEP 50-56}*. 31 October 1994.
- FM 101-5. *Staff Organization and Operations*. 31 May 1997.
- Foreign Assistance Act*, US Code (1994).
- Geneva Convention for the Amelioration of the Condition of the Wounded and Sick in Armed Forces in the Field (GWS)*, 12 August 1949.
- Geneva Convention for the Amelioration of the Condition of Wounded, Sick, and Shipwrecked Members of Armed Forces at Sea (GWS [SEA])*, 12 August 1949.
- Geneva Convention Protocol Relative to the Status of Refugees*. 1967.
- Geneva Convention Relative to the Protection of Civilian Persons in Time of War (GC)*, 12 August 1949.
- Geneva Convention Relative to the Status of Refugees*. 1951.
- Geneva Convention Relative to the Treatment of Prisoners of War (GPW)*, 12 August 1949.
- Geneva Conventions for the Protection of War Victims*, 12 August 1949.
- Misc Pub 27-7. *Manual for Courts-Martial, United States, 2000 Edition*.
- Posse Comitatus Act*, US Code (1994).
- STANAG 2033. *Interrogation of Prisoners of War (PW) (Edition 6)*. 6 December 1994.
- STANAG 2044. *Procedures for Dealing With Prisoners of War (PW) (Edition 5)*. 28 June 1994.
- STANAG 2084. *Handling and Reporting of Captured Equipment and Documents (Edition 6)*. 6 April 1999.
- STP 19-95B1-SM. *Soldier's Manual, MOS 95B, Military Police, Skill Level 1*. 21 February 1997.
- STP 19-95C14-SM-TG. *Soldier's Manual and Trainer's Guide for MOS 95C Internment/Resettlement Specialist, Skill Levels 1/2/3/4*. 26 March 1999.

STP 21-24-SMCT. *Soldier Testing Program (STP)*. 1 October 1992.

TC 27-10-1. *Selected Problems in the Law of War*. 26 June 1979.

*UCMJ*

*UNHCR Handbook for the Military on Humanitarian Operations, First Edition*. 1995.



# Index

## A

ACS. See Army Corrections System (ACS).  
adjudged prisoner, 7-4  
adjutant general (AG), 2-9  
administration  
    CI facility, 5-2  
    DC facility, 9-15  
    FCF, 8-11  
    HA facility, 10-11  
administrative segregation, 7-5  
AG. See adjutant general (AG).  
agencies involved in I/R operations, 1-6  
agitators, 4-10  
agriculture program  
    CIs, 5-16  
    EPWs, 4-20  
air assault operations, 3-19  
airborne operations, 3-18  
aircraft transport, 8-19  
amphibious operations, 3-18  
apprehension of escaped prisoners, 8-16  
approved-adjudged prisoner, 7-4  
armored operations, 3-18  
Army Corrections System (ACS), 7-1  
assembly area, DC, 9-4  
assignment to internment facility  
    CIs, 5-4  
    EPWs, 4-9

## B

backhaul system, 3-10  
barracks rules, 9-15  
baton positions, B-14  
battlefield confinement, US military prisoners, 8-1  
briefing DCs, 9-6

## C

cadence, B-27  
canteens, 4-18  
captives, 1-11  
capture tag, 3-2  
captured supplies and equipment, 6-5  
capturing power, 1-6  
casual prisoner, 7-4

categories of civilians, 9-2  
central CP, 3-12  
CHA. See corps holding area (CHA).  
chapels, 6-7  
chaplain, 2-10  
chaplain captive, 4-14  
chemical irritants, B-13  
CI. See civilian internee (CI).  
circle formation, B-21  
civil rights, 1-13  
civilian interference, 9-2  
civilian internee (CI), 1-3, 5-1  
civilian lead agency, 1-9  
civilian organizations, 1-8  
civil-military operations (CMO), 9-1  
clandestine activities, 4-23  
classification  
    captives, 3-7  
    DCs, 9-11  
    EPWs, 4-9  
    US military prisoners, 8-7  
classification reduction, 8-9  
clear zones, 6-2  
clemency, 7-11  
close confinement, 7-6  
close support, B-24  
clothing  
    CIs, 5-5  
    civilians, 10-9  
    DCs, 9-12  
    EPWs, 4-15  
    US military prisoners, 8-7  
CMO officer, 2-9  
CMO. See civil-military operations (CMO).  
coercion, 3-7  
collecting point (CP), 3-1, 3-10  
collection point, DCs, 9-4  
combat zone (CZ), 1-2  
commander responsibilities, 2-1  
commands, B-25  
communications, 6-3  
compensation  
    CIs, 5-16  
    EPWs, 4-20  
    US military prisoners, 7-11  
complaints, 5-13  
confinement

    CIs, 5-12  
    US military prisoners, 7-1  
confiscated items, 3-5  
constitutional rights, US military prisoners, 7-3  
constructing I/R facilities, 6-1  
control  
    CIs, 5-10, 5-17  
    civilians, 10-10  
    DCs, 9-2, 9-14  
    EPWs, 4-12  
    US military prisoners, 7-5, 8-10  
control force, B-6  
controlled flow, 4-1  
corps holding area (CHA), 3-1, 3-15  
correctional facilities, 7-3  
correctional staff, 7-12  
correctional system, 7-1  
correctional treatment programs, 7-8  
correctional treatment, US military prisoners, 7-1  
correspondence  
    CIs, 5-13  
    EPWs, 4-17  
    US military prisoners, 7-19, 8-14  
counseling, 7-8  
CP. See collecting point (CP).  
crowd  
    behavior, B-6  
    control, B-6  
    tactics, B-8  
currency, 3-5  
custody grade, US military prisoners, 7-5, 8-9  
custody, US military prisoners, 7-5, 8-10  
CZ. See combat zone (CZ).

## D

DART. See disaster assistance response team (DART).  
database, 4-5  
DC facility, 9-7  
DC operations, 9-1, 9-2  
DC. See dislocated civilian (DC).  
deadly force, 9-17, B-1

definitions, 1-2  
 dependent children of CIs, 5-4  
 deprivation, 8-9  
 detained prisoner, 7-4  
 detainees, 1-11  
 detaining power, 5-12  
 diamond formation, B-21  
 disaster assistance response team (DART), 10-19  
 disciplinary  
     action, 8-9  
     measures, 7-6  
     punishment, 5-3  
 disciplinary-and-adjustment board, 8-16  
 discipline  
     CIs, 5-11  
     civilians, 10-10  
     DCs, 9-14  
     EPWs, 4-15  
     US military prisoners, 8-9  
 dislocated civilian (DC), 1-4  
 disorder, 2-8, B-7  
 displaced person (DP), 1-4  
 disposition of DCs, 9-18  
 dissident actions, 4-21, 5-17  
 disturbance, 2-8, 5-17, 5-18  
 documentation, DCs, 9-6  
 DP. See displaced person (DP).

**E**

echelon formation, B-19  
 education program  
     CIs, 5-15  
     EPWs, 4-18  
     US military prisoners, 7-10  
 EGCT. See extra good-conduct time (EGCT).  
 emergency action plan, 2-2, 7-7  
 emergency services (ES), 10-14  
     CONUS, 10-14  
     OCONUS, 10-17  
 employment  
     CIs, 5-16  
     EPWs, 4-19  
     US military prisoners, 7-10  
 enemy plants, 4-10  
 enemy prisoner of war (EPW), 1-2, 4-1  
 engineer officer, 2-10  
 EPW leaders, 4-10  
 EPW. See enemy prisoner of war (EPW).  
 equipment guide, C-1  
 ES. See emergency services (ES).  
 escapes

CIs, 5-14  
 EPWs, 4-24  
     US military prisoners, 7-7  
 escapes, preventing, 8-18  
 escort guard company, 4-11  
 evacuation  
     captives, 3-7  
     DCs, 9-5  
     EPWs, 4-1  
 evacuee, 1-5  
 evacuees, return of, 9-6  
 evaluation board, 7-8  
 expellee, 1-5  
 extra duty, 8-9  
 extra good-conduct time (EGCT), 7-11

**F**

facility guard force, 2-6  
 FCF. See field confinement facility (FCF).  
 FDF. See field detention facility (FDF).  
 Federal Response Plan, 1-7  
 female  
     CIs, 5-11  
     EPWs, 4-9  
 field confinement facility (FCF), 7-1, 8-3  
 field detention facility (FDF), 7-1, 8-3  
 field processing captives, 3-2  
 finance officer, 2-9  
 Five S and T procedure (search, segregate, silence, speed, safeguard, and tag), 3-4  
 forfeiture, US military prisoners, 8-9  
 formation enhancement, B-21  
 formations, B-16  
 forms  
     ACS, 7-17  
     FCF, 8-13  
 forward CP, 3-10  
 fraternization  
     CIs, 5-11  
     EPWs, 4-15  
 frisking US military prisoners, 7-7  
 full processing, 4-8

**G**

general orders, 2-6  
 general support, B-22  
 Geneva Conventions, 1-12, 1-13  
 good-conduct time, 7-18, 8-9  
 guard towers, 6-2

guards, 7-13, 8-11

**H**

HA. See humanitarian assistance (HA).  
 halt, B-2  
 hostile  
     act, 9-17  
     environment, 10-2  
     intent, 9-17  
 housed personnel, care and control, 2-13  
 housekeeping supplies, 6-7  
 humanitarian assistance (HA), 10-1

**I**

ID band  
     CIs, 5-4  
     EPWs, 4-6  
 identifying  
     CIs, 5-5  
     DCs, 9-11, 10-8  
     US military prisoners, 8-7  
 IDP. See internally displaced person (IDP).  
 IG. See inspector general (IG).  
 IHO. See international humanitarian organization (IHO).  
 impounded items, 3-5  
 information flow, 4-7  
 initial processing, 4-7  
 inspections, 2-8  
 inspector general (IG), 2-12  
 intelligence gathering, 4-22, B-11  
 intermediate processing, 4-8  
 internally displaced person (IDP), 1-5  
 international humanitarian organization (IHO), 1-9  
 international organization (IO), 1-8  
 internee committee, 5-12  
 internment  
     dependent children, 5-2  
     protected civilians, 5-2  
 internment serial number (ISN), 4-6  
 interpreters, 4-2, 5-6  
 interrogation, 3-17  
 interservice transfer, 4-11  
 IO. See international organization (IO).  
 ISN. See internment serial number (ISN).  
 isolation, 4-9

**L**

L&O. See law and order (L&O).  
 lateral support, B-23  
 law and order (L&O), 9-16, 10-12  
 layout  
   central CP, 3-13  
   CHA, 3-15  
   DC facility, 9-10  
   DC overlay, 9-5  
   FCF, 8-5  
   forward CP, 3-11  
   HA facility, 10-7  
   I/R facility, 6-3  
   processing center, 6-5  
 legal considerations, 10-3  
 legal obligations, 9-2  
 lethal force, B-4  
 lights, 6-3  
 line formation, B-18  
 location of I/R facilities, 6-1

**M**

mandated organization, 1-9  
 marking CI facilities, 5-18  
 marking outer garments  
   CIs, 5-5  
   EPWs, 4-16  
 marksman, B-5  
 MCO. See movement control officer (MCO).  
 medical captive, 4-14  
 medical care  
   captives, 2-4  
   CIs, 5-13  
   civilians, 10-9  
   DCs, 9-6, 9-12  
   EPWs, 4-17  
   internees, 6-7  
   US military prisoners, 7-23, 8-8  
 medical evacuation, 3-8  
 medical officer, 4-17, 5-9  
 medical operations, 2-11  
 medical support, 3-10, 3-12  
 metric conversions, A-1  
 MI interrogation team, 3-2, 3-17  
 migrant, 1-5  
 military working dog (MWD), 2-7, 4-23, 5-18  
 misconduct, 8-16  
 mitigation, 7-11  
 motor vehicle transport, 8-18  
 movement control officer (MCO), 2-12  
 movement of captives, 3-9

**MP support**

  DC operations, 9-7  
   ES operations, 10-20  
 MWD. See military working dog (MWD).

**N**

NGO. See nongovernmental organization (NGO).  
 NLW. See nonlethal weapon (NLW).  
 nongovernmental organization (NGO), 1-8  
 nonlethal measures, 9-18  
 nonlethal weapon (NLW), B-3  
 nonmandated organization, 1-9  
 nonviolent tactics, B-7  
 notice of protection, 2-3, 5-11

**O**

objectives, I/R operations, 1-5  
 OD. See other detainee (OD).  
 officer prisoner, 7-4  
 operational environment, 10-2  
 other detainee (OD), 1-4, 5-1

**P**

PAO. See public affairs officer (PAO).  
 parole, 7-12  
 patrol roads, 6-3  
 perimeter security, 2-7  
 permanent transfer, 4-11  
 permissive environment, 10-2  
 personal property  
   CIs, 5-14  
   EPWs, 4-11  
   US military prisoners, 7-18  
 personnel file  
   CIs, 5-4  
   EPWs, 4-5  
   US military prisoners, 7-8  
 petty-cash fund, 7-19  
 photographs  
   CIs, 5-8  
   EPWs, 4-4  
   US military prisoners, 8-7  
 planning considerations, central CP, 3-14  
 platoon echelon left, B-20  
 platoon echelon right, B-20  
 policies, DCs, 9-3  
 populace and resource control (PRC), 9-1  
 positions, B-27

PRC. See populace and resource control (PRC).

pretrial confinement, 7-3  
 principles  
   CI facilities, 5-3  
   I/R facilities, 2-2  
   I/R operations, 1-5  
 priorities of force, 8-17, B-1  
 prisoner status, 7-4  
 privileged mail, 7-20  
 privileges, US military prisoners, 8-9  
 proactive programs, 10-1  
 procedures  
   DC operations, 9-3  
   I/R facility operations, 2-1  
 processing  
   captives, 3-2  
   CIs, 5-6  
   civilians, 10-6, 10-8  
   DCs, 9-9  
   EPWs, 4-1  
   US military prisoners, 8-5  
 processing centers, 6-5  
 processing stations  
   CIs, 5-7  
   DCs, 9-11  
   EPWs, 4-2  
   US military prisoners, 8-6  
 property accountability, 3-5  
 protected CI status, 5-4  
 protected civilian, 5-2  
 protecting power, 1-11, 4-14, 5-12  
 protection  
   captives and detainees, 1-11  
   EPWs and CIs, 1-12  
   refugees, 1-13  
 psychological operations (PSYOP), 2-12  
 PSYOP. See psychological operations (PSYOP).  
 public affairs officer (PAO), 2-10  
 punishment, 8-9, 8-10  
 punitive measures, prohibited, 7-6

**R**

rail transport, 8-19  
 rations  
   DCs, 9-6  
   EPWs, 4-17  
 reactionary force, 8-16  
 reactive programs, 10-1  
 reassignment, EPWs, 4-10  
 receipts, 3-6  
 receiving  
   CIs, 5-6

EPWs, 4-1  
 receiving centers, 6-5  
 reclassification  
     DCs, 9-11  
     EPWs, 4-10  
 record of events, B-9  
 records  
     CI facility, 5-4  
     I/R facility, 2-4  
 recreation program  
     captives, 2-5  
     CIs, 5-16  
     I/R facility, 6-7  
     US military prisoners, 7-10  
 refugee, 1-5, 1-13  
 regulations  
     ACS, 7-17  
     FCF, 8-13  
 releasing CIs, 5-15  
 relief agencies, 1-10  
 religious materials, I/R facilities,  
     6-7  
 remission, 7-11  
 repatriating EPWs, 4-11  
 reports  
     captives, 3-6  
     CI facility, 5-4  
     EPWs, 4-11  
     I/R facility, 2-4  
 representatives, EPW, 4-13  
 reprimand, 8-9  
 requests, 5-13  
 responsibilities  
     commander, 2-1  
     staff officers, 2-9  
 restraining devices, 7-6  
 restrictions, employing EPWs, 4-19  
 retained items, 3-4  
 retained person (RP), 1-3  
 riot, 2-8, 5-17, B-8  
 riot control agents, B-11  
 riot control measures, B-9  
 river-crossing operations, 3-18  
 ROE. See rules of engagement  
     (ROE).  
 ROI. See rules of interaction (ROI).  
 RP. See retained person (RP).  
 rules of engagement (ROE), 2-8,  
     4-15, 5-18, 9-17, 10-3, B-2  
 rules of interaction (ROI), 4-14,  
     8-16, 9-17, 10-13

**S**

safeguard, 3-8  
 safety, 2-5, 5-2  
 sally ports, 6-3

sanitation, 2-4, 4-17, 5-13, 6-7, 8-8,  
     9-12, 10-9  
 schedule of calls, 2-2  
 screening, 3-17, 9-11, 10-8  
 searches, 3-4, 5-11, 9-9, 10-8  
 security, 2-5, 3-9, 4-7, 4-15, 4-21,  
     5-11, 5-17, 9-5, 9-13, 10-2,  
     B-11  
 security measures, prohibited,  
     8-10  
 security requirements, I/R facilities,  
     6-2  
 segregation  
     at CPs and CHAs, 3-7  
     EPWs, 4-9  
     US military prisoners, 7-4, 8-9  
 self-government  
     civilians, 10-10  
     DCs, 9-13  
 sentence computation, 7-18, 8-14  
 signal officer, 2-10  
 SJA. See staff judge advocate  
     (SJA).  
 social programs, 2-4  
     CIs, 5-15  
     EPWs, 4-18  
 special orders, 2-6  
 staff judge advocate (SJA), 2-10  
 staff responsibilities, 2-9  
 standby guards, 2-7  
 standing orders, 2-2, 5-3  
 stateless person, 1-5  
 stay-put policy, 9-4  
 strength report, 4-7  
 STRESS (search, tag, report,  
     evacuate, segregate, and  
     safeguard), 3-2  
 subsistence  
     at I/R facilities, 6-5  
     CIs, 5-5  
     civilians, 10-9  
     DCs, 9-12  
     EPWs, 4-17  
     US military prisoners, 8-8  
 supplies, 7-22  
 supply services, 8-15  
 support personnel  
     ACS, 7-16, 7-20  
     MP unit, 8-15  
 suspension, 7-11

**T**

tactics, B-5  
 tagging captives, 3-6  
 temporary custody, 8-1  
 temporary transfer, 4-11

tower guards, 2-7  
 training  
     ACS, 7-15  
     I/R personnel, 2-13  
     NLWs, B-5  
     riot control, B-10  
 transfer  
     CIs, 5-14  
     EPWs, 4-10  
     US military prisoners, 7-21,  
     8-19  
 transporting  
     civilians, 10-13  
     DCs, 9-5, 9-6, 9-18  
     US military prisoners, 7-7,  
     8-18  
 treatment  
     CIs, 5-1  
     detainees, 1-12  
     EPWs, 4-13  
 tribunal, 4-10

**U**

uncertain environment, 10-2  
 units in a TO, D-1  
 US military prisoner, 1-5  
 US policy, 1-12  
 use of force, 2-8, 8-17, 9-17, 10-2

**V**

violations of the UCMJ, 8-16  
 visits, 5-16

**W**

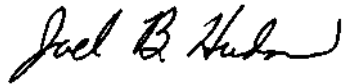
walking patrols, 2-7  
 war victim, 1-5  
 warning, 8-9  
 weapon positions, B-16  
 wedge formation, B-19  
 work detail guards, 4-23  
 worship  
     captives, 2-5  
     CIs, 5-16  
     EPWs, 4-18  
     US military prisoners, 7-20

**FM 3-19.40**

By Order of the Secretary of the Army:

ERIC K. SHINSEKI  
*General, United States Army*  
*Chief of Staff*

Official:



JOEL B. HUDSON  
*Administrative Assistant to the*  
*Secretary of the Army*

**DISTRIBUTION:**

*Active Army, Army National Guard, and US Army Reserve: To be distributed in accordance with the initial distribution number 110143 requirements for FM 3-19.40.*


[Glossary](#)

[How are refugee/IDP camps established? How are they designed to minimize health risks?](#)

[What kinds of shelter are constructed in a camp?](#)

[What are the main objectives of providing shelter?](#)

[What criteria are used in site selection for a camp?](#)

Links to more information on shelter:

[UNHCR:Refugees and the Environment](#)

## Shelter and site planning

### Introduction

Refugees arriving in any specific area tend to settle down in different ways: often, they concentrate on an unoccupied site and create a 'camp'; at other times, they spread out over a wide area and establish rural settlements; and sometimes they are hosted by local communities (rural or urban). The latter two situations, also called 'open situations', occur less frequently than the first (see below and the Introduction to Part II).

A poorly planned refugee settlement is one of the most pathogenic environments possible. Overcrowding and poor hygiene are major factors in the transmission of diseases with epidemic potential (measles, meningitis, cholera, etc.). The lack of adequate shelter means that the population is deprived of all privacy and constantly exposed to the elements (rain, cold, wind, etc.). In addition, the surrounding environment may have a pronounced effect on refugee health, particularly if it is very different from the environment from which they have come (e.g. presence of vectors carrying diseases not previously encountered).

Camps usually present a higher risk than refugee settlements in open situations as there is more severe overcrowding, and less likelihood that basic facilities, such as water supply and health care services, will be available when refugees first arrive<sup>2,7</sup>. Relief work is more difficult to organize for very large camp populations, such as some of the Rwandan refugee camps in Zaire (Goma, 1994) which contained more than 100,000 refugees.

In order to reduce health risks, it is essential that site planning and organization takes place as early as possible so that overcrowding is minimized and efficient relief services are provided. Shelters must be provided as rapidly as possible to protect refugees from the environment, and infrastructure installed for the necessary health and nutrition facilities, water supply installations, latrines, etc. All this must be initiated within

the first week of intervention<sup>3</sup>.

Relief agencies are usually faced with one of two possible situations: either the camp is already established with a refugee population that has spontaneously settled on a site prior to the arrival of relief agencies, or site planning is possible prior to their arrival, for example, when they are being transferred to a new camp.

Whichever is the case, prompt action must be undertaken to improve the site and its facilities; poor organization in the early stages may lead to a chaotic and potentially irreversible situation in regard to camp infrastructure, with consequent health risks. For example, lateral expansion of a site must be accounted for from the beginning in order to avoid overcrowding if refugee numbers increase.

Two possibilities: a refugee camp or integration into the host population

There is always a lot of discussion as to whether the formation of a refugee camp is acceptable, or whether resources would be better directed to supporting local communities who host refugees. The two main types of refugee settlement - camp or integration into the local population - each offer both advantages and disadvantages as laid out below:

### **Camp or integration into the local population: Advantages and disadvantages<sup>7,8</sup>**

#### **CAMP ADVANTAGES:**

- Provides asylum and protection
- More suitable for temporary situation
- Easier to estimate population numbers, to assess needs and monitor health status
- Some basic services are easier to organize (e.g. distributions, mass vaccinations)
- Allows visibility and advocacy
- Repatriation will be easier to plan

#### **CAMP DISADVANTAGES:**

- Overcrowding increases risk of outbreaks of communicable diseases
- Dependence on external aid, lack of autonomy
- Social isolation

- Little possibility of realizing farming initiatives
- Degradation of the surrounding environment
- Security problems within the camp
- Not a durable solution

#### INTEGRATION ADVANTAGES:

- Favors refugee mobility, easy access to alternative food, jobs, etc.
- Encourages refugee survival strategies
- Possibility of refugee access to existing facilities (water, health etc.)
- Enhances reconstruction of social/economic life and better integration in the future

#### INTEGRATION DISADVANTAGES:

- Population more difficult to reach, leading to difficulties in monitoring health needs
- Implementation of relief programs more complex, requires knowledge of local situation
- Risks destabilizing the local community, risk of tensions between local community and refugees

Health agencies are generally not involved in deciding between the two options. Every refugee situation is specific to itself. The main factors influencing the way in which they eventually settle are the number of refugees, the capacity for the local community to absorb them, the ethnic and cultural links between the refugee and local communities and the political and military situation. In practice, the predominant factor is the relationship between refugees and the local population.

It should, however, be pointed out that relief programs, particularly food aid may well play a role in attracting refugees into a camp situation even when integration would probably be a better option for them.

It is camp situations that are dealt with more specifically here, because camp populations are exposed to greater health risks. However, most of the principles described below may also be applied to open situations.

### Site planning



Site planning must ensure the most rational organization of space, shelters and the facilities required for the provision of essential goods and services. This requires supervision by experts (e.g. in sanitation, geology, construction, etc.) which must be integrated into the planning of other sectors, especially water and sanitation. It is therefore essential that there is coordination from the beginning between all the agencies involved and between the different sectors of activity, especially in an emergency situation when time is generally in short supply.

Site planning in refugee situations is normally the responsibility of UNHCR (or an agency delegated by UNHCR). As UNHCR is usually not present where there is an internally displaced settlement, another agency will have to take charge. Although health agencies will not always be involved in organizing a site, they should nevertheless make sure that this is undertaken correctly because of its direct influence on the subsequent health situation; it is therefore necessary to have an understanding of the basic principles of site planning.

As stated above, the possibilities in regard to site planning depend largely on which of the two refugee situations described will be encountered.

1. In most cases refugees have already settled on a site and planners may well be faced with chaotic conditions. The immediate priority must be to improve or reorganize the existing site, and in rare instances it may even be advisable to move the refugee population to another site (see below).
2. The ideal but far less frequently encountered situation is that where site planning can be carried out before the arrival of refugees on a new site. The most appropriate site layout may then be worked out in advance and in accordance with guidelines.

In both situations, the following principles must be respected as far as possible.

- Sufficient space must be provided for everybody: space for every family to settle with the provision of amenities (water and latrines) and other services, and access to every sector. High density camps should be avoided because they present a higher risk for disease transmission, fire and security problems<sup>2</sup>.
- Short-term site planning should be avoided, as so-called temporary camps may well have to remain much longer than expected (e.g. some Palestinian refugee camps have been in existence since 1947) <sup>2</sup>. This means that consideration must be given to the possibilities for expansion should the population increase<sup>1</sup>.
- A few small camps (ideally circa 10,000 people) are preferable to one large camp because they are easier to manage and because they favor a return to self-sufficiency<sup>2</sup>. Unfortunately, this is rarely possible when there is a massive influx of refugees (e.g. the refugee movements in Rwanda and Burundi, 1993-94).
- Refugees should be involved and consulted. Their social organization and their opinions should be taken into account wherever possible.
- Local resources (human and material) and local standards should be employed whenever feasible. Seasonal changes (e.g. the rainy season) must also be taken into consideration.

## SITE SELECTION

The ideal site, responding to all requirements, is rarely available. The choice is generally limited, as the most appropriate areas will already be inhabited by local communities or given over to farming. In any case, relief agencies are seldom on the spot to select a site before refugees arrive.

However, there are certain criteria in regard to site selection which must still be taken into account<sup>1,9</sup>.

- Security and protection: the settlement must be in a safe area (e.g. free of mines), at a reasonable distance from the border, and from any war zones.
- Water: water must be available either on the site or close by.
- Space: the area must be large enough to ensure 30m<sup>2</sup> per person (see Table 5.2).
- Accessibility: access to the site must be possible during all the seasons (e.g. for trucks).
- Environmental health risks: the proximity of vector breeding sites transmitting killer diseases should be avoided as far as possible (e.g. tsetse fly for trypanosomiasis). Where such areas cannot be avoided, they must be treated.
- Local population: every effort should be made to avoid tensions arising between local and refugee communities; for instance, legal and traditional land rights must be respected.
- It is important that the terrain should slope in order to provide natural drainage for rainwater off the site<sup>4</sup>.

Energy sources should also be considered when selecting a site, particularly as deforestation resulting from using wood for cooking fuel entails politico-ecological problems.

## SITE ORGANIZATION

Once the site has been secured, the planning and location of the required infrastructure must be worked out. A map should be used and the road network drawn onto it. The area should then be divided into sections and locations decided for the different facilities. Good access by road to every section and each installation is essential for the transport of staff and materials (e.g. food and drugs) in order to ensure the different services are able to function.

Several factors should be taken into account in deciding the spatial organization of facilities and shelters (location and layout):

- space required per person and for each installation

- accessibility of services
- minimum distance required between facilities and shelters (see table 5.2)
- cultural habits and social organization of the refugee population (clans and extended families)
- ethnic and security factors, relationships among different sections/ members of the community, etc.

**Cultural and social traditions are a determining factor in ensuring refugee acceptance of the infrastructure and services provided, particularly in regard to housing, sanitation, burial places, etc.**

However, as the layout that might be preferred by the refugees is not always the one that would allow the most efficient delivery of aid, site planning generally requires compromise solutions that take into account the different points of view<sup>2</sup>.

Table 5.2 Some quantified norms for site planning<sup>1,2</sup>

Area available per person	30 m <sup>2</sup>	
Shelter space per person	3.5 m <sup>2</sup>	
Number of people per water point	250	250
Number of people per latrine	20	
Distance to water-point	15 m max.	
Distance to latrine	30 m	
Distance between water-point and latrine	100 m	
Firebreaks	75 m every 300 m	
Distance between two shelters	2 m min.	

## ESSENTIAL INSTALLATIONS

Essential installations are described in Table 5.3. Some are likely to be centralized:

- reception center
- health center

- hospital
- meeting place for home-visitors, etc.

Other facilities, such as health posts, latrines, washing areas, etc., should be decentralized. Care must be taken to ensure that there is sufficient space for such decentralized services in all the camp sub-divisions.

**Table 5.3 Main installations required on refugee sites**

- |   |
|---|
| <ul style="list-style-type: none"> <li>— Roads and firebreaks</li> <li>— Water supply and sanitation facilities (defecation areas, latrines, waste disposal pits, washing places, etc.)</li> <li>— Health facilities: health center, health posts, hospital, pharmacy and site for cholera camp.</li> <li>— Meeting place for home-visitors</li> <li>— Nutritional facilities: therapeutic and supplementary feeding centers</li> <li>— Distribution site and storage facilities (in separate locations)</li> <li>— Administrative center, reception area</li> <li>— Other community facilities: market, schools, cemetery, meeting places, etc.</li> </ul> |
|---|

The location of health facilities must be carefully determined.

- The central health facility should be located in a safe and accessible place, preferably on the periphery of the site in order to avoid overcrowding and allow for future expansion. The space required depends on the type and desired capacity of the medical services to be provided.
- The hospital, if one is necessary, is usually an expansion of the in-patient service of the central facility. The criteria are thus similar but more space is required (in line with the number of beds). It is particularly important to plan space for water and sanitation facilities, as well as room for eventual expansion (e.g. outbreaks of disease).
- The peripheral health facilities should be centrally located within the areas they are to serve so as to ensure easy access. The number required depends mainly on the size of the population (e.g. 1 health post

per 3,000-5,000 refugees).

— A site for a cholera camp must be identified in advance, separate from other health facilities. It must be large enough to ensure sufficient capacity for potential needs and be provided with adequate water and sanitation facilities<sup>6</sup>.

## THE LAYOUT OF SHELTERS

The way shelters are grouped has an important influence on the re-establishment of social life, on the use of latrines and water-points, and on security.

In general, the site should be divided into smaller units for management purposes. For example, it could be divided into sectors of 5,000 and sections of 1,000 people. However, the formation of such units must take into account the existence of any groups within the population which may be mutually hostile,

Two main ways of grouping shelters are described:

1. The preferred method is to organize the site into basic community units, constituted by a number of shelters and community facilities (latrines, water-points and washing areas) <sup>1,3</sup>. These basic units should correspond in design as closely as possible to that with which the refugees are most familiar. Examples for designing such community units are available in several reference books <sup>2,4,9</sup>.

2. Laying out shelters in lines and rows is another possibility, but is usually not recommended because this deprives families of personal space, and increases the distances to latrines and water-points. On the other hand, such a layout can be implemented quickly and is often preferred when there is a sudden and massive influx of refugees to cope with.

Since in most cases the population will have settled on a site before any site planning can be carried out, solutions will have to be sought for improving the situation.

— Usually, the site may be improved without moving all the shelters. A better organization of facilities, improving access to all sections of the camp, and carefully planning sections for new arrivals will decrease health risks and improve camp management,

— A thorough reorganization of the site (and most shelters) may sometimes be necessary, although radical change is usually not advised. Such reorganization should be considered when there is a real threat to refugee health from overcrowding or a danger of fire, etc. For example, it was decided to move and reorganize all shelters in the Rwandan camps for refugees from Burundi in 1993, in order to counter the high fire risk and to facilitate the management of relief assistance.

— Critical problems, such as a lack of water in the area, insecurity or potential danger resulting from the camp's proximity to the border, may present major obstacles to the camp remaining where it is. A move to a new site could then be considered, but the operational problems involved in a move and the social and psychological consequences for the population must be carefully weighed up in advance,

## Shelter provision

The objectives of providing shelters are: protection against the elements and against vectors, provision of sufficient housing space for families, and restoring a sense of privacy and security. Shelters are required in every refugee emergency; but the type and design of shelter, who constructs it and how long it should last will vary in every situation<sup>2</sup>.

However, some general principles may be concluded<sup>2</sup>:

- Shelters that have already been built by refugees or buildings occupied by them (e.g. schools) must be assessed. It is important that consideration is given to the amount of space available for each person, to ventilation (e.g. risk of respiratory infection) and for protection against rain, as these factors may entail significant health risks.
- Wherever possible, refugees should construct their own shelters and should receive material (including appropriate tools) and technical support to assist them in doing so.
- It is best to use suitable local materials where available. Special emergency shelters (e.g. tents) and pre-fabricated units have not yet proven practical because of their high cost and the problems of transporting them. It is also difficult to persuade refugees to accept something which is not within their cultural traditions. However, some types of prefabricated shelter are still being tested and may be suitable for use in the first weeks of an emergency.
- A minimum sheltering space of 3.5m<sup>2</sup> per person is recommended in an emergency. However, different cultures have different needs. - Single-family shelters are preferable (unless multi-family units are traditional).

## WHEN REFUGEES FIRST ARRIVE

The provision of shelter is a high priority. Immediate action should be taken to assess the arrangements already made and provide material for temporary shelters<sup>2</sup>.

There are several common solutions for temporary shelters:

- Shelters built by the refugees themselves, with material found locally or distributed by agencies, are the most common solution.
- Tents may be useful when local material is not available and as very short term accommodation, but they are expensive and do not last long.
- Plastic sheeting may be used for constructing temporary shelters or to protect them. Methods for setting up plastic temporary shelters are described in guidelines<sup>5</sup>.
- Local public buildings, such as schools, may provide shelter initially but are not usually suitable for

large numbers. They are a very temporary solution.

## THE POST-EMERGENCY PHASE

Temporary shelters should no longer be used after the emergency stage has passed; an early start must be made to constructing shelters made of more permanent material.

However, it must be acknowledged that there are certain constraints involved in such shelter construction programs<sup>10</sup>.

- Any shelter building or rehabilitation program takes time.
- Such programs are costly (although they may produce savings in other sectors).
- As there is a vast range of options for building shelters and a wide range of criteria have to be taken into account, such programs are complex to manage. This is a specialized job and requires expertise.

This can often become a highly political issue with local authorities obstructing the building of (semi-) permanent housing when they want to prevent refugees settling for a long period of time. Longer-term housing should be similar to that with which refugees are already familiar, but should also reflect local conditions<sup>2</sup>. The use of local material is preferable, but its availability may be problematic (e.g. degradation of the environment through deforestation).

In countries such as Afghanistan or the countries of Eastern Europe, where very low temperatures may be experienced in winter, shelter provision is essential for protection against the cold. Although a few solutions have been proposed (e.g. winter tents and the provision of heaters), this is a particularly difficult problem to deal with in an emergency situation.

Once time allows, traditional housing may be built, if the materials are available, and there are sufficient financial resources.

### **Principal recommendations regarding shelter and site planning**

- Site planning and improvement should take place as early as possible in order to minimize overcrowding and make it possible to organize efficient relief services.
- A site should be selected with a view to security, access to water, the provision of adequate space, environmental health risks, and the local population.
- Site planning must ensure the most rational organization of the available space in regard to shelters and the necessary facilities and installations. Where refugees have already settled on a site before any planning could be envisaged, it is not usually advisable to institute radical changes, but improvements and reorganization should be carried out.

- Small sites are preferred. The cultural and social patterns should be taken into account.
- The provision of material for temporary shelters is a high priority when refugees first arrive. These should preferably be single-family shelters, constructed out of local material (when available) by the refugees themselves.

## Key References

1. Médecins Sans Frontières. *Public health engineering in emergency situations*. Paris: Médecins Sans Frontières, 1994.
2. UNHCR. *Handbook for Emergencies*. Geneva: UNHCR, 1982.

## Other References

3. Toole, M J, Waldman, R J. Prevention of excess mortality in refugees and displaced populations in developing countries. *JAMA*, 1990, 263(24): 3296-302.
4. Simmonds, S, Vaughan, P, William Gunn, S. *Refugee community health care*. Oxford: Oxford University Press, 1983.
5. Oxfam. *Plastic sheeting*. Oxford: Oxfam, 1989.
6. Médecins Sans Frontières. *Prise en charge d'une épidémie de choléra en camp de réfugié*. Paris, Médecins Sans Frontières, 1995.
7. Harell-Bond, B, Leopold, M. *Counting the refugees: The myth of accountability*. [Symposium] London: Refugee Studies Programme, 1993.
8. Van Damme, W. Do refugees belong in camps? Experiences from Goma and Guinea, *The Lancet*, 1995, 346(8971): 360-2.
9. Kent Harding D. *Camp planning*. [draft]. Geneva: UNHCR, 1987.
10. Govaerts, P. *Report on UNHCR shelter workshop, February 1993*. [Internal report]. Brussels: Médecins Sans Frontières, 1993.



**FM 21-10**  
**MCRP 4-11.1D**

# **FIELD HYGIENE AND SANITATION**

**HEADQUARTERS, DEPARTMENT OF THE ARMY  
AND COMMANDANT, MARINE CORPS**

**DISTRIBUTION RESTRICTION:** Approved for public release; distribution is unlimited.

# FIELD HYGIENE AND SANITATION

## TABLE OF CONTENTS

	<b>Page</b>
<b>PREFACE</b> .....	iii
<b>CHAPTER 1. INTRODUCTION TO THE MEDICAL THREAT</b>	
Section I. Message to the Unit Commander .....	1-1
Section II. The Medical Threat and Principles of Preventive Medicine Measures .....	1-3
<b>CHAPTER 2. INDIVIDUAL PREVENTIVE MEDICINE MEASURES</b>	
Section I. Heat Injuries .....	2-1
Section II. Cold Injuries .....	2-6

\*This publication supersedes FM 21-10, 22 November 1988.

	<b>Page</b>
Section III. Arthropods and Other Animals of Medical Importance .....	2-13
Section IV. Poisonous Plants and Toxic Fruits .....	2-21
Section V. Food-/Water-/Wasteborne Disease/Illness .....	2-22
Section VI. Personal Hygiene and Physical and Mental Fitness .....	2-30
Section VII. Noise .....	2-37
Section VIII. Toxic Industrial Chemicals/Materials .....	2-38

### **CHAPTER 3. LEADERS' PREVENTIVE MEDICINE MEASURES**

Section I. Heat Injuries .....	3-1
Section II. Cold Injuries .....	3-9
Section III. Arthropods and Other Animals of Medical Importance .....	3-17
Section IV. Poisonous Plants and Toxic Fruits .....	3-21
Section V. Food-/Water-/Wasteborne Disease/Illness .....	3-22
Section VI. Personal Hygiene and Physical and Mental Fitness .....	3-26
Section VII. Noise .....	3-31
Section VIII. Toxic Industrial Chemicals/Materials .....	3-33

### **CHAPTER 4. UNIT FIELD SANITATION TEAM**

Field Sanitation Team Concept .....	4-1
Scope of Field Sanitation Team Operations .....	4-1
Field Sanitation Team Tasks .....	4-2
Selection of Personnel .....	4-4
Training .....	4-4
How to Make Your Field Sanitation Team the Best in the Command ....	4-5

	<b>Page</b>
<b>APPENDIX A. UNIT-LEVEL PREVENTIVE MEDICINE MEASURES TASKS</b>	
TASK 1. Control Biting Insects .....	A-1
TASK 2. Use the 1-Gallon or 2-Gallon Compressed Air Sprayer .....	A-10
TASK 3. Control Domestic Rodents .....	A-14
TASK 4. Prevent Injuries Due to Venomous Snakebite .....	A-16
TASK 5. Inspect Unit Food Service Operations .....	A-17
TASK 6. Inspect Water Containers .....	A-22
TASK 7. Check Unit Water Supply for Chlorine Residual .....	A-27
TASK 8. Chlorinate Water Supplies .....	A-29
TASK 9. Set Up, Construct, and Maintain Field Waste Disposal Devices .....	A-32
TASK 10. Construct and Maintain Field Handwashing and Shower Devices .....	A-46
 <b>GLOSSARY</b> .....	 Glossary-1
 <b>REFERENCES</b> .....	 References-1
 <b>INDEX</b> .....	 Index-1

## **PREFACE**

The purpose of this publication is to assist individual service members, unit commanders, unit leaders, and field sanitation teams (FSTs) in preventing disease and nonbattle injury (DNBI). The publication provides information on preventive medicine measures (PMM)

## FM 21-10/MCRP 4-11.1D

for the individual service member as well as essential information for the unit commander, unit leaders, and the FST on applying unit-level PMM.

When a problem exists beyond unit capabilities, the brigade or division preventive medicine (PVNTMED) section or corps PVNTMED detachments should be called upon to assist in countering the threat.

The use of trade names or trademarks does not constitute endorsement by the Department of Defense (DOD).

Unless this publication states otherwise, masculine nouns and pronouns do not refer exclusively to men.

The proponent of this publication is the United States (US) Army Medical Department Center and School. Submit changes for improving this publication on Department of the Army (DA) Form 2028 and forward it directly to **Commander, US Army Medical Department Center and School, ATTN: MCCS-FCD-L, 1400 East Grayson Street, Fort Sam Houston, Texas 78234-6175.**

## CHAPTER 1

**INTRODUCTION TO THE MEDICAL THREAT****Section I. MESSAGE TO THE UNIT COMMANDER****DISEASE AND NONBATTLE INJURY**

A DNBI casualty can be defined as a military person who is lost to an organization by reason of disease or injury, and who is not a battle casualty. This definition includes persons who are dying of disease or injury due to accidents directly related to the operation or mission to which they were deployed. The acronym, DNBI, does not include service members missing involuntarily because of enemy action or being interned by the enemy (as a prisoner of war). The total number of DNBI casualties is evaluated to identify DNBI rates per number of service members in an operation. The DNBI rates are critical in evaluating the effectiveness of PVNTMED missions within the area of operations (AO) and in determining the health of a force within an operation.

Historically, in every conflict the US has been involved in, only 20 percent of all hospital admissions have been from combat injuries. The other 80 percent have been from DNBI. Excluded from these figures are vast numbers of service members with decreased combat effectiveness due to DNBI not serious enough for hospital admission.

## **FM 21-10/MCRP 4-11.1D**

Preventive medicine measures are simple, common sense actions that any service member can perform and every leader must know. The application of PMM can significantly reduce time loss due to DNBI.

*How Much Time Does Your Unit Spend Training Service Members on—  
Disease and Nonbattle Injury Prevention?  
Combat Injury Prevention?*

### **YOUR RESPONSIBILITY**

You are responsible for all aspects of health and sanitation of your command. Only you can make command decisions concerning the health of your unit in consideration of the—

- Mission.
- Medical threat.
- Condition of troops.

### **DO NOT LET THIS HAPPEN TO YOU**

*Togatabu Island, 1942:* The 134th Artillery and the 404th Engineer Battalions were part of a task force preparing to attack Guadalcanal. Fifty-five percent of the engineers and sixty-five

percent of the artillerymen contracted a disease called *filariasis* transmitted by mosquitoes. Both units had to be replaced (medically evacuated) without seeing any enemy action because they were not combat ready. The use of insect repellents and insecticides and the elimination of standing water would have prevented this.

*Merrill's Marauders*: Disease was an important detractor to this famous unit. The medical threat faced by the Marauders in the jungles of Burma was great. Everyone was sick, but some had to stay and fight. Evacuation was limited to those with high fever and severe illness. One entire platoon cut the seats from their pants because severe diarrhea had to be relieved during gunfights. After a bold and successful attack on a major airfield, Merrill's Marauders were so decimated by disease that they were disbanded.

## **Section II. THE MEDICAL THREAT AND PRINCIPLES OF PREVENTIVE MEDICINE MEASURES**

The medical threat is—

- Heat.
- Cold.
- Arthropods and other animals.



## **FM 21-10/MCRP 4-11.1D**

- Food- and waterborne diseases.
- Toxic industrial chemicals/materials.
- Noise.
- Nonbattle injury.
- The unfit service member.

## **PRINCIPLES OF PREVENTIVE MEDICINE MEASURES**

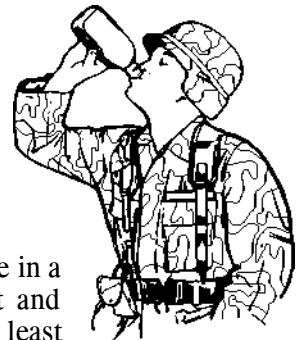
- Service members perform individual techniques of PMM.
- Chain of command plans for and enforces PMM.
- Field sanitation teams train service members in PMM and advise the commander and unit leaders on implementation of unit-level PMM.

***Failure to Apply the Principles of PMM Can Result in Mission Failure.***

## CHAPTER 2

**INDIVIDUAL PREVENTIVE MEDICINE MEASURES****Section I. HEAT INJURIES****OVERVIEW**

Heat injuries can occur anywhere, depending on physical activity (work rate) and clothing worn. However, they occur most frequently during warm-weather training, exposure to high climatic temperatures, high humidity, and bright sunlight. These conditions make it difficult for the body to regulate its temperature. Hot weather also increases daily water requirements, because body water is lost as sweat. Dehydration leads to added heat stress, increased susceptibility to heat injury, reduced work performance, and degraded mission capability.

**ACCLIMATIZATION**

When the mission permits, all personnel should work and exercise in a manner so that they gradually become acclimatized to the heat and humidity in the AO. Significant heat acclimatization requires at least

3 to 5 days and full acclimatization can take up to 2 weeks. Exercising in the heat and humidity for 1 to 2 hours daily, gradually increasing the workload each day, can produce acclimatization. (Refer to Table 3-1 in Chapter 3.) When the mission does not permit time for gradual increases in workload, then leaders and buddies must observe each other and ensure that everyone drinks plenty of water during each work period. Individuals leaving a cold or cool climate will require additional time to become acclimatized to a hot climate.

### DRINK PLENTY OF WATER

Depending on the heat and activity level, you may need to drink from  $\frac{1}{2}$  to  $1\frac{1}{4}$  quarts of water per hour—*3 gallons/12 liters per day in hot, dry climates*. **Drinking water is a must in order to prevent heat injury.** If desired, individuals may add flavoring to the water to enhance consumption. Field rations/meal(s), ready to eat (MRE) have flavoring for water in each meal. If the flavoring is used, add it to water in your canteen cup. **Do not** add flavoring to the water in your canteen; it increases the risk of contamination and illness. Never flavor the bulk source water supply. (Flavoring the bulk source water supply will reduce the action of water disinfectants.) See Table 3-1 for water intake requirements.

- Drink extra water **before** starting any mission or hard work. Cool water (60° to 70° Fahrenheit [F]) is absorbed faster than cold water.
- Drink small quantities of cool fluids frequently. Carbohydrate/electrolyte beverages (sport drinks) may provide supplemental nutrients under conditions of extreme calorie and water requirements; such as extremely vigorous activity. However, they cannot replace and must not be used to meet all water requirements.

- Drink “non-caffeinated” fluids even if you are not thirsty. (Caffeine increases water requirements in all environments.)
- Refill your canteens at every opportunity, using only treated water, if possible.

### NOTE

The color and volume of the urine stream are good indicators of a service member’s hydration status. If your urine stream is **dark yellow** and the volume is small, or if you are constipated and experience hard stools, you may not be drinking enough water. Maintain a urine stream that is **clear or light yellow**. Thirst is not a good indicator of dehydration during physical activity.

### USE WORK/REST CYCLES

- Work and rest as your leader directs. (See Table 3-1.) A rest period helps prevent dangerous increases in body temperatures by minimizing heat production.
- Work and rest in the shade, if possible.

## EAT ALL MEALS TO REPLACE SALTS

Eating all meals in the field will usually provide the body's requirements for salts. Field rations/MRE meet the daily requirements for minerals and electrolytes (sodium). **DO NOT take extra salt in meals** unless medically indicated.



### NOTE

**DO NOT TAKE SALT TABLETS.** One salt tablet increases your water requirement by at least a pint. Salt draws water from muscles to dilute your blood. Salt tablets can cause vomiting.

## RECOGNIZE THE RISK OF MISSION-ORIENTED PROTECTIVE POSTURE/BODY ARMOR/ARMORED VEHICLES

- Mission-oriented protective posture (MOPP)/body armor increases your heat stress. (See Table 3-1.) You must—
  - Drink more water. **DO NOT EXCEED 1<sup>1</sup>/<sub>4</sub> QUARTS PER HOUR.**
  - Work and rest as your leader directs.

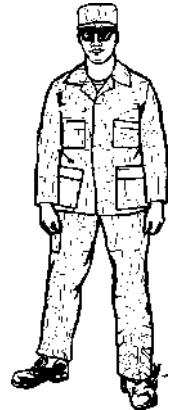


- You may be at a greater risk of heat injuries when in armored vehicles—you may need to drink more water.

## MODIFY YOUR UNIFORM

When directed/authorized by your commander to reduce heat stress and to protect against ultraviolet (UV) radiation, you should—

- Unblouse pants from boots.
- Cover all skin exposed to sun; wear sunscreen and lip balm with a sun protection factor of 15 or higher.
- Protect the eyes from UV with UV-protective sunglasses, especially wraparound sunglasses.
- Seek shade when resting outdoors.
- Keep clothing loose at the neck, wrists, and lower legs.



### NOTE

When the threat from biting arthropods is high, keep your shirtsleeves rolled down and pants bloused in boots.

**NOTE**

See Graphic Training Aid (GTA) 8-5-50 and FM 21-11, for information on heat injury prevention and first aid.

## **Section II. COLD INJURIES**

### **OVERVIEW**

Cold injuries are most likely to occur when an unprepared individual is exposed to winter temperatures. They can even occur with the proper planning and equipment. The cold weather and the type of operation in which the individual is involved impact on whether a service member is likely to be injured and to what extent. The service member's clothing, physical condition, and mental makeup are also determining factors. Well-disciplined and well-trained service members can be protected, even in the most adverse conditions. Service members and their leaders must know the hazards of exposure to the cold. They must know the importance of personal hygiene, exercise, care of the feet and hands, and the use of protective clothing. Cold injuries may be divided into "freezing and nonfreezing" types. A freezing type is frostbite. The nonfreezing types are chilblains, trench foot, and immersion foot. (See FM 21-11.)

- Frostbite can occur when the temperature is at or near freezing or colder. Frostbite can also occur when the skin is exposed to winds of less than five miles per hour and actual temperature readings of 30° F.

- Trench foot (and immersion foot) results from prolonged exposure to a wet, cold condition, or the outright immersion of the feet in water with a temperature usually below 50° F.
- At the upper range of temperatures, exposure of 12 hours or more will cause injury. Shorter duration at or near 32° F will cause the same injury.
- A trench foot injury is usually associated with immobilization of the feet.

## WEAR UNIFORM PROPERLY

- Wear the clothing your commander and leaders direct.
- Wear clothing in loose layers (top and bottom). Avoid tight clothing, including tight underwear.
- Keep clothing clean and dry. Remove or loosen excess clothing when working or in heated areas to prevent sweating.
- Wear headgear to prevent body heat loss. The body loses large amounts of heat through the head.
- Avoid spilling fuel or other liquids on clothing or skin. Evaporating liquids increase heat loss and cool the skin. Also, liquid stains on clothing will reduce the clothing's protective effects.





- Change wet/damp clothes as soon as possible. Wet/damp clothing pulls heat from body.

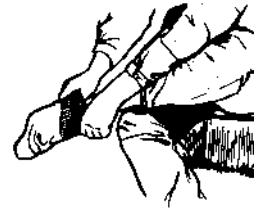
## **KEEP YOUR BODY WARM**

- Keep moving, if possible.
- Exercise your big muscles (arms, shoulders, trunk, and legs) frequently to keep warm.
- If you must remain in a small area, exercise your toes, feet, fingers, and hands.
- Avoid the use of alcohol as it makes your body lose heat faster.
- Avoid standing directly on cold, wet ground, when possible.
- Avoid tobacco products. The use of tobacco products decreases blood flow to your skin.
- Eat all meals to maintain energy.
- Drink plenty of water and/or warm nonalcoholic fluids. Dark yellow urine means you are not drinking enough fluids! You can dehydrate in cold climates too!
- Buddies should monitor each other for cold weather injury.



## PROTECT YOUR FEET

- Bring several pairs of issue boot socks with you.
- Keep socks clean and dry. Change wet or damp socks as soon as possible. Socks can become wet from sweating. Apply foot powder on feet and in boots when changing socks.
- Wash your feet daily, if possible.
- Avoid tight socks and boots (completely lace boots up as loosely as possible).
- Wear overshoes to keep boots dry.



### NOTE

A decrease in physical activity reduces the exposure **time necessary to produce injury**. In all types of footgear, feet perspire more and are generally less well ventilated than other parts of the body. Moisture accumulates in socks, decreasing their insulating quality. The feet are susceptible to cold injury and are less frequently observed than the remainder of the body.

## PROTECT YOUR HANDS

- Wear gloves with inserts, or mittens with inserts.

## FM 21-10/MCRP 4-11.1D

- Warm hands under clothing if they become numb.
- Avoid skin contact with snow, fuel, or bare metal.
- Waterproof gloves by treating with waterproofing compounds, such as snow seal.



### PROTECT YOUR FACE AND EARS

- Cover your face and ears with a scarf or other material, if available.
- Wear your insulated cap with flaps down or wear a balaclava and secure under your chin.
- Warm your face and ears by covering them with your hands. **Do not rub face** and ears.
- Do not use face camouflage when windchill is  $-10^{\circ}$  F or below; prevents detection of cold weather injury (frostbite).

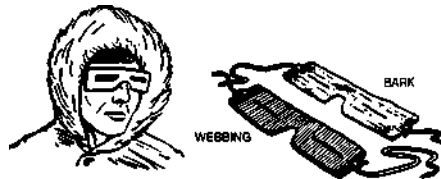
### NOTE

Rubbing cold extremities can be potentially harmful. Frostbitten areas that are rubbed can cause additional injury to the affected areas.

- Wear sunscreen. Solar UV exposure is doubled when you are surrounded by snow.
- Exercise facial muscles.

## PROTECT YOUR EYES

- Wear sunglasses (or goggles) (Sun, Wind, and Dust, National Stock Number [NSN] 8465-01-004-2893) to prevent snow blindness (gray lens insert for above system is NSN 8465-01-004-2891).
- Wear Spectacles, Protective, Laser-Ballistic, NSN 8465-01-416-4626, or Special Protective Eyewear, Cylindrical System, NSN 8465-01-416-4626.
- Improvised sunglasses (slit goggles), if actual sunglasses are not available, can be made from the field rations/MRE cardboard box or other opaque material.



## PROTECT YOUR BUDDY

- Watch for signs of frostbite on the service member's exposed skin. The affected skin will appear as pale/gray/waxy areas (it may be hard to see these changes in poor lighting or on service members with dark skin).
- Ask the service member if his feet, hands, ears, or face are numb and need rewarming.



- **DO NOT** allow the service member to sleep directly on the ground.
- To prevent carbon monoxide poisoning—
  - **DO NOT** let the service member sleep in or near the exhaust of a vehicle with the engine running.
  - **DO NOT** let the service member sleep in an enclosed area where an open fire is burning

**NOTE**

Service members may check circulation in the fingers and the toes by pinching the nail beds and checking how fast the color returns in the beds under the nails. The slower the return to a natural color, the more serious the potential for frostbite on the fingers and the toes.

**NOTE**

See GTA 8-6-12 and FM 21-11 for information on cold injury first aid procedures. During extended activities in a cold environment, warming areas should be provided; for example, a service member performing guard duty.

## **Section III. ARTHROPODS AND OTHER ANIMALS OF MEDICAL IMPORTANCE**

### **OVERVIEW**

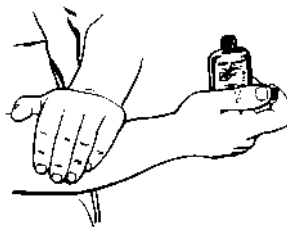
Poor sanitation and improper waste disposal under wartime conditions greatly increase the disease vector potential of such common pests as filth flies and rodents. Even in mobile field situations these “camp followers” have historically amplified sanitation problems, often resulting in epidemics of diarrheal diseases that have caused many casualties. This threat is even greater in urban areas converted to temporary or semipermanent military use. A dangerous temptation in field training or in deployment operations is to ignore the field sanitation standards. Some people think, “The rules don’t apply here.” Yielding to that temptation can cost your health and the health of those around you. There is no excuse for forgetting to bring protective equipment or failing to use it. Be sure to follow all safety precautions on all labels of the pesticides that you use. They are there for a reason—to protect your health.

### **USE THE DEPARTMENT OF DEFENSE INSECT/ARTHROPOD REPELLENTS**

The concurrent use of a skin insect repellent (N, N-diethyl-M-toluamide [DEET], NSN 6840-01-284-3982) and a clothing insect repellent (permethrin [NSN 6840-01-278-1336 and 6840-01-345-0237]) is necessary to obtain maximum protection against insects/arthropods.

## APPLY N, N-DIETHYL-M-TOLUAMIDE

- Apply DEET insect repellent to all exposed skin.
- Follow label directions.
- Apply a light, even coating to exposed skin, not under clothing.
- **DO NOT** apply to the eyes and lips, or to damaged skin.
- One application may last 8 to 12 hours; if you receive bites, reapply a light uniform coating of repellent.
- Application of DEET can be safely used with camouflage face paint. Apply a thin layer of DEET first, then apply face paint.

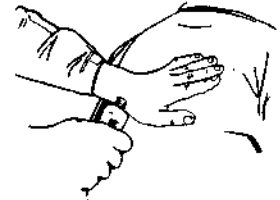


### NOTE

Reapplication of DEET may be necessary (check container label) due to heavy sweating, or after river-crossing operations, exposure to rain, or in locations where arthropod density is very high.

## APPLY PERMETHRIN CLOTHING REPELLENTS TO FIELD UNIFORMS/ SLEEPING EQUIPMENT

- Permethrin is the most effective clothing repellent available.
- Treat military field uniforms, including Nomex®/Kevlar uniforms, tent liners, ground cloths, and bed nets with permethrin. This should be done before wearing in field training or military operations. **Follow label instructions when applying to clothing.**
- Permethrin will remain in the material after repeated washings.
- Treated uniforms can be safely worn in the rain or when crossing rivers or streams.



### NOTE

Permethrin does not rinse out in cold water (or rain or streams).

- **DO NOT** apply directly to skin, to underwear, or to cap.
- **DO NOT** wear treated uniforms unless they are first thoroughly dried after treating.
- **Apply permethrin outdoors or in well-ventilated areas only.**



## **FM 21-10/MCRP 4-11.1D**

- Wear uniform as your commander directs.
- Wear a loose fitting uniform, not tightly tailored, to prevent arthropods from biting through the fabric; repair tears/holes.
- When the arthropod threat is high—
  - Blouse pants in boots and completely lace boots.
  - Tuck undershirt in at waist.
  - Wear sleeves down.
  - Button blouse/shirt at the neck and wrist.
  - Do not use aftershave lotion, cologne, or perfumed deodorants or soaps in the field; they attract arthropods.
  - Wear headgear (cap, helmet, arthropod head net) when necessary to protect your head.

## **KEEP YOUR BODY AND UNIFORM CLEAN**

- Bathe every day if possible, or at least once a week. Good personal hygiene practices reduce infestation of insects such as body lice and mites.

- Wash your uniform frequently (a minimum of every 7 days) to remove arthropods and their eggs which may be attached to the uniform. If the situation permits, use the quartermaster laundry; otherwise, use a stream, lake, or washbasin. Air-dry uniforms, especially underwear and socks, if possible.

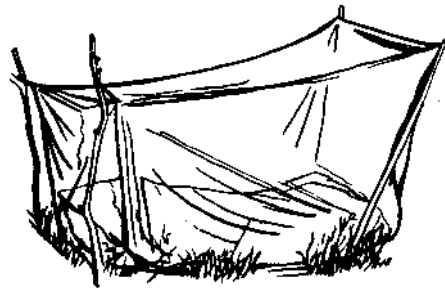


### **FOLLOW MEDICAL ADVICE**

- Take medications that help prevent diseases (such as anti-malaria pills) when directed by your commander.
- Use medications, such as cream/shampoo, when prescribed by medical personnel for treatment of lice, chiggers, poison ivy, and so forth.

### **PROTECT YOURSELF AT NIGHT**

- Ensure your bed net is in good repair.
- Use your bed net when sleeping.
- Tuck net under sleeping pad or sleeping bag so there are no openings.



## **FM 21-10/MCRP 4-11.1D**

- Follow the label directions and precautions when using DOD-approved insect spray (for example, Insecticide, Aerosol d-PHENOTHRIN, 2%) if insects are present inside the bed net (and inside closed tent). Allow vapors to disperse for 10 minutes before entering the enclosure.
- Treat bed net with permethrin for added protection.
- Repair holes in your bed net. Generously apply DEET skin repellent to those areas likely to touch the insect net during sleep (knees, hands, elbows, and feet) to prevent bites through holes in the fabric.

## **PROTECT YOURSELF FROM OTHER MEDICALLY IMPORTANT ARTHROPODS AND ANIMALS**

Spiders, Scorpions, and Centipedes—

- Remove spiders from tents or buildings.
- Shake out and inspect clothing, shoes, and bedding before use.
- Eliminate collections of papers, unused boxes, scrap lumber, and metal.
- Thoroughly clean beneath and behind large items; spiders and scorpions may be resting in these areas.

- Check field latrines before use; run a small stick under the rim of the latrine hole to dislodge any spiders or scorpions there. Spiders and scorpions may rest under toilet seat or inside latrine box.
- Wear gloves when handling paper, cloth, lumber, or other items that have been stored for long periods.
- Check around rocks and logs before resting against them.
- Use a long-handled tool or stick to turn over debris before removing it.
- Remove accumulations of boards, rocks, and other debris to eliminate the resting/hiding areas of spiders and scorpions.
- Wear leather gloves to remove rocks, lumber, and such from the ground.

### **NOTE**

In many locations worldwide, centipedes are more of a problem than scorpions, but the PMM are the same for both pests.

#### Snakes—

- Do not handle, play with, or disturb snakes or other wildlife.

## FM 21-10/MCRP 4-11.1D

- Avoid swimming in areas where snakes abound.
- Keep hands off rock ledges where snakes may be hiding or sunning.
- Look over the area before sitting down, especially if in deep grass or among rocks.
- If snakes are known to inhabit the area, sleep off the ground, if possible.
- If military situation permits, avoid walking about an area during the period from dusk to complete daylight, as many snakes are active during this period.
- Avoid camping near piles of brush, rocks, or other debris.
- Never step over large rocks or logs without first checking to see what is on the other side.
- Turn rocks and logs toward you when they have to be removed so you will be shielded should snakes be beneath them.
- Handle freshly killed snakes only with a long-handled tool or stick; snakes can inflict fatal bites by reflex action after their death.

## NOTE

If bitten, try to kill the snake and bring its head with you to the medical treatment facility. If you cannot bring the snake's head with you, get an accurate description of the snake to assist medical personnel in treating you. **DO NOT panic!**

## DOMESTIC AND WILD ANIMALS OR BIRDS

- **Do not** handle or approach so-called “pets.”
- Exclude such animals from your work and living areas, unless cleared by veterinary personnel.
- **Do not** collect or support (feed or shelter) stray or domestic animals/birds in the unit area, unless cleared by veterinary personnel.

## Section IV. POISONOUS PLANTS AND TOXIC FRUITS

### OVERVIEW

Many poisonous plants have thorns that can puncture the skin, introduce poison into the skin, or cause infection. (See FM 21-76.) Clothing can serve as a protective barrier for

the skin. Clothing can also be a source of exposure if it is not properly cleaned after contact with poisonous plants. Toxic fruits can also cause significant harm to service members, ranging from minor wounds to rapidly fatal poisoning. The threat is magnified for US military personnel who may be unfamiliar with native species and unaware of these poisonous plants and toxic fruits.

- Avoid contact with poisonous plants by properly wearing the uniform.
- Avoid areas where poisonous plants grow.
- Only eat plants or parts of plants that have been approved. If you do not know, **DO NOT** eat it.
- **DO NOT** put grasses or woody twigs or stems in your mouth; they may be poisonous.

## **Section V. FOOD-/WATER-/WASTEBORNE DISEASE/ILLNESS**

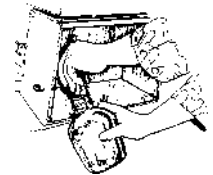
### **OVERVIEW**

Prior to deployment, the key to preventing illnesses and diseases from consumption of food and water is following the strict guidelines and procedures established by PVNTMED. During deployments, apply individual PMM. Infectious diarrhea results from contamination of water and food by bacteria, viruses, and parasites. Water- and foodborne

diarrheal diseases are of particular concern to the military because they can be spread to large numbers of service members simultaneously with disastrous consequences for combat readiness. Parasites (amoebas, Giardia, and tapeworms) consumed in water or undercooked food, especially meat and fish, can cause prolonged illness. Diarrhea, especially when vomiting or fever is present, can cause dehydration.

## WATER

Fill your canteen with treated water at every chance. When treated water is not available, you must disinfect the water in your canteen using one of the following methods.



Preferred method—iodine tablets:

- Fill your canteen with the cleanest water available.
- Put two iodine tablets in the canteen of water. Double these amounts in the 2-quart canteen.
- Place cap on canteen. Shake canteen to dissolve tablets. Wait 5 minutes. Loosen the cap and tip the canteen over to allow leakage around the canteen threads. Tighten the cap and wait an additional 25 minutes before drinking.





Alternate methods—

Chlorine Ampules:

- Fill your canteen with the cleanest water available.
- Mix one ampule of chlorine with one-half canteen cup of water; stir the mixture with a clean device until contents are fully dissolved.
- Pour one canteen capful of the above solution into your canteen of water.
- Place the cap on your canteen and shake. Slightly loosen the cap and tip the canteen over to allow leakage around threads. Tighten cap and wait 30 minutes before drinking.
- If the nuclear, biological, and chemical (NBC) canteen cap is used, then use two caps of the solution.

**NOTE**

By wearing gloves or wrapping the ampule in paper or cloth, you can avoid cutting your hands when breaking open the glass ampule.

Emergency Water Treatment Kit (CHLOR-FLOC® Tablets):

- Tear off the top of the plastic water treatment bag at the perforation (first time use).

- Fill the treatment bag one-half full with the cleanest water available; add 1 tablet.
- Fold bag tightly three times and fold tabs in.
- Hold bag firmly and shake until tablet dissolves. Swirl 10 seconds. Let the bag sit for 4 minutes. Swirl again for 10 seconds.
- Let bag sit for an additional 15 minutes.
- Insert filter pouch in neck of canteen. Pour water from bag through the filter into the canteen. Avoid pouring sediment into the filter.
- Rinse the filter with treated water after use. Always filter through the same side of the filter.
- Rinse sediment from treatment bag. Save bag for water treatment only.

**CAUTION**

Do not drink from the treatment bag! The water is still contaminated and must be filtered before drinking. Not filtering may cause stomach and intestinal disorders.

## Household Bleach:

**NOTE**

Ensure bleach is unscented. (To check for chlorine residual, see Tasks 7 and 8, Appendix A.)

- Fill your canteen with the cleanest water possible.
- Read the label on the bleach bottle to determine amount of available chlorine. Liquid chlorine laundry bleach usually has about 5 to 6 percent available chlorine. Based upon the strength of the household bleach, add the chlorine to the canteen as directed in Table 2-1.

*Table 2-1. Drops of Household Bleach to be Added to a One-Quart Canteen*

<b>AVAILABLE CHLORINE</b>	<b>CLEAR WATER</b>	<b>COLD OR CLOUDY WATER</b>
1 PERCENT	10	20
4—6 PERCENT	2	4
7—10 PERCENT	1	2

- Place the cap on your canteen and shake. Slightly loosen the cap and tip the canteen over to allow leakage around threads. Tighten the cap and wait 30 minutes before drinking the water.

## **BOILING**

- When chlorine or iodine is not available, bring water to a rolling boil for 5 minutes.
- In an emergency, boiling water for just 15 seconds will help. Boiled water must be protected from recontamination.

### **CAUTION**

If water is suspected of NBC contamination, do not attempt to treat.  
Seek a quartermaster water supply.

## **FOOD**

- Do not buy foods, drinks, or ice from civilian vendors unless approved by veterinary personnel or PVNTMED personnel.

**CAUTION**

Obtain food from approved sources **ONLY**.

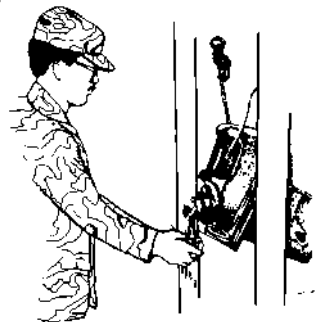
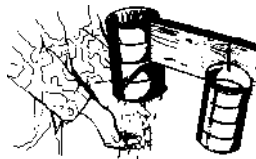
- In emergency situations, choose low-risk foods such as baked goods (breads) and thick-skinned fruits that you can peel before eating. Eat only fruits and vegetables that grow above the ground.
- When eating in local establishments or from approved vendors, only eat hot food entrees or raw foods that you can wash and peel prior to eating.
- Inspect all cans and food packets prior to use. Discard all cans with leaks or bulges. Discard food packets with visible holes or obvious signs of deterioration.
- Do not eat foods or drink beverages that have been prepared in galvanized containers (*zinc poisoning*). Canned, bottled, or vacuum-packed products should draw in air when opened (suction/hissing sound). If no sound is heard, or if there are any off-odors, colors, or foaming (except for carbonated beverages), discard the product. Do not taste.
- Do not eat or drink local (unapproved) ice, snow cones, open drinks with ice, or similar products; such food can cause foodborne illness/disease.



## WASH YOUR HANDS

Use soap and drinking (potable) water—

- After using the latrine.
- Before touching eating utensils or food.
- After eating.
- After handling any item that can potentially transfer germs.
- Frequently during the work day to keep your hands free of germs.



## WASH YOUR MESS KIT/EATING UTENSILS

A sure way to get diarrhea is to use a dirty mess kit or eating utensils. Protect yourself by washing your mess kit/eating utensils—

- In a mess kit laundry/sanitation center.
- With treated water or disinfectant solution.

## DISPOSE OF YOUR WASTE IN AN APPROVED MANNER

On a march, personal disposal bags should be used first, if available. If not available, personal cat holes can be used only if your unit is on the move! Always dispose of your waste immediately if your unit is on the move to prevent flies from spreading germs from waste to your food. Disposing of your waste also helps keep unwanted animals out of your bivouac area. Chemical toilets or burnouts are to be used in bivouac area. (See Chapter 3, Section V.)



## Section VI. PERSONAL HYGIENE AND PHYSICAL AND MENTAL FITNESS

### OVERVIEW

Physically fit, well-trained, and well-led service members can succeed under the harshest circumstances.

### KEEP PHYSICALLY FIT

- Physically fit service members are less likely to get sick or injured.



- Use caution when exercising in extremely hot or cold weather; heat/cold injuries can occur. Actively participating in physical fitness training assists you in becoming acclimatized to the field environment.



### NOTE

See FM 21-20 for more information on physical fitness training.

### PREVENT SKIN INFECTIONS

Bathe frequently; if showers or baths are not available, use a washcloth daily to wash—

- Your genital area.
- Your armpits.
- Your feet.
- Other areas where you sweat or that become wet, such as between thighs, (or for females, under the breasts) and between buttocks.





Keep skin dry.

- Use foot powder on your feet, especially if you have had fungal infections on your feet in the past.
- Use talcum powder in areas where wetness is a problem (such as between the thighs, and for females, under the breasts).



Wear proper clothing.

- Wear loose fitting uniforms; they allow for better ventilation. Tight fitting uniforms reduce blood circulation and ventilation.
- Do not wear nylon or silk-type undergarments in hot or humid environments.

## PREPARE FOR THE FIELD

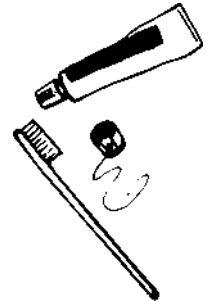
- All service members need to bring toilet articles such as soap, shampoo, washcloths, towels, toothbrush, dental floss and fluoride toothpaste, and talcum powder and foot powder, with them. **Do not share these items** to prevent the spreading of infections.
- Males need a razor and blades. Females need sanitary napkins or tampons.

*Remember, during a deployment, you may not be able to easily obtain these items if you run out; bring at least a 2-month supply.*

## PREVENT DENTAL DISEASE

Tooth decay and gum infections can cause severe illness if not prevented or treated early.

- Brush teeth and gums after meals, or at least once a day. Use fluoride toothpaste. If toothpaste is not available, brush without it.
- Use dental floss at least once a day.
- Rinse your mouth with potable water after brushing and flossing; also, rinse frequently during the day when drinking water.
- Remember, consuming sugary food and drink requires more frequent cleaning of teeth and gums.



## PREVENT GENITAL AND URINARY TRACT INFECTIONS

For males:

- Wash the head of your penis when washing your genitals. If uncircumcised, pull the foreskin back before washing.
- Protect yourself from sexually transmitted diseases (STD). Avoid sexual contact or use a condom; condoms reduce the chance of STD transmission.

For females:

- Wash your genital area daily.
- Do not use perfumed soaps or feminine deodorants in the field; they cause irritation and attract arthropods.
- Protect yourself from STD. Avoid sexual contact, or at least insist that your sex partner uses a condom—condoms help prevent STD transmission.
- **DO NOT** douche unless directed by medical personnel.
- **DO NOT** wear nylon or silk undergarments; cotton undergarments are more absorbent and allow the skin to dry.

#### NOTE

Some individuals do not drink enough fluids and tend to hold their urine due to a lack of privacy in the field. Urinary tract infections are one of the most frequent medical problems females face in the field. Drinking extra fluids and urinating more often will help prevent these infections.



## **SLEEP WHEN YOU CAN**

- Follow your leaders' instructions and share tasks with buddies so everyone gets some time to sleep safely.
- Sleep whenever possible.
  - Take catnaps as the mission allows, but expect to need a few minutes to fully wake up.
  - Sleep as much as you can *before* going on a mission that may prevent sleep.
  - Learn and practice techniques to relax yourself quickly.

### **NOTE**

Only sleep in safe and/or designated areas. Never sleep in parked vehicles while the motor is running.

## **MEASURES AGAINST THE EFFECTS OF SLEEP LOSS**

Protect against the temporary effects of sleep loss on alertness, mood, and task performance.

- Take short stretch breaks or get light exercise in place.

- **Do not trust your memory; write things down.** Get into the habit of writing things down that you must remember (except crucial details that might compromise the mission if they were lost or captured). Double-check your communications and calculations.
- Watch out for your mind playing tricks (seeing things that are not there) when very tired; check strange observations before acting.

## IMPROVE RESISTANCE TO STRESS

- Fear and physical signs or symptoms of stress are normal reactions before and during combat or other dangerous/life-threatening situations. You should not let fear or stress keep you from doing your job.
- Talk about what is happening with your buddies, especially during after-action debriefings.
- Learn ways to relax quickly.
- Integrate new replacements into your group and get to know them quickly.
- If you must join a new group, be active in establishing friendships.



- Give each other moral support.
- Care for your buddies and work together to provide everyone food, water, sleep, and shelter, and to protect against heat, cold, poor sanitation, and enemy action.

### NOTE

See FM 21-11 for first-aid procedures for stress reactions.

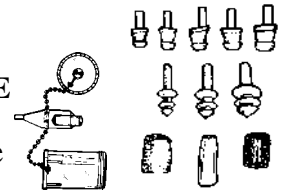
## Section VII. NOISE

### OVERVIEW

If you have to raise your voice to be understood, it is too noisy. Put on hearing protectors. The use of hearing protective devices will enhance hearing and comprehension in the presence of a hazardous noise.

### PROTECT YOURSELF AND YOUR MISSION FROM NOISE

- Wear properly fitted earplugs. Different types include single flange, triple flange, and hand formed.



- Use vehicle headgear such as a helicopter crew helmet, an armor crew helmet, or earmuffs.
- Keep earplugs and earmuffs clean to prevent ear infections.
- Avoid noise or limit time around noise to only critical tasks.



## **Section VIII. TOXIC INDUSTRIAL CHEMICALS/MATERIALS**

### **OVERVIEW**

Consider risk management in planning all operations; identify potential sources of danger or mission hazards that can be anticipated in performing a mission. Always weigh the risks and benefits and establish controls to reduce unnecessary hazards.

### **RECOGNIZE AND PREPARE FOR TOXIC INDUSTRIAL CHEMICALS/ MATERIAL THREATS**

Occupational hazards.

- Exhaust from engines and fuel space heaters.

- Gases from weapons firing, such as rockets and M8 smoke.

### NOTE

When using M8 smoke in training or operations, follow unit standing operating procedures (SOPs) and leaders and controller's instructions for use of protective masks and for moving through smoky areas, especially in buildings and tunnels.

- Solvents used to clean weapons.
- Greases and oil from vehicle maintenance repair.
- Detergents used to clean equipment.

#### Industrial hazards.

- Compressed gases.
- Industrial solvents.
- Hazardous chemical waste.



## **FM 21-10/MCRP 4-11.1D**

- Materials used at water treatment plants.
- Materials and water used at waste sewage and water treatment plants.

Biological/radiological hazards.

- Medical waste.
- Materials used at medical research facilities.
- Radioactive isotopes.
- Substances at nuclear power plants.
- Depleted uranium.

## **RECOGNIZE THE INJURY**

- Carbon monoxide is colorless, odorless, and tasteless. It causes headache, sleepiness, coma, and death.
- Hydrogen chloride is a very irritating gas that reacts with water (body fluids) to produce hydrochloric acid in the throat, lungs, and eyes. It causes coughing, tissue acid burns, and flu-like lung disease.

- M8 smoke is a very irritating gas. It can cause severe coughing, wheezing, and lung damage, if inhaled.
- Bore/gun gases cause the same effects as carbon monoxide and hydrogen chloride.
- Solvents, greases, and oils cause skin rashes, burns, drying, and infections. They cause damage to the liver, blood, and brain. Also, many are poisons that may cause cancer.
- Medical waste causes disease.
- Radioactive materials cause radiation illness.

**PROTECT YOURSELF AND YOUR MISSION FROM TOXIC INDUSTRIAL CHEMICALS/ MATERIALS**

**NOTE**

Service members should always be aware that material safety data sheets (MSDS) accompany stores of toxic chemicals when units are deployed, and they serve as an immediate reference in cases of exposure or injury. Once a unit is deployed and set up, these MSDS should be kept as part of the unit's SOP when handling the specified chemicals/materials.

Carbon monoxide.

- Run engines outdoors or with shop doors/windows open.
- Keep sleeping area windows slightly open where you sleep for ventilation and air movement.
- **DO NOT** sleep in vehicles with the engine running or use engine exhaust for heat.
- **DO NOT** park vehicles near air intakes to tents, trailers, or environmental control units.

Bore/gun gases.

- Use onboard vehicle ventilation systems.
- Keep bore evacuator well maintained.
- Try to keep some air movement in gun emplacements or in protected batteries.

Solvents, greases, and oils.

- Use “safety” Stoddard solvent.
- Never substitute one solvent for a “better” one; for example, never use benzene or fuel in place of Stoddard.

- Wear coveralls, if available, and rubber gloves.
- Wash or change clothing often, especially when soiled by chemicals or fuel.
- Always follow label instructions for use and safety precautions.
- Use ventilation systems in areas where fumes are present or when conditions and materials dictate.

Biological waste.

- Always use disposable rubber gloves when working with biological materials.
- Wear coveralls/rubberized aprons, as necessary.
- Wear goggles or safety glasses, as necessary.
- Wear facemasks and air-filtered breathing masks approved for specific tasks, as necessary, when removing/working with biological waste.
- Dispose of biological waste materials according to unit SOPs and product label instructions.

## CHAPTER 3

**LEADERS' PREVENTIVE MEDICINE MEASURES****NOTE**

In addition to the specific measures that follow, leaders must remember and apply the principle that the most effective PMM they can apply is to visibly set the example in the use of all the individual PMM that are discussed throughout this FM.

**Section I. HEAT INJURIES****PLAN FOR THE HEAT**

- Maximize physical fitness and heat acclimatization before deployment.
- Use your FST to train individuals and their leaders in PMM against heat.
- Acclimatize personnel to high temperatures as gradually as the mission will allow.

## FM 21-10/MCRP 4-11.1D

- Brief service members on dangers of sunburn and skin rashes and the importance of good personal field hygiene.
- Obtain weather forecast for time/area of training/mission.
- Ensure adequate supplies of potable water are available (up to 3 gallons per day per service member just for drinking) (See Table 3-1). Issue a second canteen to service members in hot weather operations. In the desert, additional canteens may be required.
- Know the location of water distribution points.
- Set up a buddy system to maximize rehydration and minimize heat injuries.
- Ensure medical support is available for treatment of heat injuries.
- Plan the placement of leaders to observe for and react to heat injuries in dispersed training (road marches), or operational missions.
- If the mission permits, plan to—
  - Train during the cooler morning hours.

- Serve heavy meals in the evening, rather than at noon.

## **OBTAIN AND USE HEAT CONDITION INFORMATION**

- Obtain heat condition information per your unit's SOP or contact the local supporting PVNTMED detachment or section. Heat condition may be reported as--
  - Category: 1, 2, 3, 4, and/or 5.
  - Wet bulb globe temperature (WBGT) index.
- Use heat condition information to determine required water intake and work/rest cycles (Table 3-1).

### **NOTE**

Training by lecture or demonstration, maintenance procedures on equipment, or personal hygiene activities (such as skin and foot care) can be performed during rest periods.

*Table 3-1. Fluid Replacement Guidelines for Warm Weather Training  
(Applies to Average Acclimated Service Member Wearing Hot Weather Uniform)*

HEAT CATEGORY	WBGT INDEX DEGREES F	EASY WORK		MODERATE WORK		HARD WORK	
		WORK/REST MIN	WATER INTAKE QT/HR	WORK/REST MIN	WATER INTAKE QT/HR	WORK/REST MIN	WATER INTAKE QT/HR
1	78-81.9	NL	1/2	NL	3/4	40/20	3/4
2 (GREEN)	82-84.9	NL	1/2	50/10	3/4	30/30	1
3 (YELLOW)	85-87.9	NL	3/4	40/20	3/4	30/30	1
4 (RED)	88-89.9	NL	3/4	30/30	3/4	20/40	1
5 (BLACK)	> 90	50/10	1	20/40	1	10/50	1

The work/rest times and fluid replacement volumes will sustain performance and hydration for at least 4 hours of work in the specified heat category. Individual water needs will vary  $\pm 1/4$  quart/hour.

NL= no limit to work time per hour.

Rest means minimal physical activity (sitting or standing) accomplished in shade, if possible.

**CAUTION:** Hourly fluid intake should not exceed 1 1/4 quarts.

Daily fluid intake **should not exceed 12 liters.**

Wearing body armor adds 5° F to WBGT Index.

Wearing all MOPP overgarments adds 10° F to WBGT Index.



*Table 3-1. Fluid Replacement Guidelines for Warm Weather Training (Continued)  
(Applies to Average Acclimated Service Member Wearing Hot Weather Uniform)*

EASY WORK	MODERATE WORK	HARD WORK
WEAPON MAINTENANCE WALKING HARD SURFACE AT 2.5 MPH, ≤ 30 LB LOAD GUARD DUTY MARKSMANSHIP TRAINING DRILL AND CEREMONY	WALKING LOOSE SAND AT 2.5 MPH, NO LOAD WALKING HARD SURFACE AT 3.5 MPH, ≤ 40 LB LOAD CALISTHENICS PATROLLING INDIVIDUAL MOVEMENT TECHNIQUES, SUCH AS LOW CRAWL, HIGH CRAWL DEFENSIVE POSITION CONSTRUCTION	WALKING HARD SURFACE AT 3.5 MPH, ≥ 40 LB LOAD WALKING ON LOOSE SAND AT 2.5 MPH WITH LOAD FIELD ASSAULTS

### **WARNING**

**Hourly fluid intake should not exceed 1<sup>1</sup>/<sub>4</sub> quarts. Daily fluid intake should not exceed 12 liters.**

## ENFORCE INDIVIDUAL PREVENTIVE MEDICINE MEASURES

Leaders must—

- Enforce water intake by—
  - Observing service members drinking required amounts. Encourage frequent drinking of water in small amounts.
  - Ensuring that service members practice good field hygiene.
  - Providing cool water; if desired, you can add flavoring after disinfection to enhance consumption. Personnel should use their canteen cup for consumption of flavored water. **DO NOT add flavoring to canteen water; use only plain water in canteen.**
  - Ensuring troops drink water before starting any hard work or mission (in the morning, with/after meals).
  - Ensuring buddy system is being used.
  - Frequently checking service members' canteens for water; not beverages.

- Making sure service members have adequate time to eat and drink as mission permits. Permit personnel to consume carbohydrate/electrolyte beverages (sports drinks) as supplemental nutrients under conditions of extreme calorie and water requirements; such as extremely vigorous activities.
- Reduce heat injuries by—
  - Enforcing work/rest cycles when the mission permits. Permitting personnel to work/rest in the shade, if possible.
  - Encouraging service members to eat all meals for needed salts.
  - Adjusting workload to size of individuals, when possible.
  - Be prepared for heat casualties and decreased performance when water and work/rest cycle recommendations cannot be met.

## **MODIFY WEAR OF THE UNIFORM**

Direct/authorize service members to—

- Keep skin covered while in sun.
- Keep uniform loose at neck, wrists, and lower legs (unblouse pants).

**NOTE**

If the medical threat from biting arthropods is high, keep sleeves rolled down and pants bloused in boots.

**IDENTIFY SPECIAL CONSIDERATIONS**

Identify and modify training/physical activity for service members with high-risk conditions of heat injuries, such as—

- Diseases/injuries, especially fevers, vomiting, diarrhea, heat rash, or sunburn.
- Use of alcohol within the last 24 hours.
- Overweight/unfit.
- Over 40 years old.
- Fatigue/lack of sleep.
- Taking medication (especially for high blood pressure, colds, or diarrhea).
- Previous heatstroke/severe heat exhaustion.
- Lack of recent experience in a hot environment.

## Section II. COLD INJURIES

### PLAN FOR THE COLD

- Use your FST to train individuals and their leaders in PMM against cold.
- Obtain weather forecast for time/area of training/mission.
- Ensure the following are available as the tactical situation permits:
  - Covered vehicles for troop transport, if tactical situation permits.
  - Cold weather clothing.
  - Laundry services.
  - Warming tents/areas.
  - Hot rations/hot beverages.
  - Drinking water.
- Inspect service members (before starting training/mission) to ensure—
  - Availability, proper fit, and wear of cold weather gear.

## **FM 21-10/MCRP 4-11.1D**

- Clean, dry, proper-fitting clothing.
- Each service member has several pairs of socks, depending on the nature and duration of the mission.
- Frequently rotate guards or other service members performing inactive duties.
- Ensure medical support is available for treatment should cold weather injuries occur.

## **DETERMINE AND USE WINDCHILL FACTOR**

- Obtain temperature and wind speed information as directed by your unit's SOP or contact the local supporting PVNTMED detachment or section.
- Calculate windchill from Table 3-2.

### **NOTE**

Cold injuries can and do occur in nonfreezing temperatures. Hypothermia can occur in mildly cool weather.

Table 3-2. Windchill Chart

ESTIMATED WIND SPEED (IN MPH)	ACTUAL TEMPERATURE READING (°F)												
	50	40	30	20	10	0	-10	-20	-30	-40	-50	-60	
	EQUIVALENT CHILL TEMPERATURE (°F)												
CALM	50	40	30	20	10	0	-10	-20	-30	-40	-50	-60	
5	48	37	27	16	6	-5	-15	-26	-36	-47	-57	-68	
10	40	28	16	4	-9	-24	-33	-46	-58	-70	-83	-95	
15	36	22	9	-5	-18	-32	-45	-58	-72	-85	-99	-112	
20	32	18	4	-10	-25	-39	-53	-67	-82	-96	-110	-121	
25	30	16	0	-15	-29	-44	-59	-74	-88	-104	-118	-133	
30	28	13	-2	-18	-33	-48	-63	-79	-94	-109	-125	-140	
35	27	11	-4	-20	-35	-51	-67	-82	-98	-113	-129	-145	
40	26	10	-6	-21	-37	-53	-69	-85	-100	-116	-132	-148	
(WIND SPEEDS GREATER THAN 40 MPH HAVE LITTLE ADDITIONAL EFFECT.)	LITTLE DANGER IN LESS THAN ONE HOUR WITH DRY SKIN. MAXIMUM DANGER OF FALSE SENSE OF SECURITY.			INCREASING DANGER DANGER FROM FREEZING OF EXPOSED FLESH WITHIN ONE MINUTE.					GREAT DANGER FLESH MAY FREEZE WITHIN 30 SECONDS.				
	NOTE: 1. TRENCH FOOT AND IMMERSION FOOT MAY OCCUR AT ANY POINT ON THIS CHART. 2. F = 9/5 C + 32.												

Table 3-3. Windchill Categories (See Windchill Table)

WORK INTENSITY	LITTLE DANGER	INCREASED DANGER	GREAT DANGER
<b>HIGH</b> DIGGING FOXHOLE, RUNNING, MARCHING WITH RUCKSACK, MAKING OR BREAKING BIVOAC	INDIVIDUALS OR SMALL UNIT LEADERS: BLACK GLOVES OPTIONAL; MANDATORY BELOW 0 DEGREES F; INCREASED HYDRATION.	INCREASED SURVEILLANCE BY EXTREME COLD WEATHER SYSTEM OR EQUIVALENT; MITTENS WITH LINERS; NO FACIAL CAMOUFLAGE; EXPOSED SKIN COVERED AND KEPT DRY; REST IN WARM, DRY, SHELTERED AREA; COLD WEATHER, VAPOR BARRIER BOOTS BELOW 0 DEGREES F.	POSTPONE NON- ESSENTIAL ACTIVITY; ESSENTIAL TASKS ONLY WITH LESS THAN 15 MINUTES EXPOSURE; COVER ALL SKIN.
<b>LOW</b> WALKING, MARCHING WITHOUT RUCKSACK, DRILL AND CEREMONY	INCREASED SURVEILLANCE; COVER EXPOSED FLESH WHEN POSSIBLE; MITTENS WITH LINERS AND NO FACIAL CAMOUFLAGE BELOW 10 DEGREES F; FULL HEAD COVER BELOW 0 DEGREES F; KEEP SKIN DRY, ESPECIALLY AROUND NOSE AND MOUTH.	RESTRICT NONESSENTIAL ACTIVITY; 30-40 MINUTE WORK CYCLES WITH FREQUENT SUPERVISORY SURVEILLANCE FOR ESSENTIAL TASKS (SEE ABOVE).	CANCEL OUTDOOR ACTIVITY, IF POSSIBLE.
<b>SEDENTARY</b> SENTRY DUTY, EATING, RESTING, SLEEPING, CLERICAL WORK	SEE ABOVE; FULL HEAD COVER AND NO FACIAL CAMOUFLAGE BELOW 10 DEGREES F; COLD WEATHER, VAPOR BARRIER BOOTS BELOW 0 DEGREES F; SHORTEN DUTY CYCLES; PROVIDE WARMING.	POSTPONE NONESSENTIAL ACTIVITY; 15-20 MINUTE WORK CYCLES FOR ESSENTIAL TASKS; WORK GROUPS OF NO LESS THAN 2 PERSONNEL; NO EXPOSED SKIN.	CANCEL OUTDOOR ACTIVITY, IF POSSIBLE.



These guidelines are generalized for worldwide use. Commanders of units with extensive extreme cold weather training and specialized equipment may opt to use less conservative guidelines.

- Then use Table 3-4 to apply PMM guidance:

*Table 3-4. Windchill Preventive Medicine Measures*

WINDCHILL	PREVENTIVE MEDICINE MEASURES
30° F AND BELOW	ALERT PERSONNEL TO THE POTENTIAL FOR COLD INJURIES.
25° F AND BELOW	LEADERS INSPECT PERSONNEL FOR WEAR OF COLD WEATHER CLOTHING. PROVIDE WARM-UP TENTS/AREAS/HOT BEVERAGES.
0° F AND BELOW	LEADERS INSPECT PERSONNEL FOR COLD INJURIES. INCREASE THE FREQUENCY OF GUARD ROTATIONS TO WARMING AREAS. DISCOURAGE SMOKING.
-10° F AND BELOW	INITIATE THE BUDDY SYSTEM—HAVE PERSONNEL CHECK EACH OTHER FOR COLD INJURIES.
-20° F AND BELOW	MODIFY OR CURTAIL ALL BUT MISSION-ESSENTIAL FIELD OPERATIONS.

## **FM 21-10/MCRP 4-11.1D**

- The windchill index gives the equivalent temperature of the cooling power of wind on exposed flesh.
  - Any movement of air has the same effect as wind (running, riding in open vehicles, or helicopter downwash).
  - Any dry clothing (mittens, scarves, masks) or material which reduces wind exposure will help protect the covered skin.
- Trench foot injuries can occur at any point on the windchill chart and—
  - Are much more likely to occur than frostbite at “LITTLE DANGER” windchill temperatures, especially on extended exercises/missions and/or in wet environments.
  - Can lead to permanent disability, just like frostbite.

## **IDENTIFY SPECIAL CONSIDERATIONS**

- Conditions that place service members at high risk of cold injuries include—
  - Previous trench foot or frostbite.

- Fatigue.
  - Use of alcohol.
  - Significant injuries.
  - Poor nutrition.
  - Use of medications that cause drowsiness.
  - Little previous experience in cold weather.
  - Immobilized or subject to greatly reduced activity.
  - Service members wearing wet clothing.
  - Sleep deprivation.
- Identify the special hazards of carbon monoxide poisoning and fire that may affect your cold weather operations.

### **ENFORCE INDIVIDUAL PREVENTIVE MEDICINE MEASURES**

- Ensure service members wear clean and dry uniforms in loose layers.

## FM 21-10/MCRP 4-11.1D

- Ensure service members remove outer layer(s) before starting hard work or when in heated areas (before sweating).
- Have service members inspect their socks and feet at least daily when operating in cold and/or wet environments.
- Ensure service members to—
  - Wash their feet daily.
  - Wear clean and dry socks.
  - Use warming areas when available.
  - Eat all meals to ensure sufficient calories are consumed to maintain body heat.
  - Drink plenty of water and/or nonalcoholic fluids. In cold weather, fluid intake is often neglected, leading to dehydration.
  - Exercise their big muscles or at least their toes, feet, fingers, and hands to keep warm.
- Institute the buddy system in cold weather operations. Service members taking care of each other decrease cold injuries.

## **Section III. ARTHROPODS AND OTHER ANIMALS OF MEDICAL IMPORTANCE**

### **PLAN FOR THE ARTHROPOD, RODENT, AND OTHER ANIMAL THREAT**

- Obtain information on biting and stinging arthropods and other animals (such as snakes, domestic and wild animals, or birds) which could be a threat—
  - Through unit medical channels from the command PVNTMED representative.
  - From the health service support (HSS) annex to operation plan/order.
- Use your FST—
  - Train your service members in PMM.
  - Control insects and other medically important arthropods in your AO.
  - Control rodents and other medically important animals in your AO.
  - Remind service members to avoid handling insects, arthropods, snakes, and other animals to prevent bites or injury. Animals that appear to be healthy may transmit rabies and other zoonotic diseases.

## **FM 21-10/MCRP 4-11.1D**

- Keep personnel from eating in sleeping/work areas; prevent attracting insects, rodents, and other animals.
- Animal mascots should not be kept or maintained unless cleared by veterinary personnel.
- Ensure that—
  - Each service member has a bed net in good repair and treated with permethrin repellent.
  - Immunizations are current. Prophylaxis (for example, anti-malaria tablets) is available for issue as required.
  - Laundry and bathing facilities are available.
  - Field sanitation team supplies and equipment are available and can be replenished.
- Request assistance from a PVNTMED unit (through medical or command channels) when control of biting arthropods, rodents, or other animals is beyond the capabilities of your unit.

## **ENFORCE INDIVIDUAL PREVENTIVE MEDICINE MEASURES**

- Ensure all uniforms are impregnated with permethrin before field training or deployment.

- Ensure each service member has DOD skin (DEET) and clothing (permethrin) insect repellent and uses them. However, cooks, other food handlers, and kitchen police personnel must not use repellent on their hands when preparing and serving food, or when cleaning food service utensils, dishes, and food serving areas.
- Direct service members to keep—
  - Shirts buttoned.
  - Sleeves rolled down.
  - Pants bloused inside boots.
- Ensure service members—
  - Bathe/shower regularly (field expedients will do); a field shower or bath with a clean change of uniform should be accomplished once each week to control body lice.
  - Discontinue the use of aftershave lotions, colognes, perfumes, and scented soaps; they attract insects.
  - Use permethrin treated bed nets and the DOD-approved aerosol insect (Insecticide, d-Phenothrin, 2%, Aerosol, NSN 6840-01-412-4634); spray inside the net if necessary.

## **FM 21-10/MCRP 4-11.1D**

- Observe service members taking anti-malaria pills or other prophylaxis (when prescribed by the medics).
- Use your FST to identify suspected lice infestations and refer for medical treatment.

### **MINIMIZE EXPOSURE TO ARTHROPOD, RODENT, AND ANIMAL THREAT**

- If the mission permits—
  - Use your FST to assist you in selecting bivouac sites.
  - Occupy areas distant from insect/arthropod breeding areas such as natural bodies of water.
  - Avoid areas with high grass or dense vegetation.
  - Use FST recommendations and assistance in applying pesticides for area control around living areas and in natural bodies of water.
  - Drain or fill in temporary standing water sites in occupied area (empty cans, used tires, or wheel ruts after rains).
  - Clear vegetation in and around occupied area.



- Maintain area sanitation by enforcing good sanitation practices.
  - Properly dispose of all waste.
  - Protect all food supplies.
  - Police area regularly.
  - Exclude pests (rats, mice, lice, and flies).

#### **NOTE**

See Appendix A for performance of tasks relating to PMM against arthropods and rodents.

### **Section IV. POISONOUS PLANTS AND TOXIC FRUITS**

- Obtain information on poisonous plants and toxic fruits that could be a threat—
  - Through unit medical channels from the command PVNTMED representative.
  - From the HSS annex to operation plan/order.

## **FM 21-10/MCRP 4-11.1D**

- Use your FST to—
  - Train your service members in PMM.
  - Display and provide information on the kinds of dangerous plants and fruits in the unit area.
- Enforce individual PMM by—
  - Proper wearing of the uniform.
  - Avoidance of poisonous plants where possible.
  - Avoidance of consuming potentially dangerous vegetation and fruits.
  - Avoidance of putting grasses and twigs in the mouth.

## **Section V. FOOD-/WATER-/WASTEBORNE DISEASE/ILLNESS**

### **PLAN FOR SAFE WATER**

- Know the location of approved water distribution points.

- Make sure your unit has an adequate supply of—
  - Iodine water purification tablets (1 bottle for each individual).
  - Field chlorination kits.
  - Bulk chlorine.
  - Chlor-Floc® kits.
- Ensure water trailers and tankers (400 gallon and above) are inspected by PVNTMED personnel semiannually.
- Inspect water containers before use.
- Check the residual chlorine of bulk water supplies (5-gallon cans, water pillows, water trailer) before drinking and at least daily thereafter. (See Tasks 7 and 8, Appendix A.)

## **PLAN FOR SAFE FOOD**

- Ensure food service personnel maintain foods at safe temperatures.
- Inspect food service personnel daily and refer for medical evaluation those with illness and/or skin infections.

## **FM 21-10/MCRP 4-11.1D**

- Make sure foods, drinks, and ice purchased from civilian vendors are approved by the command medical authority.
- Supervise the use of the mess kit laundry/sanitation center.
- Ensure food service personnel and service members use handwashing devices.
- Ensure all food waste is transported to an approved disposal site, buried, or burned daily (at least 30 meters from food preparation area and water source).

### **PLAN FOR THE CONSTRUCTION AND MAINTENANCE OF FIELD SANITATION DEVICES**

- Determine type of field waste disposal devices required.
  - The primary type of human waste disposal devices in bivouac areas are the chemical toilets. Individual waste collection bags are the primary type used when on the march.
  - The type of improvised waste disposal used will depend on the mission, length of stay in the area, terrain, and weather conditions. When chemical toilets are not available, the burn-out latrine is the preferred improvised waste disposal device.

**NOTE**

Always check local, state, federal, or host-nation regulations for restrictions or prohibitions on using standard or improvised field devices and waste disposal in the field.

- Select locations for field latrines.
  - As far from food operations as possible (100 meters or more). Downwind and down slope, if possible.
  - Down slope from wells, springs, streams, and other water sources (30 meters or more).
- Set up, construct, and maintain latrines (see Task 9, Appendix A, for requirements).
  - As soon as the unit moves into a new area, detail service members to set up chemical toilets or dig latrines. (See previous **NOTE**.)
  - Detail service members to clean latrines daily.
  - Instruct the FST to spray the latrines with insecticide as necessary (not the pit contents).
  - Always provide handwashing facilities at the food service facilities and the latrines. Make use of handwashing devices at latrines mandatory.

- Cover, transport, burn, or bury waste daily.
- Use the FST to train service members and unit leaders in PMM against food-/water-/wasteborne diseases.

**NOTE**

See Appendix A for performance of tasks relating to PMM against food-/water-/wasteborne diseases.

**Section VI. PERSONAL HYGIENE AND PHYSICAL AND MENTAL FITNESS**

**KEEP YOUR UNIT PHYSICALLY FIT**

- Ensure that leaders at all levels recognize the benefits of physical fitness. Leaders must be role models, leading by example.
- Take a positive approach to physical fitness with service members. A physically fit service member is less likely to be a combat loss from disease or injury.

**NOTE**

See FM 21-20 for more information.

**PLAN FOR PERSONAL HYGIENE**

- Provide shower/bathing facilities in the field. All personnel must bathe at least once a week and have a clean change of clothing to reduce the health hazard associated with body lice.
- Inspect service members' personal equipment to ensure they have sufficient personal hygiene supplies—soap, washcloths, towels, a toothbrush, dental floss, fluoride toothpaste, and razor and razor blades (females should have sanitary napkins or tampons).
  - Ensure undergarments are cotton (not silk, nylon, or polyester).
  - Ensure uniforms fit properly (not tight).
  - Ensure service members have several pairs of issue boot socks; the number will depend on the type and length of the mission.
- Use your FST to train your service members in personal hygiene.

## FM 21-10/MCRP 4-11.1D

- Ensure service members receive annual dental examinations and needed oral health care. Make sure all oral health appointments are kept. Use low operational requirement periods to ensure all personnel maintain a good oral health status.

## ENFORCE SLEEP DISCIPLINE

- The mission, unit readiness, and individual security must come first, but never miss a chance to give everyone in the unit time to sleep.
- When feasible, set work/rest shifts.
- Do not allow service members to sleep in areas where they may be run over by vehicles, or in other unsafe areas.
- During *continuous operations*, set shifts and rotate jobs to allow everyone at least 3 to 4 hours uninterrupted sleep per 24-hour period.
- During brief (up to 48 hours) sustained operations when shifts are impossible, rotate jobs so all individuals catnap as safely and comfortably as possible. The loss of sleep will reduce the service member's ability to perform his duties and the leader's ability to make decisions.



**NOTE**

Ensure that sleeping individuals observe safety precautions. Use ground guides for vehicles in bivouac areas.

**ENFORCE PREVENTIVE MEDICINE MEASURES FOR THE EFFECTS OF SLEEP LOSS**

- Those individuals with the most complex mental or decision-making jobs need the most sleep. This means you and your most critical leaders and operators!
- Cross train individuals to perform the critical tasks and delegate limited authority among leaders, thus enabling all to get necessary rest.

**ENSURE WELFARE, SAFETY, AND HEALTH OF UNIT**

- Ensure the best and safest water, food, equipment, shelter, sanitation, and sleep possible are provided.
- Educate service members to maintain professional pride and personal caring for themselves, each other, and their equipment.

## **FM 21-10/MCRP 4-11.1D**

- Know the personal backgrounds and the military skills of your service members. Chat with them informally about themselves. Be attentive and understanding while listening to service members.
- Utilize group support and counsel for service members with *home front* problems.
- Assign jobs to maintain a balance between having qualified people in key positions while sharing the load, hardship, and risks fairly.
- Use challenging and difficult environments during training to increase your own and the unit's coping skills and confidence.

## **REDUCE UNCERTAINTY BY KEEPING EVERYONE INFORMED**

- Brief unit personnel on the situation, objectives, and conditions that the mission or environment may involve.
- Explain reasons for hardships, delays, and changes.
- Do not give false reassurances. Prepare your service members for the worst and put any unexpected challenges or reversals in a positive perspective.
- Deal with rumors firmly and honestly. Prevent the spread of rumors.
- Make contingency plans and follow SOP to reduce the effects of surprise.

## **PROMOTE COHESION WITHIN THE UNIT**

- Use equipment drills, physical fitness training, team sports, and field *stress training* to stimulate mutual reliance and closeness.
- Bring unit members together for meals, award ceremonies, and other special occasions.
- Integrate new members by assigning sponsors and ensuring rapid familiarization.

## **IMPART UNIT PRIDE**

- Educate service members in the history and tradition of the small unit, its parent units, and the branch of Service.
- Honor the historical examples of initiative, endurance, and resilience, of overcoming heavy odds, and of self-sacrifice.

# **Section VII. NOISE**

## **PLAN FOR NOISE**

- Identify existing noise in your unit. If necessary, request PVNTMED assistance in identifying sources.

## FM 21-10/MCRP 4-11.1D

- Ensure that hearing conservation is part of the unit SOP.
- Ensure all service members are medically fitted for hearing protectors and are issued multiple sets.
- Ensure all service members have annual hearing test/screening.
- Control noise sources.
  - Isolate by distance; that is, keep troops away from noise, if possible.
  - Isolate by barrier; for example, use sandbags.
  - Use organic equipment controls; for example, keep mufflers and engine covers in good repair.
- Train unit to do mission while wearing hearing protectors.
- Post **Noise Hazard** signs in noise hazardous areas and on noise hazardous equipment.

## ENFORCE INDIVIDUAL PROTECTIVE MEASURES

Ensure that service members—

- Wear earplugs or other hearing protective devices.

- Do not remove inserts from aircraft or tracked vehicle helmets.
- Avoid unnecessary exposure.
- Limit necessary exposure to short, infrequent, mission-essential times.
- Clean their hearing protectors.

## **PROTECT MISSION**

- Be aware of short-term noise effects on the service member's ability to hear combat significant noise.
- Assign listening post (LP)/observation post (OP) to troops least affected by noise, augment LP/OP with night vision devices and/or increase the number of audible alarms around your position.

## **Section VIII. TOXIC INDUSTRIAL CHEMICALS/MATERIALS**

### **PLAN FOR CHEMICALS**

- Identify sources of toxic industrial chemicals/materials in your unit. If necessary, request PVNTMED assistance in identifying sources.

## **FM 21-10/MCRP 4-11.1D**

- Obtain safer chemicals for unit operations, if available.
- Observe cautions/warnings posted in technical manuals dealing with solvents corrosives, and other hazardous materials. (Refer to MSDS that accompany stores of toxic chemicals/materials.)

## **ENFORCE INDIVIDUAL PREVENTIVE MEDICINE MEASURES**

Ensure that service members—

- Repair engines outside or vent engine exhaust to outside.
- Keep their sleeping quarters ventilated.
- Do not use vehicle engines as heaters.
- Use/maintain onboard ventilation systems.
- Are trained and drilled to self-protect themselves around hydrogen chloride and M8 smoke.
- Maintain bore/gun gas evacuation systems.
- Use “safety” Stoddard solvent.

- Have adequate clean gloves, coveralls, and other protective gear.
- Follow label instructions on chemical containers.

## CHAPTER 4

**UNIT FIELD SANITATION TEAM****FIELD SANITATION TEAM CONCEPT**

- During World War II, it became apparent that more action was needed at the unit level to counter the medical threat. (Remember Togatabu Island and the jungles of Burma? [pages 1-2 and 1-3]) To answer this need, the FST concept was developed.
- Selected members from each company-sized unit were designated to receive special training in DNBI prevention so they could advise the commander in PMM for DNBI. This training enabled the unit commander to provide arthropod control, individual and unit disinfection of water, and safe food supplies. This resulted in commanders being able to reduce DNBI losses.

**SCOPE OF FIELD SANITATION TEAM OPERATIONS**

The FST—

- Conducts arthropod and rodent control operations in the field as directed by the commander. In garrison, the FST is in a training status. During mobilization, the FST performs its field sanitation duties.



## **FM 21-10/MCRP 4-11.1D**

- Ensures that unit leaders are supervising the disinfection of unit water supplies. Instructs the troops in methods of individual water purification.
- Assists the commander by inspecting food service operations.
- Monitors the waste disposal procedures and the construction of garbage and soakage pits; and then inspects these devices for proper waste disposal procedures use.
- Ensures personnel have individual waste collection bags and the unit's chemical toilets are set up and operated correctly. Monitors disposal methods of individual bags and chemical toilet contents. Monitors the construction of field latrines and urinals when chemical toilets are not available. Inspects these devices for proper sanitation.
- Provides unit training in the use of individual PMM.
- Applies pesticides as required/necessary for the control of arthropods.

## **FIELD SANITATION TEAM TASKS**

Unit FSTs serve as advisors to the commander on individual and unit PMM that prevent DNBI. To assess the medical threat (disease/illness risk), the team members must be able to perform the following tasks:

- Inspect water containers and trailers.

- Disinfect unit water supplies.
- Check unit water supply for chlorine.
- Inspect unit field food service operations.
- Inspect unit waste disposal operations.
- Control arthropods, rodents, and other animals in unit area.
- Train unit personnel in use of individual PMM.
- Monitor status of PMM in unit.
- Assist in selection of a unit bivouac site.
- Supervise the construction of field sanitation devices.
- Monitor unit personnel in the application of individual PPM.

**NOTE**

All unit leaders should be able to perform these tasks.

## **SELECTION OF PERSONNEL**

Selection of personnel for the unit FST should be based on the following:

- Units having organic medical personnel (combat medics) **WILL** use them as the FST.
- When organic medical personnel are not available, selected team members should be personnel whose normal field duties allow them to devote time to field sanitation activities.
- At least one member must be a noncommissioned officer when organic medical personnel are not available.

## **TRAINING**

Members of the FST are required to receive training in basic sanitation techniques, disease control, and individual PMM. Training includes—

- Use of insect repellents, uniform impregnants, and protective clothing.
- Use and repair of screening and bed nets.
- Use of residual and space insecticide sprays.
- Rodent control measures.

- Food service sanitation.
- Unit waste disposal procedures.
- Water purification procedures, to include determination of chlorine residual.
- Personal hygiene.
- Heat/cold injury prevention, to include WBGT determination and use of the windchill chart.
- Other subjects as they relate to the medical threat in the unit's AO, to include noise hazards and hearing protection.

### **HOW TO MAKE YOUR FIELD SANITATION TEAM THE BEST IN THE COMMAND**

- Select soldiers you can rely on.
- After they are trained, use them during—
  - Service training and evaluation programs.
  - Field training exercises.

## FM 21-10/MCRP 4-11.1D

- Unit training on PMM.
- Predeployment training on the medical threat in the deployment AO.
- Ensure your unit has a functional FST SOP.

### NOTE

Do not let your FST just be an Inspector General requirement. Make it an asset you can use. Your FST has a critical role and can assist you in protecting the health of unit personnel.

## APPENDIX A

**UNIT-LEVEL PREVENTIVE MEDICINE  
MEASURES TASKS**

**TASK 1:** Control biting insects.

**EQUIPMENT NEEDED:** 1-gallon or 2-gallon sprayer, ready-to-use insecticide, and individual repellents (DEET and permethrin).

**STEPS OF PERFORMANCE:**

**MOSQUITOES:**

**STEP 1:** Identify common mosquito-breeding areas:

- Mosquito landing counts and trapping.
- Standing water.
- Artificial water containers.

**STEP 2:** Control:

- If possible, drain standing water.



## FM 21-10/MCRP 4-11.1D

- Empty artificial water containers.
- Avoid setting up bivouac sites near mosquito-breeding areas.
- Enforce individual use of DOD insect repellent systems (DEET on skin and permethrin on uniforms and bed nets).
- Have FST spray pesticide on adult mosquito-resting areas using 1-gallon or 2-gallon sprayer (see Task 2), if necessary.

### FLEAS:

**STEP 1:** Identify rodent infestations or the presence of wild or domestic cats and dogs in the unit area (rodents, cats, and dogs carry fleas).



**STEP 2:** Control:

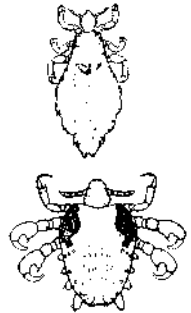
- Have service members in unit use individual DOD insect repellents.
- Exclude rodents and other wild animals from camps and buildings.
- Have FST spray pesticide, using 1-gallon or 2-gallon sprayer (see Task 2) around rodent burrows and harborage.

- **DO NOT** allow service members to keep “pet” animals.

## LICE:

### STEP 1: Identify lice infestation:

- Head lice—look for lice and eggs attached to the hair, close to the scalp. Eggs are attached directly to the hairs.
- Crab lice—usually associated with the pubic area (groin), but can be found attached to other body hairs. The eggs are attached directly to the hair.
- Body lice—generally found in the seams of infested persons’ clothing. The eggs are attached to the fibers of the garments. Body lice tend to move to the body of the host only during the actual feeding process.



### STEP 2: Control:

- Refer individuals with lice infestation for medical treatment.
- Enforce high standards of personal hygiene. Require frequent showering and laundering of bedding and clothing (once a week at a minimum).



## FM 21-10/MCRP 4-11.1D

- To prevent body lice, enforce individual use of permethrin-treated battle dress uniform/cammies.
- Avoid sexual contact (for crab lice).

### TICKS AND MITES:

**STEP 1:** Identify tick- or mite-infested areas—

- Grassy areas.
- Animal trails or resting areas.
- Rodent burrows.



**STEP 2:** Control:

- Avoid walking through tick-infested areas.
- Cut down vegetation in and around camps.
- Enforce individual use of DOD insect repellent.

- If necessary, have FST spray area with pesticide, using 1-gallon or 2-gallon sprayer to apply pesticide (see Task 2).
- Enforce a buddy system where troops perform checks not only on themselves but on their buddy as well. If ticks are found—
  - Remove any attached ticks promptly and carefully without crushing, using gentle steady traction with forceps (tweezers) close to the skin to avoid leaving mouthparts in the skin;
  - Protect hands with gloves, cloth or tissue when removing ticks from humans or animals;
  - Ensure that the body of the tick is not separated from its head.

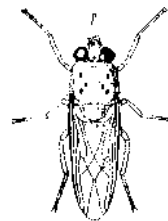
### **NOTE**

Lyme disease, Rocky Mountain spotted fever, ehrlichiosis, and encephalitis can be contracted through tick bites. Beware of ticks when passing through the thick vegetation they may cling to. When cleaning host animals for food, or when gathering natural materials to construct a shelter, you must be on the lookout for them. Buddy checks are important. If diagnosed early, the diseases mentioned above can be cured. If not, they can lead to death.

### BITING FLIES:

**STEP 1:** Identify problems with biting flies and their breeding sites.

- Moist soil near ponds and stream banks.
- Decaying vegetation and animal manure.
- Rodent burrows, rock walls, and cracks in walls of buildings.



**STEP 2:** Control:

- Enforce use of DOD insect/arthropod repellents (DEET on the skin and permethrin on uniforms).
- Avoid areas with biting fly problems or breeding sites.

### FILTH FLIES:

**STEP 1:** Identify infestations and breeding areas, such as—

- Open latrines.
- Uncovered food and waste.
- Ground soaked with liquid kitchen waste or food scraps on wet soil.



- Animal barnyards near AO.

**STEP 2:** Control:

- Remove, cover, or burn latrine waste.
- Keep food and waste covered.
- Use fly swatters for small to moderate numbers of filth flies. Only use the DOD-approved aerosol (Insecticide, d-Phenothrin, 2%, 12 ounce Aerosol, NSN 6840-01-412-4634) pesticide if large numbers of flies are in an enclosed area (do not use in food service operations).
- Ensure proper disposal of waste collection bags.
- Have FST use a 1-gallon or 2-gallon sprayer to spray pesticide on ground that is wet with kitchen waste, in field latrines, and on fly-resting sites (see Task 2).
- Use toxic fly baits.

**COCKROACHES:**

**STEP 1:** Identify cockroach infestations and breeding areas, such as—

- Food service areas.

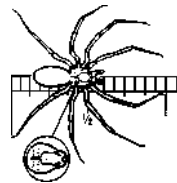
- Latrines/shower facilities.
- Trash collection points.

**STEP 2: Control:**

- Enforce good sanitation practices.
- Ensure proper collection and removal of food waste.
- Have FST use a 1-gallon or 2-gallon sprayer to spray pesticide as spot treatment in food service areas and as a residual spray to outside surfaces of buildings and trash collection points.

**SPIDERS:**

**STEP 1:** Identify infestations of medically important spiders (black widow, tarantula, and brown recluse spider).



**NOTE**

Use caution when entering into and clearing out of old, infrequently used buildings.

**STEP 2: Control:**

- Eliminate unnecessary rubbish and other debris in the bivouac area.
- Have FST use a 1-gallon or 2-gallon sprayer (see Task 2) to spray around tents, field latrines, or other spider habitats.

**SCORPIONS and CENTIPEDES:**

**STEP 1:** Identify places where scorpions and centipedes are a problem.

- Rocky areas.
- Inside of building.
- Tents.

**STEP 2: Control:**

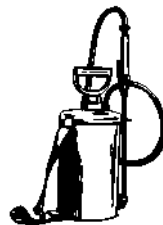
- Have FST use a 1-gallon or 2-gallon sprayer (see Task 2) on nesting sites around the entire tent or other structure, forming a band 2-feet high from the ground level.
- Saturate all cracks and crevices with insecticide.

**BEEES, WASPSS, AND ANTTSS:**

**STEEP 1:** Identify places where these insects are a problem. Locate the nests.

**STEEP 2:** Control:

- Educate troops to avoid nests.
- Have FST use a 1-gallon or 2-gallon sprayer (see Task 2) on the nesting sites. Use caution to avoid stings from disturbed insects. If the task is too great or too dangerous, contact PVNTMED personnel for assistance.



**TASK 2:** Use the 1-gallon or 2-gallon compressed air sprayer.

**EQUIPMENT NEEDED:** 1-gallon or 2-gallon sprayer and authorized insecticide, respirator, gloves, nonvented goggles, and other personal protective equipment, as appropriate.

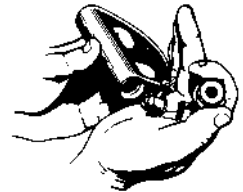
**NOTE**

Only personnel certified as DOD Pesticide Applicator may apply pesticides. Uncertified persons may apply pesticides if they are properly trained by and under the direct supervision of a certified pesticide applicator.

**STEPS OF PERFORMANCE:**

**STEP 1:** Determine the job to be done (pest, area to be treated, and pesticide type).

**STEP 2:** Assemble the compressed air sprayer. Select the correct nozzle and attach to the end of the wand, fill the tank half full of clean water, and pressurize the tank to ensure that the tank and nozzle are operational. Pressurize to approximately 40 to 60 pounds per square inch (psi) of pressure. If the sprayer does not have a gauge, approximately 30 to 35 pump strokes will usually be sufficient. Squeeze the handle on the wand to check nozzle performance. If the sprayer is operational, release pressure from tank. If the sprayer leaks, replace the gaskets or tighten the connections on the hose, wand, and nozzle.



**STEP 3:** Read the insecticide label.

- Always read the label before doing anything.
- Always follow all instructions on the label. **The label is the law.**



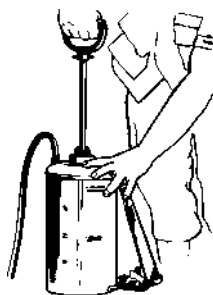
### CAUTION

Wear chemical resistant gloves during mixing and spraying. Gloves, Chemical and Oil Protective, NSN 8415-01-012-9294 (size 9) or NSN 8415-01-013-7832 (size 10) are recommended. Wear an approved pesticide respirator, if required by the label. **DO NOT** use the NBC protective mask when applying pesticides. Avoid skin contact with insecticide.

**STEP 4:** Add pesticide to the clean water in the sprayer tank. Finish filling the sprayer with clean water to the appropriate level. **DO NOT fill the sprayer to the top.** Leave space for pumping air pressure into the tank. Put the pump assembly into the sprayer and tighten.

**STEP 5:** Pump the sprayer.

- Pump the sprayer 30 to 35 times to achieve 40 to 60 psi pressure.
- There should be a slight resistance to pumping when this pressure is achieved. **DO NOT** over pump.

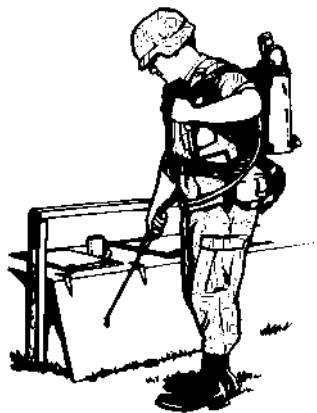


**STEP 6:** Spray insecticide.

- Point nozzle at area to be sprayed and squeeze the handle on the wand.
- Continue spraying until area is covered.

**NOTE**

Record all pesticide applications. The record should include location of application, name of pesticide used, and amount of pesticide used. Pesticide applications must be reported to higher echelon command, using **Department of Defense Form 1532-1** as required by **DOD Instruction 4150.7**.

**STEP 7:** Clean the sprayer.

- Clean the sprayer with soap and water, then flush the tank at least 3 times with clear water.
- Rinse all parts in clear water.

## FM 21-10/MCRP 4-11.1D

- Reassemble and spray clear water through nozzle. If the sprayer is not cleaned after use, vital parts will corrode.

### **STEP 8:** Store cleaned sprayer.

- Turn the sprayer tank upside down with pump assembly separated to keep tank dry.

### **CAUTION**

Always wash your hands and chemical resistant gloves, respirator, goggles, and other personal protective equipment with soap and water after spraying. Store personal protective equipment away from pesticides and applicator.

### **TASK 3:** Control domestic rodents.

**EQUIPMENT NEEDED:** Tamper-proof rodent bait stations, rat snap trap (mechanical spring), mouse snap trap (mechanical spring), and rodenticides.

**STEPS OF PERFORMANCE:**

**STEP 1:** Identify rodent infestations and breeding and harborage areas, such as—

- Underground burrows.
- Around building foundations.
- Under rubbish piles.
- Near food sources.

**STEP 2:** Control:

- Enforce food sanitation practices, such as eliminating garbage and food waste in the bivouac area and keeping all food and waste covered.
- Locate trash dumps away from sleeping/berthing and food service areas.
- Clear all possible nesting areas by removing unnecessary rubbish and other debris.
- Modify buildings and structures to prevent rodents from having easy access.

- Use rodent snap traps and poison baits simultaneously for effective control. Poison baits must be placed in tamper/spill-proof containers with bilingual labels (English and local). Read the label and wear chemical resistant gloves when handling poison baits.

**CAUTION**

Wear chemical resistant gloves while handling rodenticides. Avoid skin contact with rodenticides. Wear plastic gloves when handling dead rodents. Place dead rodents in plastic bags; seal and dispose of the bags in landfills, or incinerate.

**TASK 4:** Prevent injuries due to venomous snakebite.

**STEPS OF PERFORMANCE:**

**STEP 1:** Be familiar with venomous snakes in the AO and with areas where snakes may be a problem.

- Rocky areas.
- Areas with rodent infestations.
- Heavy vegetation.

**STEP 2: Control:**

- Be familiar with field treatment of snakebites.
- Educate personnel on avoiding snakes and preventing snakebites.
- Prevent and control rodents (food sources for snakes) around camps and bivouac sites.
- Exclude snakes from buildings.

**TASK 5:** Inspect unit food service operations.

**EQUIPMENT NEEDED:** Thermometer, Self-Indicating Bimetallic, 0° F to 220° F, NSN 6685-00-444-6500. Clipboard with writing material.

**BACKGROUND INFORMATION:**

Some foods support the rapid growth of disease organisms that cause diarrhea; these foods are called:

**POTENTIALLY HAZARDOUS FOODS**

Examples of potentially hazardous foods include but are not limited to meats, fish, milk, creamed beef, gravies, soups, and chicken. Extra care and precautions must be taken with

## **FM 21-10/MCRP 4-11.1D**

these potentially hazardous foods. Five factors most often involved in outbreaks of diarrhea caused by contaminated foods are—

- Failing to keep potentially hazardous foods cold (below 40° F) or hot (above 140° F).
- Allowing potentially hazardous foods to remain at warm temperatures (41° F to 139° F).
- Preparing foods 3 hours or more before being served.
- Allowing sick employees to work.
- Permitting poor personal hygiene or sanitation practices by food handlers. Example: Not washing hands after using the latrine; improperly washing and sanitizing all cooking utensils.

### **STEPS OF PERFORMANCE:**

#### **IN GARRISON OR WHEN FOOD IS PREPARED IN A FIELD FOOD SERVICE FACILITY:**

**STEP 1:** Have the supervisor check the temperature of potentially hazardous foods.

- If hot—food should be 140° F or above.
- If cold—food should be 40° F or below.

**STEP 2:** Check personnel for illness and skin infection.

**STEP 3:** Check food handling techniques and personal hygiene.

**STEP 4:** Have the supervisor check the food temperature in cold storage units.

**STEP 5:** Check handwashing facilities. Are they being used by food handlers?

**STEP 6:** Check doors and windows. Are they closed or screened to prevent flies from entering?

### **NOTE**

See FM 10-23 for the correct operating procedures for a field kitchen facility (mobile field kitchen [MKT-75] or kitchen tent [M-1948]).

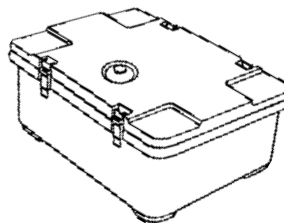
### **WHEN FOOD IS BROUGHT TO YOUR UNIT IN THE FIELD:**

**STEP 1:** Check the preparation of insulated containers.



## FM 21-10/MCRP 4-11.1D

- For hot foods, the container should be preheated by the use of boiling water. Foods should be placed in the container while they are hot (above 140° F).
- For cold foods, the container should be prechilled by the use of ice. Foods placed in the container should be cooler than 40° F. Always check the container and the insert seals to ensure that they are intact and in good condition to aid in keeping food at its required temperature.



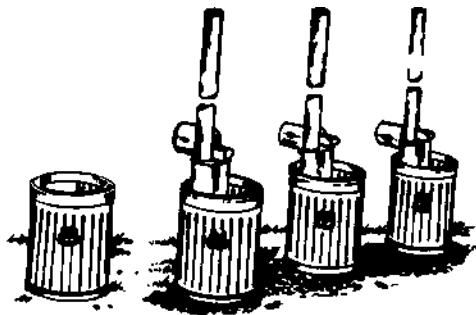
### NOTE

See FM 8-34 and FM 10-23 for the correct procedures for preparing the insulated containers.

**STEP 2:** When the insulated container arrives, the supervisor must check the food temperature before serving. Make sure it is 140° F or above for hot foods and 40° F or below for cold foods. If the temperature is in the danger zone, contact the medical authority for instructions.

**STEP 3:** Check for handwashing devices for use by service members.

**STEP 4:** Check the mess kit laundry, if used. Make sure service members are using the mess kit laundry correctly. The food waste is placed in a scrap can. Wash the kit in warm, soapy water (120° F to 140° F) using a long-handled brush to scrub. Rinse the mess kit in clear, boiling water. Disinfect the mess kit by immersing it in clear, boiling water for 10 seconds. Each mess kit laundry setup of four cans will support 80 personnel. Air-dry mess kits.

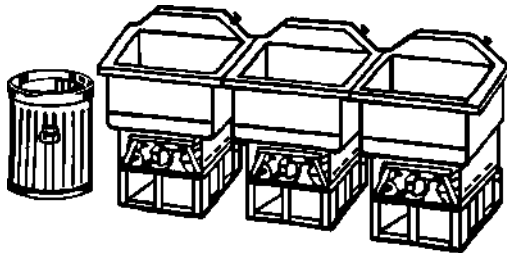


#### NOTE

If a sanitation center or immersion heaters are not available, food service disinfectant may be used. Make sure the label directions are being followed. Each setup of four cans will support 100 personnel. The setup consists of one can for food scraps, one can with soapy water, a clear rinse can, and a final rinse can with food service disinfectant.

**STEP 5:** Check the sanitation center, if used. The sanitation center is a set of one garbage can and three sinks with the M2 field range burners, or the

modern burner unit, and thermometers. The first sink has warm, soapy water. The second sink has clear, 170° F water. The third sink has clear, 180° F water. If thermometers are not available, the third sink must have boiling water. Food is scraped into the garbage can.



Scrub mess kit in the warm, soapy water by using a long-handled brush. Rinse the mess kit in the second sink of clear, 170° F water. Disinfect the mess kit by immersing it in the third sink of 180° F water for 10 seconds. Air-dry mess kits.

**TASK 6:** Inspect water containers.

**EQUIPMENT NEEDED:** None.

**WHEN TO INSPECT WATER CONTAINERS:**

- Quarterly in garrison when not being used.
- Prior to deployment.

- Before filling at water distribution points.
- Upon completion of use to ensure that all water has been drained from the container before storage.

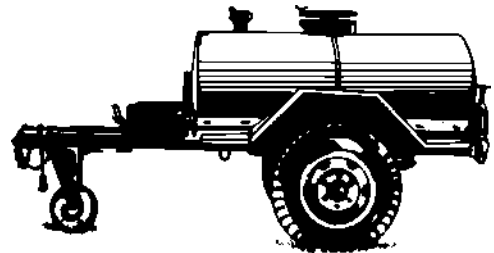
### STEPS OF PERFORMANCE:

#### UNIT WATER TRAILER:

- Upon completion of use:

**STEP 1:** Drain plug and spigots: Make sure that the drain plug has been removed and that all spigots have been opened to drain all water

from the tank. Foul odors, bacteria growth, and rust will accumulate during storage if the water is not completely drained.



**STEP 2:** Manhole cover: Place a thin piece of wood under the manhole cover to provide ventilation. With the manhole cover and spigots open, air circulation will be allowed, thus drying the inside of the water trailer.

### NOTE

See the technical manual on your water trailer for additional guidance.

- Quarterly:

**STEP 1:** Manhole cover: Ensure the sealing gasket is in place, free of excessive cracks and dry rot. Cover should provide an effective seal.



**STEP 2:** Drain plug: Ensure it is operable; it should be removable without excessive effort.

**STEP 3:** Interior: Check surface for excessive cracks; check for signs of being used for storage of products other than water such as oil products, gasoline, or diesel fuel. Rust stains and other discoloration caused by common natural chemicals in water (iron or manganese) pose no health problem.

**STEP 4:** Spigots: Make sure spigots are clean and operable. Covers over spigots should open and close with ease. Spigot handles should operate freely.

#### NOTE

Questions concerning excessive interior cracks or chipping and use after storage of products other than water should be directed to PVNTMED personnel. Refer to the technical manual on your water trailer for maintenance instructions.

- Before filling at water distribution points:

**STEP 1:** Check interior for gross contamination.

**STEP 2:** Check hose used to fill trailer. Water point fill hose should not come in contact with the ground. If the hose is lying on the ground, wash the end before use.

**STEP 3:** After filling, check manhole cover and drain plug to ensure that they are secure.

**CAUTION**

Personnel detailed to fill water trailers must be directed to fill the trailers only at approved water points.

**COLLAPSIBLE FABRIC DRUMS/PILLOWS/ONION TANKS:**

**STEP 1:** Interior: Check for dirt and other contamination; check for holes.

**STEP 2:** Fill holes: Check to ensure that fill holes are clean and covers are in place.

**STEP 3:** Exterior: Check to ensure the exterior is free of oils and other contaminants that may seep into the bag and contaminate the water.

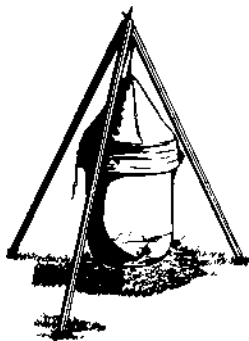
**LYSTER BAGS:**

**STEP 1:** Interior: Check for dirt and other contamination; check for holes.

**STEP 2:** Cover: Check to make sure it fits. Check for holes.

**STEP 3:** Spigots: Make sure spigots are clean and in place.

**STEP 4:** Location: Elevate Lyster bags sufficiently to prevent contamination of spigots by wildlife.



**NOTE**

Always clean the Lyster bag prior to its first use and periodically thereafter with potable water.

**WATER CANS:** Check interior for contamination; if can has a fuel odor, such as gasoline, do not use it for drinking water.



**TASK 7:** Check unit water supply for chlorine residual.

**EQUIPMENT NEEDED:** Field chlorination kit containing chlorine ampules, color comparator, and chlorine test tablets.

Check the chlorine residual when—

- Filling unit containers at water distribution points.
- Water containers arrive in unit area.
- Directed by command medical authority.
- Treating a raw water supply.

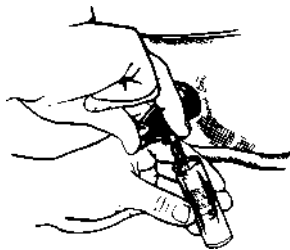
**STEPS OF PERFORMANCE:**

**STEP 1:** Determine the desired chlorine residual in milligrams per liter (mg/L).

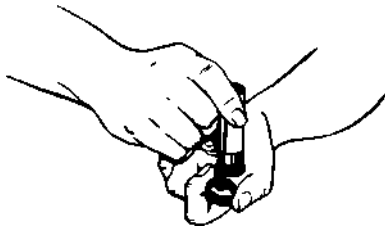
- At the point of consumption, water obtained from an approved water distribution point should have at least a trace of chlorine residual.
- When the unit must obtain water from a raw water supply, or from another source such as a stream or pond, the finished product should have a 5-mg/L chlorine residual after 30 minutes. Under certain conditions, the local medical authority may direct a higher residual.



**STEP 2:** Flush the spigots of the water container being checked and fill the color comparator tube to a point just below the top of the tube.



**STEP 3:** Place one chlorine test tablet in the comparator and allow it to dissolve.



**STEP 4:** Hold the color comparator at eye level and toward a good light source.

**STEP 5:** Compare the color of the water with the color disc on the opposite side of the color comparator.



- The water is safe to use if the color of the water is the same shade or darker than the required color for the chlorine residual.
- The water must be chlorinated if the color is lighter than the required residual.

**TASK 8:** Chlorinate water supplies.

**EQUIPMENT NEEDED:** Field chlorination kit, a 6-ounce jar of calcium hypochlorite (HTH) (70 percent chlorine), or a container of 5- to 6-percent household bleach. Chlorinate the water when—

- The water supply has no chlorine residual.

- The chlorine residual is below required level.
- A raw (untreated) or unapproved water supply must be used.

**STEPS OF PERFORMANCE:**

**STEP 1:** Before adding chlorine, check the chlorine residual following the procedures in Task 7.

**STEP 2:** If the chlorine residual is less than the desired level, add enough chlorine to raise the residual to the required level. Use Table A-1 to determine the amount to add to untreated water. If a 10 mg/L chlorine residual is required, double these amounts. To increase the residual in treated water, smaller quantities of chlorine will be needed.

**STEP 3:** Wait 10 minutes, then check the chlorine residual.

**STEP 4:** If the residual is less than 5 mg/L, repeat steps 2 and 3 using a smaller amount of chlorine.

**STEP 5:** If the residual is at least 5 mg/L, wait an additional 20 minutes before drinking.

*Table A-1. Amounts of HTH and Bleach Equivalent to a 5 mg/L Dose in Various Volumes of Water Volume\**

VOLUME	AMPULES	HTH		5% BLEACH	
		MRE SPOON	MESSKIT SPOON	MRE SPOON	MESSKIT SPOON
5 GAL	0.5			0.5	
10 GAL	1.0			1.0	
20 GAL	1.0			2.0	
32 GAL	2.0			2.0	1.0
36 GAL	2.0	0.5		3.0	1.0
50 GAL	3.0	0.5		3.0	1.0
55 GAL	3.0	0.5		4.0	1.0
100 GAL	6.0	1.0		7.0	2.0
150 GAL	8.0	1.0		10.0	3.0
160 GAL	9.0	1.0		11.0	3.0
250 GAL	14.0	2.0	0.5	17.0	5.0
400 GAL	22.0	3.0	1.0	26.0	7.0
500 GAL	27.0	3.0	1.0	33.0	9.0
1000 GAL	54.0	7.0	2.0	66.0	18.0
3000 GAL	162.0	20.0	6.0	196.0	54.0
5000 GAL	270.0	33.0	10.0	327.0	90.0

\* THE QUANTITIES DEPICTED IN THIS TABLE ARE GENERAL GUIDELINES, ACTUAL AMOUNTS MAY VARY BASED ON WATER QUALITY.

**TASK 9:** Set up, construct, and maintain field waste disposal devices.

**EQUIPMENT NEEDED:**

- Set up required number of chemical toilets.
- Collect material for type of improvised facilities to be constructed, if required.
- Establish a detail to set up or construct the devices.

**DISPOSAL METHODS THAT MAY BE USED IN THE FIELD:**

**NOTE**

Local, state, federal, and host-nation regulations or laws may prohibit burning or burial of waste. The garbage, rubbish, and other such material may have to be transported to a waste disposal facility. Chemical toilets are the required human waste disposal devices for use during field exercises or missions. Improvised devices may be used under emergency conditions; the burn-out latrine is the preferred method for improvised devices.

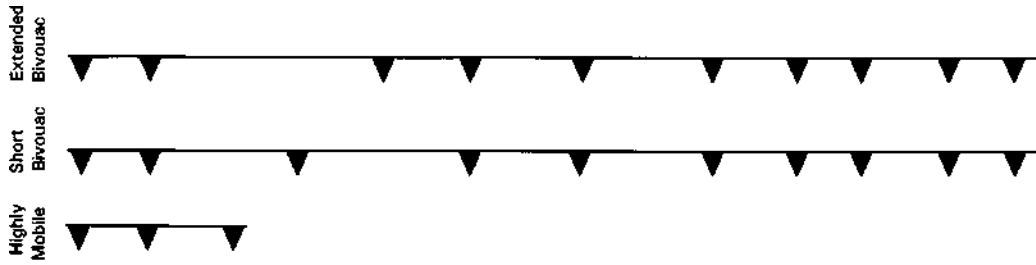
- Garbage/rubbish disposal.
  - Collect and transport to approved disposal facilities.

- Expedient devices.
  - Burial—Less than 1 week.
  - Incineration—Longer than a week.
- Liquid kitchen or bathing waste disposal.
  - Grease trap.
  - Soakage pits.
  - Evaporation beds.
- Human waste disposal.
- Chemical toilets. Urinals should be provided in these facilities to prevent soiling the toilet seats, if possible.
  - Individual waste collection bags on the march or for small groups in isolated areas.
  - Cat-hole latrine for marches if individual waste collection bags are not available.

- Field expedients when individual waste collection bags are not available—
  - Burn-out latrine.
  - Pail latrine when chemical toilets are not available, the ground is too hard, or the water table is too high (soil is very wet).
  - Straddle trench for 1 to 3 day bivouac sites when burn-out or pail latrine are not available.
  - Deep pit latrine for temporary camps.
  - Soakage pits for urinals at temporary camps.
  - Trough urinal.
  - Pipe urinal.
  - Urinoil. (See page A-44 for further information on the urinoil.)

**STEPS OF PERFORMANCE:**

**STEP 1:** Use the following chart to determine disposal requirements.

**INDIVIDUAL WASTE COLLECTION BAGS**

Dispose of with regular waste.

**CHEMICAL TOILETS**

The preferred field device. Add urinals to protect seats in latrines.

**CAT-HOLE**

Cover with dirt after use.

**STRADDLE TRENCH**

Enough for 6 percent of the soldiers. Cover with dirt after each use.

**DEEP PIT**

Enough for 6 percent of the soldiers. Add urinals to protect seats in male latrines.

**GARBAGE PIT**

Locate near dining facility, but not closer than 100 feet. One pit per 100 soldiers served per day. Cover with dirt after each meal; close daily.

**SOAKAGE PITS (FOOD SERVICE)**

Locate near dining facility; need at least two. Fill with loose rocks. Add grease trap for dining facility waste. Alternate daily use.

**SOAKAGE PIT (OTHER)**

Provide soakage pit for urinals, shower, Lyster bag, or other locations where water collects.

**MESS KIT LAUNDRY/SANITATION CENTER**

Dig soakage pit to provide good drainage.

**HANDWASHING DEVICES**

Dig shallow soakage pit. Collocate with latrines and food facilities.

**SHOWERS**

Dig soakage pit.

**URINALS**

Trough  
Pipe  
Urinoit



**STEP 2:** Select site of construction.

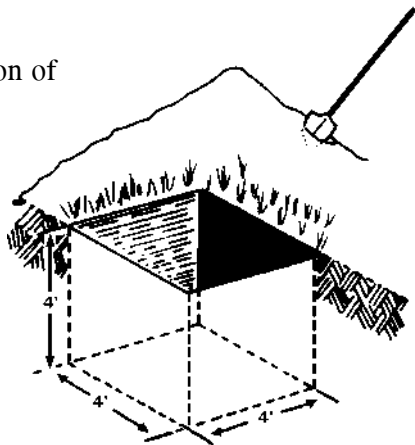
- Garbage and soakage pits should be at least 30 meters from food service.
- Latrine should be as far as possible from food service (100 meters or more is best).
- Latrine should be located on level ground. Never uphill from the campsite or water supplies.

**STEP 3:** Construct disposal facility.

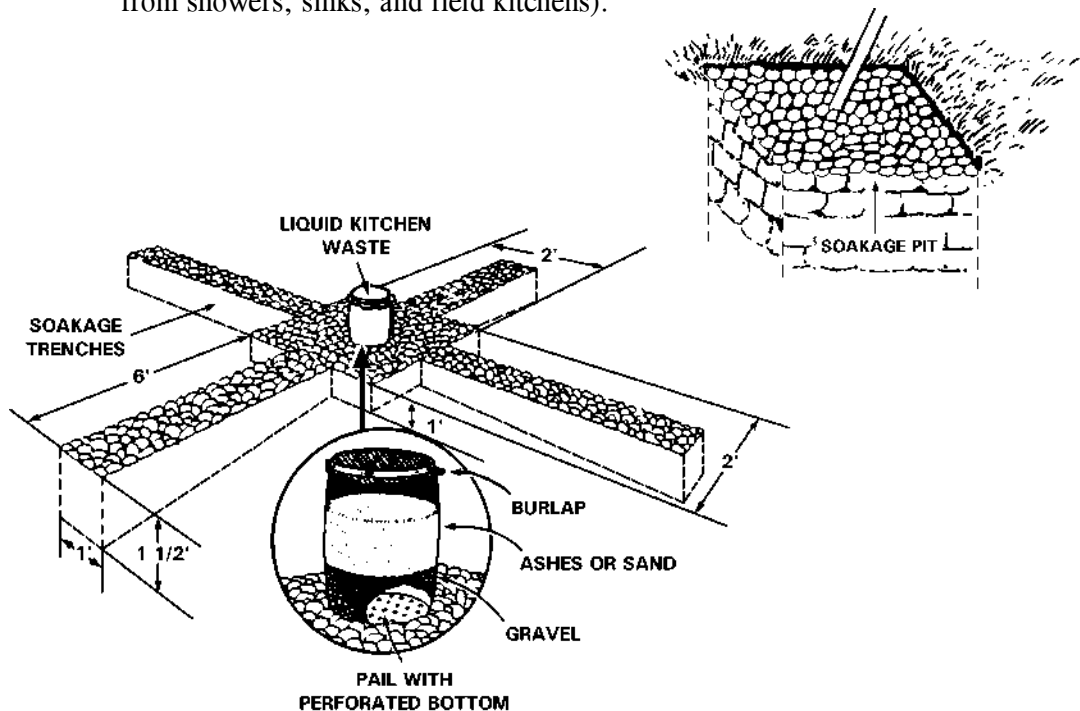
- **Garbage pit**—Used to prevent accumulation of garbage in the unit area.

**NOTE**

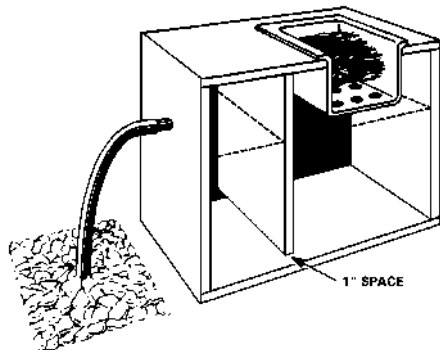
Garbage and rubbish should be transported to an approved landfill or must be buried or burned. If buried for short stays, cover daily. For longer periods, garbage and rubbish may have to be burned; however, the ashes should be buried. (Reader should consult the note on page A-32.)



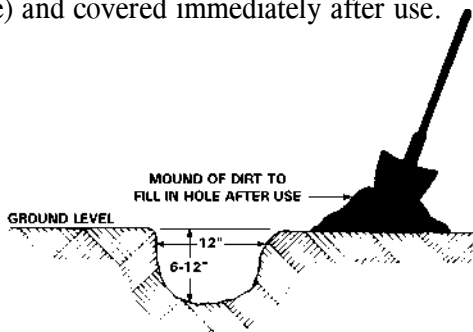
- **Soakage pit/trench**—Used to prevent accumulation of liquid waste (water from showers, sinks, and field kitchens).



- **Grease trap**—Used with both soakage pit and trench to prevent clogging of soil.



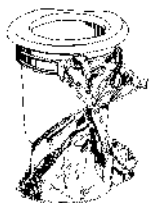
- **Cat-hole latrine**—Used only on the march (if individual waste collection bags are not available) and covered immediately after use.



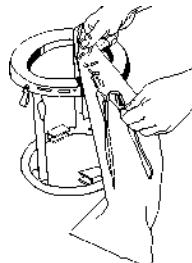
- **Chemical toilets**—Used as the standard field latrine.



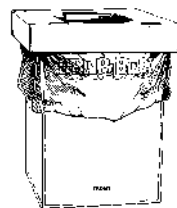
**BRIEF RELIEF  
(INDIVIDUAL)**



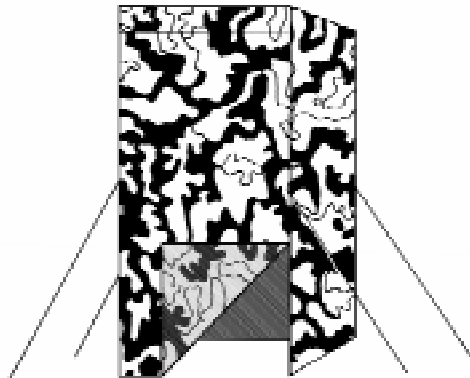
**DISPOSA-JOHN**



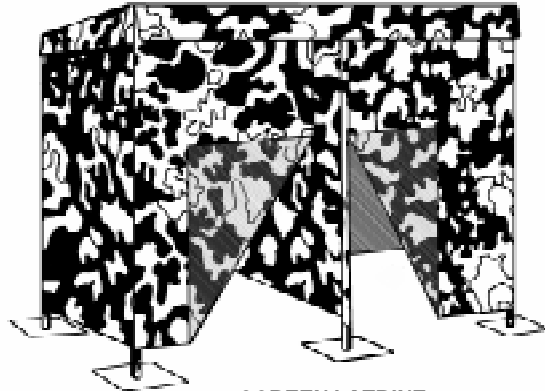
**INDIVIDUAL SERVICE  
MEMBER FIELD TOILET**



**DROP-BOX TOILET**

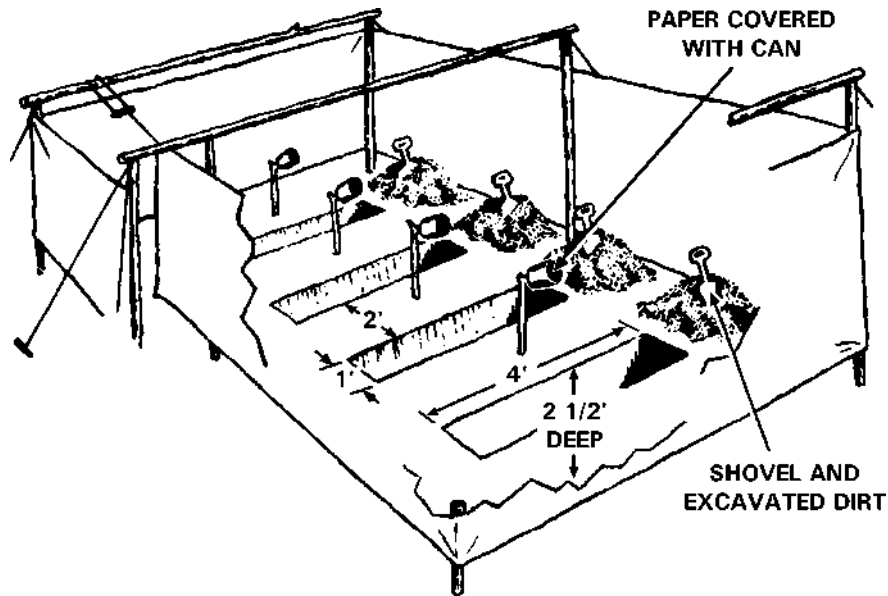


**INDIVIDUAL TENT LATRINE**

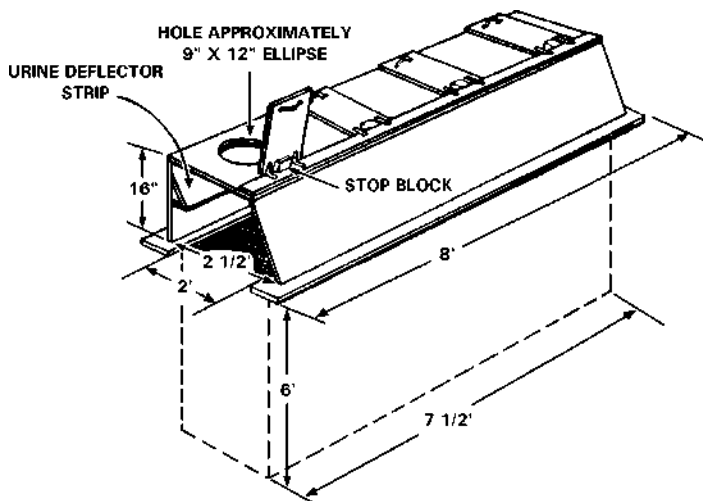


**SCREEN LATRINE**

- **Straddle trench latrine**—Used on short bivouacs and field training exercises. Two trenches per 100 males and three trenches per 100 females.



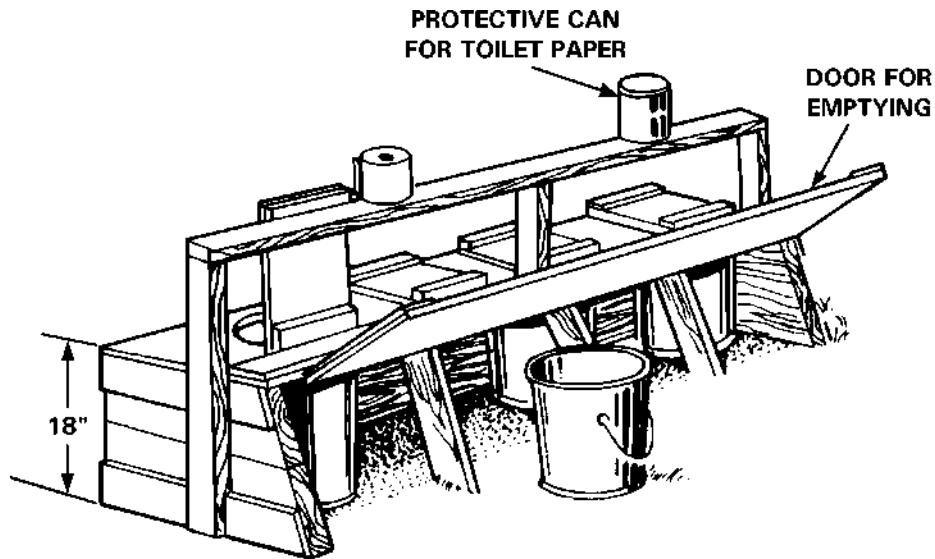
- **Deep pit latrine**—Used for longer periods of time and in built-up areas. Collapsible two-seat boxes are available in the supply system.



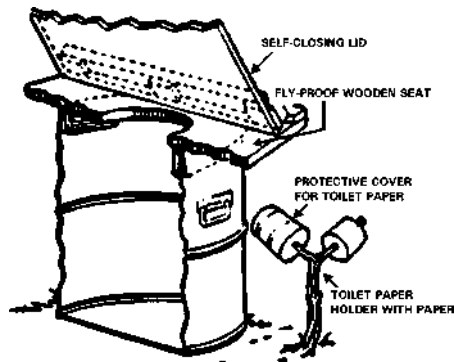
#### NOTE

If ground is too hard for digging, or if the water table is too high, use a pail latrine or a burn-out latrine.

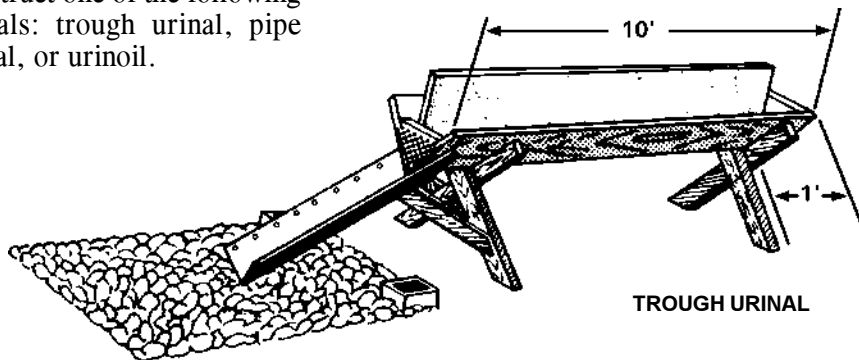
- **Pail latrine**—Use where water table is too close to the surface of the ground for digging a deep pit latrine.



- **Burn-out latrine**—Use where water table is too close to the surface of the ground for digging a pit latrine, or stay is for an extended period.

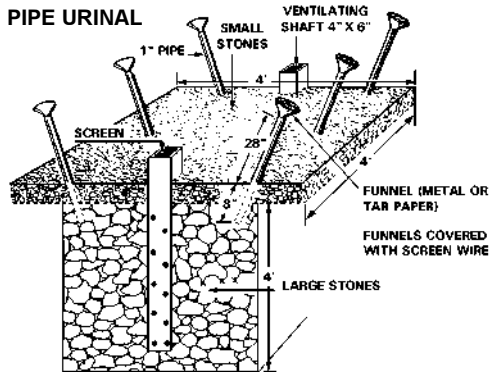


- **Urinals**—For male latrines, construct one of the following urinals: trough urinal, pipe urinal, or urinoil.

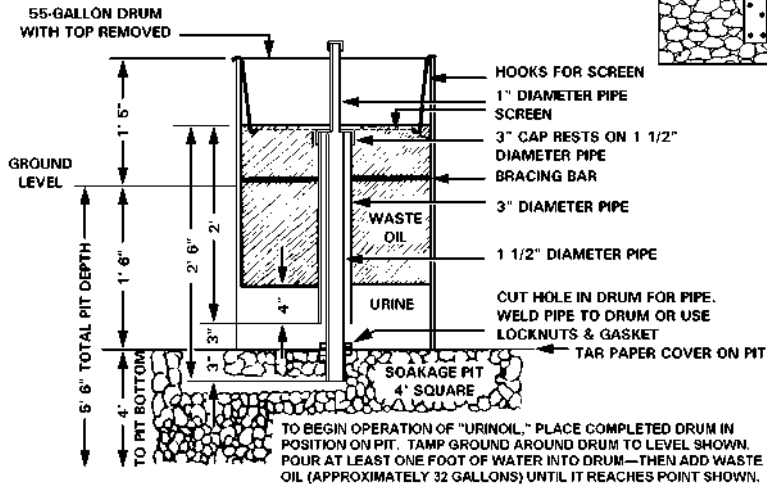


TROUGH URINAL





**URINOIL**



**STEP 4:** Inspect daily to make sure that the following is done:

- Waste is collected and transported to an approved disposal facility.
- Straddle trench latrines and garbage pits are covered with dirt daily.
- Pail latrines are emptied and cleaned daily.
- Burn-out latrine containers are rotated and contents burned daily. • Facilities (not the contents) are sprayed with insecticide for fly control when other control techniques fail.

**STEP 5:** Close improvised latrines and garbage pits when filled to within 1 foot of the ground surface. Have chemical toilet contents removed daily.

Close out by—

- Spraying with residual insecticide.
- Packing earth in successive 3-inch layers until mounded 1 foot above ground level. Spraying again with residual insecticide.
- Posting a sign stating, “Closed latrine/garbage pit and date” (except in combat).

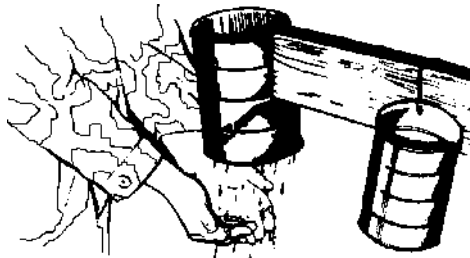
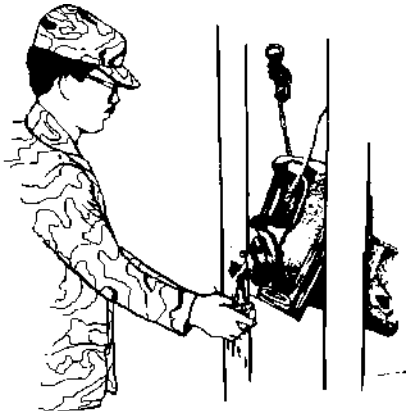
**TASK 10:** Construct and maintain field handwashing and shower devices.

**EQUIPMENT NEEDED:** Personnel detailed to construct and maintain field handwashing and shower devices. Material as required for type of facilities to be constructed.

**STEPS OF PERFORMANCE:**

**STEP 1:** Select device to be constructed.

- Handwashing devices.



- Shower devices.

**STEP 2:** Construct devices.

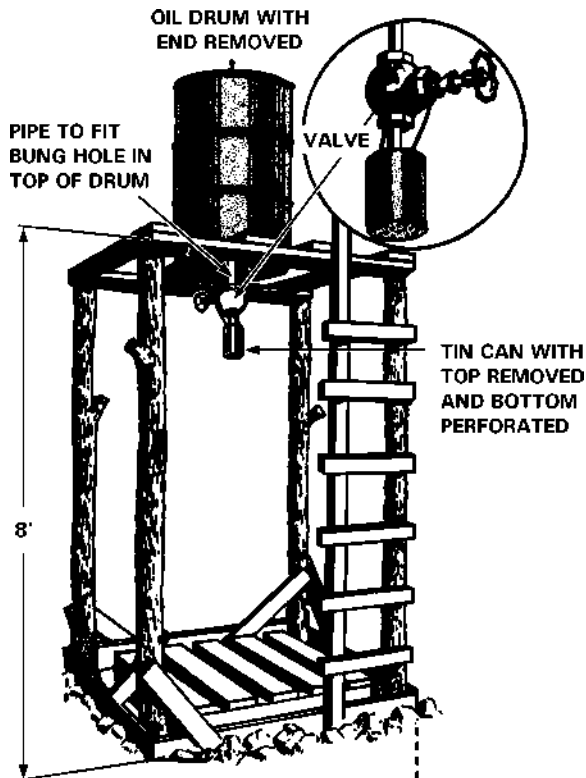
- Collocate handwashing devices at food service and latrine locations.

**NOTE**

A soakage pit should be provided for all handwashing and shower facilities.

**STEP 3:** Maintain devices. A supply of soap and water must be available at all times.

**STEP 4:** Close devices.



## GLOSSARY

**ABBREVIATIONS AND ACRONYMS**

<b>AO</b>	area of operations
<b>attn</b>	attention
<b>C</b>	centigrade
<b>DA</b>	Department of the Army
<b>DEET</b>	75 percent N, N-diethyl-M-Toluamide
<b>DNBI</b>	disease and nonbattle injury
<b>DOD</b>	Department of Defense
<b>F</b>	Fahrenheit
<b>FM</b>	field manual
<b>FST</b>	field sanitation team
<b>gal</b>	gallon

## **FM 21-10/MCRP 4-11.1D**

**GTA** graphic training aid

**hr** hour

**HSS** health service support

**HTH** calcium hypochlorite, 70 percent available chlorine

**lb** pound

**LP** listening post

**MCRP** Marine Corps Reference Publication

**mg/L** milligrams per liter

**min** minute

**MOPP** mission-oriented protective posture

**mph** miles per hour

**MRE** meal(s), ready to eat

**MSDS** material safety data sheets

**Glossary-2**

<b>NBC</b>	nuclear, biological, and chemical
<b>NL</b>	no limit
<b>NSN</b>	National Stock Number
<b>OP</b>	observation post
<b>PMM</b>	preventive medicine measures
<b>psi</b>	pounds per square inch
<b>PVNTMED</b>	preventive medicine
<b>qt</b>	quart
<b>SOP</b>	standing operating procedure
<b>STD</b>	sexually transmitted disease
<b>US</b>	United States
<b>UV</b>	ultraviolet
<b>WGBT</b>	wet bulb globe temperature

## REFERENCES

### Joint or Multiservice Publications

- AR 40-562. *Immunizations and Chemoprophylaxis*. AFJI 48-110; BUDMEDINST 6230.15; CG COMDTINST M6230.4E. 1 November 1995.
- FM 8-33. *Control of Communicable Diseases Manual* (16th Edition). NAVMED P-5038. 9 April 1996.
- TM 5-632. *Military Entomology Operational Handbook*. NAVFAC MO-310; AFM 9-16. 1 December 1971. (Reprinted with basic including Changes 1—2, January 1976).
- TB Med 81. *Cold Injury*. NAVMED P-5052-29; AFP 161-11. 30 September 1976.
- TB Med 507. *Occupational and Environmental Health Prevention, Treatment, and Control of Heat Injury*. NAVMED P-5052-5; AFP 160-1. 25 July 1980.
- DOD Instruction 4150.7. *DOD Pest Management Program*. 22 April 1996.

### Army Publications

- AR 40-5. *Preventive Medicine*. 15 October 1990.
- AR 40-35. *Preventive Dentistry*. 26 March 1989.
- DA Pam 600-63-11. *Dental Health Module for "Fit to Win" Program*. September 1987.
- FM 8-34. *Food Sanitation for the Supervisor*. 30 December 1983.
- FM 8-250. *Preventive Medicine Specialist*. 27 January 1986. (Reprinted with basic including Change 1, 12 September 1986).



## **FM 21-10/MCRP 4-11.1D**

FM 10-23. *Basic Doctrine for Army Field Feeding and Class I Operations Management*. 18 April 1996.

FM 10-52. *Water Supply in Theaters of Operations*. 11 July 1990.

FM 10-52-1. *Water Supply Point Equipment and Operations*. 18 June 1991.

FM 21-11. *First Aid for Soldiers*. 27 October 1988. (Reprinted with basic including Changes 1—2, 4 December 1991).

FM 21-20. *Physical Fitness Training*. 30 September 1992. (Change 1, 1 October 1998).

FM 21-76. *Survival*. 5 June 1992.

CTA 50-900. *Clothing and Individual Equipment*. 1 September 1994.

TB Med 530. Occupational and Environmental Health Food Service Sanitation. 28 November 1991.

TB Med 561. Occupational and Environmental Health Pest Surveillance. 1 June 1992.

TB Med 577. Occupational and Environmental Health: Sanitary Control and Surveillance of Field Water Supplies. 7 March 1986.

GTA 5-8-12. *Individual Safety Card*. 25 February 1999.

GTA 8-6-12. *Adverse Effects of Cold*. 1 August 1985.

## **Department of the Defense Form**

1532-1. *Pest Management Maintenance Record*. August 1996 (EG).

## **Technical Notes**

United States Army Research Institute of Environmental Medicine, Natick, MA 01760.

## **References-2**

- USARIEM TN 93-1. Sustaining Soldier Health and Performance in Somalia: Guidance for Small Unit Leaders, December 1992.
- USARIEM TN 93-6. Sustaining Soldier Health and Performance in Yugoslavia: Guidance for Small Unit Leaders, June 1993.
- USARIEM TN 94-4. Sustaining Soldier Health and Performance in Haiti: Guidance for Small Unit Leaders, September 1994.
- USARIEM TN 95-1. Sustaining Soldier Health and Performance in Southwest Asia: Guidance for Small Unit Leaders, October 1995.

## INDEX

- acclimatization**, 2-1
- area of operation**, 1-1
- arthropod(s)**, 3-8, 3-17
  - ants, A-10
  - bees, A-10
  - biting, 3-8, 3-17, 3-18, 3-10, A-6
  - centipedes, 2-19, A-9
  - cockroaches, A-7
  - control, 2-17, 4-1, A-1
  - filth flies, A-6
  - fleas, A-2
  - lice, 3-19, A-3
  - minimize exposure to, 3-20, A-1
  - mites, A-4
  - mosquitoes, A-1
  - repellents, 2-13—15, A-1, A-2, A-6
  - scorpions, 2-18, A-9
  - spiders, 2-18, A-8
  - ticks, A-4
  - wasps, A-10
- bathe/bathing**, 2-16, 3-18, 3-27

## **FM 21-10/MCRP 4-11.1D**

### **bed net**

repair, 2-18

use, 2-17

**biological waste**, 2-43

**bleach, household**, 2-26

### **can**

water, A-26

**chemical(s), toxic materials**, 2-38

bore/gun gases, 2-41

carbon monoxide, 2-40, 2-42

gloves, A-5, A-10, A-12, A-14, A-16

grease, oils, and solvents, 2-41

hydrogen chloride, 2-40

injuries, 2-40

protection, 2-41

threat

biological/radiological, 2-40

industrial, 2-39

occupational, 2-38

### **chlorine**

ampules, 2-24, A-27

residual, A-27

test tablets, A-27

## **Index-2**

**cold**

- injuries, 2-6—12, 3-9—10
- protection from, 2-9—12
- special considerations, 3-14
  - carbon monoxide poisoning, 3-15
- windchill
  - categories, 3-12
  - chart, 3-11
  - factor, 3-10

**combat**

- hospital admissions, 1-1
- injuries, 1-1

**cycles**

- rest, 2-3, 3-3, 3-7
- work, 2-3, 3-3, 3-7

**dehydration, 2-1, 2-2—3****diarrhea**

- dehydration, 2-23
- disease organisms, A-17
- hazardous foods, A-17
- outbreak factors, 2-22, A-17

**disease, 1-1, 2-13**

- dental, 2-33
- foodborne, 2-22, 2-28—29, 3-22, 3-26

## FM 21-10/MCRP 4-11.1D

### disease (*continued*)

nonbattle injury, 1-1, 4-1

rates, 1-1

sexually transmitted, 2-33

wasteborne, 2-22, 3-22

waterborne, 2-23

**domestic and wild animals, 3-17, A-2**

**feet, care of, 2-9, 2-32**

### field sanitation

devices, 3-24, 4-2, 4-3, A-32

garbage pit, A-36

grease trap, A-38

latrines, 3-24—25

burn-out, 3-24, A-32, A-43

cat hole, 2-30, A-38

chemical toilets, 3-24, A-39

deep pit, A-4

pail, A-42

straddle trench, A-40

soakage

pit, A-36

trench, A-36

urinals, A-43—44

pipe, A-44

**field sanitation**

## devices

urinals (*continued*)

trough, A-43

urinoil, A-44

team, Preface, Chapter 4

concept, 4-1

lice infections, 3-20, A-3

members, 4-3

operations, 4-1

pesticides, 3-20, 3-25

prophylaxis, 3-18

scope of operation, 4-1

site selection, 3-20, 4-2

tasks, Appendix A

training, 3-1, 3-9, 3-17, 3-22, 3-26, 3-27, 4-4, Appendix A

**fitness**

leaders role, 2-30

physical, 3-1, 3-26

**fleas, A-2****fluid replacement, Table 3-1****food**

civilian vendors, 2-27

hazardous, A-17

inspection, A-20

## **FM 21-10/MCRP 4-11.1D**

### **food** (*continued*)

insulated containers, A-19—20

safe temperatures, A-20

safety, 3-29

service operations, A-17

### **frostbite**, 2-6

### **hands**, 3-16

washing, 2-29, 3-24

### **handwashing devices**

location, 3-25, A-19

use, 3-25, A-19

### **heat**

acclimatization, 2-1

condition information, 3-3

injuries, 2-1, 3-1

in MOPP/body armor/armored vehicles, 2-4

prevention, 2-2, 3-1

special considerations, 3-8

stress, 2-1, 2-4, 2-5

### **household bleach**, 2-26

### **hydration**, 2-2

### **illness**

food, 3-22

### **Index-6**



**illness** (*continued*)

water, 3-22

**infections**

genital, 2-31, 2-33

prevention, 2-31

skin, 2-31

urinary tract, 2-33

**insecticide**

aerosol, A-7

DEET, 2-13, 2-18

spray, 3-25

use, A-7

**iodine tablets**, 2-23**latrines**, 3-25, A-6**laundry**, 3-24**lice**, 3-19, A-3**Lyster bags**, A-26**meals**

eating, 2-4

salt replacement, 2-4

**medical threat**, Chapter 1

advice, 2-17

arthropods, 3-8

## **FM 21-10/MCRP 4-11.1D**

### **medical threat** (*continued*)

cold, 3-9

heat, 3-1

**mess kit laundry**, 2-29, A-21

**mites**, A-4

**mosquitoes**, A-1

### **noise**, 2-37

effects of, 3-31

individual protection measures, 3-32

protection from, 2-37, 3-32

**nonbattle injury**, 1-1

**permethrin**, 2-13, 2-15

**personal hygiene**, 2-16, 2-30, 3-2, 3-26

female, 3-27

male, 2-33

plan for, 2-32, 3-27

skin infection, 2-31

**poisonous plants**, 2-21, 3-21

**preventive medicine measures**, 1-2

individual, Chapter 2, 3-17, 3-22

leaders, Chapter 3

principles of, 1-3—4

## **Index-8**

**preventive medicine measures** (*continued*)

- tasks, Appendix A
- unit level, Appendix A
- windchill, 3-13

**prisoner of war**, 1-1**protect**

- buddy, 2-11
- ears, 2-10
- eyes, 2-5, 2-11
- face, 2-10
- feet, 2-9
- hands, 2-9
- head, 2-16
- health, 2-13

**repellents**

- DEET, 2-13, 2-18
- permethrin, 2-13, 2-15

**rest**, 3-7**risk**

- of contamination, 2-2
- of heat stress/injuries, 2-5

**rodents**, 3-17, A-2, A-14

- traps. *See* snap traps.

**salt**

- replace, 2-4
- tablets, 2-4

**sanitation center**, A-21

**sexually transmitted diseases**, 2-33

**showers**, 3-19, 3-27, A-46—47

**sleep**

- catnaps, 2-35, 3-28
- discipline, 2-35, 3-28
- loss, effects of, 2-35, 3-29
- minimize loss, 2-35
- safety, 2-12, 2-20
- when possible, 2-35, 2-37

**snakes**, 2-20, 3-17, A-16

**snap traps, mechanical**, A-14, A-16

**sprayer, 1- or 2-gallon**

- cleaning, A-13
- use of, Appendix A

**stress**

- combat, 2-36
- heat, 2-1, 2-4, 2-5
- reduce within unit, 2-36

**tablets**

- Chlor-Floc®, 2-24

**Index-10**

**tablets** (*continued*)

chlorine test, A-27

iodine, 2-23, 3-23

salt, 2-4

**thermometer**, A-17, A-22**ticks**, A-4**toilet articles**, 2-32**toxic fruit**, 2-21**toxic industrial chemicals**, 2-38, 3-33

identify, 3-33

injury, 2-40

threat, 2-38

protect from, 2-41, 3-34

**undergarments**

cotton, 2-34, 3-27

silk-polyester type, 2-32, 3-27

**uniform**

laundry, 2-17

modify, 2-5

treat, 2-15

wear, 2-7, 2-16

**unit**

cohesion, 3-31

health, 3-29

**unit** (*continued*)

- pride, 3-31
- safety, 3-29
- uncertainty, 3-30
- welfare, 3-29

**waste disposal**, 2-13

devices

- burial, 3-24, 3-26, A-33
- closing, A-45
- garbage/rubbish, 4-2, A-15, A-32, A-36
- human waste
  - latrines, 3-25, A-33
    - burn-out, A-34, A-43
    - cat hole, 2-30, A-33, A-38
    - chemical toilet, A-33, A-39
    - collection bags, 4-2, A-34, A-39
    - deep pit, A-34, A-41
    - location, 3-25
    - pail, A-34, A-42
    - pipe, A-44
  - soakage
    - pits, A-37
    - trenches, A-37
  - straddle trench, A-34, A-40

**waste disposal**

## devices

human waste (*continued*)

urinals, A-33, A-43

urinoil, A-44

incinerator, A-33

**water**

bag, Lyster, A-26

boiling, 2-27

can, 3-23

chlorinate, 2-24

chlorination kit, field, A-27

chlorine residual, 2-26, A-27

containers, A-22, A-25

distribution point, 3-21—22, A-27

drinking, 2-2, 2-8, 2-23

flavoring, 2-2

potable, 3-2

requirements, 2-1, 2-2

supplies, 4-2, A-29

trailer, 4-2, A-23

treatment of, 2-24—27

**windchill**, 3-10, 4-5

chart, 3-11

index, 3-14

## **FM 21-10/MCRP 4-11.1D**

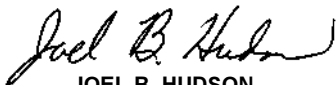
### **windchill** (*continued*)

preventive medicine measures, 3-13—14, 3-15—16  
work/rest cycles, 2-3, 3-3, 3-4, 3-7



By Order of the Secretary of the Army:

Official:



**JOEL B. HUDSON**  
*Administrative Assistant to the  
Secretary of the Army*  
0011110

**ERIC K. SHINSEKI**  
*General, United States Army  
Chief of Staff*

By Direction of the Commandant of the Marine Corps:

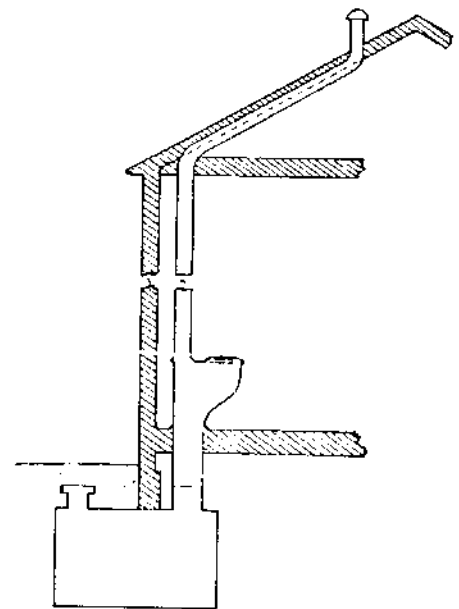
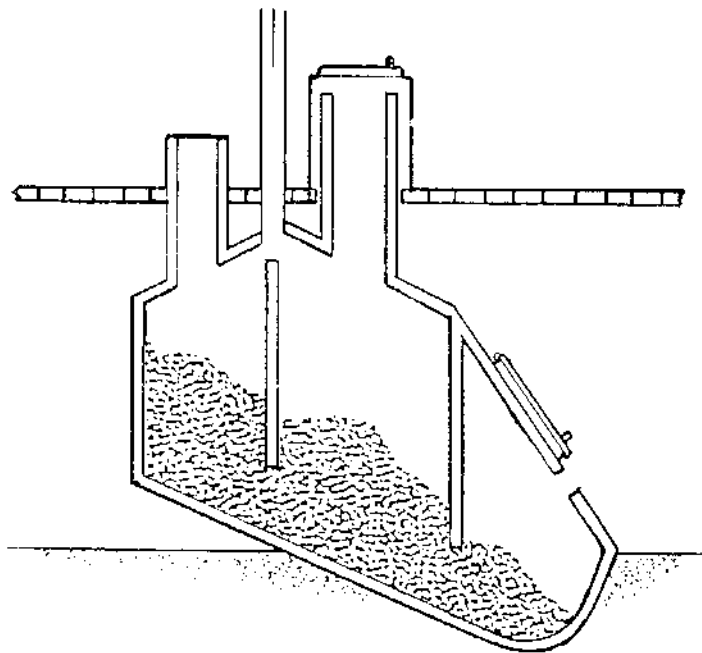


**J.E. RHODES**  
*Lieutenant General, US Marine Corps  
Commanding General  
Marine Corps Combat Development Command*

**DISTRIBUTION:**

- US Army:** *Active Army, USAR, and ARNG:* To be distributed in accordance with the initial distribution number 110160, requirements for FM 21-10.
- US Marine Corps:** PCN: 14400008600

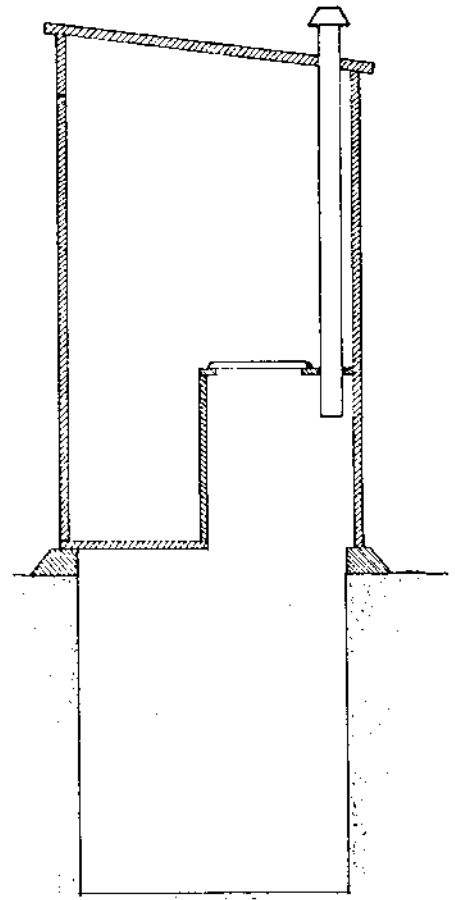
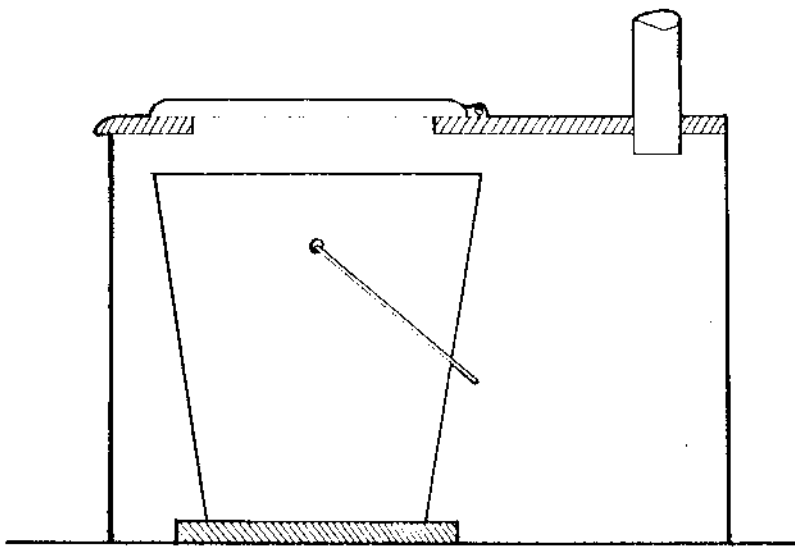
# UNSEWERED TOILETS



Ministry  
of the  
Environment

Hon. George A. Kerr, Q.C.  
Minister

K. H. Sharpe  
Deputy Minister



# CONTENTS

FOREWORD	
I. INTRODUCTION	3
II. THE SEPTIC TANK SYSTEM	5
A. What Does It Do?	
B. How Does It Work?	
1. The Tank	
2. The Leaching Bed	
C. Disadvantages?	
III. PRIVIES	7
A. Pit Privy	
1. Construction	
2. Pro and Con	
B. Pail and Vault Privies	
IV. CHEMICAL TOILETS	10
A. The Basic Chemistry	
B. Pro and Con	
C. Variations	
1. Bucket	
2. Improvements: Splash Pan and Drop Pipe	
3. Recirculating	
4. Portable	
V. INCINERATING TOILETS	14
VI. COMPOSTING TOILETS	16
A. Introduction	
1. What Composting Is	
2. Low Temperature, Flies, and the Vegetable Garden	
B. Large and Small Units	
1. Large Units	
2. Small Units	
C. Summary: Composting May Be Right For You	
VII. SOME OF THE OTHERS	25
A. Septic Toilet	
B. Low-Volume (Minimum-Flush) Toilets	
C. Portable Low-Volume Toilets	
D. Continuous Aeration Systems	
APPENDIX I	28
Regulation to Amend Ontario Regulation 229/74	
TABLE I. Unsewered Toilets: An Aid to Decision	34



## FOREWORD

There are about 300,000 cottages in Ontario, occupied generally by well over 1.2 million people for part of the year. One of the main problems all cottagers have in common is that of the disposal of human waste.

Where the toilet facilities can be connected to a municipal sewage system, the solution is obvious. In the majority of cases, however, municipal services are not provided, and the alternative, a good septic tank system, is either expensive or, in many cases, not suitable because of the nature of the terrain.

Ontario regulations, especially Regulation 229/74 under The Environmental Protection Act, 1971, and its amendments, require the approval of all sewage disposal installations, with the exception of systems of Class I. These systems comprise various types of unsewered toilets, known as earth or pit privies, vault privies, removable

pail privies, chemical toilets, incinerating toilets, and composting toilets.

Toilets of Class I are widely used because of their simplicity and their low cost of installation. If properly installed, used, and maintained, they can give good service without damaging the environment.

This booklet provides all the information necessary for proper installation, use, and maintenance of Class I toilet systems. It explains the limitations of the various systems, their advantages and disadvantages, and their possible effect on the environment if they are misused or not properly maintained.

A separate chapter describes in detail the principle, the operation, the advantages and disadvantages, the installation, the use, and the maintenance of the new composting toilets.



## I. INTRODUCTION

The ideal toilet system must reliably dispose of human wastes in a way that neither spreads disease nor offends civilized sensibilities. The standard flush toilet, with its smooth, white surface, self-cleansing flush, water seal against odours, and access to sewers that are someone else's responsibility, is the best choice from the standpoint of health and aesthetics, but it's not always available. It typically runs through three or four gallons of water every time it is flushed. It thus needs an ample supply of water, electricity to run the water pump, and a place to dispose of a lot of wastewater.

Where the standard toilet won't do, you must make other arrangements. As you cast about for alternatives, you will discover human ingenuity at its most diverse: you'll discover privies and chemical toilets, incinerating toilets, variations on the standard flush, indoor compost toilets, and small activated-sludge plants, in fascinating profusion. None of these can be pointed out as the best: all have good points and bad. The "best" choice will depend upon the facilities at your site, the convenience you want, and the money you are willing to spend. In Ontario, it will also be influenced by The Environmental Protection Act.

Sewage is potentially dangerous, even deadly. The microorganisms responsible for many grave diseases—cholera, typhoid fever, hepatitis, and polio, to mention only a few—swarm in the feces of

the sick. If these organisms reach the water supply, hundreds more may sicken. A major concern in the design of any sewage disposal system must be to ensure that the public is at no time exposed to the danger of sewage-borne disease, either indirectly, through their drinking water, or directly, by way of rats, flies, or curious children. For this reason, as well as to safeguard the environment from the unpleasant effects of careless sewage disposal, Ontario law regulates sewage disposal closely.

The disposal methods described in this booklet are not equally acceptable everywhere in Ontario. Local bylaws as well as shallow soil on a steep lot, for instance, may rule out some methods, and sandy soil may favor a system that wouldn't work in clay. To find out which forms of sewage disposal are approved in your area, see the local representative of the Ontario Ministry of the Environment.

Not every toilet unit is a sewage disposal system. A good pit privy is, since the wastes decompose where they fall and enrich their surroundings with no further disturbance, but a modern flush toilet is not. A flush toilet does no more than send the wastes upon their way. In the city, the way leads to the municipal sewage treatment plant, a subject in which we need take no further interest than pleases us. In the country, the owner must choose the destination.





## II. THE SEPTIC TANK SYSTEM

### A. What Does It Do?

Where you can't hook onto the municipal sewers, your best choice in waste disposal is usually a septic tank system, which consists of a septic tank and an underground leaching bed. The big advantage of this system over most of the others is that it will accept all of the household wastewater: the bath water, the dishwater, and the laundry water, as well as what the toilet sends. If treated with reasonable consideration, it will accept all of them without complaint for several years, until it is time to pump the accumulated sludge out of the tank.

Most installations need no machinery, no power, and, apart from pumping out the tank occasionally, no maintenance.

### B. How Does It Work?

The only way to get rid of sewage, as distinguished from merely sending it somewhere else, is to prepare a comfortable home for the microorganisms that eat it. Many strains perform this useful function. For simplicity, they can be divided into two groups: the aerobic ones, which need oxygen, and the anaerobic ones, which can't abide it.

**1. The Tank:** Anaerobic bacteria live and work in the septic tank, which is just that: a tank. It's usually big enough to hold several days' worth of sewage and shaped so that the flow is slow and reasonably uniform. Sewage from the house enters the tank, settles down, gets partly decomposed by the anaerobic bacteria, and flows out of the tank. By this time, if the system is working well, the sewage is a clearish liquid that still stinks and may still carry disease. It should not go anywhere but into the leaching bed or some equivalent treatment facility: by no means directly into a ditch or watercourse.

**2. The Leaching Bed:** A leaching bed consists of one or more rows of buried distribution pipe, each of which is a series of "tiles" laid end-to-end in a bed of crushed stone in a trench. A "tile", in turn, is a length of pipe, typically made of ceramic or plastic. Ceramic tiles are spaced about  $\frac{1}{2}$  inch apart to allow the sewage to flow into the crushed stone. The longer plastic tile is usually perforated by small holes along its length. The

crushed stone acts as a reservoir, from which the sewage can seep slowly into the soil. The dimensions of the trench and the details of how it should be filled in, the characteristics of the soil, the required length of the distribution pipe, and other particulars of the burial are important and are specified under The Environmental Protection Act\*, but they need not concern us further here.

Sewage leaving the septic tank flows down the rows of tiles, leaking continuously into the soil by way of the holes or gaps. In the soil it encounters a flourishing population of aerobic bacteria, who finish the good work begun in the tank by their anaerobic cousins. The

whole subject is decently hidden from view by a fresh, green lawn which rarely needs fertilizer.

### C. Disadvantages?

There are few disadvantages to the septic tank system, apart from its cost — and even that may not compare too badly with the cost of other units, considering that the system handles **all** the household wastes.

Its major drawback is simply that it can't be used everywhere. An impermeable soil, such as clay, won't let the liquid flow through it; a shallow soil hasn't the necessary capacity; and a very cold climate may not suit the indispensable bacteria. Consult your local Environment staff.

\* See the Ministry of the Environment's Booklet **Septic Tank Systems** (Information Services Branch, 135 St. Clair Avenue West, Toronto).

### III. PRIVIES

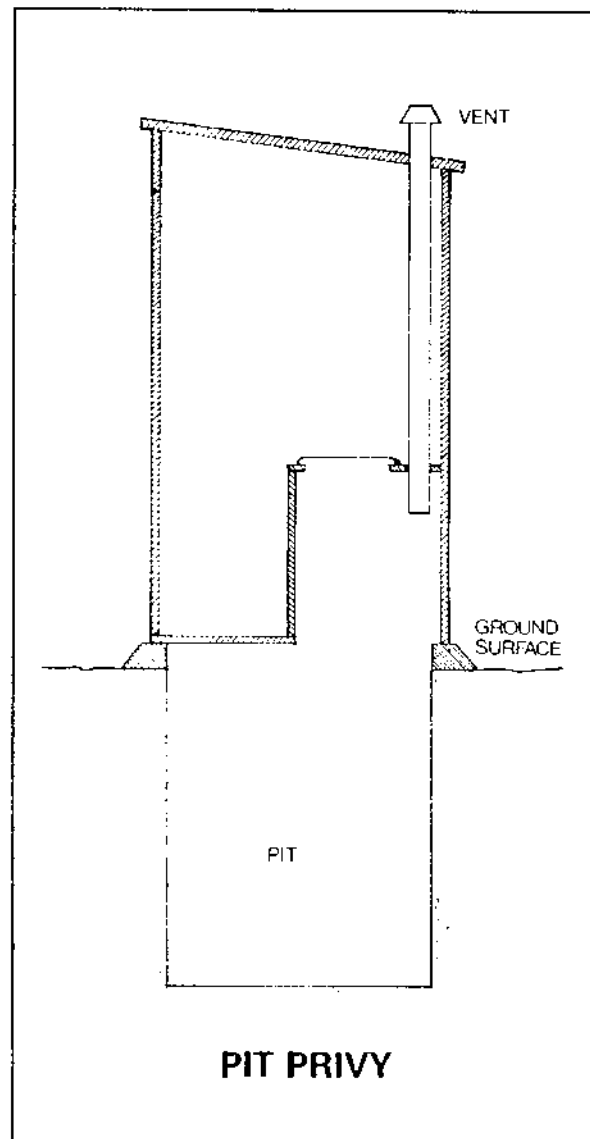
#### A. Pit Privy

1. **Construction:** A pit privy is a hole in the ground, fitted with a seat for comfort and a shed for privacy. It is justly popular for the simplicity of its concept, and it is widely used.

Despite its simplicity, a privy must be planned. To begin with, the pit should be big enough to last a while — at least five years, say, before it fills up and you have to dig a new one. For year-round family use in well-drained soil, estimate two cubic feet per person per year, but bear in mind that this figure may not apply to camping conventions or busy resorts, where the pit may fill too fast for normal drainage and decomposition. Build the shed stoutly, include a window, and put screens where they're needed, to keep out flies, rodents, and other carriers of filth. Porcupines show little interest in the pit but may eat the privy, and where they abound metal sheathing on the outside walls may help.

Don't neglect to vent the pit — not the shed, but the pit — and vent it well. Fresh air and foul will balance themselves some-

how, and you will be happier in your work if they do so through a good-sized vent pipe, rather than by way of the seat. A screen



on the top of the vent pipe will discourage flies, and a little raised roof (not a lid) will keep out the rain. The Ministry of the Environment supplies a working drawing on request.

Well-vented and considerably used, a privy is reasonably inoffensive; but a light sprinkling with chloride of lime every couple of days, or a nodding acquaintance with commercial privy deodorants, will help to keep it habitable.

While hunting for your spade, consider the soil in which the pit will be dug. There must be enough of it to surround the pit with two feet of earth in all directions, around it as well as below it, and it must have the right composition. If it's too sandy, the walls of the pit will have to be shored to prevent cave-ins. If it's solid clay, the liquids will just sit there, perpetually with you; you might as well use a holding tank to begin with, and have it pumped out when it's full. (But ask the Environment office about any local restrictions on holding tanks.)

Ideally, the soil should be porous enough to permit liquid to seep through it, tight enough to keep liquids from running through too fast, and deep enough to shield the groundwater from pollution. It should also slope away from the hole on all sides: do not dig your pit in the centre of a drainage basin, and build a low mound around it to keep out rainwater runoff.

(The "groundwater", incidentally, is the water which saturates the ground beneath the surface, the water which feeds springs and is tapped by wells. The "water table" is the tap level of the groundwater.)

When checking the water table, to be sure you stop digging the pit two feet above it, remember that it varies during the year; it's higher in wet weather and lower in droughts. Check the level shortly after the spring thaw.

A final safety note: don't let a little child use the privy unattended, especially if there's no child-size hole. Occasionally an unfortunate youngster falls in.

**2. Pro and Con:** A good privy is safe, and it does the complete job as far as toilet wastes are concerned. You may have to dig a new hole now and then, but you don't have to clean out the old one as, in effect, you may have to do with more elegant systems. It also is cheap.

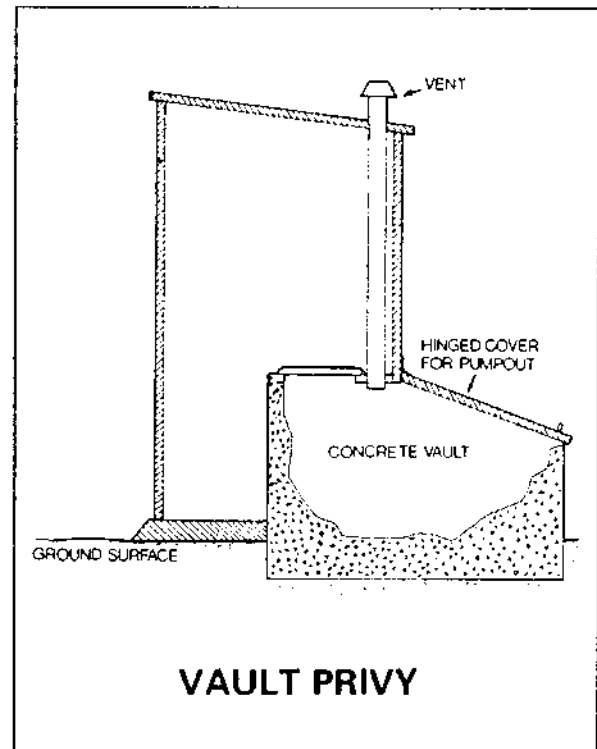
On the negative side, the privy is, for reasons of health, located at a distance from the house. This point gains in importance after dark or in winter. In some northern areas health officers frown on privies because their users fail to bundle up: the absence of warm clothing can be as unhealthy as its presence is inconvenient. A chamber-pot emptied periodically into the privy solves one problem by introducing a worse one: the presence of a thoroughly unaesthe-

tic and potentially dangerous pot of human wastes in the house.

### B. Pail and Vault Privies

Variations on the privy theme include the pail privy and the vault privy. These differ from the self-contained pit privy in that neither of them ultimately gets rid of the wastes. They merely collect them and postpone the problem for a while. The pail privy substitutes a pail for the pit, while the vault privy uses a small holding tank, the "vault". (The latter, in lightweight plastic, is often encountered at construction sites and club-houses.) The pail must be taken away from time to time and dumped, probably by you; and the vault must be pumped out and the contents taken away and dumped, probably by a contractor but at your expense.

The contractor will need a dumping permit from the Ministry of the Environment. You need no permit to bury your pailful on your own property, but you are obliged to make certain it causes no pollution and creates no public health nuisance. After a while, if you begin to get tired of the squashy places



in your woods, you may wish to consider a cesspool. A cesspool is basically the pit of a pit privy, with a lid instead of a shed. It must meet all the design requirements of the privy pit, and it requires a permit. Unless suitable soil is a long walk from the house, you'll be better off with the pit privy.

If you opt for one of these, the vault is the better choice. The pail is cheaper, but you may not enjoy carrying it. Besides, it's a health hazard.

## IV. CHEMICAL TOILETS

### A The Basic Chemistry

The simplest chemical toilet is a bucket with a seat. The "chemical" part is a small amount of solution poured into the bucket before use. It can act in one of three ways: as a caustic, as a preservative, or as a dye. Accordingly, it may decompose the wastes, preserve them, or merely improve their appearance.

The first two kinds of chemicals make the wastes harmless. The caustic, usually caustic soda or lye, liquifies and partly decomposes the wastes, at the same time killing any bacteria present and destroying the eggs of parasites, a significant feature in controlling the spread of disease. A chemical preservative such as formaldehyde also destroys any bacteria present; however, it then prevents the wastes from decomposing: it kills the bacteria which would otherwise bring about biological decomposition, but lacks the chemical decomposing power of the caustic.

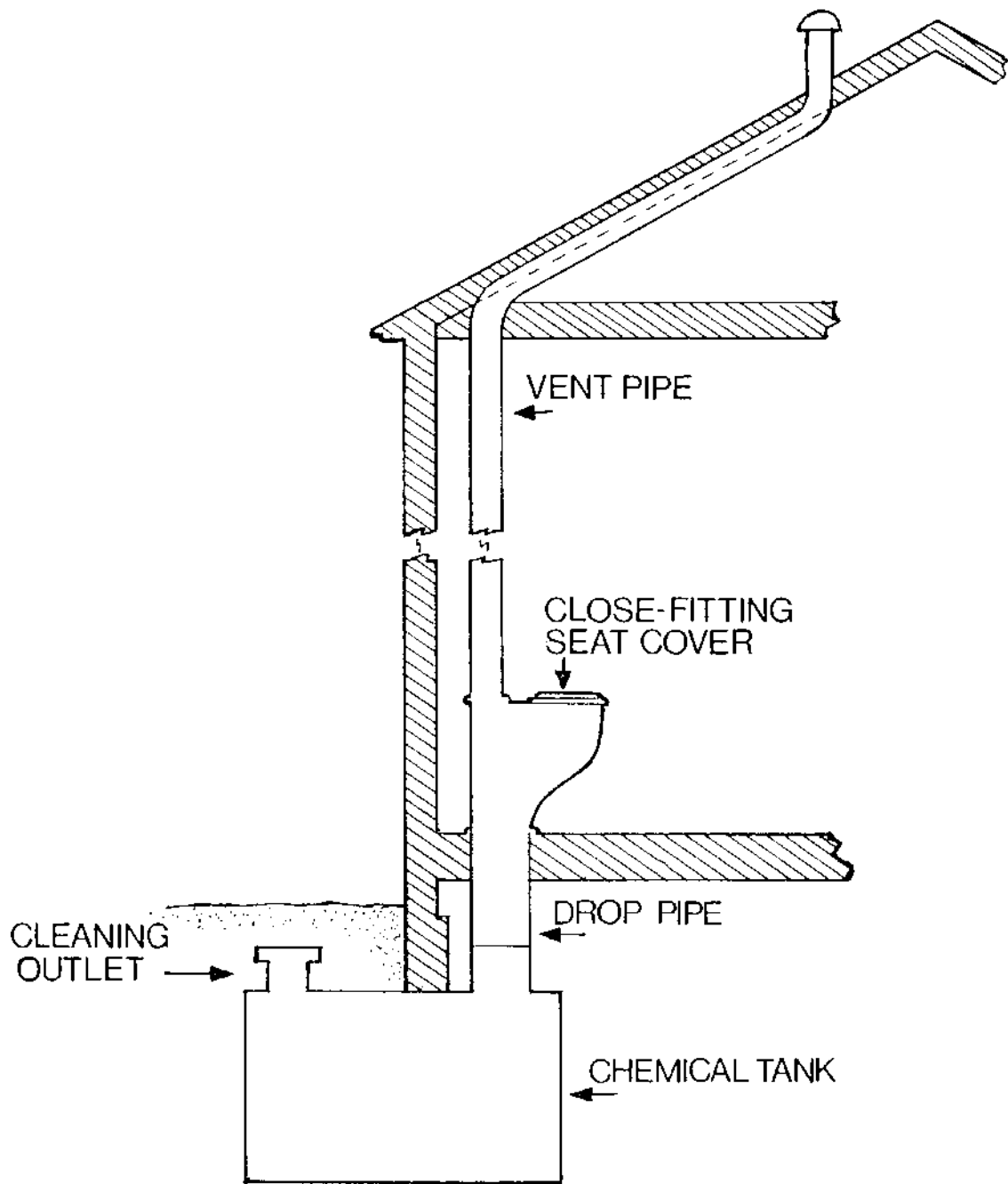
Killing bacteria present reduces the odours typical of the wash-room. To further the good work, many chemical charges also contain a perfume, and possibly

a blue or green dye to mask the yellow-brown colour imparted by nature. As an additional advantage, killing the bacteria means that a chemical toilet using either a caustic or a preservative may safely be located in the house. The whole situation begins to seem more like home.

If the chemical charge consists of only dye and perfume, and lacks either kind of bactericide, the improvement in appearance is deceptive. If a bactericide is not present, the bacteria are not killed; this kind of toilet is a pail privy with interior decoration. It is no more appropriate in the house than any other privy would be.

### B. Pro and Con

The chief disadvantage of the chemical toilet is that, like the pail and vault privies, it does not solve the problem; it merely gives you time to think about it. Using a chemical disinfectant is also a coin with two sides. The same chemical that so conveniently inhibits decomposition during use continues to inhibit it afterwards; and getting rid of the wastes, you recall, must ultimately take place through bacterial decomposition. For this reason, buried wastes are likely



**CHEMICAL TOILET  
— DROP TYPE**



to hang around far longer than one would wish, and wastes pumped into a septic tank are likely to stop the operation of the entire system. If you dump them into a lake, so as to dilute the preservative, you will succeed; the result is equivalent to using a chamber pot in the first place and emptying it overboard.

A solution which Environment officials will sometimes approve, especially where people are few and the high water table is low, is a cesspool. In crowded vacation spots, where the soil is thin and the water table high, you might as well build a privy on the end of your dock, for all the pollution a cesspool will spare your lake. (Perhaps it should be mentioned without delay that a privy on the end of dock is not an approved method of sewage disposal.)

The best solution to the problem may be to discharge the chemical wastes to a municipal sewage plant, provided the plant is big and the chemical toilets few. A big plant, with other contributions pouring in, can dilute the chemical mix to the equivalent of raw sewage and then treat it along with the rest. If too many people get the same idea, however, the chemicals could stop the bacterial action of the whole sewage works, with implications one might prefer not to pursue.

### C. Variations

**1. Bucket:** The most basic version of the chemical toilet is a simple bucket, nowadays often

fitted with a removable plastic liner, placed in a small, vented, metal cabinet in the bathroom. The approach is simple, and the unit is odourless when properly installed and operated. On the debit side, the contents of the bucket are open to view at all times, which is generally not very pleasing. Furthermore, when the bucket is more than half full, there is likely to be a splash on the user: the water is cold, the preservative may contain caustic, which burns, and the dye can stain clothing.

And then there is the problem of the full bags. They must be removed at the proper time, and their capacity is limited. If their owner gives a party, for instance, they may not last the evening. They must be taken to an approved dumping place, and they must be treated until arrival there with sufficient respect to prevent a puncture.

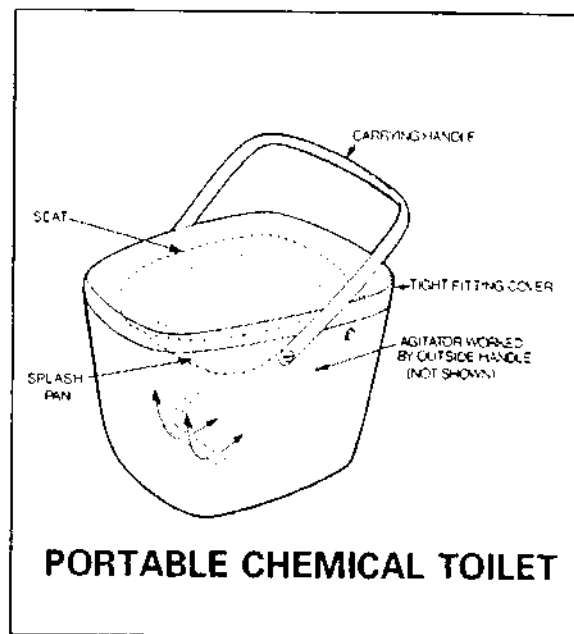
### **2. Improvements: Splash Pan and Drop Pipe:**

Other models of the chemical toilet offer various degrees of refinement to the basic concept. A splash pan is available, shaped like the bowl of the standard flush toilet, which prevents all but a rare splash on the user. To allow room for the splash pan, though, the bucket containing the charge becomes a small tank, the plastic bag is no longer used, and the contents of the tank must be drained at intervals to a suitable point of disposal. The installation is subject to all the local restrictions on holding tanks.

Another version locates the toilet over a tank buried in the ground beneath the house. The connection is usually made by a drop pipe, and the drop is usually sufficient to eliminate the need for a splash pan. The tank must be pumped out at suitable intervals, and the contents disposed of according to local custom.

**3. Recirculating:** The recirculating chemical toilet is much like the splash-pan toilet, except that it uses the contents of the tank to flush the bowl. The contents are liquified and dyed blue by the chemical charge, the construction quite eliminates splashing, and the unit is aesthetically much like the standard flush toilet (This is the familiar toilet of the airplane washroom). The need for a recirculating pump, however, increases the cost of this unit; it also limits its use to areas where electricity is available. The chief disadvantage of this model is that it cannot be used if the electricity fails or the pump breaks down.

**4. Portable:** A useful final variant on the chemical toilet is the portable model. This is much like the basic bucket model, though it may have a splash pan, and is fitted with a fairly tight lid and a carrying handle. It must be



carried with some care to avoid splashing or spilling. Its capacity is, of course, limited by the need for portability, and the usual requirement for safe disposal of the contents remains. These units may be drained into a standard toilet and flushed to municipal sewers, but not to a private septic tank.

Incidentally, while looking at portable toilets, consider weight and stability. By the time it's ready for emptying, the toilet may weigh 70 to 80 pounds; for many people, that's a lot to lift. Also, some models are tippy, and may need a frame for convenient use by children or older people.

## V. INCINERATING TOILETS

This unit consists of a toilet bowl above a small incinerating tank. In the tank, which may be heated by either gas or electricity, the wastes are burned to a dry, sterile ash which may be discarded with no special precautions.

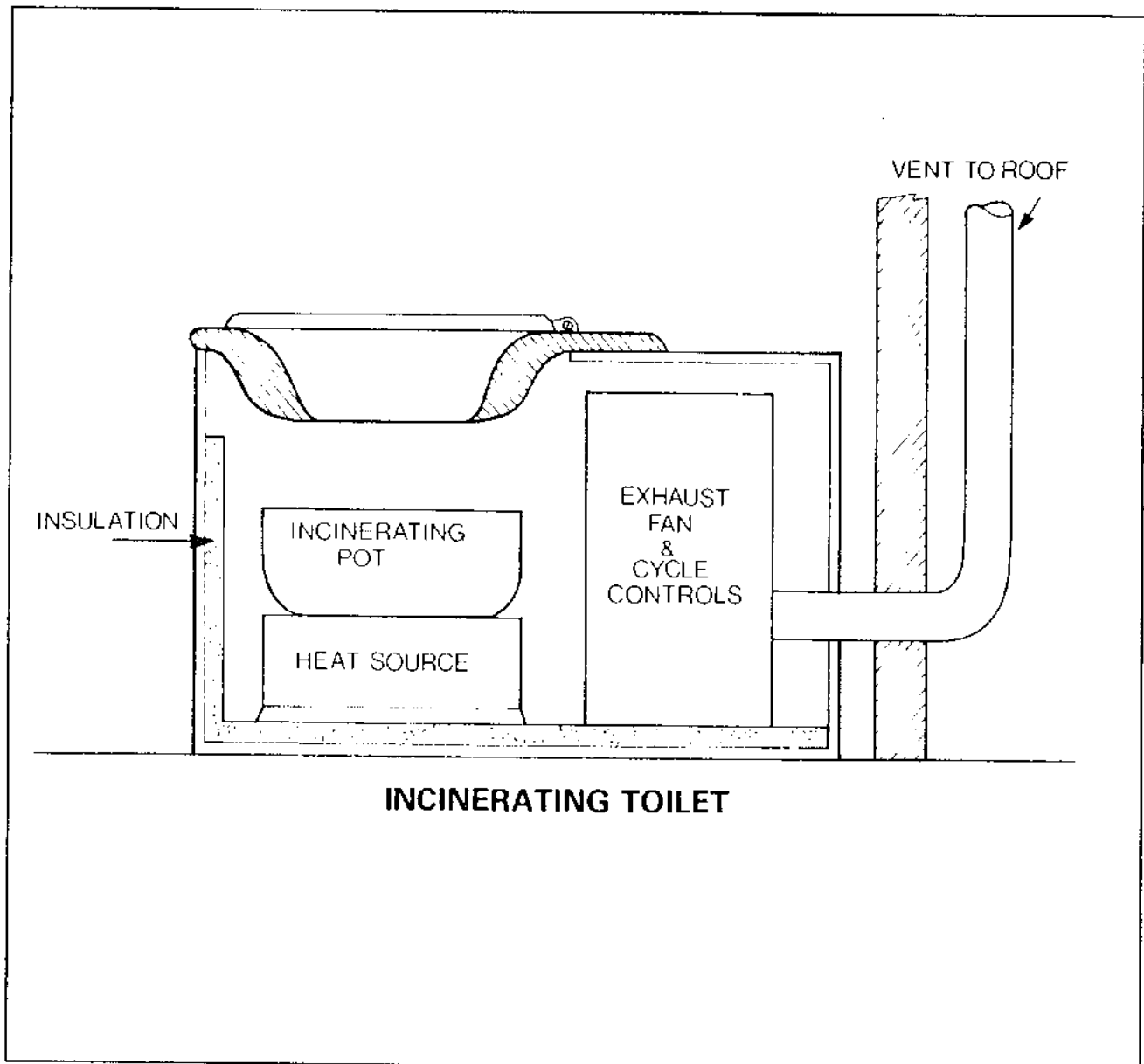
The toilet is thus a self-contained unit requiring no further equipment for disposing of the wastes committed to its keeping. Unfortunately, the approach, excellent in concept, may have certain drawbacks in practice. Consider some of these points as you compare models.

1. Toilet wastes are chiefly composed of water. Consequently, before they can be burned, they must be dried. The drying process is one of boiling; and this, as well as the actual burning, creates a notable stench. Good design, including high combustion temperatures, can give you an odourless gas, but these temperatures may not be reached in small, household units. If the neighbours complain, the unit can be closed
2. The toilet, naturally, grows hot during the incinerating cycle, and requires time to cool. In some models, the seat grows hot, too, and the cooling period may be as long as 40 minutes. The possible inconvenience of this delay is obvious, as is the peril of trying to reduce it.
3. Some models are designed so that the seat does not heat up during the combustion cycle, and the cycle itself can be interrupted at any time for further use, a far more practical arrangement. Too many interruptions, however, can lead to trouble, as the incinerating tank is usually small. If it is not emptied by a complete combustion cycle after two or three uses, it may overflow. The only remedy then is to spoon out the contents down to the "fire line" (saving

them, of course, for future cycles), and start over.

4. The incinerator unit, the necessary insulation, and the stack to lead combustion products away, all add up to an expensive installation. In addition, whether the incinerator uses propane gas or electricity, the operating costs can be high.

5. The high-salt liquid which develops during incineration tends to corrode valves and other moving parts. Further, though some models reduce the wastes to a light ash which can easily be vacuumed out or dumped, others have been known to reduce them to a clinker which can only be removed with a hammer.



## VI. COMPOSTING TOILETS

### A. Introduction

**1. What Composting Is:** A comparative newcomer to North America, the composting toilet has been available for some years in Scandinavia. Its principle is simple. Like the compost heap in the garden or the manure pile beside the barn, the composting toilet allows organic materials to decompose in the presence of air to an inoffensive material much esteemed as fertilizer.

The results differ significantly from what happens in the pit of a pit privy. The packed mass in a pit privy is airless except at its surface. Most of it must, therefore, decompose anaerobically, like the material in a septic tank. The products of anaerobic decomposition are such gases as hydrogen sulphide and methane. The former is the gas which gives the characteristic odour to eggs rotting anaerobically in their shells; the latter, "marsh gas", bubbles up from the bottom of stagnant lakes where dead plants rot.

A compost heap is kept loose by the grass cuttings, twigs, and leaves of which it is composed,

and its interior is always in contact with air. The same is true of a manure pile, where the straw of the animals' bedding keeps other residues from packing too closely. The result of this happy state of affairs is aerobic decomposition, which produces carbon dioxide and water vapour, both odourless. The difference between the two processes in nature is illustrated by the difference between leaf-mould on the well-aerated forest floor and swamp-muck.

The composting toilet attempts to introduce aerobic decomposition to the disposal of human wastes in reasonably pleasant circumstances. Different models achieve different degrees of success. These are described below.

Three topics are relevant to all composting toilets: the effect of temperature, the breeding of flies, and the safety of the final compost.

### **2. Low Temperature, Flies, and the Vegetable Garden**

**a Composting May Stop in Winter:** Like most microor-

ganisms, those which cause aerobic decomposition work best when they are comfortably warm. They slow down as they cool and become dormant at low temperatures. A composting tank kept outdoors or in an unheated basement cannot be expected to operate well in winter. The chilled bacteria wait for spring, and the tank serves primarily as a holding tank. If the winter is short and the summer is hot, and if your unit is sized to allow for these fluctuations, all may be well.

- b Flies Thrive in Compost:** The warmth and nutrients in composting manure make it ideal for raising fly larvae; similarly, flies prosper in the tank of a composting toilet.

The mild down-draft at the toilet and garbage chute may or may not be enough to contain the swelling population. A well-designed vent pipe comes complete with a fine-mesh fly-screen which will probably prevent these insects from entering the tank by this route, but there are other ways.

Because the well-being of the bacteria in the composting mass is so important, you cannot attack the flies with disinfectants or chloride of lime left over from your privy days. Fortunately, however, biodegradable insecticides are available from the manufacturers of some of the

composting toilets. When applied as directed (sparingly), these will kill both flies and larvae, without interfering with the essential bacteria.

- c Is Compost Safe?** As every gardener knows, compost made of dead leaves, lawn cuttings, twigs, and vegetable scraps supplies excellent natural enrichment when dug well into the soil. Manure and human wastes have long been used for the same purpose and in some places still are. Unfortunately, however, bacteria and viruses responsible for many serious human diseases pass out of the body with the faeces. Should these microorganisms enter another person's body, that person may fall gravely ill. One of the commonest modes of entry is through food prepared by unwashed hands, or on which a contaminated fly may have walked.

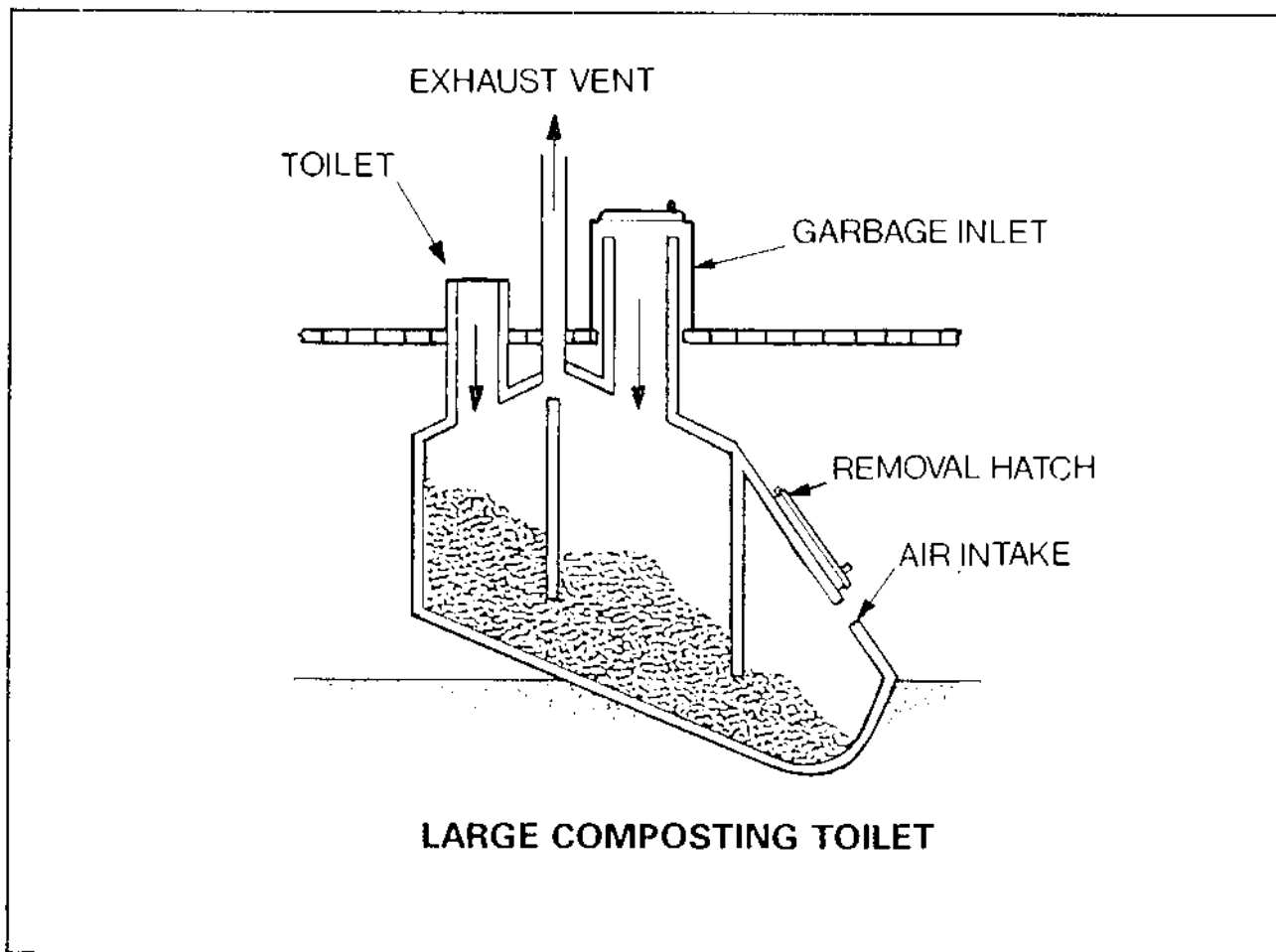
Most of the microorganisms which cause disease cannot live under conditions very different from those found in the human body. In a compost heap they will die from the lower temperatures, the drier conditions, and the competition of the natural (and harmless) bacteria of the soil. Compost which has spent enough time in a composting toilet will usually contain only the microorganisms commonly found in garden soil.

If the residence time was too short or if all was not well within the toilet, matters may be different. The makers of composting toilets generally recommend using the unit's product freely to nourish shrubs and flowers. They recommend it for vegetables, too, but suggest not bringing it directly into contact with that part of the vegetable which you intend to eat. Possibly you should use some other fertilizer around the roots of root vegetables or in the soil through which the leaves of salad vegetables must push their way before you pick them.

## B. Large and Small Units

Composting toilets can be divided into two major groups: large units and small ones. The first put the composting tank in the basement, because it is too big to fit in the bathroom. (Some of these tanks are, in fact, bigger than some bathrooms: one of them measures about seven or eight feet high by nine feet long by four feet wide.) In the smaller units, the toilet and a small compost box form a single unit, which can be installed readily in most bathrooms.

The large units are expensive: up to \$1,500 - 2,000 installed.



Small ones cost considerably less, about \$600 - 700 (in 1976).

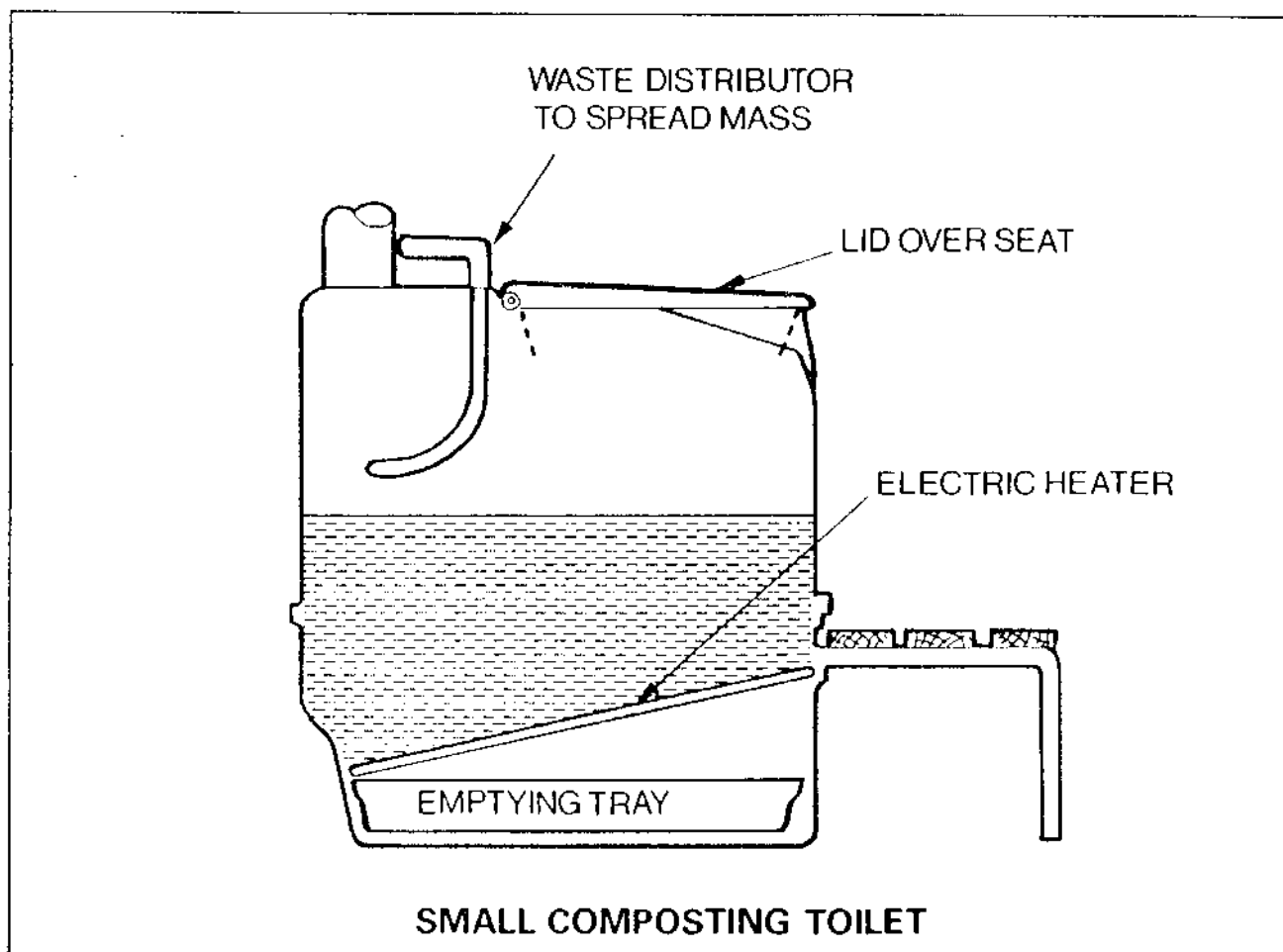
### 1. Large Units

a. **The Design Principles:** The toilet of a large unit is pleasantly indoors, in the bathroom of the house. It is connected by a drop pipe to the tank directly below, in the basement. If the house (or cottage) does not have a basement, particularly if the house is also built upon thin soil, you have a problem. Some units provide a screw-type conveyor to move the wastes from their point of deposition to a composting tank located outdoors, but this introduces a complex

piece of electrically driven machinery, and much of the simplicity of the concept is lost. The lower ambient temperatures outdoors may also affect the composting.

The drop pipe from the toilet has to have a large diameter to avoid fouling in use and must, therefore, pass through a large hole in the bathroom floor. But the distance from the toilet down to the tank's interior, which is not illuminated, essentially removes the contents of the tank from view.

Odour is eliminated, in principle, by an insulated vent pipe connecting the interior of the tank





with the out-of-doors. When all goes well, this vent is not merely a passive conduit, but a chimney. The composting material in the tank is warm, as are the water vapor and carbon dioxide rising from it. As warm air rises, the column of warm gases in the vent pipe flows out the top of the pipe.

This creates a partial vacuum within the composting tank. This partial vacuum draws replacement air into the tank from two sources: an air intake designed to flow air through the wastes and keep them aerobic, and the toilet seat when the lid is up. The slight downdraft through the toilet seat prevents odours from reaching the bathroom.

**b. The Problems:** So much for theory. With some units practice may be different. A unit which consists of a simple tank accepting only toilet wastes, for instance, resembles the pit of a privy. The packed wastes admit no air and eventually form a dry crust of aerobically decomposed material covering a liquid mass slowly decomposing anaerobically. The owner of such a tank is advised to stir the contents frequently, with a paddle of some sort. Not all owners will relish the task.

Some units attempt to overcome this unpleasantness by mounting the tank at a slight angle to the floor: 20° to 30° or

so. The wastes are supposed to slide slowly down the slope, composting as they go. They are supposed to reach the retrieval door at the bottom in a fit condition to be shoveled out without distressing the shoveler.

Of the units that fail, some permit the interior mass to slide too quickly, so that it reaches the exit while still too near its original state. Others that fail manage to hold back the mass by means of baffles but cannot prevent the somewhat muddy urine which drains from the mass from forming a puddle at the exit door.

**c. Garbage Disposal, Too?** The problem with the above units is aeration—or, rather, the lack of aeration. Toilet wastes alone, even if mixed with toilet paper, tend to pack so tightly that it is very difficult to pass air through the mass. To overcome this difficulty some units use special aerating pipes. Others follow more closely the principles of the compost heap by accepting some of the household garbage in addition to the toilet wastes. Such units will digest basically organic food scraps: meat scraps, bones, and grease, as well as vegetable scraps and parings.

They will also accept a fair amount of cellulose in some of its familiar household forms: paper towels, kleenex and toilet paper of course, sanitary nap-

kins and disposable diapers (minus the plastic part), and even floor sweepings and the contents of the vacuum cleaner bag.\*

Like the straw in the manure pile, this vegetable material prevents the mass in the compost tank from packing too closely to admit air. In addition, the paper and the compost, when true compost begins to form, are dryish and absorb the urine. The latter, retained in a warm, open medium through which air is flowing, soon evaporates. More precisely, the water content evaporates while the salt content remains behind as nitrogen compounds for the eventual benefit of the owner's garden.

**d. Orientation and Quiet Days:**

A unit which accepts the household garbage and other cellulosic materials along with the toilet wastes tends to work considerably better than one which accepts only toilet wastes, but nothing is perfect. To begin with, since garbage and toilet wastes have to enter the same subterranean tank, the kitchen and the bathroom have to be

adjacent — the house may have to be designed around the disposal unit. A large unit also takes a long time to reach its steady-state condition, in which the nearly full tank continuously accepts wastes and emits a continuous supply of compost. Filling the tank takes longer than one might expect, as nearly 90% of the original volume goes up the vent in the form of gases. For the first couple of years, while the tank is filling, there may be too little compost to hold back liquids until they evaporate. A few sacks of peat moss judiciously applied will help. Indeed, they may solve the problem; but the unit cannot be ignored during its first years.

Finally, the venting system may be vulnerable to hot weather. On a hot day, when the surrounding air is as warm as the air in the pipe, the column in the vent pipe will not rise and the odour of the uncomposted contents of the tank may seep throughout the house. A small exhaust fan greatly reduces the likelihood of this distressing occurrence. Purists will point out that installing a fan in a unit which prides itself upon avoiding all artificial contrivances makes the whole process less natural, but others may be willing to compromise.

**2. Small Units:** The smaller composting toilets consist essentially of a box with a comfortable seat on top. The size of the box varies but it will fit into most bathrooms. No hole in the floor is needed, but a two-inch to

---

\* NOTE: Ontario regulations permit the addition of small quantities of vegetable matter only to composting systems, specifically designed for the biological decomposition of such waste or that require small quantities of vegetable matter to improve the decomposition of human body waste. See also the excerpts from the revisions to Ontario Regulation 229/74 applicable to private sewage systems under Part VII of The Environmental Protection Act, 1971, reprinted in the Appendix.

four-inch vent-pipe must be led out-of-doors.

**a. No Longer Wholly Natural:** Composting depends on the activity of a multitude of microorganisms. It is not a chemical or mechanical process which can proceed at any speed convenient to the user. The little box of the smaller units demands some concessions to biology.

The first of these is that the smaller composting mass can no longer be left to find its own operating temperature. The contents of a small unit must be heated to tropical temperatures.

The heater is commonly a small, low-temperature electric resistance unit fitted at the bottom of the composting wastes. This makes the small composting toilet unsuitable for a cottage lacking electricity. In addition, a small fan in the vent pipe is also essential, both to draw air through the contents and to prevent odours from emerging when the lid over the seat is raised. The unit will not consume much power, but some it must have.

**b. Removing the Compost:** In due course, the matured compost must be removed from the toilet. This task should not be necessary more often than every six months to a year. In most units, the contents of the box rest above the heater. At the proper time, the owner, using some mechanical device sup-

plied with the unit, disturbs the bottom layers so that the material drops through the heater into a collecting bin, which can be removed and emptied. This chore should be neither unpleasant nor frequent in a unit operating as it should, but the nature of the mechanical device deserves some study before the unit is chosen. Does it seem sturdy? Is using it according to instructions likely to be a disagreeable task? Is the full bin likely to be heavy? Can the bin be removed easily and without conspicuous danger of spilling its contents?

**c. Achieving Aeration:** Because of their size, small units are designed to accept only toilet wastes. Here many of them encounter the same problem as their larger counterparts; the wet and close-packed wastes resist all efforts to draw air through them and set up their own unsavoury anaerobic system. If the urine can drain away or evaporate quickly, the solid residue can set into a firm block.

Several units come with an internal device for stirring (and thus aerating) the mass, usually operated by a handle projecting outside the unit. Unfortunately, the stirrers supplied tend to be no match for the dry mass. The handles may break off, and the interior parts may remain immovably imbedded. Since what they are imbedded in is not compost, this situation may not be very satisfactory.

The manufacturers of some units recommend adding some cellulose to keep the mass open enough to be aerated. Their units welcome toilet paper, kleenex, and vegetable scraps and trimmings, but not many: as small units they can spare only so much volume. And meat trimmings, cooking liquids, and grease are out. These act to dampen and compact the mass, rather than aerate it. In effect, the smaller composting toilets are toilets only. Some may accept and profit from the kitchen's vegetable scraps, but none can be used for complete garbage disposal.

**d. Design, Aesthetics, Flies, and Parties:** Most of the considerations affecting the purchase of a small composting toilet centre around the size of the composting box.

To begin with, the smaller the box, the more certain you may wish to be that complete composting will occur within a short time. Temperature and good aeration matter here.

To make the most of their small size, most small composting toilets reach their steady state when nearly full. Some manufacturers supply a distributor for evening matters out, lest the user's work rise to meet him. As a result, the contents do not rest in a dim void eight feet or so below the bathroom, but are offered prominently to view whenever the toilet lid is raised. One manufacturer suggests

sprucing things up when necessary by strewing a few handfuls of grass cuttings over the surface.

Small units, like large ones, can become infested with flies. These insects can be dealt with by the biodegradable insecticides recommended by the manufacturers.

Basic to the small size of the small units is the fact that they cannot cope readily with fluctuations in use — a party, for example. Solids introduced into the toilet remain on top of what they find; liquids seep into the mass. A little liquid in a full toilet evaporates fast. A lot of liquid may penetrate the mass completely and drip through the bottom into the collecting bin.

During a well attended celebration the collecting bin may fill and even overflow. The owner surprised by these consequences of social success can do little more than get out the mop.

### **C. Summary: Composting May Be Right For You**

The small composting toilet is not the only unsewered toilet unable to handle unexpectedly heavy loads. The bucket and chemical toilets are also sharply limited by their size, the incinerating toilet must empty itself regularly, and even a privy has only a limited capacity. A major advantage of the composting toilet — if it is working as intended — is that it reduces the volume of the wastes it receives

— in due time — to about a tenth of their original volume and delivers that final tenth in a form that is not disagreeable to handle (even literally). The cottage owner who is not a gardener can dispose of his compost by simply burying it, without concern over chemicals or excessive liquid content.

The main disadvantage to this type of toilet is that a biological system is not a mechanical contrivance and cannot be treated mechanically. A composting toilet works because a population of healthy microorganisms prospers under choice conditions of warmth and moisture. A householder concerned about his own comfort must be ever mindful of theirs.

An aeration unit is not a machine. It is a balanced ecological system, the home of living beings, which depend for their well-being and effective function on correct temperature, proper air flow, good mixing, and all the other variables which govern life and health. If one of these fails, the aerobic bacteria may die off. Their place may

then be taken by anaerobic bacteria, bacteria which function without air. The sewage then turns "septic", putrefies, and stinks. This sorry situation could result if the aeration unit were shut off: if the cottager wished to go home after the weekend, for instance, or the year-round occupant to take a holiday, or if the pump broke down in some idyllic spot far from the nearest spare-parts depot. These units are not approved unless the owner has a written servicing agreement, either with the manufacturer or with a person licensed by the Ministry of the Environment to service them.

Some aeration units, particularly where water is scarce, economize by using the aerated wastewater to flush the bowl. The principle is that of the recirculating chemical toilet, but the results differ. The flush-water is not a cheerful blue, but an unappealing natural brown, and it may not be odourless. Unless aeration has completed the job of decomposition, what recirculates is merely what went in, homogenized.

## VII. SOME OF THE OTHERS

### A. Septic Toilet

The septic toilet is a toilet seat above a buried tank. Wastes fall directly into this tank through a drop pipe, followed once a day by a pailful of water. Since the tank is always full, a pailful of wastes is displaced by the water and flows out of the tank into an adjacent leaching bed or cess-pool. This arrangement recalls the standard septic tank system, but there are some important differences.

1. The septic tank system disposes of all the household wastewater, while the septic toilet handles only toilet wastes.

2. The septic tank system is usually associated with a flush toilet and other standard bathroom fixtures. The septic toilet is a bucket privy with a drop pipe. The contents of the tank are in view; the inner wall of the drop pipe can become fouled and require cleaning; the bottom end of the drop pipe, if it reaches below the water surface in the tank, can become plugged with what floats; and the pipe itself is a first-rate conduit for odours.

In spite of this, the septic privy is a great improvement over the bucket toilet. Its leaching bed **does** ultimately dispose of the wastes; you don't have to take them somewhere else to get rid of them.

3. The leaching bed of a septic toilet is often very small compared with that of the septic tank system, because the volume of the wastes is smaller. The organic load from the toilet, however, is not changed by the design of the toilet or the volume of transport water. A relatively heavy organic load can clog the soil of the leaching bed, preventing effective operation. These leaching beds are subject to many of the same controls as those of septic tank systems. Ask the local Environment office before you dig.

### B. Low-Volume (Minimum-Flush) Toilets

In a sense, these systems are a half-way house between the septic toilet and the septic tank system. The toilet itself closely resembles the standard flush

toilet, except for the reduction in water use. Where the standard toilet typically requires three to four gallons per flush, the low-volume toilet uses an economical one to two quarts.

The fixed model is mounted over a buried septic tank, which drains in the usual way to a buried leaching bed. The toilet is connected to the tank by a drop pipe, which normally extends below the level of the septic tank liquid — so far, much like the septic toilet. To avoid odour, some models are designed with a water seal: a spring-loaded plate presses upward against a gasket and retains a portion of the clean flush-water after each use. A foot-pedal tilts the plate down after use, permitting wastes and flush-water to drop into the septic tank. As an additional advantage, in areas lacking pumped water, the unit can be flushed manually by pouring a quart or so of water into the bowl.

The disadvantages tend to centre around the seal. A bit of toilet paper can prevent the plate from seating properly, so that the water seal is lost, and with it the odour protection. Repeated use can distort the plate or gasket slightly, with the same result. And don't let your foot slip off the pedal controlling that spring-loaded plate. The plate has been known to snap back into place with such vigour that the contents hit the ceiling.

The leaching bed for the minimum-flush system, like that for the septic toilet, is often shorter than it should be for the organic loading. If the legal requirements point to a longer leaching bed, you may want to consider sizing it to take care of the rest of the wastewater, too. In effect, you might be well off to consider a standard septic tank system with a water-saving minimum-flush toilet. Check your soil and the local prices, as well as the local Environment requirements, before you decide.

### **C. Portable Low-Volume Toilets**

This convenient unit has a sealed top to prevent spilling or splashing while carrying. Otherwise, like the portable chemical toilet, it is a small tank surmounted by a seat.

A hand pump flushes the unit after use, and there is a water seal against odours. These units can be emptied into any fixed flush toilet, whether it is connected to sewers or to a septic tank: since no bactericidal chemicals are present, the contents will not affect the bacterial operation of the septic tank. Consider, however, the stability and the full weight of the unit. The absence of bactericidal chemicals also means that the contents may be a health hazard. Handle the unit like a privy pail, with care.

#### **D. Continuous Aeration Systems**

This waste-treatment method, usually an expensive one, features an aerated tank, and can accept all of the household wastewater, not just the toilet wastes. The system is in effect a small activated sludge plant, similar to the secondary treatment plant of many municipal sewage works: air, vigorously stirred or bubbled into the wastes, nourishes aerobic bacteria, which break down the complex organic compounds of the wastes into simpler, inoffensive ones. The products of their labour are a reasonably clear liquid and a sludge. The liquid is

usually discharged to a leaching bed or to a watercourse — both alternatives require approvals — while the sludge, like the sludge from a septic tank, must be pumped out periodically and disposed of as the law permits.

Though an effective treatment method, an aeration plant is usually better suited to towns or small communities than to individual use. For one thing, such a unit needs electricity to run the aeration pump; but even where electricity is available, operating the plant can offer the novice disagreeable surprises.

For the reader's convenience in comparing the toilet systems described in this booklet, the position of the toilet in relation to other structures is listed in Tables 4 and 5, as shown in the regulations.



## APPENDIX I

### EXTRACT FROM THE REGULATION TO AMEND ONTARIO REGULATION 229/74 MADE UNDER THE ENVIRONMENTAL PROTECTION ACT, 1971

1. Clause a of section 2 of Ontario Regulation 229/74 is revoked and the following substituted therefor:

- (a) Class 1— a chemical toilet, an incinerating toilet, a recirculating toilet and all forms of privy including an earth pit privy, a pail privy, a privy vault and a composting toilet system;

2. Section 7 of the said Regulation, as amended by section 2 of Ontario Regulation 944/74 and section 1 of Ontario Regulation 956/75, is revoked and the following substituted therefor:

7.- (1) The following are prescribed as standards for the construction of any tank used in a sewage system for collecting, holding or storing sewage, whether or not it is part of a Class 5 sewage system, or used for treating sewage:

- (a) the tank shall be constructed of concrete, steel, fibreglass, reinforced plastic or such other material as may be approved by the Minister;
- (b) the tank installed, assembled or constructed shall,
- (i) be carefully made, exhibit craftsmanship and true quality, be sound, durable and thoroughly capable of satisfactory and troublefree service,
- (ii) have such wall thickness, reinforcing and strength as is necessary to meet the requirements of use in service and any stresses to which it may be subjected prior to or during installation, and
- (iii) be of watertight construction;

- (c) materials used in the construction of the tank shall be in conformance with the standards prescribed in this Regulation and where no such standard is prescribed, shall meet the appropriate industry standards and codes applicable to such materials;
- (d) a prefabricated tank, including, subject to subclause i of class i, multiple piece units assembled on site, shall conform to the requirements of Canadian Standards Association Standard B66 except as otherwise prescribed herein;
- (e) only those provisions of Canadian Standards Association Standard B66 and this section relating to material standards, access, workmanship and construction methods and practices apply to a tank other than a septic tank in a Class 4 sewage system or a holding tank in a Class 5 sewage system;
- (f) the tank shall be constructed or installed on site according to good construction practice or, where specified, the manufacturer's recommendations, and in a manner that will ensure against,
  - (i) subsequent settlement of the tank or subsequent uplift due to groundwater pressure, that will be disruptive to the sewage system of which the tank is a part,
  - (ii) damage to the tank or any protective coating during handling and back-filling, and
  - (iii) damage to the tank due to weather or frost;
- (g) a prefabricated septic or holding tank shall be constructed so as to meet the requirements for certification by either the Canadian Standards Association or Underwriters' Laboratories of Canada and shall bear the certification mark of either the Canadian Standards Association or Underwriters' Laboratories of Canada and the marking required on a

tank by Canadian Standards Association Standard B66, on the upper surface of the tank at such location that it can be seen after installation is complete by exposing the manhole access that is nearest to the inlet pipe;

- (h) a tank constructed on site of concrete shall be poured-in-place and shall,
  - (i) comply with the requirements of Canadian Standards Association Standard A23.1.
  - (ii) have a balanced design of steel reinforcing sufficient to meet the requirements of clause **b**.
  - (iii) have bar or wire reinforcement in accordance with the requirements of Canadian Standards Association Standard A23.3,
  - (iv) conform to the general requirements appearing in clause 3 of Canadian Standards Association Standard B66 except as otherwise provided herein,
  - (v) have top and bottom slabs of a thickness of at least ten centimetres in the case of a tank having a capacity of 9,000 litres or less and at least fifteen centimetres for a tank having a capacity in excess of 9,000 litres,
  - (vi) have sides and ends with a thickness of at least fifteen centimetres in the case of a tank having a capacity of 27,000 litres or less and at least twenty centimetres for a tank having a capacity in excess of 27,000 litres, and
  - (vii) have an inlet and outlet of such size as required to accommodate the sewage flows;
- (i) a steel tank shall not be,
  - (i) constructed or assembled on site,
  - (ii) coated on the outside with coating method "B" described in clause 4.1.7.1 of Canadian Standards Association Standard B66, or

(iii) coated on the inside with coating method "B" described in Canadian Standards Association Standard B66 if the metal is thinner than 10 gauge.

(2) Subsection 1, except clause **g**, comes into force on the 31st day of December, 1976.

(3) Clause **g** of subsection 1 comes into force on the 1st day of July, 1977.

3. Section 15 of the said Regulation is revoked and the following substituted therefor:

15. The following are prescribed as standards for the operation of a Class 1 sewage system:

(a) subject to clause **b**, a Class 1 sewage system shall receive or be used only for the disposal of human body waste; and

(b) a Class 1 sewage system that has been specifically designed for the biological decomposition of non-waterborne biodegradable kitchen wastes, or that requires the addition of small quantities of vegetable matter to improve the decomposition of human body waste, may receive such wastes in addition to human body waste.

4. Section 19 of the said Regulation is revoked and the following substituted therefor:

19. A sewage system of a type set out in Column 1 of Table 5 shall be located so that no part thereof is closer to an item described in the heading of Column 2, Column 3 or Column 4 of Table 5, than the horizontal distance set opposite the name of such type of sewage system in such column.

**TABLE 4**

Column 1	Column 2
Spring or well other than a well referred to in the next item	100 feet
Well with watertight casing to a depth of 20 feet	50 feet
Building or structure where the bottom of the distribution pipe is below the level of the lowest floor in the building or structure	10 feet
Building or structure where the bottom of the distribution pipe is on the same level or above the level of the lowest floor in the building or structure	25 feet
Property boundary	10 feet
Lake, river, pond, spring, stream, reservoir	50 feet


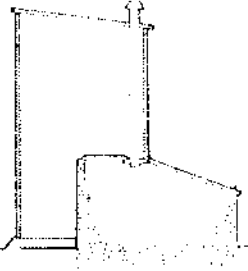

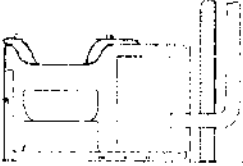
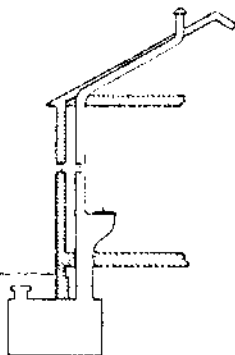
**TABLE 5**

Column 1	Column 2	Column 3	Column 4
	Well with watertight casing to a depth of 20 feet	Spring or well other than a well with watertight casing to a depth of 20 feet	Lake, river, pond, stream, reservoir
Pit Privy	50 feet	100 feet	50 feet
Privy Vault Pail Privy	25 feet	50 feet	25 feet
Cesspool	100 feet	200 feet	50 feet
Leaching Pit	25 feet	50 feet	50 feet

## CLASS 1 SEWAGE DISPOSAL SYSTEMS

Class 1 systems are used only for the disposal of human body wastes and provision must be made to dispose of waste water to a separate sewage system. The conditions under which Class 1 systems are usually permitted are:

- 1) Where the installation of a standard septic tank and tile bed is not possible due to lot conditions
- 2) Where provision is made for the adequate disposal of the waste water to a completely separate system. Class 1 systems are not usually permitted if a premises is served by a pressure water system, as seepage pits usually can not adequately handle large flows.

FACILITY	SUITABILITY	LOCATION	CONSTRUCTION	MAINTENANCE
<p>Earth or Pit Privy</p> 	<p>Where soil available and ground water not encountered. Bottom of pit should be 3' above water table, rock or impermeable soil.</p>	<p>Minimum distances: 50' from cased well 100' from dug well 50' from river, stream, lake, pond, etc. Should be located downgrade from well.</p>	<p>Deep pit, insect and rodent proof. Earth mounted to prevent infiltration of surface water. Pit ventilated.</p>	<p>Good housekeeping required. Natural decomposition of waste should be relatively odourless.</p>
<p>Vault Privy</p> 	<p>Where adequate soil not available for pit privy and protection of ground water is required.</p>	<p>Minimum distances: 25' from cased well 50' from dug well 25' from river, stream, lake, pond, etc. Should be located downgrade from well.</p>	<p>Watertight concrete vault. Flytight building. Ventilated vault and building. 6 cu. ft./person/year.</p>	<p>Keep clean, flytight. Clean pit when contents approach within 18" of door. Disposal of contents to a Class 3 or 7 system.</p>
<p>Removable Pail Privy</p> 	<p>A temporary facility to protect water supply. Where pit privy is impractical.</p>	<p>Minimum distances as per vault privy.</p>	<p>As per vault privy. Provide easily-cleaned pails.</p>	<p>Provide regular collection service and cleaning facilities, including hot water, long-handled brushes, detergent, drained concrete floor. Disposal of contents to Class 3 or 7 system.</p>
<p>Incinerating Toilets &amp; Composting Toilets</p> 	<p>To protect ground water and surface water supplies.</p>	<p>Indoors or adjoining main residence. Should not be used in close proximity to neighbours.</p>	<p>Unit requires a power source. Incinerating toilets also have a cycle time during which it can not be used.</p>	<p>Incinerated ash or dry compost may be disposed of easily, on garden, or buried.</p>
<p>Chemical Toilet</p> 	<p>To protect underground and surface water supplies.</p>	<p>Indoors or adjoining main residence.</p>	<p>As for masonry vault privy. Tank may be heavy gauge metal with protective coating. Capacity 125-250 gallons.</p>	<p>Use 1/4 lb. lye for each cu. ft. of vault capacity. Made up to 6" liquid depth in vault or 25 lbs. caustic soda per seat in 15 gal. water. Maintain chemical solution proper strength to keep odours down and agitate after each use. Clean vault when 2/3 - 3/4 full. Avoid splashing as solution causes burns.</p>

Further information on the installation of toilets, their siting on the lot, the condition of the soil and other details are available from the following regional and district offices of the Ontario Ministry of the Environment:

**NORTHWESTERN REGION:**

**Thunder Bay Regional Office,**

435 James St. S.,  
Thunder Bay, P7C 5G6  
Tel.: 475-1205

**Kenora District Office,**

808 Robertson St.,  
Kenora, P9N 1X9  
Tel.: 468-5578

**NORTHEASTERN REGION**

**Sudbury Regional Office,**

469 Bouchard St., Regency Mall,  
Sudbury, P3E 2K8  
Tel.: 522-8282

**Timmins District Office,**

83 Algonquin Blvd. W.,  
Timmins, P4N 2R4  
Tel.: 264-9474

**Sault Ste Marie District Office,**

445 Albert St. E.,  
Sault Ste. Marie, P6A 2J9  
Tel.: 949-4640

**North Bay District Office,**

1500 Fisher St., Northgate Plaza,  
North Bay, P1B 2H3  
Tel.: 476-1001

**Parry Sound District Office,**

74 Church St.  
Parry Sound, P2A 1Z1  
Tel.: 746-2139

**SOUTHWESTERN REGION**

**London Regional Office,**

985 Adelaide St. South,  
London, N6E 1V3  
Tel.: 681-3600

**Windsor District Office,**

250 Windsor Ave., 6th Floor,  
Windsor, N9A 6V9  
Tel.: 254-5129

**Sarnia District Office,**

242 A Indian Rd. South,  
Suite 209 S.,  
Sarnia, N7T 3W4  
Tel.: 336-4030

**Owen Sound District Office,**

220-11th St. West, Suite 108,  
Owen Sound, N4K 1T9  
Tel.: 371-2901

**Chatham Sub-District Office,**

435 Grand Ave., W.,  
Chatham, N7L 3Z4  
Tel.: 352-5107

**WEST CENTRAL REGION**

**Hamilton Regional Office,**

140 Centennial Parkway N.,  
Stoney Creek, L8E 3H2  
Tel.: 561-7410

**Cambridge District Office,**

400 Clyde Rd.,  
Cambridge, N1R 5W6  
Tel.: 623-2080

**Welland District Office,**

637-641 Niagara St. N.,  
Welland, L3C 1L9  
Tel.: 735-0431

**CENTRAL REGION**

Suite 700, 150 Ferrand Dr.,  
Don Mills, M3C 3C3  
Tel.: 424-3000



**Barrie District Office,**  
12 Fairview Rd.,  
Barrie, L4N 4P3  
Tel.: 726-1730

**Muskoka-Haliburton  
District Office,**  
Gravenhurst, P0C 1G0  
Tel.: 687-3408

**Peterborough District,**  
139 George St., N.,  
Peterborough, K9J 3G6  
Tel.: 743-2972

**Halton-Peel District Office,**  
125 Cross Ave.,  
Oakville, L6J 2W8  
Tel.: 844-5757

**Huntsville Sub-Office,**  
100 Main St. E.,  
Huntsville, P0A 1K0  
Tel.: 798-2386

**Southeastern Region,**  
133 Dalton St.,  
Kingston, K7L 4X6  
Tel.: 549-4000

**Ottawa District Office,**  
2378 Holly Lane,  
Ottawa, K1V 7P1  
Tel.: 521-3450

**Cornwall District Office,**  
4 Montreal Road, 2nd Floor,  
Cornwall, K6H 1B1  
Tel.: 933-7402

**Belleville District Office,**  
15 Victoria Ave.,  
Belleville, K8N 1Z5  
Tel.: 962-9208

**Pembroke District Office,**  
1000 MacKay St.,  
Pembroke, K8A 6X1  
Tel.: 732-3643

# Embedded Secure Document

The file *file:///E:/PROPHECYKEEPERS/data/POST-NUCLEAR-WAR/a\_reconstruction/immediate/basic\_rescue\_skills.pdf* is a secure document that has been embedded in this document. Double click the pushpin to view.



## Death

Associated with large disasters and catastrophes there is often the problem of disposal of large numbers of corpses and dismembered body parts. While it might seem a benefit to have the assistance of those experienced in mortician services their skills may be largely inapplicable to a holocaust situation. Indeed, even disaster specialists will find new challenges perhaps not to be found in other disasters.

The niceties of mortuary services in embalming, funerary practices and such will have to be dispensed with. While for ethical/religious reasons some may be inclined towards either burial or incineration the exigencies of the time may dictate the actual methods used.

In certain areas the disposal of human bodies may pale in the face of need for disposal of large herds of cattle and/or other livestock. In past disasters where resources were available, perhaps from elsewhere, and there was large heavy machinery, and fuel to operate it, then a solution was in using bulldozers and backhoes to dig pits and move the carcasses. This may be difficult to achieve.

The burning of carcasses may be even more problematical, given the demand for fuel and facilities, but the best guidelines that I have found so far are in state instructions for animal disposal. Here is one example:

### [Dead Animal Disposal](#)

Nuclear war would add an additional catastrophic challenge to body disposal in that while it is desirable to dispose of dead bodies as quickly as possible, ideally within 72 hours maximum even in cooler climates, the circumstances of radioactive fallout may not permit initial attention to the problem for two or three weeks and then the immensity of the problem may require many weeks or even months to complete.

This is a task that will require the dedication of such resources and personnel as are available and necessary. Because of the very serious health threat in handling aging corpses particular concern will need to be paid to selecting and supporting the required personnel. Even after the task is completed, the personnel involved may need to be isolated and quarantined from the rest of the population - perhaps for some substantial period of time. (A minimum of six weeks is usually recommended - while in the past some authorities have recommended 6 months where graves were being moved where the cadavers had been exposed to things like the plague).

Inoculation of the personnel involved would be a nicety if available, however, other matters of hygiene need to be rigidly observed. Special garments resistant to contaminations (rubberized would be excellent) - along with good regular cleaning and decontamination of those garments. Use of gloves and masks.

Good shower facilities with scrub brushes that are used after each shift. Special diet and not overly exhaustive shifts so as to not weaken the physical stamina of the personnel as that would weaken their immune systems.

Particular attention needs to be given to air masks - both for reduction of the stench involved and to reduce the inhalation of contaminants. Personnel should rapidly gain some expertise in learning to work from an upwind position as much as possible and in using tools and equipment to handle the remains without having to touch them directly.

Here are two pamphlets as how to make air masks:

### [How To Make A Fumigating Mask](#)

This 847 KB 3 page pamphlet explains making a simple mask.

### [How To Make An Emergency Gas Mask.pdf](#)

This 0898 KB 3 page pamphlet explains how to make an emergency gas mask.

Below, I am making available a test case that may somewhat demonstrate the expected severity of the problem. This was the 2001 FMD (Foot and Mouth Disease) epidemic in Britain, during the peak of which there were slaughtered a half million animals *each* week for several weeks. One must remember that this was but a fraction of the animal population and did not include many types.

The other deficiency in this model is that there was a healthy human population with extensive mechanical and energy resources to handle the disposal. The numbers of personnel during the peak weeks numbered about 1500 veterinary personnel and 2000 military personnel for a total of 3500 total personnel. Consider this in relation to holocaust situation where there may be about 20% of the population left to bury 80% of the human population and almost 100% of the animal population.

Even the poultry population presently out numbers the human population about three to one. The catastrophe may be of such a nature that there may be large segments with no remains left to bury but, nevertheless, without extensive resources of machinery and fuel, it is going to be a daunting initial task.

The following article discusses a number of critical issues such as transportation, decontamination, the used of burning pyres, land fills and burial pits and concerns about water table contamination. Because large cows are the most difficult common carcass requiring disposal - the principles involved here, by extension, have the broadest overall application.

### [Animal Disposal During an Epidemic](#)

Here is another thought. Those animals that are not killed - may try to kill us. You may wish to consider the following:

[What will you do with the dogs?](#)

**MENU: [HOME](#) » [Reconstruction](#) » [Recovery](#) » [Renewal](#) » [Survival](#)**

---

---

# DEAD ANIMAL DISPOSAL

[General Overview](#)

[Composting](#)

[Incineration](#)

[Burial](#)

[Rendering](#)

[Alternative Methods](#)

The Board of Animal Health investigates complaints from the public concerning the disposal of dead livestock. Agricultural Regulatory Specialists visit the premises to ensure disposal of carcasses complies with Board of Animal Health rules.

## ***BEST MANAGEMENT PRACTICES - CARCASS DISPOSAL***

**GENERAL OVERVIEW:** There are always losses (mortality) in animal production.

**Proper disposal of carcasses is important both to prevent livestock disease transmission, and to protect air and water quality. This document provides options for disposal with associated advantages, disadvantages and rule requirements.**

**Carcass Disposal is Regulated by: \***

**Minnesota Statutes 35.82****Minnesota Board of Animal Health Rules - 1719.0100 - 1719.4600****Minnesota Pollution Control Agency Rules****Minnesota Department of Natural Resources Rules**

**\* These are summarized in the following Best Management Practices.**

**LEGAL METHODS OF DISPOSAL (As of January 1996)**

SPECIES	METHOD						
	BURY	INCINERATE	RENDER	COMPOST	EXEMPT BY LAW	FUR FARM CONSUMPTION	PET FOOD
<b>Poultry</b>	○	○	○	○		○	○
<b>Swine</b>	○	○	○	○		○	○
<b>Cattle</b>	○	○	○			○	○
<b>Horses</b>	○	○	○			○	○

<b>Sheep/goats</b>	○	○	○*	○			○
<b>Household Pets</b>					○		
<b>Wild Anim.</b>					○		
<b>Game Farm/ Exotic Animals</b>	○	○	○				

**\* Allowed by Law, but at this time Minnesota renderers will not process sheep or goats.**

**Definition of Carcass: The body or a part of a domestic animal or fowl that has died or has been killed otherwise than by being slaughtered for human or animal consumption.**

**Definition of Discarded Animal Parts: All or a part of animals, fish, or poultry that have been killed for human or animal consumption and not used for that purpose.**

**GENERAL RULE SUMMARY:**



- 1. Carcass must be disposed of as soon as reasonably possible, ie; within 48-72 hours.**
- 2. Burying a carcass requires that the carcass be 5 feet above the high water level and covered with 3 feet of dirt. Sandy or gravelly areas or areas within 10 feet of bedrock should be avoided.**
- 3. Incineration must be in an incinerator that is approved by the Minnesota Pollution Control Agency.**
- 4. Hauling over the road. Carcasses or discarded animal parts must be in vehicles or containers that are leakproof and covered. The vehicles also need to be inspected and have a permit, unless the vehicle belongs to the owner of the animal before it died.**
- 5. Composting must use the protocol set forth in Board rules. These are explained on the page about composting.**
- 6. Fur farms need a permit and inspected vehicle to haul carcasses or discarded animal parts over the road.**
- 7. Each carcass used as pet food must pass an inspection by a veterinarian and must be processed under clean and sanitary conditions.**
- 8. Carcasses left at an off-site pickup point must be in an animal-proof enclosed area that is at least 200 yards from a neighbor's buildings. Carcasses must be picked up within 72 hours, except if the enclosed area is refrigerated to less than 45E F, the carcasses must be picked up within 7 days.**

[Top of Page](#)

# ***BEST MANAGEMENT PRACTICES - CARCASS DISPOSAL***

## **COMPOSTING**

Composting is the process of placing carcasses in layers with a carbon source and manure to allow the natural heating process to break down the carcass and reduce its mass. As of January, 1996, composting is allowed for swine, sheep, goats and poultry.

### **ADVANTAGES**

+ Biosecurity.

+ Year-round use.

+ Inexpensive

+ Environmentally sound.

+ Value - added product to

sell or  
us

+ Best and recommended

Method to handle  
catastrophic

losses.

+ Heat of composting process

kills pathogens and insect larvae.

#### DISADVANTAGES

+ May be more labor intensive.

+ Requires impervious pad,

rot resistant walls and cover

to repel rain.

+ Takes some practice to

develop the "art".

+ Requires carbon source

(straw, sawdust, cornstalks, etc)

#### RECOMMENDATIONS.

—

! Composting is an "art" that must be practiced because of the variety in materials, weather conditions and number of carcasses. It is best to have the same person doing the composting to consistently read the pile.

DO:

+ Follow protocol as specified in Board of Animal Health rules.

- Process mortality daily.

- Keep carcasses covered and at least 6" from sides.

- Take and record temperature daily (must reach 130E F).

- Start with a base of carbon source material.

- Put carcasses, litter and carbon source in layers.

- Mix pile at least 1 time when the temperature starts to decline; this will generate a new heat cycle after each mixing.

DON'T:

+ Use frozen carcasses for composting.

+ Store carcasses before processing.

## PUBLIC RELATIONS.

Build composter out of sight and away from neighbors. While a compost pile that is working right will have no smell and no insects, it may bother neighbors to see carcasses going into it on a daily basis. Convince your neighbors to use the finished compost for their gardens (before you tell them what is in it).

[Top of page](#)

# ***BEST MANAGEMENT PRACTICES - CARCASS DISPOSAL***

## **I N C I N E R A T I O N**

Incineration is an effective but more costly method, working well as a cold weather alternative.

### ADVANTAGES

- + Can use year-round.
- + Biosecurity (No trucks coming from other farms to pick up

carcasses).

## DISADVANTAGES

- + Incinerator cost.\_
- + Fuel cost - expensive.
- + Odor.\_
- + Very expensive for larger size carcasses.\_

—

## RECOMMENDATIONS.

! Place your incinerator out of sight or enclosed with a decorative screen

.

! Consider the wind direction and time of the day, so as to least effect your neighbors.

### DO:

- + Purchase MPCA Approved incinerator.
- + Purchase unit large enough to handle each day's mortality.

- + Properly maintain unit.
- + Incinerate mortality daily.

**DON'T:**

- + Accumulate carcasses for days before incinerating.
- + Incinerate when down wind neighbor is having a barbecue, etc.
- + Forget to pay your gas bill.

**PUBLIC RELATIONS.**

Most problems from incineration come from the odor of burning hair or feathers that interferes with a neighbor's outdoor activities.

[Top of page](#)

***BEST MANAGEMENT PRACTICES - CARCASS  
DISPOSAL***

# BURIAL

Burial requires great care in site selection because as carcasses decompose, they release materials that can pollute ground water, particularly if large volumes are buried. This practice is most suitable for small amounts of material (e.g. less than 2000 lb./burial pit/acre).

## ADVANTAGES

+ Inexpensive (if own equipment).

+ Biosecurity (No trucks coming

from other farms to pick up carcasses).

## DISADVANTAGES

+ Difficult in winter.\_

+ Can cause groundwater pollution.\_



- + Cannot bury where water table is within 10' of surface.

RECOMMENDATIONS:

! Should not be used by large facilities or with catastrophic losses because the volume of carcasses may lead to groundwater pollution.

! Examine other alternatives for dead livestock disposal.

**DO:**

- + Cover with three feet of dirt and stay five feet above the water table.
- + Cover each day's deposits with a layer of dirt.
- + Identify sites for worker safety.
- + Bury immediately.

**DO NOT:**

## DON'T:

- + Place in or near lakes, ponds, rivers, streams, wetlands, ditches or wells.
- + Use as a dump for other farm garbage.
- + Bury in areas with a high seasonal water table.
- + Bury in "karst" or sandy areas.
- + Bury in areas subject to surface water flooding.

## PUBLIC RELATIONS.

Problems arise when using burial pits and from burying a carcass too near to a neighbor's well. The neighbors complain about burial pits when any smell comes from the farm; they assume it is from the pit or when carcasses are not properly covered each day and dogs or wild animals drag off parts of the carcasses.

[Top of page](#)

***BEST MANAGEMENT PRACTICES - CARCASS DISPOSAL***

# R E N D E R I N G

Rendering offers the grower the chance to create a recyclable feed product if it is submitted to the renderer with proper handling.

## ADVANTAGES

- + Recyclable resources
- + Can use year-round.

## DISADVANTAGES

- 
- + Lack of biosecurity with pickup of carcasses.\_
- + Cost.\_
- + Not available in all areas.\_
- + Not available for all species.\_
-

## RECOMMENDATIONS.

! Get on an annual contract with the renderer rather than a "per call" charge.

! If large enough farm, get on a scheduled weekly or twice weekly pick-up route.

! Use "off-site" pickup points for biosecurity purposes.

! Consider refrigerated "off-site" pickup points.

### DO:

+ Know what substances the animals were exposed to, to avoid residue problems in the rendered product.

+ Follow Board of Animal Health Rules for "off-site pickup point".

- Must be animal-proof enclosure at least 200 yards from neighbor's buildings.

- Carcasses may not be left for more than 72 hrs. unless refrigerated -

then 7 days.

- + Be aware of potential disease spread from a rendering truck.
- + Vehicles or containers must be leakproof and covered to haul carcasses over the road. (Contracted vehicles also need a permit from the Board of Animal Health.)

**DON'T:**

- + Delay calling for carcass pickup.
- + Leave carcasses where other animals can drag them off.

- + Leave carcasses in public view.

PUBLIC RELATIONS.

—  
What upsets neighbors the most are carcasses left where other animals can drag them into their yards or where the carcasses can be seen from the road. "Off-site" pickup points are required to be animal-proof enclosures.

[Top of page](#)

**BEST MANAGEMENT PRACTICES - CARCASS**

# DISPOSAL

## ALTERNATIVE METHODS

The Board of Animal Health may permit alternative methods of carcass disposal that are effective for the protection of public health and the control of livestock diseases.

**ALL ALTERNATIVE METHODS REQUIRE A PERMIT FROM  
THE BOARD OF ANIMAL HEALTH.**

**(651) 296-2942**

### SOME ALTERNATIVE METHODS:

#### 1. PET FOOD PROCESSING

- Requires permit, veterinary inspection of each carcass, facilities and equipment that meet Board of Animal Health specifications.

## 2. FUR FARM CONSUMPTION.

- Fur farm is required to have a permit and to keep the farm in a sanitary condition.
- Permits allow only the feeding to fur bearing animals that do not re-enter the food chain.
- Owner assumes the risk of a disease or condition in the carcass that could be detrimental to the fur animals.

## 3. GRINDING AND INJECTING INTO THE MANURE PIT

- A permit was granted to the University of Minnesota for an experimental project.
- Field trials are being conducted in 1996.
- A disadvantage may be neighbors' perception that the smell from the manure pit is worse because of the carcasses in it.

## 4. LACTIC FERMENTATION.

Lactic fermentation utilizes a mixture of ground carcasses and a carbohydrate source to produce a "silage" type product for refeeding.

## 5. EXTRUSION.

Extrusion is a method whereby ground carcasses and a carrier such as soybean meal are cooked under pressure and moisture, generating steam and a product with 12% moisture for refeeding.

## 6. EMERGENCY, COMMERCIAL OR EXPERIMENTAL COMPOSTING.

- In emergency or catastrophic loss - call the Board of Animal Health for a permit and advice on composting the losses.
- Experimental composting must be in conjunction with a University and requires a permit.
- Cattle and other species may be experimentally composted if the protocol is approved.

## REFERENCES FOR MORE INFORMATION:

- Extension Service - University of Minnesota

Dr. Sally Noll - (612) 624-4928

- Minnesota Board of Animal Health

(651) 296-2942

- Minnesota Pollution Control

(Feed Lot Permits) (651) 296-6300

- Minnesota Dept. of Natural Resources

(Wetlands) (651) 296-4800



This Page Was Last Updated

05/07/2002

For suggestions email [webmaster@bah.state.mn.us](mailto:webmaster@bah.state.mn.us)

# Embedded Secure Document

The file *file:///E:/PROPHECYKEEPERS/data/POST-NUCLEAR-WAR/a\_reconstruction/immediate/death/fumigating\_mask.pdf* is a secure document that has been embedded in this document. Double click the pushpin to view.



# Embedded Secure Document

The file *file:///E:/PROPHECYKEEPERS/data/POST-NUCLEAR-WAR/a\_reconstruction/immediate/death/emergency\_gas\_mask.pdf* is a secure document that has been embedded in this document. Double click the pushpin to view.





# Preparing for Disaster

## Carcass Disposal Challenges During UK's FMD Outbreak

By Dr. Heidi J. Hamlen

California Department of Food and Agriculture, Animal Health Branch Emergency Program

In collaboration with G.A.W. Hickman, Department of Environment, Food, and Rural Affairs, FMD Joint Coordination Centre, London, UK; G.M. Trevelyan; M.V. Tas; and E.M. Varley.

**A**s we pass the anniversary of the beginning of the foot and mouth disease (FMD) outbreak that devastated the United Kingdom (UK) and captured the world's attention, it's important to look at the lessons learned. These lessons are valuable to all countries as they make contingency plans to cope with a potential outbreak. Carcass disposal posed a monumental challenge.

FMD is a highly infectious, rapidly spreading viral infection that affects cloven-footed livestock including cattle, sheep, and pigs. The UK, like many developed countries with a large export market for animals and animal products, practiced the "stamping out" method of disease control. This strategy calls for the humane destruction of infected and exposed livestock as quickly as possible to stop the further spread of FMD. The goal is to eradicate the disease, and thus preserve the remaining, uninfected livestock. At the onset of an outbreak, it is difficult to foresee the overall magnitude. A critical factor contributing to the extent of the 2001 UK outbreak was that FMD had already spread across many parts of the country due to the movement of inapparently infected sheep prior to disease detection. From the outset, animal health officials were

racing against time to control further spread (see Figure 1). An international call for assistance mobilized veterinarians and animal health technicians from around the world to assist in the control effort.

As a result of aggressive disease control measures, nearly four million animals were slaughtered and destroyed (see Chart 1), and another 2.5 million were taken for welfare reasons (i.e., they could not be marketed due to international trade restrictions or moved to other pastures because of national movement controls).

Infected and exposed animals were quickly killed, but disposal was more difficult. Decisions had to balance the interests of animal health officials whose primary goal was to quickly eradicate the disease with those charged with environmental protection and safeguarding public health. Officials then had to gain acceptance from the public for these complex decisions and policies.

Traditionally, animal health officials have been hesitant to remove carcasses from the farm for disposal for fear that it would spread infection, so they immediately began employing disposal options that had been used successfully during the 1967 FMD outbreak: on-farm burial and on-farm

**Table 1. Weekly Statistics of FMD Outbreak, February 25-June 10, 2001**

Week number	Week ending	Animals vets deployed	Military personnel deployed	Number of animals slaughtered	Number of animals disposed	Number of animals awaiting slaughter	Number of animals awaiting disposal
1	2/25/01	421	-	2,911	1,223	9,513	1,688
2	3/04/01	470	-	34,463	11,605	156,525	24,546
3	3/11/01	689	-	78,785	62,291	239,198	41,040
4	3/18/01	1,033	-	145,598	116,308	315,379	70,330
5	3/25/01	1,152	500	297,109	239,526	489,880	127,913
6	4/01/01	1,269	1,000	490,803	388,941	622,184	229,775
7	4/08/01	1,437	1,600	615,753	627,540	498,426	217,988
8	4/15/01	1,581	2,000	597,283	601,622	137,859	213,649
9	4/22/01	1,635	1,900	428,618	517,924	152,316	124,343
10	4/29/01	1,704	1,900	240,357	306,841	60,975	57,859
11	5/06/01	1,720	1,500	113,092	159,043	30,637	11,908
12	5/13/01	1,798	1,036	64,633	73,083	48,158	3,450
13	5/20/01	1,817	619	63,471	60,379	46,985	6,550
14	5/27/01	1,851	581	97,313	100,346	26,097	3,517
15	6/03/01	1,552	498	72,490	67,080	28,303	8,927
16	6/10/01	871	433	61,172	64,185	23,465	5,914

pyre burning. As the extent of the rapidly escalating outbreak became clear, the constraints on the two disposal methods also became apparent. The Environmental Agency and the Ministry for Agriculture, Foods, and Fisheries (MAFF) issued detailed guidance on steps to be taken prior to on-farm burning or burial of carcasses. Guidance highlighted the need to protect the environment, and, in particular, the ground water, and summarized environmental protection regulations. Many of the regulations had not been

atmosphere or watercourses. As a result, procedures needed to be put in place urgently to utilize rendering capacity, but at the same time provide the necessary disease security to minimize the risk of disease spread through the collection and transport of carcasses to plants. With UKRA assistance, plans were developed and put in place to dedicate six of the UK's 20 rendering plants to processing FMD infected or potentially exposed livestock, with priority placed on rendering cattle. The potential weekly capacity was about 15,000 tons of carcasses.

**Figure 1. Cumulative Number of Animals Condemned, Slaughtered, and Disposed of During the 2001 FMD Outbreak in the UK**



in place during the 1967 outbreak and placed major limitations to on-farm burial in many areas. Public health officials, the public, and the media raised concerns regarding the potential contamination of ground water from on-farm burial and air quality issues from pyres. While these concerns were being voiced, the outbreak continued to escalate. Carcass disposal could not keep pace with the rate that infected and exposed animals were being killed and farmers coped with the trauma of seeing the carcasses of their livestock for days, or in some cases weeks, prior to disposal (see Table 1). Officials needed to quickly develop alternative disposal options. These options included rendering, use of licensed commercial landfill sites, and the creation of mass burial sites – all new strategies for carcass disposal developed in the face of an escalating outbreak (see Figure 2).

**Rendering**

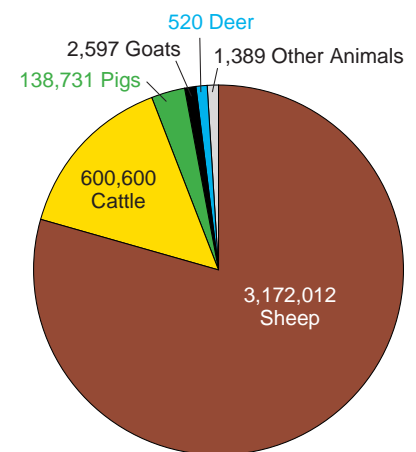
As soon as the first outbreaks were confirmed, Alan Lawrence, director general of the United Kingdom Renderers Association (UKRA), wrote to MAFF and offered the industry's assistance. At that stage it seemed that burial or burning on open pyres were to be the methods of disposal, but MAFF indicated that rendering might be used as a contingency. However, as already described, it soon became clear that mass burial pits and open pyres were unacceptable to the public, for environmental and health reasons. In the latter case, concerns were raised about bovine spongiform encephalopathy (BSE), or "mad cow" disease, and the possibility of the prion agent entering the

these routes were closely monitored for any possible spread of disease.

One of the unanticipated problems with moving animals to rendering did not involve disease containment, but the extremely narrow drives that made entrance of the large articulated trucks to the farms next to impossible. In some cases, this could be overcome by removing fencing or stone walls, but in other instances, smaller trucks or alternative disposal methods had to be used.

Due to the use of other disposal options during the 2001 outbreak, and technical and logistical problems, overall, the dedicated rendering plants were only used at 50 percent capacity. Discussions are currently taking place to utilize maximal rendering capacity should the UK have the misfortune to experience a future outbreak of this magnitude.

**Chart 1. UK Animals Slaughtered for Disease Control**



*Continued on page 20*

### Licensed Commercial Landfill Sites

As part of ongoing contingency plans, the Environmental Agency identified potential landfill sites suitable for carcass disposal. Existing protocol limits carcass disposal usually to five percent of the currently permitted disposal inputs of waste. In theory, landfill capacity could have absorbed comfortably all the stock slaughtered both in the FMD outbreak and the concurrent welfare disposal scheme; however, few landfill operators were prepared to accept carcasses, and then only sheep and pigs. To develop sufficient capacity to meet the peak demands of the outbreak would have required the government to direct the licensed landfill holders to take carcasses. The regulations that enable directions to be issued could not be applied to cattle born before August 1996 because of the higher BSE risk. However, directions were not issued and the voluntary use of landfill sites for carcass disposal was met with considerable opposition from local public, local authorities, special-interest groups, and farmers located near the landfill site. Therefore, it proved difficult to fully utilize this disposal option.

### Mass Burial Sites

Mass burial sites were developed in the UK as a novel option to cope with carcass disposal from an FMD outbreak. Large sites were procured (five in England, one in Wales, and one in Scotland) in which multiple pits each capable of

These mass burial sites were used together with rendering and licensed landfills to meet the peak demands for disposal and are regarded as national assets. Plans are currently in place to restore these sites and remediate environmental impacts.

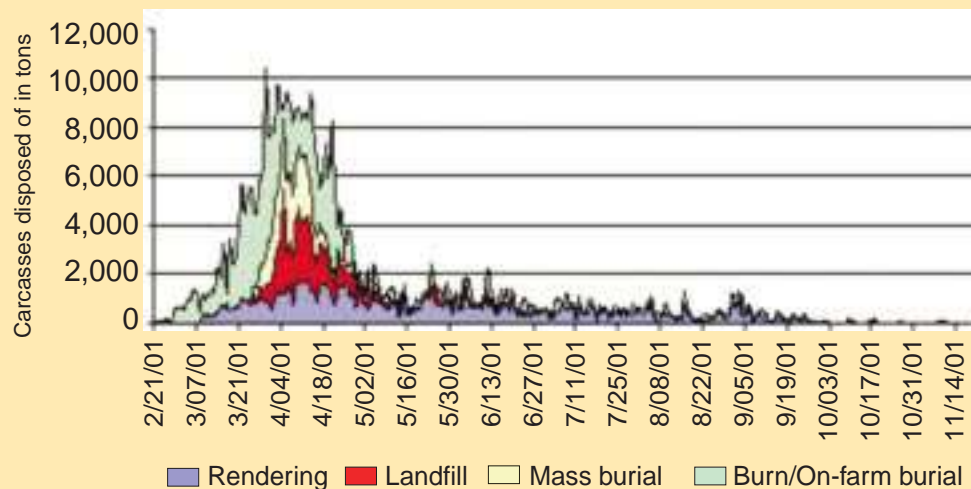
All agreed that rendering and incineration were the preferred disposal methods.

### Carcass Disposal Hierarchy

Early in the course of the outbreak, all stakeholders committed to developing a hierarchy of carcass disposal options that would balance the need to protect public health, protect the environment, and ensure FMD control and eradication. All agreed that rendering and incineration were the preferred disposal methods, but it was clear from the outset that these resources were not immediately available and even when fully exploited, could only partially meet the disposal needs. It cannot be stressed too highly that the disposal problem posed by the 2001 UK outbreak could not have been contained if on-farm burial and mass burial had not been available to the degree and at the time they were needed. That said, the agreed disposal hierarchy for carcasses, reflecting the input of all stakeholders, was

published by the Department of Health on April 24, 2001, two months after the outbreak was first detected: 1) rendering; 2) incineration; 3) licensed landfill; 4) pyre burning; 5) mass burial or on-farm burial.

Figure 2. Quantity of Carcasses Disposed of Through Various Disposal Routes



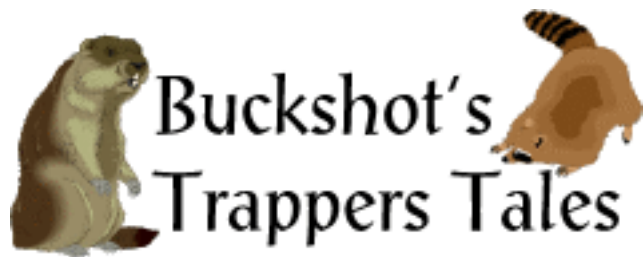
### Conclusions

The valuable lessons learned during this outbreak include the serious public health and environmental impacts of the various carcass disposal options, the ability of the public to accept these options, and the substantial challenges faced by the government in implementing

holding between 10,000 and 60,000 carcasses were engineered. At the start, there were no proven designs for mass burial sites and the design features underwent rapid development and change over four to six weeks at the peak of the outbreak. Increasingly sophisticated liners and leachate collection systems were employed to minimize risk to groundwater. The extreme nature of the emergency with regards to delays in carcass disposal required that these sites be made operational with little advance consultation of stakeholders and environmental bodies if a public health or animal health disaster were to be avoided.

successful carcass disposal strategies in the face of a rapidly spreading outbreak of this magnitude. Unlike the 1967 FMD outbreak where virtually all carcasses were disposed of on-farm, in 2001 the majority of carcasses were disposed of off-farm under conditions of strict biosecurity.

The valuable role that rendering played in this outbreak should be a call to action for all renderers to work closely with animal health officials to develop and expand contingency plans. By working together, we can safeguard animal, public, and environmental health during an animal disease crisis. ❖



## Wild Dogs Pose Post-TEOTWAWKI Danger

I was in a chat room tonight and we were discussing dogs. I said "If TEOTWAWKI (the end of the world as we know it) happens, then 100 millions dog will be a major problem." Then we got to talking about the Great Depression and how the land was almost hunted dry.

First, before we accept that as fact, here was the argument. One person stated that when the great depression happened there was half the population, then there is now. So, if a great world collapse was to happen today, his premise was there wouldn't be anything left in the forest. I have to disagree. My biggest point was during the G.D., 40 percent of the population came from farms, most knew how to hunt and a fair percentage knew how to trap. Then it makes senses that the game would disappear. But even then, there were a percentage of trappers all over this country that fed their families and saved their farms with the fur money. See the value of trapping?

My premise is we have 90 percent of the U.S. population in the cities. Most are soft and would rather steal what you have then work at hunting or trapping. I believe most will never get out of the cities and will die in a hail of gunfire, rioting and fires. When all this is going on, they will let their pets go free, thinking at least they can survive on their own. This is why at 4:00 am I'm writing this article. I could not sleep. I know city people will do this and we will have 100 million dogs and 80 million cats released to go wild.

Now what I have to say next is not for the weak hearted, if for any reason you have a weak stomach or can't handle a cold hard reality check, then [go back to my home page](#) and choose another article.

OK, for those that are still with me, these animals will be a major problem and must be dealt with. Period. This isn't Disney, where you can talk to the poor dog and cat and the world is all fuzzy and warm. This is reality. If you own animals never, ever, EVER, release them to go wild. If you don't have the stomach for putting them down, have someone else do it. If you have to put dog food away at your camp, cache, whatever, great. I think a dog is invaluable then. A cat in the wild in this crisis is your greatest enemy. One study in Wisconsin found that the best predator against small game was the house cat. The common house cat killed more small game than all other predators in the study.



Now the reason I'm up this late and can't sleep is the dogs. I understand pack mentality and a pack of dogs scares me more than a pack of wolves. I have been studying the woods and wildlife my whole life. This is how the dogs will form packs, an alpha male will take control of the pack with a beta male as second in command, the packs will range from 6 to 100 dogs depending on the food supply.

This scenario, I read years ago of a pack like this had 45 dogs and this was how they attacked people. The alpha picked a friendly looking female like a collie. This is the decoy dog. As you are walking in the woods, the collie approaches and draws your attention, as the packs circle you for the kill. When the pack sneaks up to striking distance, they will attack and so will the decoy. I'm talking lightning fast 45 dogs coming at you. How many rounds does your clip have?

You see when the riots and the death in the city is happening the dogs will learn to feed on the bodies then in turn will acquire the taste for humans. Now you have a pack of wild dogs who consider you and your loved ones as food. They have no fear of man and will kill you to insure their own survival. Now, I'm not trying to scare you and sell fear. I am telling you that this will happen if the chaos of TEOTWAWKI occurs. You'll have to learn to kill dogs and cats on sight. Period. This is not an option.

If you want to insure your own survival, then listen to me. This is no game. If you think I'm just stating this to sell you trapping equipment then click off this article and go take a poll of the people you know, ask the following question, "What would you do with your dog and cat if you lost your job and could not afford to feed them?" I have lived in the country most of my life and I have had to deal with these animals that people let go on their own.

I have talked to the people who have told me that they still believe their Ralphy boy is probably still out there hunting with the best of the coyotes. Dreamy like and with pride in



there voice! Or I know my cat is still alive because he was the best hunter in the neighborhood, he killed more birds then any other cat!



I'm not selling anything but reality! I'll tell you another dog story that happened to me. I was trapping on this farm years ago and I caught a black mangy, scaly looking black lab mixed mongrel. I have caught lots of dogs over the years and I can let most go with out a problem, unharmed. Anyway, I approached this dog and started talking to him and slowly moving closer. The dog stood up, wagged his tail and appeared happy to see me. When this happens, 99% percent of the time I can release the dog and place

him in my truck to take to the farmhouse and explain what happened. Most dogs are fine and have a sore foot for a couple of days, then they're back to normal. Not this dog he lured me in with his friendly attitude until he thought I was in striking distance, then turned into attack mode. Lucky, I was prepared for the reaction and quickly jumped back. I never will forget that lighting fast change and the snarling teeth just missing my hand. The dog misjudged his strike range, if I had been a little closer this would be a different story.

So I walk back to truck truck, found the farmer and told him I caught his dog. The farmer says I don't own a dog and what color is it, because some black mongrel attacked his wife yesterday. To make long story short, the dog was turned over to the humane department and tested positive for rabies. Now this was back in the early eighties when a lot of people were getting laid-off. People were letting their dogs go in the farmers' fields and without proper care, and the dogs picked up all kinds of diseases. Someone has to deal with these dogs. There is no such thing as a dog or cat that is better off let go to fend for themselves. I have seen them all and most of the time you would never recognize them after 6 months on there own.

If a TEOTWAWKI does happen then someone in your group preferably everyone should trap, hunt and kill every dog and cat that has gone wild in your area. Period! I'm writing this early in the morning because I couldn't sleep at the thought of that many wild dogs and cats free in America.

The best defense to protect your garden and livestock or game animals would be snares. I would have 10 dozens coyote grade snares and enough heavy wire to set all of them at once.

Here is another theory: Starving people will kill the dogs for food. I say sure some will become food, but the average household that has guns has less then 50 rounds, although most survivalists will have much more. So, I think after the first week most people will be

out of ammo. Then the packs will rule.

Let me know what you think, am I way off base? I just keep thinking of all the people in the cities and their "My dogs are my children" attitude. Dog and cat food is a huge business. I mean, they have pet psychiatrist for Christ sakes. Think about all the movies and shows like 911 where people risk their lives to save animals. I'm not saying that this is wrong, all I'm pointing out is people's attitude toward pets, and I guarantee they will let them go to fend for themselves when the food runs out. Make sure you are ready to face this threat.

---

[More on Dogs](#) | [Back to Buckshot's home page](#) | [Back to Captain Dave's Home Page](#) |  
[Search](#) | [Shop](#)

## Medical Rorganization

In the immediate aftermath of a world-wide nuclear war, any medical facilities that survive will be completely overwhelmed and there will be little capability to replace any supplies. Those that they have will soon be exhausted. Trauma and triage will be the order of the day. Medicine will almost immediately be thrown back a couple of hundred years. Any surviving surgeons will have to quickly learn how to perform amputations without benefit of anaesthesia.

Any surviving medical and nursing staff will have to act largely as supervision to newly recruited personnel. Sanitary procedures will be a challenge and the facilities will tend to have the odors and noises of centuries ago. It will be a quite different place than people associate with hospitals today. They will mainly be a place to take people to die.

There will also be many more psychiatric problems because portions of the surviving medicated population will become irrational and the ensuing events are likely to induce traumatic and pathological behavior in others.

Safety procedures should be even more rigidly enforced because the traumatic penalty for accidents will be ever more serious. Diagnostic procedures will be largely nil and surgical remedies that would have been commonplace will be undoable. Alternate older time remedies and procedures will have to be implemented where possible until pharmaceutical production can be reinstated - which for most items will be months and years and for some possibly decades.

Listed here are two resources which may be useful in some locales.

### [Medical: Where there is no Doctor](#)

This \_\_\_\_\_page .pdf file is currently sealed and because of copyright won't be opened until after a nuclear war. This book is currently available from many places for about \$20US. One source is:

<http://www.baproducts.com/nodoctor.htm>

### [Dental: Where there is no Dentist](#)

This \_\_\_\_\_page .pdf file is currently sealed and because of copyright won't be opened until after a nuclear war. This book is currently available from many places for about \$20US. One source is:

<http://www.baproducts.com/nodoctor.htm>

Some other books that have been recommended to me are:

**The Onboard Medical Handbook**

Gill, Paul G.

**Advanced First Aid Afloat**

Eastman, Peter F

**First Aid Afloat**

Haworth, Robert

**International Medical Guide to Ships Including Ships' Medicine Chest**

World Health Organization

**The Ship Captain's Medical Guide**

Department Of Transport (U.K.)

**MENU:** [HOME](#) » [Reconstruction](#) » [Recovery](#) » [Renewal](#) » [Survival](#)

---

---

# **Entitlement in Local Economy Trading Systems (LETS) (for post-cataclysmic recovery) A Blueprint by Bruce Beach**

Version 3 - December 24, 2000  
changes as of June 3, 2001

## **Prologue**

The purpose of this essay is to describe ENTITLEMENT in LETS (Local Economy Trading Systems) that might be established after a nuclear holocaust or other world-wide catastrophe that seriously disrupts society. LETS are the most highly recommended systems, for post nuclear recovery, to have come out of the Final Report of the US Federal Emergency Management Agency study (RR-31 / Reprinted March 1990) on "Markets, Distribution, and Exchange After Societal Cataclysm" (pp. 94-95). The details presented here are the results of decades of study and contemplation, by the author, a university trained Institutional Economist and at one time a college professor of economics. The author has been acquainted and involved with LETS for many years, over a decade ago developing a video presentation for which he arranged booths at fairs for its presentation.

In this essay we will be discussing the meaning of "entitlement" and how it should be implemented, along with a description and examples of the operation of LETS. The intention is that this essay should be used as a blueprint, a "How To" manual, in a post-cataclysmic recovery period by those who will be working to reconstruct society. In stable times, most members of society will not bother to examine the justifications or reasons for why things are done the way they are done. But at the time of social collapse and reconstruction these subjects must be addressed so that in rebuilding we do not simply reimplement portions of the structure that may have contributed to the collapse, or that were previously irritating and that we simply accepted along with the entire previous structure. For this reason we will seek to remove some of the veils regarding money and show the justification for redefining the rules for entitlement.

## **The Meaning of Entitlement**

A Just Economic System is about entitlement. WHO is entitled to WHAT. All persons, in an abundant society, are entitled to subsistence. That is to say, to sufficient food, shelter, clothing and basic health care, that they will not die. In a less than abundant society, decisions sometimes have to be made between those who can contribute to the survival of society and those who can't or won't. An abundant society that is humane will meet the needs of the handicapped, incapacitated and elderly. Any society should be

particularly concerned about the health, welfare and education of its children who are the future. A society of true abundance and justice will provide to ALL its members the opportunity to not only fulfill their material needs, but also the opportunity to develop to the utmost their spiritual capacities.

Some persons feel that in recent decades the term “entitlement” has attained the connotation that the unproductive and irresponsible members of society have a claim on the wealth of those who do produce and exercise personal responsibility. They use the emotional word “irresponsible” where often the word “non-responsible” would be better. Children are non-productive and non-responsible. Likewise the very elderly may be non-productive and non-responsible. The same can be said for mentally retarded and other categories. But, aside from that, the idea of entitlement that is our concern here, is more concerned with production than consumption. It is mainly concerned with who (which entrepreneurs) are entitled to the factors of production (land, labor, capital). The purpose, concern and thrust is to increase production as quickly and efficiently as possible, through the encouragement and support of entrepreneurship, so that there will be an abundant society in which everyone gets cared for, to a standard that allows for personal growth and development to their full potential. It is necessary that distribution of resources will be based upon value judgements as to the future possibilities present in the person and on value judgements regarding the moral quality of their behavior.

## **JUST Economic Systems**

A Just Economic System in this world is RELATIVE, that is to say - less than absolutely just. Only God can dispense ABSOLUTE Justice. All human decisions in this world will remain relative because of the frailty of human wisdom and character. The ONLY choice is through LAW and ORDER. The alternative - anarchy - is lawlessness and disorder, and is not a choice for a society that seeks JUSTICE, harmony, security, and abundance. The natural order of life is interdependence and a Just Economic System is a part of a Just Society. It must be a part of a just society. It cannot exist separately from a just society, nor can a society be just - without a just economic system.

A JUST economic system is based upon the Pillars of Reward and Punishment. The carrot and the stick. It should be organized in such a way, (as should society itself) as to:

Encourage the Saints,  
Direct (Guide) the Sinners, and  
Restrain the Satans.

and assure that they all contribute to society.

## **The Need for LETS**

LETS are an intermediate step between "household economics" and "national (or international) economics". No claim is made here that LETS should be the only economic system, or that they should replace "traditional monetary systems" at the national and international levels. But they do fill a gap that has been previously ignored. LETS have not had overwhelming success or acceptance (which amounts to

the same thing), in the few decades since their inception although there are many hundreds of them. Part of the problem has been the exhaustive missionary and educative process that would be needed to gain acceptance in a culture that has become almost completely identified with the "traditional monetary systems". There have been other problems also, such as the necessity for an initial critical mass of participation for a system to reach a "kindling point" of usefulness and efficiency.

After a societal cataclysm, LETS can be a key factor in the RESTORATION of SOCIETY. In economically underdeveloped societies, and as a matter of lifestyle among some individuals, independence and self-reliance has been a necessary or desired way of life. Recession, depression, and stagnation in large economies have often meant that individual households have had to independently produce what they have not been able to obtain from the larger economy about them. Independence and self-reliance have both their advantages and disadvantages. As an advantage, those who are able to function independently can sometimes use their own resources that would otherwise be idle. As a disadvantage, where there is no cash or exchangeable assets they are often cut off from the larger community and are forced to live without many of the advantages of specialized technologies and services such as advanced medical care. On the whole, independence is at a disadvantage as compared to interdependence, because interdependence generally allows for very great efficiencies of specialization and much more appropriate use of each resource available.

In a money based economy, the only alternative to self-production has been possession of the required currency. Independent barter is generally inefficient because it is difficult to find others willing to exchange the exact goods that one desires, (and in the exact quantity desired) for goods that one has available to exchange. Local trade fairs offer little additional advantage. While they permit one to exhibit their goods to a broader audience, still the medium of acceptable exchange is usually based upon the broader recognized currency. LETS provide an intermediary step, permitting a community to efficiently exchange goods on services on a broader basis than that of an individual household, and thereby more extensively and efficiently utilizing the resources of the entire community.

## **The Need for Entrepreneurship**

In the final analysis, all goods are created by what economists recognize as the four factors of production:

Land  
Labor  
Capital and  
Entrepreneurship

It is the fourth factor that is the most necessary to reduce the idleness of the other three resources, and to assure their most efficient use, and it is the fourth factor that LETS most enhances over both "household" and "national" economies. Value of goods and services is based upon factors besides the four factors of production. These can be such factors as scarcity, necessity, perceived intrinsic value, and others, but an exchange system accommodates these subjective values in its pricing and exchange rates, as a part of the mechanism of what is called "supply and demand". Still, the relative values of the various factors of

production are often determined by tradition, established power structures, and other external factors that are not necessarily determined by technical factors. It is these historical methods of determination of entitlement, that arose from culture, custom and tradition of the preceding mode of socio-political organization, that we must often directly replace with new determinations of entitlement in order to jump start society, and to once again get production going.

The theory is, that the more local that motivated entrepreneurship can be, that is to say that the further down the productive system or chain that we can press it, then the greater the efficiency that there will be attained. What we are talking about is the power of the motivated decisions of the individual in a free economy. Because it is an exchange economy we obtain the efficiency of “relative advantage” that arises out of the differences of land, labor, capital and entrepreneurship, and those which are contributable to specialization and division of labor. Socialists argue that a controlled economy is more efficient, because it eliminates the redundancy of competition and assigns resources on the basis of social need rather than on the basis of individual selfish desires. There must of course be a balance between individual selfish desires and collective social need. Finding a balance between these two philosophies will achieve the benefits of both worlds ... and eliminate the tragedy inherent alone in each. To find this balance there must be a new revelation in the thought processes of those participating in the rebirth of the economy. Those in authority must avoid the pitfalls of the past without endangering the future with socio-economic fallacy.

## **The Establishment of Authority**

The purpose of this essay, in describing how Entitlement may be determined in LETS, is an entirely practical one. While grand philosophical issues might be discussed, analyzed, and debated, what is presented here is a practical suggestion of how local communities may go forward and recover economically from a cataclysmic upheaval. Indeed, because there can be such difference of opinion as to what is the best course, and because circumstances can vary greatly both through time and from location to location, what is key to determination of Entitlement, is the establishment of THE AUTHORITY to determine the Entitlement. Anyone who comprehends what will be presented here will understand that the two go hand in hand or, better yet, hand in glove, for the one - Entitlement- is clothed with the other, Authority.

Simply put, it is Authority that determines Entitlement. The underlying principle is that the authority of the governors arises from the governed. That the authority of the highest levels ultimately rests in the lowest level groups, through their selection of delegates to the next highest level, and the repeat of that process through to the highest levels. The legitimacy of the authority of the higher levels therefore comes from the right of the governed at the lower levels to choose their governors. I have redundantly expressed this in three ways, so that there can be no doubt about the matter.

The governors, during their terms, need not refer back to any historical documents, no matter how previously revered. They need take into account no previous customs, no matter how long established. So long as there are no established operative authorities above them they need not limit in any way their own



actions. Hopefully, at all levels, those implementing policies and rules will be guided by the higher wisdom that has been communicated to mankind in the past by the highest spiritual sources such as the Prophets and other leaders in moral thought. The concern with morals and ethics in economics has a long history. Adam Smith, considered by many as being the father of economics, was a professor of Moral Philosophy and until more recent times the study of economics was always referred to as “Political Economy”.

## Justice and Law

The success of LETS has a lot to do with the success of the re-establishment or replacement of what is currently considered law and order. Entrepreneurs must have some stability, some assurance that their work will not vanish to either an officially sanctioned or a rogue raid. The higher administrative levels will have to curtail the power of those from within the administrative structure who try to unduly use either their influence as well as those from without who seek by violence to achieve their own ends. Practically, the administrators will have to deal with the specifics when they meet them. The remedies will depend both upon the specifics and their resources for dealing with them.

Both revolutionaries and the establishments justify their actions on the basis that they are the more just and that therefore they are justified in any means to obtain their ends. For this reason the educative process is essential in instilling a sense of high moral value, justice, fair play and so forth. This educative process must be of a higher mentality, emotionality, and spirituality than has ever existed in mankind previously, or the pattern of errors plaguing the past will quickly reverberate all over again. It is a long and difficult process because the veneer of society is very thin and the task is most delicate, but nevertheless it is essential. Unless there is a broad consensus as to what is fair and just, then the entrepreneurs have no principles to play by and no surety that others will be expected to play by the principles. Without such guiding principles there is no justification for hope of reward for taking the risk that is part of being an entrepreneur.

## Justice and Rights.

There does not need to be the burdening mass of laws, rules and bureaucracy that shackle the present day social innovators in order to preserve the inherited status quo. The decisions in LETS can be made by responsible individuals with souls, rather than by soulless corporations and government bureaucracies guarded and guided by minions of legalists dedicated to specific ends rather than to common sense, readily recognized justice. In the final analysis, despite the existence of laws, that in their printed form occupy hundreds of feet of shelf space, the decision of what is right or wrong comes down to the minds of the judges. Substantiating precedence can be found for most any position by anyone with enough funds to have expensive and capable talent search what are many miles of printed previous decisions. It is seen as excellent justice for the wealthy and often meaningless unfairness for the poor. Often the procedure is just delay until a matter becomes irrelevant. Thus justice delayed is justice denied.

The operation of any system is dependent upon the good will, wisdom and spiritual enlightenment of its

administrators. It is incumbent upon the members of groups to select administrators with those qualities. The administrators must in turn seek to assign delegates, with the same qualities, to the higher levels. These individuals can then dispense justice on the basis of Principles of Recognized Rights and Freedoms rather than interpretative arguments regarding syntax in written statements of law. Since economic actions (as well as social ones) will be the responsibility of real persons with souls, rather than the fictitious persons of soulless corporations, the interaction of dialogue can be between the individuals, and the administrators, and any aggrieved parties, on those principles. Educated descendants of the original indigenous inhabitants of North America, and other such native peoples through out the world pointed out how the lack of such commitment to justice in the Western systems was a major shortcoming.

At every level, from the lowest groups, through each level to the highest, there must be the recognition of the responsibility to educate all participants in the need for honesty, trustworthiness, integrity, fair play, equality, tolerance, commitment to freedom, and justice. We need only look about the world at the moment to see how intolerance, fraud, bribes, collusion, arbitrary power, exclusionary interests and such, wreck the opportunity for progress, security, and the benefit of all. A system of intelligence, morality, and spirituality greater than any inspired people before, must be instilled in the survivors of the disasters - or the disaster begins again.

## Money.

John Maynard Keynes supposedly said, "Money is a veil", although I have not been able to locate the source. In any case, to most people, its nature is a mystery. Money is more than currency or coin. More than cash and checks and the balance that one has in the bank. The line between liquid and non-liquid assets blurs as does that between debt and credit. Various definitions of money exist, such as a medium of exchange, or a store of wealth, but none of that concerns us here. We each have enough sense of the meaning of the term money, to have a notion of what we are talking about.

One of the main issues of ENTITLEMENT is WHO is authorized to create money. In the traditional systems of the 20th century, in many people's minds, it was the government. They saw the printing of currency or coinage as being the creation of money. Gradually most knowledgeable people became aware that cash (i.e. currency and coin) was a very small part of money and that it was actually the banks that created money through loans. Still, some felt that this was controlled through the government through its National Bank, or as in the US, The Federal Reserve (an actual, probably intentional, misnomer). In most capitalistic countries, including the US and Canada, the money creation system was owned and operated by private capital organizations. It was the purview of persons of great wealth and power who were truly hidden behind a veil. Unelected. Uncontrolled. Unaccountable. Unresponsible. And Unresponsive to many of the legitimate needs and concerns of the lower classes of society. .

Neither the history, morality, nor the mechanism of the creation of money in the past need concern us here. What LETS does is put the control of the creation of money in the hands of the individual to a greater degree than in the past. In actuality, it rested there to a degree already, to the extent that

individuals were willing to create debt by borrowing or lending money. Sometimes referred to as consumer confidence. Every person who had a credit card was authorized to create money within the limit set on the card. The real issue then becomes, who has the authority (or is entitled) to set the limits on credit cards or to refuse loans. It is not done by the legislatures of a country. It is done by the banks, and the lending, and other, financial institutions. Under the LETS proposed here, we are therefore concerned with establishing the Authority for Setting Limits to Entitlement.

-----added June 03, 2001----->

More than the issue of the quantity of money is that of the quality of money. There will be those who advocate a return to gold and silver or at least 100% metal backed certificates. The thesis here is that there is room for a variety of currencies. The key concept behind LETS is that the mere lack of existing certificates should not be a limiting factor when there is value to be exchanged. There needs only to be authorized entitlement to issue further certification. Should some levels or types of certification come to be more highly appreciated, then in accordance with what is called Gresham's Law, but which is in reality a centuries old principle, the poorer currency will drive out the better. That is to say the less honored currency will be offered first, and the more honored will be hoarded. Under the LETS system, this problem is self rectified by the capacity of traders to issue their own in accordance with their entitlement while the dilligent seeking of more honored currencies will simply be to the enhancement of industry.

<-----

## **Authority to Set Entitlement.**

Theoretically, in capitalistic countries, the chartered banks got their authority from the government, and the government got its authority from the legislatures and elected representatives of the people, so that ultimately the control of money supposedly rested in the people. In practicality, as most people came to realize, it was the large concentrations of wealth (and consequently power) that actually controlled the programs of the political parties. While immense emotional furor existed regarding the various programs most people realized that there was little difference in their basic tenets and that control ultimately remained with those who controlled (usually inherited) the great concentrations of wealth. For this reason, most people never bothered to devote any great amount of time or personal financial resources in involvement in those processes. Some few did, out of emotional attachment to some philosophy, and some few others because by working within the systems they were able to achieve personal gains. But as stated, most were alienated, because they recognized that they had already been effectively disenfranchised from the centers of power that actually controlled their entitlements.

What is presented here, as an alternative, would under any other circumstance, other than in that of restoration of society after a societal cataclysm, be seen as mere Utopian Daydreaming. But in this particular circumstance people have not only the opportunity, but the necessity, to create a system that will fulfill their needs. They will be well advised in the process to create a JUST system. All authority eventually rests with God. Those who would implement human systems should keep foremost in their minds the objective of being in accordance with God's command for Justice. That being said, and

hopefully being conformed to, to the best of human ability, there still exists a wide spectrum of approaches that one might legitimately undertake. There may be a need to paint a house, but one can paint it attractively in any one of a number of different colors or combinations of colors. And likewise, the system presented here is not the only possible system, but is a well thought out and practical one. .

LETS are, as its name says, LOCAL. Families are free to implement within their own families such policies and practices of economic production, sharing, or restraint as they wish, and at the other end of the spectrum there may be international and national economic organization that is very different in policy and practice. LETS are meant to fill the gap in between. And there is a gap. It cannot be filled by individual family activity, and in the past has often not been filled by national or global activity as evidenced by the numerous and widespread pockets of poverty among a world of plenty, and the numerous times that even locales of affluence have become stagnant.

## **The Mechanics of LETS**

The mechanics of LETS have been well established through actual usage and practice by many tens of thousands of individuals in hundreds of LETS associations.

Basically one issues to anyone in the system, credits (that is to say - LETS dollars) for having delivered goods or having performed services. One can give (create) these credits to the combined extent that they have received these credits from others for having delivered goods and services to other members, and that they have them in their entitlement.

The facility for tracking LETS transactions has been greatly enhanced by the availability of personal computers. The availability of computers, however, will not be a determining factor of whether or not LETS systems can be implemented because they can even be implemented with a pencil bookkeeping method. While there are specialized LETS accounting programs available, they have no real advantage over any very simple bookkeeping or even spreadsheet program.

Practical experience is the best guide, and it is practice that will give experience. The procedure can be as simple as creating and exchanging checks like most everyone is familiar with in the current banking system. The checks can then be hand cleared and accounts credited or debited at the central LETS office. Just as technology assisted the current banking system in printing, numbering, sorting by account number, and so forth of checks, and the keeping of accounts on computers, so could it benefit LETS if it is, or becomes available.

Very advanced techniques of electronic debit cards can be used, once that technology again becomes available. Yet, simple is as simple does. To avoid security issues such as counterfeiting, forgery, uttering, kiting and other such deviousness, a LETS may need both an internal and external system of checks balances to accompany its authority for overseeing entitlement. These systems, however, should not be over burdensome and should simply meet the practical necessity of the milieu and level of activity of any particular LETS.

What will need to be done in practice, is that those with some skill in these matters, will need to establish the local mechanics and procedures. Hopefully, then, they will be willing to share their art with others in nearby localities where others are also trying to establish LETS. As the popular saying is today - this isn't rocket science that we are talking about.

## Creating Entitlement

Entitlement is the real key to the system. It is the ability to create credit or debt. The limit of entitlement is determined by the administrators of the individual LETS, and by the higher levels of administrators, by whatever rules of community standard they wish to apply. Theoretically, they might establish no limits. But then, rather than continually growing in value and usefulness, the credits could become debased and useless by their being over issued by non-producers. Or, for that matter, an entrepreneur of the very best intentions might issue too many credits relative to the resources of the LETS and swamp the system, or worse yet, that entrepreneur might fail and take the LETS with him or her.

At the other extreme, if the administrators are overly conservative, or even if the members of the Groups are overly conservative, and are not willing to take any risk in taking debt and issuing credits, for fear of loss, then the system will collapse equally or more rapidly. One must apply their talents, (as in the Biblical parable) to the best of their ability. Many arrows will miss the target. Numerous seeds won't sprout. But that is the nature of life. As an analogy, there must be tolerance for those who have a bad or failed crop, whether due to external situations such as the weather or pestilence, or whether due to bad management. In the latter case, it is responsibility of the Groups to share in educating, assisting, and encouraging their members in better management techniques. Sometimes in restraining their members in the use of credits and other times (perhaps oftentimes) encouraging them to use and employ even more. The administrators at the higher levels need to particularly exhibit guidance in these matters.

LETS has never been used anywhere, to this writer's knowledge, as a primary system. Using it in this way will present new challenges, and also new opportunities. Properly instituted it may be able to provide full employment, and much greater efficiencies, along with better opportunities for social and economic justice, and a more fulfilling approach to life and spiritual growth. While that seems a lot to hope for - it must nevertheless be the goal. LETS as the primary economic structure can provide the higher levels of the accompanying social structure, as described previously, with the resources to fulfill many of these social goals. And, it should be mentioned, without the need for interest or taxes. Once more there must be a cautionary note - LETS, as its name implies, is a LOCAL system. Its principles do not necessarily apply to national and international systems. There, others may see advantages in retaining such institutions as interest and taxes.

## Risk and Fraud

Once again, let me stress, there must be an appropriate degree of tolerance for failures, and where needed they must be written off without penalty or reflection on those responsible for them. Developing

entrepreneurial skills is a learning process and experience, including failure, is often the best teacher. The nature of the world is that it in GREAT abundance rewards the proper combinations of land, labor, and capital. In the financial/industrial world of the past, there were often very great failures, even under the skilled hands of highly trained, motivated and capable managers. That too is part of the nature of the real world. What is needed is the appropriate development of entrepreneurial skills. In a well functioning economy there will be an increasing amount of abundance to risk (I do not wish to say waste) on entrepreneurial training and experimentation.

LETS are rife with the potential for fraud, but so are all other exchange systems. Properly implemented there is less probability of fraud with LETS because at each level, and within each group, there will be numbers of independent and unbiased monitors. Indeed, as compared to the traditional system LETS can be thought of as being almost fraud free, if one comprehends how the old system worked to the advantage of a small privileged class and to the disadvantage of the masses. There is an old saying that he who stole the goose from the commons was caught and punished while he who stole the common from goose was let free. With LETS there may be more opportunity for goose stealing less opportunity for commons stealing. This may be only an idealistic hope, and one will have to wait and see if events actually bear this out. It is prudent to be tolerant of the occasional missing goose, and be thankful if one retains the common.

## **The Limits of LETS**

How broad a local community to which one may apply LETS, also has not been determined. The basic LETS unit, as described here, would consist of 10 groups having a total of 500 to 2000 members among them. Small enough to be personal, but large enough to have some efficiency. On the other hand, the overall structure allows higher administrative levels to control interaction between these individual LETS. A fourth or fifth level of combined activity could involve millions of people, but the basic building block would remain LOCAL, just as the basic economic and social unit in society remains the family.

At some higher level, LETS would cease to be local and would become national or international in nature. There may then be a different set of problems, such as the need for national or international currency. Coordination of International Exchange. Matters of jurisdiction over a plethora of international matters such as air waves, air travel, and shipping. Rules, conventions, and standards for measurement, safety, and security. The control of international resources, water, air pollution, and use of the sea. These subjects of national and international commerce are all far beyond the purview of this essay.

## **Examples of LETS Activity**

### **The Farmer Comes First**

The farmer comes first in the construction of society. The farmer comes first in the re-construction of

society, and the farmer should come first in LETS. The first need of the farmer will be security, to protect any current inventory, to protect his farm and equipment, and to protect his family.

Because there may be less mechanization available after a societal cataclysm (because of lack of fuel or power), farm operation may become more labor intensive and the farmer will need access to more labor. In rationing, the farmer will have a very high priority to any fuel or energy available. Alternate sources may have to be developed.

All of this resolves down to entitlement and the farmer will have to have explained to him that he has the entitlement, right and responsibility to issue LETS dollars for these services. His production is the basis of the survival of society. Agriculture must have the necessary resources allocated to it and is the first place where we wish to put to work any idle resources such as labor.

## **Social Services Come Second**

The maintainers of order (police, fire, military), health services (doctors, hospitals, community health), infrastructure reconstruction (mail, public transportation, power, telephone, gas), basic reconstruction (roads, rail, bridges, sewers, heavy equipment operators, truck drivers, etc.) and essential industries (food processing, refineries, paper mills, etc.) need to be returned to service as soon as possible. If the existing institutions survive they may be able to do this in several ways. By use of force, etc. However, if they do not survive sufficiently, or are sufficiently flexible, this could and should be achieved by the issuing of LETS dollars by the Higher Administrative Levels as described above.

## **Scavengers and Entrepreneurs**

One of the first strategies of recovery and reconstruction will be scavenging. This is an activity that will need to be both encouraged and controlled. The tradition has been Martial Law and the shooting of looters. While that applies to a local tragedy it is not suitable for a universal cataclysm. Scavengers too, need resources and outlets. Authorization by LETS Level and Higher can give them the authority and also the outlet in the way of LETS dollars for delivering their goods. The key to organizing such enterprises lies with entrepreneurs. These need to be identified, recognized and authorized by LETS and higher administrative levels. These levels need to authorize, entitle and legitimize entrepreneurs, the fourth and often the most essential factor of production. The vitality of non-centralized economic systems, and particularly of LETS lies in the development and release of the entrepreneurial talents and spirit. Indeed, the free entrepreneurial spirit is the single most significant distinction between decentralized and centralized economies, and the demonstrated efficiency of the former. It is for this reason that LETS Higher Level Administrators must authorize and encourage entrepreneurship.

## **New Production**

Scavenging is only a temporary solution and possible for a short duration. Eventually new production

will be necessary. Establishing new production should then become the prime objective of the Administrative Levels. For this purpose, special accounts with appropriate levels of entitlement may need to be established for individuals who appear to have the necessary qualities and capabilities. In the traditional system this was the function of bank managers. When one looks beyond the veil, they will see that this is also the way in which banks created money. Entitlement to money creation is only one of the forms of entitlement that will be needed by the entrepreneurs. They will also need entitlement to land, and capital (meaning, in the terms of economists - plant, machinery, equipment, etc.). The traditional forms of entitlement being inoperative, the method of entitlement will have to be developed on the fly by the founders of the LETS. This writer's personal preference is to invest it in individuals, rather than in "soulless" corporations.

New production may begin in cottage industries, even by the re-invocation of some older technologies. There should be considerable liberality in supporting every effort. Repeated failure in such difficult times should not be unexpected and should not be subjectively penalized but should be objectively redirected with love and encouragement. As conditions stabilize then higher standards of performance can be imposed. Experience and increasing maturity will eventually be gained at all levels. Once again, the most beneficial path is to educate and encourage as many as possible in the entrepreneurial skills and spirit. The benefit of LETS is that these skills, as well as the other factors of production, need not lie idle because of external factors outside of the LETS control, as is the situation with local economies at the time of this writing.

In the past there has been a trend towards both vertical and horizontal integration and conglomeration of industry. There are undoubtedly some technological efficiencies to be obtained in such a process. On the other hand a large part of the activity was motivated by the need for access to money capital, or simply the control that was influenced by money capital. This type of control is counter-productive to the initiatives of individual entrepreneurship and it will probably be beneficial, especially in the time of social reorganization, to achieve as much as possible the benefits of that prime factor of production, through as much decentralization as possible. Even in large production facilities, there should be the ability to implement schemes of individualized control, or at least profit sharing, so as encourage individual incentive and entrepreneurship for efficient management.

## Other LETS Functions

Besides providing entitlement to money and factors of production, the LETS can facilitate the local economy in many ways. It can provide inventories of the skills, services and goods available. It can establish acceptable rates of remuneration. It can witness contracts. It can adjudicate disputes. It can control and prevent abuses.

LETS Administrators should rise above the pedestrian view of being mere bookkeepers or adjudicators within the standards of the current traditional system. They should view themselves as facilitators and educators, servants within a new spirit of economics. Whatever idealistic and philosophical views they may initiate there are many improvements that can be made over the current system. To reiterate, the



current writer's view is that they should seek to encourage saints, guide sinners, and restrain satans. The distribution of such personalities, in every society, follows a Bell Curve. There are few saints and few satans. Most of us are sinners. The curve can shift up or down some ideal spectrum line. If the society improves, the standard for being a saint will be higher. If the society becomes decadent (or continues in its present decadence) the standard of sainthood will be lower. The inverse is true of satanhood.

While economic sainthood is desirable, (defined by this writer as a willingness to devote one's life in complete service to God and others) one must realize that it will be rare. This station is not some merely abstract form of life where one is living on some spiritual high and not making any real economic contribution to society. The real saints enter the struggle of daily life and wrestle with problems of relative good and evil found in the market place. On the other extreme is the satan who seeks only his personal advantage, to the disadvantage of others. These too, under proper control can serve society. But the ideal remains those who are instrumental in producing great wealth, and then use those same talents in assuring that the wealth is used to the benefit of society.

It may be noted that, in what I shall call the prototype LETS systems of the past, there has been a philosophical objection to both interest and taxes. Theoretically and technically, neither is necessary in a LETS. There are other issues such as inheritance, transference (especially in the case of what are presently large corporations, but which this writer has proposed should be under the entitlement of individuals), and still other matters of entitlement that will have to be dealt with in actual experience.

## Some Imagined Examples

One of the first things that a LETS might do is to establish a Scavenging Store or Storehouse. Anyone may bring goods to the store and the LETS Administrators could appoint store management with the responsibility of either paying for the goods outright with LETS dollars or taking them on assignment. Goods could be inventoried or Dutch Auctioned to assure rapid turnover and reduce the space needed for inventory. In a Dutch auction the prices are repetitively reduced over some time period until they clear. Individual Entrepreneurs could use their Entitlements to acquire the goods and retail them for LETS dollars. The scavengers would then have been rewarded on a wholesale basis and the retailers would give value added by specializing in particular lines of products. Thus one might know and stock culinary tools and another children's clothing, just as we see in present day malls. Those seeking something would have the advantage of being able to find it in a specific location and having someone knowledgeable about the products to assist them. It is this type of creative entrepreneurial activity that creates efficiency and value.

Another activity that should be undertaken by LETS is to insure full employment. The LETS or the Administrators at the higher levels should be the employers of last resort. That is to say they should guarantee that everyone has a job. While it is their function to assure that tasks of social purpose, such as fire departments, are staffed with capable people at attractive rates, they should be able to find many social tasks, such as the removal of destruction and waste, that do not require a high level of skill. The latter can be filled, if necessary, at a somewhat lower wage rate, so that those accepting such employment will have incentive to independently find better employment.

The success, or current performance of an economy, can be measured by the FEWNESS of individuals willing to accept the guaranteed low paid positions. One of the major functions of the LETS and the higher level administrators is to educate the members of Groups in how to develop better opportunities and how to become self reliant and capable of managing economic activities on their own. Still, acceptance of guaranteed employment should not be denigrated and where there is a large demand for this type of employment that in itself is indicative that the overall economy is not functioning well.

At the other extreme, if there are too few participants in the offered guaranteed employment, it may be indicative that the higher levels of administration are creating too great a demand for labor resources by over utilizing the labor in activities that they pay directly. Opinion as to the degree to which direct or collective community goals should have priority over the independent entrepreneurial demand for resources is one that will have to be expressed through the collective process of consultation in the groups. Groups can directly express their opinions (but not as a decision) through resolutions publicly or privately directed to any level of administration. However, the power of decision would still remain with the appropriate administration.

With this approach, of workfare rather than welfare, there should be a much reduced need for welfare to those cases which are absolutely physically or emotionally handicapped to the point where they cannot function productively. Even those with severe handicaps should be provided opportunities to contribute to the society in what we presently call “sheltered workshops” because the ability to make positive contribution to society is a part of human dignity and a human right.

There are other extreme situations, such as sociopaths, with which a LETS and the higher levels may have to deal. In an affluent society, such as we have today, there may be the luxury of dealing with such persons in ways that require extensive and expensive use of society’s resources. During the reorganization of society that is recovering from societal cataclysm that luxury may not exist and the methods of dealing with such problems may seem very harsh by today’s standards. Technical details for the application of this principle will have to be left to the time and circumstance.

## Appendix

### The Principles of Group and LETS Organization

The LETS get their authority from the groups, who get their authority from the individual members of the groups. The problem of organizing and creating LETS is really one of organizing and creating the groups. There is no one way in which the groups must be formed but the following appears to me to be a practical way.

Individual groups can be formed in a variety of ways. Church groups. Neighborhood or village groups. Former employees of a large concern. Prior merchant and other associations. People known to each other

through sports clubs or almost any social organization where people have had, or have the desire to meet and cooperate together.

In practicality, in the process of recovery from a societal-cataclysmic situation, it may be necessary that the founders have access to any surviving stocks of food, fuel, or other necessities, and that they use these as the incentive to encourage organization and to establish the acceptance of debt and the creation of credit. Initial issuance's of entitlement may be relatively limited, but on the other hand, in some locales there may be a surfeit of capital resources or other factors of production that should be immediately employed through qualified entrepreneurs, and those individuals should be given the entitlements to do so.

## Group size

The founders of a LETS may designate the initial minimum and maximum acceptable group size. Some large organizations, such as a large church might provide several groups. Once the groups have formed and have designated their delegates, then the LETS administration can take over the founders' functions. Once a LETS is operating, there should be little difficulty in attracting additional members to the groups, and additional groups so as to support higher levels.

The remedy for alienation is active participation. The remedy for disenfranchisement is active participation. The path to entitlement is through active participation. The key to active participation is the size of the group. Too large a group and the individual is lost in the crowd. Too small a group and there is not sufficient dynamic. I recommend a group size of between 50 and 200. Any group over 100 should be allowed to autonomously split. Any group over 200 should be required to split.

## Group membership

LETS may form in locales where there is a remnant of the previous establishment. This can be beneficial or detrimental depending upon how flexible and amicable that remnant is to the establishment of a new way of doing things. Where there is outward opposition to the LETS, or the majority of the citizenry are psychologically attached to conformity to the established system, then there may be little likelihood of success for a LETS.

However, in those locales where LETS are involved in the reconstruction of society, from the ground up, then they may become the basis of general social organization and the group structure on which they are based will become the primary social structure. In that case every individual in the locale, over the age of 15, should be required to belong to a group. If they don't voluntarily join one of their choosing then they should be assigned to one by some level of administrators in the area.

Groups would be very autonomous over their own memberships. From the acceptance of individuals (except for those assigned to them) to their choice of internal rules. An individual can belong to only one group, but an individual may apply for membership to any group and an individual may apply to change

membership from one group to another group. Aside from assigned individuals - group administrators are free to create a group identity with regards to religion, sexual orientation, race, age or any other discrimination they wish.

There can be many groups that I would consider to have a high degree of dysfunctionality because of ignorance, superstition, religious customs, and other causes, but these variations appear in a free society and are even a part of free will. In the relative world there will always be a scale from the least functional to the most functional groups. Function itself, will certainly be defined in various ways by various groups. This variety, in my opinion, is not only something that is to be tolerated, but is something that should be appreciated.

## **Individual Rights and Responsibilities of group membership**

All group members shall have the right and responsibility to vote by secret ballot for group administrators, and to be voted for as a group administrator or delegate to the LETS at times designated by the LETS. Eventually, there should be some designated time for annual elections, and in the case of vacancies there should be by-elections within a designated length of time.

All group members shall have the right and responsibility to attend their group's general meetings and functions. There should be informative reporting available from every administrative level. The method of consultation is one that needs to be developed in a manner such that while there should be full and frank discussion on the reports. The meetings must be conducted with courtesy, and without rancor, and there should be the opportunity for everyone to participate.

All group members, age of fifteen and over, shall be assigned by the LETS a LETS identification number, and a limit of Entitlement in creating LETS dollars. Individuals who feel that their designated level of entitlement is inadequate should have the right to appeal to the LETS and if not satisfied there, to the higher administrative levels. In those areas where the LETS structure also provides the basic social structure the individual would also have the same right of appeal regarding any other administrative decisions.

## **Rights and Responsibilities of the Group**

To elect in Group meeting and by secret ballot 10 administrators at a time designated by the LETS. The recommended process of election is as follows: The members should be presented with a list of the names and numbers of all the members in the group. Each member should write down on a secret ballot the name and number of as many individuals as they wish to nominate for administrator. The ballots should be publicly tallied before the whole group and each person receiving one or more nominations should be placed on the ballot. Each nominated person should address the group up to a maximum time agreed upon by the group. Each member should write on a secret ballot the names of 10 different individuals from among those nominated. Any nominee receiving over 50% of the number of ballots cast shall be considered elected. The number of votes for the remaining candidates shall be announced, and

those receiving at least one vote on the previous ballot should be voted for in a new secret ballot cast for the remaining number of vacant positions. Again, any nominee receiving over 50% of the number of ballots cast shall be considered elected, and the process reiterated until all ten positions have been filled. While I have not gone into further detail, I do prefer an "open" counting of the ballots. Selecting tellers by lot, or some other suitable method would also be well, but as noted earlier, many of these details are left to the group, and the group may choose a whole different process than what I have described here.

To hold regular group meetings as scheduled by Group Administrators. I would recommend meeting at least weekly but these meetings can be held more or less frequently as the Group Administrators may decide.

To hold group consultation and make recommendations that are non-binding on the Group Administrators.

To execute collectively and individually decisions of the Group Administrators.

## **Rights and Responsibilities of the Group Administrators.**

To elect from among themselves a delegate to the LETS. The delegate can thereafter attend the Group Administrator meetings but will not have a vote. It is the responsibility of the delegate to communicate the views of the Group Administration to the LETS and LETS directives and views to the Group Administration.

To educate and encourage the members of the Group in taking advantage of the LETS.

To judge disputes among Group members.

To administer awards and punishments to Group members.

The degree to which the Group will be involved in social policies shall be determined by the Group.

## **The LETS**

The LETS is the ESSENTIAL level of the LETS structure.

----->The span of 7 to 15 is a revision made June 03, 2001 <-----

Each LETS shall be composed of 7 to 15 Groups. When a LETS with 15 Groups wishes to admit another group it must split into two separate LETS. LETS may voluntarily accept new Groups or have new Groups assigned to them by the next higher level.

The members of the LETS shall by secret ballot assign one of their members to the next higher administrative level.

The LETS shall assign ENTITLEMENT levels to individuals in its groups.

The LETS shall provide the mechanics of the trading system.

## Higher Administrative Levels

Each higher administrative level is comprised of 7 to 15 delegates consisting of one from each member of the immediately lower level. The number of members of each higher level is determined in the same manner as that for the lower levels. The flexibility of there being between 7 and 15 members at each level is a tolerance to permit the implementation, functioning, and replication at each level, through a process of natural growth, units of approximately the same size without being rigid about what comprises a functioning unit.

Each level selects by secret ballot one delegate to assign to the next higher level. That delegate can, and should, then continue to meet with the electing level to communicate to it information from the next higher level, but the delegate will no longer have a vote in the electing level.

## Summary of the Principles of Organization

The first principle is that of PARTICIPATION, in that those individuals at the lowest level, are few enough in number to be intimately acquainted with each other.

The second principle is that the Administration is selected directly by SECRET ballot, without influence or subterfuge.

The third principle is that the administrative officers are then independent in their decision making. They are supposed to be committed to universal justice rather than some element that voted for them.

At each level, the officers at that level select a delegate to the next higher level. This individual is NOT there to represent the group that elected them to the higher level, but to simply through consultation with the other officers at that level to determine that which is most beneficial and just.

In each case the rules, guidance and where necessary judgement, come from the next higher level. Also disputes can be resolved or appealed to the next higher level.

The degree that this structure intertwines with non-economic activities, will be dependent upon the degree to which other social institutions are available.

The overall social structure is in part the determiner of the economic system and the economic system is in part the determiner of the overall social structure. The two are so intertwined that it is impossible to divorce one from the other. It is for this reason that in describing the mechanics and examples of variations in using the LETS that we needed to discuss a sample governing structure.

I might have dealt with a great variety of issues. Such as the re-establishment of complicated industrial processes, the location and development of the necessary elements and talents for highly technical methods of production, and the need for the rationing of scarce resources. I will not belabor those subjects because at this point it would largely be just a matter of imaginative literature. What will be needed, when the reality arises, is creative and flexible response, unfettered by past convention, to deal with circumstances as they present themselves. What I have presented here is a structure, rather than detail, for how we may deal with those circumstances.

**MENU: [HOME](#) » [Reconstruction](#) » [Recovery](#) » [Renewal](#) » [Survival](#)**

---

---



Leonard E. Read

I, Pencil

My Family Tree as told to Leonard E. Read

Dec. 1958

[Help, Tips, Instructions](#)

[Search The Text](#)

[Cite This Page](#)

[Copyright Information](#)

[Introduction, by Milton Friedman](#)

[Afterword, by Donald J. Boudreaux](#)

## I, Pencil

### My Family Tree as told to Leonard E. Read

I am a lead pencil—the ordinary wooden pencil familiar to all boys and girls and adults who can read and write.\*

RP.1

Writing is both my vocation and my avocation; that's all I do.

RP.2

You may wonder why I should write a genealogy. Well, to begin with, my story is interesting. And, next, I am a mystery—more so than a tree or a sunset or even a flash of lightning. But, sadly, I am taken for granted by those who use me, as if I were a mere incident and without background. This supercilious attitude relegates me to the level of the commonplace. This is a species of the grievous error in which mankind cannot too long persist without peril. For, the wise G. K. Chesterton observed, "We are perishing for want of wonder, not for want of wonders."

RP.3

I, Pencil, simple though I appear to be, merit your wonder and awe, a claim I shall attempt to prove. In fact, if you can understand me—no, that's too much to ask of anyone—if you can become aware of the miraculousness which I symbolize, you can help save the freedom mankind is so unhappily losing. I have a profound lesson to teach. And I can teach this lesson better than can an automobile or an airplane or a mechanical dishwasher because—well, because I am seemingly so simple.

RP.4

Simple? Yet, *not a single person on the face of this earth knows how to make me.* This sounds fantastic, doesn't it? Especially when it is realized that there are about one and one-half billion of my kind produced in the U.S.A. each year.

RP.5



Pick me up and look me over. What do you see? Not much meets the eye—there's some wood, lacquer, the printed labeling, graphite lead, a bit of metal, and an eraser.

RP.6

## Innumerable Antecedents

Just as you cannot trace your family tree back very far, so is it impossible for me to name and explain all my antecedents. But I would like to suggest enough of them to impress upon you the richness and complexity of my background.

RP.7

My family tree begins with what in fact is a tree, a cedar of straight grain that grows in Northern California and Oregon. Now contemplate all the saws and trucks and rope and the countless other gear used in harvesting and carting the cedar logs to the railroad siding. Think of all the persons and the numberless skills that went into their fabrication: the mining of ore, the making of steel and its refinement into saws, axes, motors; the growing of hemp and bringing it through all the stages to heavy and strong rope; the logging camps with their beds and mess halls, the cookery and the raising of all the foods. Why, untold thousands of persons had a hand in every cup of coffee the loggers drink!

RP.8

The logs are shipped to a mill in San Leandro, California. Can you imagine the individuals who make flat cars and rails and railroad engines and who construct and install the communication systems incidental thereto? These legions are among my antecedents.

RP.9

Consider the millwork in San Leandro. The cedar logs are cut into small, pencil-length slats less than one-fourth of an inch in thickness. These are kiln dried and then tinted for the same reason women put rouge on their faces. People prefer that I look pretty, not a pallid white. The slats are waxed and kiln dried again. How many skills went into the making of the tint and the kilns, into supplying the heat, the light and power, the belts, motors, and all the other things a mill requires? Sweepers in the mill among my ancestors? Yes, and included are the men who poured the concrete for the dam of a Pacific Gas & Electric Company hydroplant which supplies the mill's power!

RP.10

Don't overlook the ancestors present and distant who have a hand in transporting sixty carloads of slats across the nation.

RP.11

Once in the pencil factory—\$4,000,000 in machinery and building, all capital accumulated by thrifty and saving parents of mine—each slat is given eight grooves by a complex machine, after which another machine lays leads in every other slat, applies glue, and places another slat atop—a lead sandwich, so to speak. Seven brothers and I are mechanically carved from this "wood-clinched" sandwich.

RP.12

My "lead" itself—it contains no lead at all—is complex. The graphite is mined in Ceylon. Consider these miners and those who make their many tools and the makers of the paper sacks in which the graphite is shipped and those who make the string that ties the sacks and those who put them aboard ships and those who make the ships. Even the lighthouse keepers along the way assisted in my birth—and the harbor pilots.

RP.13

The graphite is mixed with clay from Mississippi in which ammonium hydroxide is used in the refining process. Then wetting agents are added such as sulfonated tallow—animal fats chemically reacted with sulfuric acid. After passing through numerous machines, the mixture finally appears as endless extrusions—as from a sausage grinder-cut to size, dried, and baked for several hours at 1,850 degrees Fahrenheit. To increase their strength and smoothness the leads are then treated with a hot mixture which includes candelilla wax from Mexico, paraffin wax, and hydrogenated natural fats.

RP.14

My cedar receives six coats of lacquer. Do you know all the ingredients of lacquer? Who would think that the growers of castor beans and the refiners of castor oil are a part of it? They are. Why, even the processes by which the lacquer is made a beautiful yellow involve the skills of more persons than one can enumerate!

RP.15

Observe the labeling. That's a film formed by applying heat to carbon black mixed with resins. How do you make resins and what, pray, is carbon black?

RP.16

My bit of metal—the ferrule—is brass. Think of all the persons who mine zinc and copper and those who have the skills to make shiny sheet brass from these products of nature. Those black rings on my ferrule are black nickel. What is black nickel and how is it applied? The complete story of why the center of my ferrule has no black nickel on it would take pages to explain.

RP.17

Then there's my crowning glory, inelegantly referred to in the trade as "the plug," the part man uses to erase the errors he makes with me. An ingredient called "factice" is what does the erasing. It is a rubber-like product made by reacting rape-seed oil from the Dutch East Indies with sulfur chloride. Rubber, contrary to the common notion, is only for binding purposes. Then, too, there are numerous vulcanizing and accelerating agents. The pumice comes from Italy; and the pigment which gives "the plug" its color is cadmium sulfide.

RP.18

## No One Knows

Does anyone wish to challenge my earlier assertion that no single person on the face of this earth knows how to make me?

RP.19

Actually, millions of human beings have had a hand in my creation, no one of whom even knows more than a very few of the others. Now, you may say that I go too far in relating the picker of a coffee berry in far off Brazil and food growers elsewhere to my creation; that this is an extreme position. I shall stand by my claim. There isn't a single person in all these millions, including the president of the pencil company, who contributes more than a tiny, infinitesimal bit of know-how. From the standpoint of know-how the only difference between the miner of graphite in Ceylon and the logger in Oregon is in the *type* of know-how. Neither the miner nor the logger can be dispensed with, any more than can the chemist at the factory or the worker in the oil field—paraffin being a by-product of petroleum.

Here is an astounding fact: Neither the worker in the oil field nor the chemist nor the digger of graphite or clay nor any who mans or makes the ships or trains or trucks nor the one who runs the machine that does the knurling on my bit of metal nor the president of the company performs his singular task because he wants me. Each one wants me less, perhaps, than does a child in the first grade. Indeed, there are some among this vast multitude who never saw a pencil nor would they know how to use one. Their motivation is other than me. Perhaps it is something like this: Each of these millions sees that he can thus exchange his tiny know-how for the goods and services he needs or wants. I may or may not be among these items.

## No Master Mind

There is a fact still more astounding: the absence of a master mind, of anyone dictating or forcibly directing these countless actions which bring me into being. No trace of such a person can be found. Instead, we find the Invisible Hand at work. This is the mystery to which I earlier referred.

It has been said that "only God can make a tree." Why do we agree with this? Isn't it because we realize that we ourselves could not make one? Indeed, can we even describe a tree? We cannot, except in superficial terms. We can say, for instance, that a certain molecular configuration manifests itself as a tree. But what mind is there among men that could even record, let alone direct, the constant changes in molecules that transpire in the life span of a tree? Such a feat is utterly unthinkable!

I, Pencil, am a complex combination of miracles: a tree, zinc, copper, graphite, and so on. But to these miracles which manifest themselves in Nature an even more extraordinary miracle has been added: the configuration of creative human energies—millions of tiny know-hows configuring naturally and spontaneously in response to human necessity and desire and *in the absence of any human master-minding!* Since only God can make a tree, I insist that only God could make me. Man can no more direct these millions of know-hows to bring me into being than he can put molecules together to create a tree.

The above is what I meant when writing, "If you can become aware of the miraculousness which I symbolize, you can help save the freedom mankind is so unhappily losing." For, if one is aware that these know-hows will naturally, yes, automatically, arrange themselves into creative and productive patterns in response to human necessity and demand—that is, in the absence of governmental or any other coercive masterminding—then one will possess an absolutely essential ingredient for freedom: *a faith in free people*. Freedom is impossible without this faith.

Once government has had a monopoly of a creative activity such, for instance, as the delivery of the mails, most individuals will believe that the mails could not be efficiently delivered by men acting freely. And here is the reason: Each one acknowledges that he himself doesn't know how to do all the things incident to mail delivery. He also recognizes that no other individual could do it. These assumptions are correct. No individual possesses enough know-how to perform a nation's mail delivery any more than any individual possesses enough know-how to make a pencil. Now, in the absence of faith in free people—in the unawareness that millions of tiny know-hows would naturally and miraculously form and cooperate to satisfy this necessity—the individual cannot help but reach the erroneous conclusion that mail can be delivered only by governmental "master-minding."

## Testimony Galore

If I, Pencil, were the only item that could offer testimony on what men and women can accomplish when free to try, then those with little faith would have a fair case. However, there is testimony galore; it's all about us and on every hand. Mail delivery is exceedingly simple when compared, for instance, to the making of an automobile or a calculating machine or a grain combine or a milling machine or to tens of thousands of other things. Delivery? Why, in this area where men have been left free to try, they deliver the human voice around the world in less than one second; they deliver an event visually and in motion to any person's home when it is happening; they deliver 150 passengers from Seattle to Baltimore in less than four hours; they deliver gas from Texas to one's range or furnace in New York at unbelievably low rates and without subsidy; they deliver each four pounds of oil from the Persian Gulf to our Eastern Seaboard—halfway around the world—for less money than the government charges for delivering a one-ounce letter across the street!

The lesson I have to teach is this: *Leave all creative energies uninhibited*. Merely organize society to act in harmony with this lesson. Let society's legal apparatus remove all obstacles the best it can. Permit these creative know-hows freely to flow. Have faith that free men and women will respond to the Invisible Hand. This faith will be confirmed. I, Pencil, seemingly simple though I am, offer the miracle of my creation as testimony that this is a practical faith, as practical as the sun, the rain, a cedar tree, the good earth.

*Leonard E. Read (1898-1983) founded FEE in 1946 and served as its president until his death.*

*"I, Pencil," his most famous essay, was first published in the December 1958 issue of The Freeman. Although a few of the manufacturing details and place names have changed over the past forty years, the principles are unchanged.*

---

\* My official name is "Mongol 482." My many ingredients are assembled, fabricated, and finished by Eberhard Faber Pencil Company.

## Top of File

[Introduction, by Milton Friedman](#)

[Afterword, by Donald J. Boudreaux](#)

## Introduction,

by Milton Friedman

Leonard Read's delightful story, "I, Pencil," has become a classic, and deservedly so. I know of no other piece of literature that so succinctly, persuasively, and effectively illustrates the meaning of both Adam Smith's invisible hand—the possibility of cooperation without coercion—and Friedrich Hayek's emphasis on the importance of dispersed knowledge and the role of the price system in communicating information that "will make the individuals do the desirable things without anyone having to tell them what to do."

I.1

We used Leonard's story in our television show, "Free to Choose," and in the accompanying book of the same title to illustrate "the power of the market" (the title of both the first segment of the TV show and of chapter one of the book). We summarized the story and then went on to say:

I.2

"None of the thousands of persons involved in producing the pencil performed his task because he wanted a pencil. Some among them never saw a pencil and would not know what it is for. Each saw his work as a way to get the goods and services he wanted—goods and services we produced in order to get the pencil we wanted. Every time we go to the store and buy a pencil, we are exchanging a little bit of our services for the infinitesimal amount of services that each of the thousands contributed toward producing the pencil.

I.3

"It is even more astounding that the pencil was ever produced. No one sitting in a central office gave orders to these thousands of people. No military police enforced the orders that were not given. These people live in many lands, speak different languages, practice different religions, may even hate one another—yet none of these differences prevented them from cooperating to produce a pencil. How did it happen? Adam Smith gave us the answer two hundred years ago."

I.4

"I, Pencil" is a typical Leonard Read product: imaginative, simple yet subtle, breathing the love of freedom that imbued everything Leonard wrote or did. As in the rest of his work, he was not trying to tell people what to do or how to conduct themselves. He was simply trying to enhance individuals' understanding of themselves and of the system they live in.

I.5

That was his basic credo and one that he stuck to consistently during his long period of service to the public—not public service in the sense of government service. Whatever the pressure, he stuck to his guns, refusing to compromise his principles. That was why he was so effective in keeping alive, in the early days, and then spreading the basic idea that human freedom required private property, free competition, and severely limited government.

I.6

*Professor Friedman, the 1976 Nobel Prize in Economic Science, is Senior Research Fellow at the Hoover Institution, Stanford, California.*

I.7

[Top of File](#)

[Introduction, by Milton Friedman](#)

[Afterword, by Donald J. Boudreaux](#)

## Afterword,

by Donald J. Boudreaux

There are two kinds of thinking: simplistic and subtle. Simplistic thinkers cannot understand how complex and useful social orders arise from any source other than conscious planning by a purposeful mind. Subtle thinkers, in contrast, understand that individual actions often occur within settings that encourage individuals to coordinate their actions with one another independent of any overarching plan. F. A. Hayek called such unplanned but harmonious coordination "spontaneous order."

A.1

The mark of the subtle mind is not only its ability to grasp the idea of spontaneous orders but also to understand that conscious attempts to improve or to mimic these orders are doomed to fail. "Why so?" asks the simplistic thinker. "How can happenstance generate complex order superior to what a conscious mind can conceive and implement?" In responding to this question, a subtle thinker points out that spontaneous orders do not arise from happenstance: the continual adjustments by each individual within spontaneous orders follow a very strict logic—the logic of mutual accommodation. Because no central planner can possibly know all of the details of each individual's unique situation, no central planner can know how best to arrange each and every action of each and every individual with that of the multitudes of other individuals.

A.2

In the eighteenth century, a handful of scholars—most notably David Hume and Adam Smith—developed a subtle understanding of how private property rights encourage self-regarding producers and consumers to act in mutually beneficial ways. Spontaneous ordering forces were thus discovered, and with this discovery modern economics began to take shape.

A.3

Over the next two centuries economics achieved enormous success in furthering our understanding not only of industry and commerce, but of society itself. Modern economics—that is to say, economics that explores the emergence of spontaneous orders—is a sure-fire inoculant against the simplistic notion that conscious direction by the state can improve upon the pattern of mutual adjustments that people make within a system of secure private property rights.

A.4

But learning modern economics requires some effort—in the same way that breaking free of any simplistic mindset requires effort. It isn't surprising, then, that those economists who've contributed most to a widespread understanding of the subject have been clear and vivid writers, skillful in using analogies and everyday observations to lubricate the mind's transition away from superficial thinking and toward a grasp of subtle insights. The best economic writers cause oncesimplistic thinkers to say "Aha! *Now I get it!*" Skillfully tutored, a simplistic mind becomes a subtle mind.

A.5

For its sheer power to display in just a few pages the astounding fact that free markets successfully coordinate the actions of literally millions of people from around the world into a productive whole, nothing else written in economics compares to Leonard Read's celebrated essay, "I, Pencil." This essay's power derives from Read's drawing from such a prosaic item an undeniable, profound, and spectacular conclusion: it takes the knowledge of countless people to produce a single pencil. No newcomer to economics who reads "I, Pencil" can fail to have a simplistic belief in the superiority of central planning or regulation deeply shaken. If I could choose one essay or book that everyone in the world would read, I would unhesitatingly choose "I, Pencil." Among these readers, simplistic notions about the economy would be permanently transformed into a new and vastly more subtle—and correct—understanding.

A.6

—DONALD J. BOUDREAUX

April 1998

**Top of File**

[Introduction, by Milton Friedman](#)

[Afterword, by Donald J. Boudreaux](#)

---

Copyright ©: 2000, [Liberty Fund](#), design, art, and coding.

Content: Copyright ©: 1999. [Foundation for Economic Education \(FEE\)](#). (Second printing, August 1999.) The Library of Economics and Liberty is grateful to FEE for permission to produce this essay in electronic form.

[Citation Generator for this page](#)

The cuneiform inscription in the logo is the earliest-known written appearance of the word "freedom" (amagi), or "liberty." It is taken from a clay document written about 2300 B.C. in the Sumerian city-state of [Lagash](#).

Border art based on [Celtic Web Art](#), ©: 1997-1999 by Karen Nicholas.

Title font is AuBauer Text Initials from [Font Addict](#).

The URL for this site is: <http://www.econlib.org/> Please direct questions or comments about the website to <mailto:%20webmaster@econlib.org>

---

**MENU: [HOME](#) » [Reconstruction](#) » [Recovery](#) » [Renewal](#) » [Survival](#)**

---



# A Baha'i's Perspective on The Gospel of Wealth

[bruce@webpal.org](mailto:bruce@webpal.org)

[Bruce M. Beach](#)

---

## *Prolog*

**There comes a time in the thread of civilization when it is necessary to re-examine and reconstruct its institutions. Such a time is fast approaching when the present thread of civilization will have snapped in a world-wide catastrophe. The mountains on the present landscape of civilization consisting of anarchistic national governments, gigantic international soulless corporations, beyond huge resource gobbling militaries, power hungry political systems of self-interest, secret consortiums of financial affluence and influence, dogmatic and fanatic movements of religion, unjust legal systems based upon archaic statements of law that perpetually let the wealthy go free and are unaffordable by the poor, media and educational systems that propagandize the missions of the establishments, no matter in what part of the world they**

**may be - these and many other ills and immoralities of the present society will have been momentarily crushed to dust in the face of the catastrophe. Such catastrophe demonstrates the necessity of restoring civilization on a basis that will remove the seeds of its own destruction and prevent the reoccurrence of that which will have just occurred.**

**The study presented here consists of three strands of dialog for bringing forth a new thread of civilization. First there is the practical advice of a man recognized to be one of the most successful businessmen and the greatest philanthropist the world has ever known. Secondly there is the organization of the presentation by a trained institutional economist. And thirdly, and most importantly, there is the philosophical and moral underpinnings of a recognized Prophet to this day and age.**

### *Dialog*

These web pages are meant to be a dialog. Those who are willing to participate are invited to do so by writing to Bruce Beach at the above email address. Appropriate critiques, comments and contributions will be embodied in future uploads of the page to the Internet. It will be appreciated if all contributors will boldly state, as I have, as to who are their lights of guidance.

### *History of this Web Site*

Some decades ago, I first read mention of Carnegie's *The Gospel of Wealth*, (first printed as a complete volume in 1900) and now referenced in *Selections from the Writings of 'Abdu'l-Bahá* (compiled by the

Research Department of the Universal House of Justice, Baha'i World Centre, Haifa - printed in Great Britain by W & J Mackay Limited, Chatham 1978). It was several years later that I managed to acquire through a rare book source a copy of the then out of print, "*The Gospel of Wealth and Other Timely Essays* by Andrew Carnegie", edited by Edward C. Kirkland and published by The Belknap Press of Harvard University Press in 1962.

As one trained in Institutional Economics I was greatly impressed with the work and it was my desire to make the work more readily known and available to others who, after coming across the reference by 'Abdu'l-Bahá, might be similarly interested. For many years this has remained on my list of things to do. Recently, with the popularity of the Internet, family and friends hearing me mention the work, asked why I did not put it on the Internet. This struck me as an excellent suggestion and my son and wife started the process of scanning in my copy for me.

Amidst this activity, and some arduous editing and repair, (my copy having been severely underlined by the original owner) my wife asked me if the book were not already on the Internet. Until this point I had neglected to search and mind my astonishment that I found many hundreds of references. I spent many hours checking them all and while I found many copies of the first half of "The Gospel of Wealth" essay, I did not find either that complete essay or any of the other dozen essays in the work. I therefore decided to proceed and to put the complete work on the Internet.

As a contemporary work, in the time of 'Abdu'l-Bahá, the book and essays were quite well known. In the interim it became so obscure that I could not find a reference in the public library, but now once again it has amazingly returned to some considerable popularity, at least in a certain venue of college courses. I can only say that I am most gratified.

More than merely increasing the availability of this work and encouraging its occasional reading, it is my goal to use it as a vehicle to develop a dialog regarding Baha'i Principles of Economics.

### *Andrew Carnegie*

Andrew Carnegie (1835-1919), was considered in his day as being the richest man in America, if not the world. He has also been recognized as one of the leading philanthropists that the world has ever known, although he has not been universally admired for this quality by some socialists and others.

*"No one ever considered Carnegie libraries steeped in the blood of the Homestead steelworkers, but they are. We do not remember that the Rockefeller Foundation is founded on the dead miners of the Colorado Fuel and Iron Company and a dozen other performances."*

Harry Truman, 1937 speech to the Senate.

I am a great admirer of "Give 'em hell, Harry", who always called them - as he saw them. Many of the modern day university courses treat the "Wealth of Nations", as an example of Social Darwinism

(usually considered an epithet). Names and titles and opinions of other's aside, it should be our purpose to examine, as openly and as honestly as we can, the ideas expressed therein.

While I now have in my library other books by and about Andrew Carnegie, I shall not belabor a biography here, other than the [chronology](#) included with the the source edition, but will allow the interested reader to seek such information elsewhere. However, to enliven the atmosphere, I will share one anecdote.

Andrew Carnegie was a generous supporter of the New York Philharmonic Society, meeting its annual deficits in its early years. One year the society's secretary came as usual to Carnegie's mansion, this time requesting \$60,000. Carnegie was just about to sign the check when he paused and said, "No, I've changed my mind. Surely there are other people who like music enough to help with their own money." He then told the secretary to go out and raise half the necessary amount, promising to match it with the other half when this had been done.

The following day the secretary was back at the Carnegie mansion, announcing that he had raised the requisite money. Carnegie commended the man's enterprise and wrote out and signed his check for \$30,000. As he handed it over he said, "Would you mind telling me who gave you the other half?" "Not at all. Mrs. Carnegie."

### *The Baha'i Connection to the Work*

Andrew Carnegie actually met 'Abdu'l-Bahá in America in 1912 and gave two copies of his publications to 'Abdu'l-Bahá. Since the "The Gospel of Wealth and Other Timely Essays" was published in 1900, it is quite possible (I would think probable) that the original version of the entire book presented here, were among the works give by Andrew Carnegie to 'Abdu'l-Bahá. Whether this was before or after the famous quote, by 'Abdu'l-Bahá, I do not know, and have not been sufficiently historically inclined to seek the answer out. There are numerous other ways in which 'Abdu'l-Bahá, might have seen the essays because they were widely printed at the time, in a variety of sources. The original letter from 'Abdu'l-Bahá (the date of which I have not been able to determine), is reported to still be extant in the Carnegie Trust in the town of Dunfermline, which was the ancient capital of Scotland.

### *The Famous Quote as from Selections From the Writings of `Abdu'l-Bahá pp114-115*

*O respected personage! I have read your work "The Gospel of Wealth" and noted therein truly apposite and sound recommendations for easing the lot of humankind.*

*To state the matter briefly, the Teachings of Bahá'u'lláh advocate voluntary sharing, and this is a greater thing than the equalization of wealth. For equalization must be imposed*

*from without, while sharing is a matter of free choice.*

*Man reacheth perfection through good deeds, voluntarily performed, not through good deeds, the doing of which was forced upon him. And sharing is a personally chosen righteous act: that is, the rich should expend their substance for the poor, but of their own free will, and not because the poor have attained this end through force. For the harvest of force is turmoil and the ruin of social order. On the other hand, voluntary sharing, the freely-chosen expending of one's substance, leadeth to society's comfort and peace. It lighteth up the world: It bestoweth honour upon humankind.*

*I have seen the good effects of your own philanthropy in America, in various universities, peace gatherings and associations for the promotion of learning, as I travelled from city to city. Wherefore do I pray on your behalf that you shall ever be encompassed by the bounties and blessings of heaven, and shall perform many philanthropic deeds in the East and West. Thus may you gleam as a lighted taper in the Kingdom of God, may attain honour and everlasting life, and shine out as a bright star on the horizon of eternity.*

There has been sent to me from Baha'i sources, a further reference reference regarding Carnegie.

"Star of the West" IX:3, 28 April 1918, page 35:

*'Abdu'l-Bahá said: "His aim is good and a service to the world of humanity. O how I wish that all of the leaders of the people would spend their energy for unity and peace among all nations and sects!" At that moment, letters and newspapers arrived from the occident and Persia, bearing the glad-tidings of the harmony and purpose of the believers in teaching the Cause. 'Abdu'l-Bahá became exceedingly happy and prayed for confirmation from the Kingdom of Abhá and for the protection of the believers. He said: "They must step with steadfast feet into this field and must think of naught else save the unity of the people and the elevation of the Word of God."*

### ***The Work At Hand***

Without further ado then - I shall leave the reader to the original baker's dozen essays. At the time of this update, and since my initial statement here, Bruce Barrick has thoroughly edited all the essays for scanning errors and Bob Haugen has provided annotation for about half of the essays.

With the help of you the reader, I hope to enlarge upon what has been done here, for all the essays. The paragraphs were not numbered in the original, but I have numbered them here for your ease in making commentary. Your help in this sizable project will be greatly appreciated.

Go to:

[Table of Contents](#)

or

[The Gospel of Wealth \(The Problem of Administration of Wealth\)](#)

(the main essay most often quoted)

**MENU:** [HOME](#) » [Reconstruction](#) » [Recovery](#) » [Renewal](#) » [Gospel Content](#)

---

---

## THE GOSPEL OF WEALTH AND OTHER TIMELY ESSAYS

---Page xxii. The Gospel of Wealth - Editor's Introduction---

### Chronology of Carnegie's Life

1835 Born November 25 at Dunfermline, Scotland, son of Margaret (Morrison) and William Carnegie.

1848 Brought to the United States. Family settled in Allegheny, Pennsylvania.  
Began work immediately as bobbin-boy in cotton factory.

1849 First messenger, then operator at Pittsburgh telegraph office.

1853 Position with Pennsylvania Railroad.

1861 Accompanied Scott to Washington at outbreak of Civil War.

1865 Resigned from railroad to organize own firm, Keystone Bridge Company.

1873 Travel to Europe and association with British steel makers, especially Bessemer. Began concentration on steel here.

1882 Joined forces with Henry Clay Frick, acquiring vast coke properties.

1883 Published *An American Four-in-Hand* in Britain. Began contributions to magazines, notably *North American Review* and *Nineteenth Century*.

1886 Published *Triumphant Democracy*.

1887 Married Louise Whitfield.

1889 "Wealth" published in *North American Review*.

1892 Break with Frick; Homestead Strike.

1901 Sold out to United States Steel. Gave \$5,000,000 to employees for pension and benefit fund. Began major philanthropies.

1907 Built Peace Palace at The Hague.

1919 August 11, died at "Shadowbrook," in Massachusetts.

**MENU:** [HOME](#) » [Reconstruction](#) » [Gospel Content](#) » [Gospel Purpose](#)

---

---



# The Gospel of Wealth

## And Other Timely Essays

by Andrew Carnegie

**Bruce Barick did a super job  
of proof-reading all the essays!**

As of:

February 24th, 2002

nine of the thirteen essays have been annotated -  
**by Bob Haugen and David Jensen.**

Additional help in annotating would be appreciated. All you need to help is a Baha'i reference program like [Ocean](#). If you are willing to help please write to: [Bruce Beach](#)

### CONTENTS

[Purpose by Bruce Beach](#)

[Introduction \(to the John Harvard Library edition\) by Edward C. Kirkland](#)

With A Note on the Text

[Chronology of Carnegie's Life](#)

[I Introduction: How I served My Apprenticeship](#)

(Annotated by Bob Haugen)

II The Gospel of Wealth

[PART I: THE PROBLEM OF THE ADMINISTRATION OF WEALTH](#)

(Annotated by Bob Haugen)

[PART II: THE BEST FIELDS FOR PHILANTHROPY](#)

(Annotated by Bob Haugen)

[III The Advantages of Poverty](#)

(being Annotated by Bob Haugen)

[IV Popular Illusions about Trusts](#)

**(Annotated by Bob Haugen)**

[V An Employer's View of the Labor Question](#)

[VI Results of the Labor Struggle](#)

**(Annotated by Bob Haugen)**

[VII Distant Possessions: The Parting of the Ways](#)

VIII Americanism versus Imperialism

[Part I](#) **(Annotated by David Jensen)**

[Part II](#) **(Annotated by David Jensen)**

[IX Democracy in England](#)

[X Home Rule in America](#)

**(Annotated by Bob Haugen)**

[XI Does America Hate England?](#)

**(Annotated by Bob Haugen)**

[XII Imperial Federation](#)

**MENU: [HOME](#) » [Reconstruction](#) » [Gospel Content](#) » [Gospel Purpose](#)**

---

# The Gospel of Wealth

And Other Timely Essays

by Andrew Carnegie

**In the right-hand commentary column,  
that which is in GREEN is a commentator's remark and  
that which is in BLUE is from the Baha'i Writings.**

**On occasion, in that column, there may be a [link](#) to an extended comment or  
dissertation on the subject under discussion.**

- -

***A reminder that under "view" on your browser - you can set the text size UP  
or DOWN for a more comfortable read for yourself.***

---Page vii. The Gospel of Wealth - Editor's Introduction---

## Editor's Introduction

1. FEW men wanted more intensely to win than Andrew Carnegie; none was more certain his destiny was success. In 1868, at the age of thirty-three, he wrote in a famous introspective note a sentence of self-analysis: "Whatever I engage in I must push inordinately." Thirty years later he was trumpeting his triumphs in golf. "I am beating my friends at golf so all goes well. I played eighteen holes today with Taylor. Beat him. Beat Murray Butler Saturday. Beat Franks the day before."

[Baha'i Comment](#)

2. Though he occasionally expressed a misgiving about success in business, his most genuine, his greatest achievement was as a businessman. The autobiographical fragment, hereafter published as the first essay, is correct in describing the Carnegie family's migration from Scotland when Andrew was young and his start in this country at the bottom of the industrial ladder. Later he found employment on the Pennsylvania Railroad and rose from telegrapher to a divisional superintendent. Meanwhile he was acquiring a fortune by saving and borrowing money and investing it in railroads and in firms supplying railroad equipment, in petroleum, and in various iron works. By 1868, when he penned the note already cited, he could expect an annual income of \$50,000. Still pushing "inordinately," he transferred in the seventies his abilities and wealth to metallurgy. A business principle guided him: "Put all your eggs in one basket, and then watch that basket," and the financial strains of the panic of 1873 compelled him to concentrate his funds if he were to complete and operate The Edgar Thomson Steel Works near Pittsburgh. The plant

[Baha'i Comment](#)

made steel in Bessemer converters.

---Page viii. The Gospel of Wealth - Editor's Introduction--

-

Though Carnegie was not the leader who introduced this revolutionary process to America, he was among the first to employ it on a large scale. In the years which followed he acquired coal and iron-ore properties and built mills to manufacture finished steel products. By the nineties Carnegie's was the most advanced and the most powerful unit in the American steel and iron industry. At the end of the century he sold out to the financiers and industrialists who were putting together the United States Steel Corporation. In 1901 after the sale he had a fortune of about \$300,000,000.

3. Though he retired from business, he did not disown it. Instead of being its apologist, at a time when critics and reformers were detecting and exposing its flaws, he remained its celebrant. As he informed the undergraduates of Cornell University, "I can confidently recommend to you the business career as one in which there is abundant room for the exercise of man's

[Baha'i Comment](#)

highest power, and of every good quality in human nature. I believe the career of the great merchant, or banker, or captain of industry, to be favourable to the development of the powers of the mind, and to the ripening of the judgment upon a wide range of general subjects; to freedom from prejudice, and to the keeping of an open mind.... If without sound, all-round judgment, he must fail. The business career is thus a stern school of all the virtues...." Commendation of this sort was, however, reserved for businessmen of a certain definition. "A man to be in business must be at least part owner of the enterprise which he manages," and be "chiefly dependent for his revenues upon its profits." "The business man, pure and simple plunges into and tosses upon the waves of human affairs without a life-preserver in the shape of salary; he risks all. ... The business man pursues fortune." This attitude set Carnegie a little apart from the business currents of his period. At a time when business was increasingly professionalized and bureaucratized, he excluded from the ranks of businessmen all salary receivers; when businessmen were

---Page ix. The Gospel of  
Wealth - Editor's Introduction--

-

consolidating their organizations into trusts, holding companies, and corporations, Carnegie remained the anarchic individualist, a reluctant participator in pools and agreements and a man who held his big business within the confines of the partnership form of organization until the nineties. But these anachronisms, if such they were, delighted Carnegie. In so far as they made him unique, they tickled his vanity.

4. Carnegie was fundamentally different, too, in his realization that there were in the world other values than those of a business culture and other goals than that of business success. His background mostly explained this. Radicals who admired the French Revolution and eloquently cursed social inequality and the unjust operation of the economy clustered along both sides of Carnegie's family tree. Indeed one of Andrew's uncles had been arrested for sedition after delivering a lecture on Chartism. For by this time the family's reforming impulse had channelized into

[Baha'i Comment](#)

supporting the political reform program which the working class had stated in the People's Charter. This document demanded universal manhood suffrage, voting by ballot, abolition of property qualifications for membership in Parliament and salaries for members, annual Parliaments, and equal electoral districts. Chartism, however, had fizzled out in 1848. But the circumstances which drove Andrew's immediate family to migrate to this country in that year were economic rather than political.

5. Whether defeated or not, a career of agitation developed in the Carnegies an ability at exposition, discussion, argument, public address, and newspaper writing. They were devoted to books. One ancestor, indeed, was nicknamed "Professor" and Carnegie's father was "an awfu' man to read." Carnegie never shook off this inheritance. Perhaps the Scottish admiration for the things of the mind and of the spirit reinforced the family's learned tradition. Nonetheless he was not sure later that the professions had as desirable an

---Page x. The Gospel of Wealth - Editor's Introduction--

-

[Baha'i Comment](#)



effect upon their practitioners as did business. The professional mind, occupied with fame rather than dollar getting, was "clear but narrow."

6. Yet it would be a mistake to ascribe Carnegie's non-business interests and concerns solely to a family or national background. Carnegie liked to be different. In business he loved to depart from the traditional paths of the ironmasters, "Fathers-in-Israel," as he derisively christened them. One of his favorite exhortations to young men was "Attract attention." He followed his own advice. At a time when such businessmen as John D. Rockefeller and Elbert H. Gary (1846-1927) were supposed to be without an intellectual attainment larger than the ability to lead a Sunday-school class, he was the friend of literary men, those characteristically successful like Mark Twain and Richard Watson Gilder (1844-1909) of the Century, who acted as a recruiter of the "gods" of the literary world that attended Carnegie's "literary dinners" at his home on upper Fifth Avenue. Carnegie loved to drop names - "My dear friend, Matthew Arnold," - and hobnob with college presidents and statesmen,

[Baha'i Comment](#)

particularly if British. In one mail he received letters from Gladstone, Spencer, and John Morley. "I am quite set up as no other can say this." There was a strong streak of the show-off in Carnegie; he sought to startle and perplex. This trait, combined with the fact that his attitudes were often formulated for an occasion, prevented his thought from attaining system or consistency. It was often contradictory and impish.

7. Nonetheless, the essays in this volume reveal certain underlying patterns of thought. The details, of course, were not all Carnegie's own. In the post-Civil War years books rather than preachers frequently converted American businessmen and made the tangle and perplexity of this world literally clear to them. Edward Atkinson (1827-1905), New England cotton manufacturer, insurance man and publicist, one of the most perceptive commentators on America's economic structure in the post-Civil War era, owed his intellectual emanci-

---Page xi. The Gospel of Wealth - Editor's Introduction--

pation to Carlyle's *Sartor Resartus*. Charles Francis

[Baha'i Comment](#)

Adams, Jr. (1835-1915), later President of the Union Pacific Railroad, found his road to Damascus in England when in 1865 he read John Stuart Mill's essay on Auguste Comte, which "revolutionized in a single morning my whole mental attitude." Andrew Carnegie records in his Autobiography how he chanced to read Darwin and certain works of Herbert Spencer. "I remember that light came as in a flood and all was clear. Not only had I got rid of theology and the supernatural, but I had found the truth of evolution. 'All is well since all grows better' became my motto, my true source of comfort." Carnegie became one of Spencer's greatest American friends and through a lifetime of association showered him with kindnesses and admiration. Over the years in book and essay Spencer wrote on many topics; whether Carnegie was acquainted with the whole body of Spencer's work or was influenced by it at every point it is quite impossible to tell. A discussion in the second of these essays, "The Problem of Wealth," uses Spencerian-Darwinian phrases and concepts to justify the regime of competition. But long before the "survival of the fittest" gained fashionable currency in the vocabulary of

business and other men, it was believed that the race and prizes belonged to the swift. Carnegie was as apt to quote the biblical parable of the talents as a justification for wealth as to cite evolution, and it is notable that his original acknowledgment of Spencerian influence was in religious and theological matters. Actually his secularism and skepticism, uncharacteristic of his business generation, owed quite as much to the beliefs of his immediate forebears as they did to natural and social science.

8. With his family background of Chartist reform it was not surprising that Carnegie was a passionate believer in democracy. Almost as soon as he reached the United States he was writing back to the homeland that he had found the fulfillment of his dreams - no royal family, no aristocracy, no established church. "We have the Charter which you have

---Page xii. The Gospel of Wealth - Editor's Introduction--

-

been fighting for for years as the Panacea for all Britain's woes." In 1886 he wrote *Triumphant Democracy*, as extravagant an example of

[Baha'i Comment](#)

booster or promotional literature as was ever penned by a public relations expert. In words which are touching for their sincerity and simplicity he dedicated the volume "To the Beloved Republic, under whose Equal Laws I am made the peer of any man, although denied political equality by my native land." Like his definition of the businessman, this statement is as remarkable for its emphasis as for its omissions. Its stress is social and political; its "equality" is political equality. On another occasion he defined democracy as not meaning "equality of conditions, physical or mental, or equality as to property. It does mean political equality and the equality of opportunity."

9. On nearly every count this was exactly the creed of American business in the decades of the late nineteenth century. Though there were doubters among them, American businessmen, even sophisticated ones, accepted the open-ended character of American society and its institutions -- universal manhood suffrage, the free public school, the right of the laborer to choose his occupation and of the receiver of income, whether of salary, wages, or profits, to spend it

[Baha'i Comment](#)

as he chose. These were the cornerstones of the faith of a generation which, like Carnegie, was exceptionally sanguine, self-reliant and masculine. In some respects Carnegie carried the creed to more logical and more extreme positions than his business contemporaries. Most of them would hardly have seconded his approval of labor organization as an expression of self-reliance and as commendable striving by associated individuals for self-betterment. Carnegie here spoke for himself and a powerful minority of businessmen. If it had not been for these dissenters among employers, the task of labor unions would have been even more onerous.

10. *Triumphant Democracy* was more than an effusive love letter to the United States; it recommended a good example which England might well imitate. For one of Carnegie's

---Page xiii. The Gospel of Wealth - Editor's Introduction--

-

boyhood dreams had been "to grow up to kill a king" and, more soberly, to transform Britain into a republic. In the early eighties he purchased a string of newspapers in Great

[Baha'i Comment](#)

Britain and through them and in other ways began to push his campaign. By the middle of the decade his movement petered out, failing to topple the House of Lords or abolish the monarchy and other traces of political privilege. Triumphant Democracy was therefore not an opening salvo but a valedictory. The theme of transforming Britain remained, however, a persistent one - if only wistfully. In 1890 Carnegie was writing to William Ewart Gladstone about the comforts and conveniences of the Pennsylvania Limited -- "all of them free of charge" - between Chicago and New York. He concluded his letter, "What a quickening of the British mind we may get when the British Republic comes."

11. Though turned back from ultimate objectives, Carnegie maintained a deep interest in the course of British domestic politics, as the last four essays in this volume demonstrate. He was on friendly terms with English statesmen and did not refrain from lecturing or instructing them-and frequently baffling them. The body of British political doctrine that most appealed to him was Gladstonian liberalism. Its evangelical overtones must have left him cold, but in the later part of

[Baha'i Comment](#)

his career Gladstone at least supported the broadening of the suffrage and a series of measures culminating in Home Rule to allay or remove the age-old bitterness between Ireland and England. Of course the Carnegie-Gladstone relationship was not based solely upon the mutuality of political outlook. Gladstone was a success, a person who counted; for him Carnegie's admiration approached the idolatrous. When Gladstone commented in print on *The Gospel of Wealth*, the happy author wrote, "It seems like a dream that you who was to the little Scotch lad, something beyond human - should be attracted by anything he has promulgated and that he should really know you in the flesh. Always with reverence, Andrew Carnegie." Other leading

---Page xiv. *The Gospel of Wealth* - Editor's Introduction--

-

British exponents of liberalism, Lord Rosebery (1847-1929), for example, he tried to turn in a Gladstonian direction.



12. With a "native land" on one side of the Atlantic and an "adopted country" on the other, Carnegie perforce went beyond mere nationalism. We reinforced this dualism by taking long annual vacations in England and Scotland, the "fairyland," either in coach-and-four or on Scottish estates. Eventually he became the owner of Skibo, an estate of 30,000 acres and a castle with American improvements. At its flag-staff flew "the United flag ... the Stars and Stripes and the Union Jack sewn together - the first of that kind of flag ever seen." Carnegie was naturally the apostle of a federation of England and the United States (in which the more numerous American inhabitants would outvote their transatlantic cousins), and of the annexation of Canada.

[Baha'i Comment](#)

13. "I tell you," he wrote in 1898, "that race is the potent factor." His letters are replete with references to "The Race" or "Our Race." If he wanted a rationalization for the Anglo-Saxon supremacy which was largely instinctive with him, the context of his times would have provided it. The pastor and the professor alike were bursting from their studies to proclaim the glad tidings that the Teutonic or Anglo-Saxon races were "the political

[Baha'i Comment](#)

nations par excellence" and were authorized "in the economy of the world to assume the leadership in the establishment and administration of states." Of such moonshine the logical corollary was imperialism, and Admiral Alfred Thayer Mahan (1840-1914) in his discussions of sea power and historical greatness (*The Influence of Sea Power upon History*, 1890) became its spokesman. But Carnegie had too much common sense; he pulled back. Though the Spanish-American War gave the possibility of realizing imperial visions, such a program appalled Carnegie as a defiance of American principles. Two essays, "Distant Possessions" and "Americanism versus Imperialism," state his reservations to racism thus operating. He joined with other Americans to forestall a peace treaty consummating

---Page xv. *The Gospel of Wealth* - Editor's Introduction--

-

this betrayal, he helped finance the Anti-Imperialist League, and he tried to influence public men with such zeal as to elicit from one of them the observation that "Andrew Carnegie seems to be off his head." In 1900,

however, he refused to finance a third party movement against William McKinley. The ineptitude of this proposal is perhaps enough to justify Carnegie's decision, but his withdrawal question whether, as in his campaign for a British Republic he was genuinely interested in following through reforms which were not a success in the short run.

14. Of course he could elevate a specific issue to a broader basis. He could take comfort for the failure of his British campaign in the thought of an Anglo-Saxon, English speaking federation and the consequent democratic political changes forced upon his native land. For the failure of federation to materialize and for the collapse of true Americanism, perhaps a campaign for world peace through some other devices could be some counterweight. Soon after his arrival as a youth in this country he wrote an essay against the Crimean War in which he maintained that the machines of war deserve the execration given to the scaffold or guillotine. Later he was drawn into the Peace Society of Great Britain and he dates from the late eighties his preoccupation with the abolition of war. At first he was apparently sanguine

[Baha'i Comment](#)

enough to believe a hatred of war was enough to abolish it; later he saw in arbitration an alternative to conflict.

Eventually Carnegie financed at the construction at The Hague of a "Temple of Peace - the most holy building in the world because it has the holiest end in view. I do not even except St. Peter's or any other building erected to the Glory of God..." And in 1910 he gave \$10,000,000 for the Carnegie endowment for International Peace.

Carnegie's commitment to the peace movement had the incidental advantages of personal association with statesmen and scholars at international conferences to which he was frequently appointed a delegate and of the award of foreign decorations.

---Page xvi. The Gospel of Wealth - Editor's Introduction--

-

15. In the area of war and peace Carnegie was not a deviant from the accepted canon of business thought. In the writings of the business press and of businessmen few themes are more frequent and more persistent than the realization that America's position and policy by conducting to peace gave the nation an immense competitive advantage. It avoided the wasteful expenditure of public funds on armament and the crushing burden of high taxes; it directed our manpower to production rather than military purposes. On the contrary, our European competitors had to shoulder these burdens much to our advantage. War upset the rationality and order which business was trying to introduce into economic operations.

[Baha'i Comment](#)

16. As I have indicated, it is impossible to treat Carnegie's non-business interests without mentioning his benefactions. The most significant essays in this volume are those which contribute its title. The philosophy there set forth had been succinctly anticipated in 1868 in Carnegie's famous memorandum to himself: "Beyond this [\$50,000 a year] never earn -make no effort to increase fortune, but spend

[Baha'i Comment](#)

the surplus each year for benevolent purposes.... Man must have an idol - the amassing of wealth is one of the worst species of idolatry - no idol more debasing than the worship of money. To continue much longer ... with most of my thoughts wholly upon the way to make more money in the shortest possible time, must degrade me beyond hopes of permanent recovery." As a declaration of personal allegiance to a program this avowal and the later "Gospel of Wealth" are revealing. But historically they have little novelty. For centuries Christ had exalted and consecrated individual generosity and benevolence; charity was a Christian virtue and Christ had answered the rich young\_ man's question, "What shall I do to inherit eternal life?" by the directive, "Sell all that thou hast and distribute unto the poor." Through the ages men and women had followed an ideal of the Christian stewardship of wealth.

---Page xvii. The Gospel of Wealth - Editor's Introduction--

-

17. That Carnegie should take this path was startling, for his tone had been secular, and he believed there was truth in all religions. Since clerics have a keen scent for heresy and a sharp eye for danger, the hostility or moderation with which they greeted Carnegie's "Gospel of Wealth" had significance. While granting that his statement was "interesting," they generally went on to celebrate the virtues and achievements of Christian charity or wandered off into irrelevancies like the tariff. One eminent Methodist divine in England chose to discuss the "Gospel of Wealth" as a therapy for social ills -- Carnegie had certainly invited discussion on this level and concluded that a millionaire of the Carnegie class was "an anti-christian phenomenon, a social monstrosity, and a grave political peril!" To grant that Carnegie contributed a secular tone to giving is not to assert that he was a pioneer in this respect. In America the note goes back at least Franklin; and Stephen Girard, another Philadelphian, had in his endowment for Girard College expressly stipulated "no ecclesiastic, missionary, or minister of any sort

[Baha'i Comment](#)

whatever, shall ever hold or exercise any station or duty whatever in the said College; nor shall any such person be admitted for any purpose, or as a visitor, within the premises appropriated to the purposes of the said College.”

18. While it has been demonstrated that American public opinion expected rich men to give at least part of their fortunes for public purposes, it did not follow that such generosity was a path to popularity. Carnegie did not find it so. When he first, offered Pittsburgh \$250,000 for a library building, the City Council rejected it. Later, when the City changed its mind, Carnegie gave \$1,000,000 and went on to give, as well as a library, an art museum and music hall. Smaller places showed the same reluctance to accept a Carnegie gift. It was said he insisted that the building bear his name; this was untrue. Others apparently suspected that acceptance was an endorsement of the methods by which Carnegie had acquired his fortune. A more important and

---Page xviii. The Gospel of Wealth - Editor's Introduction---

-

concrete objection was

[Baha'i Comment](#)



Carnegie's insistence that communities appropriate an amount, usually a percentage of his gift, for the support of the buildings he gave them; communities bristled at dictation from the steel king. Nor did Carnegie find it easy to dispense his fortune wisely. Begging letters poured in by the thousands. For his benefactions Carnegie sought out expert advisors; in the field of education the presidents of Cornell and Johns Hopkins played this role. In cases he handled on his own he often exhibited extraordinary sensitivity and patience. Anyone who reads the interchange of letters about the purchase of Lord Acton's library -- the terms stipulated that Acton could continue without embarrassment to use it -- will be impressed by the delicacy and tact of the philanthropist. Nonetheless, the evolving forms in the administration of his bequests reflected Carnegie's experiences as a giver and his fatigue as a merely personal administrator.

19. In the last analysis Carnegie's achievement as a philanthropist lay in doing what he wrote he ought: to do; or, phrased in another way, he had an intellectual rather than a purely impulsive formula for his giving. This always over-impresses intellectuals. Be that as it may, he built 2,507 libraries - (the free public library) was to his mind the people's university. In the more formal educational field he financed technical training at the Carnegie Institute of Technology, encouraged research in basic science by the Carnegie Institution of Washington, and through the Carnegie Foundation for the Advancement of Teaching established a pension fund for college teachers. Only institutions without denominational connections could apply for inclusion. Finally in 1911 he created the Carnegie Corporation of New York, a separate foundation as large as all his other trusts combined. In simplified spelling, the Corporation was enjoined "to promote the advancement and diffusion of knowledge and understanding among the people of the United States, by aiding technical schools, institutions of higher learning, libraries, scientific

[Baha'i Comment](#)

---Page xix. The Gospel of Wealth - Editor's Introduction--

-

research, hero funds, useful publications, and by such other agencies and means as shall from time to time be found appropriate therefor." Before his death in 1919 he gave away \$311,000,000.

20. It does not impugn the noble integrity of this achievement to point out that Carnegie's program of philanthropy ministered to his exhibitionism. Though he modestly forbade the specific memorialization of his name, the essay, "Gospel of Wealth," enabled him to be a distinctive rich man, to select among his "dear fellow millionaires" - past and present - those he could commend or, by inference, censure. As he roamed about cracking heads or dispensing bouquets, he could play the congenial role of the maverick, a role J. P. Morgan found so disturbing in him. He could startle. On the stage of attention and influence, where he loved to stride, he could toss about once again the "Fathers-in-Israel."

[Baha'i Comment](#)

21. For some reason literateness in businessmen arouses popular and occasionally scholarly suspicion. They are thought not to possess the brains to think abstractly and summon thought or the ability to write the works to which their names are signed. Although Carnegie lived before the days when ghost-writing was standard operating procedure for businessmen and politicians (and occasionally candidates for the Ph.D.), he has not escaped the stigma. In the folklore of possible authorship the most common name given to the "faceless one" is that of James Howard Bridge. Carnegie once referred to him as "my clever secretary." Undoubtedly Bridge was of great assistance in the compilation of *Triumphant Democracy*, and he wrote a book on his own to prove that Carnegie had little to do with the accumulation of his fortune - this was the work of others. An examination of the private papers of Carnegie in the Library of Congress is enough to refute the notion that Carnegie could not express himself. The essays in this volume are authentic Carnegie.

[Baha'i Comment](#)

22. Nor was he the only literate or articulate man of business in a notable business generation. John D. Rockefeller col-

---Page xx. The Gospel of Wealth - Editor's Introduction--

lected in a volume his *Random Reminiscences of Men and Events* (1909); in spite of later scholarship, the volume retains a usefulness. Of business essayists contemporary with Carnegie, Edward Atkinson, the economist David A. Wells (1828-1898), the railroad journalist and economist Henry Varnum Poor (1812-1905), to mention no others, were all penetrating observers. Like Carnegie, they felt writing was a way to influence, and they sought quite consciously so to write and so to publish as to shape public opinion and policy. When due attention has been given to these business writers and to the media in which their work appeared, the business literature of the age will compare favorably in bulk and in force with that of reformists and critics.

[Baha'i Comment](#)

23. Carnegie wrote of events of course as he saw them in his own time, and it is scarcely to his discredit that he could not foresee the ironies subsequent events of twentieth-century history have produced-the two world wars despite his "Temple of Peace" at the Hague; revolution in Cuba and alignment with a foreign power despite the Monroe Doctrine; decline of empire and emergence of new nations on the African continent, then the arena of fierce new imperialistic rivalries; the vast American commitments all over the world; permanent conscription; continuing frustrations of international "co-operation"; the rise in power of Soviet Russia, no longer "one of our best friends." Nevertheless, typical spokesman of business as Carnegie was, he remains unique in the variety of his interests, the fecundity of his writing, and in my estimation, in the impression he made. The republication of these essays should remove once and for all the commonplace notion that the whole business generation was one of "robber barons" and that its members were all either crooks or clowns, dunces or hypocrites.

[Baha'i Comment](#)

---Page xxi. The Gospel of  
Wealth - Editor's Introduction--

-

### A Note on the Text

The first edition of THE GOSPEL OF WEALTH *And Other Timely Essays* came out in 1900, when the Century Company adapted and assembled in one volume twelve articles of topical interest written by Carnegie between 1886 and 1899. Acknowledgement of the original sources was made in the following statement: "The various articles in this volume are reprinted by permission of the publishers of the periodicals in which they originally appeared. The autobiographical fragment which precedes the essays proper was written for the 'Youth's Companion'; the other papers were first published in the 'Century Magazine,' the 'North American Review,' the 'Forum,' the 'Contemporary Review,' the 'Fortnightly Review,' and 'Nineteenth Century,' and the 'Scottish Leader.'" Curiously enough, although the edition carefully identified each essay by periodical and year, none is attributed to the *Fortnightly Review*. The present text follows that of 1900. A

[Baha'i Comment](#)

subsequent edition (1906) includes an additional essay entitled "British Pessimism," which had appeared in the *Nineteenth Century and After* in 1901.

**MENU:** [HOME](#) » [Reconstruction](#) » [Gospel Content](#) » [Gospel Purpose](#)

---



# The Gospel of Wealth

And Other Timely Essays

by Andrew Carnegie

**In the right-hand commentary column,  
that which is in GREEN is a commentator's remark and  
that which is in BLUE is from the Baha'i Writings.  
On occasion, in that column, there may be a [link](#) to an extended comment or  
dissertation on the subject under discussion.**

- -

***A reminder that under "view" on your browser - you can set the text size UP  
or DOWN for a more comfortable read for yourself.***

---Page 03 The Gospel of Wealth - How I Served My Apprenticeship---

## I

### **Introduction: How I Served My Apprenticeship**

*(1) Published in the Youth's Companion, April 23, 1896.*

1. IT is a great pleasure to tell how I served my apprenticeship as a business man. But there seems to be a question preceding this: Why did I become a business man? I am sure that I should never have selected a business career if I had been permitted to choose.

[Baha'i Comment](#)

2. The eldest son of parents who were themselves poor, I had, fortunately, to begin to perform some useful work in the world while still very young in order to earn an honest livelihood, and was thus shown even in early boyhood that my duty was to assist my parents and, like them, become, as soon as possible, a bread-winner in the family. What I could get to do, not what I desired, was the question.

[Baha'i Comment](#)

3. When I was born my father was a well-to-do master weaver in Dunfermline, Scotland. He owned no less than four damask-looms and employed apprentices. This was before the days of steam-factories for the manufacture of linen. A few large merchants took orders, and employed master weavers, such as my father, to weave the cloth, the merchants supplying the materials.

[Baha'i Comment](#)

4. As the factory system developed hand-loom weaving naturally declined, and my father was one of the sufferers by the change. The first serious lesson of my life came to me one day when he had taken in the last of his work to the merchant, and returned to our little home greatly distressed because there was no more work for him to do. I was then just about

---Page 04 The Gospel of Wealth - How I Served My Apprenticeship---

ten years of age, but the lesson burned into my heart, and I resolved then that the wolf of poverty should be driven from our door some day, if I could do it.

[Baha'i Comment](#)

5. The question of selling the old looms and starting for the United States came up in the family council, and I heard it discussed from day to day. It was finally resolved to take the plunge and join relatives already in Pittsburg. I well remember that neither father nor mother thought the change would be otherwise than a great sacrifice for them, but that "it would be better for the two boys."

[Baha'i Comment](#)

6. In after life, if you can look back as I do and wonder at the complete surrender of their own desires which parents make for the good of their children, you must reverence their memories with feelings akin to worship.

[Baha'i Comment](#)

7. On arriving in Allegheny City (there were four of us: father, mother, my younger brother, and myself), my father entered a cotton factory. I soon followed, and served as a "bobbin-boy," and this is how I began my preparation for subsequent apprenticeship as a business man. I received one dollar and twenty cents a week, and was then just about twelve years old.

[Baha'i Comment](#)

8. I cannot tell you how proud I was when I received my first week's own earnings. One dollar and twenty cents made by myself and given to me because I had been of some use in the world! No longer entirely dependent upon my parents, but at last admitted to the family partnership as a contributing member and able to help them! I think this makes a man out of a boy sooner than anything else, and a real man, too, if there be any germ of true manhood in him. It is everything to feel

[partnership](#) - Asserting that women and men share similar "station and rank" and "are equally the recipients of powers and endowments from God," the Baha'i teachings offer a model of equality based on the concept of partnership. Only when women become full participants in all domains of life and enter the important arenas of decision-making will humanity be prepared to embark on the next stage of its collective development. (Two Wings, paragraph 12, Baha'u'llah, Tablet translated from the Persian and Arabic, quoted in Women, no. 2; 'Abdu'l-Baha, Promulgation, p. 300.)

that you are useful.

9. I have had to deal with great sums. Many millions of dollars have since passed through my hands. But the genuine satisfaction I had from that one dollar and twenty cents outweighs any subsequent pleasure in money-getting. It was the direct reward of honest, manual labor; it represented a week

---Page 05 The Gospel of Wealth - How I Served My Apprenticeship---

of very hard work - so hard that, but for the aim and end which sanctified it, slavery might not be much too strong a term to describe it.

10. For a lad of twelve to rise and breakfast every morning, except the blessed Sunday morning, and go into the streets and find his way to the factory and begin to work while it was still dark outside, and not be released until after darkness came again in the evening, forty minutes' interval only being allowed at noon, was a terrible task.

**slavery** - How much of the energy employed in the business world of today is expended simply in canceling and neutralizing the efforts of other people--in useless strife and competition! And how much in ways that are still more injurious! Were all to work, and were all work, whether of brain or hand, of a nature profitable to mankind, as Baha'u'llah commands, then the supplies of everything necessary for a healthy, comfortable and noble life would amply suffice for all. There need be no slums, no starvation, no destitution, no industrial slavery, no health-destroying drudgery. (Baha'u'llah and New Era, page 143)

From the day it was born the United States embraced a set of contradictory values. The founding fathers proclaimed their devotion to the highest principles of equality and justice yet enshrined slavery in the Constitution. Slavery poisoned the mind and heart of the nation and would not be abolished without a bloody civil war that nearly destroyed the young republic. The evil consequences of slavery are still visible in this land. They continue to affect the behavior of both Black and White Americans and prevent the healing of old wounds. (Vision of Race Unity, page 111)

**Baha'i Comment**

11. But I was young and had my dreams, and something within always told me that this would not, could not, should not last - I should some day get into a better position. Besides this, I felt myself no longer a mere boy, but quite a little man, and this made me happy.

happy - I hope that the people of the West may be illumined by the light of God; that the Kingdom may come to them, that they may find eternal Life, that the Spirit of God may spread like a fire among them, that they may be baptized with the Water of Life and may find a new birth.

This is my desire; I hope by the will of God, He will cause you to receive it, and will make you happy. ('Abdu'l-Baha in London, page 49)

12. A change soon came, for a kind old Scotsman, who knew some of our relatives, made bobbins, and took me into his factory before I was thirteen, but here for a time it was even worse than in the cotton factory, because I was set to fire a boiler in the cellar, and actually to run the small steam engine which drove the machinery. The firing of the boiler was all right, for fortunately we did not use coal, but the refuse wooden chips; and I always liked to work in wood. But the responsibility of keeping the water right and of running the engine, and the danger of my making a mistake and blowing the whole factory to pieces, caused too great a strain, and. I often awoke and found myself sitting up in bed through the night, trying the steam-gauges. But I never told them at home that I was having a hard tussle. No, no! everything must be bright to them.

Baha'i Comment

13. This was a point of honor, for every member of the family was working hard, except, of course, my little brother, who was then a child, and we were telling each other only all the bright things. Besides this, no man would whine and give up - he would die first.

[Baha'i Comment](#)

14. There was no servant in our family, and several dollars per

---Page 06 The Gospel of Wealth - How I Served My Apprenticeship---

week were earned by the mother by binding shoes after her daily work was done! Father was also hard at work in the factory. And could I complain?

[factory](#) - It would be well, with regard to the common rights of manufacturers, workmen and artisans, that laws be established, giving moderate profits to manufacturers, and to workmen the necessary means of existence and security for the future. Thus when they become feeble and cease working, get old and helpless, or leave behind children under age, they and their children will not be annihilated by excess of poverty. And it is from the income of the factory itself, to which they have a right, that they will derive a share, however small, toward their livelihood. ('Abdu'l-Baha, Some Answered Questions, page 275)

15. My kind employer, John Hay, -peace to his ashes!- soon relieved me of the undue strain, for he needed some one to make out bills and keep his accounts, and finding that I could write a plain school-boy hand and could "cipher," he made me his only clerk. But still I had to work hard upstairs in the factory, for the clerking took but little time.

[Baha'i Comment](#)

16. You know how people moan about poverty as being a great evil, and it seems to be accepted that if people had only plenty of money and were rich, they would be happy and more useful, and get more out of life.

**poverty** - A financier with colossal wealth should not exist whilst near him is a poor man in dire necessity. When we see poverty allowed to reach a condition of starvation it is a sure sign that somewhere we shall find tyranny. Men must bestir themselves in this matter, and no longer delay in altering conditions which bring the misery of grinding poverty to a very large number of the people. The rich must give of their abundance, they must soften their hearts and cultivate a compassionate intelligence, taking thought for those sad ones who are suffering from lack of the very necessities of life.

There must be special laws made, dealing with these extremes of riches and of want. The members of the Government should consider the laws of God when they are framing plans for the ruling of the people. The general rights of mankind must be guarded and preserved. ('Abdu'l-Baha, Paris Talks, pages 153-154)

17. As a rule, there is more genuine satisfaction, a truer life and more obtained from life in the humble cottages of the poor than in the palaces of the rich. I always pity the sons and daughters of rich men, who are attended by servants, and have governesses at a later age, but am glad to remember that they do not know what they have missed.

**poor** - Difference of capacity in human individuals is fundamental. It is impossible for all to be alike, all to be equal, all to be wise. Baha'u'llah has revealed principles and laws which will accomplish the adjustment of varying human capacities. He has said that whatsoever is possible of accomplishment in human government will be effected through these principles. When the laws he has instituted are carried out there will be no millionaires possible in the community and likewise no extremely poor. This will be effected and regulated by adjusting the different degrees of human capacity. The fundamental basis of the community is agriculture, tillage of the soil. All must be producers. Each person in the community whose income is equal to his individual producing capacity shall be exempt from taxation. But if his income is greater than his needs he must pay a tax until an adjustment is effected. That is to say, a man's capacity for production and his needs will be equalized and reconciled through taxation. If his production exceeds he will pay no tax; if his necessities exceed his production he shall receive an amount sufficient to equalize or adjust. Therefore taxation will be proportionate to capacity and production and there will be no poor in the community. (Foundations of World Unity, page 37)



18. They have kind fathers and mothers, too, and think that they enjoy the sweetness of these blessings to the fullest: but this they cannot do; for the poor boy who has in his father his constant companion, tutor, and model, and in his mother - holy name! - his nurse, teacher, guardian angel, saint, all in one, has a richer, more precious fortune in life any rich man's son who is not so favored can know, and compared with which all other fortunes count for little.

**rich** - How often do we see a man, poor, sick, miserably clad, and with no means of support, yet spiritually strong. Whatever his body has to suffer, his spirit is free and well! Again, how often do we see a rich man, physically strong and healthy, but with a soul sick unto death. (Paris Talks, page 65)

19. It is because I know how sweet and happy and pure the home of honest poverty is, how free from perplexing care, from social envies and emulations, how loving and how united its members may be in the common interest of supporting the family, that I sympathize with the rich man's boy and congratulate the poor man's boy; and it is for these reasons that from the ranks of the poor so many strong,

**poverty** - The realm of Divinity is an indivisible oneness, wholly sanctified above human comprehension; for intellectual knowledge of creation is finite, whereas comprehension of Divinity is infinite. How can the finite comprehend the infinite? We are utter poverty, whereas the reality of Divinity is absolute wealth. How can utter poverty understand absolute wealth? We are utter weakness, whereas the reality of Divinity is absolute power... . (Promulgation of Universal Peace, page 172)

---Page 07 The Gospel of Wealth - How I Served My Apprenticeship---

eminent, self-reliant men have always sprung and always must spring.

20. If you will read the list of the immortals who "were not born to die," you will find that most of them were born to the precious heritage of poverty.

**poverty** - ... But the poor are especially beloved of God. Their lives are full of difficulties, their trials continual, their hopes are in God alone. Therefore, you must assist the poor as much as possible, even by sacrifice of yourself. No deed of man is greater before God than helping the poor. Spiritual conditions are not dependent upon the possession of worldly treasures or the absence of them. When one is physically destitute, spiritual thoughts are more likely. Poverty is a stimulus toward God.... (Promulgation of Universal Peace, page 216)

21. It seems nowadays a matter of universal desire that poverty should be abolished. We should be quite willing to abolish luxury, but to abolish honest, industrious, self-denying poverty would be to destroy the soil upon which mankind produces the virtues which enables our race to reach a still higher civilization than it now possesses.

**poverty** - While thousands are considering these questions, we have more essential purposes. The fundamentals of the whole economic condition are divine in nature and are associated with the world of the heart and spirit. This is fully explained in the Baha'i teaching, and without knowledge of its principles no improvement in the economic state can be realized. The Baha'is will bring about this improvement and betterment but not through sedition and appeal to physical force--not through warfare, but welfare. Hearts must be so cemented together, love must become so dominant that the rich shall most willingly extend assistance to the poor and take steps to establish these economic adjustments permanently. If it is accomplished in this way, it will be most praiseworthy because then it will be for the sake of God and in the pathway of His service. For example, it will be as if the rich inhabitants of a city should say, "It is neither just nor lawful that we should possess great wealth while there is abject poverty in this community," and then willingly give their wealth to the poor, retaining only as much as will enable them to live comfortably. (Promulgation of Universal Peace, page 238-239)

22. I come now to the third step in my apprenticeship, for I had already taken two, as you see - the cotton factory and then the bobbin factory; and with the third - the third time is the chance, you know - deliverance came. I obtained a situation as messenger boy in the telegraph office of Pittsburg when I was fourteen. Here I entered a new world.

**new world** - The gift of God to this enlightened age is the knowledge of the oneness of mankind and of the fundamental oneness of religion. War shall cease between nations, and by the will of God the Most Great Peace shall come; the world will be seen as a new world, and all men will live as brothers. (Century of Light, page 21)

23. Amid books, newspapers, pencils, pens and ink and writing-pads, and a clean office, bright windows, and the literary atmosphere, I was the happiest boy alive.

[Baha'i Comment](#)

24. My only dread was that I should some day be dismissed because I did not know the city; for it is necessary that a messenger boy should know all the firms and addresses of men who are in the habit of receiving telegrams. But I was a stranger in Pittsburg. However, I made up my mind that I would learn to repeat successively each business house in the principal streets, and was soon able to shut my eyes and begin at one side of Wood Street, and call every firm successively to the top, then pass to the other side and call every firm to the bottom. Before long I was able to do this with the business streets generally. My mind was then at rest upon that point.

[Baha'i Comment](#)

25. Of course every messenger boy wants to become an operator, and before the operators arrive in the early mornings the boys slipped up to the instruments and practised. This I

---Page 08 The Gospel of Wealth - How I Served My Apprenticeship---

did, and was soon able to talk to the boys in the other offices along the line, who were also practising.

[Baha'i Comment](#)

26. One morning I heard Philadelphia calling Pittsburg and giving the signal, "Death message." Great attention was then paid to "death messages," and I thought I ought to try to take this one. I answered and did so, and went off and delivered it before the operator came. After that the operators sometimes used to ask me to work for them.

[Baha'i Comment](#)

27. Having a sensitive ear for sound, I soon learned to take messages by the ear, which was then very uncommon - I think only two persons in the United States could then do it. Now every operator takes by ear, so easy it is to follow and do what any other boy can-if you only have to. This brought me into notice, and finally I became an operator, and received the, to me, enormous recompense of twenty-five dollars per month - three hundred dollars a year!

[recompense](#) - STATION OF TRUSTWORTHINESS 'O inmates of earth and heaven! Behold ye My beauty, and My radiance, and My revelation, and My effulgence. By God, the True One! I am Trustworthiness and the revelation thereof, and the beauty thereof. I will recompense whosoever will cleave unto Me, and recognize My rank and station, and hold fast unto My hem. I am the most great ornament of the people of Baha, and the vesture of glory unto all who are in the kingdom of creation. I am the supreme instrument for the prosperity of the world, and the horizon of assurance unto all beings.' (Baha'u'llah: Epistle to the Son of the Wolf, pages 136-137)

28. This was a fortune - the very sum that I had fixed when I was a factory-worker as the fortune I wished to possess, because the family could live on three hundred dollars a year and be almost or quite independent. Here it was at last! But I was soon to be in receipt of extra compensation for extra work.

[Baha'i Comment](#)

29. The six newspapers of Pittsburg received telegraphic news in common. Six copies of each despatch were made by a gentleman who received six dollars per week for the work, and he offered me a gold dollar every week if I would do it, of which I was very glad indeed, because I always liked to work with news and scribble for

[newspapers](#) - In this Day the secrets of the earth are laid bare before the eyes of men. The pages of swiftly-appearing newspapers are indeed the mirror of the world. They reflect the deeds and the pursuits of divers peoples and kindreds. They both reflect them and make them known. They are a mirror endowed with hearing, sight and speech. This is an amazing and potent phenomenon. However, it behoveth the writers thereof to be purged from the promptings of evil passions and desires and to be attired with the raiment of justice and equity. They should enquire into situations as much as possible and ascertain the facts, then set them down in writing. (Tablets of Baha'u'llah, pages 39-40)

newspapers.

30. The reporters came to a room every evening for the news which I had prepared, and this brought me into most pleasant intercourse with these clever fellows, and besides, I got a dollar a week as pocket-money, for this was not considered family revenue by me.

[Baha'i Comment](#)

31. I think this last step of doing something beyond one's task is fully entitled to be considered "business". The other revenue, you see, was just salary obtained for regular work;

[Baha'i Comment](#)

---Page 09 The Gospel of Wealth - How I Served My Apprenticeship---

but here was a little business operation upon my own account, and I was very proud indeed of my gold dollar every week.

32. The Pennsylvania Railroad shortly after this was completed to Pittsburg, and that genius, Thomas A. Scott,

*(2) Scott (1823-1881) was the railroad executive who warned Lincoln not to proceed directly to Washington for his inauguration and who served the Union cause significantly during the Civil War as supervisor and adviser on problems of transportation of men and supplies.*

was its superintendent. He often came to the telegraph office to talk to his chief, the general superintendent, at Altoona, and I became known to him in this way.

[Baha'i Comment](#)

33. When that great railway system put up a wire of its own, he asked me to be his clerk and operator; so I left the telegraph office - in which there is great danger that a young man may be permanently buried, as it were - and became connected with the railways.

[Baha'i Comment](#)

34. The new appointment was accompanied by what was, to me, a tremendous increase of salary. It jumped from twenty-five to thirty-five dollars per month. Mr. Scott was then receiving one hundred and twenty-five dollars per month, and I used to wonder what on earth he could do with so much money.

[Baha'i Comment](#)

35. I remained for thirteen years in the service of the Pennsylvania Railroad Company, and was at last superintendent of the Pittsburg division of the road, successor to Mr. Scott, who had in the meantime risen to the office of vice-president of the company.

[Baha'i Comment](#)

36. One day Mr. Scott, who was the kindest of men, and had taken a great fancy to me, asked if I had or could find five hundred dollars to invest.



37. Here the business instinct came into play. I felt that as the door was opened for a business investment with my chief, it would be wilful flying in the face of providence if I did not jump at it; so I answered promptly:

"Yes, sir; I think I can."

"Very well," he said, "get it; a man has just died who owns

---Page 10 The Gospel of Wealth - How I Served My Apprenticeship---

ten shares in the Adams Express Company which I want you to buy. It will cost you fifty dollars per share, and I can help you with a little balance if you cannot raise it all."

[Baha'i Comment](#)

38. Here was a queer position. The available assets of the whole family were not five hundred dollars. But there was one member of the family whose ability, pluck, and resource never failed us, and I felt sure the money could be raised somehow or other by my mother.

[Baha'i Comment](#)

39. Indeed, had Mr. Scott known our position he would have advanced it himself; but the last thing in the world the proud Scot will do is to reveal his poverty and rely upon others. The family had managed by this time to purchase a small house and pay for it in order to save rent. My recollection is that it was worth eight hundred dollars.

[Baha'i Comment](#)

40. The matter was laid before the council of three that night, and the oracle spoke: "Must be done. Mortgage our house. I will take the steamer in the morning for Ohio, and see uncle, and ask him to arrange it. I am sure he can." This was done. Of course her visit was successful -- where did she ever fail?

[Baha'i Comment](#)

41. The money was procured, paid over; ten shares of Adams Express Company stock was mine; but no one knew our little home had been mortgaged "to give our boy a start."

[Baha'i Comment](#)

42. Adams Express stock then paid monthly dividends of one percent, and the first check for five dollars arrived. I can see it now, and I well remember the signature of "J. C. Babcock, Cashier," who wrote a big "John Hancock" hand.

[Baha'i Comment](#)

43. The next day being Sunday, we boys - myself and my ever-constant companions - took our usual Sunday afternoon stroll in the country, and sitting down in the woods, I showed them this check, saying, "Eureka! We have found it.

[Baha'i Comment](#)

44. Here was something new to all of us, for none of us had ever received anything but from toil. A return from capital was something strange and new.

[Baha'i Comment](#)

45. How money could make money, how, without any attention from me, this mysterious golden visitor should come,

---Page 11 The Gospel of Wealth - How I Served My Apprenticeship---

led to much speculation upon the part of the young fellows, and I was for the first time hailed as a "capitalist".

[capitalist](#) - Certainly, some being enormously rich and others lamentably poor, an organization is necessary to control and improve this state of affairs. It is important to limit riches, as it is also of importance to limit poverty. Either extreme is not good. To be seated in the mean is most desirable. If it be right for a capitalist to possess a large fortune, it is equally just that his workman should have a sufficient means of existence. ('Abdu'l-Bahá, Paris Talks, page 153)

46. You see, I was beginning to serve my apprenticeship as a business man in a satisfactory manner.

[Baha'i Comment](#)

47. A very important incident in my life occurred when, one day in a train, a nice, farmer-looking gentleman approached me, saying that the conductor had told him I was connected with the Pennsylvania Railroad, and he would like to show me something. He pulled from a small green bag the model of the first sleeping-car. This was Mr. Woodruff, the inventor.

[Baha'i Comment](#)

*(3) Theodore Tuttle Woodruff (1811-1892), whose idea for sleeping cars dated from as early as 1830, produced his first model in 1857.*

48. Its value struck me like a flash. I asked him to come to Altoona the following week, and he did so. Mr. Scott, with his usual quickness, grasped the idea. A contract was made with Mr. Woodruff to put two trial cars on the Pennsylvania Railroad. Before leaving Altoona Mr. Woodruff came and offered an interest in the venture, which I promptly accepted. But how I was to make my payments rather troubled me, for the cars were to be paid for in monthly instalments after delivery, and

[Baha'i Comment](#)

my first monthly payment was to be two hundred and seventeen dollars and a half.

49. I had not the money, and I did not see any way of getting it. But I finally decided to visit the local banker and ask him for loan, pledging myself to repay at the rate of fifteen dollars per month. He promptly granted it. Never shall I forget his putting his arm over my shoulder, saying, "Oh, yes, Andy; you are all right!"

[Baha'i Comment](#)

50. I then and there signed my first note. Proud day this; and surely now no one will dispute that I was becoming a "business man." I had signed my first note, and, most important of all, - for any fellow can sign a note, - I had found a banker willing to take it as "good."

[Baha'i Comment](#)

51. My subsequent payments were made by the receipts from the sleeping-cars, and I really made my first considerable

[Baha'i Comment](#)

---Page 12. The Gospel of Wealth - How I Served My Apprenticeship---

sum from this investment in the Woodruff Sleeping Car

Company, which was afterward absorbed by Mr. Pullman a remarkable man whose name is now known over all the world.

52. Shortly after this I was appointed superintendent of the Pittsburg division, and returned to my dear old home, smoky Pittsburg. Wooden bridges were then used exclusively upon the railways, and the Pennsylvania Railroad was experimenting with a bridge built of cast-iron. I saw that wooden bridges would not do for the future, and organized a company in Pittsburg to build iron bridges.

[Baha'i Comment](#)

53. Here again I had recourse to the bank, because my share of the capital was twelve hundred and fifty dollars, and I had not the money; but the bank lent it to me, and we began the Keystone 1 which proved a great success. This company built the first great bridge over the Ohio River, three hundred feet span, and has built many of the most important structures since.

[Baha'i Comment](#)

54. This was my beginning in manufacturing; and from that start all our other works have grown, the profits of one building the other. My "apprenticeship" as a business man soon ended, for I resigned my position as an officer of the Pennsylvania Railroad Company to give exclusive attention to business.

[Baha'i Comment](#)

55. I was no longer merely an official working for others upon a salary, but a full-fledged business man working upon my own account.

[Baha'i Comment](#)

56. I never was quite reconciled to working for other people. At the most, the railway officer has to look forward to the enjoyment of a stated salary, and he has a great many people to please; even if he gets to be president, he has sometimes a board of directors who cannot know what is best to be done; and even if this board be satisfied, he has a board of stockholders to criticize him, and as the property is not his own he cannot manage it as he pleases.

[salary - 1476. If One Abuses His Position with the Government Through Corrupt or Mercenary Behavior...](#) "If one of the friends ... be appointed to a high administrative office, he should strive diligently, to perform the duties committed to his charge with perfect honesty, integrity, sincerity, rectitude and uprightness. If, however, he abuse his position through corrupt or mercenary behaviour, he will be held in detestation at the Threshold of Grandeur and incur the wrath of the Abha Beauty--nay, he shall be forsaken by the One True God and all who adore Him. So far from acting thus, he should content himself with his salary and allowance, seek out the way of righteousness, and dedicate his life to the service of state and people. Such must be the conduct and bearing of the Baha'is. Whoso transgresseth these bounds shall fall at length into manifest loss." (Lights of Guidance, page 454)

57. I always liked the idea of being my own master, of manufacturing

---Page 13. The Gospel of Wealth - How I Served My Apprenticeship---

something and giving employment to many men. There is only one thing to think of manufacturing if you are a Pittsburger, for Pittsburg even then had asserted her supremacy as the "Iron City," the leading iron-and-steel-manufacturing city in America.

[Baha'i Comment](#)

58. So my indispensable and clever partners, who had been my boy companions, I am delighted. to say, - some of the very boys who had met in the grove to wonder at the five dollar check, - began business, and still continue extending it to meet the ever-growing and ever-changing wants of our most progressive country, year after year.

[Baha'i Comment](#)



59. Always we are hoping that we need. expand no farther; yet ever we are finding that to stop expanding would be to fall behind; and even to-day the successive improvements and inventions follow each other so rapidly that we see just as much yet to be done as ever.

[Baha'i Comment](#)

60. When the manufacturer of steel ceases to grow he begins to decay, so we must keep on extending. The result of all these developments is that three pounds of finished steel are now bought in Pittsburg for two cents, which is cheaper than anywhere else on the earth, and that our country has become the greatest producer of iron in the world.

[Baha'i Comment](#)

61. And so ends the story of my apprenticeship and graduation as a business man.

[Baha'i Comment](#)

**MENU: [HOME](#) » [Reconstruction](#) » [Gospel Content](#) » [Gospel Purpose](#)**

# The Gospel of Wealth

And Other Timely Essays

by Andrew Carnegie

**In the right-hand commentary column,  
that which is in GREEN is a commentator's remark and  
that which is in BLUE is from the Baha'i Writings.  
On occasion, in that column, there may be a [link](#) to an extended comment or  
dissertation on the subject under discussion.**

**A reminder that under "view" on your browser - you can set the text size UP  
or DOWN for a more comfortable read for yourself.**

---Page 14 The Gospel of Wealth - II Administration of Wealth---

## **PART I: THE PROBLEM OF THE ADMINISTRATION OF WEALTH**

*(1) Published originally in the North American Review, CXLVIII (June 1889), 653-664, and CXLIX (December 1889), 682-698. Carnegie did not devise the appropriate and fetching title this essay now bears. He called it "Wealth." William T. Stead, editor of the Pall Mall Gazette, supplied the heading "The Gospel of Wealth." The personally dramatic circumstances under which the editor of the North American Review accepted the original article highly appealed to Carnegie's vanity and bent for personal excitement. He reported the circumstances in the first two paragraphs of his second periodical article, "The Best Fields for Philanthropy," which appeared in the Review in December 1889. As the latter article is here reprinted, Carnegie omitted this episode and began with the third paragraph of the original. There were also other minor changes from the original essay.*

1. The problem of our age is the proper administration of wealth, that the ties of brotherhood may still bind together the rich and poor in harmonious relationship.

Some might say the problem of our age is the need for PEACE!  
Others might say the problem in our materialistic age is the lack of spirituality. Nevertheless, as the old saying goes - money appears to be the root of all evil - and so while Carnegie lived at a time when the struggle between labor and capital was the predominant concern of the day, still it is a proper thesis from which to begin our study of the reorganization of society.

Be anxiously concerned with the needs of the age ye live in, and centre your deliberations on its exigencies and requirements.  
(Baha'u'llah: Proclamation of Baha'u'llah, page 116)

Is it not a fact - and this is the central idea I desire to emphasize -

that the fundamental cause of this world unrest is attributable, not so much to the consequences of what must sooner or later come to be regarded as a transitory dislocation in the affairs of a continually changing world, but rather to the failure of those into whose hands the immediate destinies of peoples and nations have been committed, to adjust their system of economic and political institutions to the imperative needs of a rapidly evolving age? Are not these intermittent crises that convulse present-day society due primarily to the lamentable inability of the world's recognized leaders to read aright the signs of the times, to rid themselves once for all of their preconceived ideas and fettering creeds, and to reshape the machinery of their respective governments according to those standards that are implicit in Baha'u'llah's supreme declaration of the Oneness of Mankind - the chief and distinguishing feature of the Faith He proclaimed? For the principle of the Oneness of Mankind, the cornerstone of Baha'u'llah's world-embracing dominion, implies nothing more nor less than the enforcement of His scheme for the unification of the world - the scheme to which we have already referred. "In every Dispensation," writes Abdu'l-Baha, "the light of Divine Guidance has been focussed upon one central theme.... In this wondrous Revelation, this glorious century, the foundation of the Faith of God and the distinguishing feature of His Law is the consciousness of the Oneness of Mankind." (Shoghi Effendi: World Order of Baha'u'llah, page 36)

"Nevertheless a greater and greater number of thoughtful and fair-minded men and women are recognizing in the clamour of contention, grief and destruction, now reaching such horrendous proportions, the evidences of Divine chastisement, and, turning their faces towards God, are becoming increasingly receptive to His Word. Doubtless the present circumstances, though tragic and awful in their immediate consequences, are serving to sharpen the focus on the indispensability of the Teachings of Baha'u'llah to the needs of the present age, and will provide many opportunities to reach countless waiting souls, hungry and thirsty for Divine guidance." (From a letter of the Universal House of Justice to the Baha'is of the World, November 16, 1969: Messages from the Universal House of Justice, pp. 33-34) (Multiple Authors: Lights of Guidance, pages 132-133)

"The inordinate disparity between rich and poor, a source of acute suffering, keeps the world in a state of instability, virtually on the brink of war. Few societies have dealt effectively with this situation. The solution calls for the combined application of spiritual, moral and practical approaches. A fresh look at the problem is required, entailing consultation with experts from a wide spectrum of disciplines, devoid of economic and ideological polemics, and involving the people directly affected in the decisions that must urgently be made. It is an issue that is bound up not only with the necessity for eliminating extremes of wealth and poverty but also

with those spiritual verities the understanding of which can produce a new universal attitude. Fostering such an attitude is itself a major part of the solution." (The Universal House of Justice: The Promise of World Peace, pp. 10-11, Haifa, 1985)

**The conditions of human life have not only been changed, but revolutionized, within the past few hundred years. In former days there was little difference between the dwelling, dress, food, and environment of the chief and those of his retainers. The Indians are today where civilized man then was. When visiting the Sioux, I was led to the wigwam of the chief. It was like the others in external appearance, and even within the difference was trifling between it and those of the poorest of his braves. The contrast between the palace of the millionaire and the cottage of the laborer with us today measures the change which has come with civilization.**

Be a treasure to the poor, an admonisher to the rich, an answerer to the cry of the needy, a preserver of the sanctity of thy pledge. (Baha'u'llah: Epistle to the Son of the Wolf, page 93)

O YE RICH ONES ON EARTH! The poor in your midst are My trust; guard ye My trust, and be not intent only on your own ease. (Baha'u'llah: Persian Hidden Words, page 54)

Certainly, some being enormously rich and others lamentably poor, an organization is necessary to control and improve this state of affairs. It is important to limit riches, as it is also of importance to limit poverty. Either extreme is not good. To be seated in the mean(1) is most desirable. If it be right for a capitalist to possess a large fortune, it is equally just that his workman should have a sufficient means of existence. A financier with colossal wealth should not exist whilst near him is a poor man in dire necessity. When we see poverty allowed to reach a condition of starvation it is a sure sign that somewhere we shall find tyranny. Men must bestir themselves in this matter, and no longer delay in altering conditions which bring the misery of grinding poverty to a very large number of the people. The rich must give of their abundance, they must soften their hearts and cultivate a compassionate intelligence, taking thought for those sad ones who are suffering from lack of the very necessities of life. There must be special laws made, dealing with these extremes of riches and of want. The members of the Government should consider the laws of God when they are framing plans for the ruling of the people. The general rights of mankind must be guarded and preserved. The government of the countries should conform to the Divine Law which gives equal justice to all. This is the only way in which the deplorable superfluity of great wealth and miserable, demoralizing, degrading poverty can be abolished. Not until this is done will the Law of God be obeyed. (Abdu'l-Baha: Paris Talks\*, pages 153-154)

---Page 15 The Gospel of  
Wealth - II Administration of  
Wealth---

This change, however, is not to be deplored, but welcomed as highly beneficial. It is well, nay, essential, for the progress of the race that the houses of some should be homes for all that is highest and best in literature and the arts, and for all the refinements of civilization, rather than that none should be so. Much better this great irregularity than universal squalor. Without wealth there can be no Maecenas. The "good old times" were not good old times. Neither master nor servant was as well situated then as today. A relapse to old conditions would be disastrous to both -- not the least so to him who serves -- and would sweep away civilization with it. But whether the change be for good or ill, it is upon us, beyond our power to alter, and, therefore, to be accepted and made the best of. It is a waste of time to criticize the inevitable.

King Lycurgus, the philosopher, made a great plan to equalize the subjects of Sparta; with self-sacrifice and wisdom was the experiment begun. Then the king called the people of his kingdom, and made them swear a great oath to maintain the same order of government if he should leave the country, also that nothing should make them alter it until his return. Having secured this oath, he left his kingdom of Sparta and never returned. Lycurgus abandoned the situation, renouncing his high position, thinking to achieve the permanent good of his country by the equalization of the property and of the conditions of life in his kingdom. All the self-sacrifice of the king was in vain. The great experiment failed. After a time all was destroyed; his carefully thought-out constitution came to an end. The futility of attempting such a scheme was shown and the impossibility of attaining equal conditions of existence was proclaimed in the ancient kingdom of Sparta. In our day any such attempt would be equally doomed to failure. (Abdu'l-Baha: Paris Talks\*, pages 152-153)

Among the results of the manifestation of spiritual forces will be that the human world will adapt itself to a new social form, the justice of God will become manifest throughout human affairs, and human equality will be universally established. The poor will receive a great bestowal, and the rich attain eternal happiness. For although at the present time the rich enjoy the greatest luxury and comfort, they are nevertheless deprived of eternal happiness; for eternal happiness is contingent upon giving, and the poor are everywhere in the state of abject need. Through the manifestation of God's great equity the poor of the world will be rewarded and assisted fully, and there will be a readjustment in the economic conditions of mankind so that in the future there will not be the abnormally rich nor the abject poor. The rich will enjoy the privilege of this new economic condition as well as the poor, for owing to certain provisions and restrictions they will not be able to accumulate so much as to be burdened by its management, while the poor will be relieved from the stress of want and misery. The rich will enjoy his palace, and the poor will have his comfortable cottage. The essence of the matter is that divine justice will become manifest in human conditions and affairs, and all mankind will find comfort and enjoyment in life. It is not meant that all will be equal, for inequality in degree and capacity is a property of nature. Necessarily there will be rich people and also those who will be in want of their livelihood, but in the aggregate community there will be equalization and readjustment of values and interests. In the future there will be no very rich nor extremely poor. There will be an equilibrium of interests, and a condition will be established which will make both rich and poor comfortable and content. This will be an eternal and blessed outcome of the glorious twentieth century which will be realized universally. The significance of it is that the glad tidings of great joy revealed in the promises of the Holy Books will be fulfilled. (Abdu'l-Baha:

2. It is easy to see how the change has come. One illustration will serve for almost every phase of the cause. In the manufacture of products we have the whole story. It applies to all combinations of human industry, as stimulated and enlarged by the inventions of this scientific age. Formerly, articles were manufactured at the domestic hearth, or in small shops which formed part of the household. The master and his apprentices worked side by side, the latter living with the master, and therefore subject to the same conditions. When these apprentices rose to be masters, there was little or no change in their mode of life, and they, in turn, educated succeeding apprentices in the same routine. There was, substantially, social equality, and even political equality, for those engaged in industrial pursuits had then little or no voice in the State.

This is a century of life and renewal. Sciences and arts, industry and invention have been reformed. Law and ethics have been reconstituted, reorganized. The world of thought has been regenerated. Sciences of former ages and philosophies of the past are useless today. Present exigencies demand new methods of solution; world problems are without precedent. Old ideas and modes of thought are fast becoming obsolete. Ancient laws and archaic ethical systems will not meet the requirements of modern conditions, for this is clearly the century of a new life, the century of the revelation of reality and, therefore, the greatest of all centuries. Consider how the scientific developments of fifty years have surpassed and eclipsed the knowledge and achievements of all the former ages combined. Would the announcements and theories of ancient astronomers explain our present knowledge of the suns and planetary systems? Would the mask of obscurity which beclouded medieval centuries meet the demand for clear-eyed vision and understanding which characterizes the world today? Will the despotism of former governments answer the call for freedom which has risen from the heart of humanity in this cycle of illumination? It is evident that no vital results are now forthcoming from the customs, institutions and standpoints of the past. In view of this, shall blind imitations of ancestral forms and theological interpretations continue to guide and control the religious life and spiritual development of humanity today? Shall man, gifted with the power of reason, unthinkingly follow and adhere to dogma, creeds and hereditary beliefs which will not bear the analysis of reason in this century of effulgent reality? Unquestionably this will not satisfy men of science, for when they find premise or conclusion contrary to present standards of proof and without real foundation, they reject that which has been formerly accepted as standard and correct and move forward from new foundations. (Abdu'l-Baha: Promulgation of Universal Peace\*, pages 140-141)

**3. The inevitable result of such a mode of manufacture was crude articles at high prices. Today the world obtains commodities of excellent quality at prices which even the preceding generation would have deemed incredible. In the commercial world similar causes have produced similar results, and the race is benefited thereby. The poor enjoy what**

**---Page 16 The Gospel of Wealth - II Administration of Wealth---**

**the rich could not before afford. What were the luxuries have become the necessities of life. The laborer has now more comforts than the farmer had a few generations ago. The farmer has more luxuries than the landlord had, and is more richly clad and better housed. The landlord has books and pictures rarer and appointments more artistic than the king could then obtain.**

From every standpoint the world of humanity is undergoing a reformation. The laws of former governments and civilizations are in process of revision; scientific ideas and theories are developing and advancing to meet a new range of phenomena; invention and discovery are penetrating hitherto unknown fields, revealing new wonders and hidden secrets of the material universe; industries have vastly wider scope and production; everywhere the world of mankind is in the throes of evolutionary activity indicating the passing of the old conditions and advent of the new age of reformation. Old trees yield no fruitage; old ideas and methods are obsolete and worthless now. Old standards of ethics, moral codes and methods of living in the past will not suffice for the present age of advancement and progress. ( `Abdu'l-Baha: Promulgation of Universal Peace\*, page 439)

Man is always progressing. His circle of knowledge is ever widening, and his mental activity flows through many and varied channels. Look what man has accomplished in the field of science, consider his many discoveries and countless inventions and his profound understanding of natural law. In the world of art it is just the same, and this wonderful development of man's faculties becomes more and more rapid as time goes on. If the discoveries, inventions and material accomplishments of the last fifteen hundred years could be put together, you would see that there has been greater advancement during the last hundred years than in the previous fourteen centuries. For the rapidity with which man is progressing increases century by century. ( `Abdu'l-Baha: Paris Talks\*, pages 71-72)

In times gone by progress on the material plane was not so rapid, neither was there bloodshed in such profusion. In ancient warfare there were no cannons, no guns, no dynamite, no shells, no torpedo boats, no battleships, no submarines. Now, owing to material civilization, we have all these inventions, and war goes from bad to worse! Europe itself has become like one immense arsenal, full of explosives, and may God prevent its ignition - for, should this happen, the whole world would be involved. I want to make you understand that material progress and spiritual progress are two very different things, and that only if material progress goes hand in hand with spirituality can any real progress come about, and the Most Great Peace reign in the world. ( `Abdu'l-Baha: Paris Talks\*, pages 107-108)

4. The price we pay for this salutary change is, no doubt, great. We assemble thousands of operatives in the factory, and in the mine, of whom the employer can know little or nothing, and to whom he is little better than a myth. All intercourse between them is at an end. Rigid castes are formed, and, as usual, mutual ignorance breeds mutual distrust. Each caste is without sympathy with the other, and ready to credit anything disparaging in regard to it. Under the law of competition, the employer of thousands is forced into the strictest economies, among which the rates paid to labor figure prominently, and often there is friction between the employer and the employed, between capital and labor, between rich and poor. Human society loses homogeneity.

Then rules and laws should be established to regulate the excessive fortunes of certain private individuals and meet the needs of millions of the poor masses; thus a certain moderation would be obtained. However, absolute equality is just as impossible, for absolute equality in fortunes, honors, commerce, agriculture, industry would end in disorderliness, in chaos, in disorganization of the means of existence, and in universal disappointment: the order of the community would be quite destroyed. Thus difficulties will also arise when unjustified equality is imposed. It is, therefore, preferable for moderation to be established by means of laws and regulations to hinder the constitution of the excessive fortunes of certain individuals, and to protect the essential needs of the masses. For instance, the manufacturers and the industrialists heap up a treasure each day, and the poor artisans do not gain their daily sustenance: that is the height of iniquity, and no just man can accept it. Therefore, laws and regulations should be established which would permit the workmen to receive from the factory owner their wages and a share in the fourth or the fifth part of the profits, according to the capacity of the factory; or in some other way the body of workmen and the manufacturers should share equitably the profits and advantages. Indeed, the capital and management come from the owner of the factory, and the work and labor, from the body of the workmen. Either the workmen should receive wages which assure them an adequate support and, when they cease work, becoming feeble or helpless, they should have sufficient benefits from the income of the industry; or the wages should be high enough to satisfy the workmen with the amount they receive so that they may themselves be able to put a little aside for days of want and helplessness. When matters will be thus fixed, the owner of the factory will no longer put aside daily a treasure which he has absolutely no need of (for, if the fortune is disproportionate, the capitalist succumbs under a formidable burden and gets into the greatest difficulties and troubles; the administration of an excessive fortune is very difficult and exhausts man's natural strength). And the workmen and artisans will no longer be in the greatest misery and want; they will no longer be submitted to the worst privations at the end of their life. It is, then, clear and evident that the repartition of excessive fortunes among a small number of individuals, while the masses are in need, is an iniquity and an injustice.



5. The price which society pays for the law of competition, like the price it pays for cheap comforts and luxuries, is also great; but the advantages of this law are also greater still than its cost -- for it is to this law that we owe our wonderful material development, which brings improved conditions in its train. But, whether the law be benign or not, we must say of it, as we say of the change in the conditions of men to which we have referred: It is here; we cannot evade it; no substitutes for it have been found; and while the law may be sometimes hard for the individual, it is best for the race, because it insures the survival of the fittest in every department. We accept and welcome, therefore, as conditions to which we must accommodate ourselves, great inequality of environment; the concentration of business, industrial and commercial, in the hands of a few; and the law of competition between these, as being not only beneficial, but

---Page 17 The Gospel of Wealth - II Administration of Wealth---

essential to the future progress of the race. Having accepted these, it follows that

**competition** - How much of the energy employed in the business world of today is expended simply in canceling and neutralizing the efforts of other people--in useless strife and competition! And how much in ways that are still more injurious! Were all to work, and were all work, whether of brain or hand, of a nature profitable to mankind, as Baha'u'llah commands, then the supplies of everything necessary for a healthy, comfortable and noble life would amply suffice for all. There need be no slums, no starvation, no destitution, no industrial slavery, no health-destroying drudgery. (Bahá'u'lláh & New Era, page 143)

**The Ethics of Wealth** - According to the Baha'i teachings, riches rightly acquired and rightly used are honorable and praiseworthy. Services rendered should be adequately rewarded. Baha'u'llah says in the Tablet of Tarazat:--"The people of Baha must not refuse to discharge the due reward of anyone, and must respect possessors of talent,... One must speak with justice and recognize the worth of benefits." (Bahá'u'lláh & New Era, page 143)

**essential** - The implications for social and economic development are profound. Concern for justice protects the task of defining progress from the temptation to sacrifice the well-being of the generality of humankind -- and even of the planet itself -- to the advantages which technological breakthroughs can make available to privileged minorities. In design and planning, it ensures that limited resources are not diverted to the pursuit of projects extraneous to a community's essential social or economic priorities. Above all, only development programs that are perceived as meeting their needs and as being just and equitable in objective can hope to engage the commitment of the masses of humanity, upon whom implementation depends. The relevant human qualities such as honesty, a willingness to work, and a spirit of cooperation are successfully harnessed to the accomplishment of enormously demanding collective goals when every member of society -- indeed every component group within society -- can trust that they are protected by standards and assured of benefits that apply equally to all.

At the heart of the discussion of a strategy of social and economic development, therefore, lies the issue of human rights. The shaping of such a strategy calls for the promotion of human rights to be freed from the grip of the false dichotomies that have for so long held it hostage. Concern that each human being should enjoy the freedom of thought and action conducive to his or her personal growth does not justify devotion to the cult of individualism that so deeply corrupts many areas of contemporary life. Nor does concern to ensure the welfare of society as a whole require a deification of the state as the supposed source of humanity's well-being. Far otherwise: the history of the present century shows all too clearly that such ideologies and the partisan agendas to which they give rise have

there must be great scope for the exercise of special ability in the merchant and in the manufacturer who has to conduct affairs upon a great scale. That this talent for organization and management is rare among men is proved by the fact that it invariably secures enormous rewards for its possessor, no matter where or under what laws or conditions. The experienced in affairs always rate the MAN whose services can be obtained as a partner as not only the first consideration, but such as render the question of his capital scarcely worth considering: for able men soon create capital; in the hands of those without the special talent required, capital soon takes wings. Such men become interested in firms or corporations using millions; and, estimating only simple interest to be made upon the capital invested, it is inevitable that their income must exceed their expenditure and that they must, therefore, accumulate wealth. Nor is there any middle ground which such men can occupy, because the great manufacturing or commercial concern which does not earn at least interest upon its capital soon becomes bankrupt. It must either go forward or fall behind; to stand still is impossible. It is a

been themselves the principal enemies of the interests they purport to serve. Only in a consultative framework made possible by the consciousness of the organic unity of humankind can all aspects of the concern for human rights find legitimate and creative expression. (Prosperity of Humankind, pages 5-6)

revenue - His Holiness Baha'u'llah has given instructions regarding every one of the questions confronting humanity. He has given teachings and instructions with regard to every one of the problems with which man struggles. Among them are (the teachings) concerning the question of economics that all the members of the body politic may enjoy through the working out of this solution the greatest happiness, welfare and comfort without any harm or injury attacking the general order of things. Thereby no difference or dissension will occur. No sedition or contention will take place. This solution is this:

First and foremost is the principle that to all the members of the body politic shall be given the greatest achievements of the world of humanity. Each one shall have the utmost welfare and well-being. To solve this problem we must begin with the farmer; there will we lay a foundation for system and order because the peasant class and the agricultural class exceed other classes in the importance of their service. In every village there must be established a general storehouse which will have a number of revenues. (Foundations of World Unity, page 39)

condition essential to its successful operation that it should be thus far profitable, and even that, in addition to interest on capital, it should make profit. It is a law, as certain as any of the others named, that men possessed of this peculiar talent for affairs, under the free play of economic forces must, of necessity, soon be in receipt of more revenue than can be judiciously expended upon themselves; and this law is as beneficial for the race as the others.

6. Objections to the foundations upon which society is based are not in order, because the condition of the race is better with these than it has been with any other which has been tried. Of the effect of any new substitutes proposed we cannot be sure. The Socialist or Anarchist who seeks to overturn present conditions is to be regarded as attacking the

---Page 18 The Gospel of Wealth - II Administration of Wealth---

foundation upon which civilization itself rests, for civilization took its start from the day when the capable, industrious workman said to

**society** - The institutions of society will succeed in eliciting and directing the potentialities latent in the consciousness of the world's peoples to the extent that the exercise of authority is governed by principles that are in harmony with the evolving interests of a rapidly maturing human race. Such principles include the obligation of those in authority to win the confidence, respect, and genuine support of those whose actions they seek to govern; to consult openly and to the fullest extent possible with all whose interests are affected by decisions being arrived at; to assess in an objective manner both the real needs and the aspirations of the communities they serve; to benefit from scientific and moral advancement in order to make appropriate use of the community's resources, including the energies of its members. No single principle of effective authority is so important as giving priority to building and maintaining unity among the members of a society and the members of its administrative institutions. Reference has already been made to the intimately associated issue of commitment to the search for justice in all matters.

Clearly, such principles can operate only within a culture that is essentially democratic in spirit and method. To say this, however, is not to endorse the ideology of partisanship that has everywhere boldly assumed democracy's name and which, despite impressive contributions to human progress in the past, today finds itself mired in the cynicism, apathy, and corruption to which it has given rise. In selecting those who are to take collective decisions on its behalf, society does not need and is not well served by the political theater of nominations, candidature, electioneering, and solicitation. It lies

his incompetent and lazy fellow, "If thou dost not sow, thou shalt not reap," and thus ended primitive Communism by separating the drones from the bees. One who studies this subject will soon be brought face to face with the conclusion that upon the sacredness of property civilization itself depends -- the right of the laborer to his hundred dollars in the savings-bank, and equally the legal right of the millionaire to his millions. Every man must be allowed "to sit under his own vine and fig-tree, with none to make afraid," if human society is to advance, or even to remain so far advanced as it is. To those who propose to substitute Communism for this intense Individualism, the answer therefore is: The race has tried that. All progress from that barbarous day to the present time has resulted from its displacement. Not evil, but good, has come to the race from the accumulation of wealth by those who have had the ability and energy to produce it. But even if we admit for a moment that it might be better for the race to discard its present foundation, Individualism, -- that it is a nobler ideal that man should labor, not for himself alone, but in and for a brotherhood of his fellows, and share with

within the capacity of all people, as they become progressively educated and convinced that their real development interests are being served by programs proposed to them, to adopt electoral procedures that will gradually refine the selection of their decision-making bodies. As the integration of humanity gains momentum, those who are thus selected will increasingly have to see all their efforts in a global perspective. Not only at the national, but also at the local level, the elected governors of human affairs should, in Baha'u'llah's view, consider themselves responsible for the welfare of all of humankind.

The tasks entailed in the development of a global society call for levels of capacity far beyond anything the human race has so far been able to muster. Reaching these levels will require an enormous expansion in access to knowledge, on the part of individuals and social organizations alike. Universal education will be an indispensable contributor to this process of capacity building, but the effort will succeed only as human affairs are so reorganized as to enable both individuals and groups in every sector of society to acquire knowledge and apply it to the shaping of human affairs. (Prosperity of Humankind, page 8,14 &15)

O my friend! In all circumstances one should seize upon every means which will promote security and tranquillity among the peoples of the world. The Great Being saith: In this glorious Day whatever will purge you from corruption and will lead you towards peace and composure, is indeed the Straight Path.

Please God, the peoples of the world may be led, as the result of the high endeavours exerted by their rulers and the wise and learned amongst men, to recognize their best interests. How long will humanity persist in its waywardness? How long will injustice continue? How long is chaos and confusion to reign amongst men? How long will discord agitate the face of society? (Tablets of Bahá'u'lláh, page171)

them all in common, realizing Swedenborg's idea of heaven

*(2) Carnegie is referring to Emanuel Swedenborg's (1688-1772) mystic theology expressed in his work Heaven and Hell.*

where, as he says, the angels derive their happiness, not from laboring for self, but for each other, -- even admit all this, and a sufficient answer is, This is not evolution, but revolution. It necessitates the changing of human nature itself -- a work of eons, even if it were good to change it, which we cannot know.

7. It is not practicable in our day or in our age. Even if desirable theoretically, it belongs to another and long-succeeding sociological stratum. Our duty is with what is practicable now -- with the next step possible in our day and generation. It is criminal to waste our energies in endeavoring to uproot,

---Page 19 The Gospel of Wealth - II Administration of Wealth---

when all we can profitably accomplish is to bend the universal tree of humanity a little in the direction most favorable to the production of good fruit under existing circumstances. We might as

society - ..."The maturity of the gift of understanding is made manifest through consultation." The standard of truth seeking this process demands is far beyond the patterns of negotiation and compromise that tend to characterize the present-day discussion of human affairs. It cannot be achieved -- indeed, its attainment is severely handicapped -- by the culture of protest that is another widely prevailing feature of contemporary society. Debate, propaganda, the adversarial method, the entire apparatus of partisanship that have long been such familiar features of collective action are all fundamentally harmful to its purpose: that is, arriving at a consensus about the truth of a given situation and the wisest choice of action among the options open at any given moment.

What Baha'u'llah is calling for is a consultative process in which the individual participants strive to transcend their respective points of view, in order to function as members of a body with its own interests and goals. In such an atmosphere, characterized by both candor and courtesy, ideas belong not to the individual to whom they occur during the discussion but to the group as a whole, to take up, discard, or revise as seems to best serve the goal pursued. Consultation succeeds to the extent that all participants support the decisions arrived at, regardless of the individual opinions with which they entered the discussion. Under such circumstances an earlier decision can be readily reconsidered if experience exposes any shortcomings. (Prosperity of Humankind, page 8)

well urge the destruction of the highest existing type of man because he failed to reach our ideal as to favor the destruction of Individualism, Private Property, the Law of Accumulation of Wealth, and the Law of Competition; for these are the highest result of human experience, the soil in which society, so far, has produced the best fruit. Unequally or unjustly, perhaps, as these laws sometimes operate, and imperfect as they appear to the Idealist, they are, nevertheless, like the highest type of man, the best and most valuable of all that humanity has yet accomplished.

8. We start, then, with a condition of affairs under which the best interests of the race are promoted, but which inevitably gives wealth to the few. Thus far, accepting conditions as they exist, the situation can be surveyed and pronounced good. The question then arises, -- and if the foregoing be correct, it is the only question with which we have to deal, -- What is the proper mode of administering wealth after the laws upon which civilization is founded have thrown it into the hands of the few? And it is of this great question that I

**administering wealth** - Certainly, some being enormously rich and others lamentably poor, an organization is necessary to control and improve this state of affairs. It is important to limit riches, as it is also of importance to limit poverty. Either extreme is not good. To be seated in the mean is most desirable. If it be right for a capitalist to possess a large fortune, it is equally just that his workman should have a sufficient means of existence.

A financier with colossal wealth should not exist whilst near him is a poor man in dire necessity. When we see poverty allowed to reach a condition of starvation it is a sure sign that somewhere we shall find tyranny. Men must bestir themselves in this matter, and no longer delay in altering conditions which bring the misery of grinding poverty to a very large number of the people. The rich must give of their abundance, they must soften their hearts and cultivate a compassionate intelligence, taking thought for those sad ones who are suffering from lack of the very necessities of life.

There must be special laws made, dealing with these extremes of riches and of want. The members of the Government should consider the laws of God when they are framing plans for the ruling of the people. The general rights of mankind must be guarded and

believe I offer the true solution. It will be understood that fortunes are here spoken of, not moderate sums saved by many years of effort, the returns from which are required for the comfortable maintenance and education of families. This is not wealth, but only competence, which it should be the aim of all to acquire, and which it is for the best interests of society should be acquired.

9. There are but three modes in which surplus wealth can be disposed of. It can be left to the families of the decedents; or it can be bequeathed for public purposes; or, finally, it can be administered by its possessors during their lives. Under the first and second modes most of the wealth of the world that has reached the few has hitherto been applied. Let us in turn consider each of these modes. The first is the most

---Page 20 The Gospel of Wealth - II Administration of Wealth---

injudicious. In monarchical countries, the estates and the greatest portion of the wealth are left to the first son, that the vanity of the parent may be gratified by the thought that his name and title are to

preserved.

The government of the countries should conform to the Divine Law which gives equal justice to all. This is the only way in which the deplorable superfluity of great wealth and miserable, demoralizing, degrading poverty can be abolished. Not until this is done will the Law of God be obeyed. ( Abdu'l-Bahá, Paris Talks, page 153-154)

**inheritance** - We have divided inheritance into seven categories

The Baha'i laws of inheritance apply only in case of intestacy, that is, when the individual dies without leaving a will. In the Kitab-i-Aqdas (#109), Baha'u'llah instructs every believer to write a will. He elsewhere clearly states that the individual has full jurisdiction over his property and is free to determine the manner in which his or her estate is to be divided and to designate, in the will, those, whether Baha'i or non-Baha'i, who should inherit (Q and A 69). In this connection, a letter written on behalf of Shoghi Effendi explains that:

...even though a Baha'i is permitted in his will to dispose of his wealth in the way he wishes, yet he is morally and conscientiously bound to always bear in mind, while writing his will, the necessity of his upholding the principle of Baha'u'llah regarding the social function of wealth, and the consequent necessity of avoiding its over-accumulation and concentration in a few individuals or groups of individuals.

This verse of the Aqdas introduces a lengthy passage in which Baha'u'llah elaborates the Baha'i law of inheritance. In reading this passage one should bear in mind that the law is formulated with the presumption that the deceased is a man; its provisions apply, mutatis mutandis, when the deceased is a woman.

The system of inheritance which provides for distribution of the deceased's estate among seven categories of heirs (children, spouse, father, mother, brothers, sisters, and teachers) is based on the provisions set out by the Báb in the Bayan. The major features of the

descend unimpaired to succeeding generations. The condition of this class in Europe to-day teaches the failure of such hopes or ambitions. The successors have become impoverished through their follies, or from the fall in the value of land. Even in Great Britain the strict law of entail has been found inadequate to maintain an hereditary class. Its soil is rapidly passing into the hands of the stranger. Under republican institutions the division of property among the children is much fairer; but the question which forces itself upon thoughtful men in all lands is, Why should men leave great fortunes to their children? If this is done from affection, is it not misguided affection? Observation teaches that, generally speaking, it is not well for the children that they should be so burdened. Neither is it well for the State. Beyond providing for the wife and daughters moderate sources of income, and very moderate allowances indeed, if any, for the sons, men may well hesitate; for it is no longer questionable that great sums bequeathed often work more for the injury than for the good of the recipients. Wise men will soon conclude that, for the best interests of the members of their families, and of the State, such

Baha'i laws of inheritance in the case of intestacy are:

1. If the deceased is a father and his estate includes a personal residence, such residence passes to the eldest son (Q and A 34).
2. If the deceased has no male descendants, two thirds of the residence pass to his female descendants and the remaining third passes to the House of Justice (Q and A 41, 72). See note 42 concerning the levels of the institution of the House of Justice to which this law applies. (See also note 44.)
3. The remainder of the estate is divided among the seven categories of heirs. For details of the number of shares to be received by each group, see Questions and Answers, number 5, and Synopsis and Codification, section IV.C.3.a.
4. In case there is more than one heir in any category the share allotted to that class should be divided between them equally, be they male or female. (Bahá'u'lláh, Kitáb-i-Aqdás, page 182-183)



bequests are an improper use of their means.

10. It is not suggested that men who have failed to educate their sons to earn a livelihood shall cast them adrift in poverty. If any man has seen fit to rear his sons with a view to their living idle lives, or, what is highly commendable, has instilled in them the sentiment that they are in a position to labor for public ends without reference to pecuniary considerations, then, of course, the duty of the parent is to see that such are provided for in moderation. There are instances of millionaires' sons unspoiled by wealth, who, being rich, still perform great services to the community. Such are the very salt of the earth, as valuable as, unfortunately, they are

---Page 21 The Gospel of Wealth - II Administration of Wealth---

rare. It is not the exception, however, but the rule, that men must regard; and, looking at the usual result of enormous sums conferred upon legatees, the thoughtful man must shortly say, "I would as soon leave to my son a curse as the almighty dollar," and admit to himself

**livelihood** - O MY SERVANT! The best of men are they that earn a livelihood by their calling and spend upon themselves and upon their kindred for the love of God, the Lord of all worlds. (Baha'u'llah: The Hidden Words, Persian #82)

Blessed are those who have fixed their gaze on the realm of glory and have followed the commandments of the Lord of Names. Blessed is he who in the days of God will engage in handicrafts. This is a bounty from God, for in this Most Great Dispensation it is acceptable in the sight of God for man to occupy himself in a trade which relieveth him of depending upon charity. The craft of every craftsman is regarded as worship. (Bahá'u'lláh, The Arts, Compilation of Compilations, vol. I, number 1)

10. The purpose of learning should be the promotion of the welfare of the people, and this can be achieved through crafts. It hath been revealed and is now repeated that the true worth of artists and craftsmen should be appreciated, for they advance the affairs of mankind. Just as the foundations of religion are made firm through the Law of God, the means of livelihood depend upon those who are engaged in arts and crafts. True learning is that which is conducive to the well-being of the world, not to pride and self-conceit, or to tyranny, violence and pillage.

II. From the Writings and Utterances of 'Abdu'l-Baha

11. Every person must have an occupation, a trade or a craft, so that he may carry other people's burdens, and not himself be a burden to others. (The Arts, Compilation of Compilations, vol. I, number 10 & 11)

It would be well, with regard to the common rights of manufacturers, workmen and artisans, that laws be established, giving moderate profits to manufacturers, and to workmen the necessary means of existence and security for the future. Thus when they become feeble and cease working, get old and helpless, or leave behind children under age, they and their children will not be annihilated by excess of poverty. And it is from the income of the factory itself, to which they have a right, that they will derive a share, however small, toward their livelihood. (Abdu'l-Bahá, Some Answered Questions, page 275)

that it is not the welfare of the children, but family pride, which inspires these legacies.

11. As to the second mode, that of leaving wealth at death for public uses, it may be said that this is only a means for the disposal of wealth, provided a man is content to wait until he is dead before he becomes of much good in the world. Knowledge of the results of legacies bequeathed is not calculated to inspire the brightest hopes of much posthumous good being accomplished by them. The cases are not few in which the real object sought by the testator is not attained, nor are they few in which his real wishes are thwarted. In many cases the bequests are so used as to become only monuments of his folly. It is well to remember that it requires the exercise of not less ability than that which acquires it, to use wealth so as to be really beneficial to the community. Besides this, it may fairly be said that no man is to be extolled for doing what he cannot help doing, nor is he to be thanked by the community to which he only leaves wealth at death. Men who leave vast sums in this way may fairly be thought men who would not have left it at all had they been able to

**Bequests** - "If a wealthy man at the time of his death bequeaths a gift to the poor and miserable, and gives a part of his wealth to be spent for them, perhaps this action may be the cause of his pardon and forgiveness, and of his progress in the divine Kingdom.

"Also a father and mother endure the greatest troubles and hardships for their children; and often when the children have reached the age of maturity, the parents pass on to the other world. Rarely does it happen that a father and mother in this world see the reward of the care and trouble they have undergone for their children. Therefore, children, in return for this care and trouble, must show forth charity and beneficence, and must implore pardon and forgiveness for their parents. So you ought, in return for the love and kindness shown you by your father, to give to the poor for his sake, with greatest submission and humility implore pardon and remission of sins, and ask for the supreme mercy." (Lights of Guidance, number 685)

90. Great is the recompense that God has ordained for the true and devoted souls, the pure and detached beings who have spontaneously bequeathed a portion of their earthly possessions to the Cause of God, either during their own lifetimes or through their wills, and have had the privilege and honour of discharging their obligations to Huququ'llah.

Give assurance on my behalf to the donors and to the survivors of those who have ascended unto God, affirming that these efforts and donations are bound to attract divine confirmations, heavenly blessings and incalculable favours, and to promote the manifold interests of the International Baha'i Community. Well is it with them, inasmuch as God has enabled them to fulfil that which shall elevate their stations in this world and in the world to come. (23 June 1945--translated from the Persian) (Bahá'u'lláh, Huququ'llah, page 31)

take it with them. The memories of such cannot be held in grateful remembrance, for there is no grace in their gifts. It is not to be wondered at that such bequests seem so generally to lack the blessing.

12. The growing disposition to tax more and more heavily large estates left at death is a cheering indication of the growth of a salutary change in public opinion. The State of Pennsylvania now takes -- subject to some exceptions -- one tenth of the property left by its citizens. The budget presented in the British Parliament the other day proposes

---Page 22 The Gospel of Wealth - II Administration of Wealth---

to increase the death duties; and, most significant of all, the new tax is to be a graduated one. Of all forms of taxation this seems the wisest

*(3) Inheritance taxes have historically taken many forms. They may be progressively heavier depending on the size of the transferred estate; they may vary with the relationship of the beneficiary to the testator; they may be levied upon different kinds of property. By the late eighties, England had carried the system of "death duties," purportedly a Gladstonian designation, farther than any other nation. By 1890 only six American states levied*

**Inheritance** - Baha'u'llah states that a person should be free to dispose of his possessions during his lifetime in any way he chooses, and it is incumbent on everyone to write a will stating how his property is to be disposed of after his death. When a person dies without leaving a will, the value of the property should be estimated and divided in certain stated proportions among seven classes of inheritors, namely, children, wife or husband, father, mother, brothers, sisters and teachers, the share of each diminishing from the first to the last. In the absence of one or more of these classes, the share which would belong to them goes to the public treasury, to be expended on the poor, the fatherless and the widows, or on useful public works. If the deceased has no heirs, then all his property goes to the public treasury.

There is nothing in the law of Baha'u'llah to prevent a man from leaving all his property to one individual if he pleases, but Baha'is will naturally be influenced, in making their wills, by the model Baha'u'llah has laid down for the case of intestate estates, which ensures distribution of property among a considerable number of heirs. (Bahá'u'lláh & New Era, page 146)

*taxes of one sort or another on inheritances; and federal resort to inheritance taxation had been generally a temporary feature of emergency war financing. By 1900 twenty-one states had inheritance taxes.*

Men who continue hoarding great sums all their lives, the proper use of which for public ends would work good to the community from which it chiefly came, should be made to feel that the community, in the form of the State, cannot thus be deprived of its proper share. By taxing estates heavily at death the State marks its condemnation of the selfish millionaire's unworthy life.

13. It is desirable that nations should go much further in this direction. Indeed, it is difficult to set bounds to the share of a rich man's estate which should go at his death to the public through the agency of the State, and by all means such taxes should be graduated, beginning at nothing upon moderate sums to dependents, and increasing rapidly as the amounts swell, until of the millionaire's hoard, as of Shylock's, at least

*The other  
half  
Comes to the privy  
coffer of the State*

tax - Difference of capacity in human individuals is fundamental. It is impossible for all to be alike, all to be equal, all to be wise. Baha'u'llah has revealed principles and laws which will accomplish the adjustment of varying human capacities. He has said that whatsoever is possible of accomplishment in human government will be effected through these principles. When the laws he has instituted are carried out there will be no millionaires possible in the community and likewise no extremely poor. This will be effected and regulated by adjusting the different degrees of human capacity. The fundamental basis of the community is agriculture, tillage of the soil. All must be producers. Each person in the community whose income is equal to his individual producing capacity shall be exempt from taxation. But if his income is greater than his needs he must pay a tax until an adjustment is effected. That is to say, a man's capacity for production and his needs will be equalized and reconciled through taxation. If his production exceeds he will pay no tax; if his necessities exceed his production he shall receive an amount sufficient to equalize or adjust. Therefore taxation will be proportionate to capacity and production and there will be no poor in the community. (Foundations of World Unity, page 37)

*(4) Portia's judgment in Merchant of Venice, Act IV, scene 1.*

This policy would work powerfully to induce the rich man to attend to the administration of wealth during his life, which is the end that society should always have in view, as being by far the most fruitful for the people. Nor need it be feared that this policy would sap the root of enterprise and render men less anxious to accumulate, for, to the class whose ambition it is to leave great fortunes and to be talked about after their death, it will attract even more attention, and, indeed, be a somewhat nobler ambition, to have enormous sums paid over to the State from their fortunes.

---Page 23 The Gospel of Wealth - II Administration of Wealth---

14. There remains, then, only one mode of using great fortunes; but in this we have the true antidote for the temporary unequal distribution of wealth, the reconciliation of the rich and the poor -- a reign of harmony, another ideal, differing, indeed, from that of the Communist in requiring only the further evolution of

**Public Finance** - 'Abdu'l-Baha suggests that each town and village or district should be entrusted as far as possible with the administration of fiscal matters within its own area and should contribute its due proportion for the expenses of the general government. One of the principal sources of revenue should be a graduated income tax. If a man's income does not exceed his necessary expenditure he should not be required to pay any tax, but in all cases where income exceeds the necessary expenditure a tax should be levied, the percentage of tax increasing as the surplus of income over necessary expenditure increases.

On the other hand, if a person, through illness, poor crops, or other cause for which he is not responsible, is unable to earn an income sufficient to meet his necessary expenses for the year, then what he

existing conditions, not the total overthrow of our civilization. It is founded upon the present most intense Individualism, and the race is prepared to put it in practice by degrees whenever it pleases. Under its sway we shall have an ideal State, in which the surplus wealth of the few will become, in the best sense, the property of the many, because administered for the common good; and this wealth, passing through the hands of the few, can be made a much more potent force for the elevation of our race than if distributed in small sums to the people themselves. Even the poorest can be made to see this, and to agree that great sums gathered by some of their fellow-citizens and spent for public purposes, from which the masses reap the principal benefit, are more valuable to them than if scattered among themselves in trifling amounts through the course of many years.

lacks for the maintenance of himself and his family should be supplied out of public funds.

There will also be other sources of public revenue, e.g. from intestate estates, mines, treasure trove and voluntary contributions; while among the expenditures will be grants for the support of the infirm, of orphans, of schools, of the deaf and blind, and for the maintenance of public health. Thus the welfare and comfort of all will be provided for. (Bahá'u'lláh & New Era, page 141-142)

15. If we consider the results which flow from the Cooper Institute, for instance, to the best portion of the race in New York not possessed of means, and compare these with those which would have ensued for the good of the masses from an equal sum distributed by Mr. Cooper in his lifetime in the form of wages, which is the highest form of distribution, being for work done and not for charity, we can form some estimate of the possibilities for the improvement of the race which lie embedded in the present law of the accumulation of wealth. Much of this sum, if distributed in small quantities among the people, would have been wasted in the indulgence of appetite, some of it in excess, and it may be doubted whether even the part put to the best use, that of adding to the comforts of the home, would have yielded results for the race, as a race, at all comparable to those

---Page 24 The Gospel of Wealth - II Administration of Wealth---

which are flowing and are to flow from the Cooper Institute from generation to generation.

**Income** - Difference of capacity in human individuals is fundamental. It is impossible for all to be alike, all to be equal, all to be wise. Baha'u'llah has revealed principles and laws which will accomplish the adjustment of varying human capacities. He has said that whatsoever is possible of accomplishment in human government will be effected through these principles. When the laws he has instituted are carried out there will be no millionaires possible in the community and likewise no extremely poor. This will be effected and regulated by adjusting the different degrees of human capacity. The fundamental basis of the community is agriculture, tillage of the soil. All must be producers. Each person in the community whose income is equal to his individual producing capacity shall be exempt from taxation. But if his income is greater than his needs he must pay a tax until an adjustment is effected. That is to say, a man's capacity for production and his needs will be equalized and reconciled through taxation. If his production exceeds he will pay no tax; if his necessities exceed his production he shall receive an amount sufficient to equalize or adjust. Therefore taxation will be proportionate to capacity and production and there will be no poor in the community. (Foundations of World Unity, page 37)

The question of socialization is very important. It will not be solved by strikes for wages. All the governments of the world must be united and organize an assembly the members of which should be elected from the parliaments and the nobles of the nations. These must plan with utmost wisdom and power so that neither the capitalist suffer from enormous losses nor the laborers become needy. In the utmost moderation they should make the law; then announce to the public that the rights of the working people are to be strongly preserved. Also the rights of the capitalists are to be protected. When such a general plan is adopted by the will of both sides, should a strike occur, all the governments of the world collectively should resist it. Other-wise, the labor problem will lead to much destruction, especially in Europe. Terrible things will take place.

For instance, the owners of properties, mines and factories should share their incomes with their employees and give a fairly certain percentage of their products to their workingmen in order that the employees may receive, beside their wages, some of the general income of the factory so that the employee may strive with his soul in the work.

No more trusts will remain in the future. The question of the trusts will be wiped away entirely. Also, every factory that has ten thousand shares will give two thousand shares of these ten thousand to its employees and will write the shares in their names, so that they may have them, and the rest will belong to the capitalists. Then at the end of the month or year whatever they may earn after the

*(5) Cooper Union, which celebrated in 1959 the centenary of its opening, was the chief philanthropic undertaking of Peter Cooper (1791-1883). A resident of New York, whose main iron mills were in New Jersey, Cooper was moved to establish an institution providing for those of little means an education in pure and applied science. The Union, though its activities soon embraced a wide variety of intellectual interests, stressed contributions "to the useful purposes of life" and adult education. The Union's building at 3rd Avenue and 7th Street appropriately embodied many structural innovations. Before his death Cooper had given the Union up-wards of \$900,000. In 1902 Carnegie gave \$600,000 to its endowment.*

Let the advocate of violent or radical change ponder well this thought.

expenses and wages are paid, according to the number of shares, should be divided among both. In reality, so far great injustice has befallen the common people. Laws must be made because it is impossible for the laborers to be satisfied with the present system. They will strike every month and every year. Finally, the capitalists will lose. In ancient times a strike occurred among the Turkish soldiers. They said to the government: "Our wages are very small and they should be increased." The government was forced to give them their demands. Shortly afterwards they struck again. Finally all the incomes went to the pockets of the soldiers to the extent that they killed the king, saying: "Why didst thou not increase the income so that we might have received more?"

It is impossible for a country to live properly without laws. To solve this problem rigorous laws must be made, so that all the governments of the world will be the protectors thereof. (Foundations of World Unity, pages 43-44)



16. We might even go so far as to take another instance -- that of Mr. Tilden's bequest of five millions of dollars for a free library in the city of New York; but in referring to this one cannot help saying involuntarily: How much better if Mr. Tilden had devoted the last years of his own life to the proper administration of this immense sum; in which case neither legal contest nor any other cause of delay could have interfered with his aims. But let us assume that Mr. Tilden's millions finally become the means of giving to this city a noble public library, where the treasures of the world contained in books will be open to all forever, without money and without price.

[Baha'i Comment](#)

*(6) Samuel J. Tilden (1814-1886), New Yorker, able corporation lawyer, loser of the disputed presidential election of 1876, bequeathed a considerable share of his large estate "to establish and maintain a free public library and reading room in the City of New York." To accomplish this end his executors were to incorporate a Tilden Trust. Family heirs contested the will, and in a series of decisions -- possibly animated by political considerations -- various New York courts upset the testator's instructions. Though the Tilden Trust was incorporated in 1887 and the executors settled with the heirs in 1892, the estate was formally in the hands of executors until 1930. With about \$2,250,000 in hand for a library, the Tilden Trust amalgamated in*

*1901 with the Astor and Lenox Libraries to form the New York Public Library. The present classical building on Fifth Avenue, housing the library, was the fruit of this settlement.*

Considering the good of that part of the race which congregates in and around Manhattan Island, would its permanent benefit have been better promoted had these millions been allowed to circulate in small sums through the hands of the masses? Even the most strenuous advocate of Communism must entertain a doubt upon this subject.

---Page 25 The Gospel of Wealth - II Administration of Wealth---

Most of those who think will probably entertain no doubt whatever.

17. Poor and restricted are our opportunities in this life, narrow our horizon, our best work most imperfect; but rich men should be thankful for one inestimable boon. They have it in their power during their lives to busy themselves in organizing benefactions from which the masses of their fellows will derive lasting advantage, and thus dignify their own lives. The highest life is probably to be reached,

[Baha'i Comment](#)

not by such imitation of the life of Christ as Count Tolstoi gives us, but, while animated by Christ's spirit, by recognizing the changed conditions of this age, and adopting modes of expressing this spirit suitable to the changed conditions under which we live, still laboring for the good of our fellows, which was the essence of his life and teaching, but laboring in a different manner.

18. This, then, is held to be the duty of the man of wealth: To set an example of modest, unostentatious living, shunning display or extravagance; to provide moderately for the legitimate wants of those dependent upon him; and, after doing so, to consider all surplus revenues which come to him simply as trust funds, which he is called upon to administer, and strictly bound as a matter of duty to administer in the manner which, in his judgment, is best calculated to produce the most beneficial results for the community -- the man of wealth thus becoming the mere trustee and agent for his poorer brethren, bringing to their service his superior wisdom, experience, and ability to administer, doing for them better than they would

**Rich** - This is the Book of Generosity which hath been revealed by the King of Eternity. Whoso adorneth himself with this virtue hath distinguished himself and will be blessed by the All-Merciful from His exalted Kingdom of Glory. However, despite his high rank and prominent position, were he to pass beyond the limits, he would be regarded among the prodigal by the All-Knowing, the All-Wise. Cling ye unto moderation. This is the commandment that He Who is the All-Possessing, the Most High hath enjoined upon you in His Generous Book. O ye that are the exponents of generosity and the manifestations thereof! Be generous unto them whom ye find in manifest poverty. Oh ye that are possessed of riches! Take heed lest outward appearance deter you from benevolent deeds in the path of God, the Lord of all mankind.

Say: I swear by God! No one is despised in the sight of the Almighty for being poor. Rather is he exalted, if he is found to be of them who are patient. Blessed are the poor that are steadfast in patience, and woe betide the rich that hold back Huququ'lláh and fail to observe that which is enjoined upon them in His Preserved Tablet.

Say: Pride not yourselves on earthly riches ye possess. Reflect upon your end and upon the recompense for your works that hath been ordained in the Book of God, the Exalted, the Mighty. Blessed is the rich man whom earthly possessions have been powerless to hinder from turning unto God, the Lord of all names.

Verily he is accounted among the most distinguished of men before God, the Gracious, the All-Knowing. (Bahá'u'lláh, Huququ'llah, page 8-9)

or could do for themselves.

19. We are met here with the difficulty of determining what are moderate sums to leave to members of the family; what is modest, unostentatious living; what is the test of extravagance. There must be different standards for different conditions. The answer is that it is as impossible to name exact amounts or actions as it is to define good manners, good taste, or the rules of propriety; but, nevertheless, these are verities,

---Page 26 The Gospel of Wealth - II Administration of Wealth---

well known, although indefinable. Public sentiment is quick to know and to feel what offends these. So in the case of wealth. The rule in regard to good taste in dress of men or women applies here. Whatever makes one conspicuous offends the canon. If any family be chiefly known for display, for extravagance in home, table, or equipage, for enormous sums ostentatiously spent in any form upon itself -- if these be its chief distinctions, we have no difficulty in estimating its nature or culture. So likewise in regard

**Distribution of wealth by wills** - We have divided inheritance into seven categories

The Baha'i laws of inheritance apply only in case of intestacy, that is, when the individual dies without leaving a will. In the Kitab-i-Aqdas (#109), Baha'u'llah instructs every believer to write a will. He elsewhere clearly states that the individual has full jurisdiction over his property and is free to determine the manner in which his or her estate is to be divided and to designate, in the will, those, whether Baha'i or non-Baha'i, who should inherit (Q and A 69). In this connection, a letter written on behalf of Shoghi Effendi explains that:

...even though a Baha'i is permitted in his will to dispose of his wealth in the way he wishes, yet he is morally and conscientiously bound to always bear in mind, while writing his will, the necessity of his upholding the principle of Baha'u'llah regarding the social function of wealth, and the consequent necessity of avoiding its over-accumulation and concentration in a few individuals or groups of individuals.

This verse of the Aqdas introduces a lengthy passage in which Baha'u'llah elaborates the Baha'i law of inheritance. In reading this passage one should bear in mind that the law is formulated with the presumption that the deceased is a man; its provisions apply, *mutatis mutandis*, when the deceased is a woman.

The system of inheritance which provides for distribution of the deceased's estate among seven categories of heirs (children, spouse, father, mother, brothers, sisters, and teachers) is based on the provisions set out by the Báb in the Bayan. The major features of the Baha'i laws of inheritance in the case of intestacy are:

1. If the deceased is a father and his estate includes a personal residence, such residence passes to the eldest son (Q and A 34).
2. If the deceased has no male descendants, two thirds of the residence pass to his female descendants and the remaining third passes to the House of Justice (Q and A 41, 72). See note 42 concerning the levels of the institution of the House of Justice to which this law applies. (See also note 44.)
3. The remainder of the estate is divided among the seven categories of heirs. For details of the number of shares to be received by each group, see Questions and Answers, number 5, and Synopsis and

to the use or abuse of its surplus wealth, or to generous, free-handed cooperation in good public uses, or to unabated efforts to accumulate and hoard to the last, or whether they administer or bequeath. The verdict rests with the best and most enlightened public sentiment. The community will surely judge, and its judgments will not often be wrong.

Codification, section IV.C.3.a.

4. In case there is more than one heir in any category the share allotted to that class should be divided between them equally, be they male or female. (Bahá'u'lláh, Kitáb-i-Aqdas, page 182-183)

20. The best uses to which surplus wealth can be put have already been indicated. Those who would administer wisely must, indeed, be wise; for one of the serious obstacles to the improvement of our race is indiscriminate charity. It were better for mankind that the millions of the rich were thrown into the sea than so spent as to encourage the slothful, the drunken, the unworthy. Of every thousand dollars spent in so-called charity today, it is probable that nine hundred and fifty dollars is unwisely spent -- so spent, indeed, as to produce the very evils which it hopes to mitigate or cure. A well-known writer of philosophic books admitted the other day that he had given a quarter of a dollar to a man who approached him as he was coming to visit the

charity - One demonstration of the excellent character of the Christians in those days was their dedication to charity and good works, and the fact that they founded hospitals and philanthropic institutions. For example, the first person to establish public clinics throughout the Roman Empire where the poor, the injured and the helpless received medical care, was the Emperor Constantine. This great king was the first Roman ruler to champion the Cause of Christ. He spared no efforts, dedicating his life to the promotion of the principles of the Gospel, and he solidly established the Roman government, which in reality had been nothing but a system of unrelieved oppression, on moderation and justice. His blessed name shines out across the dawn of history like the morning star, and his rank and fame among the world's noblest and most highly civilized is still on the tongues of Christians of all denominations.

What a firm foundation of excellent character was laid down in those days, thanks to the training of holy souls who arose to promote the teachings of the Gospel. How many primary schools, colleges, hospitals, were established, and institutions where fatherless and indigent children received their education. How many were the individuals who sacrificed their own personal advantages and "out of desire to please the Lord" devoted the days of their lives to teaching the masses. (Secret of Divine Civilization, page 85)

house of his friend. He knew nothing of the habits of this beggar, knew not the use that would be made of this money, although he had every reason to suspect that it would be spent improperly. This man professed to be a disciple of Herbert Spencer; yet the quarter-dollar given that night will probably work more injury than all the money will do good which its thoughtless donor will ever be able to give in true charity. He only gratified his own feelings, saved himself from

---Page 27 The Gospel of Wealth - II Administration of Wealth---

annoyance -- and this was probably one of the most selfish and very worst actions of his life, for in all respects he is most worthy.

21. In bestowing charity, the main consideration should be to help those who will help themselves; to provide part of the means by which those who desire to improve may do so; to give those who desire to rise the aids by which they may rise; to assist, but rarely or never to do all. Neither the individual nor the race is improved by almsgiving. Those worthy of assistance, except in rare cases, seldom

[charity](#) - "The divine ideals are humility, submissiveness, annihilation of self, perfect evanescence, charity and loving-kindness. You must die to self and live in God. You must be exceedingly compassionate to one another and to all the people of the world. Love and serve mankind just for the sake of God and not for anything else. The foundation of your love toward humanity must be spiritual faith and divine assurance. (Lights of Guidance, page 214)

require assistance. The really valuable men of the race never do, except in case of accident or sudden change. Every one has, of course, cases of individuals brought to his own knowledge where temporary assistance can do genuine good, and these he will not overlook. But the amount which can be wisely given by the individual for individuals is necessarily limited by his lack of knowledge of the circumstances connected with each. He is the only true reformer who is as careful and as anxious not to aid the unworthy as he is to aid the worthy, and, perhaps, even more so, for in almsgiving more injury is probably done by rewarding vice than by relieving virtue.

22. The rich man is thus almost restricted to following the examples of Peter Cooper, Enoch Pratt of Baltimore, Mr. Pratt of Brooklyn, Senator Stanford,

*(7) Of this cluster of philanthropists, Enoch Pratt (1808-1896) was a New Englander who moved to Baltimore and accumulated a fortune as a merchant of iron products and as a general investor. In the eighties he constructed a library building and gave it along with an endowment of over \$800,000 to the City of Baltimore. Carnegie once hailed Pratt as "my pioneer." Charles Pratt (1830-1891), also a New*

**Trades** - It is enjoined upon every one of you to engage in some form of occupation, such as crafts, trades and the like. We have graciously exalted your engagement in such work to the rank of worship unto God, the True One. Ponder ye in your hearts the grace and the blessings of God and render thanks unto Him at eventide and at dawn. Waste not your time in idleness and sloth. Occupy yourselves with that which profiteth yourselves and others. Thus hath it been decreed in this Tablet from whose horizon the day-star of wisdom and utterance shineth resplendent.

The most despised of men in the sight of God are those who sit idly and beg. Hold ye fast unto the cord of material means, placing your whole trust in God, the Provider of all means. When anyone occupieth himself in a craft or trade, such occupation itself is regarded in the estimation of God as an act of worship; and this is naught but a token of His infinite and all-pervasive bounty. (Tablets of Bahá'u'lláh, page 26)

*Englander, moved to New York and established a firm to deal in paints and oils. Sensing in the sixties the importance of petroleum, he was one of the founders of Charles Pratt and Company; the concern refined oil on Long Island. When the Rockefeller interests acquired this business in 1874, Pratt became a member of the high command in Standard Oil. In 1887 his funds and educational acumen led to the opening of the Pratt Institute in Brooklyn, a secondary school for training in the trades. He also established the Pratt Institute Free Library, "the first free public library in either Brooklyn or New York." Leland Stanford (1824-1893), a New Yorker, moved to California, prospered as a wholesale merchant in Sacramento, was Civil War Governor of the State, and one of the "Big Four" associated in promoting, organizing, financing, and building the Central Pacific, the western link of the first transcontinental railroad. Subsequently he became a pioneer in the Southern Pacific Railroad and a United States Senator. In 1884 the death of an only son at the age of fifteen shattered Stanford and his wife. After personal reflection and after seeking advice among educators, the parents founded Leland Stanford Junior University on their Palo Alto "farm." The new institution charged no tuition and emphasized preparation for the practical affairs of life. For many years the Stanford's concerned themselves with the details of university administration, whether in the architecture of the buildings or the character of appointments.*

and others, who know

---Page 28 The Gospel of  
Wealth - II Administration of  
Wealth---

that the best means of



benefiting the community is to place within its reach the ladders upon which the aspiring can rise -- free libraries, parks, and means of recreation, by which men are helped in body and mind; works of art, certain to give pleasure and improve the public taste; and public institutions of various kinds, which will improve the general condition of the people; in this manner returning their surplus wealth to the mass of their fellows in the forms best calculated to do them lasting good.

23. Thus is the problem of rich and poor to be solved. The laws of accumulation will be left free, the laws of distribution free. Individualism will continue, but the millionaire will be but a trustee for the poor, intrusted for a season with a great part of the increased wealth of the community, but administering it for the community far better than it could or would have done for itself. The best minds will thus have reached a stage in the development of the race in which it is clearly seen that there is no mode of disposing of surplus wealth creditable to thoughtful and earnest men into whose hands it flows, save by using it year by year for the general good. This day

[Baha'i Comment](#)

already dawns. Men may die without incurring the pity of their fellows, still sharers in great business enterprises from which their capital cannot be or has not been withdrawn, and which is left chiefly at death for public uses; yet the day is not far distant when the man who dies leaving behind him millions of available wealth, which was free to him to administer during life, will pass away "unwept, unhonored, and unsung," no matter to what uses he leaves the dross which he cannot take with him. Of such as these

---Page 29 The Gospel of Wealth - II Administration of Wealth---

the public verdict will then be: "The man who dies thus rich dies disgraced."

24. Such, in my opinion is the true gospel concerning wealth, obedience to which is destined some day to solve the problem of the rich and the poor, and to bring "Peace on earth, among men good will."

Peace - O RESPECTED Assembly! O friends of Truth! The inherent nature of fire is to burn, the inherent nature of electricity is to give light, the inherent nature of the sun is to shine, and the inherent nature of the organic earth is the power of growth.

There is no separation between a thing and its inherent qualities.

It is the inherent nature of things on this earth to change, thus we see around us the change of the seasons. Every spring is followed by a summer and every autumn brings a winter--every day a night and every evening a morning. There is a sequence in all things.

Thus when hatred and animosity, fighting, slaughtering, and great coldness of heart were governing this world, and darkness had

overcome the nations, Baha'u'llah, like a bright star, rose from the horizon of Persia and shone with the great Light of Guidance, giving heavenly radiance and establishing the new Teaching.

He declared the most human virtues; He manifested the Spiritual powers, and put them into practice in the world around Him.

Firstly: He lays stress on the search for Truth. This is most important, because the people are too easily led by tradition. It is because of this that they are often antagonistic to each other, and dispute with one another.

But the manifesting of Truth discovers the darkness and becomes the cause of Oneness of faith and belief: because Truth cannot be two! That is not possible... .

Eighthly: Baha'u'llah declared the coming of the Most Great Peace. All the nations and peoples will come under the shadow of the Tent of the Great Peace and Harmony--that is to say, by general election a Great Board of Arbitration shall be established, to settle all differences and quarrels between the Powers; so that disputes shall not end in war. ( `Abdu'l-Bahá in London, pages 26-30)

**MENU: [HOME](#) » [Reconstruction](#) » [Gospel Content](#) » [Gospel Purpose](#)**

# The Gospel of Wealth

And Other Timely Essays

by Andrew Carnegie

**In the right-hand commentary column,  
that which is in GREEN is a commentator's remark and  
that which is in BLUE is from the Baha'i Writings.**

**On occasion, in that column, there may be a [link](#) to an extended comment or  
dissertation on the subject under discussion.**

- -

***A reminder that under "view" on your browser - you can set the text size UP  
or DOWN for a more comfortable read for yourself.***

---Page 29 The Gospel of Wealth - II Administration of Wealth---

## **PART II: THE BEST FIELDS FOR PHILANTHROPY**

25. While "The Gospel of Wealth" has met a cordial reception upon this side of the Atlantic, it is natural that in the motherland it should have attracted more attention, because the older civilization is at present brought more clearly face to face with socialistic questions. The contrast between the classes and the masses, between rich and poor, is not yet quite so sharp in this vast, fertile, and developing- continent, with less than twenty persons per square mile, as in crowded little Britain, with fifteen times that number and no territory

**motherland** - As to the patriotic prejudice, this is also due to absolute ignorance, for the surface of the earth is one native land. Every one can live in any spot on the terrestrial globe. Therefore all the world is man's birthplace. These boundaries and outlets have been devised by man. In the creation, such boundaries and outlets were not assigned. Europe is one continent, Asia is one continent, Africa is one continent, Australia is one continent, but some of the souls, from personal motives and selfish interests, have divided each one of these continents and considered a certain part as their own country. God has set up no frontier between France and Germany; they are continuous. Yea, in the first centuries, selfish souls, for the promotion of their own interests, have assigned boundaries and outlets and have, day by day, attached more importance to these, until this led to intense enmity, bloodshed and rapacity in subsequent centuries. In the same way this will continue indefinitely, and if this conception of patriotism remains limited within a certain circle, it will be the primary cause of the world's destruction. No wise and just person will acknowledge these imaginary distinctions. Every limited area which we call our native country we regard as our motherland, whereas the terrestrial globe is the motherland of all, and not any restricted area. In short, for a few days we live on this earth and eventually we are buried in it, it is our eternal tomb. Is it worth while that we should engage in bloodshed and tear one another to pieces

unoccupied. Perhaps the "Pall Mall Gazette" in its issue of September 5 puts most pithily the objections that have been raised to what the English have been pleased to call "The Gospel of Wealth." I quote: "Great fortunes, says Mr. Carnegie, are great blessings to a community, because such and such things may be done with them. Well, but they are also a great curse, for such and such things are done with them. Mr. Carnegie's preaching, in other words, is altogether vitiated by Mr. Benzon's practice.

*(8)Ernest Benzon, commonly known as the "Jubilee plunger," was an English rogue of the fin-de-siecle variety. His career apparently came to grief on the Riviera when he was brought into court for forgery or obtaining money under false pretenses.*

The gospel of wealth is killed by the acts."

26. To this the reply seems obvious: the gospel of Christianity is also killed by the acts. The same objection that is urged against the gospel of wealth lies against the commandment,

---Page 30 The Gospel of Wealth - II Administration of Wealth---

"Thou shalt not steal." It is no

for this eternal tomb? Nay, far from it, neither is God pleased with such conduct nor would any sane man approve of it. (Selections from the Writings of 'Abdu'l-Bahá, page 300-301)

**fortunes** - The highest station, the supreme sphere, the noblest, most sublime position in creation, whether visible or invisible, whether alpha or omega, is that of the Prophets of God, notwithstanding the fact that for the most part they have to outward seeming been possessed of nothing but their own poverty. In the same way, ineffable glory is set apart for the Holy Ones and those who are nearest to the Threshold of God, although such as these have never for a moment concerned themselves with material gain. Then comes the station of those just kings whose fame as protectors of the people and dispensers of Divine justice has filled the world, whose name as powerful champions of the people's rights has echoed through creation. These give no thought to amassing enormous fortunes for themselves; they believe, rather, that their own wealth lies in enriching their subjects. To them, if every individual citizen has affluence and ease, the royal coffers are full. They take no pride in gold and silver, but rather in their enlightenment and their determination to achieve the universal good.

Next in rank are those eminent and honorable ministers of state and representatives, who place the will of God above their own, and whose administrative skill and wisdom in the conduct of their office raises the science of government to new heights of perfection. They shine in the learned world like lamps of knowledge; their thinking, their attitudes and their acts demonstrate their patriotism and their concern for the country's advancement. (Secret of Divine Civilization, page 20-21)

**fortunes** - Those persons who are selected to serve the public, or are appointed to administrative positions, should perform their duties in a spirit of true servitude and ready compliance. That is to say, they should be distinguished by their goodly disposition and virtuous character, content themselves with their allotted remuneration, and act with trustworthiness in all their doings. They should keep themselves aloof from unworthy motives, and be far removed above covetous designs; for rectitude, probity and righteousness are among the most potent means for attracting the grace of God and securing both the prosperity of the country and the welfare of the people. Glory and honour for man are not to be found in fortunes and riches, least of all in those which have been unlawfully amassed through extortion, embezzlement and corruption practised at the expense of an exploited populace. Supreme honour, nobility and greatness in the human world, and true felicity in this life and the life to come--all

argument against a gospel that it is not lived up to; indeed, it is an argument in its favor, for a gospel must be higher than the prevailing standard. It is no argument against a law that it is broken: in that disobedience lies the reason for making and maintaining of the law; the law which is never to be broken is never required.

consist inequity and uprightness, sanctity and detachment. If a man would seek distinction, he should suffice himself with a frugal provision, seek to better the lot of the poor of the realm, choose the way of justice and fair-mindedness, and tread the path of high-spirited service. Such a one, needy though he be, shall win imperishable riches and attain unto everlasting honour. ('Abdu'l-Baha: Trustworthiness, section 2067, pages 342-343 of Compilation of Compilations)

27. Undoubtedly the most notable incident in regard to "The Gospel of Wealth" is that it was fortunate enough to attract the attention of Mr. Gladstone, and bring forth the following note from him: "I have asked Mr. Lloyd Bryce"

**fortunes** - It will not be possible in the future for men to amass great fortunes by the labors of others. The rich will willingly divide. They will come to this gradually, naturally, by their own volition. It will never be accomplished by war and bloodshed. (Bahá'u'lláh & New Era, page 145)

*(9) Lloyd Stephens Bryce (1851-1917) was owner and editor of the North American Review beginning in 1889. He combined the diverse talents of man of wealth, bon vivant, merchant, and member of Congress.*

[North American Review] kindly to allow the republication in this country of the extremely interesting article on 'Wealth' by Mr. Andrew Carnegie, which has just appeared in America." This resulted in the publication of the article in several newspapers and periodicals, and an enterprising publisher issued it in pamphlet form, dedicated by permission to Mr. Gladstone.

28. All this is most encouraging, proving as it does that society is alive to the great issue involved, and is in a receptive mood. Your request, Mr. Editor, that I should continue the subject and point out the best fields for the use of surplus wealth, may be taken as further proof that whether the ideas promulgated are to be received or rejected, they are at least certain to obtain a hearing.

present day Order - "Soon," Baha'u'llah's own words proclaim it, "will the present day Order be rolled up, and a new one spread out in its stead." ...

The Revelation of Baha'u'llah ... should ... be regarded as signaling through its advent the coming of age of the entire human race. It should be viewed not merely as yet another spiritual revival in the ever-changing fortunes of mankind, not only as a further stage in a chain of progressive Revelations, nor even as the culmination of one of a series of recurrent prophetic cycles, but rather as marking the last and highest stage in the stupendous evolution of man's collective life on this planet. The emergence of a world community, the consciousness of world citizenship, the founding of a world civilization and culture ... should ... be regarded, as far as this planetary life is concerned, as the furthestmost limits in the organization of human society, though man, as an individual, will, nay must indeed as a result of such a consummation, continue indefinitely to progress and develop.... (Bahá'u'lláh & New Era, page 279)

29. The first article held that there is but one right mode of using enormous fortunes - namely, that the possessors from time to time during their own lives should so administer these as to promote the permanent good of the communities from which they were gathered. It was held that public sentiment would soon say of one who died possessed of available wealth which he was free to administer: "The man who dies thus rich dies disgraced."

Wealth - To state the matter briefly, the Teachings of Baha'u'llah advocate voluntary sharing, and this is a greater thing than the equalization of wealth. For equalization must be imposed from without, while sharing is a matter of free choice.

Man reacheth perfection through good deeds, voluntarily performed, not through good deeds the doing of which was forced upon him. And sharing is a personally chosen righteous act: that is, the rich should extend assistance to the poor, they should expend their substance for the poor, but of their own free will, and not because the poor have gained this end by force. For the harvest of force is turmoil and the ruin of the social order. On the other hand voluntary sharing, the freely-chosen expending of one's substance, leadeth to society's comfort and peace. It lighteth up the world; it bestoweth honour upon humankind. (Selected Writings of 'Abdu'l-Bahá, Page 115)

---Page 31 The Gospel of  
Wealth - II Administration of  
Wealth---

[Baha'i Comment](#)

30. The purpose of this paper is to present some of the best methods of performing this duty of administering surplus wealth for the good of the people. The first requisite for a really good use of wealth by the millionaire who has accepted the gospel which proclaims him only a trustee of the surplus that come to him, is to take care that the purposes for which he spends it shall not have a degrading, pauperizing tendency upon its recipients, but that his trust shall be so administered as to stimulate the best and most aspiring poor of the community to further efforts for their own improvement. It is not the irreclaimably destitute, shiftless and worthless which it is truly beneficial or truly benevolent for the individual to attempt to reach and improve. For these there exists the refuge provided by the city or the State, where they can be sheltered, fed, clothed, and kept in comfortable existence, and -most important of all - where they can be isolated from the well-doing and, industrious poor, who are liable to be demoralized by contact with these unfortunates. One man or



women who succeeds in living comfortably by begging is more dangerous to society, and a greater obstacle to the progress of humanity, than a score of wordy Socialists. The individual administrator of surplus wealth has as his charge the industrious and ambitious; not those who need everything done for them, but those who, being most anxious and able to help themselves, deserve and will be benefited by help from others and by the extension of their opportunities by the aid of the philanthropic rich.

31. It is ever to be remembered that one of the chief obstacles which the philanthropist meets in his efforts to do real and permanent good in this world, is the practice of indiscriminate giving; and the duty of the millionaire is to resolve to cease giving to objects that are not clearly proved to his satisfaction to be deserving. He must remember Mr. Rice's

*(10) Charles Alien Thorndike Rice (1851-1889), publisher of the North American Review, 1886-1889.*

belief, that nine hundred and fifty out of every thousand dollars

Charity is pleasing and praiseworthy in the sight of God and is regarded as a prince among goodly deeds. Consider ye and call to mind that which the All-Merciful hath revealed in the Qur'an: `They prefer them before themselves, though poverty be their own lot. And with such as are preserved from their own covetousness shall it be well.' Viewed in this light, the blessed utterance above is, in truth, the day-star of utterances. Blessed is he who preferreth his brother before himself. Verily, such a man is reckoned, by virtue of the Will of God, the All-Knowing, the All-Wise, with the people of Baha who dwell in the Crimson Ark. (Tablets of Bahá'u'lláh, page 71)

---Page 32 The Gospel of  
Wealth - II Administration of  
Wealth---

bestowed to-day upon so-called charity had better be thrown into the sea. As far as my experience of the wealthy extends, it is unnecessary to urge them to give of their superabundance in charity so called. Greater good for the race is to be achieved by inducing them to cease impulsive and injurious giving. As a rule, the sins of millionaires in this respect are not those of omission, but of commission, because they do not take time to think, and chiefly because it is much easier to give than to refuse. Those who have surplus wealth give millions every year which produce more evil than good, and really retard the progress of the people, because most of the forms in vogue to-day for benefiting mankind only tend to spread among the poor a spirit of dependence upon alms, when what is essential for progress is that they should be inspired to depend upon their own exertions. The miser millionaire who hoards his wealth does less injury to society than the careless millionaire who squanders his unwisely, even if he does so under cover of the mantle of sacred charity. The man who

gives to the individual beggar commits a grave offense, but there are many societies and institutions soliciting alms, to aid which is none the less injurious to the community. These are as corrupting as individual beggars. Plutarch's "Morals" contains this lesson: "A beggar asking an alms of a Lacedaemonian, he said: 'Well, should I give thee anything, thou wilt be the greater beggar, for he that first gave thee money made thee idle, and is the cause of this base and dishonorable way of living.'" As I know them, there are few millionaires, very few indeed, who are clear of the sin of having made beggars.

32. Bearing in mind these considerations, let us endeavor to present some of the best uses to which a millionaire can devote the surplus of which he should regard himself as only the trustee.

**wealthy** - In the Bolshevistic principles equality is effected through force. The masses who are opposed to the people of rank and to the wealthy class desire to partake of their advantages.

But in the divine teachings equality is brought about through a ready willingness to share. It is commanded as regards wealth that the rich among the people, and the aristocrats should, by their own free will and for the sake of their own happiness, concern themselves with and care for the poor. This equality is the result of the lofty characteristics and noble attributes of mankind. (Abdu'l-Baha: Foundations of World Unity, Page: 44)

**33. *First.* Standing apart by itself there is the founding of a university by men enormously rich, such men as must necessarily be few in any country. Perhaps the greatest sum ever**

**---Page 33 The Gospel of Wealth - II Administration of Wealth---**

**given by an individual for any purpose is the gift of Senator Stanford, who undertakes to establish a complete university upon the Pacific coast, where he amassed his enormous fortune, which is said to involve the expenditure of ten millions of dollars, and upon which he may be expected to bestow twenty millions of his surplus. He is to be envied. A thousand years hence some orator, speaking his praise upon the then crowded shores of the Pacific, may thus adapt Griffith's eulogy of Wolsey:**

**In bestowing,  
madam,  
He was most princely.  
Ever witness for him  
This seat of learning,...  
    though unfinished,  
    yet so famous.  
So excellent in art, and  
still so rising,  
That Christendom shall  
ever speak his virtue.**

**enormously rich** - It should not be imagined that the writer's earlier remarks constitute a denunciation of wealth or a commendation of poverty. Wealth is praiseworthy in the highest degree, if it is acquired by an individual's own efforts and the grace of God, in commerce, agriculture, art and industry, and if it be expended for philanthropic purposes. Above all, if a judicious and resourceful individual should initiate measures which would universally enrich the masses of the people, there could be no undertaking greater than this, and it would rank in the sight of God as the supreme achievement, for such a benefactor would supply the needs and insure the comfort and well-being of a great multitude. Wealth is most commendable, provided the entire population is wealthy. If, however, a few have inordinate riches while the rest are impoverished, and no fruit or benefit accrues from that wealth, then it is only a liability to its possessor. If, on the other hand, it is expended for the promotion of knowledge, the founding of elementary and other schools, the encouragement of art and industry, the training of orphans and the poor--in brief, if it is dedicated to the welfare of society--its possessor will stand out before God and man as the most excellent of all who live on earth and will be accounted as one of the people of paradise. ('Abdu'l-Bahá, Secret of Divine Civilization, page 24 & 25)

*(11) Quoted inaccurately from Henry VIII, Act IV, scene 2, lines 51 ff.*

**34. Here is a noble use of wealth. We have many such institutions, - Johns Hopkins, Cornell, Packer, and others,**

*(12) In the founding of universities by private wealth in the post-Civil War era, the names of institutions perpetuate the donations and other assistance of Johns Hopkins (1795-1873), a Baltimore philanthropist, and Ezra Cornell (1807-1874), an upstate New Yorker who built a fortune from the telegraph. Asa Packer (1805-1879), a New England youth who emigrated to Pennsylvania, acquired his fortune from transporting and mining coal in the anthracite region. He was a judge and a politician. After the Civil War Packer donated money and land to a new institution, Lehigh University. He originally had in mind a technical institution, but when the school was opened in 1885 its scheme was more traditional. The total of Packer's donations in his lifetime gifts and bequests was over \$3,800,000.*

-- but most of these have only been bequeathed, and it is impossible to extol any man greatly for simply leaving what he cannot take with him. Cooper and Pratt and Stanford, and others of this class, deserve credit and admiration as much for the time and attention given during their lives as for their expenditure upon their respective monuments.

**bequeath** - If a wealthy man at the time of his death bequeaths a gift to the poor and miserable, and gives a part of his wealth to be spent for them, perhaps this action may be the cause of his pardon and forgiveness, and of his progress in the Divine Kingdom. (Abdu'l-Baha: Some Answered Questions, Page: 231)

**35. We cannot think of the Pacific coast without recalling another important work of a different character which has recently been established there - the Lick Observatory.**

*(13)James Lick (1796-1876), an eccentric who made a fortune from investments in San Francisco real estate and California land, was with difficulty guided by careful advisers to give \$700,000 for a telescope "superior to and more powerful than any telescope ever made." Previous to this decision he had never seen a telescope or looked through one and had not even an amateur's acquaintance with astronomy. Eventually the managers of the gift located the Lick observatory on Mt. Hamilton, a wilderness peak in Santa Clam County, and contracted for a 36-inch lens, the largest feasible under the technology of the eighties. The regents of the University of California became the trustees of the Lick observatory.*

**---Page 34 The Gospel of Wealth - II Administration of Wealth---**

**If any millionaire be interested in the ennobling study of astronomy, -and there should be and would be such if they but gave the subject the slightest attention, -here is an example which could well be followed, for the progress made in astronomical instruments and appliances is so great and continuous that every few years a new telescope might be judiciously given to one of the observatories upon this**

University -

In brief, man through the possession of this ideal endowment of scientific investigation is the most noble product of creation, the governor of nature. He takes the sword from nature's hand and uses it upon nature's head. According to natural law night is a period of darkness and obscurity, but man by utilizing the power of electricity, by wielding this electric sword overcomes the darkness and dispels the gloom. Man is superior to nature and makes nature do his bidding. Man is a sensitive being; nature is without sensation. Man has memory and reason; nature lacks them. Man is nobler than nature. There are powers within him of which nature is devoid. It may be claimed that these powers are from nature itself and that man is a part of nature. In answer to this statement we will say that if nature is the whole and man is a part of that whole, how could it be possible for a part to possess qualities and virtues which are absent in the whole? Undoubtedly the part must be endowed with the same qualities and properties as the whole. For example, the hair is a part of the human anatomy. It cannot contain elements which are not found in other parts of the body, for in all cases the component elements of the body are the same. Therefore, it is manifest and evident that man, although in body a part of nature, nevertheless in spirit possesses a power transcending nature; for if he were simply a part of nature and limited to material laws, he could possess only the things which nature embodies. God has conferred upon and added to man a distinctive power - the faculty of intellectual investigation into the secrets of creation, the acquisition of higher knowledge - the greatest virtue of which is scientific enlightenment. This endowment is the most praiseworthy power of man, for through its employment and exercise the betterment of the human race is accomplished, the development of the virtues of mankind is made possible and the spirit and mysteries of God become manifest. Therefore, I am greatly pleased with my visit to this university. Praise be to God that this country abounds in such institutions of learning where the knowledge of sciences and arts may readily be acquired. As material and physical sciences are taught here and are constantly unfolding in wider vistas of attainment, I am hopeful that spiritual development may also follow and keep pace with these outer advantages. As material knowledge is illuminating those within the walls of this great temple of learning, so also may the light of the spirit, the inner and divine light of the real philosophy glorify this institution. The most important principle of divine philosophy is the oneness of the world of humanity, the unity of mankind, the bond conjoining East and West, the tie of love which blends human hearts. (Abdu'l-Baha: Promulgation of Universal Peace, Pages: 30-31)

continent, the last being always the largest and the best, and certain to carry further and further the knowledge of the universe and of our relation to it here upon the earth. As one among many of the good deeds of the late Mr. Thaw of Pittsburg, his constant support of the observatory there may be mentioned. This observatory enabled Professor Langley to make his wonderful discoveries. He is now at the head of the Smithsonian Institution, a worthy successor to Professor Henry. Connected with him was Mr. Braeshier of Pittsburg, whose instruments are in most of the principal observatories of the world. He was a common millwright, but Mr. Thaw recognized his genius and was his main support through trying days. This common workman has been made a professor by one of the foremost scientific bodies of the world. In applying part of his surplus in aiding these two now famous men, the millionaire Thaw did a noble work. Their joint labors have brought great credit, and are destined to bring still greater credit, upon their country in every scientific center throughout the world.

*(14) Pittsburgh immediately after the Civil War became a center of astronomical activity and*

*scholarship. A popular subscription had raised funds to build in 1860 the old Allegheny observatory, and five years later it was transferred to the Western University of Pennsylvania (since 1908 the University of Pittsburgh). In 1867 Samuel P. Langley (1834-1906), a man of immense erudition and scientific originality, became director of the observatory and professor of physics and astronomy. Twenty years later Langley became the third secretary of the Smithsonian Institution. Meanwhile, John Alfred Brashear (1840-1920) -- one of many variant spellings -- a Pittsburgh machinist who in his youth had been inspired by a maternal grandfather with a love of the stars, had built his own telescope and had attracted the attention of Langley. William Thaw, who had acquired wealth as a freight forwarder and Pennsylvania Railroad official and investor, was a director of Western University. He financed Langley's researches--the observatory incidentally provided correct time for the railroad -- and enabled Brashear to set up in business as a maker of precision instruments and telescopes. Carnegie later selected him as one of three men to draw up plans for the Carnegie Institute of Technology founded in 1905.*

### ---Page 35 The Gospel of Wealth - II Administration of Wealth---

**36. It is reserved for very few to found universities, and, indeed, the use for many, or perhaps, any, new universities does not exist. More good is henceforth to be accomplished by adding to and extending those in existence. But in this department a wide field**

**universities** - In these days there are new schools of philosophy blindly claiming that the world of nature is perfect. If this is true, why are children trained and educated in schools, and what is the need of extended courses in sciences, arts and letters in colleges and universities? What would be the result if humanity were left in its natural condition without education or training? All scientific discoveries and attainments are the outcomes of knowledge and education. The telegraph, phonograph, telephone were latent and potential in the world of nature but would never have come forth into the realm of visibility unless man through education had penetrated and discovered the laws which control them. All the marvelous developments and miracles of what we call civilization would have remained hidden, unknown and, so to speak, nonexistent, if man had remained in his natural condition, deprived of the bounties, blessings and benefits of education and mental culture. The intrinsic difference between the ignorant man and the



remains for the millionaire as distinguished from the Croesus among millionaires. The gifts to Yale University have been many, but there is plenty of room for others. The School of Fine Arts, founded by Mr. Street, the Sheffield Scientific School, endowed by Mr. Sheffield, and Professor Loomis's fund for the observatory, are fine examples. Mrs. C. J. Osborne's building for reading and recitation is to be regarded with especial pleasure as being the wise gift of a woman.

*(15) A series of gifts enlarged the physical facilities and instructional offerings of Yale College. Just before the Civil War Joseph E. Sheffield (1793-1882), a Connecticut man who had made a fortune as a railroad contractor in the West and, out of personal and civic pride, spent some of it financing a needless New England railroad, gave the first of his donations to the Yale Scientific School, renamed the Sheffield Scientific School in 1861. After the War, Augustus R. Street (1791-1866), a New Haven-born Yale graduate, and his wife, a woman of wealth, financed a building for the Yale School of Fine Arts and endowed instruction in a number of areas at Yale. In the late eighties Elias Loomis (1811-1889), who had made a fortune as author of books in the field of natural science, bequeathed \$300,000 to Yale. Mrs. Miriam A. (C.J.) Osborn gave in the eighties a sum for a building for history. Its construction "resulted in the removal of the Fence."*

astute philosopher is that the former has not been lifted out of his natural condition, while the latter has undergone systematic training and education in schools and colleges until his mind has awakened and unfolded to higher realms of thought and perception; otherwise, both are human and natural. ('Abdu'l-Bahá, Promulgation of Universal Peace, page 309-310)

Harvard University has not

been forgotten; the Peabody Museum and the halls of Wells, Matthews, and Thayer may be cited. Sever Hall is worthy of special mention, as showing what a genius like Richardson could do with the small sum of a hundred thousand dollars.

*(16)Mr. Carnegie's stroll through Harvard produced some inaccurate observations. George Peabody (1795-1869), an American banker in London, donated in 1866, at the suggestion of a Yale nephew, \$150,000 for a "Museum and professorship of American Archaeology and Ethnology." But there is not and never was a Wells Hall. This is a mistake for Weld Hall, given in 1872 by W. F. Weld, a Boston financier, in memory of his brother. Like Weld, the other "halls" were dormitories. Matthews Hall was the gift in 1872 of Nathan Matthews (1854-1927), a Boston merchant; Thayer Hall, of Nathaniel Thayer (1808-1883), a member of a Boston investment banking house, in memory of his brother. Colonel James W. Sever, a shoeman in southeastern Massachusetts, bequeathed \$100,000 for a hall to be named for the family. Sever Hall is a classroom building.*

---Page 36 The Gospel of Wealth - II Administration of Wealth---

The Vanderbilt University, at Nashville, Tennessee, may be mentioned as a true product of the gospel of wealth. It was established by the members of the Vanderbilt family

*(17) The first Vanderbilt gift to the Central University of the Methodist*

*Episcopal Church of the South at Nashville came from Cornelius ("The Commodore") Vanderbilt (1794-1877), veteran steamship tycoon and virtually a synonym for the New York Central Railroad. Since the Commodore became Vanderbilt's benefactor in a decidedly offhand manner, Carnegie's note of admiration is surprising. In time the Commodore's descendants generously supplemented his original benefaction.*

during their lives - mark this vital feature, during their lives; for nothing counts for much that is left by a man at his death. Such funds are torn from him, not given by him. If any millionaire be at a loss to know how to accomplish great and indisputable good with his surplus, here is a field which can never be fully occupied, for the wants of our universities increase with the development of the country.

37. *Second* The result of my own study of the question. What is the best gift which can be given to a community? is that a free library occupies the first place, providing the community will accept and maintain it as a public institution, as much a part of the city property as its public schools, and indeed, an adjunct to these. It is, no doubt, possible that my own possible experience may have led me to value a free library beyond all other forms of

[Baha'i Comment](#)

beneficence. When I was a working-boy in Pittsburg, Colonel Anderson of Allegheny -a name I can never speak without feelings of devotional gratitude - opened his little library of four hundred books to boys. Every Saturday afternoon he was in attendance at his house to exchange books. No one but he who has felt it

---Page 37 The Gospel of Wealth - II Administration of Wealth---

can ever know the intense longing with which the arrival of Saturday was awaited, that a new book might be had. My brother and Mr. Phipps,

*(18)Thomas M. Carnegie (1843-1886), a younger brother of Andrew, followed a somewhat similar career. Henry Phipps, Jr. (1839-1930), was a boyhood neighbor and chum of Andrew. Tom Carnegie and Phipps early entered the iron business. Tom died in 1886; Phipps stayed with the Carnegie firm until its acquisition by United States Steel in 1901. His money supported a wide variety of philanthropic undertakings from public baths to psychiatric institutes.*

*Whatever may have been done in these four years, it is my pleasure to acknowledge that much, very much, is due to the earnest interest, the wise counsels, and the practical suggestions of Mr. Pratt. He never seemed to feel that the mere donation of great wealth for the benefit of his fellow-citizens was all that would be asked of him, but he wisely*

*labored to make its application as comprehensive and effective as possible. Thus he constantly lightened burdens that were, at times, very heavy, brought good cheer and bright sunshine when clouds flitted across the sky, and made every officer and employee feel that good work was appreciated, and loyal devotion to duty would receive hearty commendation.*

who have been my principal business partners through life, shared with me Colonel Anderson's precious generosity, and it was when reveling in the treasures which he opened to us that I resolved, if ever wealth came to me, that it should be used to establish free libraries, that other poor boys might receive opportunities similar to those for which we were indebted to that noble man.

38. Great Britain has been foremost in appreciating the value of free libraries for its people. Parliament passed an act permitting towns and cities to establish and maintain these as municipal institutions; whenever the people of any town or city voted to accept the provisions of the act, the authorities were authorized to tax the community to the extent of one penny in the pound valuation. Most of the towns already have free libraries under this act. Many of these

[Baha'i Comment](#)

are the gifts of rich men, whose funds have been used for the building, and in some cases for the books also, the communities being required to maintain and to develop the libraries. And to this feature I attribute most of their usefulness. An endowed institution is liable to become the prey of a clique. The public ceases to take interest in it, or rather, never acquires interest in it. The rule has been violated which requires the recipients to help themselves. Everything has been done for the community instead of its being only helped to help itself, and good results rarely ensue.

39. Many free libraries have been established in our country, but none that I know of with such wisdom as the Pratt Library in Baltimore. Mr. Pratt built and presented the library

---Page 38 The Gospel of Wealth - II Administration of Wealth---

to the city of Baltimore, with the balance of cash handed over; the total cost was one million dollars, upon which he required the city to pay five per cent, per annum, fifty thousand dollars per year, to trustees for the maintenance

[Baha'i Comment](#)

and development of the library and its branches. During 1888 430,217 books were distributed; 37,196 people of Baltimore are registered upon the books as readers. And it is safe to say that 37,000 frequenters of the Pratt Library are of more value to Baltimore, to the State, and to the country, than all the inert, lazy, and hopelessly poor in the whole nation. And it may further be safely said that, by placing books within the reach of 37,000 aspiring people which they were anxious to obtain, Mr. Pratt has done more for the genuine progress of the people than has been done by all the contributions of all the millionaires and rich people to help those who cannot or will not help themselves. The one wise administrator of his surplus has poured a fertilizing stream upon soil that was ready to receive it and return a hundred-fold. The many squanderers have not only poured their streams into sieves which can never be filled - they have done worse; they have poured them into stagnant sewers that breed the diseases which most afflict the body politic. And this is not all. The million dollars of which Mr. Pratt has made so grand a use are something, but there is something greater still. When the fifth branch

library was opened in Baltimore, the speaker said:

---Page 39 The Gospel of Wealth - II Administration of Wealth---

40. This is the finest picture I have ever seen of any of the millionaire class. As here depicted, Mr. Pratt is the ideal disciple of the gospel of wealth. We need have no fear that the mass of toilers will fail to recognize in such as he their best leaders and their most invaluable allies; for the problem of poverty and wealth, of employer and employed, will be practically solved whenever the time of the few is given, and their wealth is administered during their lives, for the best good of that portion of the community which has not been burdened with the responsibilities which attend the possession of wealth. We shall have no antagonism between classes when that day comes, for the high and the low, the rich and the poor, shall then indeed be brothers.

**riches** - Those persons who are selected to serve the public, or are appointed to administrative positions, should perform their duties in a spirit of true servitude and ready compliance. That is to say, they should be distinguished by their goodly disposition and virtuous character, content themselves with their allotted remuneration, and act with trustworthiness in all their doings. They should keep themselves aloof from unworthy motives, and be far removed above covetous designs; for rectitude, probity and righteousness are among the most potent means for attracting the grace of God and securing both the prosperity of the country and the welfare of the people. Glory and honour for man are not to be found in fortunes and riches, least of all in those which have been unlawfully amassed through extortion, embezzlement and corruption practised at the expense of an exploited populace. Supreme honour, nobility and greatness in the human world, and true felicity in this life and the life to come--all consist inequity and uprightnes, sanctity and detachment. If a man would seek distinction, he should suffice himself with a frugal provision, seek to better the lot of the poor of the realm, choose the way of justice and fair-mindedness, and tread the path of high-spirited service. Such a one, needy though he be, shall win imperishable riches and attain unto everlasting honour. ('Abdu'l-Baha: Cited in Trustworthiness, section 2067, pages 342-343 of Compilation of Compilations)



41. No millionaire will go far wrong in his search for one of the best forms for the use of his surplus who chooses to establish a free library in any community that is willing to maintain and develop it. John Bright's

*(19) The noted British liberal statesman, reformer, and orator (1811-1889), who believed strongly in self-education.*

words should ring in his ear: "It is impossible for any man to bestow a greater benefit upon a young man than to give him access to books in a free library." Closely allied to the library, and, where possible, attached to it, there should be rooms for an art gallery and museum, and a hall for such lectures and instruction as are provided in the Cooper Union. The traveler upon the Continent is surprised to find that every town of importance has its art-gallery and museum; these may be large or small, but each has a receptacle for the treasures of the locality, in which are constantly being placed valuable gifts and bequests. The Free Library and Art Gallery of Birmingham are remarkable among such institutions, and every now and then a rich man adds to their value by presenting books, fine pictures, or other works of art. All that our cities

**bequeath** - If a wealthy man at the time of his death bequeaths a gift to the poor and miserable, and gives a part of his wealth to be spent for them, perhaps this action may be the cause of his pardon and forgiveness, and of his progress in the Divine Kingdom. ('Abdu'l-Bahá, Some Answered Questions, page 231)

require, to begin with, is a proper fire-proof building. Their citizens who travel will send to it rare and costly things from every quarter of the globe they visit, while those who remain at

---Page 40 The Gospel of Wealth - II Administration of Wealth---

home will give or bequeath to it of their treasures. In this way collections will grow until our cities will ultimately be able to boast of permanent exhibitions from which their own citizens will derive incalculable benefit, and which they will be proud to show to visitors. In the Metropolitan Museum of Art in New York we have made an excellent beginning. Here is another avenue for the proper use of surplus wealth.

42. *Third* We have another most important department in which great sums can be worthily used - the founding or extension of hospitals, medical colleges, laboratories, and other institutions connected with the alleviation of human suffering, and especially with the prevention rather than cure of human ills. There is no danger of pauperizing a community in giving for such purposes,

[hospitals](#) - This Baha'i teaching of human fellowship and kindness implies that we must be always ready to extend every assistance and help we can to those who are in distress and suffering. Baha'i charity is of the very essence of the Teachings, and should therefore be developed in every Baha'i community. Charitable institutions such as orphanages, free schools and hospitals for the poor, constitute an indispensable part of the Mashriqu'l-Adhkar. It is the responsibility of every local Baha'i community to insure the welfare of its poor and needy members, through whatever means possible. (Lights of Guidance, page 120-121)

because such institutions relieve temporary ailments or shelter only those who are hopeless invalids. What better gift than a hospital can be given to a community that is without one? - the gift being conditioned upon its proper maintenance by the community in its corporate capacity. If hospital accommodation already exists, no better method for using surplus wealth can be found than in making additions to it. The late Mr. Vanderbilt's gift of half a million dollars to the Medical Department of Columbia College for a chemical laboratory was one of the wisest possible uses of wealth.

*(20) Gifts from the Vanderbilts enabled Columbia's College of Physicians and Surgeons in the eighties to move to a new location and plant on West 59th Street. W. H. Vanderbilt (1821-1885), the son of the Commodore and an exceedingly able business man in his own right, was for the moment the chief of the Vanderbilt givers.*

It strikes at the prevention of disease by penetrating into its causes. Several others have established such laboratories, but the need for them is still great.

43. If there be a millionaire in the land who is at a loss what to do with the surplus that has been committed to him as trustee, let him investigate the good that is flowing from these chemical laboratories. No medical college is complete

---Page 41 The Gospel of Wealth - II Administration of Wealth---

without its laboratory. As with universities, so with medical colleges: it is not new institutions that are required, but additional means for the more thorough equipment of those that exist. The forms that benefactions to these may wisely take are numerous, but probably none is more useful than that adopted by Mr. Osborne when he built a school for training female nurses at Bellevue College.

*(21) William Henry Osborn (1820-1894), reorganizer and financial savior of the Illinois Central Railroad, after his retirement in 1882 became interested in aiding medical institutions, among which was the Bellevue Training School for Nurses in New York City.*

If from all gifts there flows one half of the good that comes from this wise use of a millionaire's surplus, the most exacting may well be satisfied. Only those who have passed

millionaire - What could be better before God than thinking of the poor? For the poor are beloved by our heavenly Father. When Christ came upon the earth, those who believed in Him and followed Him were the poor and lowly, showing that the poor were near to God. When a rich man believes and follows the Manifestation of God, it is a proof that his wealth is not an obstacle and does not prevent him from attaining the pathway of salvation. After he has been tested and tried, it will be seen whether his possessions are a hindrance in his religious life. But the poor are especially beloved of God. Their lives are full of difficulties, their trials continual, their hopes are in God alone. Therefore, you must assist the poor as much as possible, even by sacrifice of yourself. No deed of man is greater before God than helping the poor. Spiritual conditions are not dependent upon the possession of worldly treasures or the absence of them. When one is physically destitute, spiritual thoughts are more likely. Poverty is a stimulus toward God. Each one of you must have great consideration for the poor and render them assistance. Organize in an effort to help them and prevent increase of poverty. The greatest means for prevention is that whereby the laws of the community will be so framed and enacted that it will not be possible for a few to be millionaires and many destitute. One of Baha'u'llah's teachings is the adjustment of means of livelihood in human society. Under this adjustment there can be no extremes in human conditions as regards wealth and sustenance. For the community needs financier, farmer, merchant and laborer just as an army must be composed of commander, officers and privates. All cannot be commanders; all cannot be officers or privates. Each in his station in the social fabric must be competent - each in his function according to ability but with justness of opportunity for all. (Abdu'l-Baha: Promulgation of Universal Peace, Page: 216)

through a lingering and dangerous illness can rate at their true value the care, skill, and attendance of trained female nurses. Their employment as nurses has enlarged the sphere and influence of woman. It is not to be wondered at that a senator of the United States, and a physician distinguished in this country for having received the highest distinctions abroad, should recently have found their wives in this class.

**44. *Fourth*** In the very front rank of benefactions public parks should be placed, always provided that the community undertakes to maintain, beautify and preserve them inviolate. No more useful or more beautiful monument can be left by any man than a park for the city in which he was born or in which he has long lived, nor can the community pay a more graceful tribute to the citizen who presents it than to give his name to the gift. Mrs. Schenley's gift last month of a large park to the city of Pittsburg deserves to be noted. This lady, although born in Pittsburg, married an English gentleman while yet in her teens. It is forty years and more since she took up her residence in London among

**wealthy** - Through the ingenuity and inventions of man it is possible to cross the wide oceans, fly through the air and travel in submarine depths. At any moment the Orient and Occident can communicate with each other. Trains speed across the continents. The human voice has been arrested and reproduced, and now man can speak at long distances from any point. These are some of the signs of this glorious century. The great progress mentioned has taken place in the material world. Remarkable signs and evidences have become manifest. Hidden realities and mysteries have been disclosed. This is the time for man to strive and put forth his greatest efforts in spiritual directions. Material civilization has reached an advanced plane, but now there is need of spiritual civilization. Material civilization alone will not satisfy; it cannot meet the conditions and requirements of the present age; its benefits are limited to the world of matter. There is no limitation to the spirit of man, for spirit in itself is progressive, and if the divine civilization be established, the spirit of man will advance. Every developed susceptibility will increase the effectiveness of man. Discoveries of the real will become more and more possible, and the influence of divine guidance will be increasingly recognized. All this is conducive to the divine form of civilization. This is what is meant in the Bible by the descent of the New Jerusalem. The heavenly Jerusalem is none other than divine civilization, and it is now ready. It is to be and shall be organized, and the oneness of humankind will be a visible fact. Humanity will then be brought together as one. The various religions will be united, and different races will be known as one kind. The Orient and Occident will be conjoined, and the banner of international peace will be unfurled. The world shall at last find peace, and the equalities and rights of men shall be established. The

the titled and the wealthy of the world's metropolis, but still she turns to the home of her childhood and by means of Schenley Park links her name with it forever.

*(22) Pittsburgh advocates of parks induced Mrs. Mary E. Schenley to donate 300 acres for a park and the city purchased for \$200,000 an additional acreage. In addition to facilities for sports and beauty, Schenlev Park was the site of the Phipps conservatories, the first Carnegie Pittsburgh Library, and the Carnegie Institute.*

---Page 42 The Gospel of Wealth - II Administration of Wealth---

A noble use this of great wealth by one who thus becomes her own administrator. If a park be already provided, there is still room for many judicious gifts in connection with it. Mr. Phipps of Allegheny has given conservatories to the park there, which are visited by many every day of the week, and crowded by thousands of working-people every Sunday; for, with rare wisdom, he has stipulated. as a condition of the gift that the conservatories shall be open on Sundays. The result of his experiment has been so gratifying that he finds himself justified in adding to them from his surplus, as he is doing largely this year. To lovers of flowers among the

capacity of humankind will be tested, and a degree shall be attained where equality is a reality.

All the peoples of the world will enjoy like interests, and the poor shall possess a portion of the comforts of life. Just as the rich are surrounded by their luxuries in palaces, the poor will have at least their comfortable and pleasant places of abode; and just as the wealthy enjoy a variety of food, the needy shall have their necessities and no longer live in poverty. In short, a readjustment of the economic order will come about, the divine Sonship will attract, the Sun of Reality will shine forth, and all phenomenal being will attain a portion. (Abdu'l-Baha: Promulgation of Universal Peace\*, Pages: 101-102)

wealthy I commend a study of what is possible for them to do in the line of Mr. Phipps's example; and may they please note that Mr. Phipps is a wise as well as a liberal giver, for he requires the city to maintain these conservatories, and thus secures for them forever the public ownership, the public interest, and the public criticism of their management. Had he undertaken to manage and maintain them, it is probable that popular interest in the gift would never have been awakened.

45. The parks and pleasure-grounds of small towns throughout Europe are not less surprising than their libraries, museums, and art-galleries. I saw nothing more pleasing during my recent travels than the hill at Bergen, in Norway. It has been converted into one of the most picturesque of pleasure-grounds; fountains, cascades, waterfalls, delightful arbors, fine terraces, and statues adorn what was before a barren mountain-side. Here is a field worthy of study by the millionaire who would confer a lasting benefit upon his fellows. Another beautiful instance of the right use of wealth in the direction of making cities more and more

[Baha'i Comment](#)

attractive is to be found in Dresden. The owner of the leading paper there bequeathed its revenues forever to the city, to be used in

---Page 43 The Gospel of Wealth - II Administration of Wealth---

beautifying it. An art committee decides, from time to time, what new artistic feature is to be introduced, or what hideous feature is to be changed, and as the revenues accrue, they are expended in this direction. Thus, through the gift of this patriotic newspaper proprietor his native city of Dresden is fast becoming one of the most artistic places of residence in the whole world. A work having been completed, it devolves upon the city to maintain it forever. May I be excused if I commend to our millionaire newspaper proprietors the example of their colleague in the capital of Saxony?



**46. Scarcely a city of any magnitude in the older countries is without many structures and features of great beauty. Much has been spent upon ornament, decoration, and architectural effect. We are still far behind in these things upon this side of the Atlantic. Our Republic is great in some things in material development unrivaled; but let us always remember that in art and in the finer touches we have scarcely yet taken a place. Had the exquisite Memorial Arch recently erected temporarily in New York been shown in Dresden, the art committee there would probably have been enabled, from the revenue of the newspaper given by its owner for just such purposes, to order its permanent erection to adorn the city forever.**

*Popular subscriptions have accomplished this result in the case referred to (the Washington Monument), and two other memorial arches have been designed and are to be erected here. -- ED. [Note in original edition.]*

**material development** - Baha'u'llah has announced that no matter how far the world of humanity may advance in material civilization, it is nevertheless in need of spiritual virtues and the bounties of God. The spirit of man is not illumined and quickened through material sources. It is not resuscitated by investigating phenomena of the world of matter. The spirit of man is in need of the protection of the Holy Spirit. Just as he advances by progressive stages from the mere physical world of being into the intellectual realm, so must he develop upward in moral attributes and spiritual graces. In the process of this attainment he is ever in need of the bestowals of the Holy Spirit. Material development may be likened to the glass of a lamp whereas divine virtues and spiritual susceptibilities are the light within the glass. The lamp chimney is worthless without the light; likewise man in his material condition requires the radiance and vivification of the divine graces and merciful attributes. Without the presence of the Holy Spirit he is lifeless. Although physically and mentally alive he is spiritually dead. His Holiness Christ announced, "That which is born of flesh is flesh and that which is born of spirit is spirit," meaning that man must be born again. As the babe is born into the light of this physical world so must the physical and intellectual man be born into the light of the world of divinity. In the matrix of the mother the unborn child was deprived and unconscious of the world of material existence but after its birth it beheld the wonders and beauties of a new realm of life and being. In the world of the matrix it was utterly ignorant and unable to conceive of these new conditions but after its transformation it discovers the radiant sun, trees, flowers and an infinite range of blessings and bounties awaiting it. In the human plane and kingdom man is a captive of nature and ignorant of the divine world until born of the breaths of the Holy Spirit out of physical conditions of limitation and deprivation. Then he beholds the reality of the spiritual realm and kingdom, realizes the narrow restrictions of the mere human world of existence and becomes conscious of the unlimited and infinite glories of the world of God. Therefore no matter how man may advance upon the physical and intellectual plane he is ever in need of the boundless virtues of divinity, the protection of the Holy Spirit and the face of God. (Foundations of World Unity, Page 59)

47. While the bestowal of a park upon a community will be universally approved as one of the best uses for surplus wealth, in embracing such additions to it as conservatories, or in advocating the building of memorial arches and works of adornment, it is probable that many will think I go too far, and consider these somewhat fanciful. The material good to flow from them may not be so directly visible; but let not any practical mind, intent only upon material good, depreciate the value of wealth given for these or for kindred esthetic purposes as being useless as far as the mass

---Page 44 The Gospel of Wealth - II Administration of Wealth---

of the people and their needs are concerned. As with libraries and museums, so with these more distinctively artistic works: they perform their great use when they reach the best of the masses of the people. It is better to reach and touch the sentiment for beauty in the naturally bright minds of this class than to pander to those incapable of being so touched. For what the improver of the race must endeavor is to reach those who have the divine spark

[Baha'i Comment](#)

ever so feebly developed, that it may be strengthened and grow. For my part, I think Mr. Phipps put his money to better use in giving the working-men of Allegheny conservatories filled with beautiful flowers, orchids, and aquatic plants, which they, with their wives and children, can enjoy in their spare hours, and upon which they can feed their love for the beautiful, than if he had given his surplus money to furnish them with bread; for those in health who cannot earn their bread are scarcely worth considering by the individual giver, the care of such being the duty of the State. The man who erects in a city a conservatory or a truly artistic arch, statue, or fountain, makes a wise use of his surplus. "Man does not live by bread alone."

48. *Fifth.* We have another good use for surplus wealth in providing our cities with halls suitable for meetings of all kinds and for concerts of elevating music. Our cities are rarely possessed of halls for these purposes, being in this respect also very far behind European cities. Springer Hall, in Cincinnati, a valuable addition to the city, was largely the gift of Mr. Springer, who was not content to bequeath, funds from his

[Baha'i Comment](#)

estate at death, but gave during his life, and, in addition, gave - what was equally important - his time and business ability to insure the successful results which have been achieved.

*(23) Reuben R. Springer (1800-1884), a successful investor in real estate and railroads, gave the major share of the money for the erection of the Cincinnati Music Hall. Opened in 1878, this red brick, semi-Gothic building housed the Cincinnati Music Festival and later the Cincinnati Symphony Orchestra. Perhaps inspired by this example, Andrew Carnegie in 1892 built the New York Music Hall on 57th Street. Since the latter name repelled European artists, who associated it with vaudeville, it was changed to Carnegie Hall.*

The gift of a hall to any city lacking one is an

---Page 45 The Gospel of Wealth - II Administration of Wealth---

excellent use for surplus wealth for the good of a community. The reason why the people have only one instructive and elevating, or even amusing, entertainment when a dozen would be highly beneficial, is that the rent of a hall, even when a suitable hall exists, which is rare, is so great as to prevent managers from running the risk of financial failure. If every city in our land owned a hall which could be given or rented for a

small sum for such gatherings as a committee or the mayor of the city judged advantageous, the people could be furnished with proper lectures, amusements, and concerts at an exceedingly small cost. The town halls of European cities, many of which have organs, are of inestimable value to the people, utilized as they are in the manner suggested. Let no one underrate the influence of entertainments of an elevating or even of an amusing character, for these do much to make the lives of the people happier and their natures better. If any millionaire born in a small village which has now become a great city is prompted in the day of his success to do something for his birthplace with part of his surplus, his grateful remembrance cannot take a form more useful than that of a public hall with an organ, provided the city agrees to maintain and use it.

49. *Sixth.* In another respect we are still much behind Europe. A form of benevolence which is not uncommon there is providing swimming-baths for the people. The donors of these have been wise enough to require the city benefited to maintain them at its own expense, and as proof of the contention that everything should never be done for any one or for any community, but that the recipients should invariably be called upon to do a part, it is significant that it is found essential for the popular success of these healthful establishments to exact a nominal charge for their use. In many cities, however, the school-children are admitted free

---Page 46 The Gospel of Wealth - II Administration of Wealth---

at fixed hours upon certain days; different hours being fixed for the boys and the girls to use the great swimming-baths, hours or days being also fixed for the use of these baths by women. In addition to the highly beneficial effect of these institutions upon the public health in inland cities, the young of both sexes are thus taught to swim. Swimming clubs are

[Baha'i Comment](#)

organized, and matches are frequent, at which medals and prizes are given. The reports published by the various swimming-bath establishments throughout Great Britain are filled with instances of lives saved because those who fortunately escaped shipwreck had been taught to swim in the baths; and not a few instances are given in which the pupils of certain bathing establishments have saved the lives of others. If any disciple of the gospel of wealth gives his favorite city large swimming and private baths, provided the municipality undertakes their management as a city affair, he will never be called to account for an improper use of the funds intrusted to him.

50. *Seventh.* Churches as fields for the use of surplus wealth have purposely been reserved for the last, because, these being sectarian, every man will be governed in his action in regard to them by his own attachments; therefore gifts to churches, it may be said, are not, in one sense, gifts to the community at large, but to special classes. Nevertheless, every millionaire may know of a district where the little cheap, uncomfortable, and altogether unworthy wooden structure

[Baha'i Comment](#)

stands at the cross-roads, in which the whole neighborhood gathers on Sunday, and which, inside the form of the doctrines taught is the center of social life and the source of neighborly feeling. The administrator of wealth makes a good use of part of his surplus if he replaces that building with a permanent structure of brick, stone, or granite, up whose sides the honeysuckle and columbine may climb, and from whose tower the sweet-tolling bell may sound. The millionaire should not figure how cheaply this structure can be built, but how perfect it can be made.

---Page 47 The Gospel of  
Wealth - II Administration of  
Wealth---

If he has the money, it should be made a gem, for the educating influence of a pure and noble specimen of architecture, built, as the pyramids were built, to stand for ages, is not to be measured by dollars. Every farmer's home, heart, and mind in the district will be influenced by the beauty and grandeur of the church; and many a bright boy, gazing enraptured upon its richly colored windows and entranced by the celestial voice of the organ, will there receive his first message from



and in spirit be carried away to the beautiful and enchanting realm which lies far from the material and prosaic conditions which surround him in this workaday world - a real world, this new realm, vague and undefined though its boundaries be. Once within its magic circle, its denizens live there an inner life more precious than the external, and all their days and all their ways, their triumphs and their trials, and all they see, and all they hear, and all they think, and all they do, are hallowed by the radiance which shines from afar upon this inner life, glorifying everything, and keeping all right within. But having given the building, the donor should stop there; the support of the church should be upon its own people. There is not much genuine religion in the congregation or much good to come from the church which is not supported at home.

51. Many other avenues for the wise expenditure of surplus wealth might be indicated. I enumerate but a few -- a very few - of the many fields which are open, and only those in which great or considerable sums can be judiciously used. It is not the privilege, however, of millionaires alone to work for or aid measures which are certain to benefit the community. Every one who has but a small surplus above his moderate wants may share this privilege with his richer brothers, and those without surplus can give at least a part of their time, which is usually as important as funds, and often more so.

[Baha'i Comment](#)

52. It is not expected, neither is it desirable, that there should be general concurrence as to the best possible use of surplus

[Baha'i Comment](#)

---Page 48 The Gospel of Wealth - II Administration of Wealth---

wealth. For different men and different localities there are different uses. What commends itself most highly to the judgment of the administrator is the best use for him, for his heart should be in the work. It is as

important in administering wealth as it is in any other branch of a man's work that he should be enthusiastically devoted to it and feel that in the field selected his work lies.

53. Besides this, there is room and need for all kinds of wise benefactions for the common weal. The man who builds a university, library, or laboratory performs no more useful work than he who elects to devote himself and his surplus means to the adornment of a park, the gathering together of a collection of pictures for the public, or the building of a memorial arch. These are all true laborers in the vineyard. The only point required by the gospel of wealth is that the surplus which accrues from time to time in the hands of a man should be administered by him in his own lifetime for that purpose which is seen by him, as trustee, to be best for the good of the people. To leave at death what he cannot take away, and place upon others the burden of the work which it was his own duty to perform, is to do nothing worthy. This requires no sacrifice, nor any sense of duty to his fellows.

[Baha'i Comment](#)

54. Time was when the words concerning the rich man entering the kingdom of heaven were regarded as a hard saying. To-day, when all questions are probed to the bottom and the standards of faith receive the most liberal interpretations, the startling verse has been relegated to the rear, to await the next kindly revision as one of those things which cannot be quite understood, but which, meanwhile, it is carefully to be noted, are not to be understood literally. But is it so very improbable that the next stage of thought is to restore the doctrine in all its pristine purity and force, as being in perfect harmony with sound ideas upon the subject of wealth and poverty, the rich and the poor, and the contrasts everywhere seen and deplored? In Christ's day, it is

---Page 49 The Gospel of Wealth - II Administration of Wealth---

evident, reformers were against the wealthy. It is none the less evident that we are fast recurring to that position to-day; and there will be nothing to surprise the student of sociological development if society should soon approve the text which

[Baha'i Comment](#)

has caused so much anxiety: "It is easier for a camel to enter the eye of a needle than for a rich man to enter the kingdom of heaven." Even if the needle were the small casement at the gates, the words betoken serious difficulty for the rich. It will be but a step for the theologian from the doctrine that he who dies rich dies disgraced, to that which brings upon the man punishment or deprivation hereafter.

55. The gospel of wealth but echoes Christ's words. It calls upon the millionaire to sell all that he had and give it in the highest and best form to the poor by administering his estate himself for the good of his fellows, before he is called upon to lie down and rest upon the bosom of Mother Earth. So doing, he will approach his end no longer the ignoble hoarder of useless millions; poor, very poor indeed, in money, but rich, very rich, twenty times a millionaire still, in the affection, gratitude, and admiration of his fellow-men, and -sweeter far-soothed and sustained by the still, small voice within, which, whispering, tells him that, because he has lived, perhaps one small part of the great world has been bettered just a

**Paradise** - The man who thinks only of himself and is thoughtless of others is undoubtedly inferior to the animal because the animal is not possessed of the reasoning faculty. The animal is excused; but in man there is reason, the faculty of justice, the faculty of mercifulness. Possessing all these faculties he must not leave them unused. He who is so hard-hearted as to think only of his own comfort, such an one will not be called man. Man is he who forgets his own interests for the sake of others. His own comfort he forfeits for the well-being of all. Nay, rather, his own life must he be willing to forfeit for the life of mankind. Such a man is the honor of the world of humanity. Such a man is the glory of the world of mankind. Such a man is the one who wins eternal bliss. Such a man is near to the threshold of God. Such a man is the very manifestation of eternal happiness. Otherwise, men are like animals, exhibiting the same proclivities and propensities as the world of animals. What distinction is there? What prerogatives, what perfections? None whatever! Animals are better even--thinking only of themselves and negligent of the needs of others.

Consider how the greatest men in the world--whether among prophets or philosophers--all have forfeited their own comfort, have sacrificed their own pleasure for the well-being of humanity. They have sacrificed their own lives for the body politic. They have sacrificed their own wealth for that of the general welfare. They have forfeited their own honor for the honor of mankind. Therefore it becomes evident that this is the highest attainment for the world of humanity.

We ask God to endow human souls with justice so that they may be fair, and may strive to provide for the comfort of all, that each

little. This much is sure:  
against such riches as these  
no bar will be found at the  
gates of Paradise.

member of humanity may pass his life in the utmost comfort and welfare. Then this material world will become the very paradise of the Kingdom, this elemental earth will be in a heavenly state and all the servants of God will live in the utmost joy, happiness and gladness. We must all strive and concentrate all our thoughts in order that such happiness may accrue to the world of humanity. (Foundations of World Unity, Page 42 & 43)

Carnegie TEXT here

Baha'i Comment

**MENU: [HOME](#) » [Reconstruction](#) » [Gospel Content](#) » [Gospel Purpose](#)**

# The Gospel of Wealth

And Other Timely Essays

by Andrew Carnegie

**In the right-hand commentary column,  
that which is in GREEN is a commentator's remark and  
that which is in BLUE is from the Baha'i Writings.  
On occasion, in that column, there may be a [link](#) to an extended comment or  
dissertation on the subject under discussion.**

- -

**A reminder that under "view" on your browser - you can set the text size UP  
or DOWN for a more comfortable read for yourself.**

--- Page 50. The Gospel of Wealth - III The Advantages of Poverty ---

## III

### The Advantages of Poverty

*(1) Published originally in the Nineteenth Century, XXIX (March 1891), 367-385; the same journal, XXVIII (November 1890), 677-694, published W. E. Gladstone, "Mr. Carnegie's 'Gospel of Wealth.' A Review and a Recommendation," which characteristically had something good to say about the advantages of inherited wealth. The review was of a pamphlet embodying Carnegie's articles which had received wide circulation here and abroad and had been issued in thousands of copies. A month later comments on "irresponsible Wealth" (XXVIII, 876-900) appeared by Cardinal Manning (1808-1892); Hermann Adler (1839-1911), chief rabbi of the United Hebrew Congregations of the British Empire (1891-1911); and Hugh Price Hughes (1817-1902), an influential Methodist divine. These three dwelt especially upon religious directives and motives which they thought Carnegie had brushed aside. Hughes was the most severe critic.*

1. Two essays from my pen, published in the North American Review, have been doubly fortunate in Britain in being reprinted by the Pall Mall Gazette under the new and striking title of "The Gospel of Wealth," and in attracting the attention of the one man who, of all others, could bring them most prominently before thinking

[Baha'i Comment](#)

people. Mr. Gladstone's review and recommendation in the November number of this Review gave them the most illustrious of sponsors; he is followed in the December number by others of the highest eminence and authority. The discussion has taken a wide range, but I shall restrict myself to its bearings upon the ideas presented in "The Gospel of Wealth."

2. Mr. Gladstone first calls attention to the portentous growth of wealth. From every point of view this growth seems to me most beneficial; for we know that, rapid as is the increase of wealth, its distribution among the people in streams more and more numerous is still more rapid, the share of the joint product of capital and labor which has gone to

--- Page 51. The Gospel of Wealth - III The Advantages of Poverty ---

labor during this generation being much greater than in any generation preceding, and constantly increasing. Evidences, drawn from many independent sources, converge and prove this beyond question. A few enormous fortunes have been amassed during the present

[Baha'i Comment](#)



generation in this new and undeveloped continent, but under conditions which no longer exist. In our day, even in the United States, it is much easier to lose a great fortune than to make one, and more are being lost than made. It is rather surprising, therefore, that the Rev. Mr. Hugh Price Hughes should say: "Whatever may be thought of Mr. Henry George's doctrines and deductions, no one can deny that his facts are indisputable, and that Mr. Carnegie's 'progress' is accompanied by the growing 'poverty' of his less fortunate fellow-countrymen."

*(2) Hughes's belief that "the rich were getting richer and the poor poorer" was a widely quoted aphorism of this period. It had little factual basis. Henry George (1882-1916), the American economist and author of Progress and Poverty (1879), justifying the "single tax," accepted the commonly held notion.*

3. So far as I have observed, all writers of authority upon social and economic subjects have not only disputed Mr. George's statements, but pronounce their opposites to be the truth. Mr. George's "Progress and Poverty" is founded upon two statements: first, that the rich are growing richer, and the poor poorer; and second, that land is going more and more into the hands

[Baha'i Comment](#)

of the few. The truth is that the rich are growing poorer, and the poor growing richer, and that land is passing from the hands of the few into the hands of the many. A study of Mulhall's *Fifty Years of National Progress* (pages 23-27)

*(3) Michael George Mulhall (1836-1900). His book, one of several on economic matters and statistics, appeared in England in 1887.*

is strongly recommended to those desirous of learning the truth in regard to the distribution of wealth, upon which Mr. Mulhall says: "Nor does this wealth become congested among a small number of people; on the contrary, the rich grow less rich and more numerous every year, the poor fewer in ratio to population."

--- Page 52. The Gospel of Wealth - III The Advantages of Poverty ---

[Baha'i Comment](#)

(NUMBER OF FARMS) \*

1850	1860	1870	1880
1,449,073	2,044,077	2,659,985	4,008,907

AVERAGE SIZE OF FARMS (ACRES)

1850	1860	1870	1880
203	199	153	134

*\* In 1890 the number of farms in the United States was 4,564,641 and the average size 136 and 1/2 acres. -- ED. [Note in original edition.]*

This tendency to more numerous and smaller holdings exists also in Britain, although hampered in its operation by repressive laws.

[Baha'i Comment](#)

5 I rejoice that Mr. Hughes quotes the well-known passage from Herbert Spencer,

*(4) The passage is from Spencer's Study of Sociology, pp. 256-59.*

which, as he says, "exposes the sad delusion that great wealth is a great blessing"- a passage which is throughout profoundly true; but is it possible that Mr. Hughes can be uninformed of the position Mr. George occupies in the wise mind of our mutual teacher? In speaking to me of Mr. George's book, Mr. Spencer said that he had read a few pages, and then thrown it down as "trash." I know of no writer or thinker of recognized authority, except Mr. Hughes, who differs with the philosopher in this judgment.

[Baha'i Comment](#)

6. So far as the reference to myself is concerned, -I understand, of course, it is in nowise personal, but only as the representative of a class, - I beg to assure Mr. Hughes that the indisputable fact I know is that my "progress" has inevitably carried with it not the "sowing poverty," but the growing riches of my fellow-countrymen, as the progress of every employer of labor must necessarily carry with it

--- Page 53. The Gospel of Wealth - III The Advantages of Poverty ---

the enrichment of the country and of the laborer. Imagine one speaking of "growing poverty" in the United States! The American, more than any other workman, spends his savings for the purchase of a home. The savings-banks are only one of several depositories used by him.

[Baha'i Comment](#)

7. Nevertheless, the returns just made for the year 1890, for all the New England and Middle States (where millionaires do most abound), comprising a population of 17,300,000 more than half the total population of Britain -  
- show that the deposits are \$1,279,000,000 -- say £255,000,000, the increase for the year being £13,000,000. The number of depositors is 3,520,000, showing that about one out of every five men, women, and children has a bank-account, equal practically to one to each family. The amount of savings invested for homes far exceeds the savings-bank deposits.

[Baha'i Comment](#)

8. The United States census of 1880 shows only 88,665 public paupers in a population of 50,000,000, mainly aged and superannuated - one third being foreigners. There were more blind and idiotic people in the public charitable institutions than paupers, and half as many deaf-mutes, although the percentage of the "defective classes" is less than half that of Europe. The total number of all "dependent" persons cared for was less than five per thousand, as compared with thirty-three per thousand in the United Kingdom. This

[Baha'i Comment](#)

percentage for Britain is happily only about one fourth of what it has been, and its steady decrease is most encouraging. Good and charitable workers among the poor can best accelerate this decreasing process, until something like the American figure is reached, by instilling within the working classes of Britain those feelings of manly self-respect and those habits of sobriety and thrift which distinguish their race here, and keep it almost free, not only from pauperism, but from want or extreme poverty, except as the necessary result (accident and sickness excepted) of their own bad habits.

9. Mr. Hughes would not give currency knowingly to state-

--- Page 54. The Gospel of Wealth - III The Advantages of Poverty ---

ments that were the reverse of correct. I earnestly hope, therefore, that he will satisfy himself that every writer of authority is not deceived when he asserts that poverty, want, and pauperism are rapidly diminishing quantities; and most significantly so, not so much through almsgiving, or efforts of the rich, but because of an improvement

[Baha'i Comment](#)

through education in the habits of the people themselves - the only foundation upon which their continued progress can surely be built. Mr. Hughes can also readily learn another indisputable fact by inquiring at the shipyards of Glasgow, the iron and steel mills of Sheffield, the coal-mines of the Midlands, or at industrial establishments generally - namely, that the working-classes receive much greater compensation for their services than they ever did or now do for any other form of labor, and much greater than they could possibly receive, except for the establishment of great enterprises by men of wealth. In these days of excitement and exaggeration, let it always be borne in mind that at no period in the history of the English-speaking race, wherever that race resides, has it been so easy as it is to-day for the masses not only to earn comfortable livelihoods, but to save and have money in bank for a rainy day. When they fail to do so, the true reformer looks more to their habits than to existing conditions for a satisfactory explanation.

10. So far from its being a fact that "millionaires at one end of the scale mean paupers at the other," as Mr. Hughes says, the reverse is obviously true. In a country where the millionaire exists there is little excuse for pauperism; the condition of the masses is satisfactory just in proportion as a country is blessed with millionaires. There is not a great millionaire among the whole four hundred millions of China, nor one in Japan, nor in India; one or two perhaps in the whole of Russia; there are two or three in Germany, and not more than four or five in the whole of France, monarchs and hereditary nobles excepted. There are more millionaires upon the favored little isle of Britain than in the whole of

--- Page 55. The Gospel of Wealth - III The Advantages of Poverty ---

Europe, and in the United States still more, of recent origin, than in Britain; and the revenues of the masses are just in proportion to the ease with which millionaires grow. The British laborer receives more for one day's handling of the shovel than the blacksmith or carpenter of China, Russia, India, or Japan receives for a whole week's labor, and

[Baha'i Comment](#)



double that of his Continental fellow-workman. The skilled artisan of America receives more than twice as much as the artisan of Britain.

Millionaires can only grow amid general prosperity, and this very prosperity is largely promoted by their exertions. Their wealth is not made, as Mr. Hughes implies, at the expense of their fellow-countrymen. Millionaires make no money when compelled to pay low wages. Their profits accrue in periods when wages are high, and the higher the wages that have to be paid, the higher the revenues of the employer. It is true, and not false, therefore, that capital and labor are allies and not antagonistic forces, and that one cannot prosper when the other does not.

11. I feel as if I should apologize for taking so much space in stating truisms; but much of the prejudice and hostility which unnecessarily exist between capital and labor arise from such statements as those quoted.

[Baha'i Comment](#)

12. To return to Mr. Gladstone. Would that his adhesion to "The Gospel of Wealth" in its entirety could be obtained! Deeply gratifying is the favor which he accords in general to its scope and aim; but the destructive character of its criticism upon one vital point is important. He is quite right in saying that, "though partial, it is a serious difference." It arises from his fond, clinging affection for the principle of hereditary transmission of position and wealth, and of business, and for magnificence upon the part of those in station. We must treat this serious matter at the threshold.

[Baha'i Comment](#)

13. The fundamental idea of the gospel of wealth is that surplus wealth should be considered as a sacred trust to be administered by those into whose hands it falls, during their lives, for the good of the community. It predicts that the day

[Baha'i Comment](#)

--- Page 56. The Gospel of Wealth - III The Advantages of Poverty ---

is at hand when he who dies possessed of enormous sums, which were his and free to administer during his life, will

die disgraced, and holds that the aim of the millionaire should be to die poor. It likewise pleads for modesty of private expenditure

14. The most serious obstacle to the spread of such a gospel is Undoubtedly the prevailing desire of men to accumulate wealth for the express purpose of bequeathing it to their children, or to spend it in ostentatious living. I have therefore endeavored to prove that at the root of the desire to bequeath to children there lay the vanity of the parents, rather than a wise regard for the good of the children. That the parent who leaves his son enormous wealth generally deadens the talents and energies of the son, and tempts him to lead a less useful and less worthy life than he otherwise would, seems to me capable of proof which cannot be gainsaid. It is many years since I wrote in a rich lady's album, "I should as soon leave to my son a curse as the almighty dollar." Exceptions abound to every general rule, but I think not more exceptions to this rule than to others - namely, that "wealth is a curse to young men, and poverty a blessing"; but if these terms seem rather strong, let us state the proposition thus: that wealth

[Baha'i Comment](#)

left to young men, as a rule, is disadvantageous; that lives of poverty and struggle are advantageous.

15. Mr. Gladstone asks: "Is it too much to affirm that the hereditary transmission of wealth and position, in conjunction with the calls of occupation and of responsibility, is a good and not an evil thing? I rejoice to see it among our merchants, bankers, publishers; I wish it were commoner among our great manufacturing capitalists." He also says: "Even greater is the subject of hereditary transmission of land - more important and more difficult." Mr. Gladstone does not favor entails of money, but adds: "But is it another matter when in commerce, or in manufacture, or in other

--- Page 57. The Gospel of Wealth - III The Advantages of Poverty ---

forms of enterprise, such for example as the business of a great publishing house, the work of the father is propagated by his descendants?"

[Baha'i Comment](#)

16. These passages imply that the hereditary transmission of wealth and position and of business are not detrimental - as I think them - but desirable: a good and not an evil thing. Let us take the first form, that of sons following the occupations of their fathers. Little, I think, does one know, who is not in the whirl of business affairs, of the rarity of the combined qualities requisite for conducting the business enterprises of to-day. The time has passed when business once established can be considered almost permanently secure. Business methods have changed; good will counts for less and less. Success in business is held by the same tenure, nowadays, as the Premiership of Britain -- at the cost of a perpetual challenge to all comers. The fond parent who invests his son with imaginary business qualifications, and places him in charge of affairs - upon the successful management of which the incomes of thousands depend - incurs a grave responsibility. Most of the disastrous failures of the day arise from this very cause. It is as unjust to the son as to the community. Out of seven serious failures during a panic in New York, five were traced to this root. One of these sons is an exile

[Baha'i Comment](#)

to escape punishment for breaking a law which he did not clearly understand. I have joined with others in asking the President to pardon him - a step I have never taken before on behalf of any law-breaker, but in this case I consider the father, not the son, the guilty party. The duty of the head of a great enterprise is to interest capable assistants who are without capital, but who have shown aptitude for affairs, and raise these to membership and management. The banker who hands over his business to sons, because they are sons, is guilty of a great offense. The transmission of wealth and rank, without regard to merit or qualifications, may pass from one peer to another, not without

--- Page 58. The Gospel of Wealth - III The Advantages of Poverty ---

much, but without serious injury, since the duties matter of routine, seldom involving the welfare or of others; but the management of business, never.

17. But assuming that business enterprises can be handed over properly in deference to hereditary claims, is it wise or desirable that they should be? I think not. The millionaire business man rates his vocation higher than I, who sees in it the best or highest, or even a desirable career for his sons. The sons of the wealthy have a right instinct which tells them that to engage in work where the primary object is gain is unworthy of those who, relieved from the necessity of earning a livelihood, are in a position to devote themselves to any of the hundred pursuits in which their time and knowledge can be employed primarily for the good of the community. The sons of the millionaire are to be regarded with approval who cannot be induced to take the absorbing and incessant interest in their father's business which is necessary to save it from ruin. The day is over when even the richest can play at business, as rich men's sons almost invariably do. There are exceptions where the son shows tastes and decided ability which render him the natural successor; but these are rare, far too rare to take into account in estimating the value of a custom. This ability, moreover, should be proved in some other establishment

[Baha'i Comment](#)

than that of the father.

18. When we come to the hereditary transmission of land, Mr. Gladstone's words are most touching. He paints a lovely picture of the "wonderful diversity and closeness of the ties by which, when rightly used, the office of the landed proprietor binds together the whole structure of rural society,.... that cohesion, interdependence, and affection of the gens which is in its turn a fast-compacting bond of societies at large." But is this a picture of to-day? Has not that day passed also, except in a few instances such as that furnished by the late lamented Lord Tollemache,<sup>5</sup> and upon

*(5) Lord Tollemache (1805-1890) was the landlord of two estates, totaling 33,000 acres, in Suffolk and Cheshire. He contributed a phrase and a practice to land reform by giving each of his 250 cottage tenants "three acres and a cow," from the rectums of which they could supplement their wages on neighboring farms. At the same time he divided his own estates into farms of 200 acres as the most profitable unit of cultivation. He had the most advanced ideas about a landlord's responsibility and knew every tenant and his capabilities. On his death in 1890 the Times characterized him "as the finest practical agriculturist in the country."*

--- Page 59. The Gospel of Wealth - III The Advantages of Poverty ---

[Baha'i Comment](#)



a smaller scale by Mr. Gladstone himself, in that earthly Paradise, Hawarden?"

*(6) Gladstone's large private estate in Wales, site of an ancient castle.*

Carnegie Text Goes Here

19. The cultivation of land is now a business conducted upon a commercial basis by independent men, whom the landed proprietor no longer leads, and who most fortunately can lead themselves. The American citizen, who is himself landlord, factor, tenant, and laborer, requiring from the land he owns and tills only the support of himself and family, has rendered impossible the maintenance of more than one class from the product of agricultural land anywhere in the world. Knowing the kind of citizen which this condition creates, and knowing also the character of the Scotch farmer, as evolved through the operation of long leases which make him practically independent, -although in his case the magic power of ownership, which counts for so much, is still lacking, - and estimating these classes as men and as citizens, I have no doubt that the balance of advantage, both to the individual and to the State, is largely in favor of the change. Should the abolition of primogeniture and entail come with the changes democracy is expected to inaugurate, large estates in Britain would probably be divided into farms and owned by the people. The history of Denmark in this particular might then be that of Britain; and the temptation which now exists to leave territorial domains to eldest sons would thus be removed, and with it one great obstacle to the adoption of the gospel of wealth - the desire, futile as vain, to found or maintain hereditary families.

20. Mr. Gladstone instances the Marquis of Salisbury 7 suc-

*(7) Lord Salisbury was a Cecil. The family, one of the most distinguished in English history, attained eminence at least as early as the reign of Queen Elizabeth. Robert Cecil, the first Earl of Salisbury, younger son of William Lord Burghley, was Queen Elizabeth's famous Lord Treasurer. A lineal descendant, Robert Arthur Talbot Cascoyne-Cecil, third Marquis of Salisbury, was born in 1830. His father, disapproving of*

Baha'i Comment

*the young man's marriage, gave him only a limited income. Thereupon he became a contributor to magazines, notably Bentley's Quarterly Review and the Saturday Review. On the death of an older brother in 1865 he became his father's heir. Meanwhile in the Commons he had made a reputation as a conservative and a foe of Gladstone. After serving as Secretary of State for Foreign Affairs and in other positions, he became in 1885 prime minister for the first time. Through the next fifteen years he recurrently held this office as well as that for foreign affairs. He left office for the last time in 1902 and died the following year.*

--- Page 60. The Gospel of Wealth - III The Advantages of Poverty ---

ceeding to the office of Prime Minister, which office ten generations ago was filled by one of his ancestors, and asks: "Is not this tie of lineage a link binding him to honor and to public virtue?" Is not Mr. Gladstone unfortunate in naming Lord Salisbury in support of his views? I have always regarded him as a striking instance of the advantage of not being born to hereditary wealth and position. Like the great founder of the Cecils, Lord Salisbury himself was born a commoner - a younger son with a younger son's portion; and with the promptings of decided ability within him, he did everything in his power to prevent being narrowed and

restricted by the smothering robes of rank and wealth. The laws of his country forced him to sink his individuality in a peerage, but for which English history might have told of a first and a second. Cecil, as it tells of a first and a second Pitt -- men too great to be obliterated as men by any title. It is a sad descent in historical rank from "Cecil" to the "Marquis" of anything. The highest title which a man can write upon the page of history is his own name. Mr.

Gladstone's will be there; Gladstone he is, Gladstone he will remain, even if he tried to make future generations lose his commanding personality in the "Dukedom of Clydesdale," or any title whatever. But who among his contemporaries in public life is to stand this supreme test of masterdom? There is room for one only in each generation. It is safe to predict that, whoever he be, he will resemble "Gladstone" in one essential feature: he will be of the people, free from the dis-

--- Page 61. The Gospel of Wealth - III The Advantages of Poverty ---

advantage of hereditary wealth and position, and stamp his name and personality upon the glittering scroll. "Disraeli" promised well

for a time, but he fades rapidly into Beaconsfield

*(8) Benjamin Disraeli (1804-1881) became Earl of Beaconsfield in 1876 but did not exactly "fade" as statesman until 1880.*

becoming a Shadow of a name. The title proves greater than the man.

21. As a "Saturday Reviewer," Robert Talbot Cecil (what a glorious name to lose!) had proved himself a power: it is a hundred to one that, had he been born to the hereditary title, he would have remained an obscure commonplace Marquis, resembling in this respect the many generations of Marquises of Salisbury which had followed each other, and whose noble history is comprised - and fully comprised - in "Burke's Peerage in the three letters, b, m, d. The only man of his family from whom he can derive inspiration "binding him to honor and to public virtue," is the great original Cecil, and the founder of his own branch of the house, who, like himself, was a younger son, and had neither wealth nor rank. He did not even reach knighthood till late in his career. The great Cecil sprung from the people, and had none of the advantages which Mr. Gladstone, as I think

[Baha'i Comment](#)

wrongly, attributes to hereditary wealth and position. Lineage is indeed, most important, but only the lineage of the immediate parents; for in each generation One half of the strain is changed. Fortunately for the high-placed ones of the earth, it is unnecessary for them to scrutinize the characters of their ancestors beyond the preceding generation. Happy for the royal children of Britain that they can dwell upon the virtues of father and mother, and stop there. Lord Salisbury, like many able men, perhaps, owes his commanding qualities to his mother, who was the daughter of a country gentleman - a commoner, secure from the disadvantages of the hereditary transmission of wealth and rank. It is curious that the present ruler of the other branch of the English race, our President, has the same good fortune Mr. Gladstone claims for the

--- Page 62. The Gospel of Wealth - III The Advantages of Poverty ---

Marquis of Salisbury, his grandfather having been President.

*(9) Benjamin Harrison (1833-1901), twenty third President of the United States, was the*

*grandson of William Henry Harrison, the ninth.*

But it is safe to say that the American ruler would never have occupied that high office had he received fortune and position from his grandfather, or had he himself acquired riches. No party is so foolish as to nominate for the Presidency a rich man, much less a millionaire. Democracy elects poor men. The man must have worked for his bread to be an available candidate; and if, like Lincoln, he has been so fortunate as to be compelled to split rails, or, like Garfield,

*(10) James A. Garfield (1831-1881) reputedly was the last president to be born in a log cabin.*

to drive mules upon a canal, and subsequently to clean the rooms and light the fires of the school in part payment for his tuition, or, like Blaine,

*(11) James G. Blaine (1850-1893), Secretary of State in Garfield's administration (1880-81) and again in 1889-1902, taught school at Western Military Institute, Georgetown, Kentucky, and at an institution for the blind in Philadelphia.*

to teach school, so much more successfully does he appeal to the people. This applies not only to the Presidency: one of the strongest aspirants for that office lost his

renomination to the Senate because a house that he erected in Washington was taken as an indication of tastes incompatible with republican simplicity of life.

22. Nothing is more fatal to the prospects of a public man in America than wealth, or the display of wealth. The dangers of a plutocracy that his Eminence Cardinal Manning fears are, I assure him, purely imaginary. There is no country in which wealth counts for so little as in the Republic The current is all the other way. Is the influence of lineage less upon the republican President, in binding him to honor and public virtue, because neither hereditary rank nor wealth was transmitted? Because he is poor and a commoner, is he less sensitive to the promptings of honor and virtue? I think it will be found that the best and greatest of Britain do not differ from the greatest and best of other lands. These have had a lineage which linked them to honor and to public virtue, but almost

--- Page 63. The Gospel of Wealth - III The Advantages of Poverty ---

without exception the lineage of honest poverty - of

[Baha'i Comment](#)

laborious, wage-receiving parents, leading lives of virtuous privation, sacrificing comforts that their sons might be kept at school - lineage from the cottage of poverty, not the palace of hereditary rank and position.

23. Mr. Gladstone himself has a lineage. Does it bind him less than Lord Salisbury is bound by his to honor and public virtue? His ancestors were Scotch farmers without wealth or rank, yet I doubt not that Mr. Gladstone's career has been as strongly and as nobly influenced by his knowledge or recollections of the poor and virtuous lives lived by his forefathers as that of any hereditary monarch or noble who ever lived could be by thoughts of his ancestors; and of one thing I am absolutely sure: he has reason to be much prouder of his lineage than nobles or monarchs in general can possibly be of theirs. Among many advantages arising, not from the transmission of hereditary wealth and position, but from the transmission of hereditary "poverty and health," there is one which, to my mind, overweighs all the others combined. It is not permitted the children of king, millionaire, or noble to have

[Baha'i Comment](#)



father and mother in the close and realizing sense of these sacred terms. The name of father, and the holier name of mother, are but names to the child of the rich and the noble. To the poor boy these are the words he conjures with - his guides, the anchors of his soul, the objects of his adoration. Neither nurse, servant, governess, nor tutor has come between him and his parents. In his father he has had tutor, companion, counselor, and judge. It is not given to the born millionaire, noble, or prince to dwell upon such a heritage as is his who has had in his mother nurse, seamstress, teacher, inspirer, saint - his all in all.

24. Hereditary wealth and position tend to rob father and mother of their children, and the children of father and mother. It cannot be long ere their disadvantages are felt more and more, and the advantages of plain and simple living more clearly seen.

[Baha'i Comment](#)

--- Page 64. The Gospel of  
Wealth - III The Advantages  
of Poverty ---

25. Poor boys reared thus directly by their parents possess such advantages over those watched and taught by hired strangers, and exposed to the temptations of wealth and position, that it is not surprising they become the leaders in every branch of human action. They appear upon the stage, athletes trained for the contest, with sinews braced, indomitable wills, resolved to do or die. Such boys always have marched, and always will march, straight to the front and lead the world; they are the epoch-makers. Let one select the three or four foremost names, the supremely great in every field of human triumph, and note how small is the contribution of hereditary rank and wealth to the short list of immortals who have lifted and advanced the race. It will, I think, be seen that the possession of these is almost fatal to greatness and goodness, and that the greatest and best of our race have necessarily been nurtured in the bracing school of poverty-the only school capable of producing the supremely great, the genius.

[Bahá'í Comment](#)

26. Upon the plea made by "The Gospel of Wealth" for modesty of private expenditure, Mr. Gladstone says: "Among those whose station excuses or even requires magnificence, there are abundant opportunities and there are also beautiful and graceful examples of personal simplicity and restraint." This seems to me a branch from the upas-tree of hereditary transmission of wealth and position. Is it true that station requires magnificence, or true that true dignity of station is enhanced by simplicity?

[Baha'i Comment](#)

27. Here are some words of President Cleveland in his message to Congress upon this point: "We should never be ashamed of the simplicity and prudential economies which are best suited to the operation of a republican form of government and most compatible with the mission of the American people. Those who are selected for a limited time to manage public affairs are still of the people, and may do much by their example to encourage, consistently with the dignity of their official functions, that plain way of life which

[Baha'i Comment](#)

### Wealth - III The Advantages of Poverty ---

among their fellow-citizens  
aids integrity and promotes  
thrift and prosperity."

28. President Cleveland only  
follows the teachings and  
examples of every American  
President, and of all others in  
official station. There are no  
pecuniary prizes in the  
Republic for judge, bishop, or  
President; neither any  
pensions,

*(12) On the other hand, Carnegie,  
pained by the ingratitude of  
republics, bequeathed in his will an  
income of \$10,000 a year to ex-  
President Taft and \$5,000 a year  
each to Mrs. Grover Cleveland and  
Mrs. Theodore Roosevelt.*

except that judges are retired  
upon half-pay at seventy  
years of age. The very  
moderate salaries given to all  
officials enforce modest  
expenditure, and the influence  
of this upon the nation is as  
powerful as salutary. Were  
some future King of Britain to  
announce that the serious  
consideration of the subject of  
wealth and poverty had led  
him to resolve to live as the  
President of the United States  
and his family live, upon ten  
thousand pounds a year, and  
to return to the nation, or  
devote to public uses, the  
hundreds of thousands of

[Baha'i Comment](#)

pounds spent for magnificence, and were he to live in accordance with this resolve, would it lessen or enhance the true dignity of his life and station? Would it lessen or enhance his influence? Is it reasonable to estimate that all the good that monarch could possibly do in his restricted position would equal that which would flow from setting the example of living a quiet, unostentatious, modest life -- administering his surplus not upon himself, but for others? The only objection that might be raised against such action is that it would render the king a personage far too powerful for the system of constitutional monarchy, which requires "king" to be but a word meaning the will of the Cabinet. The man capable of taking such action would be not only titular "king-," but a power ill the State. The Right Hon. John Morley,

*(13) English statesman and author (1838-1923), Secretary of Ireland under Gladstone and Secretary for India, 1905-1910.*

replying to a question asked by a constituent at a meeting in Newcastle, some time ago, bearing upon this very point of expend-

--- Page 66. The Gospel of Wealth - III The Advantages

## of Poverty ---

iture and magnificence in the State, gave expression to the hope that the highly placed might learn that the truest dignity consisted in quiet and simple living. I do not quote his words but the sense of his reply. Mr. Gladstone himself will leave behind him many titles to the affection, gratitude, and admiration of his countrymen; but when the future eulogist says of him - as he will truly be able to say - what is said of Pitt upon his monument in G[u]ildhall, he will pay him the greatest of all tributes. These words are: "Dispensing for many years the favours of his sovereign, he lived without ostentation, and died poor." If we cannot have Mr. Gladstone preaching in favor of modest living upon the part of those in station, we rejoice that none excels him in the practice of that virtue. It is seldom we are permitted to extol the example beyond the precept of the sage.

29. Upon this subject I thank Mr. Hughes for the words he has written. He says: "The real question is not how much we ought to give away, but how much we dare retain for our own gratification." These words strike home to every man of wealth and station: "How much *dare we retain* for our own gratification?" This is a troublesome question which will not "down." Giving the one tenth - the tithe - is easy. The true disciple of the gospel of wealth has to pass far beyond that stage. His conscience may be quieted by arguing that he and his family are entitled to enjoy in moderation the best that the world affords. The earnest disciple can easily discover the efficacy of running in debt, as it were, by anticipating his expected surplus, and engaging in works for the general good before the cash is in hand, to an extent which really keeps him without available surplus, and even entails the necessity of figuring how to meet engagements. He can, when so situated, consider himself poor, and he will certainly feel himself so. The personal expenditure of the very rich forms so small a part of their income, provided the rule is obeyed which forbids such extravagance as would render them conspicuous, that they

[Baha'i Comment](#)

can, perhaps, also find refuge from self-

--- Page 67. The Gospel of Wealth - III The Advantages of Poverty ---

questioning in the thought of the much greater portion of their means which is being spent upon others. But I do not profess that this is entirely satisfactory, and I am glad to agree with Mr. Hughes in the very low estimate he places upon this partial treatment of the serious question he has raised: "*How much dare we retain for our own gratification?*"

30. Upon the subject of giving, Mr. Gladstone thinks that I am severe in my judgment of private charity when I estimate that of every thousand dollars spent in so-called charity nine hundred and fifty of them had better be thrown into the sea. The history of the Charity Organization Society of New York is here most instructive,

*(14) The Charity Organization Society Of New York was established in 1881 to correlate the efforts and grants of the many private charity organizations "engaged in teaching and relieving the poor of the city in their own homes." It was an example of a general movement in the late nineteenth century to introduce more efficiency and less*

[Baha'i Comment](#)



*duplication in the bestowal of private charity.*

Its confidential monthly bulletin recently gave the names of twenty-three bogus organizations which were soliciting contributions, many of them, unfortunately, with success. These have their printed annual reports, lists of distinguished contributors, - in many cases, alas! these are genuine, - their lady collectors, and all the other details. When the various charitable societies first combined and compared lists of those receiving aid, it was found that many names were upon seven or eight of the lists. Did my space permit, a story could be told that would upon every wealthy person that his duty is not to resolve to give, but to withhold until certain that his aid will not increase the area of what is called, in the stirring language of the day, the "hell of want and misery," which he longs to remove. The towns of Connecticut have recently been getting light upon almsgiving. A morning paper says: "The experience of Hartford with well-to-do public beggars may be duplicated in almost every town in Connecticut. A year or two ago, in Norwich, a town agent investigated the condition

--- Page 68. The Gospel of  
Wealth - III The Advantages  
of Poverty ---

of the numerous persons who were receiving town aid. In forty instances he found that the applicants for charity had from five hundred to three thousand dollars in the savings bank; in one case, that of a woman who had been drawing 'town money' for years, it was found she had nearly twenty thousand dollars in a local bank."

31. This is the least deplorable side of the matter, for the money given to prudent, saving people, even if they may not need it, cannot produce the serious consequences of that given to the much more numerous class who use it for the gratification of vice, and to enable them to live in idleness. Unless the individual giver knows the person or family in misfortune, their habits, conduct, and cause of distress, and knows that help given will aid them to help themselves, he cannot act properly; and if he does act to save his own feelings -which one is very apt to do -he will increase rather than diminish the distress which appeals to him. There is really no true charity except that which will

[Baha'i Comment](#)

help others to help themselves, and place within the reach of the aspiring the means to climb.

32. I notice a prevalent disposition to think only of the unfortunate wretches into whom the virtues necessary for improvement cannot be instilled. Common humanity impels us to provide for the actual wants of human beings - to see, through our poor laws, that none die of starvation, and to provide comfortable shelter, clothing, and instruction, which should, however, always be dependent upon work performed; but in doing this our thoughts should also turn to the benefits that are to accrue to those who are yet sound and industrious and, seeking through labor the means of betterment, by removing from their midst and placing under care of the State in workhouses the social lepers. Every drunken vagabond or lazy idler supported by alms bestowed by wealthy People is a source of moral infection to a neighborhood. It will not do to teach the hard-working, industrious man that there is an easier path by which his wants can be supplied.

--- Page 69. The Gospel of

[Baha'i Comment](#)

## Wealth - III The Advantages of Poverty ---

The earnest reformer will think as much, if not more, of the preservation of the sound and valuable members among the poor, as of any real change which can be effected in those who seem hopelessly lost to temperance, industry, and thrift. He will labor more to prevent than to cure, feeling that it is necessary to remove the spoiled grape from the bunch, the spoiled apple from the barrel, mainly for the sake of the sound fruit that remains. He who would plunge the knife into the social cancer, if any good is to be effected thereby, must needs be a skilled surgeon with steady hand and calm judgment, with the feelings as much under control as possible; the less emotion the better.

33. One reads or hears everywhere of rash proposals, well meaning, no doubt, full of the innocence of the dove; but there is no task which more requires the wisdom of the serpent, which seems woefully lacking in these sensational schemes. The following from Rabbi Adler is sound to the core: "Giving, however, is an easy matter; it needs neither special training nor sustained

[Baha'i Comment](#)

thought. But the purpose and methods of charitable relief cannot be learned without a long and diligent apprenticeship, for which discipline in the painful school of personal experience is alone of any avail."

34. Sorry as I am to say it, the more attention I give to this subject, the greater the genuine knowledge obtained, the higher I am disposed to raise my estimate of the evil produced by indiscriminate giving.

[Baha'i Comment](#)

35. From the standpoint of "The Gospel of Wealth" Mr. Gladstone's criticisms are, indeed, serious - almost fatal; for it will be readily seen that if the hereditary transmission of wealth and position and of business concerns be not pernicious as a rule, as I hold, but advantageous to the individuals receiving these bequests, and to the nation as well, and if, instead of simplicity, as I think, station requires magnificence, it will be hard indeed, if not impossible, to teach the wealthy that surplus wealth should be regarded as a sacred trust to be administered during their lives for the public

[Baha'i Comment](#)

--- Page 70. The Gospel of  
Wealth - III The Advantages  
of Poverty ---

good; they will continue to gather and leave fortunes to their families or spend them for magnificence as hitherto. I turn, therefore, for support to the views of the other contributors.

36. His Eminence Cardinal Manning says:

Mr. Carnegie tells us plainly, first, that the accumulation of stagnant wealth to be bequeathed to heirs is a vainglory in the giver, and may be a ruin to the receiver; secondly, that the bequeathing of wealth for charities when the man is gone out of life is an empty way of making a name for generosity; thirdly, that to distribute all beyond the reasonable and temperate reserves due to kindred and their welfare, inter vivos, or now in life, with his own will, judgment, and hand to works of public and private beneficence and utility, is the highest and noblest use of wealth. This is a gospel, not according to capital, but

[Baha'i Comment](#)

according to the mind and life of the Founder of the Christian world. It is nothing new. It is no private opinion or exorbitant notion of a morbid prodigality, but the words of soberness and truth. If men so acted they would change the face of the world.

37. The Rev. Mr. Hughes writes:

In the long and arduous task of reconstructing society on a Christian basis, with due and careful regard to all legitimate existing interests, it would be an inestimable public service if every one whom Mr. Carnegie represents would follow the example of Mr. Carnegie in getting rid of his money as quickly as possible. Mr. Carnegie's gospel is the very thing for the transition period from social heathenism to social Christianity. If a man is so unfortunate as to have enormous wealth, he cannot do better than act upon Mr. Carnegie's distributive principles.

[Baha'i Comment](#)

38. I cannot but express the hope that further reflection upon the vital points may bring Mr. Gladstone into closer agreement with our colleagues in the discussion. In none of their articles is there a word in support of the advantages of the hereditary transmission of wealth and position, or of the necessity for magnificence upon the part of those in station. Their views seem to be in quite the other direction.

[Baha'i Comment](#)

39. Fortunately, from this point forward we have Mr. Gladstone's powerful and unreserved support. He says: "The accumulation of wealth has had adversaries, but it has been too

[Baha'i Comment](#)

--- Page 71. The Gospel of Wealth - III The Advantages of Poverty ---

strong for them all; it is the business of the world." "The Gospel of Wealth" advocates leaving free the operation of laws of accumulation. It accepts this condition as unassailable, and seeks to make the best of it by directing into new and better channels the streams of accumulated and accumulating wealth, which it is found impossible to prevent. But in this, while we



have Mr. Gladstone with us, we have regretfully lost Mr. Hughes, who rises in stern opposition and says: "If 'Lay not up for yourselves treasures upon the earth'

*(15) Matt. 6:19.*

does not forbid the accumulation of wealth, the New Testament was written on Talleyrand's principle and was intended to 'conceal thoughts.'

*(16) Also attributed to Voltaire, Dialogue XIV, Le Chapon et la Poularde - "Men employ speech only to conceal their thoughts."*

40. It is quite true, as Mr. Hughes says, "that expositors can prove anything, and that theologians can explain away anything." When applied to a rich man, his view of this very text only part of which is quoted by Mr. Hughes - was that he strictly complied with the injunction by always placing his treasures in the safety deposit company, where he was quite sure "neither moth nor rust could corrupt, nor thieves break through and steal." Mr. Hughes quotes the parable of the master of the vineyard, whose conduct is cited by Christ with approval. How came he master of a vineyard? Can he have sinned

[Baha'i Comment](#)

and 'accumulated wealth" for the payment of labor? Mr. Hughes says: "Christ distinctly prohibited the accumulation of wealth." But when Christ spoke, the revenues of a leading minister, even if divided among the whole twelve apostles, would have been accounted "wealth." It seems to me we have only to interpret literally, in this manner, a few parts of isolated texts to find warrant for the destruction of civilization. Five words spoken by Christ so interpreted, if strictly obeyed, would at one blow strike down all that distinguishes man from the beast. "Take no thought for tomorrow."

*(17) Matt. 6:34*

There is reason to believe that the

--- Page 72. The Gospel of Wealth - III The Advantages of Poverty ---

forces of Christianity are not thus to be successfully arrayed against the business of the world-the accumulation of wealth. The parable of the talents'

*(18) Matt. 25:14-28.*

bears in the other direction. It was: those who had

accumulated and even doubled their capital to whom the Lord said: "Well done, thou good and faithful servant: thou has been faithful over a few things, I will make thee ruler over many things: enter thou into the joy of thy Lord."

41. Those who had "laid up" their treasures and not increased them were reprimanded. Consider the millionaire who continues to use his capital actively in enterprises which give employment and develop the resources of the world. He who manages the ships, the mines, the factories, cannot withdraw his capital, for this is the tool with which he works such beneficent wonders; nor can he restrict his operations, for the cessation of growth and improvement in any industrial undertaking marks the beginning of decay. The demands of the world for new and better things are continuous, and existing establishments must supply these, or lose even the trade they now have. I hope Mr. Hughes will find good ground for an interpretation which justifies the belief that the text has no bearing upon him, but is intended solely for those who hoard realized capital, adding the interest

[Baha'i Comment](#)

obtained for its use to the principal, and dying with their treasures "laid up," which should have been used as they accrued during the life of the individual for public ends, as the gospel of wealth requires.

42. Acting in accordance with this advice, it becomes the duty of the millionaire to increase his revenues. The struggle for more is completely freed from selfish or ambitious taint and becomes a noble pursuit. Then he labors not for self, but for others; not to hoard, but to spend. The more he makes, the more the public gets. His whole life is changed from the moment that he resolves to become a disciple of the gospel of wealth, and henceforth he labors to acquire

--- Page 73. The Gospel of Wealth - III The Advantages of Poverty ---

that he may wisely administer for others good. His daily labor is a daily virtue. Instead of destroying, impairing, or disposing of the tree which yields such golden fruit, it does not degrade his life nor even his old age to continue guarding the capital from which alone he can obtain the

[Baha'i Comment](#)

means to do good. He may die leaving a sound business in which his capital remains, but beyond this die poor, possessed of no fortune which was free for him to distribute, and therefore, I submit, not justly chargeable with belonging to the class which "lay up their treasures upon earth."

43. In this connection I commend to my reverend colleague the sermon of the founder of his church (The Use of Money, American edition, vol. i. p. 44, Sermon 50). He says:

Gain all you can by honest industry. Use all possible diligence in your calling. Lose no time. Gain all you can by common sense, by using in your business all the understanding which God has given you. It is amazing to observe how few do this -- how men run on in the same dull track with their forefathers.

Having gained all you can by honest wisdom and unwearied diligence, the second rule of Christian prudence is, "Save all you can." Do not throw it away in idle

[Baha'i Comment](#)

expenses -- to gratify pride, etc. If you desire to be a good and faithful steward, out of that portion of your Lord's goods which he has for the present lodged in your hands, first provide things needful for yourself, food, raiment, etc.

Second, provide these for your wife, your children, your servants, and others who pertain to your household. If then you have an overplus, do good to them that are of the household of faith. If there be still an overplus, do good to all men.

*(19) John Wesley (1703-1791), the "founder" of Methodism, Mr. Hughes's denomination, accumulated about \$250,000 by his writings. The quotations, as Carnegie cited them, are from the Works of John Wesley. There are several "first" American editions. The earliest to include this sermon, here numbered LIII, was published by J. & J. Harper (New York, 1826-1827), VI, 101. The sermon is numbered L in the First American Complete and Standard Edition from the Latest London Edition (New York: Emory & B. Waugh, 1831), I, 444.*

44. Upon this sermon the gospel of wealth seems founded. Indeed, had I known of its existence before writing upon the subject, I should certainly have quoted it. I shall, therefore, not be shaken, even if a leading disciple of Wesley informs

--- Page 74. The Gospel of Wealth - III The Advantages of Poverty ---

us that Mr. Carnegie (as representing the millionaire class, of course) is an "anti-Christian phenomenon," a "social monstrosity," and a "grave political peril," and says that "in a really Christian country - that is, in a country constructed upon a Christian basis - a millionaire would be an economic impossibility." The millionaire class needs no defense, although Mr. Hughes thinks it no longer of use since joint stock companies provide the means for establishing industries upon the large scale now demanded. It is most significant that the business concerns which have given Britain supremacy are, with few or no exceptions, the creations of the individual millionaire - the Cunards, Ismays, Allens, Elders, Bessemers, Rothschilds, Barings, Clarks, Coatses, Crossleys, the Browns,

[Baha'i Comment](#)

**Siemens, Cammels, Gillotts,  
Whitworths, the Armstrongs,  
Listers, the Salts, Bairds,  
Samuelsons, Howards, Bells,**

*(20) These are families who established great 19th century British enterprises—shipping and ship-building, finance, manufacturing, metallurgy, chemicals, textiles, armaments, mining, etc. -- and who in many cases promoted philanthropic and educational projects in England.*

**and others. Joint-stock companies have not yet proven themselves equal to managing business properly after such men have created it. Where they have succeeded, it will be found that a very few individuals, and generally but one, have still control of affairs. Joint-stock companies cannot be credited with invention or enterprise. If it were not for the millionaire still in business, leading the way, a serious check would fall upon future improvement, and I believe business men generally will concur in the opinion, which I very firmly hold, that partnership - a very few, not more than two or three men - in any line of business will make full interest upon the capital invested; while a similar concern as a joint-stock company, owned by many in small amounts, will scarcely pay its way and is very likely to fail. Railroads**



may occur to some as examples of joint-stock management, but the same rule applies to these. America has most of the railroads of the world, and it is found that whenever a few able men control a line and make

--- Page 75. The Gospel of Wealth - III The Advantages of Poverty ---

its management their personal affair, dividends are earned where before there were none. The railways of Britain being monopolies, and charging from two to three times higher rates for similar service than those of America, only manage to pay their shareholders a small return. It would be quite another story if these were the property of one or two able men and managed by them.

45. The "promotion" of an individual into a joint-stock concern is precisely what the promotion of the individual is from the House of Commons to the House of Lords. The push and masterfulness of the few owners who have created the business are replaced by the limited authority and regulation performance of routine duties by salaried officials, after promotion. While the career of both

[Baha'i Comment](#)

concern and individual may continue respectable, it is necessarily drill. They are no longer in the race; the great work of both is over. It would not be well for Britain's future if her commercial and manufacturing supremacy depended upon joint-stock companies. It is her individual millionaires who have created this supremacy, and upon them its maintenance still depends. Those who insure steady employment to thousands, at wages not lower than others pay, need not be ashamed of their record; for steady employment is after all, the one indispensable requisite for the welfare and the progress of the people. Still, I am neither concerned nor disposed to dispute Mr. Hughes's assertion that in a state under really Christian principles a millionaire would be an impossibility. He may be right; it is a far guess ahead. But the millionaire will not lack good company in making his exit; for surely nothing is clearer than that in the ideal day there can be no further use whatever for those of Mr. Hughes's profession. The millionaire and the preacher will alike have to find some other use for their talents, some other work to do that they may honorably earn and eat their daily bread. In this I doubt not both will continue to

be eminently successful. The successors of the Rev. Mr. Hughes and myself, arm in arm, will

--- Page 76. The Gospel of Wealth - III The Advantages of Poverty ---

make a pretty pair out in search of some light work with heavy pay.

46. Upon speculations as to the future of the race involving revolutionary change of existing conditions, it seems unwise to dwell. I think we have nothing whatever to do with what may come a thousand or a million years hence, and none of us can know what will come. Our duties lie with the present - with our day and generation; and even these are hard enough to discern. The race toils slowly upward step by step; it has even to create each successive step before it can stand upon it, for

[Yet] Nature is made better by no mean  
But nature makes that mean.

*(21) Winter's Tale, Act IV,  
scene 3, line 89.*

[Baha'i Comment](#)

47. If it attempts to bound over intervening space to any ideal, it will not rise, but fall to lower depths. I cannot, therefore, but regard such speculations a waste of time - of valuable time -- which is imperatively required for dealing with the next step possible in the path upward. And it is in this light that Mr. Gladstone's suggestion is of the greatest value. It accepts and builds upon present conditions - accommodates itself to our present environments. Mr. Gladstone has been engaged during his long public career in focusing, as it were, the various wishes of others, and so grouping them for a common end that practical results might follow. It has been his mission to restrain extremes, and to unite in common action the advance, the center, and the rear. He shows his rare constructive skill in suggesting that there should be formed a brotherhood of those who recognize their duties to their fellows less favored with this world's goods. This society will, no doubt, be so wide as to admit all, no limit being put to the amount of percentage of his surplus which each can secretly resolve to devote to others, nor any interference attempted with the wide field of its application. We may expect kindred societies to be

[Baha'i Comment](#)

formed throughout the

--- Page 77. The Gospel of  
Wealth - III The Advantages  
of Poverty ---

world, and, at intervals, delegates from these might meet together in one world-wide brotherhood, thereby strengthening each other in the desire and effort to do their best to improve the condition of the masses, and to bring rich and poor into closer union. Those who ask, "not how much we ought to give away, but how much we dare retain," would represent the advanced section. Passing from this through many gradations, those who still fondly plead for the continued hereditary transmission of wealth and position and for magnificence in station would constitute the other great wing of the army. All would be equally welcome, equally necessary, it being enough that members of the brotherhood feel that the duty of the day is that, intrusted as they are with surplus wealth beyond their wants, - as their conscience may determine these wants, - they should regularly set apart and expend all or a proportion, greater or less, of the remainder, for the good of their less fortunate fellows, in the manner which seems to each best calculated

to promote their genuine improvement. Should Mr. Gladstone's suggestion find the response which it deserves, he will have added much to the usefulness of his life in a sphere happily far removed from and far above the political; a field in which there can be room neither for strife, jealousy, gain, nor personal ambition; a cause so high, so holy, that all its surroundings must breathe of peace, good will, brotherhood!

48. Every earnest good man, anxious to leave the world a little better than he found it, will wish Mr. Gladstone Godspeed in his new, inspiring task - a task which is indeed "too great for haste, too high for rivalry."

[Baha'i Comment](#)

**MENU:** [HOME](#) » [Reconstruction](#) » [Gospel Content](#) » [Gospel Purpose](#)

# The Gospel of Wealth

And Other Timely Essays

by Andrew Carnegie

**In the right-hand commentary column,  
that which is in GREEN is a commentator's remark and  
that which is in BLUE is from the Baha'i Writings.**

**On occasion, in that column, there may be a [link](#) to an extended comment or  
dissertation on the subject under discussion.**

- -

**A reminder that under "view" on your browser - you can set the text size UP  
or DOWN for a more comfortable read for yourself.**

--- Page 78. The Gospel of Wealth - IV Popular Illusions about Trusts

## IV

### Popular Illusions About Trusts

(1) *Published originally in Century Magazine, LX (May 1900), 143-149.*

1. THE platforms of both parties in the coming Presidential contest are likely to ring with express or implied denunciation of trusts, in order to minister to the popular outcry against them, many of the people having been led to believe that great aggregations of capital must be inimical to the interests of the masses who have little or none. While this policy may be more or less successful for the moment, from a party point of view, it must be ephemeral, because, as the writer hopes

**inimical** - ...They are like selfish, brutal men who are inimical, cursing and killing each other. Better that man should resemble the domestic animals than the ferocious beasts of prey, for in the estimation of God love is acceptable, whereas hatred and animosity are rejected. Why should we act contrary to the good pleasure of God? Why should we be as ferocious animals, constantly shedding blood, pillaging and destroying? Because we belong to one race or family of humankind, why should we consider all others bad and inferior, deserving of death, pillage and invasion--people of darkness, worthy of hatred and detestation by God? We see that God is kind to all. Just as He loves us, He loves all others; just as He provides for us, He provides for the rest. He nurtures and trains all with equal solicitude. (Abdu'l-Baha, PUP, p. 264)

**ephemeral** - ...Hence, no matter how much man may advance in this world, he shall not attain to the station of this bird! Thus it becomes evident that in the matters of this world, however much man may strive and work to the point of death, he will be unable to earn the abundance, the freedom and the independent life of a small bird. This proves and establishes the fact that man is not created for the

to show, trusts cannot permanently thwart the laws of competition, and hence must prove beneficial agencies for the people.

life of this ephemeral world--nay, rather, is he created for the acquirement of infinite perfections, for the attainment to the sublimity of the world of humanity, to be drawn nigh unto the divine threshold, and to sit on the throne of everlasting sovereignty! (Abdu'l-Baha, Tablets of the Divine Plan, p. 45-46)

**ephemeral** - ...Thriving for a time through the devices which their scheming minds had conceived and supported by the ephemeral advantages which fame, ability or fortune can confer these notorious exponents of corruption and heresy have succeeded in protruding for a time their ugly features only to sink, as rapidly as they had risen, into the mire of an ignominious end. (World Order of Baha'u'llah, p. 90)

**ephemeral** - "In the midst of a civilization torn by strifes and enfeebled by materialism, the people of Baha are building a new world. We face at this time opportunities and responsibilities of vast magnitude and great urgency. Let each believer in his inmost heart resolve not to be seduced by the ephemeral allurements of the society around him, nor to be drawn into its feuds and short-lived enthusiasms, but instead to transfer all he can from the old world to that new one which is the vision of his longing and will be the fruit of his labours." (From a letter of the Universal House of Justice to the Baha'is of the East and West, December 18, 1963)

2. The world does not spin round any faster in our day than it has for ages past, but undoubtedly new ideas in the world come into view and flash past with a rapidity hitherto unknown. It seems as if, in our time, man were chiefly absorbed in obeying the injunction to try all things. Fortunately, we evolutionists know that in the end he must and will hold fast only to that which is good for the organism known as human society. His attitude hitherto toward new things or new ideas has been one of suspicion and hesitation. We see traces of this yet in the

**revolutionists** - How great the difference between the glory of Christ and the glory of an earthly conqueror! It is related by historians that Napoleon Bonaparte I embarked secretly by night from Egypt. His destination was France. During his campaign in Palestine revolution had broken out and grave difficulties had arisen in the home government. Christian worship had been forbidden by the revolutionists. The priests of Christianity had fled in terror. France had become atheistic; anarchy prevailed. The ship sailed out into a night brilliant with the light of the moon. Napoleon was pacing up and down the deck. His officers were sitting together, talking. One of them spoke of the similarity between Bonaparte and Christ. Napoleon stopped and said grimly, "Do you think I am going back to France to establish religion?"

Jesus Christ established the religion of God through love. His sovereignty is everlasting. Napoleon overthrew governments in war and bloodshed. His dominion passed away; he himself was dethroned. Bonaparte destroyed human life; Christ was a Savior. Bonaparte controlled the physical bodies of men; Christ was a conqueror of human hearts. None of the Prophets of God were famous men, but They were unique in spiritual power. Love is the eternal sovereignty. Love is the divine power. By it all the kings of earth are overthrown and conquered. (Abdu'l-Baha, PUP, p. 210-



older countries and older civilizations; but the bounding, irrepressible, "cocksure" spirit of Western civilization seems possessed by an entirely different tendency. It grasps everything new with avidity, and is sanguine beyond measure of its merits, ever ready to discard the old, and to see in any new thing the golden

211)

**human society** - ...What mankind needeth in this day is obedience unto them that are in authority, and a faithful adherence to the cord of wisdom. The instruments which are essential to the immediate protection, the security and assurance of the human race have been entrusted to the hands, and lie in the grasp, of the governors of human society. This is the wish of God and His decree.... We cherish the hope that one of the kings of the earth will, for the sake of God, arise for the triumph of this wronged, this oppressed people. Such a king will be eternally extolled and glorified. God hath prescribed unto this people the duty of aiding whosoever will aid them, of serving his best interests, and of demonstrating to him their abiding loyalty. They who follow Me must strive, under all circumstances, to promote the welfare of whosoever will arise for the triumph of My Cause, and must at all times prove their devotion and fidelity unto him. Happy is the man that hearkeneth and observeth My counsel. Woe unto him that faileth to fulfil My wish. (Baha'u'llah, Gleanings, p. 207)

**human society** - ...The ages of its infancy and childhood are past, never again to return, while the Great Age, the consummation of all ages, which must signalize the coming of age of the entire human race, is yet to come. The convulsions of this transitional and most turbulent period in the annals of humanity are the essential prerequisites, and herald the inevitable approach, of that Age of Ages, "the time of the end," in which the folly and tumult of strife that has, since the dawn of history, blackened the annals of mankind, will have been finally transmuted into the wisdom and the tranquility of an undisturbed, a universal, and lasting peace, in which the discord and separation of the children of men will have given way to the worldwide reconciliation, and the complete unification of the divers elements that constitute human society (‘Abdu'l-Baha, Promised Day has Come, p. 117)

**human society** - IV Disunity is a danger that the nations and peoples of the earth can no longer endure; the consequences are too terrible to contemplate, too obvious to require any demonstration. "The well-being of mankind," Baha'u'llah wrote more than a century ago, "its peace and security, are observing that "mankind is groaning, is dying to be led to unity, and to terminate its age-long martyrdom", Shoghi Effendi further commented that: "Unification of the whole of mankind is the hall-mark of the stage which human society is now approaching. Unity of family, of tribe, of city- state, and nation have been successively attempted and fully established. World unity is the goal towards which a harassed humanity is striving. Nation-building has come to an end. The anarchy inherent in state sovereignty is moving towards a climax. A world, growing to maturity, must abandon this fetish, recognize the oneness and wholeness of human

relationships, and establish once for all the machinery that can best incarnate this fundamental principle of its life."

Page 14 All contemporary forces of change validate this view. The proofs can be discerned in the many examples already cited of the favourable signs towards world peace in current international movements and developments. The army of men and women, drawn from virtually every culture, race and nation on earth, who serve the multifarious agencies of the United Nations, represent a planetary "civil service" whose impressive accomplishments are indicative of the degree of co-operation that can be attained even under discouraging conditions. An urge towards unity, like a spiritual springtime, struggles to express itself through countless international congresses that bring together people from a vast array of disciplines. It motivates appeals for international projects involving children and youth. Indeed, it is the real source of the remarkable movement towards ecumenism by which members of historically antagonistic religions and sects seem irresistibly drawn towards one another. Together with the opposing tendency to warfare and self-aggrandizement against which it ceaselessly struggles, the drive towards world unity is one of the dominant, pervasive features of life on the planet during the closing years of the twentieth century. (Promise of World Peace)

--- Page 79. The Gospel of Wealth - IV Popular Illusions about Trusts

bow of promise. The American is the modern magician, ever exchanging old lamps for new. Panaceas for all the ills of life are more numerous than the ills. Not one doctor, but a hundred, arise, competent to cure every defect in the body politic, and none is without patients or-may we write? - dupes. We must all have our toys and our fads. It is natural for man to indulge in the delusions of hope.

**delusions** - Say, wretched indeed is your plight, O ye embodiments of delusion. Fear ye God and reject not the heavenly grace which hath shed radiance upon all regions. Say, He Who is the Exponent of the hidden Name hath appeared, did ye but know it. He Whose advent hath been foretold in the heavenly Scriptures is come, could ye but understand it. The world's horizon is illumined by the splendours of this Most Great Revelation. Haste ye with radiant hearts and be not of them that are bereft of understanding. The appointed Hour hath struck and mankind is laid low. Unto this bear witness the honoured servants of God. (Baha'u'llah, TOB, p. 244)

**delusions** - God created one earth and one mankind to people it. Man has no other habitation, but man himself has come forth and proclaimed imaginary boundary lines and territorial restrictions, naming them Germany, France, Russia, etc. And torrents of precious blood are spilled in defense of these imaginary divisions of our one human habitation, under the delusion of a fancied and limited patriotism.

After all, a claim and title to territory or native land is but a claim and attachment to the dust of earth. We live upon this earth for a few days and then rest beneath it forever. So it is our graveyard eternally. Shall man fight for the tomb which devours him, for his eternal sepulcher? What ignorance could be greater than this? To fight over his grave, to kill another for his grave! What heedlessness! What a

delusion! (ʿAbdu'l-Baha, PUP, p. 355)

**delusions** - I also will choose their delusions, and will bring their fears upon them; because when I called, none did answer; when I spake, they did not hear: but they did evil before mine eyes, and chose that in which I delighted not. Hear the word of the LORD, ye that tremble at his word; Your brethren that hated you, that cast you out for my name's sake, said, Let the LORD be glorified: but he shall appear to your joy, and they shall be ashamed. (Isaiah 66:4-5)

Say: "Have ye seen (these) 'Partners' of yours whom ye call upon besides God? Show Me what it is they have created in the (wide) earth. Or have they a share in the heavens? Or have We given them a Book from which they (can derive) clear (evidence)?- Nay, the wrong-doers promise each other nothing but delusions. (Quran, 35.040)

3. The day is not far past when the industrial world saw its millennium in the joint-stock idea. Every department of industry was to be captured by it. Shares in every conceivable enterprise were to be distributed among the people en masse, thus insuring the much-needed redistribution of wealth, where every man was no longer a consumer only, but his own manufacturer, his own transporter, clothier, butcher, baker, and candlestick-maker. There was nothing to prevent him being in one sense his own undertaker through shares in the "Burial Company, Limited," or the "Crematorium Company," thus carrying out to his very end the grand joint-stock corporation panacea. Every employee in mill or factory, in railway or steamship service,

**wealth** - All praise be to God Who hath adorned the world with an ornament, and arrayed it with a vesture, of which it can be despoiled by no earthly power, however mighty its battalions, however vast its wealth, however profound its influence. Say: the essence of all power is God's, the highest and the last End of all creation. The source of all majesty is God's, the Object of the adoration of all that is in the heavens and all that is on the earth. Such forces as have their origin in this world of dust are, by their very nature, unworthy of consideration. (Bahá'u'lláh, GL, p. 341)

**Wealth** - is most commendable, provided the entire population is wealthy. If, however, a few have inordinate riches while the rest are impoverished, and no fruit or benefit accrues from that wealth, then it is only a liability to its possessor. If, on the other hand, it is expended for the promotion of knowledge, the founding of elementary and other schools, the encouragement of art and industry, the training of orphans and the poor--in brief, if it is dedicated to the welfare of society--its possessor will stand out before God and man as the most excellent of all who live on earth and will be accounted as one of the people of paradise. (ʿAbdu'l-Baha, Secret Divine Civilization, p. 24-25)

...let your faces be more radiant with hope and heavenly determination to serve the Cause of God, to spread the pure fragrances of the divine rose garden of unity, to awaken spiritual susceptibilities in the hearts of mankind, to kindle anew the spirit of humanity with divine fires and to reflect the glory of heaven to this gloomy world of materialism. When you possess these divine susceptibilities, you will be able to awaken and develop them in others. We cannot give of our wealth to the poor unless we possess it. How can the poor give to the poor? How can the soul that is

was soon to become an owner, with a possible future seat on the board.

deprived of the heavenly bounties develop in other souls capacity to receive those bounties? ( `Abdu'l-Bahá, PUP, p. 7)

...our weakness is an evidence that there is might; our ignorance proves the reality of knowledge; our need is an indication of supply and wealth. Were it not for wealth, this need would not exist; were it not for knowledge, ignorance would be unknown; were it not for power, there would be no impotence. In other words, demand and supply is the law, and undoubtedly all virtues have a center and source. That source is God, from Whom all these bounties emanate. ( `Abdu'l-Bahá, PUP, p. 83)

4. Though all these over-sanguine expectations have not been realized through the laws establishing corporations, thus encouraging the massing of the innumerable small savings of the public in general, yet few new forms have been productive of so much benefit to the thrifty and aspiring people with small savings, who are the salt of the working millions and of the country, as the corporate idea.

**expectations** - The principle of collective trusteeship creates also the right of every person to expect that those cultural conditions essential to his or her identity enjoy the protection of national and international law. Much like the role played by the gene pool in the biological life of humankind and its environment, the immense wealth of cultural diversity achieved over thousands of years is vital to the social and economic development of a human race experiencing its collective coming-of-age. It represents a heritage that must be permitted to bear its fruit in a global civilization. On the one hand, cultural expressions need to be protected from suffocation by the materialistic influences currently holding sway. On the other, cultures must be enabled to interact with one another in ever-changing patterns of civilization, free of manipulation for partisan political ends.

"The light of men", Baha'u'llah says, "is Justice. Quench it not with the contrary winds of oppression and tyranny. The purpose of justice is the appearance of unity among men. The ocean of divine wisdom surgeth within this exalted word, while the books of the world cannot contain its inner significance." (Prosperity of Humankind, p. 6-7)

5. Another highly important step forward in this domain resulted from the authorization of limited partnerships, by which the undoubted advantages of individual over corporate management could be secured without danger of ruin to the members, whose liability is limited to the amount of the capital stock of the partnership. In the great corporation the shares are generally bought and sold upon the

--- Page 80. The Gospel of Wealth - IV Popular Illusions about Trusts

stock exchange, and the real owners are unknown. All depends upon salaried officials, who may or may not have a dollar in the enterprise. In the limited partnership, on the contrary, only shareholders can be members; the shares are not sold to outsiders, and thus is insured the eye of the master over all. With proper, but absolutely necessary, provisions, it is possible, under this system, to create owners from among exceptional but poor employees, from whom no capital is required, the partnership agreeing to permit the profits to pay for the

**capitalistic** - "Regarding your questions concerning the Baha'i attitude on various economic problems, such as the problem of ownership, control and distribution of capital, and of other means of production, the problem of trusts and monopolies, and such economic experiments as social cooperatives; the Teachings of Baha'u'llah and Abdu'l-Baha do not provide specific and detailed solutions to all such economic questions which mostly pertain to the domain of technical economics, and as such do not concern directly the Cause. True, there are certain guiding principles in Baha'i Sacred Writings on the subject of economics, but these do by no means cover the whole field of theoretical and applied economics, and are mostly intended to guide further Baha'i economic writers and technicians to evolve an economic system which would function in full conformity with the spirit and the exact provisions of the Cause on this and similar subjects. The International House of Justice will have, in consultation with economic experts, to assist in the formulation and evolution of the Baha'i economic system of the future. One thing, however, is certain, that the Cause neither accepts the theories of the Capitalistic economics in full, nor can it agree with the Marxists and Communists in their repudiation of the principle of private ownership and of the vital sacred rights of the individual." (Lights of Guidance, p 549-550 From a letter written on behalf of Shoghi Effendi to an individual believer, June 10, 1930: Ibid.)

interest given, the capitalistic owners reserving the right to discontinue the partnership by a two-thirds vote, or a three-fourths majority vote, should the new partner not prove desirable. By this plan it is possible for the rise of the poor but able employee, thus neutralizing, to some extent, the acknowledged difficulty of men rising to ownership in our day, because of the enormous amount of capital required for successful operations under present, and probably enduring, conditions. The day of small concerns within the means of many able men seems to be over, never to return. The rise to partnership in vast concerns must come chiefly through such means as these permitted by the laws of limited partnership.

6. To-day we hear little of the joint-stock corporation, which has settled into its proper sphere and escapes notice. It was succeeded by the "syndicate," a combination of corporations which pulled together for a time, and expected to destroy destructive competition. The word has already almost passed out of use, and now the syndicate has given place to the trust.

**competition** - ...Political love also is much bound up with hatred of one party for another; this love is very limited and uncertain. The love of community of interest in service is likewise fluctuating; frequently competitions arise, which lead to jealousy, and at length hatred replaces love. A few years ago, Turkey and Italy had a friendly political understanding; now they are at war! All these ties of love are imperfect. It is clear that limited material ties are insufficient to adequately express the universal love. The great unselfish love for humanity is bounded by none of these imperfect, semi-selfish bonds; this is the one perfect love, possible to all mankind, and can only be achieved by the power of the Divine Spirit. No worldly power can accomplish the universal love.

Let all be united in this Divine power of love! Let all strive to grow in the light of the Sun of Truth, and reflecting this luminous love on all men, may their hearts become so united that they may dwell evermore in the radiance of the limitless love. (Abdu'l-Bahá, PT, p. 36-37)

7. We see in all these efforts of men the desire to furnish opportunities to mass capital, to concentrate the small savings of the many and to direct them to one end. The conditions of human society create for this an imperious demand; the concentration of capital is a necessity for meeting the demands of our day, and as such should not be looked at askance, but be encouraged. There is nothing detrimental

--- Page 81. The Gospel of Wealth - IV Popular Illusions about Trusts

to human society in it, but much that is, or is bound soon to become, beneficial. It is an evolution from the heterogeneous to the homogeneous,

*(2) Spencer's Law of Evolution, enunciated in Part 2 of First Principles (1862), reads: "an integration of matter and concomitant dissipation of motion, during which the matter passes from an indefinite incoherent homogeneity to a definite coherent heterogeneity." Carnegie, not notably exact in quotation, has here literally reversed the order of "development" commentary on his subservience to or understanding of the English thinker.*

and is clearly another step in the upward path of development.

**capital** - It is quite otherwise with the human species, which persists in the greatest error, and in absolute iniquity. Consider an individual who has amassed treasures by colonizing a country for his profit: he has obtained an incomparable fortune and has secured profits and incomes which flow like a river, while a hundred thousand unfortunate people, weak and powerless, are in need of a mouthful of bread. There is neither equality nor benevolence. So you see that general peace and joy are destroyed, and the welfare of humanity is negated to such an extent as to make fruitless the lives of many. For fortune, honors, commerce, industry are in the hands of some industrialists, while other people are submitted to quite a series of difficulties and to limitless troubles: they have neither advantages, nor profits, nor comforts, nor peace.

Then rules and laws should be established to regulate the excessive fortunes of certain private individuals and meet the needs of millions of the poor masses; thus a certain moderation would be obtained. However, absolute equality is just as impossible, for absolute equality in fortunes, honors, commerce, agriculture, industry would end in disorderliness, in chaos, in disorganization of the means of existence, and in universal disappointment: the order of the community would be quite destroyed. Thus difficulties will also arise when unjustified equality is imposed. It is, therefore, preferable for moderation to be established by means of laws and regulations to hinder the constitution of the excessive fortunes of certain individuals, and to protect the essential needs of the masses. For instance, the manufacturers and the industrialists heap up a treasure each day, and the poor artisans do not gain their daily sustenance: that is the height of iniquity, and no just man can accept it. Therefore, laws and regulations should be established which would permit the workmen to receive from the factory owner their wages and a share in the fourth or the fifth part of the profits, according to the capacity of the factory; or in some other way the body of workmen and the manufacturers should share equitably the profits and advantages. Indeed, the capital and management come from the owner of the factory, and the work and labor, from the body of the workmen. Either the workmen should receive wages which assure them an adequate support and, when they cease work, becoming feeble or helpless, they should have sufficient benefits from the income of the industry; or the wages should be high enough to satisfy the workmen with the amount they receive so that they may themselves be able to put a little aside for days of want and helplessness.

When matters will be thus fixed, the owner of the factory will no longer put aside daily a treasure which he has absolutely no need of (for, if the fortune is disproportionate, the capitalist succumbs under a formidable burden and gets into the greatest difficulties and

troubles; the administration of an excessive fortune is very difficult and exhausts man's natural strength). And the workmen and artisans will no longer be in the greatest misery and want; they will no longer be submitted to the worst privations at the end of their life. It is, then, clear and evident that the repartition of excessive fortunes among a small number of individuals, while the masses are in need, is an iniquity and an injustice. In the same way, absolute equality would be an obstacle to life, to welfare, to order and to the peace of humanity. In such a question moderation is preferable. It lies in the capitalists' being moderate in the acquisition of their profits, and in their having a consideration for the welfare of the poor and needy-- that is to say, that the workmen and artisans receive a fixed and established daily wage-- and have a share in the general profits of the factory.

It would be well, with regard to the common rights of manufacturers, workmen and artisans, that laws be established, giving moderate profits to manufacturers, and to workmen the necessary means of existence and security for the future. Thus when they become feeble and cease working, get old and helpless, or leave behind children under age, they and their children will not be annihilated by excess of poverty. And it is from the income of the factory itself, to which they have a right, that they will derive a share, however small, toward their livelihood.

In the same way, the workmen should no longer make excessive claims and revolt, nor demand beyond their rights; they should no longer go out on strike; they should be obedient and submissive and not ask for exorbitant wages. But the mutual and reasonable rights of both associated parties will be legally fixed and established according to custom by just and impartial laws. In case one of the two parties should transgress, the court of justice should condemn the transgressor, and the executive branch should enforce the verdict; thus order will be reestablished, and the difficulties, settled. The interference of courts of justice and of the government in difficulties pending between manufacturers and workmen is legal, for the reason that current affairs between workmen and manufacturers cannot be compared with ordinary affairs between private persons, which do not concern the public, and with which the government should not occupy itself. In reality, although they appear to be private matters, these difficulties between the two parties produce a detriment to the public; for commerce, industry, agriculture and the general affairs of the country are all intimately linked together. If one of these suffers an abuse, the detriment affects the mass. Thus the difficulties between workmen and manufacturers become a cause of general detriment. (Abdu'l-Bahá, SAQ, p. 273-276)

**homogeneity** - What is true of the life of the individual has its



parallels in human society. The human species is an organic whole, the leading edge of the evolutionary process. That human consciousness necessarily operates through an infinite diversity of individual minds and motivations detracts in no way from its essential unity. Indeed, it is precisely an inhering diversity that distinguishes unity from homogeneity or uniformity. What the peoples of the world are today experiencing, Bahá'u'lláh said, is their collective coming-of-age, and it is through this emerging maturity of the race that the principle of unity in diversity will find full expression. From its earliest beginnings in the consolidation of family life, the process of social organization has successively moved from the simple structures of clan and tribe, through multitudinous forms of urban society, to the eventual emergence of the nation-state, each stage opening up a wealth of new opportunities for the exercise of human capacity. (Prosperity of Humankind, p. 4)

**8. Abreast of this necessity for massing the wealth of the many in even larger and larger sums for huge enterprises, another law is seen in operation in the invariable tendency from the beginning till now to lower the cost of all articles produced by man. Through the operation of this law the home of the laboring man of our day boasts luxuries which even in the palaces of monarchs as recent as Queen Elizabeth were unknown. It is a trite saying that the comforts of to-day were the luxuries of yesterday, and conveys only a faint impression of the contrast, until one walks through the castles and palaces of older countries, and learns that two or three centuries ago these had for carpets only rushes, small open spaces for windows, glass being little known, and**

**Luxuries** - The Captivity of Man - `Abdu'l-Bahá said:--"Luxuries cut off the freedom of communication. One who is imprisoned by desires is always unhappy; the children of the Kingdom have unchained themselves from their desires. Break all fetters and seek for spiritual joy and enlightenment; then, though you walk on this earth, you will perceive yourselves to be within the divine horizon. To man alone is this possible. When we look about us we see every other creature captive to his environment.

"The bird is a captive in the air and the fish a captive in the sea. Man alone stands apart and says to the elements, I will make you my servants! I can govern you! He takes electricity, and through his ingenuity imprisons it and makes of it a wonderful power for lighting, and a means of communication to a distance of thousands of miles. But man himself may become a captive to the things he has invented. His true second birth occurs when he is freed from all material things: for he only is free who is not a captive to his desires. He has then as Jesus has said, become captive to the Holy Spirit." ( `Abdu'l-Bahá in London, p. 87-88)

were without gas or water-supply, or any of what we consider to-day the conveniences of life. As for those chief treasures of life, books, there is scarcely a working-man's family which has not at its command, without money and without price, access to libraries to which the palace was recently a stranger.

9. If there be in human history one truth clearer and more indisputable than another, it is that the cheapening of articles, whether of luxury or of necessity or of those classed as artistic, insures their more general distribution, and is one of the most potent factors in refining and lifting a people, and in adding to its happiness. In no period of human activity has this great agency been so potent or so widespread as in our own. Now, the cheapening of all these

--- Page 82. The Gospel of Wealth - IV Popular Illusions about Trusts

good things, whether it be in the metals, in textiles, or in food, or especially in books and prints, is rendered possible only through the operation of the law, which may be stated thus:

[Baha'i Comment](#)

cheapness is in proportion to the scale of production. To make ten tons of steel a day would cost many times as much per ton as to make one hundred tons; to make one hundred tons would cost double as much per ton as a thousand; and to make one thousand tons per day would cost greatly more than to make ten thousand tons. Thus, the larger the scale of operation the cheaper the product. The huge steamship of twenty thousand tons burden carries its ton of freight at less cost, it is stated, than the first steamships carried a pound. It is, fortunately, impossible for man to impede, much less to change, this great and beneficent law, from which flow most of his comforts and luxuries, and also most of the best and most improving forces in his life.

10. In an age noted for its inventions, we see the same law running through these. Inventions facilitate big Operations, and in most instances require to be worked upon a great scale. Indeed, as a rule, the great invention which is beneficent in its operation would be useless unless operated to supply a thousand people where ten were supplied

[Baha'i Comment](#)

before. Every agency in our day labors to scatter the good things of life, both for mind and body, among the toiling millions. Everywhere we look we see the inexorable law ever producing bigger and bigger things. One of the most notable illustrations of this is seen in the railway freight-car. When the writer entered the service of the Pennsylvania Railroad from seven to eight tons were carried upon eight wheels; to-day they carry fifty tons. The locomotive has quadrupled in power. The steamship to-day is ten times bigger, the blast-furnace has seven times more capacity, and the tendency everywhere is still to increase. The contrast between the hand printing-press of old and the elaborate newspaper printing-machine of to-day is even more marked.

11. We conclude that this overpowering, irresistible tendency

--- Page 83. The Gospel of Wealth - IV Popular Illusions about Trusts

toward aggregation of capital and increase of size in every branch of product cannot be arrested or even greatly impeded, and that, instead of attempting to restrict either,

**aggregation** - ...All things are involved in all things. For every single phenomenon has enjoyed the postulates of God, and in every form of these infinite electrons it has had its characteristics of perfection.

Thus this flower once upon a time was of the soil. The animal eats the flower or its fruit, and it thereby ascends to the animal kingdom. Man eats the meat of the animal, and there you have its ascent into the human kingdom, because all phenomena are divided into that which eats and that which is eaten. Therefore, every primordial atom of these atoms, singly and indivisible, has had its courings throughout all the sentient creation, going constantly into the aggregation of the various elements. Hence do you have the conservation of energy and the infinity of phenomena, the indestructibility of phenomena, changeless and immutable, because life cannot suffer annihilation but only change.

we should hail every increase as something gained, not for the few rich, but for the millions of poor, seeing that the law is salutary, working for good and not for evil. Every enlargement is an improvement, step by step, upon what has preceded. It makes for higher civilization, for the enrichment of human life, not for one, but for all classes of men. It tends to bring to the laborer's cottage the luxuries hitherto enjoyed only by the rich, to remove from the most squalid homes much of their squalor, and to foster the growth of human happiness relatively more in the workman's home than in the millionaire's palace. It does not tend to make the rich poorer, but it does tend to make the poor richer in the possession of better things, and greatly lessens the wide and deplorable gulf between the rich and the poor. Superficial politicians may, for a time, deceive the uninformed, but more and more will all this be clearly seen by those who are now led to regard aggregations as injurious.

The apparent annihilation is this: that the form, the outward image, goes through all these changes and transformations. Let us again take the example of this flower. The flower is indestructible. The only thing that we can see, this outer form, is indeed destroyed, but the elements, the indivisible elements which have gone into the composition of this flower are eternal and changeless. Therefore the realities of all phenomena are immutable. Extinction or mortality is nothing but the transformation of pictures and images, so to speak--the reality back of these images is eternal. And every reality of the realities is one of the bounties of God. (Foundations of World Unity, p. 52)

**salutary** - You cannot give up a salutary law just because on rare occasions the innocent may be punished. (Bahá'u'lláh, Kitáb-i-Aqdás, p. 204)

**superficial** - Those who are uninformed of the world of reality, who do not comprehend existing things, who are without perception of the inner truth of creation, who do not penetrate the real mysteries of material and spiritual phenomena and who possess only a superficial idea of universal life and being are but embodiments of pure ignorance. They believe only that which they have heard from their fathers and ancestors. Of themselves they have no hearing, no sight, no reason, no intellect; they rely solely upon tradition. Such persons imagine that the dominion of God is an accidental dominion or kingdom.

For instance they believe that this world of existence was created six or seven thousand years ago; as if God did not reign before that time and had no creation before that period. They think that divinity is accidental, for to them divinity is dependent upon existing things whereas in reality as long as there has been a God there has been a creation. As long as there has been light, there have been recipients of that light, for light cannot become manifest unless those things which perceive and appreciate it exist. The world of divinity presupposes creation, presupposes recipients of bounty, presupposes the existence of worlds. No divinity can be conceived as separate from creation, for otherwise it would be like imagining an empire without a people. A king must needs have a kingdom, must needs have an army and subjects. Is it possible to be a king and have no country, no army, no subjects? This is an absurdity. If we say that there was a time when there was no country, no army and no subjects, how then could there have been a king and ruler? For these things are essential to a king. (Foundations of World Unity, p. 107)

**superficial** - "People today indeed do tend to be very superficial in their thinking, and it would seem as if the educational systems in use are sorely lacking in ability to produce a mature mind in a person

who has reached supposedly adult life! All the outside influences that surround the individual seem to have an intensely distracting effect, and it is a hard job to get the average person to do any deep thinking or even a little meditation on the problems facing him and the world at large. Over and over again Baha'u'llah cried out against the heedlessness of humanity, and warns of the fate such an attitude must lead to. Did we not know what God plans to do, and will do, with the world in the future, we should certainly be as hopeless as many of the best thinkers of our generation have become." (From a letter written on behalf of the Guardian to an individual believer, September 22, 1948) Lights of Guidance, page 211-212)

**superficial - AMERICA PASSING THROUGH CRISIS -**

Moreover, the country of which it forms a part is passing through a crisis which, in its spiritual, moral, social and political aspects, is of extreme seriousness-- a seriousness which to a superficial observer is liable to be dangerously underestimated.

The steady and alarming deterioration in the standard of morality as exemplified by the appalling increase of crime, by political corruption in ever widening and ever higher circles, by the loosening of the sacred ties of marriage, by the inordinate craving for pleasure and diversion, and by the marked and progressive slackening of parental control, is no doubt the most arresting and distressing aspect of the decline that has set in, and can be clearly perceived, in the fortunes of the entire nation.

Parallel with this, and pervading all departments of life--an evil which the nation, and indeed all those within the capitalist system, though to a lesser degree, share with that state and its satellites regarded as the sworn enemies of that system--is the crass materialism, which lays excessive and ever-increasing emphasis on material well-being, forgetful of those things of the spirit on which alone a sure and stable foundation can be laid for human society. ... (Citadel of Faith, p. 124-125)

12. In all great movements, even of the highest value, there is cause for criticism, and new dangers arising from new conditions, which must be guarded against. There is no nugget free from more or less impurity, and no good cause without its fringe of scoria. The sun itself has spots, but, as has been wisely said, these are rendered visible only by the light itself sends forth.

**criticism** - 155 Motive, manner, mode, become relevant; but there is also the matter of love: love for one's fellows, love for one's community, love for one's institutions. The responsibility resting on the individual to conduct himself in such away as to ensure the stability of society takes on elemental importance in this context. For vital as it is to the progress of society, criticism is a two-edged sword: it is all too often the harbinger of conflict and contention. (Individual Rights and Freedoms)

13. The benefits, therefore, which have come to the world through this law of aggregation and increase take several forms, to some of which objection is made.

[Baha'i Comment](#)

14. One form of aggregation is the growth of establishments constantly extending their field of operations, the special form which has been most criticized being the department store. We look back to the time when one petty establishment sold one class of articles. The subdivision of labor is seen in its fullest development throughout the Eastern world,

[Baha'i Comment](#)

--- Page 84. The Gospel of Wealth - IV Popular Illusions about Trusts

where many servants are

required, each restricted to doing one part of many operations required to produce one whole. Traces of this system still linger among us. In dealing with department stores the first question is, Do they provide articles at less cost for the masses? Upon cheapness, indeed, depends the wider distribution of desirable articles among the people, the enjoyment of which is greatly to be desired as inevitably carrying with it elevation to a higher stage of civilization. Increased comfort means increased refinement, and this means a higher standard of life. No one questions the fact that these great stores do furnish more value for the money than it was possible for small separate selling agencies to do. The increased scale of operations all under one management insures much cheaper distribution. That they are so generally patronized is the best proof that they are beneficial, and, what should not be lost sight of, they are relatively more advantageous for the general public than for the few rich. In like manner it is the masses of the people, not the few, who are most benefited by the growth of huge and all-embracing establishments in every line of production and distribution. It is inevitable



that the introduction of a new system should disturb and finally overthrow the older and less desirable system.

15. The chief complaint made against the department stores is that, while under the old system of small separate establishments there were secured as valuable citizens to the State a hundred independent owners, the department store may have only five. In the writer's opinion, this is a mistake, as experience already demonstrates that the great and successful establishment is dependent upon numerous active members participating directly in the results. It may be accepted as a law that the store which interests the greatest number of assistants, other things being equal, will prove the most successful, and it is a matter of common knowledge even to-day that in these vast establishments it is already the rule for all those in charge of the numerous departments

--- Page 85. The Gospel of Wealth - IV Popular Illusions about Trusts

to be directly interested in the profits. In other words, the small, petty master in his little store has given place to the

**character** - For every thing, however, God has created a sign and symbol, and established standards and tests by which it may be known. The spiritually learned must be characterized by both inward and outward perfections; they must possess a good character, an enlightened nature, a pure intent, as well as intellectual power, brilliance and discernment, intuition, discretion and foresight, temperance, reverence, and a heartfelt fear of God. For an unlit candle, however great in diameter and tall, is no better than a barren palm tree or a pile of dead wood. (Abdu'l-Bahá, SDC, p. 33-34)

Perhaps someone will say that, since the capacity and worthiness of men differ, therefore, the difference of capacity certainly causes the difference of characters.

But this is not so, for capacity is of two kinds: natural capacity and acquired capacity. The first, which is the creation of God, is purely good--in the creation of God there is no evil; but the acquired capacity has become the cause of the appearance of evil. For example, God has created all men in such a manner and has given them such a constitution and such capacities that they are benefited by sugar and honey and harmed and destroyed by poison. This nature and constitution is innate, and God has given it equally to all mankind. But man begins little by little to accustom himself to poison by taking a small quantity each day, and gradually increasing it, until he reaches such a point that he cannot live without a gram of opium every day. The natural capacities are thus completely perverted. Observe how much the natural capacity and constitution can be changed, until by different habits and training they become entirely perverted. One does not criticize vicious people because of their innate capacities and nature, but rather for their acquired capacities and nature. (Abdu'l-Bahá, SAQ, p. 215)

#### THE CAUSES OF THE DIFFERENCES IN THE CHARACTERS OF MEN

Question.--How many kinds of character has man, and what is the cause of the differences and varieties in men?

Answer.--He has the innate character, the inherited character, and the acquired character which is gained by education.

With regard to the innate character, although the divine creation is purely good, yet the varieties of natural qualities in man come from

**bigger, much more important manager of a department, those revenues generally exceed those of the petty owner he has supplanted. Nor is this all: the field for the display of exceptional ability is much wider than it could possibly be in the smaller establishment, and will as often win partnership in one of these establishments, or at least an equivalent of partnership, as the owner of the small store achieved success. This bigger system grows bigger men, and it is by the big men that the standard of the race is raised. The race of shopkeepers is bound to be improved, and to become not only better business men, and better men in themselves, but more valuable citizens for the State. Dealing with petty affairs tends to make small men; dealing with larger affairs broadens and strengthens character.**

the difference of degree; all are excellent, but they are more or less so, according to the degree. So all mankind possess intelligence and capacities, but the intelligence, the capacity and the worthiness of men differ. This is evident.

For example, take a number of children of one family, of one place, of one school, instructed by one teacher, reared on the same food, in the same climate, with the same clothing, and studying the same lessons--it is certain that among these children some will be clever in the sciences, some will be of average ability, and some dull. Hence it is clear that in the original nature there exists a difference of degree and varieties of worthiness and capacity. This difference does not imply good or evil but is simply a difference of degree. One has the highest degree, another the medium degree, and another the lowest degree. So man exists; the animal, the plant and the mineral exist also--but the degrees of these four existences vary. What a difference between the existence of man and of the animal! Yet both are existences. It is evident that in existence there are differences of degrees. (‘Abdu'l-Bahá, SAQ, p. 212-213)

**16. We have taken department stores as the form most under criticism, but what we have said here may be taken as said of all other branches of business, that the larger the scale upon which it can be successfully conducted the better it is for the race as a whole, and in greater degree better for the masses of the race than for the few.**

Baha'i Comment

17. We come now to another phase of aggregation: the consolidation of various works scattered in different parts of the country into one solid company. These consolidations are now classed as trusts.

[Baha'i Comment](#)

18. As far as the consolidation of various plants engaged in one branch of manufacture is concerned, this is only obeying the great law of aggregation, which, we have seen, is beneficial, although the real object of the consolidators may, in some cases, have been the belief that through these consolidations ruinous competition might be ended. Color is given to this belief because it is obvious that the cheapening of product cannot result to so great an extent by combining works in scattered places as when one establishment enlarges itself. On the other hand, something is to be allowed

[Baha'i Comment](#)

--- Page 86. The Gospel of Wealth - IV Popular Illusions about Trusts

for the claim that each separate work may be utilized to supply the wants of a tributary region, thus saving

cost of transportation. The one solid enlarged establishment will, however, probably be able to manufacture its surplus not needed in the region tributary to it at a cost so much less than is possible at the small scattered establishments as to enable it to pay the freight upon what it desires to sell beyond its natural territory. In so far as consolidation of scattered works is intended to save cost of transportation, and thus to produce more cheaply, the consolidation is to be hailed as beneficial for the country; for the foundation upon which we rest: is that cheapness of articles leads to their wider distribution among the masses, and is a gain when attained. Reduced cost of production, under the free play of competition, insures reduced prices to the consumer.

19. The people are aroused against trusts because they are said to aim at securing monopolies in the manufacture and distribution of their products; but the whole question is, Have they succeeded, or can they succeed, in monopolizing products? Let us consider. That the manufacturer of a patented article can maintain

**monopoly** - ... If fair-minded and intelligent men of knowledge should ponder and reflect upon the judicious laws of the Lord of mankind, they will no doubt bear witness to the perfection of Divine Providence in the laws thus instituted. For instance, these three firm and irrefutable ordinances, namely, first: the question of inheritance by which monopoly of wealth will be removed and the question of socialism solved; second: the question of universal peace and international agreements regarding disarmament and conserving expenditure now devoted to implements of war; third: the question of all being commanded to acquire a profession, art or trade whereby they May earn a living, thus lightening the burden of expense to those upon whom it falls, such as farmers, laborers, et al. This expense is created by the idlers and unemployed members of the human family.

a monopoly goes without saying. Our laws expressly give him a monopoly. That it has been wise for the State to give an inventor this for a time will not be seriously questioned. So beneficial has it proved that the nations of the world are one after the other following our patent laws. Our chief industrial rival, Great Britain, has done so as far as possible, and the chairman of the British Patent Commission expressed to me the regret that it was found impracticable, at present, to go further in the same direction.

These fair-minded and intelligent men will also testify that the readjustment of the world and the salvation of mankind from great dangers is conditioned upon following the commands of this Most Great Manifestation. Thus will they utter the blessed words: "Blessed is God, the Possessor of the Dominion and the Kingdom!" (The Brilliant Proof, p. 68-69)

20. There are only two conditions other than patents which render it possible to maintain a monopoly. These are when the parties absolutely control the raw material out of which the article is produced, or control territory into which rivals can enter only with extreme difficulty. Such is virtually the case with the Standard Oil Company, and as long as it can

**legislation** - The Baha'i Cause covers all economic and social questions under the heading and ruling of its laws. The essence of the Baha'i spirit is that, in order to establish a better social order and economic condition, there must be allegiance to the laws and principles of government. Under the laws which are to govern the world, the socialists may justly demand human rights but without resort to force and violence. The governments will enact these laws, establishing just legislation and economics in order that all humanity may enjoy a full measure of welfare and privilege; but this will always be according to legal protection and procedure. Without legislative administration, rights and demands fail, and the welfare of the commonwealth cannot be realized. Today the method of demand is the strike and resort to force, which is manifestly wrong and destructive of human foundations. Rightful privilege and demand must be set forth in laws and regulations.

While thousands are considering these questions, we have more essential purposes. The fundamentals of the whole economic condition are divine in nature and are associated with the world of the heart and spirit. This is fully explained in the Baha'i teaching, and without knowledge of its principles no improvement in the economic state can be realized. The Baha'is will bring about this improvement and betterment but not through sedition and appeal to physical force--not through warfare, but welfare. Hearts must be so cemented together, love must become so dominant that the rich shall most willingly extend assistance to the poor and take steps to

--- Page 87. The Gospel of Wealth - IV Popular Illusions about Trusts

maintain a monopoly of raw materials it goes without saying that it can maintain a

monopoly in the product. This is a fact that the public must recognize, but what legislation can do to prevent it is difficult to say. Citizens of the United States have a right to buy anything they choose. This right could scarcely be restricted, nor, upon the whole, would it seem wise to restrict it, since that of the Standard Oil is the only case in which monopoly of an article has been secured. It has been rendered possible only by exceptional ability and in circumstances not likely ever to occur again. The price of its continued success is a line of such able men as its originators. Its second source of strength lies in the fact that through its extensive operations it has been enabled to reduce the price of its product to the consumer. it is a unique organization, for there is nothing like it in the world, and therefore it is not to be classed with the ordinary trusts, which are numerous and are constantly increasing.

establish these economic adjustments permanently. If it is accomplished in this way, it will be most praiseworthy because then it will be for the sake of God and in the pathway of His service. For example, it will be as if the rich inhabitants of a city should say, "It is neither just nor lawful that we should possess great wealth while there is abject poverty in this community," and then willingly give their wealth to the poor, retaining only as much as will enable them to live comfortably. (‘Abdu’l-Bahá, Promulgation Universal Peace, p. 238- 239)

21. Within the last few months a wholly new and enterprising development of the trust idea has appeared in the railway world - one which reflects much credit upon the brain which conceived it. This is the purchase by the leading trunk-lines of large amounts of the stock of their less prominent competitors. We now see a vice-president of the Pennsylvania Railway Company sitting on the board of the Baltimore and Ohio. The possible outcome of this movement, if pursued, assumes portentous proportions, far surpassing in their effect any previous phase of the trust, and may lead to an extension of the powers of the Interstate Commission, and perhaps to other legislation at present unthought of. The subject is too far-reaching for more than mere mention in this paper. The country must see its future development, which will be waited with deep concern by the thoughtful student of economic problems.

**Trusts** - The question of socialization is very important. It will not be solved by strikes for wages. All the governments of the world must be united and organize an assembly the members of which should be elected from the parliaments and the nobles of the nations. These must plan with utmost wisdom and power so that neither the capitalist suffer from enormous losses nor the laborers become needy. In the utmost moderation they should make the law; then announce to the public that the rights of the working people are to be strongly preserved. Also the rights of the capitalists are to be protected. When such a general plan is adopted by the will of both sides, should a strike occur, all the governments of the world collectively should resist it. Otherwise, the labor problem will lead to much destruction, especially in Europe. Terrible things will take place.

For instance, the owners of properties, mines and factories should share their incomes with their employees and give a fairly certain percentage of their products to their workmen in order that the employees may receive, beside their wages, some of the general income of the factory so that the employee may strive with his soul in the work. No more trusts will remain in the future. The question of the trusts will be wiped away entirely. Also, every factory that has ten thousand shares will give two thousand shares of these ten thousand to its employees and will write the shares in their names, so that they may have them, and the rest will belong to the capitalists. Then at the end of the month or year whatever they may earn after the expenses and wages are paid, according to the number of shares, should be divided among both. In reality, so far great injustice has befallen the common people. Laws must be made because it is impossible for the laborers to be satisfied with the present system. They will strike every month and every year. Finally, the capitalists will lose. In ancient times a strike occurred among the Turkish soldiers. They said to the government: "Our wages are very small and they should be increased." The government was forced to give them their demands. Shortly afterwards they struck again. Finally all the incomes went to the pockets of the soldiers to the extent that they killed the king, saying: "Why didst thou not increase the income so that we might have received more?"

It is impossible for a country to live properly without laws. To solve this problem rigorous laws must be made, so that all the governments of the world will be the protectors thereof. (Abdu'l-Bahá, Foundations of World Unity, p. 43-44)

22. The genesis of trusts is as follows: Manufacturers of most staple articles (especially of iron and steel) are subject to long periods of serious depression, succeeded by short inter-

[Baha'i Comment](#)

--- Page 88. The Gospel of Wealth - IV Popular Illusions about Trusts

vals of high profits. Because during depression no increase is made in capacity, and the world's population and wants are constantly growing, one morning it is discovered that demand has overtaken and outrun supply. But the production of an increased supply is no easy matter. It usually means, beginning at the beginning, obtaining the raw materials from mine or soil, passing these through various processes for which the necessary machinery and facilities are wanting, and it is a year or eighteen months, or even two years, before the supply of most articles can be materially increased. Demand becomes imperious and unsatisfied, and prices bound upward. Many new men are induced to build new works. The extensions of the old works supply all demands, and even a shade beyond; then comes the collapse. It is during one of these long



periods of depression, when many of the manufacturers are on the verge of bankruptcy, that there arises in the heart a hope, soon crystallized into a belief, that a new way has been found to avoid the natural consequences of the unchanging economic laws. It is soon felt that savage competition should cease between those enduring a common affliction, who should be brother manufacturers, and that the lion and the lamb should lie down together. They forget, in the hour of their misery, that the moralist has expressed the fear lest the one may be found inside the other. First, all kinds of understandings and fair promises are made - alas! only to be broken; and finally the promoter makes his appearance, and our unfortunate manufacturers fall an easy prey. Enormous sums are offered for antiquated plants which may not have been able to do more than pay their way for years. These are tied together, and the new industrial makes its appearance as a trust, under the delusion that if a dozen or twenty invalids be tied together vitality will be infused thereby into the mass. This is not true of all that are classed as trusts; there are exceptions; I speak only

generally.

23. Should these combinations be made upon the eve of a

--- Page 89. The Gospel of Wealth - IV Popular Illusions about Trusts

period of activity, as was the case recently, then there is a triumphant vindication of the new nostrum, the industrial world has found its panacea for all ills, and there is never to be ruinous competition again. The public is alarmed; it hears for a time of the advance of prices in the products of these gigantic concerns which temporarily control the market, and demands legislation against them. Generally speaking, as in the present instance, the advance in prices would have taken place even if no trusts existed, being caused by increased demand. The very name of trust stinks in our nostrils. We believe the public to be needlessly alarmed upon the subject, for the following reasons:

[Baha'i Comment](#)

24. Few trusts have a monopoly through patents or through the supply of raw material or of territory, and what happens is this: For a short time competition is hindered, but rarely, if ever, completely stifled. The profits of the trusts are high, and capital, ever watchful for an opportunity to make unusual gains, seeks its level by a law of its being, and needs only the opportunity to engage in this highly profitable manufacture. A relative of one of the principal officials or one of the chiefs of a department in the trust, knowing its great profits, gets some friend with capital to build new works in cooperation with him, and the result is that we soon see springing up over the country rival works, each of which has the great giant trust more or less at its mercy. A threat to reduce prices, and the trust, to which this may mean millions of dollars of loss, will sooner or later come to an agreement with the little David who threatens to attack the Goliath, and the rival concern is arranged with or purchased. This only whets the appetite of others who see the success of the first innovator, and other works soon spring up. No sooner has the trust purchased one threatened rival than two appear, and the end is

[Baha'i Comment](#)

disaster. The people may rest assured that neither in one article nor in another is it possible for any trust to exact exorbitant profits without thereby speedily undermining its own foundations. It is not

--- Page 90. The Gospel of Wealth - IV Popular Illusions about Trusts

long since trusts first made their appearance, and already many have disappeared. Many still existing are being assailed, the names of which will readily occur to our readers. Only a few survive to-day, and none have secured the coveted monopoly. Most of the metals and many of the staple articles have been formed into trusts, which, although yet living, are rapidly being attacked to their final destruction. The press used to tell every morning of the organization of some trust or other, and even to-day we still hear of proposed additions to the list of these attempted gigantic monopolies, which enjoy an ephemeral existence. Upon most of them can already be written the appropriate epitaph:

It was so soon to be done for,  
I wonder what I was begun for."

*(3) The first line should read: "It is so soon that I am done for."*

*An Epitaph "For a Child Aged Three Weeks,"  
Cheltenham  
Churchyard.*

25. Every attempt to monopolize the manufacture of any staple article carries within its bosom the seeds of failure. Long before we could legislate with much effect against trusts there would be no necessity for legislation. The past proves this, and the future is to confirm it. There should be nothing but encouragement for these vast aggregations of capital for the manufacture of staple articles. As for the result being an increase of price to the consumer beyond a brief period, there need be no fear. On the contrary, the inevitable result of these aggregations is, finally and permanently, to give to the consumer cheaper articles that would have been otherwise possible to obtain; for capital is stimulated by the high profits of the trust, for a season, to embark against it. The result is very soon a capacity of production beyond the wants of the consumer, and as the new works erected are of the most improved pattern, and capable of producing cheaper than the old works, the vulnerable

[Baha'i Comment](#)

trusts are compelled to buy and capitalize at two or three times their cost. There is thus no danger ahead to the community from trusts, nor any cause for fear.

--- Page 91. The Gospel of Wealth - IV Popular Illusions about Trusts

26. The great natural laws, being the outgrowth of human nature and human needs, keep on their irresistible course. Competition in all departments of human activity is not to be suppressed. The individual manufacturer who is tempted into the unusually profitable business of the trust will take care of the monopoly question and prevent injury to the nation. The trust, so far as aggregation and enlargement go, is one day to be recognized as a grand step toward cheaper products for the people than could have been obtained by any other mode than the aggregation of capital and establishments. Already the ghosts of numerous departed trusts which aimed at monopolies have marched across the stage of human affairs, each pointing to its fatal wound, inflicted by that great corrective, competition. Like the ghosts of Macbeth's victims, the line promises to

[Baha'i Comment](#)

stretch longer and longer, and also like those phantoms of the brain, they "come like shadows, so depart."

The earth hath bubbles  
as the water hath,  
And these are of them.

*(4) Macbeth, Act I, scene  
3, line 79.*

The masses of the people, the toiling millions, are soon to find in this great law of aggregation of capital and of factories another of those beneficent agencies which in their operation tend to bring to the homes of the poor, in greater degree than ever, more and more of the luxuries of the rich, and into their lives more of sweetness and light. The only people who have reason to fear trusts are those who trust them.

Carnegie TEXT here.

[Baha'i Comment](#)

**MENU: [HOME](#) » [Reconstruction](#) » [Gospel Content](#) » [Gospel Purpose](#)**

# The Gospel of Wealth

And Other Timely Essays

by Andrew Carnegie

**In the right-hand commentary column,  
that which is in GREEN is a commentator's remark and  
that which is in BLUE is from the Baha'i Writings.  
On occasion, in that column, there may be a [link](#) to an extended comment or  
dissertation on the subject under discussion.**

- -

***A reminder that under "view" on your browser - you can set the text size UP  
or DOWN for a more comfortable read for yourself.***

--- Page 92. The Gospel of Wealth - V An Employer's View of the Labor Question

## V

### An Employer's View of the Labor Question

*(1) From the Forum, I (April 1886), 114-125.*

1. THE struggle in which labor has been engaged during the past three hundred years, first against authority and then against capital, has been a triumphal march. Victory after victory has been achieved. Even so late as in Shakespere's time, remains of villeinage or serfdom still existed in England. Before that, not only the labor but the person of the laborer belonged to the chief. The workers were either slaves or serfs; men and women were sold with the estate upon

[Baha'i Comment](#)



which they worked, and became the property of the new lord, just as did the timber which grew on the land. In those days we hear nothing of strikes or of trades-unions, or differences of opinion between employer and employed. The fact is, labor had then no right which the chief, or employer, was bound to respect. Even as late as the beginning of this century, the position of the laborer in some departments was such as can scarcely be credited. What do our laboring friends think of this, that down to 1779 the miners of Britain were in a state of serfdom. They "were compelled by law to remain in the pits as long as the owner chose to keep them at work there, and were actually sold as part of the capital invested in the works. If they accepted an engagement elsewhere, their master could always have them fetched back and flogged as thieves for having attempted to rob him of their labor. This law was modified in 1779, but was not repealed till after the acts passed in

--- Page 93. The Gospel of Wealth - V An Employer's View of the Labor Question

1797 and 1799" (The Trades-Unions of England, p. 119).

(2) *By Louis Philippe, Albert*

*d'Orleans, Comte de Paris (1830-1894). His Les Associations ouvries en Angleterre was translated and published in England in 1869 (Thomas Hughes, ed.).*

This was only ninety-seven years ago. Men are still living who were living then. Again, in France, as late as 1806, every workman had to procure a license; and in Russia, down to our own days, agricultural laborers were sold with the soil they tilled.

2. Consider the change, nay, the revolution. Now the poorest laborer in America or in England, or indeed throughout the civilized world, who can handle a pick or a shovel, stands upon equal terms with the purchaser of his labor. He sells or withholds it as may seem best to him. He negotiates, and thus rises to the dignity of an independent contractor. When he has performed the work he bargained to do, he owes his employer nothing, and is under no obligation to him. Not only has the laborer conquered his political and personal freedom: he has achieved industrial freedom as well, as far as the law can give it, and he now fronts his master, proclaiming himself his equal under the law.

[Baha'i Comment](#)

3. But, notwithstanding this complete revolution, it is evident that the permanent relations to each other of labor and capital have not yet evolved. The present adjustment does not work without friction, and changes must be made before we can have industrial pence. To-day we find collisions between these forces, capital and labor, when there should be combination. The mill hands of an industrial village in France have just risen against their employers, attacked the manager's home and killed him. The streets of another French village are barricaded against the expected forces of order. The ship-builders of Sunderland, in England, are at the verge of starvation, owing to a quarrel with their employers; and Leicester has just been the scene of industrial riots. In our country, labor disputes and strikes were never so numerous as now.

*(3) For work stoppages -- strikes or boycotts -- there are only fragmentary figures before 1850. Beginning with that date the United States Commissioner of Labor began a more systematic compilation. These statistics bore out Carnegie's contention. Following the depression of 1884-1885 there was a nationwide wave of strikes. In 1885, when Carnegie must have been maturing this essay, an index of strikes and workers involved increased by fifty per cent. The next year, 1886, was*

[Baha'i Comment](#)

*to be even more fruitful of labor turbulence. Its full impact came in May, after the publication of this essay, but the rapid growth of labor union membership, the multiplication of new unions, and "the great railroad strike" on the southwest lines of Jay Gould occurred in the early months of that year.*

East and West, North and South,

--- Page 94. The Gospel of Wealth - V An Employer's View of the Labor Question

everywhere, there is unrest, showing that an equilibrium has not yet been reached between employers and employed.

4. A strike or lockout is, in itself, a ridiculous affair. Whether a failure or a success, it gives no direct proof of its justice or injustice. In this it resembles war between two nations. It is simply a question of strength and endurance between the contestants. The gage of battle, or the duel, is not more senseless, as a means of establishing what is just and fair, than an industrial strike or lockout. It would be folly to conclude that we have reached any permanent adjustment between capital and labor until strikes and lockouts are as much things of the past as the gage of battle

[Baha'i Comment](#)

or the duel have become in the most advanced communities.

5. Taking for granted, then, that some further modifications must be made between capital and labor, I propose to consider the various plans that have been suggested by which labor can advance another stage in its development in relation to capital. And, as a preliminary, let it be noted that it is only labor and capital in their greatest masses which it is necessary to consider. It is only in large establishments that the industrial unrest of which I have spoken ominously manifests itself. The farmer who hires a man to assist him, or the gentleman who engages a groom or a butler, is not affected by strikes. The innumerable cases in which a few men only are directly concerned, which comprise in the aggregate the most of labor, present upon the whole a tolerably satisfactory condition of affairs. This clears the ground of much, and leaves us to deal only with the immense mining

--- Page 95. The Gospel of Wealth - V An Employer's View of the Labor Question

[Baha'i Comment](#)

and manufacturing concerns of recent growth, in which capital and labor often array themselves in alarming antagonism.

6. Among expedients suggested for their better reconciliation, the first place must be assigned to the idea of cooperation, or the plan by which the workers are to become part-owners in enterprises, and share their fortunes.

*(4) Producer's co-operation was of immense interest to organized labor in the post-Civil War era. Aside from harmonizing appealingly with American ideals, it was during depression years a form of unemployment relief. The officers of the Knights of Labor gave the device much verbal, though inconstant, support; it also made a wide appeal to liberal preachers, professors, and editors. Even E. L. Godkin (1831-1902), editor of the Nation and generally a conservative spokesman, supported co-operation. In the mid-eighties, the "highest point of the cooperative movement," producers' cooperative ventures numbered 135, chiefly in mining, cooperage, and shoes. Most were very small scale enterprises.*

There is no doubt that if this could be effected it would have the same beneficial effect upon the workman which the ownership of land has upon the man who has hitherto tilled the land for another. The sense of ownership would make of him

[Baha'i Comment](#)

more of a man as regards himself, and hence more of a citizen as regards the commonwealth. But we are here met by a difficulty which I confess I have not yet been able to overcome, and which renders me less sanguine than I should like to be in regard to cooperation. The difficulty is this, and it seems to me inherent in all gigantic manufacturing, mining, and commercial operations. Two men or two combinations of men will erect blast-furnaces, iron-mills, cotton-mills, or piano manufactories adjoining each other, or engage in shipping or commercial business. They will start with actual capital and credit; and to those only superficially acquainted with the personnel of these concerns, success will seem as likely to attend the one as the other.

Nevertheless, one will fail after dragging along a lifeless existence, and pass into the hands of its creditors; while the neighboring mill or business will make a fortune for its owners. Now, the successful manufacturer, dividing every month or every year a proportion of his profits among his workmen, either as a bonus or as dividends upon shares

--- Page 96. The Gospel of Wealth - V An Employer's

## View of the Labor Question

owned by them, will not only have a happy and contented body of operatives, but he will inevitably attract from his rival the very best workmen in every department. His rival, having no profits to divide among his workmen, and paying them only a small assured minimum to enable them to live, finds himself despoiled of foremen and of workmen necessary to carry on his business successfully. His workmen are discontented and, in their own opinion, defrauded of the proper fruits of their skill, through incapacity or inattention of their employers. Thus, unequal business capacity in the management produces unequal results.

7. It will be precisely the same if one of these manufactories belongs to the workmen themselves; but in this case, in the present stage of development of the workmen, the chances of failure will be enormously increased. It is, indeed, greatly to be doubted whether any body of workingmen in the world could to-day organize and successfully carry on a mining or manufacturing or commercial business in competition with concerns owned by men

[Baha'i Comment](#)



trained to affairs. If any such cooperative organization succeeds, it may be taken for granted that it is principally owing to the exceptional business ability of one of the managers, and only in a very small degree to the efforts of the mass of workmen-owners. This business ability is excessively rare, as is proved by the incredibly large proportion of those who enter upon the stormy sea of business only to fail. I should say that twenty cooperative concerns would fail to every one that would succeed. There are, of course, a few successful establishments, notably two in France and one in England, which are organized upon the cooperative plan, in which the workmen participate in the profits. But these were all created by the present owners, who now generously share the profits with their workmen, and are making the success of their manufactories upon the cooperative plan the proud work of their lives. What these concerns will become when the genius for affairs is no longer with them to guide, is a matter of grave doubt and, to me,

--- Page 97. The Gospel of Wealth - V An Employer's View of the Labor Question

of foreboding. I can, of course, picture in my mind a state of civilization in which the most talented business men shall find their most cherished work in carrying on immense concerns, not primarily for their own personal aggrandizement, but for the good of the masses of workers engaged therein, and their families; but this is only a foreshadowing of a dim and distant future. When a class of such men has evolved, the problem of capital and labor will be permanently solved to the entire satisfaction of both. But as this manifestly belongs to a future generation, I cannot consider cooperation, or common ownership, as the next immediate step in advance which it is possible for labor to make in its upward path.

8. The next suggestion is that peaceful settlement of differences should be reached through arbitration. Here we are upon firmer ground. I would lay it down as a maxim that there is no excuse for a strike or a lockout until arbitration of differences has been offered by one party and refused by the other. No doubt serious trouble attends even arbitration at present, from the difficulty of procuring suitable men to judge

[Baha'i Comment](#)

intelligently between the disputants. There is a natural disinclination among business men to expose their business to men in whom they have not entire confidence. We lack, so far, in America a retired class of men of affairs. Our vile practice is to keep on accumulating more dollars until we die. If it were the custom here, as it is in England, for men to withdraw from active business after acquiring a fortune, this class would furnish the proper arbitrators. On the other hand, the ex-presidents of trades-unions, such as Mr. Jarrett or Mr. Wihle,

*(5) John Jarrett, an immigrant from Wales, was a mill worker who became President of the Amalgamated Association of Iron and Steel Workers, a consolidation of the various craft unions in the industry. When the Federation of Organized Trades and Labor Unions, a predecessor of the American Federation, was organized in 1881, Jarrett became the first president. William Weihe (the Carnegie misspelling reflects on his acquaintance with the union in his industry), a native American, succeeded Jarrett in the early eighties as President of the Amalgamated Association of Iron and Steel Workers. Ironically, in view of Carnegie's admiration, Weihe was president of the Association in 1892, when at the Homestead Works, one of the Carnegie plants, occurred the classic test of strength between union and management, the latter represented by Henry Clay Frick (1849-1918). The Homestead Strike of 1892 was, of course, subsequent to this essay.*

after they have retired from active control, would

--- Page 98. The Gospel of Wealth - V An Employer's View of the Labor Question

commend themselves to the manufacturers and to the men as possessed of the necessary technical knowledge, and educated to a point where commercial reasons would not be without their proper weight upon them. I consider that of all the agencies immediately available to prevent wasteful and embittering contests between capital and labor, arbitration is the most powerful and most beneficial.

9. The influence of trades-unions upon the relations between the employer and employed has been much discussed. Some establishments in America have refused to recognize the right of the men to form themselves into these unions, although I am not aware that any concern in England would dare to take this position. This policy, however, may be regarded as only a temporary phase of the situation. The right of the working-men to combine and to form trades-unions is no less sacred than the right of the manufacturer to enter into associations and

[Baha'i Comment](#)

conferences with his fellows, and it must sooner or later be conceded. Indeed, it gives one but a poor opinion of the American workman if he permits himself to be deprived of a right which his fellow in England long since conquered for himself. My experience has been that trades-unions, upon the whole, are beneficial both to labor and to capital. They certainly educate the working-men, and give them a truer conception of the relations of capital and labor than they could otherwise form. The ablest and best workmen eventually come to the front in these organizations; and it may be laid down as a rule that the more intelligent the workman the fewer the contests with employers. It is not the intelligent workman, who knows that labor without his brother capital is helpless, but the blatant ignorant man, who regards capital as the natural enemy of labor, who does so much to embitter the relations between employer and

--- Page 99. The Gospel of Wealth - V An Employer's View of the Labor Question

employed; and the power of this ignorant demagogue arises chiefly from the lack of proper organization among the men through which their

real voice can be expressed. This voice will always be found in favor of the judicious and intelligent representative. Of course, as men become intelligent more deference must be paid to them personally and to their rights, and even to their opinions and prejudices; and, upon the whole, a greater share of profits must be paid in the day of prosperity to the intelligent than to the ignorant workman. He cannot be imposed upon so readily. On the other hand, he will be found much readier to accept reduced compensation when business is depressed; and it is better in the long run for capital to be served by the highest intelligence, and to be made well aware of the fact that it is dealing with men who know what is due to them, both as to treatment and compensation.

10. One great source of the trouble between employers and employed arises from the fact that the immense establishments of to-day, in which alone we find serious conflicts between capital and labor, are not managed by their owners, but by salaried officers, who cannot possibly have any permanent interest in the welfare of the workingmen. These officials are

[Baha'i Comment](#)

chiefly anxious to present a satisfactory balance-sheet at the end of the year, that their hundreds of shareholders may receive the usual dividends, and that they may therefore be secure in their positions, and be allowed to manage the business without unpleasant interference either by directors or shareholders. It is notable that bitter strikes seldom occur in small establishments where the owner comes into direct contact with his men, and knows their qualities, their struggles, and their aspirations. It is the chairman, situated hundreds of miles away from his men, who only pays a flying visit to the works and perhaps finds time to walk through the mill or mine once or twice a year, that is chiefly responsible for the disputes which break out at intervals. I have noticed that the manager who confers oftenest with a committee of

--- Page 100. The Gospel of Wealth - V An Employer's View of the Labor Question

his leading men has the least trouble with his workmen. Although it may be impracticable for the presidents of these large corporations to know the working-men personally, the manager at the mills, having a

committee of his best men to present their suggestions and wishes from time to time, can do much to maintain and strengthen amicable relations, if not interfered with from headquarters. I, therefore, recognize in trades-unions, or, better still, in organizations of the men of each establishment, who select representatives to speak for them, a means, not of further embittering the relations between employer and employed, but of improving them.

11. It is astonishing how small a sacrifice upon the part of the employer will sometimes greatly benefit the men. I remember that at one of our meetings with a committee, it was incidentally remarked by one speaker that the necessity for obtaining credit at the stores in the neighborhood was a grave tax upon the men. An ordinary workman, he said, could not afford to maintain himself and family for a month, and as he only received his pay monthly, he was compelled to obtain credit and to pay exorbitantly for everything, whereas, if he had the cash, he could, buy at twenty-five per cent less. "Well," I said, "why cannot we overcome that by paying every two weeks?" The reply

[Baha'i Comment](#)



was: "We did not like to ask it, because we have always understood that it would cause much trouble; but if you do that it will be worth an advance of five per cent. in our wages." We have paid semi-monthly since. Another speaker happened to say that although they were in the midst of coal, the price charged for small lots delivered at their houses was a certain sum per bushel. The price named was double what our best coal was costing us. How easy for us to deliver to our men such coal as they required, and charge them cost! This was done without a cent's loss to us, but with much gain to the men. Several other points similar to these have arisen by which their labors might be lightened or products increased, and others suggesting changes in machinery or facilities which, but for the

--- Page 101. The Gospel of Wealth - V An Employer's View of the Labor Question

conferences referred to, would have been unthought of by the employer and probably never asked for by the men. For these and other reasons I attribute the greatest importance to an organization of the men, through whose

duly elected representatives the managers may be kept informed from time to time of their grievances and suggestions. No matter how able the manager, the clever workman can often show him how beneficial changes can be made in the special branch in which that workman labors. Unless the relations between manager and workmen are not only amicable but friendly, the owners miss much; nor is any man a first-class manager who has not the confidence and respect, and even the admiration, of his workmen. No man is a true gentleman who does not inspire the affection and devotion of his servants. The danger is that such committees may ask conferences too often; three or four meetings per year should be regarded as sufficient.

12. I come now to the greatest cause of the friction which prevails between capital and labor in the largest establishments the real essence of the trouble, and the remedy I have to propose.

[Baha'i Comment](#)

13. The trouble is that the men are not paid at any time the compensation proper to that time. All large concerns necessarily keep filled with orders, say for six months in advance, and these orders are taken, of course, at prices prevailing when they are booked. This year's operations furnish perhaps the best illustration of the difficulty. Steel rails at the end of last year for delivery this year were \$29 per ton at the works. Of course the mills entered orders freely at this price, and kept on entering them until the demand growing unexpectedly great carried prices up to \$35 per ton. Now, the various mills in America are compelled for the next six months or more to run up orders which do not average \$31 per ton at the seaboard and Pittsburg and pay \$34 at Chicago. Transportation, ironstone, and prices of all kinds have advanced upon them in the meantime, and they must therefore run the

--- Page 102. The Gospel of Wealth - V An Employer's View of the Labor Question

bulk of the year upon very small margins of profit. But the men, noticing in the papers the "great boom in

[Baha'i Comment](#)

steel rails," very naturally demand their share of the advance, and, under existing faulty arrangements between capital and labor, they have secured it. The employers, therefore, have grudgingly given what they know under proper arrangements they should not have been required to give, and there has been friction, and still is dissatisfaction upon the part of the employers. Reverse this picture. The steel-rail market falls again. The mills have still six months' work at prices above the prevailing market, and can afford to pay men higher wages than the then existing state of the market would apparently justify. But having just been amerced in extra payments for labor which they should not have paid, they naturally attempt to reduce wages as the market price of rails goes down, and there arises discontent among the men, and we have a repetition of the negotiations and strikes which have characterized the beginning of this year. In other words, when the employer is going down the employee insists on going up, and vice versa. What we must seek is a plan by which the men will receive high wages when their employers are receiving high prices for their product, and hence are making large

profits; and, per contra, when the employers are receiving low prices for product, and therefore small if any profits, the men will receive low wages.

*(6) Methods of paying labor, whereby wages had a fluctuating relation with changes in the market price of the product, were not uncommon at this time in American industry. Wages were lowered when prices fell and vice versa. Attempts to introduce maximum or minimum limits to wage changes were variants of the scheme. Workers of course preferred a fixed rate of wages. Sliding scales existed in coal mining, shipping on the Great Lakes, and in the iron and steel industry. A dispute over this feature of payment was one facet of the Homestead outbreak.*

If this plan can be found, employers and employed will be "in the same boat," rejoicing together in their prosperity, and calling into play their fortitude together in adversity. There will be no room for quarrels, and instead of a feeling of antagonism

--- Page 103. The Gospel of Wealth - V An Employer's View of the Labor Question

there will be a feeling of partnership between employers and employed.

14. There is a simple means of producing this result, and to its general introduction both employers and employed should steadily bend their energies. Wages should be based upon a sliding scale, in proportion to the net prices received for product month by month. And I here gladly pay Mr. Potter, president of the North Chicago Rolling Mill Company, the great compliment to say that he has already taken a step in this direction, for to-day he is working his principal mill upon this plan. The result is that he has had no stoppage whatever this year, nor any dissatisfaction. All has gone smoothly along, and this in itself is worth at least as much to the manufacturer and to the men as the difference in wages one way or another which can arise from the new system.

[Baha'i Comment](#)

15. The celebrated Crescent Steel Works of Pittsburg, manufacturers of the highest grades of tool steel, pay their skilled workmen by a sliding scale, based upon prices received for product - an important factor in the eminent success of that firm. The scale adopted by the iron manufacturers and workmen is only an approach to the true sliding scale;

[Baha'i Comment](#)

nevertheless it is a decided gain both to capital and labor, as it is adopted from year to year, and hence eliminates strikes on account of wages during the year, and limits these interruptions from that cause to the yearly negotiation as to the justice or injustice of the scale. As this scale, however, is not based upon the prices actually received for product, but upon the published list of prices, which should be received in theory, there is not complete mutuality between the parties. In depressed times, such as the iron industry has been passing through in recent years, enormous concessions upon the published card prices have been necessary to effect sales, and in these the workmen have not shared with their employers. If, however, there was added to the scale, even in its present form, a stipulation that all causes of difference

--- Page 104. The Gospel of Wealth - V An Employer's View of the Labor Question

which could not be postponed till the end of the year, and then considered with the scale, should be referred to arbitration, and that, in case of failure of the owners and workmen to agree at the yearly conference, arbitration

should also be resorted to, strikes and lockouts would be entirely eliminated from the iron business; and if the award of the arbitrators took effect from the date of reference the works could run without a day's interruption.

16. Dismissing, therefore, for the present all consideration of cooperation as not being within measurable distance, I believe that the next steps in the advance toward permanent, peaceful relations between capital and labor are:

[Baha'i Comment](#)

17. *First.* That compensation be paid the men based upon a sliding scale in proportion to the prices received for product.

[Baha'i Comment](#)

18. *Second.* A proper organization of the men of every works to be made, by which the natural leaders, the best men, will eventually come to the front and confer freely with the employers.

[Baha'i Comment](#)



19. *Third.* Peaceful arbitration to be in all cases resorted to for the settlement of differences which the owners and the mill committee cannot themselves adjust in friendly conference.

[Baha'i Comment](#)

20. *Fourth.* No interruption ever to occur to the operations of the establishment, since the decision of the arbitrators shall be made to take effect from the date of reference.

[Baha'i Comment](#)

21. If these measures were adopted by an establishment, several important advantages would be gained:

[Baha'i Comment](#)

22. *First.* The employer and employed would simultaneously share their prosperity or adversity with each other. The scale once settled, the feeling of antagonism would be gone, and a feeling of mutuality would ensue. Capital and labor would be shoulder to shoulder, supporting each other.

[Baha'i Comment](#)

**23. *Second.*** There could be neither strike nor lockout, since both parties had agreed to abide by a forthcoming decision of disputed points. Knowing that in the last resort strangers were to be called in to decide what should be a family affair,

--- Page 105. The Gospel of Wealth - V An Employer's View of the Labor Question

the cases would, indeed, be few which would not be amicably adjusted by the original parties without calling in others to judge between them.

[Baha'i Comment](#)

**24.** Whatever the future may have in store for labor, the evolutionist, who sees nothing but certain and steady progress for the race, will never attempt to set bounds to its triumphs, even to its final form of complete and universal industrial cooperation, which I hope is some day to be reached. But I am persuaded that the next step forward is to be in the direction I have here ventured to point out; and as one who is now most anxious to contribute his part toward helping forward the day of amicable relations between the two forces of capital and

[Baha'i Comment](#)

labor, which are not enemies, but are really auxiliaries who stand or fall together, I ask at the hands of both capital and labor a careful consideration of these views.

Carnegie Text Goes Here

[Baha'i Comment](#)

**MENU: [HOME](#) » [Reconstruction](#) » [Gospel Content](#) » [Gospel Purpose](#)**

# The Gospel of Wealth

And Other Timely Essays

by Andrew Carnegie

**In the right-hand commentary column,  
that which is in GREEN is a commentator's remark and  
that which is in BLUE is from the Baha'i Writings.**

**On occasion, in that column, there may be a [link](#) to an extended comment or  
dissertation on the subject under discussion.**

- -

**A reminder that under "view" on your browser - you can set the text size UP  
or DOWN for a more comfortable read for yourself.**

--- Page 106. The Gospel of Wealth - VI Results of the Labor Struggle

## VI

### Results of the Labor Struggle

*(1) Published originally in the Forum, I (August 1886), 538-551. Between the date of this and the preceding essay, part of organized labor had launched on May 1, 1886, a movement for the eight-hour day. According to one contemporary estimate, no fewer than 340,000 men took part, and 190,000 actually struck. Regionally this labor pressure was most uneven. Chicago was center of great excitement. There the eight-hour program got tangled with an existing strike in the McCormick Harvester Works and with the agitational efforts of a small group of anarchists who displayed the familiar radical desire to fish in troubled waters. A mass meeting called in Haymarket Square on May 4th to protest a police attack upon McCormick workers proved a dull affair, hut later in the evening when the police moved into the Square to disperse the meeting, some unidentified person threw a bomb which killed a police officer. Eight anarchists were arrested and tried as accessories to murder; of the seven sentenced to hang, four were executed, one committed suicide, and two, whose sentences were commuted to life, along with one sentenced to fifteen years, were pardoned in 1893 by Governor Altgeld (1847-1902) of Illinois. The Haymarket trial became one of the most famous illustrations of a miscarriage of justice in American history. Carnegie does not exaggerate the hysteria or terror of the times; few, including many labor leaders, shared his serenity.*

1. WHEN "An Employer's View of the Labor Question" was written, labor and capital were at peace, each performing its proper function; capital providing for the wants of labor, and labor regularly discharging its daily task. But before that paper reached the public the most serious labor revolt that ever occurred in this country was upon us. Capital, frightened almost into panic, began to draw back into its strongholds, and many leaders of public opinion seemed to lose self-command. Among the number were not a few of our foremost political economists. These writers of the closet, a small but important class in this country removed from personal contact with every-day affairs, and uninformed of the solid

--- Page 107. The Gospel of Wealth - VI Results of the Labor Struggle

basis of virtue in the wage-receiving class upon which American society rests, necessarily regarded such phenomena from a purely speculative standpoint. Some of them apparently thought that the fundamental institutions upon which peaceful development depends had been, if not completely overthrown, at

**Institutions** - The Baha'i Commonwealth of the future, of which this vast Administrative Order is the sole framework, is, both in theory and practice, not only unique in the entire history of political institutions, but can find no parallel in the annals of any of the world's recognized religious systems. No form of democratic government; no system of autocracy or of dictatorship, whether monarchical or republican; no intermediary scheme of a purely aristocratic order; nor even any of the recognized types of theocracy, whether it be the Hebrew Commonwealth, or the various Christian ecclesiastical organizations, or the Imamate or the Caliphate in Islam--none of these can be identified or be said to conform with the Administrative Order which the master-hand of its perfect Architect has fashioned. (World Order of Bahá'u'lláh, page 152)

**Economists** - Now concerning our social principles, namely the teachings of His Holiness Bahá'u'lláh spread far and wide fifty years ago, they verily comprehend all other teachings. It is clear and evident that without these teachings progress and advancement for mankind are in no wise possible. Every community in the world findeth in these Divine Teachings the realization of its highest aspirations. These teachings are even as the tree that beareth the best fruits of all trees. Philosophers, for instance, find in these heavenly teachings the most perfect solution of their social problems, and similarly a true and noble exposition of matters that pertain to philosophical questions. In like manner men of faith behold the reality of religion manifestly revealed in these heavenly teachings, and clearly and conclusively prove them to be the real and true remedy for the ills and infirmities of all mankind. Should these sublime teachings be diffused, mankind shall be freed from all perils, from all chronic ills and sicknesses. In like manner are the Baha'i economic principles the embodiment of the highest aspirations of all wage-earning classes and of economists of various schools.

In short, all sections and parties have their aspirations realized in the teachings of Bahá'u'lláh. As these teachings are declared in churches, in mosques and in other places of worship, whether those of the followers of Buddha or of Confucius, in political circles or amongst materialists, all shall bear witness that these teachings bestow a fresh life upon mankind and constitute the immediate remedy for all the ills of social life. None can find fault with any of these teachings, nay rather, once declared they will all be acclaimed, and all will confess their vital necessity, exclaiming, 'Verily this is the truth and naught is there beside the truth but manifest error.'

In conclusion, these few words are written, and unto everyone they will be a clear and conclusive evidence of the truth. Ponder them in thine heart. The will of every sovereign prevaieth during his reign, the will of every philosopher findeth expression in a handful of

least gravely endangered, and that civilization itself had received a rude shock from the disturbance. More than one did not hesitate to intimate that the weakness of democratic institutions lay at the foundation of the revolt. Suggestions were made that the suffrage should be confined to the educated; that the masses might be held in stricter bonds. When we hear the cry of these alarmists we are tempted to reverse the rebuke of the sacred Teacher: they are always troubled more by the mote in their own country's eye than by the beam in the eye of other lands. They forget that not sixty days before, monarchical Belgium was convulsed with labor revolts, compared with which ours were insignificant and practically harmless. That country, with its five and a half millions of inhabitants, had more rioters than the United States, with its fifty-six millions; and instead of restoring peace, as this country did, by means of the established forms of order, the Belgian government had to abandon, for a time, all law, and publicly authorize every citizen to wage private war against the insurgents.

*(2) In March 1886 there was a riot in Liege, followed by outbreaks in all the industrial districts. They were repressed with much*

disciples during his lifetime, but the Power of the Holy Spirit shineth radiantly in the realities of the Messengers of God, and strengtheneth Their will in such wise as to influence a great nation for thousands of years and to regenerate the human soul and revive mankind.

Consider how great is this power! It is an extraordinary Power, an all-sufficient proof of the truth of the mission of the Prophets of God, and a conclusive evidence of the power of Divine Inspiration.

(ABDU'L-BAHA'S TABLET TO DR. FOREL, p. 26-28)

*bloodshed.*

2. Our magazines, reviews, and newspapers have been filled with plans involving radical changes considered necessary by these socialists for the restoration and maintenance of proper relations between capital and labor. The pulpit has been equally prolific. Thirty days have not elapsed since the excitement was at its height, and yet to-day capital and labor are again cooperating everywhere, as at the date of my first paper, and we are now in position to judge of the extent of the disturbance and to reduce the specter to its real dimensions. It will soon be seen that what occurred was a very

--- Page 108. The Gospel of Wealth - VI Results of the Labor Struggle

inadequate cause for the alarm created. The eruption was not, in itself, a very serious matter, either in its extent or in its consequences. Its lesson lay in the indications it gave of the forces underlying it. There are in the United States today a total of more than twenty millions of workers who earn their bread by the sweat of their brow; in trade and

**Press** - We return to the phenomenal characteristics of speech. Content, volume, style, tact, wisdom, timeliness are among the critical factors in determining the effects of speech for good or evil.

Consequently, the friends need ever to be conscious of the significance of this activity which so distinguishes human beings from other forms of life, and they must exercise it judiciously.

Their efforts at such discipline will give birth to an etiquette of expression worthy of the approaching maturity of the human race.

Just as this discipline applies to the spoken word, it applies equally to the written word; and it profoundly affects the operation of the press.

The significance and role of the press in a new world system are conspicuous in the emphasis which the Order of Bahá'u'lláh places on accessibility to information at all levels of society.

Shoghi Effendi tells us that Bahá'u'lláh makes "specific reference to 'the swiftly appearing newspapers', describes them as 'the mirror of the world' and as 'an amazing and potent phenomenon', and prescribes to all who are responsible for their production the duty to be sanctified from malice, passion and prejudice, to be just and fair-minded, to be painstaking in their inquiries, and ascertain all the facts in every situation".

In His social treatise, "The Secret of Divine Civilization", `Abdu'l-Baha offers insight as to the indispensability of the press in future society.

He says it is "urgent that beneficial articles and books be written, clearly and definitely establishing what the present-day requirements of the people are, and what will conduce to the happiness and advancement of society".

Further, He writes of the "publication of high thoughts" as the "dynamic power in the arteries of life", "the very soul of the world".

Moreover, He states that, "Public opinion must be directed toward whatever is worthy of this day, and this is impossible except through the use of adequate arguments and the adducing of clear, comprehensive and conclusive proofs."

transportation alone there are more than seven millions. At the very height of the revolt, not more than 250,000 of these had temporarily ceased to labor. This was the estimate given by "Bradstreet's" on the 14th of May. Three days later it was 80,000, and four days after that only 47,000. The remaining millions continued to pursue their usual vocations in peace. It is fair to assume that the number reported on the 14th of May included all those who were dissatisfied and had requested advance of wages or redress of grievances, but were not really strikers at all. A demonstration that shrinks to one fourth its size from the 14th to the 17th of May, and then again to one half its remaining proportions in the next three days, can scarcely be called a contest. The number of those involved in a serious struggle with capital did not, therefore, at any one time exceed 50,000 - not one per cent of the total wage-receiving class, in the brandies where labor troubles occurred. How then, one is tempted to ask, did so small an interruption seem so great? Why was it taken for granted that a general revolt of labor had taken place, when not one worker in a hundred had really entered

As to manner and style, Bahá'u'lláh has exhorted "authors among the friends" to "write in such a way as would be acceptable to fair-minded souls, and not lead to cavilling by the people".

And He issues a reminder: "We have said in the past that one word hath the influence of spring and causeth hearts to become fresh and verdant, while another is like unto blight which causeth the blossoms and flowers to wither."

In the light of all this, the code of conduct of the press must embrace the principles and objectives of consultation as revealed by Bahá'u'lláh.

Only in this way will the press be able to make its full contribution to the preservation of the rights of the people and become a powerful instrument in the consultative processes of society, and hence for the unity of the human race. (Individual Rights & Freedoms, #165-179)



upon a contest? The reason for the delusion is obvious. The omnipresent press, with the electric telegraph at its command, spreads the report of a local disturbance in East St. Louis over the entire three million square miles of the land.

*(3) The great railroad strike of 1886 was precipitated on the Gould southwest lines, Texas Pacific, Missouri Pacific, and others, by the Knights of Labor in order to raise the wages of unskilled workers, secure the recognition of the union, and punish Gould for the discharge of union workmen in spite of an understanding concluding a strike in 1885. The outbreak did not involve at first hand engineers, firemen, conductors, or brakemen, who were organized in brotherhoods or craft unions. Shopmen, trackmen, and yardmen contributed the strike's core; telegraphers were sympathetic. About 9,000 strikers were involved. The local leader was Martin Irons, a machinist who had emigrated from Scotland as a boy. A Congressional committee stigmatized him as "a dangerous if not pernicious man." In any case he did not act harmoniously with the centralized command of the Knights, notably Terence V. Powderly (1849-1924), Grand Master Workman. The strikers effectively interfered with freight traffic by "killing engines" and other devices, and the strike did great damage to the commerce and prosperity of St. Louis. The "chaos" which the Congressional committee found endemic in East St. Louis erupted in April into a day of violence with gunfire and incendiarism. Early in May the strike petered out; Gould was victorious.*

It is felt almost as

--- Page 109. The Gospel of  
Wealth - VI Results of the  
Labor Struggle

distinctly in New Orleans, Boston, and San Francisco as in the city of St. Louis itself, upon the opposite side of the river. The thoughts of men throughout the country concentrate upon this one point of outbreak. Excitable natures fancy the trouble to be general, and even imagine that the very ground trembles under their own feet. In this way the petty, local difficulty upon the Wabash system of railways, which involved only 3700 Knights of Labor, and a strike of a few hundred men on the Third Avenue Railway, New York, together with a few trifling and temporary disputes at other points, were magnified into a general warfare between capital and labor. There were but a few local skirmishes; peace already reigns; and our professors and political economists and the whole school of pessimists who tremble for the safety of human society in general, and of the Republic in particular, and the ministers that have bodily essayed to revolutionize existing conditions, are free to find another subject for their anxious fears and forebodings. The relations between capital

and labor which have slowly evolved themselves in the gradual development of the race will not be readily changed. The solid walls with which humanity fortifies itself in each advanced position gained in its toilsome march forward will not fall to the ground at the blast of trumpets. Present conditions have grown up slowly, and can be changed for the better only slowly and by small, successive steps. A short history of the disturbances will, however, furnish many useful and needed lessons.

3. The trouble grew, as many serious troubles do grow, from a trifle. A leader of the Knights of Labor was dismissed.

--- Page 110. The Gospel of Wealth - VI Results of the Labor Struggle

Whether the fact that he was a labor leader influenced his superior to dismiss him will probably never be known; but this much is to be said, that it was very likely to do so. Salaried officials in the service of large corporations are naturally disposed to keep under them only such men as give them no trouble.

**leadership** - How pathetic indeed are the efforts of those leaders of human institutions who, in utter disregard of the spirit of the age, are striving to adjust national processes, suited to the ancient days of self-contained nations to an age which must either achieve the unity of the world, as adumbrated by Bahá'u'lláh, or perish. At so critical an hour in the history of civilization it behoves the leaders of all the nations of the world, great and small, whether in the East or in the West, whether victors or vanquished, to give heed to the clarion call of Bahá'u'lláh and, thoroughly imbued with a sense of world solidarity, the sine qua non of loyalty to His Cause, arise manfully to carry out in its entirety the one remedial scheme He, the Divine Physician, has prescribed for an ailing humanity. Let them discard, once for all, every preconceived idea, every national prejudice, and give heed to the sublime counsel of `Abdu'l-Bahá, the authorized Expounder of His teachings. You can best serve your country, was `Abdu'l-Bahá's rejoinder to a high official in the service of the federal government of the United States of America, who had questioned Him as to the best manner in which he could promote the interests of his government and people, if you strive, in your capacity as a citizen of the world, to assist in the eventual application of the principle of federalism underlying the government of your own country to the relationships now existing between the peoples and nations of the world. (Peace, page 21)

That materialistic ideals have, in the light of experience, failed to satisfy the needs of mankind calls for an honest acknowledgement that a fresh effort must now be made to find the solutions to the

agonizing problems of the planet. The intolerable conditions pervading society bespeak a common failure of all, a circumstance which tends to incite rather than relieve the entrenchment on every side. Clearly, a common remedial effort is urgently required. It is primarily a matter of attitude. Will humanity continue in its waywardness, holding to outworn concepts and unworkable assumptions? Or will its leaders, regardless of ideology, step forth and, with a resolute will, consult together in a united search for appropriate solutions? (Promise of World Peace, page 6)

4. On the other hand, the safety of its leaders is the key of labor's position. To surrender that is to surrender everything. Even if the leader in question had not been as regularly at work as other men, even if he had to take days now and then to attend to official duties for his brethren, the superior of that man should have dealt very leniently with him. The men cannot know whether their leader is stricken down for proper cause or not; but, at the same time, they cannot help suspecting. And here I call the attention of impartial minds to the elements of manhood and the high sense of honor and loyalty displayed upon the part of working-men who sacrifice so much and throw themselves in the front of the conflict to secure the safety of their standard-bearers. Everything reasonable can be done with men of this spirit. The loyalty which they show to their leaders can be transferred to their employers by treating

**courtesy** - Say: Let truthfulness and courtesy be your adorning. Suffer not yourselves to be deprived of the robe of forbearance and justice, that the sweet savors of holiness may be wafted from your hearts upon all created things. Say: Beware, O people of Baha, lest ye walk in the ways of them whose words differ from their deeds. Strive that ye may be enabled to manifest to the peoples of the earth the signs of God, and to mirror forth His commandments. Let your acts be a guide unto all mankind, for the professions of most men, be they high or low, differ from their conduct. It is through your deeds that ye can distinguish yourselves from others. Through them the brightness of your light can be shed upon the whole earth. Happy is the man that heedeth My counsel, and keepeth the precepts prescribed by Him Who is the All-Knowing, the All-Wise. (Bahá'u'lláh, Gleanings, page 305)

**dignity** - All men have been created to carry forward an ever-advancing civilization. The Almighty beareth Me witness: To act like the beasts of the field is unworthy of man. Those virtues that befit his dignity are forbearance, mercy, compassion and loving-kindness towards all the peoples and kindreds of the earth. Say: O friends! Drink your fill from this crystal stream that floweth through the heavenly grace of Him Who is the Lord of Names. Let others partake of its waters in My name, that the leaders of men in every land may fully recognize the purpose for which the Eternal Truth hath been revealed, and the reason for which they themselves have been created. (Bahá'u'lláh, Gleanings, page 215)

them as such men deserve. Society has nothing to fear from men so staunch and loyal to one another. Nor is the loyalty shown in this instance exceptional; it distinguishes working-men as a class. Mr. Irons has said that "one hour's gentlemanly courtesy on the part of the manager would have averted all the disaster." Whether this be true or not, the statement should not be overlooked, for it is true that one hour of courtesy on the part of employers would prevent many strikes. Whether the men ask in proper manner for interviews, or observe all the rules of etiquette, is immaterial. We expect from the presumably better-informed party representing capital much more in this respect than from labor; and it is not asking too much of men intrusted with the management of great properties that they should devote some part of their attention to searching out the

--- Page 111. The Gospel of Wealth - VI Results of the Labor Struggle

causes of disaffection among their employees, and, where any exist, that they should meet the men more than half-way in the endeavor to allay them. There is nothing but

good for both parties to be derived from labor teaching the representative of capital the dignity of man, as man. The workingman, becoming more and more intelligent, will hereafter demand the treatment due to an equal.

5. The strikers at first were excusable, even if mistaken, in imagining that their leader had been stricken down; but, under the excitement of conflict, violence was resorted to; and further, an attempt was made to drag into the quarrel railway lines that had nothing to do with it. The men took up these wrong positions and were deservedly driven from them. And labor here received a salutary lesson--namely, that nothing is to be gained by violence and lawlessness, nor by endeavoring to unjustly punish the innocent for the sins of the guilty. Public sentiment, always disposed to side with labor, was with the men at first, but soon finding itself unable to sanction their doings, it veered to the other side. When the strikers lost that indispensable ally they lost all.

**STRIKES** - You have questioned me about strikes. This question is and will be for a long time the subject of great difficulties. Strikes are due to two causes. One is the extreme greed and rapacity of the manufacturers and industrialists; the other, the excesses, the avidity and intransigence of the workmen and artisans. It is, therefore, necessary to remedy these two causes.

But the principal cause of these difficulties lies in the laws of the present civilization; for they lead to a small number of individuals accumulating incomparable fortunes, beyond their needs, while the greater number remain destitute, stripped and in the greatest misery. This is contrary to justice, to humanity, to equity; it is the height of iniquity, the opposite to what causes divine satisfaction.

This contrast is peculiar to the world of man: with other creatures--that is to say, with nearly all animals--there is a kind of justice and equality. Thus equality exists in a shepherd's flock and in a herd of deer in the country. Likewise, among the birds of the prairie, of the plain, of the hills or of the orchard, and among every kind of animal some kind of equality prevails. With them such a difference in the means of existence is not to be found; so they live in the most complete peace and joy.

It is quite otherwise with the human species, which persists in the greatest error, and in absolute iniquity. Consider an individual who has amassed treasures by colonizing a country for his profit: he has obtained an incomparable fortune and has secured profits and incomes which flow like a river, while a hundred thousand unfortunate people, weak and powerless, are in need of a mouthful of bread. There is neither equality nor benevolence. So you see that general peace and joy are destroyed, and the welfare of humanity is negated to such an extent as to make fruitless the lives of many. For fortune, honors, commerce, industry are in the hands of some industrialists, while other people are submitted to quite a series of difficulties and to limitless troubles: they have neither advantages, nor profits, nor comforts, nor peace.

Then rules and laws should be established to regulate the excessive fortunes of certain private individuals and meet the needs of millions of the poor masses; thus a certain moderation would be obtained. However, absolute equality is just as impossible, for absolute equality in fortunes, honors, commerce, agriculture, industry would end in disorderliness, in chaos, in disorganization of the means of existence, and in universal disappointment: the order of the community would be quite destroyed. Thus difficulties will also arise when unjustified equality is imposed. It is, therefore, preferable for moderation to be established by means of laws and regulations to hinder the constitution of the excessive fortunes of certain individuals, and to protect the essential needs of the masses. For instance, the manufacturers and the industrialists heap up a treasure each day, and the poor artisans do not gain their daily sustenance: that is the height of iniquity, and no just man can accept it. Therefore, laws and regulations should be established which would permit the workmen to receive from the factory owner their wages and a share in the fourth or the fifth part of the profits, according to the capacity of the factory; or in some other way the body of workmen and the manufacturers should share equitably the profits and advantages. Indeed, the capital and management come from the owner of the factory, and the work and labor, from the body of the workmen.

Either the workmen should receive wages which assure them an adequate support and, when they cease work, becoming feeble or helpless, they should have sufficient benefits from the income of the industry; or the wages should be high enough to satisfy the workmen with the amount they receive so that they may themselves be able to put a little aside for days of want and helplessness. ( `Abdu'l-Bahá, SAQ, Pages 274-275)

**6. The other branch of the revolt of labor occurred in New York city, where the employees of the Third Avenue Railway struck for fewer hours and better pay. If ever a strike was justifiable this one was. It is simply disgraceful for a corporation to compel its men to work fifteen or sixteen hours a day. Such was the verdict of the public, and the men won a deserved victory. Here again,**

### Trade Unions and Strikes - Guidelines in Respect to Membership in Trade Unions and Participation in Strikes

"On the question of trade unions the Guardian's secretary made the following comment on his behalf in a letter dated 2 February 1951. 'Regarding your question about trade unions: The Guardian considers that this is a matter for each National Spiritual Assembly to advise the believers on. As long as the trade unions are not members of any particular political party, there does not seem to be any objection to the Baha'is belonging to them.'

"...the British National Spiritual Assembly wrote to the Guardian as follows: 'In this country the law recognises strikes as legal when called by properly constituted authorities such as a Trade Union, and our own understanding is that in such circumstances the Baha'i teaching, in spite of Abdu'l-Baha's express disapproval of strikes,

as at St. Louis, for lack of proper leadership, they went too far; and in their demand for the employment of certain men and the dismissal of others they lost their only sure support - public sentiment. This was compelled to decide against their final demands, and consequently they failed, and deservedly failed. How completely public sentiment, when aroused, compels obedience, as we have seen it did both at St. Louis and in New York city, is further shown by the result of the order, issued June 6, requiring the men of all the city railroads in Brooklyn

--- Page 112. The Gospel of Wealth - VI Results of the Labor Struggle

and New York to stop work until the striking employees of the Third Avenue line were reinstated. The edict was disregarded by the men themselves, who found that compliance would not be approved by the community, and that, therefore, the attempt would fail. It was an attempt that the worst foe of labor might have instigated.

neither requires nor forbids an individual to strike but leaves him free to decide for himself in the particular circumstances of his case what is the proper course of action.'

"The Guardian's secretary replied on his behalf in a letter dated July 11, 1956: 'As regard strikes, the Guardian feels that your own understanding of the matter as expressed in your letter is quite correct, and he does not see the necessity of adding anything to it. We should avoid becoming rigid and laying down any more rules and regulations of conduct.'

"Based on the above guidelines, we are to emphasize the following points. 1. A Baha'i can become a member of a trade union as long as he is not required to also join a political party. 2. Abdu'l-Baha in general disapproved of strikes. The Baha'i attitude is that when the law recognizes strikes as legal, as when called by a properly constituted authority such as a trade union, the Baha'i teaching neither requires nor forbids an individual to participate in the strike but leaves him free to decide for himself what is the proper course of action in the particular circumstances."



7. These were the two chief strikes from which came the epidemic of demands and strikes throughout the country. None of these ebullitions proved of much moment. A rash had broken out upon the body politic, but it was only skin-deep, and disappeared as rapidly as it had come. At a somewhat later date the disturbance took a different form. A demand was made that the hours of labor should be reduced from ten to eight hours a day. To state this demand is to pronounce its fate. Existing conditions are not changed by twenty-per cent leaps and bounds, and especially in times like these, when business is not even moderately profitable. Such a request simply meant that many employers of labor would not be able to keep their men at work at all. History proves, nevertheless, that the hours of labor are being gradually reduced. The percentage of men working from ten to eleven hours in this country in 1830 was 29.7. These ten-hour workers increased in 1880 to 59.6 per cent of the whole; while the classes who in 1830 worked excessive hours - from twelve to thirteen - constituted 32.5 per cent. In 1880 they were only 14.6 per cent; while the number of men compelled to

**counsel** - The Master advises the members to "take counsel together in such wise that no occasion for ill-feeling or discord may arise". He affirms that: This can be attained when every member expresseth with absolute freedom his own opinion and setteth forth his argument. Should any one oppose, he must on no account feel hurt for not until matters are fully discussed can the right way be revealed. The shining spark of truth cometh forth only after the clash of differing opinions.... (p. 21)

It is important to note that truth emerges after the "clash" of carefully articulated views (which may well be expressed with enthusiasm and vigour), not from the clash of feelings. A clash of feelings is likely to obscure the truth, while a difference of opinion facilitates the discovery of truth.

'Abdu'l-Baha provides the following advice concerning the manner in which views should be expressed in the course of consultation. It is suggested that this guidance could also pertain to the expression of feelings:

They must then proceed with the utmost devotion, courtesy, dignity, care and moderation to express their views. They must in every matter search out the truth and not insist upon their own opinion, for stubbornness and persistence in one's views will lead ultimately to discord and wrangling and the truth will remain hidden... (Community Functioning, page 6)

work between thirteen and fourteen hours, which was in 1830 13.5 per cent, had fallen in 1880 to 2.3 per cent. Those working twelve hours are generally employed in double shifts, night and day. I do not believe that we have reached the limit of this reduction, but I do believe that any permanent reduction will be secured only by the half-hour at a time. If labor be guided by wise counsel, it will ask for reductions of half-hours, and then wait until a reduction to this extent is firmly established, and surrounding circumstances have adjusted themselves to that.

--- Page 113. The Gospel of Wealth - VI Results of the Labor Struggle

8. In considering the reasonableness of the demand for fewer hours of labor, we must not lose sight of the fact that the American works more hours, on an average, than his fellow in Great Britain. Twenty-three trades in Massachusetts are reported as working sixty hours and seventeen minutes a week, on the average, while the same crafts in Great Britain work only fifty-three hours and fifty minutes, showing that the American works an hour a day longer than his English brother. In

**Management** - Then rules and laws should be established to regulate the excessive fortunes of certain private individuals and meet the needs of millions of the poor masses; thus a certain moderation would be obtained. However, absolute equality is just as impossible, for absolute equality in fortunes, honors, commerce, agriculture, industry would end in disorderliness, in chaos, in disorganization of the means of existence, and in universal disappointment: the order of the community would be quite destroyed. Thus difficulties will also arise when unjustified equality is imposed. It is, therefore, preferable for moderation to be established by means of laws and regulations to hinder the constitution of the excessive fortunes of certain individuals, and to protect the essential needs of the masses. For instance, the manufacturers and the industrialists heap up a treasure each day, and the poor artisans do not gain their daily sustenance: that is the height of iniquity, and no just man can accept it. Therefore, laws and regulations should be established which would permit the workmen to receive from the factory owner their wages and a share in the fourth or the fifth part of the profits, according to the capacity of the factory; or in some other way the body of workmen and the manufacturers should share equitably the profits

British textile factories, the number of working hours in a week ranges from fifty-four to fifty-six. In mines, foundries, and machine-shops, fifty-four hours make a week's work, which is equivalent to nine hours a day, six days a week; but the men, in all cases, work enough overtime each day to insure them a half-holiday on Saturday. In some districts, notably in Glasgow, the men prefer to work two weeks, and make every other Saturday a whole holiday. This gives them an opportunity to leave on early morning trains, on excursions, and to spend Saturday and Sunday with friends. The Allegheny Valley Railroad Company, under the management of my friend Mr. McCargo, introduced the half-Saturday holiday in the shops some time ago, with the happiest results. Mr. McCargo found, by years of experience, that working-men lose about half a day a week. Since the half-holiday was established no more time has been lost than before. The men work five and one half days a week regularly. While they are not paid, of course, for the half-holiday, they could not be induced to give it up. This example should be followed, not only by all the railroads of the country, but by every employer of labor, and should be supported by every man

and advantages. Indeed, the capital and management come from the owner of the factory, and the work and labor, from the body of the workmen. Either the workmen should receive wages which assure them an adequate support and, when they cease work, becoming feeble or helpless, they should have sufficient benefits from the income of the industry; or the wages should be high enough to satisfy the workmen with the amount they receive so that they may themselves be able to put a little aside for days of want and helplessness. (Abdu'l-Bahá, SAQ, Page 274-275)

who seeks to improve the condition of the wage-receiving classes.

9. I venture to suggest to the representatives of labor, however, that before they demand any reduction upon ten hours per day, they should concentrate their efforts upon making ten hours the universal practice, and secure this. At present, every ton of pig-iron made in the world, except at two estab-

--- Page 114. The Gospel of Wealth - VI Results of the Labor Struggle

lishments, is made by men working in double shifts of twelve hours each, having neither Sunday nor holiday the year round. Every two weeks the day men change to the night shift by working twenty-four hours consecutively. Gas-works, paper-mills, flour-mills, and many other industries, are run by twelve-hour shifts, and breweries exact fifteen hours a day, on an average, from their men. I hold that it is not possible for men working ten hours a day to enlist public sentiment on their side in a demand for the shortening of their task, as long as many of their fellows are compelled to work twelve or more hours a

Labor - One of Baha'u'llah's teachings is the adjustment of means of livelihood in human society. Under this adjustment there can be no extremes in human conditions as regards wealth and sustenance. For the community needs financier, farmer, merchant and laborer just as an army must be composed of commander, officers and privates. All cannot be commanders; all cannot be officers or privates. Each in his station in the social fabric must be competent--each in his function according to ability but with justness of opportunity for all. (Abdu'l-Bahá, Promulgation of Universal Peace, page 216)

day.

10. The eight-hour movement is not, however, without substantial foundation. Works that run day and night should be operated with three sets of men, each working eight hours. The steel-rail mills in this country are generally so run. The additional cost of the three sets of men has been divided between the workmen and the employers, the latter apparently having to meet an advance of wages to the extent of 16-2/3 per cent, but against this is to be placed the increased product which can be obtained. This is not inconsiderable, especially during the hot months, for it has been found that men working twelve hours a day continuously cannot produce as much per hour as men working eight hours a day; so that, if there be any profit at all in the business, the employer derives some advantage from the greater productive capacity of his works and capital, while the general expenses of the establishment remain practically as they were before. Since electric lighting has been perfected, many establishments which previously could not be run at night can be run with success. I therefore look for a large

productive - Not surprisingly, therefore, there is increasing recognition that the world is in urgent need of a new "work ethic". Here again, nothing less than insights generated by the creative interaction of the scientific and religious systems of knowledge can produce so fundamental a reorientation of habits and attitudes. Unlike animals, which depend for their sustenance on whatever the environment readily affords, human beings are impelled to express the immense capacities latent within them through productive work designed to meet their own needs and those of others. In acting thus they become participants, at however modest a level, in the processes of the advancement of civilization. They fulfill purposes that unite them with others. To the extent that work is consciously undertaken in a spirit of service to humanity, Baha'u'llah says, it is a form of prayer, a means of worshiping God. Every individual has the capacity to see himself or herself in this light, and it is to this inalienable capacity of the self that development strategy must appeal, whatever the nature of the plans being pursued, whatever the rewards they promise. No narrower a perspective will ever call up from the people of the world the magnitude of effort and commitment that the economic tasks ahead will require.

A challenge of similar nature faces economic thinking as a result of the environmental crisis. The fallacies in theories based on the belief that there is no limit to nature's capacity to fulfill any demand made on it by human beings have now been coldly exposed. A culture which attaches absolute value to expansion, to acquisition, and to the satisfaction of people's wants is being compelled to recognize that such goals are not, by themselves, realistic guides to policy. Inadequate, too, are approaches to economic issues whose decision-making tools cannot deal with the fact that most of the major challenges are global rather than particular in scope. (Prosperity of Humankind, page 12)

increase in the number of establishments working men only eight hours, but employing the machinery that now runs only ten hours the entire twenty-four. Each shift, of course, takes turn of each of the three parts into which the twenty-four hours are divided, and thus the lives of the men are rendered

--- Page 115. The Gospel of Wealth - VI Results of the Labor Struggle

less monotonous and many hours for recreation and self-improvement are obtained.

11. The literature called forth by the recent excitement is preponderatingly favorable to cooperation, or profit-sharing, as the only true remedy for all disputes between labor and capital. My April article has been criticized because it relegated that to the future. But the advocates of this plan should weigh well the fact that the majority of enterprises are not profitable; that most men who embark in business fail--indeed, it is stated that only five in every hundred succeed, and that, with the exception of a few wealthy and partially retired manufacturers, and a very few wealthy corporations, men engaged in business affairs are in the midst of an

**profit-sharing** - It is by friendly consultation and cooperation, by just copartnership and profit-sharing, that the interests of both capital and labor will be best served. The harsh weapons of the strike and lockout are injurious, not only to the trades immediately affected, but to the community as a whole. It is, therefore, the business of the governments to devise means for preventing recourse to such barbarous methods of settling disputes. 'Abdu'l-Baha said at Dublin, New Hampshire, in 1912:-- Now I want to tell you about the law of God. According to the divine law, employees should not be paid merely by wages. Nay, rather they should be partners in every work. The question of socialization is very difficult. It will not be solved by strikes for wages. All the governments of the world must be united, and organize an assembly, the members of which shall be elected from the parliaments and the noble ones of the nations. These must plan with wisdom and power, so that neither the capitalists suffer enormous losses, nor the laborers become needy. In the utmost moderation they should make the law, then announce to the public that the rights of the working people are to be effectively preserved; also the rights of the capitalists are to be protected. When such a general law is adopted, by the will of both sides, should a strike occur, all the governments of the world should collectively resist it. Otherwise the work will lead to much destruction, especially in Europe. Terrible things will take place. (Bahá'u'lláh & New Era, page 145)

anxious and increasing struggle to keep their heads above water. How to pay maturing obligations, how to obtain cash for the payment of their men, how to procure orders or how to sell product, and, in not a few instances, how to induce their creditors to be forbearing, are the problems which tax the minds of business men during the dark hours of night, when their employees are asleep. I attach less and less value to the teaching of those doctrinaires who sit in their cozy studies and spin theories concerning the relations between capital and labor, and set before us divers high ideals. The banquet to which they invite the working-man when they propose industrial cooperation is not yet quite prepared, and would prove to most of those who accepted the invitation a Barmecide feast. Taken as a whole, the condition of labor to-day would not be benefited, but positively injured, by cooperation.

12. Let me point out, however, to the advocates of profit-sharing that ample opportunity already exists for workingmen to become part-owners in almost any department of industrialism, without changing present relations. The great railway corporations, in all cases, as well as the great manufacturing companies generally, are stock concerns, with

--- Page 116. The Gospel of Wealth - VI Results of the Labor Struggle

shares of fifty or a hundred dollars each, which are bought and sold daily in the market. Not an employee of any of these but can buy any number of shares, and thus participate in the dividends and in the management. That capital is a unit is a popular error. On the contrary, it is made up of hundreds and thousands of small component parts, owned, for the most part, by people of limited means. The Pennsylvania Railway proper, for instance, which embraces only the 350 miles of line between Pittsburg and Philadelphia, is today owned by 19,340 shareholders, in lots of from one fifty-dollar share upward. The New York Central Railway, of 450 miles,

**industrialism** - The greatest bestowal of God to man is the capacity to attain human virtues. Therefore, the teachings of religion must be reformed and renewed because past teachings are not suitable for the present time. For example, the sciences of bygone centuries are not adequate for the present because sciences have undergone reform. The industrialism of the past will not ensure present efficiency because industrialism has advanced. The laws of the past are being superseded because they are not applicable to this time. All material conditions pertaining to the world of humanity have undergone reform, have achieved development, and the institutes of the past are not to be compared with those of this age. ('Abdu'l-Baha: Promulgation of Universal Peace, page 378)



between New York and Buffalo, belongs not to one, or two, or several capitalists, but to 10,418 shareholders, of whom about one third are women and executors of estates. The entire railway system of America will show a similar wide distribution of ownership among the People. There are but three railway corporations in which the great capitalists hold a considerable interest; and the interest in two of these is held by various members of a family, and in no case does it amount to the control of the whole. In one of these very cases, the New York Central, as we have seen, there are more than ten thousand owners.

13. Steel-rail mills, with only one exception, show a like state of affairs. One of them belongs to 215 shareholders; of whom 7 are employees, 32 are estates, and 57 are women. Another of these concerns is owned by 302 stockholders; of whom 101 are women, 29 are estates, representing an unknown number of individuals, and 20 are employees of the company. A large proportion of the remaining owners are small holders of comparatively limited means, who have, from time to time, invested

**trustees** - Since the body of humankind is one and indivisible, each member of the race is born into the world as a trust of the whole. This trusteeship constitutes the moral foundation of most of the other rights -- principally economic and social -- which the instruments of the United Nations are attempting similarly to define. The security of the family and the home, the ownership of property, and the right to privacy are all implied in such a trusteeship. The obligations on the part of the community extend to the provision of employment, mental and physical health care, social security, fair wages, rest and recreation, and a host of other reasonable expectations on the part of the individual members of society.

The principle of collective trusteeship creates also the right of every person to expect that those cultural conditions essential to his or her identity enjoy the protection of national and international law. Much like the role played by the gene pool in the biological life of humankind and its environment, the immense wealth of cultural diversity achieved over thousands of years is vital to the social and economic development of a human race experiencing its collective coming-of-age. It represents a heritage that must be permitted to bear its fruit in a global civilization. On the one hand, cultural expressions

their savings where they had confidence both as to certainty of income and safety of principal. The Merrimac Manufacturing Company (cotton), of Lowell, is owned by 2500 shareholders, of whom forty-two per cent are holders of one share, twenty-one per cent of two, and ten per cent of three shares. Twenty-seven per cent are holders

--- Page 117. The Gospel of Wealth - VI Results of the Labor Struggle

of over three shares; and not less than thirty-eight per cent. of the whole stock is held by trustees, guardians, and executors of charitable, religious, educational, and financial institutions.

14. I have obtained from other concerns similar statements, which need not be published. They prove without exception that from one fourth to one third of the number of shareholders in corporations are women and executors of estates. The number of shareholders I have given are those of record, each holding a separate certificate. But it is obvious, in the case of executors, that this one certificate may represent a

need to be protected from suffocation by the materialistic influences currently holding sway. On the other, cultures must be enabled to interact with one another in ever-changing patterns of civilization, free of manipulation for partisan political ends.

"The light of men", Baha'u'llah says, "is Justice. Quench it not with the contrary winds of oppression and tyranny. The purpose of justice is the appearance of unity among men. The ocean of divine wisdom surgeth within this exalted word, while the books of the world cannot contain its inner significance." (Prosperity of Mankind, Page 6&7)

**capitalist** - The question of socialization is very important. It will not be solved by strikes for wages. All the governments of the world must be united and organize an assembly the members of which should be elected from the parliaments and the nobles of the nations. These must plan with utmost wisdom and power so that neither the capitalist suffer from enormous losses nor the laborers become needy. In the utmost moderation they should make the law; then announce to the public that the rights of the working people are to be strongly preserved. Also the rights of the capitalists are to be protected. When such a general plan is adopted by the will of both sides, should a strike occur, all the governments of the world collectively should resist it. Otherwise, the labor problem will lead to much destruction, especially in Europe. Terrible things will take place.

For instance, the owners of properties, mines and factories should share their incomes with their employees and give a fairly certain percentage of their products to their workingmen in order that the

dozen owners. Many certificates issued in the name of a firm represent several persons, while shares held by a corporation may represent hundreds; but if we assume that every certificate of stock issued by the Pennsylvania Railroad Company represents only two owners, which is absurdly under the truth, it follows that, should every employee of that great company quarrel with it, the contest would be not against a few, but against a much larger body than they themselves constitute. It is within the mark to say that every striking employee would oppose his personal interest against that of three or four other members of the community. The total number of men employed by the Pennsylvania Railroad Company is 18,911 -- not as many as there are shareholders of record. and what is true of the Pennsylvania Railway Company is true of the railway system as a whole, and, in a greater or less degree, of mining and manufacturing corporations generally. When one, therefore, denounces great corporations for unfair treatment of their men, he is not denouncing the act of some monster capitalist, but that of hundreds and thousands of small holders,

employees may receive, beside their wages, some of the general income of the factory so that the employee may strive with his soul in the work. (Foundations of World Unity, Page 43)

It is, then, clear and evident that the repartition of excessive fortunes among a small number of individuals, while the masses are in need, is an iniquity and an injustice. In the same way, absolute equality would be an obstacle to life, to welfare, to order and to the peace of humanity. In such a question moderation is preferable. It lies in the capitalists' being moderate in the acquisition of their profits, and in their having a consideration for the welfare of the poor and needy-- that is to say, that the workmen and artisans receive a fixed and established daily wage-- and have a share in the general profits of the factory. (Abdu'l-Bahá, Some Answered Questions, page 275)

scarcely one of whom would be a party to unfair or illiberal treatment of the working-man; the majority of them, indeed, would be found on his side; and, as we have seen, many of the owners themselves would be working-men. Labor has only to bring its just grievances to the attention of owners to secure fair and liberal treatment.

--- Page 118. The Gospel of Wealth - VI Results of the Labor Struggle

The "great capitalist" is almost a myth, and exists, in any considerable number or degree, only in the heated imagination of the uninformed. Aggregate capital in railway corporations consists of many more individuals than it employs.

15. Following the labor disturbances, there came the mad work of a handful of foreign anarchists in Chicago and Milwaukee,

*(4) Though Carnegie may have been unruffled, he was not necessarily able to make fine distinctions. The eight-hour movement of May, 1886, aroused labor enthusiasm in Chicago and Milwaukee and became entangled with an existing labor dispute. In Milwaukee Paul Grottkau, who had once been in Chicago and associated with some of its apostles of violence, edited the*

**anarchists** - Extreme pacifists are thus very close to the anarchists, in the sense that both of these groups lay an undue emphasis on the rights and merits of the individual. The Baha'i conception of social life is essentially based on the subordination of the individual will to that of society. It neither suppresses the individual nor does it exalt him to the point of making him an anti-social creature, a menace to society. As in everything, it follows the "golden mean." The only way that society can function is for the minority to follow the will of the majority. (Unfolding Destiny, Page 435-436)

*Arbeiter Zeitung, played a role in the Central Labor Union, and had great influence with foreign-born workers, for he had once been expelled from Germany under its anti-socialist laws. But Grottkau now advocated conventional labor union tactics; he was more socialist than anarchist. The eight-hour drive in Milwaukee, involving "some lawlessness and riotous proceedings" and considerable excitement, had led to brushes with police and the militia. The latter on May 5th, breaking up an attack on the North Chicago Rolling Mills, fired on the crowd. Subsequently, Grottkau and thirty-six others were arrested. Many were convicted and punished with fines or short jail terms. Grottkau went free on a technicality.*

who thought they saw in the excitement a fitting opportunity to execute their revolutionary plans. Although labor is not justly chargeable with their doings, nevertheless the cause of labor was temporarily discredited in public opinion by these outbreaks. The promptitude with which one labor organization after another not only disclaimed all sympathy with riot and disorder, but volunteered to enroll itself into armed force for the maintenance of order, should not be overlooked by the student of labor problems desirous of looking justly at the question from the laborer's point of view. It is another convincing proof, if further proof were necessary, that whenever the peace of this country is seriously

threatened, the masses of men, not only in the professions and in the educated classes, but down to and through the very lowest ranks of industrious workers, are determined to maintain it. A survey of the field, now that peace is restored, gives the results as follows:

16. *First.* The "dead line" has been definitely fixed between

--- Page 119. The Gospel of Wealth - VI Results of the Labor Struggle

the forces of disorder and anarchy and those of order. Bomb-throwing means swift death to the thrower. Rioters assembling in numbers and marching to pillage will be remorselessly shot down; not by the order of a government above the people, not by overwhelming standing armies, not by troops brought from a distance, but by the masses of peaceable and orderly citizens of all classes in their own community, from the capitalist down to and including the steady workingman, whose combined influence constitutes that irresistible force, under democratic institutions, known as public sentiment. That sentiment has not only supported the officials who

**anarchy** - There can be no doubt that the decline of religion as a social force, of which the deterioration of religious institutions is but an external phenomenon, is chiefly responsible for so grave, so conspicuous an evil. "Religion," writes Baha'u'llah, "is the greatest of all means for the establishment of order in the world and for the peaceful contentment of all that dwell therein. The weakening of the pillars of religion hath strengthened the hands of the ignorant and made them bold and arrogant.

Verily I say, whatsoever hath lowered the lofty station of religion hath increased the waywardness of the wicked, and the result cannot be but anarchy." "Religion," He, in another Tablet, has stated, "is a radiant light and an impregnable stronghold for the protection and welfare of the peoples of the world, for the fear of God impelleth man to hold fast to that which is good, and shun all evil. Should the lamp of religion be obscured, chaos and confusion will ensue, and the lights of fairness, of justice, of tranquillity and peace cease to shine." "Know thou," He, in yet another connection, has written, "that they who are truly wise have likened the world unto the human temple. As the body of man needeth a garment to clothe it, so the body of mankind must needs be adorned with the mantle of justice and wisdom. Its robe is the Revelation vouchsafed unto it by God." (World Order of Bahá'u'lláh, pages 186-187)

shot down disturbers of the peace, but has extolled them in proportion to the promptitude of their action.

17. *Second.* Another proof of the indestructibility of human society, and of its determination and power to protect itself from every danger as it arises and to keep marching forward to higher states of development, has been given in Judge Mallory's words: "Every person who counsels, hires, procures, or incites others to the commission of any unlawful or criminal act, is equally guilty with those who actually perpetrate the act, though such person may not have been present at the time of the commission of the offense.

*(5) Judge James A. Mallory of Milwaukee had been prominent during the eighties in a fusion movement or Citizens' ticket to unite Democrats and Republicans against a labor party, the program of which advocated enlarged municipal services. In 1888 fusion defeated the labor effort by a narrow majority. Mallory also presided over the grand jury hearing that handed up indictments for "inciting to riot" in the Milwaukee eight-hour day excitement. Carnegie quotes from his charge to the jury. Mallory did not preside over the trials because "affidavits of prejudice" were filed against him.*

The difference between liberty

**liberty** - It is this distinguishing impulse of human consciousness that provides the moral imperative for the enunciation of many of the rights enshrined in the Universal Declaration and the related Covenants. Universal education, freedom of movement, access to information, and the opportunity to participate in political life are all aspects of its operation that require explicit guarantee by the international community. The same is true of freedom of thought and belief, including religious liberty, along with the right to hold opinions and express these opinions appropriately. Since the body of humankind is one and indivisible, each member of the race is born into the world as a trust of the whole. This trusteeship constitutes the moral foundation of most of the other rights -- principally economic and social -- which the instruments of the United Nations are attempting similarly to define. The security of the family and the home, the ownership of property, and the right to privacy are all implied in such a trusteeship. The obligations on the part of the community extend to the provision of employment, mental and physical health care, social security, fair wages, rest and recreation, and a host of other reasonable expectations on the part of the individual members of society. (Prosperity of Humankind, page 6)

and license of speech is now clearly defined - a great gain.

18. *Third.* It has likewise been clearly shown that public sentiment sympathizes with the efforts of labor to obtain from capital a fuller recognition of its position and claims than has hitherto been accorded. And in this expression, "a fuller recognition," I include not only pecuniary compensation, but what I conceive to be even more important to-day - a greater

--- Page 120. The Gospel of Wealth - VI Results of the Labor Struggle

consideration of the working-man as a man and a brother. I trust the time has gone by when corporations can hope to work men fifteen or sixteen hours a day. and the time approaches, I hope, when it will be impossible, in this country, to work men twelve hours a day continuously.

**sentiment** - High aims and pure motives, however laudable in themselves, will surely not suffice if unsupported by measures that are practicable and methods that are sound. Wealth of sentiment, abundance of good-will and effort, will prove of little avail if we should fail to exercise discrimination and restraint and neglect to direct their flow along the most profitable channels. The unfettered freedom of the individual should be tempered with mutual consultation and sacrifice, and the spirit of initiative and enterprise should be reinforced by a deeper realization of the supreme necessity for concerted action and a fuller devotion to the common weal. (Bahá'i Administration, page 12)



19. *Fourth.* While public sentiment has rightly and unmistakably condemned violence, even in the form for which there is the most excuse, I would have the public give due consideration to the terrible temptation to which the working-man on a strike is sometimes subjected. To expect that one dependent upon his daily wage for the necessities of life will stand by peaceably and see a new man employed in his stead, is to expect much. This poor man may have a wife and children dependent upon his labor. Whether medicine for a sick child, or even nourishing food for a delicate wife, is procurable, depends upon his steady employment. In all but a very few departments of labor it is unnecessary, and, I think, improper, to subject men to such an ordeal. In the case of railways and a few other employments it is, of course, essential for the public wants that no interruption occur, and in such case substitutes must be employed; but the employer of labor will find it much more to his interest, wherever possible, to allow his works to remain idle and await the result of a dispute, than to employ the class of men that can be inclined to take the place of other men who have stopped work. Neither the

**workmen** - The court of justice and the government have, therefore, the right of interference. When a difficulty occurs between two individuals with reference to private rights, it is necessary for a third to settle the question. This is the part of the government. Then the problem of strikes-- which cause troubles in the country and are often connected with the excessive vexations of the workmen, as well as with the rapacity of manufacturers--how could it remain neglected? Good God! Is it possible that, seeing one of his fellow-creatures starving, destitute of everything, a man can rest and live comfortably in his luxurious mansion? He who meets another in the greatest misery, can he enjoy his fortune? That is why, in the Religion of God, it is prescribed and established that wealthy men each year give over a certain part of their fortune for the maintenance of the poor and unfortunate. That is the foundation of the Religion of God and is binding upon all.

And as man in this way is not forced nor obliged by the government, but is by the natural tendency of his good heart voluntarily and radiantly showing benevolence toward the poor, such a deed is much praised, approved and pleasing.

Such is the meaning of the good works in the Divine Books and Tablets. (‘Abdu'l-Bahá, *Some Answered Questions*, pages 276-277)

best men as men, nor the best men as workers, are thus to be obtained. There is an unwritten law among the best workmen: "Thou shalt not take thy neighbor's job." No wise employer will lightly lose his old employees. Length of service counts for much in many ways. Calling upon strange men should be the last resort.

20. *Fifth.* The results of the recent disturbances have given indubitable proof that trades-unions must, in their very nature, become more conservative than the mass of the men they represent. If they fail to be conservative, they go to pieces through their own extravagance. I know of three

--- Page 121. The Gospel of Wealth - VI Results of the Labor Struggle

instances in which threatened strikes were recently averted by the decision of the Master Workman of the Knights of Labor, supported by the best workmen, against the wishes of the less intelligent members of that organization. Representative institutions eventually bring to the front the ablest and most prudent men, and will be found as beneficial in the industrial as

**industrial** - The oneness of mankind... implies an organic change in the structure of present-day society, a change such as the world has not yet experienced.... It calls for no less than the reconstruction and the demilitarization of the whole civilized world--a world organically unified in all the essential aspects of its life, its political machinery, its spiritual aspiration, its trade and finance, its script and language, and yet infinite in the diversity of the national characteristics of its federated units.

It represents the consummation of human evolution... and... carries with it no more and no less than a solemn assertion that attainment to this final stage in this stupendous evolution is not only necessary but inevitable, that its realization is fast approaching, and that nothing short of a power that is born of God can succeed in establishing it.

Baha'i Scriptures maintain that adherence to the principle of the oneness of humanity will have a direct and enduring impact on man's spiritual, social and physical environments. Universal acceptance of this principle will entail a major restructuring of the world's educational, social, agricultural, industrial, economic, legal and political systems. This restructuring will facilitate the emergence of a sustainable, just and prosperous world civilization. Ultimately only a spiritually based civilization--in which science and religion work in harmony--will be able to preserve the ecological balance of the earth, foster stability in human population, and advance both the material and the spiritual well-being of all peoples and nations. (Shoghi Effendi, World Order of Bahá'u'lláh, pages 42-43)

they have proved themselves to be in the political world. Leaders of the stamp of Mr. Powderly, Mr. Arthur, of the Brotherhood of Locomotive Engineers, and Messrs. Wihle and Martin, of the Amalgamated Iron and Steel Association, will gain and retain power; while such as the radical and impulsive Mr. Irons,

*(6) Powderly became Grand Master Workman of the Knights of Labor in 1879 and served until 1893. Under his leadership the Knights grew to be the country's largest labor organization in 1886 and then declined into a local, agrarian organization. Powderly induced the Knights to discard their religious and secret features. Like most Knights, he was the foe of strikes. P. M. Arthur (1831-1903), originally an immigrant from Scotland and after 1874 Grand Chief of the Brotherhood of Locomotive Engineers, incurred a discharge of epithets and abuse from organized labor's opponents for his part in the railroad strikes of 1877; later employers and capitalists came to regard both the union and its leader as "conservative," an opinion concurred in by radicals in the labor movement. William Martin, during the eighties Secretary of the Amalgamated Association of Iron and Steel Workers, had been born in Scotland. For Wihle (really Weihe) see Essay V, note 5; on Irons, note 3 above.*

if at first clothed with power,  
will soon lose it.

21. Thus, as the result of the recent revolt, we see advantages gained by both capital and labor. Capital is more secure because of what has been demonstrated, and labor will hereafter be more respectfully treated and its claims more carefully considered, in deference to an awakened public opinion in favor of the laborer. Labor won while it was reasonable in its demands and kept the peace; it lost when it asked what public sentiment pronounced unreasonable, and especially when it broke the peace.

Public opinion must be directed toward whatever is worthy of this day, and this is impossible except through the use of adequate arguments and the adducing of clear, comprehensive and conclusive proofs. For the helpless masses know nothing of the world, and while there is no doubt that they seek and long for their own happiness, yet ignorance like a heavy veil shuts them away from it. (Secret of Divine Civilization, page110)

22. The disturbance is over and peace again reigns; but let no one be unduly alarmed at frequent disputes between capital and labor. Kept within legal limits, they are encouraging symptoms, for they betoken the desire of the working-man

--- Page 122. The Gospel of Wealth - VI Results of the Labor Struggle

to better his condition; and upon this desire hang all hopes of advancement of the masses. It is the stagnant pool of Contentment, not the running stream of Ambition, that breeds disease in the

### Sustainable Development - No Industrial Slavery

In the Book of Aqdas Baha'u'llah forbids slavery, and 'Abdu'l-Baha has explained that not only chattel slavery, but also industrial slavery, is contrary to the law of God. When in the United States in 1912, He said to the American people:-- Between 1860 and 1865 you did a wonderful thing; you abolished chattel slavery; but today you must do a much more wonderful thing: you must abolish industrial slavery....

The solution of economic questions will not be brought about by array of capital against labor, and labor against capital, in strife and conflict, but by the voluntary attitude of goodwill on both sides. Then a real and lasting justness of conditions will be secured....

Among the Baha'is there are no extortionate, mercenary and unjust practices, no rebellious demands, no revolutionary uprisings against existing governments....

It will not be possible in the future for men to amass great fortunes by the labors of others. The rich will willingly divide. They will come to this gradually, naturally, by their own volition. It will never be accomplished by war and bloodshed.

body social and political. The workingmen of this country can no more be induced to sanction riot and disorder than can any other class of the community. Isolated cases of violence under strong provocation may break out upon the surface, but the body underneath is sound to the core, and resolute for the maintenance of order.

It is by friendly consultation and cooperation, by just copartnership and profit-sharing, that the interests of both capital and labor will be best served. The harsh weapons of the strike and lockout are injurious, not only to the trades immediately affected, but to the community as a whole. It is, therefore, the business of the governments to devise means for preventing recourse to such barbarous methods of settling disputes. 'Abdu'l-Baha said at Dublin, New Hampshire, in 1912:-- (Bahá'u'lláh and the New Era, pages 144-145)

23. For the first time within my knowledge, the leading organs of public opinion in England have shown a more correct appreciation of the forces at work in the Republic than some of our own despondent writers. The London "Daily News" said truly that "the territorial democracy of America can be trusted to deal with such outbreaks"; and the "Daily Telegraph" spoke as follows:

There is no need for any fear to be entertained lest the lawbreakers of Chicago should get the better of the police, and, if it be necessary to invoke their aid, of the citizens of that astonishing young city. Frankly speaking, such rioters would have a better chance of intimidating Birmingham than of overawing

**Universal Peace** - Today there is no greater glory for man than that of service in the cause of the "Most Great Peace". Peace is light whereas war is darkness. Peace is life; war is death. Peace is guidance; war is error. Peace is the foundation of God; war is satanic institution. Peace is the illumination of the world of humanity; war is the destroyer of human foundations. When we consider outcomes in the world of existence we find that peace and fellowship are factors of upbuilding and betterment whereas war and strife are the causes of destruction and disintegration. All created things are expressions of the affinity and cohesion of elementary substances, and non-existence is the absence of their attraction and agreement. Various elements unite harmoniously in composition but when these elements become discordant, repelling each other, decomposition and non-existence result. Everything partakes of this nature and is subject to this principle, for the creative foundation in all its degrees and kingdoms is an expression or outcome of love. Consider the restlessness and agitation of the human world today because of war. Peace is health and construction; war is disease and dissolution. When the banner of truth is raised, peace becomes the cause of the welfare and advancement of the human world. In all cycles and ages war has been a factor of derangement and discomfort whereas peace and brother-hood have brought security and consideration of human interests. This distinction is especially pronounced in the present world conditions, for warfare in former centuries had not attained the degree of savagery and destructiveness which now characterizes it. If two nations were at war in olden times, ten or twenty thousand would be sacrificed but in this century the destruction of one hundred thousand lives in a day is quite possible. So perfected has the science of killing become and so efficient the means and instruments of its accomplishment that a whole nation can be obliterated in a short time. Therefore comparison with the methods and results of ancient warfare is out of the question. (Abdu'l-Bahá, Foundations of World Unity, Page 20)

Chicago, St. Louis, or New York. In dealing with the insurgents of this class the record of the great Republic is singularly clear.

Not only the democracy, but the industrious working-men of which the democracy is so largely composed, have amply fulfilled the flattering predictions of our English friends, and may safely be trusted in the future to stand firmly for the maintenance of peace.

**MENU:** [HOME](#) » [Reconstruction](#) » [Gospel Content](#) » [Gospel Purpose](#)

# The Gospel of Wealth

And Other Timely Essays

by Andrew Carnegie

**In the right-hand commentary column,  
that which is in GREEN is a commentator's remark and  
that which is in BLUE is from the Baha'i Writings.  
On occasion, in that column, there may be a [link](#) to an extended comment or  
dissertation on the subject under discussion.**

- -

***A reminder that under "view" on your browser - you can set the text size UP  
or DOWN for a more comfortable read for yourself.***

--- Page 123. The Gospel of Wealth - VII Distant Possessions: The Parting of the Ways

## VII

### **Distant Possessions: The Parting of the Ways**

*(1) From the North American Review, CLXVII (August 1898), 239-248.*

1. TWICE only have the American people been called upon to decide a question of such vital import as that now before them.

[Baha'i Comment](#)

2. Is the Republic, the apostle of Triumphant Democracy, of the rule of the people, to abandon her political creed and endeavor to establish in other lands the rule of the foreigner over the people, Triumphant Despotism?

[Baha'i Comment](#)

3. Is the Republic to remain one homogeneous whole, one united people, or to become a scattered and disjointed aggregate of widely separated and alien races?

[Baha'i Comment](#)

4. Is she to continue the task of developing her vast continent until it holds a population as great as that of Europe, all Americans, or to abandon that destiny to annex, and to attempt to govern, other far distant parts of the world as outlying possessions, which can never be integral parts of the Republic?

[Baha'i Comment](#)

5. Is she to exchange internal growth and advancement for the development of external possessions which can never be really hers in any fuller sense than India is British or Cochin China French? Such is the portentous question of the day. TWO equally important questions the American people have decided wisely, and their flag now waves over the greater portion of the English-speaking race; their country is the richest of all countries, first in manufactures, in mining, and in commerce (home and foreign), first this year also in ex-

[Baha'i Comment](#)



## Wealth - VII Distant Possessions: The Parting of the Ways

ports. But, better than this, the average condition of its people in education and in living is the best. The luxuries of the masses in other lands are the necessities of life in ours. The school-house and the church are nowhere so widely distributed. Progress in the arts and sciences is surprising. In international affairs her influence grows so fast, and foreshadows so much, that one of the foremost statesmen has recently warned Europe that it must combine against her if it is to hold its own in the industrial world. The Republic remains one solid whole, its estate inclosed in a ring fence, united, impregnable, triumphant, clearly destined to become the foremost power of the world, if she continue to follow the true path. Such are the fruits of wise judgment in deciding the two great issues of the past, Independence and Union.

6. In considering the issue now before us, the agitator, the demagogue, has no part. Not feeling, not passion, but deliberate judgment alone, should have place. The question should be calmly weighed; it is not a matter of party, nor of class; for the fundamental interest of every citizen is a common interest, that which is best for the poorest being best for the richest. Let us, therefore, reason together, and be well assured, before we change our position, that we are making no plunge into an abyss. Happily, we have the experience of others to guide us, the most instructive being that of our own race in Great Britain.

[Baha'i Comment](#)

7. There are two kinds of national possessions, one colonies, the other dependencies. In the former we establish and reproduce our own race. Thus Britain has peopled Canada and Australia with English-speaking people, who have naturally adopted our ideas of self-government. That the world has benefited thereby goes without saying; that Britain has done a great work as the mother of nations is becoming more and more appreciated the more the student learns of world-wide affairs. No nation that ever

[Baha'i Comment](#)

existed has done so much for the progress of the world as the little islands in the North Sea known as Britain.

--- Page 125. The Gospel of Wealth - VII Distant Possessions: The Parting of the Ways

8. With dependencies it is otherwise. The most grievous burden which Britain has upon her shoulders is that of India, for there it is impossible for our race to grow. The child of English-speaking parents must be removed and reared in Britain. The British Indian official must have long respites in his native land. India means death to our race. The characteristic feature of a dependency is that the acquiring power cannot reproduce its own race there.

10. There was something to be said for colonies from the point of view of pecuniary gain in the olden days, when they were treated as the legitimate spoil of the conquerer. It is Spain's fatal mistake that she has never realized that it is impossible to follow this policy in our day. Britain is the only country which has realized this truth. British colonies have complete self-

[Baha'i Comment](#)

[Baha'i Comment](#)

government; they even tax the products of their own motherland. That Britain possesses her colonies is a mere figure of speech; that her colonies possess her is nearer the truth. "Our Colonial Empire" seems a big phrase, but, as far as material benefits are concerned, the balance is the other way. Thus, even loyal Canada trades more with us than with Britain. She buys her Union Jacks in New York. Trade does not follow the flag in our day; it scents the lowest price current. There is no patriotism in exchanges.

11. Some of the organs of manufacturing interests, we observe, favor foreign possessions as necessary or helpful markets for our products. But the exports of the United States this Year are greater than those of any other nation in the world.

--- Page 126. The Gospel of Wealth - VII Distant Possessions: The Parting of the Ways

Even Britain's exports are less, yet Britain possesses, it is said, a hundred colonies and dependencies scattered all over the world. The fact that the United States has none does not prevent her products and manufactures

[Baha'i Comment](#)

from invading Japan, China, Australia, New Zealand, Canada, and all parts of the world in competition with those of Britain. Possession of colonies or dependencies is not necessary for trade reasons. What her colonies are valued for, and justly so, by Britain, is the happiness and pride which the mother feels in her children. The instinct of motherhood is gratified, and no one living places a higher estimate upon the sentiment than I do. Britain is the kindest of mothers, and well deserves the devotion of her children.

12. If we could establish colonies of Americans, and grow Americans in any part of the world now unpopulated and unclaimed by any of the great powers, and thus follow the example of Britain, heart and mind might tell us that we should have to think twice, yea, thrice, before deciding adversely. Even then our decision should be adverse; but there is at present no such question before us. What we have to face is the question whether we should embark upon the difficult and dangerous policy of undertaking the government of alien races in lands where it is impossible for our own race to be produced.

[Baha'i Comment](#)

13. As long as we remain free from distant possessions we are impregnable against serious attack; yet, it is true, we have to consider what: obligations may fall upon us of an international character requiring us to send our forces to points beyond our own territory. Up to this time we have disclaimed all intention to interfere with affairs beyond our own continent, and only claimed the right to watch over American interests according to the Monroe Doctrine, which is now firmly established. This carries with it serious responsibilities, no doubt, which we cannot escape. European nations must consult us upon territorial questions pertaining to our continent, but this makes no tremendous demand upon our

--- Page 127. The Gospel of Wealth - VII Distant Possessions: The Parting of the Ways

military or naval forces. We are at home, as it were, near our base, and sure of the support of the power in whose behalf and on whose request we may act. If it be found essential to possess a coaling-station at Porto Rico for future possible, though not probable,

[Baha'i Comment](#)

contingencies, there is no insuperable objection. Neither would the control of the West Indies be alarming if pressed upon us by Britain, since the islands are small and the populations must remain insignificant and without national aspirations. Besides, they are upon our own shores, American in every sense. Their defense by us would be easy. No protest need be entered against such legitimate and peaceful expansion in our own hemisphere, should events work in that direction. I am no "Little" American, afraid of growth, either in population or territory, provided always that the new territory be American, and that it will produce Americans, and not foreign races bound in time to be false to the Republic in order to be true to themselves.

14. As I write, the cable announces the annexation of Hawaii,

*(2) Hawaii was officially annexed by the United States by Joint Resolution of Congress in 1898 and was administered as a Territory until it achieved statehood.*

which is more serious; but the argument for this has been the necessity for holding the only coaling-station in the Pacific so situated as to be

[Baha'i Comment](#)

essential to any power  
desirous of successfully  
attacking our Pacific coast.  
Until the Nicaragua Canal

*(3) Prior to the building of the  
Panama Canal a passage at  
Nicaragua was projected (as early  
as 1850), and various concessions  
were granted, but the United  
States preferred the present site.*

is made, it is impossible to  
deny the cogency of this  
contention. We need not  
consider it a measure of  
offense or aggression, but as  
strictly defensive. The  
population of the islands is so  
small that national aspirations  
are not to be encountered,  
which is a great matter. Nor is  
it obtained by conquest. It is  
ours by a vote of its people,  
which robs its acquisition of  
many dangers. Let us hope  
that our far-outlying  
possessions may end with  
Hawaii.

15. To reduce it to the  
concrete, the question is:  
Shall we

--- Page 128. The Gospel of  
Wealth - VII Distant  
Possessions: The Parting of  
the Ways

attempt to establish ourselves  
as a power in the far East and  
possess the Philippines for  
glory? The glory we already

[Baha'i Comment](#)



have, in Dewey's victory overcoming the power of Spain in a manner which adds one more to the many laurels of the American navy, which, from its infancy till now, has divided the laurels with Britain upon the sea. The Philippines have about seven and a half millions of people, composed of races bitterly hostile to one another, alien races, ignorant of our language and institutions. Americans cannot be grown there. The islands have been exploited for the benefit of Spain, against whom they have twice rebelled, like the Cubans. But even Spain has received little pecuniary benefit from them. The estimated revenue of the Philippines in 1894-95 was £2,715,980, the expenditure being £2,656,026, leaving a net result of about \$300,000. The United States could obtain even this trifling sum from the inhabitants only by oppressing them as Spain has done. But, if we take the Philippines, we shall be forced to govern them as generously as Britain governs her dependencies, which means that they will yield us nothing, and probably be a source of annual expense. Certainly they will be a grievous drain upon revenue if we consider the enormous army and navy which we shall be forced to maintain upon their account.

16. There are many objections to our undertaking the government of dependencies; one I venture to submit as being peculiar to ourselves. We should be placed in a wrong position. Consider Great Britain in India to-day. She has established schools and taught the people our language. In the Philippines, we may assume that we should do the same, and with similar results. To travel through India as an American is a point of great advantage if one wishes to know the people of India and their aspirations. They unfold to Americans their inmost thoughts, which they very naturally withhold from their masters, the British. When in India, I talked with many who had received an English education in the British schools, and found that they had read and

--- Page 129. The Gospel of Wealth - VII Distant Possessions: The Parting of the Ways

pondered most upon Cromwell and Hampden, Wallace and Bruce and Tell, upon Washington and Franklin. The Briton is sowing the seed of rebellion with one hand in his schools, - for education makes

[Baha'i Comment](#)

rebels, - while with the other he is oppressing patriots who desire the independence of their country. The national patriotism upon which a Briton plumes himself he must repress in India. It is only a matter of time when India, the so-called gem of the British crown, is to glitter red again. British control of India is rendered possible to-day only by the division of races, or rather of religions, there. The Hindus and Mohammedans still mistrust each other more than they do the British, but caste is rapidly passing away, and religious prejudices are softening. Whenever this distrust disappears, Britain is liable to be expelled, at a loss of life and treasure which cannot be computed. The aspirations of a people for independent existence are seldom repressed, nor, according to American ideas hitherto, should they be. If it be a noble aspiration for the Indian or the Cuban, as it was for the citizen of the United States himself, and for the various South American republics once under Spain, to have a country to live and, if necessary, to die for, why is not the revolt noble which the man of the Philippines has been making against Spain? Is it possible that the Republic is to be placed in the position of

the suppressor of the Philippine struggle for independence? Surely, that is impossible. With what face shall we hang in the school-houses of the Philippines our own Declaration of Independence, and yet deny independence to them? What response will the heart of the Philippine Islander make as he reads of Lincoln's Emancipation Proclamation? Are we to practise independence and preach subordination, to teach rebellion in our books, yet to stamp it out with our swords, to sow the seed of revolt and expect the harvest of loyalty? President McKinley's call for volunteers to fight for Cuban independence against the cruel dominion of Spain meets with prompt response, but who would answer the call of

--- Page 130. The Gospel of Wealth - VII Distant Possessions: The Parting of the Ways

the President of an "imperial" republic for free citizens to fight the Washington

*(4) Anti-imperialists were fond of comparing Aguinaldo, the Philippine rebel, with George Washington.*

and slaughter the patriots of some distant dependency which struggles for

independence?

17. It has hitherto been the glorious mission of the Republic to establish upon secure foundations Triumphant Democracy, and the world now understands government of the people, for the people, and by the people. Tires the Republic so soon of its mission, that it must, perforce, discard it to undertake the impossible task of establishing Triumphant Despotism, the rule of the foreigner over the people? and must the millions of the Philippines who have been asserting their God-given right to govern themselves be the first victims of Americans, whose proudest boast is that they conquered independence for themselves?

[Baha'i Comment](#)

18. Let another phase of the question be carefully weighed. Europe is to-day an armed camp, not chiefly because the home territories of its various nations are threatened, but because of fear of aggressive action upon the part of other nations touching outlying "possessions." France resents British control of Egypt, and is fearful of its West African possessions; Russia seeks Chinese territory, with a view to expansion to the Pacific;

[Baha'i Comment](#)

Germany also seeks distant possessions; Britain, who has acquired so many dependencies, is so fearful of an attack upon them that this year she is spending nearly eighty millions of dollars upon additional warships, and Russia, Germany, and France follow suit. Japan is a new element of anxiety; and by the end of the year it is computed she will have sixty-seven formidable ships of war. The naval powers of Europe, and Japan also, are apparently determined to be prepared for a terrific struggle for possessions in the far East, close to the Philippines and why not for these islands themselves? Into this vortex the Republic is cordially invited to enter by those powers who expect her policy to be of benefit to them, but her action

--- Page 131. The Gospel of Wealth - VII Distant Possessions: The Parting of the Ways

is jealously watched by those who fear that her power might be used against them.

19. It has never been considered the part of wisdom to thrust one's hand into the hornet's nest, and it does seem as if the United States must lose all claim to ordinary prudence and good sense if she enter this arena and become involved in the intrigues and threats of war which make Europe an armed camp.

[Baha'i Comment](#)

20. It is the parting of the ways. We have a continent to populate and develop; there are only twenty-three persons to the square mile in the United States. England has three hundred and seventy, Belgium five hundred and seventy-one, Germany two hundred and fifty. A tithe of the cost of maintaining our sway over the Philippines would improve our internal waterways; build the Nicaragua Canal; construct a waterway to the ocean from the Great Lakes, an inland canal along the Atlantic seaboard, and a canal across Florida, saving eight hundred miles' distance between New York and New Orleans; connect Lake Michigan with the Mississippi; deepen all the harbors upon the lakes; build a canal from Lake Erie to the Allegheny River; slack-water through movable dams the entire length of the Ohio River

[Baha'i Comment](#)

to Cairo; thoroughly improve the Lower and Upper Mississippi, and all our seaboard harbors. All these enterprises would be as nothing in cost in comparison with the sums required for the experiment of possessing the Philippine Islands, seven thousand miles from our shores. If the object be to render our Republic powerful among nations, can there be any doubt as to which policy is the better? To be more powerful at home is the surest way to be more powerful abroad. To-day the Republic stands the friend of all nations, the ally of none; she has no ambitious designs upon the territory of any power upon another continent; she crosses none of their ambitious designs, evokes no jealousy of the bitter sort, inspires no fears; she is not one of them, scrambling for possessions; she stands apart, pursuing her own

--- Page 132. The Gospel of Wealth - VII Distant Possessions: The Parting of the Ways

great mission, and teaching all nations by example. Let her become a power annexing foreign territory, and all is changed in a moment.



21. If we are able to compete with other nations for foreign possessions, we must have a navy like theirs. It should be superior to any other navy, or we play a second part. It is not enough to have a navy equal to that of Russia or of France, for Russia and France may combine against us just as they may against Britain. We at once enter the field as a rival of Britain, the chief possessor of foreign possessions, and who can guarantee that we shall not even have to measure our power against her?

[Baha'i Comment](#)

22. What it means to enter the list of military and naval powers having foreign possessions may be gathered from the following considerations. First, look at our future navy. If it is only to equal that of France it means fifty-one battleships; if of Russia, forty battle-ships. If we cannot play the game without being at least the equal of any of our rivals, then eighty battle-ships is the number Britain possesses. We now have only four, with five building. Cruisers, armed and unarmed, swell the number threefold, Britain having two hundred and seventy-three ships of the line built or ordered, with three hundred,

[Baha'i Comment](#)

and eight torpedo-boats in addition; France having one hundred and thirty-four ships of the line and two hundred and sixty-nine torpedo-boats. All these nations are adding ships rapidly. Every armor- and gun-making plant in the world is busy night and day. Ships are indispensable, but recent experience shows that soldiers are equally so. While the immense armies of Europe need not be duplicated, yet we shall certainly be too weak unless our army is at least twenty times what it has been - say five hundred thousand men. Even then we shall be powerless as against any one of three of our rivals - Germany, France, and Russia.

23. This drain upon the resources of these countries has become a necessity from their respective positions, largely as graspers for foreign possessions. The United States to-day,

--- Page 133. The Gospel of Wealth - VII Distant Possessions: The Parting of the Ways

happily, has no such necessity, her neighbors being powerless against her, since her possessions are concentrated and her power is one solid mass.

[Baha'i Comment](#)

24. To-day two great powers in the world are compact, developing: themselves in peace throughout vast conterminous territories. When war threatens they have no outlying possessions which call never be really "possessed," but which they are called upon to defend. They fight upon the exposed edge only of their own soil in case of attack, and are not only invulnerable, but they could not be more than inconvenienced by the world in arms against them. These powers are Russia and the United States. The attempt of Britain to check Russia, if the wild counsels of Mr. Chamberlain

*(5) Joseph Chamberlain (1836-1914), the British statesman who, at first a Liberal, became a Conservative in 1895 and a spokesman for "the new imperialism" in Lord Salisbury's government.*

were followed, could end in nothing but failure. With the irresistible force of the glacier, Russia moves upon the plains below. Well for Russia, and well for the world, is her advance over pagan China, better even for Britain from the standpoint of business, for every Russian to-day trades as much with Britain as do nine Chinamen. Britain,

[Baha'i Comment](#)

France, Germany, Belgium, Spain, are all vulnerable, having departed from the sagacious policy of keeping possessions and power concentrated. Should the United States depart from this policy, she also must be so weakened in consequence as never to be able to play the commanding part in the world, disjointed, that she can play whenever she desires if she remain compact.

25. Whether the United States maintain its present unique position of safety, or forfeit it through acquiring foreign possessions, is to be decided by its action in regard to the Philippines; for, fortunately, the independence of Cuba is assured; for this the Republic has proclaimed to the world that she has drawn the sword.

*(6) The Teller Resolution before the outbreak of the Spanish-American War disclaimed for the United States any intention "to exercise sovereignty, jurisdiction, or control" over Cuba.*

But why should the less

--- Page 134. The Gospel of Wealth - VII Distant Possessions: The Parting of the Ways

than two millions of Cuba receive national existence and

[Baha'i Comment](#)

the seven and a half millions of the Philippines be denied it? The United States, thus far in their history, have no page reciting self-sacrifice made for others; all their gains have been for themselves. This void is now to be grandly filled. The page which recites the resolve of the Republic to rid her neighbor, Cuba, from the foreign possessor will grow brighter with the passing centuries, which may dim many pages now deemed illustrious. Should the coming American be able to point to Cuba and the Philippines rescued from foreign domination and enjoying independence won for them by this country and given to them without money and without price, he will find no citizen of any other land able to claim for his country services so disinterested and so noble.

26. We repeat, there is no power in the world that could do more than inconvenience the United States by attacking its fringe, which is all that the world combined could do, so long as our country is not compelled to send its forces beyond its own compact shores to defend worthless possessions. If our country were blockaded by the united powers of the world for years,

[Baha'i Comment](#)

she would emerge from the embargo richer and stronger, and with her own resources more completely developed. We have little to fear from external attack. No thorough blockade of our enormous seaboard is possible; but even if it were, the few indispensable articles not produced by ourselves (if there were any such) would reach us by way of Mexico or Canada at slightly increased cost.

27. From every point of view we are forced to the conclusion that the past policy of the Republic is her true policy for the future; for safety, for peace, for happiness, for progress, for wealth, for power - for all that makes a nation blessed.

[Baha'i Comment](#)

28. Not till the war-drum is silent, and the day of calm peace returns, can the issue be soberly considered.

[Baha'i Comment](#)

29. Twice have the American people met crucial issues wisely, and in the third they are not to fail.

[Baha'i Comment](#)

**MENU:** [HOME](#) » [Reconstruction](#) » [Gospel Content](#) » [Gospel Purpose](#)

# The Gospel of Wealth

And Other Timely Essays

by Andrew Carnegie

**In the right-hand commentary column,  
that which is in GREEN is a commentator's remark and  
that which is in BLUE is from the Baha'i Writings.  
On occasion, in that column, there may be a [link](#) to an extended comment or  
dissertation on the subject under discussion.**

**A reminder that under "view" on your browser - you can set the text size UP  
or DOWN for a more comfortable read for yourself.**

--- Page 135. The Gospel of Wealth - VIII Americanism versus Imperialism

## VIII

### Americanism Versus Imperialism

#### Part I

*(1) From the North American Review, CLXVIII (January and March, 1899), 1-13; 362-372. The Spanish-American War broke out in April 1898 largely because American public opinion had become so excited as to demand Spain grant Cuba independence. A small group of Americans, including Theodore Roosevelt, Henry Cabot Lodge (1850-1924), and A. T. Mahan, also hoped to utilize the conflict to acquire for the United States other Spanish territories, notably the Philippine Islands. Other "Great Powers," for example Germany, Japan and Great Britain, were naturally divided in their sympathies. The first two, while recognizing they could, not turn back the fait accompli of American conquest -- if such occurred -- were themselves expansionist minded; Great Britain regarded American expansion more benignly. After the United States won a military decision, American Commissioners were dispatched to Paris to negotiate a peace with Spain without any definite instructions on Pacific acquisitions from President McKinley or W.R. Day (1849-1923), Secretary of State. The Commissioners debated among themselves what to do. So did the nation's press, politicians and other leaders of opinion. In October 1898 the President decided the United States must take the whole Philippine archipelago. The Senate ratified a treaty to that effect by a narrow two-thirds vote in February 1899. The Filipinos, whose opinion was not solicited, mounted an insurrection against their new masters. Throughout these events Great Britain's foreign policy saw in the United States a counterweight to her own rivals in the imperialist scramble in the Far East. Though English statesmen uttered avuncular approval for American expansion, no concrete understandings or engagements between representatives of the two nations resulted. Of course one of the most effective ways to smear an American policy politically was to arraign it as pro-British.*

*These events were the background of Carnegie's timely essay. His ideas had some support in the Cabinet, and one member tried to get him to change McKinley's annexationist course, but in an interview Carnegie found the President "obdurate."*

1. For several grave reasons I regard possessions in the far East as fraught with nothing but disaster to the Republic. Only one of these, however, can now be considered - the dangers of war and of the almost constant rumors and

--- Page 136. The Gospel of Wealth - VIII Americanism versus Imperialism

threats of war to which all nations interested in the far East are subject. There is seldom a week which does not bring alarming reports of threatened hostilities, or of new alliances, or of changes of alliances, between the powers arming for the coming struggle. It is chiefly this far Eastern question which keeps every ship-yard, gun-yard, and armor-yard in the world busy night and day, Sunday and Saturday, forging engines of destruction. It is in that region the thunderbolt is expected; it is there the storm is to burst.

To introduce this essay by Carnegie, the compiler feels it's important to get a current perspective of that time from the "*Century of Light*." A book written in 2001 under the supervision of the Universal House of Justice.

"From the point of view of wealth and influence, "the world" of 1900 was Europe and, by grudging concession, the United States. Throughout the planet, Western imperialism was pursuing among the populations of other lands what it regarded as its "civilizing mission". In the words of one historian, the century's opening decade appeared to be essentially a continuation of the "long nineteenth century",<sup>3</sup> an era whose boundless self-satisfaction was perhaps best epitomized by the celebration in 1897 of Queen Victoria's diamond jubilee, a parade that rolled for hours through the streets of London, with an imperial panoply and display of military power far surpassing anything attempted in past civilizations. As the century began, there were few, whatever their degree of social or moral sensitivity, who perceived the catastrophes lying ahead, and few, if any, who could have conceived their magnitude. The military leadership of most European nations assumed that war of some kind would break out, but viewed the prospect with equanimity because of the twin fixed convictions that it would be short and would be won by their side. To an extent that seemed little short of miraculous, the international peace movement was enlisting the support of statesmen, industrialists, scholars, the media, and influential personalities as unlikely as the tsar of Russia. If the inordinate increase in armaments seemed ominous, the network of painstakingly crafted and often overlapping alliances seemed to give assurance that a general conflagration would be avoided and regional disputes settled, as they had been through most of the previous century. This illusion was reinforced by the fact that Europe's crowned heads - most of them members of one extended family, and many of them exercising seemingly decisive political power - addressed one another familiarly by nicknames, carried on an intimate correspondence, married one another's sisters and daughters, and vacationed together throughout long stretches of each year at one another's castles, regattas and shooting lodges. Even the painful disparities in the distribution of wealth were being energetically - if not very systematically - addressed in Western societies through legislation designed to restrain the worst of the corporate freebooting of preceding decades and to meet the most urgent demands of growing urban populations.

The vast majority of the human family, living in lands outside the Western world, shared in few of the blessings and little of the optimism of their European and American brethren. China, despite its ancient civilization and its sense of itself as the "Middle Kingdom", had become the hapless victim of plundering by Western



nations and by its modernizing neighbour Japan. The multitudes in India - whose economy and political life had fallen so totally under the domination of a single imperial power as to exclude the usual jockeying for advantage - escaped some of the worst of the abuses afflicting other lands, but watched impotently as their desperately needed resources were drained away. The coming agony of Latin America was all too clearly prefigured in the suffering of Mexico, large sections of which had been annexed by its great northern neighbour, and whose natural resources were already attracting the attention of avaricious foreign corporations. Particularly embarrassing from a Western point of view - because of its proximity to such brilliant European capitals as Berlin and Vienna - was the medieval oppression in which the hundred million nominally liberated serfs in Russia led lives of sullen, hopeless misery. Most tragic of all was the plight of the inhabitants of the African continent, divided against one another by artificial boundaries created through cynical bargains among European powers. It has been estimated that during the first decade of the twentieth century over a million people in the Congo perished - starved, beaten, worked literally to death for the profit of their distant masters, a preview of the fate that was to engulf well over one hundred million of their fellow human beings across Europe and Asia before the century reached its end.

These masses of humankind, despoiled and scorned - but representing most of the earth's inhabitants - were seen not as protagonists but essentially as objects of the new century's much vaunted civilizing process. Despite benefits conferred on a minority among them, the colonial peoples existed chiefly to be acted upon - to be used, trained, exploited, Christianized, civilized, mobilized - as the shifting agendas of Western powers dictated. These agendas may have been harsh or mild in execution, enlightened or selfish, evangelical or exploitative, but were shaped by materialistic forces that determined both their means and most of their ends. To a large extent, religious and political pieties of various kinds masked both ends and means from the publics in Western lands, who were thus able to derive moral satisfaction from the blessings their nations were assumed to be conferring on less worthy peoples, while themselves enjoying the material fruits of this benevolence.

To point out the failings of a great civilization is not to deny its accomplishments. As the twentieth century opened, the peoples of the West could take justifiable pride in the technological, scientific and philosophical developments for which their societies had been responsible. Decades of experimentation had placed in their hands material means that were still beyond the appreciation of the rest of humanity. Throughout both Europe and America vast industries had risen, dedicated to metallurgy, to the manufacturing of chemical products of every kind, to textiles, to construction and to the production of instruments that enhanced every aspect of life. A

continuous process of discovery, design and improvement was making accessible power of unimaginable magnitude - with, alas, ecological consequences equally unimagined at the time - especially through the use of cheap fuel and electricity. The “era of the railroad” was far advanced and steamships coursed the sea-ways of the world. With the proliferation of telegraph and telephone communication, Western society anticipated the moment when it would be freed of the limiting effects that geographical distances had imposed on humankind since the dawn of history.”

(Prepared under the supervision of the Universal House of Justice [2001], Century of Light; pp.2-5)

### possessions

“By God! In earthly riches fear is hidden and peril is concealed. Consider ye and call to mind that which the All-Merciful hath revealed in the Qur'an: `Woe betide every slanderer and defamer, him that layeth up riches and counteth them.'+F1 Fleeting are the riches of the world; all that perisheth and changeth is not, and hath never been, worthy of attention, except to a recognized measure.” (Bahá'u'lláh [1863-1892], Tablets of Baha'u'llah; Page 219)

### constant rumors and threats of war

“Christ said: "Think not that I am come to send peace on earth: I came not to send peace, but a sword" (Matt. x, 34), and He predicted a period of wars and rumors of wars, of tribulations and afflictions that would continue till the coming of the Son of Man "in the glory of the Father."” (J.E. Esslemont [1937]: Baha'u'llah and the New Era, p.46)

**2. It is only four years since Japan defeated China and had ceded to it a portion of Chinese territory, the fruits of victory. Then appeared upon the scene a combination of France, Russia, and Germany, which drove Japan out of China. Russia took part of the spoils for herself, and Germany later took territory near by. Japan got nothing. Britain, the most powerful of**

### Colonization

Although the Universal House of Justice is speaking here of world conditions immediately after world war one, the theme of their exposition relates directly to the overall condition of the world due to colonization.

“Since the driving force of colonialism itself was economic exploitation, it was perhaps inevitable that most movements of liberation assumed a broadly socialistic ideological cast. Within only a few short years, these circumstances had created a fertile ground for exploitation by the world’s superpowers. For the Soviet Union, the situation seemed to offer an opportunity to induce a shift in the existing alignment of nations by gaining a preponderating influence in what was by now beginning to be called the “Third World”. The

all, stood by neutral. Had she decided to defend Japan, the greatest war ever known would have been the probable result; the thunderbolt would have fallen. Were the question to be decided to-day, it is now considered probable that Britain would support Japan.

response of the West - wherever development aid failed to retain the loyalties of recipient populations - was to resort to the encouragement and arming of a wide variety of authoritarian regimes.

As outside forces manipulated new governments, attention was increasingly diverted from an objective consideration of developmental needs to ideological and political struggles that bore little or no relation to social or economic reality. The results were uniformly devastating. Economic bankruptcy, gross violations of human rights, the breakdown of civil administration and the rise of opportunistic elites who saw in the suffering of their countries only openings for self-enrichment - such was the heartbreaking fate that engulfed one after another of the new nations who, only short years before, had begun life with such great promise.”

(Prepared under the supervision of the Universal House of Justice [2001], Century of Light; pp.88-89)

neutral

“Hitherto the usual practice of mankind has been that if one nation attacked another, the rest of the nations of the world remained neutral, and accepted no responsibility in the matter unless their own interests were directly affected or threatened. The whole burden of defense was left to the nation attacked, however weak and helpless it might be. The teaching of Baha'u'llah reverses this position and throws the responsibility of defense not specially on the nation attacked, but on all the others, individually and collectively. As the whole of mankind is one community, an attack on any one nation is an attack on the community, and ought to be dealt with by the community. Were this doctrine generally recognized and acted on, any nation contemplating an aggression on another would know in advance that it would have to reckon with the opposition not of that other nation only, but of the whole of the rest of the world. This knowledge alone would be sufficient to deter even the boldest and most bellicose of nations. When a sufficiently strong league of peace-loving nations is established war will, therefore, become a thing of the past. During the period of transition from the old state of international anarchy to the new state of international solidarity aggressive wars will still be possible, and in these circumstances, military or other coercive action in the cause of international justice, unity and peace may be a positive duty. 'Abdu'l-Baha writes that in such case:--

A conquest can be a praiseworthy thing, and there are times when war becomes the powerful basis of peace, and ruin the very means of reconstruction. If, for example, a high-minded sovereign marshals his troops to block the onset of the insurgent and the aggressor, or

again, if he takes the field and distinguishes himself in a struggle to unify a divided state and people, if, in brief, he is waging war for a righteous purpose, then this seeming wrath is mercy itself, and this apparent tyranny the very substance of justice and this warfare the cornerstone of peace. Today, the task befitting great rulers is to establish universal peace, for in this lies the freedom of all peoples.-- The Secret of Divine Civilization, pp. 70-71.”

(J.E. Esslemont [1937]: Baha’u’llah and the New Era, pp.171-172)

It is interesting that Carnegie mentions that Britain was neutral in the conflict between China and Japan, and that France, Germany and Russia all got involved and distributed the spoils of war amongst them. Queen Elizabeth of Britain was one of the few world leaders directly addressed by Bahá’u’lláh that replied in a dignified manner to his summons. Bahá’u’lláh addressing Queen Victoria somewhere between 1868-1877 says;

"O Queen in London! Incline thine ear unto the voice of thy Lord, the Lord of all mankind, calling from the Divine Lote-Tree: Verily, no God is there but Me, the Almighty, the All-Wise! ... We have been informed that thou hast forbidden the trading in slaves, both men and women. This, verily, is what God hath enjoined in this wondrous Revelation. God hath, truly, destined a reward for thee, because of this. He, verily, will pay the doer of good, whether man or woman, his due recompense... We have also heard that thou hast entrusted the reins of counsel into the hands of the representatives of the people. Thou, indeed, hast done well, for thereby the foundations of the edifice of thine affairs will be strengthened, and the hearts of all that are beneath thy shadow, whether high or low, will be tranquillized.” (Bahá’u’lláh [1868-1977], Proclamation of Baha’u’llah; p.33)

Abdu’l-Baha says the following about Queen Victoria;

“Victoria, Queen of England, was really superior to all the kings of Europe in ability, justness and equitable administration. During her long and brilliant reign the British Empire was immensely extended and enriched, due to her political sagacity, skill and foresight.” (Abdu’l-Bahá [1912], Promulgation Universal Peace; p.282)

The following excerpt from the book entitled “Baha’u’llah” prepared under the supervision of the Universal House of Justice, points out the distinct difference in language in which Baha’u’llah addressed the rulers of America and Great Britain, then to those rulers in mainland Europe and Asia:

“In Akka, Baha'u'llah continued the dictation of a series of letters to

individual rulers, which He had begun in Adrianople. Several contained warnings of the judgment of God on their negligence and misrule, warnings whose dramatic fulfillment aroused intense public discussion throughout the Near East. Less than two months after the exiles arrived in the prison-city, for example, Fu'ad Pasha, the Ottoman foreign minister, whose misrepresentations had helped precipitate the banishment, was abruptly dismissed from his post and died in France of a heart attack. The event was marked by a statement which predicted the early dismissal of his colleague, Prime Minister Ali Pasha, the overthrow and death of the Sultan, and the loss of Turkish territories in Europe, a series of disasters which followed on the heels of one another.

A letter to Emperor Napoleon III warned that, because of his insincerity and the misuse of his power: "...thy kingdom shall be thrown into confusion, and thine empire shall pass from thine hands, as a punishment for that which thou hast wrought.... Hath thy pomp made thee proud? By My life! It shall not endure..."[79] Of the disastrous Franco-Prussian War and the resulting overthrow of Napoleon III, which occurred less than a year after this statement, Alistair Horne, a modern scholar of nineteenth century French political history has written:

History knows of perhaps no more startling instance of what the Greeks called peripateia, the terrible fall from prideful heights. Certainly no nation in modern times, so replete with apparent grandeur and opulent in material achievement, has ever been subjected to a worse humiliation in so short a time.

Only a few months before the unexpected series of events in Europe that led to the invasion of the Papal States and the annexation of Rome by the forces of the new Kingdom of Italy, a statement addressing Pope Pius IX had urged the Pontiff "Abandon thy kingdom unto the kings, and emerge from thy habitation, with thy face set towards the Kingdom... Be as thy Lord hath been.... Verily, the day of ingathering is come, and all things have been separated from each other. He hath stored away that which He chose in the vessels of justice, and cast into the fire that which befitteth it...."

Wilhelm I, King of Prussia, whose armies had won such a sweeping victory in the Franco-Prussian War, had been warned by Baha'u'llah in the Kitab-i-Aqdas to heed the example of the fall of Napoleon III and of other rulers who had been victorious in war, and not to allow pride to keep him back from recognizing this Revelation. That Baha'u'llah foresaw the failure of the German Emperor to respond to this warning is shown by the ominous passage which appears later in that same Book:

O banks of the Rhine! We have seen you covered with gore,

inasmuch as the swords of retribution were drawn against you; and you shall have another turn. And We hear the lamentations of Berlin, though she be today in conspicuous glory.

A strikingly different note characterizes two of the major pronouncements, that addressed to Queen Victoria[83] and another to the "Rulers of America and the Presidents of the Republics therein." The former praises the pioneering achievement represented by the abolition of slavery throughout the British Empire, and commends the principle of representative government. The latter, which opens with the announcement of the Day of God, concludes with a summons, a virtual mandate, that has no parallel in any of the other messages: "Bind ye the broken with the hands of justice, and crush the oppressor who flourisheth with the rod of the commandments of your Lord, the Ordainer, the All-Wise."

(Prepared at the request of the Universal House of Justice by the Baha'i International Community Office of Public Information [1991], Bahá'u'lláh; Pages 21-22)

**3. Germany obtained a concession in China, and Britain promptly appeared, demanding that Germany should maintain the "open door" in all her Chinese territory; the same demand was made on Russia. Both perforce consented. The far East is a mine of dynamite, always liable to explode. The relative strength of the powers contending for empire in the far East is as follows: Great Britain has 80 first-class ships of war, 581 war-ships in all; France has 50 first-class war-ships, and a total of 403; Russia has 40 first-class warship", 286: in all; Germany has 28 first-class war-ships, a total of 216. Japan will soon rank with Germany, and be stronger**

"...an era whose boundless self-satisfaction was perhaps best epitomized by the celebration in 1897 of Queen Victoria's diamond jubilee, a parade that rolled for hours through the streets of London, with an imperial panoply and display of military power far surpassing anything attempted in past civilizations." (Prepared under the supervision of the Universal House of Justice [2001], Century of Light; p.2)

there because close to the scene of action.

4. The United States proposes to enter into the zone of danger with 18 first-class and a total of 81 ships. These would hardly count as half that number, however, owing to her greater distance from the battle-ground. Russia is 8000 miles,

--- Page 137. The Gospel of Wealth - VIII Americanism versus Imperialism

the other Europeans about 9000 miles from it. The United States is from 15,000 to 17,000 miles distant via the Cape and via the Straits; the route via Europe is about 12,000 miles, but that would be impracticable during war-time, as the American ships going via Europe would pass right into the trap of their European enemies.

armaments

Compose your differences, and reduce your armaments, that the burden of your expenditures may be lightened, and that your minds and hearts may be tranquillized. Heal the dissensions that divide you, and ye will no longer be in need of any armaments except what the protection of your cities and territories demandeth. Fear ye God, and take heed not to outstrip the bounds of moderation, and be numbered among the extravagant.

We have learned that you are increasing your outlay every year, and are laying the burden thereof on your subjects. This, verily, is more than they can bear, and is a grievous injustice. Decide justly between men, and be ye the emblems of justice amongst them. This, if ye judge fairly, is the thing that behoveth you, and beseemeth your station.

Beware not to deal unjustly with any one that appealeth to you, and entereth beneath your shadow. Walk ye in the fear of God, and be ye of them that lead a godly life. Rest not on your power, your armies, and treasures. Put your whole trust and confidence in God, Who hath created you, and seek ye His help in all your affairs. (Baha'u'llah [1863-1892], Gleanings from the Writings of Baha'u'llah, pp.250-251)

**5. The armies of the European nations are as follows: Germany's army on a peace footing numbers 562,352 men, on a war footing, 3,000,000 (and a large addition ordered); France's army on a peace footing, 615,413, on a war footing, 2,500,000; Russia's, on a peace footing, 750,944, on a war footing, 2,512,143. All Frenchmen and Germans over twenty, and all Russians over twenty-one years of age are subject to military service. They are, in fact, first soldiers, then citizens.**

“How savage and fearful the ferocity of man against his fellowman! Consider what is taking place now in the Balkans, what blood is being shed. Even the wild beasts and ferocious animals do not commit such acts. The most ferocious wolf kills but one sheep a day, and even that for his food. But now in the Balkans one man destroys ten fellow beings. The commanders of armies glory in having killed ten thousand men, not for food, nay, rather, for military control, territorial greed, fame and possession of the dust of the earth. They kill for national aggrandizement, notwithstanding this terrestrial globe is but a dark world of grossest matter. It is a world of sorrow and grief, a world of disappointment and unhappiness, a world of death. For after all, the earth is but the everlasting graveyard, the vast, universal cemetery of all mankind. Yet men fight to possess this graveyard, waging war and battle, killing each other. What ignorance! How spacious the earth is with room in plenty for all! How thoughtful the providence which has so allotted that every man may derive his sustenance from it! The Lord, our Creator, does not ordain that anyone should starve or live in want. All are intended to participate in the blessed and abundant bestowals of our God. Fundamentally, all warfare and bloodshed in the human world are due to the lack of unity between the religions, which through superstitions and adherence to theological dogmas have obscured the one reality which is the source and basis of them all.” (‘Abdu’l-Baha [1912]: Promulgation of Universal Peace; p. 396)

**6. It is obvious that the United States cannot contest any question or oppose any demand of any one of its rivals which secures the neutrality of the other powers, as France, Germany, find Russia did that of Britain. She cannot stand alone. What the *Saturday Review***

*(2) "This is the British publication of course.*

**says here is true:**

**Let us be frank and say outright that we expect mutual gain in material interests from this**

“These masses of humankind, despoiled and scorned - but representing most of the earth’s inhabitants - were seen not as protagonists but essentially as objects of the new century’s much vaunted civilizing process. Despite benefits conferred on a minority among them, the colonial peoples existed chiefly to be acted upon - to be used, trained, exploited, Christianized, civilized, mobilized - as the shifting agendas of Western powers dictated. These agendas may have been harsh or mild in execution, enlightened or selfish, evangelical or exploitative, but were shaped by materialistic forces that determined both their means and most of their ends. To a large extent, religious and political pieties of various kinds masked both ends and means from the publics in Western lands, who were thus able to derive moral satisfaction from the blessings their nations were assumed to be conferring on less worthy peoples, while themselves enjoying the material fruits of this benevolence.” (Prepared under the supervision of the Universal House of Justice [2001], Century of Light; p.4)



rapprochement. The American commissioners at Paris are making their bargains, whether they realize it or not, under the protecting naval strength of England, and we shall expect a material *quid pro quo* for this assistance. We expect the United States to deal generously with Canada in the matter of tariffs, and we expect to be remembered when the United States comes into possession of the Philippine Islands, and above all we expect her assistance on the day, which is quickly approaching, when the future of China comes up for settlement, for the young Imperialist has entered upon a path where it will require a strong friend, and a lasting friendship between the two nations can be secured not by frothy sentimentality on public platforms, but by reciprocal advantages in solid material interests.

7. Bishop Potter has recently stated that we must become the "cat's-paw of Britain" if we venture into the arena, and

--- Page 138. The Gospel of Wealth - VIII Americanism versus Imperialism

that is true. By Britain's neutrality, and by that alone, were we permitted to take the Philippines at all from Spain. But for that, France, Germany, and Russia never would have stood aloof, and the price demanded President McKinley has had to pay - the "open door," which secures the trade of our possessions for Britain. Nothing more significant has occurred than the statement of Senator Davis,

*(3) Henry Gassaway Davis (1823-1918), Senator from West Virginia, served as delegate to the first two International American Congresses.*

chairman of the Senate Committee upon Foreign Relations, whose ability, influence, and position are alike commanding. He says:

I favor a treaty of alliance including the United States, Great Britain, and Japan, for the protection of all their interests north of the

[Baha'i Comment](#)

equator. The rest of the world would have a wholesome fear, synonymous with respect, for us.

8. We may assume after this that it is true that, just as we were allowed by Britain to take the Philippines from Spain, so our position in the East depends upon her continued support or alliance - rather a humiliating position, I should say, for the Republic. But let us see about alliances. Can we depend upon an alliance? National combinations change with alarming rapidity in Europe. France and Britain, allied, fought the Crimean War. They took Sebastopol as we took Manila. Their flags waved together there, but they did not consider that that fact gave them the right to demand territory. To-day Russia and France are in firm alliance against Britain and other nations. Germany fought Austria; to-day they are in the Triple Alliance together. Italy allied with France fought the battle of Solferino; to-day Italy is a member of the Triple Alliance against France. Europe is a kaleidoscope, where alliances change, dissolve, recombine, and take other forms with passing events. During the

One must recognize the foresight of Carnegie here to have the vision to see that these alliances between the nations were constantly in flux and certainly not reliable. In fact, the growing power of the Britain, U.S. alliance would cause Germany to escalate its material production.

“...as the Master had also warned - when Germany, feeling constrained by a growing web of hostile alliances, embarked on a massive naval building programme aimed at eliminating the previously accepted British lead.” (Prepared under the supervision of the Universal House of Justice [2001], *Century of Light*; p.29)

Carnegie says, “*There is no alliance, not even the most apparently incongruous, that cannot be made, and that will not be made, to meet the immediate interests or ambitions of nations.*”

“Material brotherhood does not prevent nor remove warfare; it does not dispel differences among mankind. But spiritual alliance destroys the very foundation of war, effaces differences entirely, promulgates the oneness of humanity, revivifies mankind, causes hearts to turn to the Kingdom of God and baptizes souls with the Holy Spirit.” (‘Abdu’l-Baha [1912]: *Promulgation of Universal Peace*; p.130)

past week the bitter enmity which recently existed between Germany and Britain, owing to German interference in the Transvaal, is changed, and it is announced that "they see together upon

--- Page 139. The Gospel of Wealth - VIII Americanism versus Imperialism

many points and expect to cooperate more and more in the future." This morning the question is, Shall France and Germany combine for some common ends? This would have been considered remarkable a short time ago, but statesmen will remember that Germany and France did combine with Russia to drive Japan out of China. There is no alliance, not even the most apparently incongruous, that cannot be made, and that will not be made, to meet the immediate interests or ambitions of nations. Senator Davis seems to rest satisfied with an alliance for his country with Britain and Japan. If he had an alliance to-day, it might not be worth the paper it was written upon to-morrow.

9. I say, therefore, that no American statesman should place his country in any position which it could not defend relying only upon its own strong right arm. Its arm at present is not much to depend upon; its eighty-one ships of war are too trifling to be taken into account; and as for its army what are its fifty-six thousand regulars? Its volunteers are being disbanded. Both its navy and its army are good for one thing only - for easy capture or destruction by either one of the stronger powers. It is the protection of Britain, and that alone, upon which we have to rely in the far East a slender thread indeed. Upon the shifting sands of alliances we are to have our only foundation.

[Baha'i Comment](#)

10. The writer is not of those who believe that the Republic cannot make itself strong enough to walk alone, and to hold her own, and to be an imperial power of herself, and not the weak protege of a real imperial power. But in order to make herself an imperial power she must do as imperial powers do - she must create a navy equal to the navy of any other power. She must have hundreds of thousands of regular troops to cooperate with the navy.

**"...she must create a navy equal to the navy of any other power. She must have hundreds of thousands of regular troops to cooperate with the navy."**

"...the greatest need of the world of humanity today is to receive the efficacy of the Holy Spirit. Until the Holy Spirit becomes effective, interpenetrating the hearts and spirits, and until perfect, reasonable faith shall obtain in the minds of men, it is impossible for the social body to be inspired with security and confidence. Nay, on the contrary, day by day enmity and strife shall increase among men and the differences and divergences of the nations shall augment; day by day additions to armies and navies of the world shall be made, and great is the fear of the great pandemic war, the war unparalleled in history; for armaments which heretofore have been so limited are now becoming amplified on a grand scale. It is becoming severe, drawing nigh unto the degree that men shall war upon the seas, war upon the plains, nay, rather, shall war in the very atmosphere; and such conditions of warfare never obtained in bygone days. The

dangers of war grow equally with the growth of armaments.”  
(Abdu'l-Baha: Baha'i Scriptures, pp.280-281)

11. If she devoted herself exclusively and unceasingly to creating a navy equal to that of Britain, for instance, which is what she will need if she is not to be at the mercy of stronger powers, that will be the work of more than twenty years,

--- Page 140. The Gospel of Wealth - VIII Americanism versus Imperialism

building twenty war-ships per year; hitherto our navy has added only six per year. In order to get the men to man these ships, she must take the means to educate them. That she can do this there is no question; that the American either on sea or land is at least equal to the man of any other nation cannot be gainsaid. More than this, I know the American workman, especially the mechanic, to be the most skilful, most versatile, in the world - and victories at sea depend as much upon the mechanic below as upon the gunner on deck, and American gunners have no equals. It was no surprise to me that the American war-ships sunk those of Spain without loss. I spent last winter abroad in the

Baha'i Comment

society of distinguished men of European nations who congregate at Cannes. The opinion was universally held by them that for a time the Spanish navy would be master over us, although it was admitted the superior resources of the United States must eventually insure victory. I said then that, whenever any war-ships in the world met those of the American navy, the other war-ships would go to the bottom - for two reasons: first, our ships were the latest and their equipment was the best, and, second, I knew the kind of men who were behind the guns. If ever the Republic falls from her industrial ideals and descends to the level of the war ideals of Europe, she will be supreme; I have no doubt of that. The man whom this stimulating climate produces is the wiriest, quickest, most versatile of all men, and the power of organization exists in the American in greater perfection than in any other. But what I submit is that at present the Republic is an industrial hive, without an adequate navy and without soldiers; that she therefore must have a protector; and that if she is to figure in the East, she cannot be in any sense an imperial power at all. Imperialism implies naval and military force behind, Moral

force, education, civilization, are not the backbone of Imperialism; these are the moral forces which make for the higher civilization, for Americanism. The foundation for Imperialism is

--- Page 141. The Gospel of Wealth - VIII Americanism versus Imperialism

brutal physical strength, fighting men with material forces, war-ships and artillery.

12. The author of "A Look Ahead," which first appeared in the *North American Review*

*(4) Carnegie's own article, in June 1893 (CLVI, 685-710), reprinted in the 1893 edition of Triumphant Democracy.*

is not likely to be suspected of hostility to the coming together of the English-speaking race. It has been my dream, and it is one of the movements that lie closest to my heart. For many years a united flag has floated from my summer home in my native land, the Stars and Stripes and the Union Jack sewn together - the first flag of that kind ever seen. That flag will continue to fly there and the winds to blow the two from side to side in loving embrace. But I do not favor a formal alliance, such as that

patriotism of race

"It is racial, patriotic, religious and class prejudice, that has been the cause of the destruction of Humanity." (Abdu'l-Baha [1911]: Abdu'l-Baha in London, p.28)

"Both the material and intrinsic development of man are conditional upon amity and love and the greatest honor and pleasure in the human world is love; but the ways and means are different. Sometimes the cause of love is simply relationship and kinship; and sometimes it is a racial bond, patriotism, political affairs, etc. But, through all these various bonds and means it is impossible to obtain a real and pure love; it is rather superficial and temporary. Such love may easily be changed into enmity and rancor, for it is affected by the slightest manifestation of hostility; whereas a true and ideal love is faith and assurance." (Abdu'l-Baha [1910]: Star of the West, Vol. 1:8, Aug. 1 1910, p.5)



desired by Senator Davis. On the contrary, I rely upon the "alliance of hearts," which happily exists to-day.

Alliances of fighting power form and dissolve with the questions which arise from time to time. The patriotism of race lies deeper and is not disturbed by waves upon the surface. The present era of good feeling between the old and the new lands means that the home of Shakspeare and Burns will never be invaded without other than native-born Britons being found in its defense. It means that the giant child, the Republic, is not to be set upon by a combination of other races and pushed to its destruction without a growl coming from the old lion which will shake the earth. But it should not mean that either the old land or the new binds itself to support the other in all its designs, either at home or abroad, but that the Republic shall remain the friend of all nations and the ally of none; that, being free today of all foreign entanglements, she shall not undertake to support Britain, who has these to deal with. Take Russia, for instance. Only last year leading statesmen were pushing Britain into a crusade against that country. They proposed to prevent its legitimate expansion toward

the Pacific - legitimate because it is over coterminous territory, which Russia can absorb and Russian-

--- Page 142. The Gospel of Wealth - VIII Americanism versus Imperialism

ize, keeping her empire solid. She knows better than to have outlying possessions open to attack. Russia has always been the friend of the United States. When Lord Palmerston, Prime Minister of Great Britain, proposed to recognize the South, Russia sent her fleet to New York. Russia sold us Alaska. We have no opposing interests to those of Russia; the two nations are the only two great nations in the world solid, compact, impregnable, because each has developed only coterminous territory, upon which its own race could grow. Even in the matter of trade with Russia, our exports are increasing with wonderful rapidity. Shiploads of American locomotives, American steel bridges, and American electrical machinery for her leave our shores. Everything in which our country is either supreme or becoming supreme goes to Russia. Suppose Britain and Russia clash in the Far East and we have an alliance with Britain, we are at war against

one of our best friends.

13. The sister Republic of France and our own, from her very beginning, have been close friends. The services France rendered at the Revolution may be, but never should be, forgotten by the American. That some interests in France sympathized with Spain was only natural. The financial world in France held the Spanish debt. The religion of France is the religion of Spain. The enemies of the French Republic sided with the monarchy. But this can be said without fear of contradiction, that those who govern France stood the friends of our Republic, and that our enemies in France were also the enemies of the French government. An alliance with Britain and Japan would make us a possible enemy of France. I would not make an alliance which involved that. I would make no alliance with any power under any circumstances that can be imagined; I would have the Republic remain the friend of all powers. That has been her policy from the beginning, and so it should remain.

[Baha'i Comment](#)

14. When "the world shall have a wholesome fear, synonymous with respect, for us," as Senator Davis desires, it will

--- Page 143. The Gospel of Wealth - VIII Americanism versus Imperialism

not be a good day for the Republic. Adherence to Washington's desire seems better to me-that we should be the "friends of all nations"- a wholesome friendship instead of a "wholesome fear."

[Baha'i Comment](#)

15. Reference has been made to possible difference arising between the protector and its ward, but I do not wish to be understood as entertaining the belief that actual war is probable between them. Far from this, my opinion is that actual war will never exist again between the two branches of the English-speaking race. Should one have a grievance, the other would offer arbitration, and no government of either could exist which refused that offer. The most powerful government ever known in Britain was that of Lord Salisbury, when President Cleveland rightfully demanded arbitration in the Venezuelan case.

[Baha'i Comment](#)

*(5) The boundary dispute between British Guiana and Venezuela, of long standing, came to a crisis in April 1895 with the arrest of two British officials. Cleveland, persuaded by the Venezuelan minister to invoke the Monroe Doctrine, sent a message to Congress virtually stating that British efforts to enforce claims on Venezuela without arbitration would be considered a cause of war. The question was eventually arbitrated in 1899. See also Essay XI, note 2.*

As is well known, Mr. Gladstone's government had agreed to arbitration. Lord Salisbury, upon coming into power, repudiated that agreement. Lord Salisbury denied President Cleveland's request, and what was the result? Some uninformed persons in the United States believe that he was compelled to withdraw his refusal and accede to President Cleveland's request by the attitude of the United States. That was only partially true. The forces in Britain supporting Lord Salisbury compelled him to reverse his decision. This is an open secret. Those nearest and next to him in power who sided with President Cleveland could be named; but the published cables are sufficient. The heir and the next heir to the throne cabled that they hoped and believed the question would be peacefully settled. That behind this cable was the Queen herself, always

the friend of the Republic,  
need not be doubted.

--- Page 144. The Gospel of  
Wealth - VIII Americanism  
versus Imperialism

16. The idea of actual war between Great Britain and the Republic can be dismissed as something which need not be taken into account; but what is to be feared is this: the neutrality of Britain -- even to-day desired by other powers - in case her ward gave her offense, or was, as she supposed, ungrateful, and did not make full return for the protection accorded to the weakling, as we have said. It did not require the active hostility of Great Britain to thwart Japan and push her out of her possessions, but simply her decision not to interfere on Japan's behalf. Had Japan had satisfactory advantages to offer to Britain, she might have had Britain's support. It is the satisfactory bargain that alliances are founded upon in Europe; every European nation has its price, and every one of them has something which the other covets. France could give Britain a free hand in Egypt. Germany could concur in Britain's acquisition of Delagoa Bay

[Baha'i Comment](#)

*(6) In 1875 Marshal MacMahon, President of France, acting as arbitrator in a dispute between Great Britain and Portugal over the ownership of Delagoa Bay, awarded this port to Portugal, which began active colonization, extending westward and conflicting with British claims inland. The dispute lasted from 1880 to 1890, when Lord Salisbury delivered an ultimatum, as a consequence of which in 1891 Portugal conceded to Great Britain the right of preemption to her possessions south of the Zambesi River. The Transvaal Republic wanted a seaport, but in 1895 Great Britain annexed the territory between Zululand and Mozambique, thus cutting the Boer Republic off from any port. German interests in Africa looked with disfavor on further British colonial expansion.*

and end her troubles in the Transvaal. This is something Britain dearly covets. Russia could give Britain a desired frontier in India. These nations have all co-related interests and desires, and no man can predict what alliances will be broken and what made - it is all a matter of self-interest. The United States has not this position. She has little desirable to offer in exchange for alliance, and in all probability she would be sacrificed for the aims of her strong rivals -- at least she might be, being herself powerless.

17. When a statesman has in his keeping the position and interests of his country, it is not with things as they are to be in the future, but with things as they are in the present, that

--- Page 145. The Gospel of Wealth - VIII Americanism versus Imperialism

it is his serious duty to deal. The dream, in which no one perhaps indulges more than the writer, of the union of the English-speaking race, even that entrancing dream must be recognized as only a dream. The "Parliament of Man, the Federation of the World,"

*(7) "Till the war drum throbbed no longer and the battle flags were furled  
In the Parliament of Man, the Federation of the world."*

*Locksley Hall, lines 127-128.*

we know is to come. The evolutionist has never any doubt about the realization of the highest ideals from the operation of that tendency within us, not ourselves, which makes for righteousness. But he is no statesman - he is only a dreamer - who allows his hopes to stand against facts, and he who proposes that the United States, as she stands

highest ideals

"...harmony, unity and love are held up as the highest ideals in human relationships." (From a letter written on behalf of Shoghi Effendi to the National Spiritual Assembly of Central America, November 9, 1956: Quoted in Lights of Guidance, p.222)

**"that tendency within is"**

"Self has really two meanings, or is used in two senses, in the Baha'i writings: one is self, the identity of the individual created by God. This is the self mentioned in such passages as 'he hath known God who hath known himself etc.'. The other self is the ego, the dark, animalistic heritage each one of us has, the lower nature that can develop into a monster of selfishness, brutality, lust and so on. It is this self we must struggle against, or this side of our natures, in order to strengthen and free the spirit within us and help it to attain perfection." (From a letter written on behalf of Shoghi Effendi to an individual believer, December 10, 1947: Quoted in Lights of Guidance, p.113)

"Little reflection, little admonition is necessary for us to realize the purpose of our creation. What a heavenly potentiality God has deposited within us! What a power God has given our spirits! He has endowed us with a power to penetrate the realities of things; but we must be self-abnegating, we must have pure spirits, pure intentions, and strive with heart and soul while in the human world to attain everlasting glory." ('Abdu'l-Baha [1912]: Promulgation of Universal Peace; p.187)



to-day, shall enter into the coming struggle in the far East, depending upon any alliance that can be made with any or all of the powers, seems unsuited to shape the policy or deal with the destinies of the Republic.

18. Just consider her position, solid, compact, impregnable. If all the naval forces were to combine to attack her, what would be her reply. She would fill her ports with mines; she would draw her ships of war behind them, ready to rush out as favorable opportunities might offer to attack. But she would do more than this in extremity: she would close her ports, - a few loaded scows would do the business, - and all the powers in the world would be impotent to injure her seriously. The fringe only would be troubled; the great empire within would scarcely feel the attack.

[Baha'i Comment](#)

19. The injury she would inflict upon the principal powers by closing her ports would be much more serious than could be inflicted upon her, because non-exportation of food-stuffs and cotton would mean famine and distress to Britain and injure her to a greater degree than loss in battle. Even in France and in Germany the results of non-exportation would be more serious than the effects of ordinary war. It would only be a matter of a short time until the powers recognized how futile was their attempt to injure seriously this self-

--- Page 146. The Gospel of Wealth - VIII Americanism versus Imperialism

contained Republic, whose estate here lies secure within a ring fence.

**"this self-contained Republic, whose estate here lies secure within a ring fence."**

The United States has habitually imagined that it could exist in isolation from the rest of the world. George Washington said that this country should not become entangled in the affairs of other nations. But it's obvious to all that the world is shrinking into a neighborhood and -- willingly or unwillingly -- America must assume her responsibility. The U.S. was yanked into WWII with the attack on Pearl Harbor. Then they ventured into Korea, Cambodia, Vietnam, Bosnia and numerous other areas.

"Paradoxical as it may seem, her only hope of extricating herself from the perils gathering around her is to become entangled in that very web of international association which the Hand of an inscrutable Providence is weaving." (Shoghi Effendi [1938], Advent of Divine Justice, pp.87-88)

"This nation, moreover, may well claim to have, as a result of its effective participation in both the first and second world wars, redressed the balance, saved mankind the horrors of devastation and bloodshed involved in the prolongation of hostilities..." (Shoghi Effendi, Citadel Of Faith, p.36)

It appears in the year 2002 that every feeble attempt at isolationism has been met with a crisis that forces the government to re-evaluate her stance. Most recently the terrorist attacks of profound economic implications on American soil. Of course Carnegie could scarcely imagine a contracted world in which trying to dismiss disturbances of the part would eventually visit it's scourge upon the whole.

"One of the striking developments of this kind that Shoghi Effendi discerned in the Writings he was called on to interpret concerned the future role of the United States as a nation, and, to a lesser extent, its sister nations in the Western hemisphere. His foresight is all the more remarkable when one remembers that he was writing during a period of history when the United States was determinedly isolationist in both its foreign policy and the convictions of the majority of its citizens. Shoghi Effendi, however, envisioned the country assuming an "active and decisive part ... in the organization and the peaceful settlement of the affairs of mankind". He reminded Baha'is of 'Abdu'l-Baha's anticipation that, because of the unique nature of its social composition and political development - as opposed to any "inherent excellence or special merit" of its people - the United States had developed capacities that could empower it to be "the first nation to establish the foundation of international agreement". Indeed, he foresaw the governments and peoples of the entire hemisphere becoming increasingly oriented in this direction."

(Prepared under the supervision of the Universal House of Justice [2001], Century of Light; p.52)

20. The national wealth would not grow as fast during the blockade, but that is all. Our foreign trade would suffer, but that is a trifle, not more than four per cent of our domestic commerce. No expert estimates the annual domestic exchanges of the people at less than fifty thousand millions of dollars; those of exports and imports have never yet reached Quite two thousand millions. The annual increase of domestic exchanges is estimated to be just about equal to the total of all our foreign trade, imports and exports combined. Labor would be displaced, but the new demand upon it caused by the new state of affairs would employ it all. We should emerge from the embargo without serious injury. So much for the impregnability of the Republic. To-day fortune rains upon her. For the first time in her history, she has become the greatest exporting nation in the world, even the exports of Britain being less than hers. Her manufactures are invading all lands; commercial expansion proceeds by leaps and bounds. New York has become the financial center of the world. It is London no more,

### Impregnable

The Baha'i writings proclaim "religion" to be;

"a radiant light and an impregnable stronghold for the protection and welfare of the peoples of the world" and "the chief instrument for the establishment of order in the world"; affirms its fundamental purpose to be the promotion of union and concord amongst men; warns lest it be made "a source of dissension, of discord and hatred"; commands that its principles be taught to children in the schools of the world, in a manner that would not be productive of either prejudice or fanaticism; attributes "the waywardness of the ungodly" to the "decline of religion"; and predicts "convulsions" of such severity as to "cause the limbs of mankind to quake." (Shoghi Effendi [1944], *God Passes By*, p.217)

When man vainly imagines that his own imaginings are "impregnable" God quickly takes action to humble our ego. For example, upon hearing of the Titanic calamity, Abdu'l-Baha stated;P> "...these events have deeper reasons. Their object and purpose is to teach man certain lessons. We are living in a day of reliance upon material conditions. Men imagine that the great size and strength of a ship, the perfection of machinery or the skill of a navigator will ensure safety, but these disasters sometimes take place that men may know that God is the real Protector. If it be the will of God to protect man, a little ship may escape destruction, whereas the greatest and most perfectly constructed vessel with the best and most skillful navigator may not survive a danger such as was present on the ocean. The purpose is that the people of the world may turn to God, the One Protector; that human souls may rely upon His preservation and know that He is the real safety. These events happen in order that man's faith may be increased and strengthened." ('Abdu'l-Baha [1912]: *Promulgation of Universal Peace*; p.48)

but New York, which is to-day the financial center. This, however, is not yet to be claimed as permanent, but it promises to become so ere long, unless the Republic becomes involved in European wars through Imperialism. Labor is in demand at the highest wages paid in the world; the industrial supremacy of the world lies at our feet. Two questions are submitted to the decision of the American people: first, Shall we remain as we are, solid, compact, impregnable, republican, American? or, second, Shall we creep under the protection, and become, as Bishop Potter says, the "cat's-paw" of Britain, in order that we may grasp the phantom of Imperialism.

21. If the latter be the choice, then it is submitted that we must first begin quietly to prepare ourselves for the new work which Imperialism imposes.

[Baha'i Comment](#)

--- Page 147. The Gospel of  
Wealth - VIII Americanism  
versus Imperialism

[Baha'i Comment](#)

22. We need a large regular army of trained soldiers. There is no use trying to encounter regular armies with volunteers we have found that out. Not that volunteers would not be superior to the class of men we shall get to enlist simply for pay in the regular army, if they would enlist there and be trained, but because they are not trained. Thirty-eight thousand more men are to be called for the regular army; but it is easy "to call spirits from the vasty deep"

*(8) Henry IV, Act iii, scene 1, line 54.*

- they may not come. The present force of the army is sixty-two thousand men by law; we have only fifty-six thousand, as the President tells us in his message. Why do we not first fill up the gap, instead of asking for legislation to enlist more? Because labor is well employed and men are scarce in some States to-day; because men who now enlist know for what they are wanted, and that kind of work is not what American soldiers have been asked to perform hitherto. They have never had

to leave their own country, much less to shoot down men whose only crime against the Republic was that they, too, like ourselves, desired their country's independence and believed in the Declaration of Independence-in Americanism. The President may not get the soldiers he desires, and whom he must have if he is not to make shipwreck of his Imperialism. There is very grave reason to doubt whether the army can be raised even to one hundred thousand men without a great advance in pay, perhaps not without conscription. But surely before we appear in the arena in the far East we must have a large regular army.

23. The second indispensable requirement is a navy corresponding, at least in some degree, to the navies of the other powers interested in the East. We can get this in twenty years, perhaps, if we push matters, but this means building twenty ships a year. The securing of men trained to man them will be as difficult a task as the building of the ships. When we have armed ourselves thus, but not till then,

--- Page 148. The Gospel of Wealth - VIII Americanism versus Imperialism

[Baha'i Comment](#)

shall we be in a position to take and hold territory in the far East "by the sole power of our unlorded will," as we should hold it, or not hold it at all. To rush in now, without army or navy, trusting to the treacherous shifting foundation of anybody's "protection," or "neutrality," or "alliance," is to court defeat, and such humiliation as has rarely fallen to the lot of any nation, even the poorest and most madly or most foolishly governed. It is not good sense.

24. This ends the subject upon which I undertook to write, but there remains the practical question, What shall we do with the Philippines? These are not ours, unless the Senate approves the treaty; but, assuming that it will, that question arises.

#### **Philippines - synopsis of history**

The islands were named for King Philip II [Son of Charles V] of Spain and were illegally ceded by Spain [along with Guam, Cuba and Puerto Rico] to the U.S. for 20 Million Dollars following the Spanish-American War in 1898. U.S. troops suppressed a guerrilla uprising in a brutal 6-year war from 1899-1905.

In 1934, the U.S. Congress passed an act which made the Phillipines a U.S. Commonwealth. On December 8, 1941, Japan occupied the islands during WWII. On July 4, 1946, independence was proclaimed in accordance with an act passed by congress by the U.S. Congress in 1934. A republic was established and Manuel Roxas became the President of the Republic of the Phillipines.

[http://www.puc.edu/Faculty/Milbert\\_Mariano/MANO/history.html](http://www.puc.edu/Faculty/Milbert_Mariano/MANO/history.html)

25. The question can best be answered by asking another: What have we promised to do with Cuba? The cases are as nearly parallel as similar cases usually are. We drove Spain out of both Cuba and the Philippines. Our ships lie in the harbors of both. Our flag waves over both. To Cuba the President in his message renews the pledge given by Congress - she is to be aided to form a "free and independent government at the earliest possible moment."

[Baha'i Comment](#)

26. The magic words "free and independent" will be accepted by the people of Cuba, and our soldiers hailed as deliverers. So well assured of this is our government that only one half the number of troops intended for Cuba are now to be sent there.

[Baha'i Comment](#)

27. Even if we were tempted to play false to our pledge, as the enemies of the Republic in Europe predict we shall, the aspirations of a people for independence are seldom quenched. There are a great number of Americans, and these of the best, who would soon revolt at our soldiers being used against the Cubans fighting for what they had been promised. The latest advices I have from Cuba are

**“...mark my prediction, she (Cuba) will ask for annexation.”**

Cuba never did ask for annexation. In fact the twentieth century saw this island struggle to become as independent as possible from the United States.

**“There is no Imperialism here (Cuba) - no danger of foreign wars.”**

October 22, 1962 - President Kennedy announces to the world that the Soviet Union has deployed nuclear missiles in Cuba. This incident brings the world to the brink of nuclear war. Five days later the Cuban Missile Crisis is resolved with the Soviet Union agreeing to remove its missiles from Cuba and the US agreeing not to invade Cuba and to remove US missiles from Turkey. However the incident



from a good source. This necessity is not likely to arise. Cuba will soon form a government, and, mark my prediction, she will ask for

--- Page 149. The Gospel of Wealth - VIII Americanism versus Imperialism

annexation. The proprietors of Cuba who will control the new government, and many Americans who are becoming interested with them in estates there, will see to this. "Free sugar" means fortune to all. Will the United States admit Cuba? Doubtful. But Cuba need not trouble us very much. There is no Imperialism here - no danger of foreign wars.

results in cementing a relationship between the Soviet Union and Cuba that lasts nearly 30 years and injects over \$100 billion of Soviet aid and loans into Cuba.

<http://www.uscubacommission.org/history4.html>

28. Now, why is the policy adopted for the island of Cuba not the right policy for the Philippine Islands? General Schofield

*(9) John McAllister Schofield (1831-1906), Superintendent of the United States Military Academy (1876-1881), commanding general of the army (1895), and noted, among other things, for his part in the acquisition of Pearl Harbor by the United States.*

states that thirty thousand troops will be required there, as we may have to "lick them." What work this for Americans! General Miles

Baha'i Comment

*(10) Nelson Appleton Miles (1839-1925), succeeded to Schofield's position in 1895. He was active in the Spanish-American War and afterwards.*

thinks twenty-five thousand will do. If we promised them what we have promised Cuba, half the number would suffice, as with Cuba, - probably less, and we should be spared the uncongenial task of shooting down people who are guiltless of offense against us.

29. If we insist "the slaves are ours because we bought them," and fail to tell them we come not as slave-drivers, but as friends to assist them to independence, we may have to "lick them," no doubt. It will say much for the Filipinos if they do rebel against "being bought and sold like cattle." It would be difficult to give a better proof of their fitness for self-government.

slavery

"It is forbidden you to trade in slaves, be they men or women. It is not for him who is himself a servant to buy another of God's servants, and this hath been prohibited in His Holy Tablet. Thus, by His mercy, hath the commandment been recorded by the Pen of justice. Let no man exalt himself above another; all are but bondslaves before the Lord, and all exemplify the truth that there is none other God but Him. He, verily, is the All Wise, Whose wisdom encompasseth all things." (Baha'u'llah, The Kitab-i-Aqdas, p. 45)

Also Baha'u'llah revealed the following to Queen Victoria of England

"We have been informed that thou hast forbidden the trading in slaves, both men and women. This, verily, is what God hath enjoined in this wondrous Revelation." (Baha'u'llah, Epistle to the Son of the Wolf, p. 60)

30. Cuba is under the shield of the Monroe Doctrine; no foreign interference is possible there. Place the Philippines under similar conditions until they have a stable government, when eight millions of people can be trusted to protect themselves. The truth is that none of the powers would risk the hostility of eight millions of people who had tasted the hope of independence. "Free and independent" are magical words, never forgotten, and rarely unrealized.

### Monroe Doctrine

This was a principle of American foreign policy enunciated in President James Monroe's message to Congress, Dec. 2, 1823. It initially called for an end to European intervention in the Americas, but it was later extended to justify U.S. imperialism in the Western Hemisphere.

--- Page 150. The Gospel of Wealth - VIII Americanism versus Imperialism

31. Only one objection can be made to this policy: they are not fit to govern themselves. First, this has not been proved. This was said of every one of the sixteen Spanish republics as they broke away from Spain; it was said even of Mexico within this generation; it was the belief of the British about ourselves. There is, in the writer's opinion, little force in the objection. In the far East I have visited the village communities in India, to find even there a system of self-government dating back for two thousand years. In no country, not even the most

### Baha'i Comment

backward, are government and "orders and degrees" of men not to be found. The head men of tribes and others of lesser authority are often selected by the members. In the wild lands of the Afridis - a tribe in India which has just baffled seventy thousand soldiers, native and British, the largest army ever assembled there-there is a system of self-government, and a rigid one. Human societies cannot exist without establishing, as a rule, peace and order in greater or less perfection.

32. The Filipinos are by no means in the lowest scale - far from it; nor are they much lower than the Cubans. If left to themselves they will make mistakes, but what nation does not? Riot and bloodshed may break out -- in which nation are these absent? Certainly not in our own. But the inevitable result will be a government better suited to the people than any that our soldiers and their officers could ever give.

bloodshed

“Consider how discord and dissension have prevailed in this great human family for thousands of years. Its members have ever been engaged in war and bloodshed. Up to the present time in history the world of humanity has neither attained nor enjoyed any measure of peace, owing to incessant conditions of hostility and strife. History is a continuous and consecutive record of warfare brought about by religious, sectarian, racial, patriotic and political causes. The world of humanity has found no rest. Mankind has always been in conflict, engaged in destroying the foundations, pillaging the properties and possessing the lands and territory of each other, especially in the earlier periods of savagery and barbarism where whole races and peoples were carried away captive by their conquerors. Who shall measure or estimate the tremendous destruction of human life resulting from this hostility and strife? What human powers and forces have been employed in the prosecution of war and applied to inhuman purposes of battle and bloodshed? In this most radiant century it has become necessary to divert these energies and utilize them in other directions, to seek the new path of fellowship and unity, to unlearn the science of war and devote supreme human forces to the blessed arts of peace. After long trial and experience we are convinced of the harmful and satanic outcomes of dissension; now we must seek after means by which the benefits of agreement and concord may be enjoyed. When such means are found, we must give them a trial.” (Abdu’l-Baha [1912]: The Promulgation Of Universal Peace, p.229)

33. Thus only can the Republic stand true to its pledge that the sword was drawn only in the cause of humanity and not for territorial aggrandizement, and true to the fundamental principles upon which it rests: that "government derives its just powers from the consent of the governed"; that the flag, wherever it floats, shall proclaim "the equality of the citizen," "one man's privilege every man's right"; that "all men are created equal," not that under its sway a part only shall be citizens with rights and a part subjects without rights - freemen and serfs, not all freemen. Such is the issue between Americanism and Imperialism.

**"the sword was drawn only in the cause of humanity"**

"O Rulers of America and the Presidents of the Republics therein... Bind ye the broken with the hands of justice, and crush the oppressor who flourisheth with the rod of the commandments of your Lord, the Ordainer, the All-Wise.

The time must come when the imperative necessity for the holding of a vast, an all-embracing assemblage of men will be universally realized. The rulers and kings of the earth must needs attend it, and, participating in its deliberations, must consider such ways and means as will lay the foundations of the world's Great Peace amongst men. Such a peace demandeth that the Great Powers should resolve, for the sake of the tranquillity of the peoples of the earth, to be fully reconciled among themselves. Should any king take up arms against another, all should unitedly arise and prevent him. If this be done, the nations of the world will no longer require any armaments, except for the purpose of preserving the security of their realms and of maintaining internal order within their territories. This will ensure the peace and composure of every people, government and nation." (Baha'u'llah [1863-1892]: Gleanings From The Writings Of Baha'u'llah, p.249)

**"government derives its just powers from the consent of the governed"**

In contrast to this principle, in the Baha'i Faith, the governors are directly responsible to God rather than the governed. The current "Spiritual Assemblies" -- an appellation that must in the course of time be replaced by their permanent and more descriptive title of "Houses of Justice," are "invested with an authority rendering them unanswerable for their acts and decisions to those who elect them; solemnly pledged to follow, under all conditions, the dictates of the "Most Great Justice" that can alone usher in the reign of the "Most Great Peace" which Baha'u'llah has proclaimed and must ultimately establish;" (Shoghi Effendi [1944], "God Passes By", p.33)

**"the equality of the citizen"**

While this is a praiseworthy aspiration, the United States has had problems with this on its soil. The "equality of the white citizen" would be perhaps a more accurate description of the United States at this time. Although Carnegie praises the high ideals of Americanism, he fails to acknowledge the brutal Imperialism of the United States to destroy the American Indian. He fails to point out the second class citizenship of the American Negro.

"No less serious is the stress and strain imposed on the fabric of American society through the fundamental and persistent neglect, by the governed and governors alike, of the supreme, the inescapable and urgent duty -- so repeatedly and graphically represented and stressed by Abdu'l-Baha in His arraignment of the basic weaknesses in the social fabric of the nation -- of remedying, while there is yet time, through a revolutionary change in the concept and attitude of the average white American toward his Negro fellow citizen, a situation which, if allowed to drift, will, in the words of Abdu'l-Baha, cause the streets of American cities to run with blood, aggravating thereby the havoc which the fearful weapons of destruction, raining from the air, and amassed by a ruthless, a vigilant, a powerful and inveterate enemy, will wreak upon those same cities." (Shoghi Effendi [1947-1957]: Citadel of Faith, p.126)

On the other hand, Abdu'l-Baha praises the efforts made by America is the arena of the emancipation of the Negro.

"But I wish to say one thing in order that the blacks may become grateful to the whites and the whites become loving toward the blacks. If you go to Africa and see the blacks of Africa, you will realize how much progress you have made. Praise be to God! You are like the whites; there are no great distinctions left. But the blacks of Africa are treated as servants. The first proclamation of emancipation for the blacks was made by the whites of America. How they fought and sacrificed until they freed the blacks! Then it spread to other places. The blacks of Africa were in complete bondage, but your emancipation led to their freedom also--that is, the European states emulated the Americans, and the emancipation proclamation became universal. It was for your sake that the whites of America made such an effort. Were it not for this effort, universal emancipation would not have been proclaimed. Therefore, you must be very grateful to the whites of America, and the whites must become very loving toward you so that you may progress in all human grades. Strive jointly to make extraordinary progress and mix together completely. In short, you must be very thankful to the whites who were the cause of your freedom in America. Had you not been freed, other blacks would not have been freed either. Now--praise be to God!--everyone is free and lives in tranquillity. I pray that you attain to such a degree of good character and behavior that the names of black and white shall vanish. All shall be called human, just as the name for a flight of doves is dove. They are not called black and white. Likewise with other birds." (Abdu'l-Bahá [1912], Promulgation Universal Peace, pp.45-46)

**"all men are created equal"**

"O CHILDREN OF MEN! Know ye not why We created you all

from the same dust? That no one should exalt himself over the other. Ponder at all times in your hearts how ye were created. Since We have created you all from one same substance it is incumbent on you to be even as one soul, to walk with the same feet, eat with the same mouth and dwell in the same land, that from your inmost being, by your deeds and actions, the signs of oneness and the essence of detachment may be made manifest. Such is My counsel to you, O concourse of light! Heed ye this counsel that ye may obtain the fruit of holiness from the tree of wondrous glory.” (Baha’u’llah [1862-1863]: Hidden Words of Baha’u’llah, p.20)

### imperialism

“From darkest Africa the first stirrings of a conscious and determined revolt against the aims and methods of political and economic imperialism can be increasingly discerned, adding their share to the growing vicissitudes of a troubled age. Not even America, which until very recently prided itself on its traditional policy of aloofness and the self-contained character of its economy, the invulnerability of its institutions and the evidences of its growing prosperity and prestige, has been able to resist the impelling forces that have swept her into the vortex of an economic hurricane that now threatens to impair the basis of her own industrial and economic life. Even far-away Australia, which, owing to its remoteness from the storm-centers of Europe, would have been expected to be immune from the trials and torments of an ailing continent, has been caught in this whirlpool of passion and strife, impotent to extricate herself from their ensnaring influence.” (Shoghi Effendi, The World Order of Baha'u'llah, p. 31)

**MENU: [HOME](#) » [Reconstruction](#) » [Gospel Content](#) » [Gospel Purpose](#)**

# The Gospel of Wealth

And Other Timely Essays

by Andrew Carnegie

**In the right-hand commentary column,  
that which is in GREEN is a commentator's remark and  
that which is in BLUE is from the Baha'i Writings.  
On occasion, in that column, there may be a [link](#) to an extended comment or  
dissertation on the subject under discussion.**

- -

***A reminder that under "view" on your browser - you can set the text size UP  
or DOWN for a more comfortable read for yourself.***

--- Page 151. The Gospel of Wealth - VIII Americanism versus Imperialism

## VIII

### Americanism Versus Imperialism

#### Part II

34. In the January number of the *Review* I dealt with the danger of foreign wars and entanglements as one of several grave reasons against departing from the past policy of the Republic, which has kept it solid and compact upon its own continent, to undertake the subjection and government of subject races in the tropics. I now propose to consider one of the reasons given for such departure - the only one remaining which retains much vitality, for the

[Baha'i Comment](#)



two other reasons once so prominent have already faded away and now are scarcely ever urged. These were "commercial expansion" in peace and "increased power" in war. The President killed the first when compelled by Great Britain to give the "open door" as the price for her support; for to give the "open door" to the nearer foreigner meant the "closed door" to the products of the soil and mines of his own country. There never was and never can be any trade worth quarreling about in the Philippines; but what little there is or can be he has given away. When the country saw Dewey's fleet provisioned from Australia, instead of from our own agricultural land, the claim of possible expansion of American commerce there fell to the ground.

35. The second claim, that the Republic as a war power would be strengthened, held the field even for a shorter period than that of commercial expansion, for it was obvious that distant possessions would only give to our enemies, during war, vulnerable points of attack which had hitherto been wanting. As one solid mass, without outlying possessions, the Republic is practically

[Baha'i Comment](#)

unassailable. Should she keep the Philippines, any one of the great naval powers has her at its mercy. Hence Admiral Sampson

*(11) William Thompson Sampson (1840-1902), squadron commander in the Spanish-American war.*

warned us but a few days ago that "our risks of and dangers from war had already increased a hundred per cent and that we needed to double our navy." The

--- Page 152. The Gospel of Wealth - VIII Americanism versus Imperialism

President has just asked that our army also be doubled.

36. Thus the claims of "commercial expansion" in peace and of "increased power" in war have bled to death of themselves.

[Baha'i Comment](#)

37. There remains to-day, as the one vital element of Imperialism, the contention that Providence has opened for the American people a new and larger destiny, which imposes heavy burdens indeed upon them, but from which they cannot shrink without evading holy duty; that it has become their sacred task to undertake the civilization of a backward people committed to their charge. A foundling has been left at their door, which it is their duty to adopt, educate, and govern. In a word, it is "Humanity," "Duty," "Destiny," which call upon us again for sacrifice. These potent cries, which brought us to the drawing of the sword for oppressed Cuba, are now calling us to a more difficult task, and hence to a greater "duty."

### ...a new and larger destiny

Carnegie here is referring to "Manifest Destiny."

"...tenet holding that territorial expansion of the United States is not only inevitable but divinely ordained. The phrase was first used by the American journalist and diplomat John Louis O'Sullivan, in an editorial supporting annexation of Texas, in the July-August 1845 edition of the United States Magazine and Democratic Review, a magazine that featured literature and nationalist opinion. The phrase was later used by expansionists in all political parties to justify the acquisition of California, the Oregon Territory, and Alaska. By the end of the 19th century the doctrine was being applied to the proposed annexation of various islands in the Caribbean Sea and the Pacific Ocean."

<http://encarta.msn.com/find/Concise.asp?ti=04198000>

**holy duty ...their (United States) sacred task to undertake the civilization of a backward people committed to their charge.**

In a review of the twentieth century, the Baha'i authored document "Century of Light," discusses this serious matter of expansion in the "Name of God."

"These masses of humankind, despoiled and scorned - but representing most of the earth's inhabitants - were seen not as protagonists but essentially as objects of the new century's much vaunted civilizing process. Despite benefits conferred on a minority among them, the colonial peoples existed chiefly to be acted upon - to be used, trained, exploited, Christianized, civilized, mobilized - as the shifting agendas of Western powers dictated. These agendas may have been harsh or mild in execution, enlightened or selfish, evangelical or exploitative, but were shaped by materialistic forces that determined both their means and most of their ends. To a large extent, religious and political pieties of various kinds masked both ends and means from the publics in Western lands, who were thus able to derive moral satisfaction from the blessings their nations were assumed to be conferring on less worthy peoples, while themselves enjoying the material fruits of this benevolence." (Baha'i World Centre [2001], Century of Light, 2001, p.4)

### Civilization

Today throughout the five continents of the globe it is Europe and most sections of America that are renowned for law and order, government and commerce, art and industry, science, philosophy

and education. Yet in ancient times these were the most savage of the world's peoples, the most ignorant and brutish. They were even stigmatized as barbarians--that is, utterly rude and uncivilized. Further, from the fifth century after Christ until the fifteenth, that period defined as the Middle Ages, such terrible struggles and fierce upheavals, such ruthless encounters and horrifying acts, were the rule among the peoples of Europe, that the Europeans rightly describe those ten centuries as the Dark Ages. The basis of Europe's progress and civilization was actually laid in the fifteenth century of the Christian era, and from that time on, all her present evident culture has been, under the stimulus of great minds and as a result of the expansion of the frontiers of knowledge and the exertion of energetic and ambitious efforts, in the process of development. (Abdu'l-Baha, *The Secret of Divine Civilization*, p.10)

Until the heavenly civilization is founded, no result will be forthcoming from material civilization, even as you observe. See what catastrophes overwhelm mankind. Consider the wars which disturb the world. Consider the enmity and hatred. The existence of these wars and conditions indicates and proves that the heavenly civilization has not yet been established. If the civilization of the Kingdom be spread to all the nations, this dust of disagreement will be dispelled, these clouds will pass away, and the Sun of Reality in its greatest effulgence and glory will shine upon mankind. (Abdu'l-Baha [1912], *The Promulgation Of Universal Peace*, p.96)

All are human beings. Why have the people of America advanced to a high degree of civilization while the tribes of central Africa remain in extreme ignorance and barbarism? The difference and distinction between them is the degree of education. This is unquestioned. The people of Europe and America have been uplifted by education and training from the world of defects and have ascended toward the realm of perfection, whereas the people of Africa, denied educational development, remain in a natural condition of illiteracy and deprivation, for nature is incomplete and defective. Education is a necessity. If a piece of ground be left in its natural and original state, it will either become a thorny waste or be covered by worthless weeds. When cleared and cultivated, this same unproductive field will yield plentiful harvests of food for human sustenance. (Abdu'l-Baha [1912], *The Promulgation Of Universal Peace*, p.329)

### **Destiny of America**

“Among some of the most momentous and thought-provoking pronouncements ever made by Abdu'l-Baha, in the course of His epoch-making travels in the North American continent, are the following: "May this American Democracy be the first nation to establish the foundation of international agreement. May it be the first nation to proclaim the unity of mankind. May it be the first to

unfurl the Standard of the Most Great Peace." And again: "The American people are indeed worthy of being the first to build the Tabernacle of the Great Peace, and proclaim the oneness of mankind.... For America hath developed powers and capacities greater and more wonderful than other nations.... The American nation is equipped and empowered to accomplish that which will adorn the pages of history, to become the envy of the world, and be blest in both the East and the West for the triumph of its people. ...The American continent gives signs and evidences of very great advancement. Its future is even more promising, for its influence and illumination are far-reaching. It will lead all nations spiritually."

The creative energies, mysteriously generated by the first stirrings of the embryonic World Order of Baha'u'llah, have, as soon as released within a nation destined to become its cradle and champion, endowed that nation with the worthiness, and invested it with the powers and capacities, and equipped it spiritually, to play the part foreshadowed in these prophetic words. The potencies which this God-given mission has infused into its people are, on the one hand, beginning to be manifested through the conscious efforts and the nationwide accomplishments, in both the teaching and administrative spheres of Baha'i activity, of the organized community of the followers of Baha'u'llah in the North American continent. These same potencies, apart from, yet collateral with these efforts and accomplishments, are, on the other hand, insensibly shaping, under the impact of the world political and economic forces, the destiny of that nation, and are influencing the lives and actions of both its government and its people.

To the efforts and accomplishments of those who, aware of the Revelation of Baha'u'llah, are now laboring in that continent, to their present and future course of activity, I have, in the foregoing pages sufficiently referred. A word, if the destiny of the American people, in its entirety, is to be correctly apprehended, should now be said regarding the orientation of that nation as a whole, and the trend of the affairs of its people. For no matter how ignorant of the Source from which those directing energies proceed, and however slow and laborious the process, it is becoming increasingly evident that the nation as a whole, whether through the agency of its government or otherwise, is gravitating, under the influence of forces that it can neither comprehend nor control, towards such associations and policies, wherein, as indicated by Abdu'l-Baha, her true destiny must lie. Both the community of the American believers, who are aware of that Source, and the great mass of their countrymen, who have not as yet recognized the Hand that directs their destiny, are contributing, each in its own way, to the realization of the hopes, and the fulfillment of the promises, voiced in the above-quoted words of Abdu'l-Baha. (Shoghi Effendi [1938], *The Advent Of Divine Justice*, pp.85-87)

38. It is encouraging to those who hold to Americanism that the chief strength of the imperialistic movement calling upon us to depart from our republican ideals, rests upon no ignoble foundation to-day. It is not the desire of gain, as our European critics assert, nor the desire of military glory, which gives vitality to the strange outburst for expansion and the proposed holding of alien races in subjection for their good. The average American, especially in the West, really believes that his country can govern these tropical people, and benefit them by so doing; he considers it a duty not to evade a task which, as he sees it, Providence has clearly imposed upon his country. The writer knows that the cynics, both at home and abroad, but especially the latter, will smile at this statement; but the extent of the ignorance of the American people in general, except in the South, about subject races and tropical conditions, cannot be realized by Europeans. This ignorance is truly as great as their belief implies. Their lack of knowledge is at fault, but the greater this lack the clearer is it that they can be credited with absolute sincerity,

### Problem of Race

From the Baha'i perspective, racism is one of the most baneful and persistent evils in society. Racial discrimination is baneful because it violates the dignity of human beings. And yet it persists. Racism is poisonous because it cripples its victims, corrupts its perpetrators, and blights human progress. And yet it persists. Why? We believe that racism persists precisely because it is deeply rooted in outdated attitudes and erroneous beliefs.

Accordingly, any campaign to eradicate racism must change those attitudes and beliefs. Although necessary, political action alone cannot offer a permanent solution. In the Baha'i view, racism will be eliminated only when the peoples of the world are convinced of the oneness of humankind and proceed to reconstruct their lives and their societies on that basis.

The recognition of the oneness of mankind would require the abandonment of all doctrines of superiority, many of which still persist implicitly despite our preoccupation with its more obvious forms such as apartheid. More importantly, by establishing the foundation for true co-operation, the recognition of this principle would raise civilization to a new level. At this higher level, no one need fear oppression, even those who were formerly oppressors. The sharing of power and responsibility among all citizens can then be implemented without fear, through appropriate legal measures and equitable social and economic policies.

(Baha'i International Community [1989], Statement to the forty-fifth session of the United Nations Commission on Human Rights)

--- Page 153. The Gospel of Wealth - VIII Americanism versus Imperialism

and with those very dangerous things when possessed without knowledge, "good intentions." The people of the South, who have knowledge of the problems of race, are with rare unanimity opposed to further accretions, and see it to be a "holy duty" to keep our Republic from further dangers arising from racial differences.

39. Our national history has not been such as to give our people experience in dealing with this new and essentially foreign question, but the American democracy has displayed in all national crises a highly creditable sensitiveness to the moral features of every issue presented. The deciding voice has been that of those who stood for what made toward its abolition until the issue was placed upon high moral grounds. In the issue of secession, patriotism played the first part, but the enthusiasm of the nation was greatly quickened the moment it became a question of the emancipation of the slaves. Even in the recent issue, when the debasement of the standard of value was

### Democracy

Question: Is it not a fact that universal peace cannot be accomplished until there is political democracy in all the countries of the world?

Answer: It is very evident that in the future there shall be no centralization in the countries of the world, be they constitutional in government, republican or democratic in form. The United States may be held up as the example of future government--that is to say, each province will be independent in itself, but there will be federal union protecting the interests of the various independent states. It may not be a republican or a democratic form. To cast aside centralization which promotes despotism is the exigency of the time. This will be productive of international peace. Another fact of equal importance in bringing about international peace is woman's suffrage. That is to say, when perfect equality shall be established between men and women, peace may be realized for the simple reason that womankind in general will never favor warfare. Women will not be willing to allow those whom they have so tenderly cared for to go to the battlefield. When they shall have a vote, they will oppose any cause of warfare. Another factor which will bring about universal peace is the linking together of the Orient and the Occident. (Abdu'l-Baha [1912], *The Promulgation Of Universal Peace*, p.167)

...unlike the paramount principle of democracy by which the elected are constantly responsible to the electors, Baha'i bodies are responsible at all times to the Founder of their Faith and His

proposed, those who stood for the maintenance of the high standard found their strongest weapon when they placed before the people the moral side of the question, and argued that debts contracted in gold should be paid in gold; that the savings of the people deposited in banks in gold should be so repaid; and that the soldiers' pensions should be paid in money equal to any. The justice of the matter, what was right, what was fair, -- in other words, the moral side of the question, - was potent in determining the decision.

teachings. Whereas in democracy the ruling factor at the top can go no higher than their own councils and their decisions are subject to the scrutiny and approval of those they represent, this ruling factor in the Cause of God is at once the servant of all the servants of God - in other words the body of the faithful - but responsible to a higher factor, divinely guided and inspired, the Guardian or sole interpreter, and the Universal House of Justice, the supreme elected body, or sole legislator. It will be seen that in this system the people, divorced from the corrupt influences of nomination, political canvassing and the violence of those whims and dissatisfactions so easily engendered in the masses by the working of the democratic principle alone, are free to choose those they deem best qualified to direct their affairs and safeguard their rights on the one hand, and to protect and serve the interests of the Cause of God on the other.

The elected Baha'i bodies might be likened to a great network of irrigation pipes, selected and put together by the people for their own benefit. but life-giving waters from on high flow through this system, independent of the people, independent of any will of the pipes, and this water is the divinely guided and inspired counsels of the Guardian and the Supreme Body of the Cause, which they receive, in this Baha'i dispensation, from no less a source than the twin Manifestations of God. The system of Baha'u'llah, Shoghi Effendi wrote, "cannot ever degenerate into any form of despotism, of oligarchy, or of demagoguery which must sooner or later corrupt the machinery of all man-made and essentially defective political institutions." (Ruhyyih Khanum [1969], *The Priceless Pearl*, p.349)

### **Moral Laxity**

The steady and alarming deterioration in the standard of morality as exemplified by the appalling increase of crime, by political corruption in ever widening and ever higher circles, by the loosening of the sacred ties of marriage, by the inordinate craving for pleasure and diversion, and by the marked and progressive slackening of parental control, is no doubt the most arresting and distressing aspect of the decline that has set in, and can be clearly perceived, in the fortunes of the entire nation. (Shoghi Effendi, *Citadel of Faith*, p. 124)



40. We hear much of the decline of the pulpit in our day, and upon theological questions and dogmas its influence cannot be what it once was. Yet, as far as our country is concerned, I should say that the power of the pulpit upon all moral questions has gained as much as it has lost upon theological issues. It is not less powerful to-day in this domain of the Republic than in Scotland, and far more so than in any other English-speaking country. In such questions its voice has been potent when decisively pronounced upon one side or

--- Page 154. The Gospel of Wealth - VIII Americanism versus Imperialism

the other, as it generally has been; but in regard to Imperialism it has been divided. Bishop Potter, Dr. van Dyke, Dr. Cuyler, Dr. Parkhurst, Dr. Eaton, and others equally prominent stand firmly against it. On the other hand, Bishop Doane, Dr. Lyman Abbott, and others have taken the opposite view, but solely from the standpoint of the good of the subject races, not in the slightest degree for our own advantage.

*(12) Carnegie here calls the roll of divines, most of whom were*

### Decline of the Pulpit

The Pen of the Divine Expounder exhorteth, at this moment, the manifestations of authority and the sources of power, namely the kings and rulers of the earth--may God assist them--and enjoine them to uphold the cause of religion, and to cleave unto it. Religion is, verily, the chief instrument for the establishment of order in the world, and of tranquillity amongst its peoples. The weakening of the pillars of religion hath strengthened the foolish, and emboldened them, and made them more arrogant. Verily I say: The greater the decline of religion, the more grievous the waywardness of the ungodly. This cannot but lead in the end to chaos and confusion. Hear Me, O men of insight, and be warned, ye who are endued with discernment! (Baha'u'llah [1873-1892], Tablets Of Baha'u'llah Revealed After The Kitab-i-Aqdas, pp.63-64)

...the realm of the religionist has gradually narrowed and darkened, and the sphere of the materialist has widened and advanced; for the religionist has held to imitation and counterfeit, neglecting and discarding holiness and the sacred reality of religion. When the sun sets, it is the time for bats to fly. They come forth because they are creatures of the night. When the lights of religion become darkened, the materialists appear. They are the bats of night. The decline of religion is their time of activity; they seek the shadows when the world is darkened and clouds have spread over it.

Baha'u'llah has risen from the eastern horizon. Like the glory of the sun He has come into the world. He has reflected the reality of divine religion, dispelled the darkness of imitations, laid the foundation of new teachings and resuscitated the world. (Abdu'l-Baha [1912], The Promulgation Of Universal Peace, pp.179-180)

**Due to theological questions and dogmas its influence (Religion) cannot be what it once was**

The beginnings of all great religions were pure; but priests, taking possession of the minds of the people, filled them with dogmas and superstitions, so that religion became gradually corrupt. (Abdu'l-Baha [1911], Abdu'l-Baha in London, p.125)

Many religious leaders have grown to think that the importance of religion lies mainly in the adherence to a collection of certain dogmas and the practice of rites and ceremonies! Those whose souls they profess to cure are taught to believe likewise, and these cling tenaciously to the outward forms, confusing them with the inward truth.

Now, these forms and rituals differ in the various churches and

*conspicuous in the Anti-Imperialist League, a spontaneous uprising of intellectuals against "imperialism." At least three were "first citizens of New York City. Henry C. Potter (1835-1908), Episcopalian bishop of New York, a clerical and social liberal and leader in the fight against municipal corruption; Henry Van Dyke (1852-1935), Princeton graduate and pastor of the Brick Presbyterian Church, a fabulous preacher and teacher, a literary man and self-styled "adventurous conservative"; and Charles Henry Parkhurst (1842-1933), pastor of the Madison Square Presbyterian Church, whose blistering sermon (1892) on the alliance between politicians and vice forced him to collect the evidence and brought on the Lexow Investigation (1894) which led to the defeat of Tammany Hall. Theodore Ledyard Cuyler (1822-1909), Princeton graduate, was pastor in the Lafayette Avenue Presbyterian Church, Brooklyn, and a conservative in theology. Homer Eaton (1834-1913) after 1889 was Secretary of the Methodist Book Concern in New York and Treasurer of the denomination's Board of Foreign Missions. The deviant divines were W. C. Doane (1832-1913), first Bishop of the Protestant Episcopal Diocese of Albany, a high churchman with gifts as an administrator; and Lyman Abbott (1835-1922), Congregationalist pastor of the Plymouth Church (Henry W. Beecher's Church) in Brooklyn during the nineties, editor of the Outlook--the new name (1893) of the Christian Union -- and a reconciler of evolution and historic Christianity. Abbott later became a zealous apostle of Theodore Roosevelt.*

**This view, and this alone, is what gives Imperialism most of its remaining vitality.**

amongst the different sects, and even contradict one another; giving rise to discord, hatred, and disunion. The outcome of all this dissension is the belief of many cultured men that religion and science are contradictory terms, that religion needs no powers of reflection, and should in no wise be regulated by science, but must of necessity be opposed, the one to the other. The unfortunate effect of this is that science has drifted apart from religion, and religion has become a mere blind and more or less apathetic following of the precepts of certain religious teachers, who insist on their own favourite dogmas being accepted even when they are contrary to science. This is foolishness, for it is quite evident that science is the light, and, being so, religion truly so-called does not oppose knowledge. (Abdu'l-Baha [1911], Paris Talks, pp.143-144)

## 41. Here is the essence of the whole matter given by Professor Alden

*(13) Raymond M. Alden (1873-1924), later professor at the University of Illinois and at Stanford.*

### of the University of Pennsylvania:

Apropos of the missionary argument for expansion, the clergyman under whose ministry I sat last Sunday offered the following petition on behalf of the Filipinos:

"We pray thee that those who prefer to remain in darkness, and are even willing to fight in order to do so, may, whether willingly or unwillingly, be brought into the light."

Instantly there came to my mind the naive remark of the pious

--- Page 155. The Gospel of Wealth - VIII Americanism versus Imperialism

author of the "Chanson de Roland," in describing one of the victories of Charlemagne over the Mussulmans:

"...willingly or unwillingly, be brought into the light" and also

"There was not a pagan left in the city who was not either killed or made a Christian."

There is really no justification in all the religious teachings that justify force or compulsion in advancing your religious beliefs. No doubt some who have conquered in the "Name of God" probably earnestly felt they were doing "God's Will." It's interesting to not how many of these colonial powers "justified" their Imperialism by getting the blessings of the Church. Thus they could derive moral satisfaction and at the same time garner land and wealth. They really could "have their cake, and eat it too" - so to speak. The Eagles phrased it in a song -

We satisfy our endless needs and justify our bloody deeds.  
In the name of destiny and in the name of God.  
(The Eagles, The Last Resort)

Do not quarrel with anybody, and shun every form of dispute. Utter the Word of God. If he accepteth it the desired purpose is attained, and if he turneth away leave him to himself and trust to God. (Abdu'l-Baha, Selections from the Writings of Abdu'l-Baha, p. 210)

Let there be no compulsion in Religion. Now is the right way made distinct from error. (The Qur'an (Rodwell tr), Sura 2 - The Cow)

For it is impossible to keep the Law without Christ, though man may, for the sake of honor or property, or from fear of punishment, feign outward holiness. The heart which does not discern God's grace in Christ cannot turn to God nor trust in him; it cannot love his commandments and delight in them, but rather resists them. For nature rebels at compulsion (Sermons of Martin Luther, Twofold Use of Law & Gospel, Letter and Spirit)

En la citet nen at  
remes paien  
Ne seit ocis, o  
devient crestiens.

That is to say: "There was not a pagan left in the city who was not either killed or made a Christian." So may it be in Manila, when a similar dilemma is prepared for its inhabitants.

42. Bishop Doane is the most prominent representative of the religious world who upholds the missionary view, and he would probably hesitate to push it to its logical conclusion, as his less known ministerial adherent does. The Bishop gives the argument of "Duty" in the following:

Bishop Doane says that precedent seems to indicate that both by the inherent national right of sovereignty and under the existing Constitution we can provide for the government of the people whom we have rescued, but that if this supposition shall be found untrue, "then we must remember that, in the emergency, national life and duty are more

If priests of religion really adored the God of love and served the Divine Light, they would teach their people to keep the chief Commandment, 'To be in love and charity with all men'. But we find the contrary, for it is often the priests who encourage nations to fight. Religious hatred is ever the most cruel! (Abdu'l-Baha, Paris Talks, p. 147)

important than the letter of a document, and that the Constitution, not being, as some people seem to think it, a close and final revelation of God, can be amended.

... No difficulties and no anxieties can alter the facts or change the situation or put back the advancing movement of God's will, which tends to the final substitution of the civilization, the liberty, and the religion of English-speaking people for the lost domination of the Latin races and the Latin religion. God has called the people in America to be his instruments in a movement perhaps even greater in its consequences than the Reformation in England or the liberation of Italy or the unification of Germany, and in the spirit of dependence on Him, with the quiet courage of patient faith, we must rise to the duty of the hour."

43. It is with the view Bishop Doane presents that we anti-Imperialists have to deal, not with spouting party politicians waving the flag, and descending to clap-trap phrases to "split the ears of the groundlings." In the Bishop's words we see some reason for the charge sometimes made against ecclesiastics, viz., that, their attention being chiefly fixed upon the other world, they seldom shine as advisers upon affairs pertaining to this. The Bishop's remedy for overcoming constitutional obstacles, for instance, is easily sug-

--- Page 156. The Gospel of Wealth - VIII Americanism versus Imperialism

gested; but such an amendment to the Constitution is impossible, since upon this question all the Southern States are attached to its present provisions, and against "rescuing" and governing subject races by force. Having in their own land some experience of race problems of which the North and West are ignorant, they stand for the old Americanism. Then, again, the Bishop reveals to us "God's will," which, he informs us, "tends to the final

## Liberty

That which beseemeth man is submission unto such restraints as will protect him from his own ignorance, and guard him against the harm of the mischief-maker. Liberty causeth man to overstep the bounds of propriety, and to infringe on the dignity of his station. It debaseth him to the level of extreme depravity and wickedness.

Regard men as a flock of sheep that need a shepherd for their protection. This, verily, is the truth, the certain truth. We approve of liberty in certain circumstances, and refuse to sanction it in others. We, verily, are the All-Knowing.

Say: True liberty consisteth in man's submission unto My commandments, little as ye know it. Were men to observe that which We have sent down unto them from the Heaven of Revelation, they would, of a certainty, attain unto perfect liberty. Happy is the man that hath apprehended the Purpose of God in whatever He hath revealed from the Heaven of His Will, that pervadeth all created things. Say: The liberty that profiteth you is to be found nowhere except in complete servitude unto God, the Eternal Truth. Whoso hath tasted of its sweetness will refuse to barter it for all the dominion of earth and heaven. (Baha'u'llah, Gleanings from the Writings of Baha'u'llah, p. 336)

**"...a layman who cannot pretend to know the designs of the Creator"**

He hath endowed every soul with the capacity to recognize the signs of God. How could He, otherwise, have fulfilled His testimony unto men, if ye be of them that ponder His Cause in their hearts. He will never deal unjustly with any one... (Baha'u'llah, Gleanings from the Writings of Baha'u'llah, p. 106)

Know thou that the ear of man hath been created that it may hearken unto the Divine Voice on this Day that hath been mentioned in all the Books, Scriptures, and Tablets. (Baha'u'llah, Epistle to the Son of the Wolf, p. 2)

The Word of God may be likened unto a sapling, whose roots have been implanted in the hearts of men. (Baha'u'llah, Gleanings from the Writings of Baha'u'llah, p. 97)

He hath moreover deposited within the realities of all created things the emblem of His recognition... (The Bab, Selections from the Writings of the Bab, p. 112)

substitution of the civilization, the liberty, and the religion of English-speaking people for the lost domination of the Latin races and the Latin Catholic religion." It may be open even for a layman who cannot pretend to know the designs of the Creator to observe that, in the case of the tropics, the Unknown Power seems to have placed an insurmountable barrier against the English-speaking race. Professor Worcester,

*(14) Dean C. Worcester (1866-1924), born in Thetford, Vermont, and educated there and at the University of Michigan, was a naturalist on the Michigan faculty and participator in scientific expeditions to the Philippine Islands in the eighties. In 1898, he published a book, The Philippine Islands and Their People, which came to the attention of President McKinley; not surprisingly, he appointed Worcester in January 1899 a member of the Philippine Commission, one of the three civilians. The duties of this group were to determine how American "authority" should be extended humanely over the islands. Worcester believed the United States must retain the islands and govern them for a considerable period. He remained on the Commission until 1913 and served as Secretary of the Interior in the Philippine Insular Government from 1901 to 1913. Worcester's opinion, here quoted by Carnegie, is in the former's volume, p. 67. It reads, "It is doubtful, in my judgment, if many successive generations of European or American children could be reared there."*

who knows most about the Philippines, tells us that our

**"...perhaps the Bishop may have misinterpreted God's will."**

Misinterpreting the divine commands, men have acquired prejudices and on these prejudices they have waged religious wars and caused bloodshed. Behold what is happening to-day! Men are killing their brothers, believing this to be the cause of salvation, believing that such work is approved by God, believing that those whom they kill will be sent to hell. (Abdu'l-Baha [1912], Divine Philosophy, p. 101)

Look at the Gospel of the Lord Christ and see how glorious it is! Yet even today men fail to understand its priceless beauty, and misinterpret its words of wisdom.

Christ forbade war! When the disciple Peter, thinking to defend his Lord, cut off the ear of the servant of the High Priest, Christ said to him: 'Put up thy sword into the sheath'. [1] Yet, in spite of the direct command of the Lord they profess to serve -- men still dispute, make war, and kill one another, and His counsels and teaching seem quite forgotten. [1 St John xviii, 11.] (Abdu'l-Baha [1911], Paris Talks, p. 48)

**"In my travels, I have found the universal laws everywhere working to higher and higher standards of national life."**

Therefore, no one should glorify himself over another; no one should manifest pride or superiority toward another; no one should look upon another with scorn and contempt; and no one should deprive or oppress a fellow creature. All must be considered as submerged in the ocean of God's mercy. (Abdu'l-Baha [1912], The Promulgation of Universal Peace, p. 63)

Throughout past centuries each system of religious belief has boasted of its own superiority and excellence, abasing and scorning the validity of all others. Each has proclaimed its own belief as the light and all others as darkness. Religionists have considered the world of humanity as two trees: one divine and merciful, the other satanic; they themselves the branches, leaves and fruit of the divine tree and all others who differ from them in belief the product of the tree which is satanic. Therefore, sedition and warfare, bloodshed and strife have been continuous among them. The greatest cause of human alienation has been religion because each party has considered the belief of the other as anathema and deprived of the mercy of God. (Abdu'l-Baha [1912], The Promulgation of Universal Peace, p. 230)

**"...genuine faith in the divine government throughout all the world"**

... the manifold bounties of the Lord of all beings have, at all times,

race cannot settle there and make permanent homes; neither can it in other parts of the tropics, nor has it ever done so. It has tried to do so in India, but failed. If a British child be born there, it must be sent home. In the Philippines it is even worse. Can Bishop Doane point to any considerable or successful settlement of our race in the tropics? He cannot do so, and this fact would seem to imply that perhaps the Bishop may have misinterpreted God's will. It would seem that, perhaps, in his own way he intends the people he has placed in the tropics to develop a

--- Page 157. The Gospel of Wealth - VIII Americanism versus Imperialism

civilization for themselves, and is keeping his loving, fatherly eye upon his children there just as tenderly as upon the Bishop. In my travels, I have found the universal laws everywhere working to higher and higher standards of national life. All the world steadily improves. Only impatient men, destitute of genuine faith in the divine government throughout all the world, doubt that all goes well. The Bishop's eminent colleague, Bishop Potter, sees "God's will," our "holy duty,"

through the Manifestations of His Divine Essence, encompassed the earth and all that dwell therein. Not for a moment hath His grace been withheld, nor have the showers of His loving-kindness ceased to rain upon mankind. (Baha'u'llah, Gleanings from the Writings of Baha'u'llah, p. 18)

There can be no doubt whatever that if for one moment the tide of His mercy and grace were to be withheld from the world, it would completely perish. For this reason, from the beginning that hath no beginning the portals of Divine mercy have been flung open to the face of all created things, and the clouds of Truth will continue to the end that hath no end to rain on the soil of human capacity, reality and personality their favors and bounties. Such hath been God's method continued from everlasting to everlasting. (Baha'u'llah, Gleanings from the Writings of Baha'u'llah, p. 68)

‘When bishops in the same church disagree, it is difficult to decide.’

If reason is the perfect standard and criterion of knowledge, why are opinions at variance and why do philosophers disagree so completely with each other? This is a clear proof that human reason is not to be relied upon as an infallible criterion. (Abdu'l-Baha, Baha'i World Faith - Abdu'l-Baha Section, p. 252)

No two men can be found who may be said to be outwardly and inwardly united. (Baha'u'llah, Tablets of Baha'u'llah, p. 163)

The subject of “interpretation” has led mankind astray from the true intent of the Prophets throughout history. In this day and age Baha’u’llah has revealed the “Covenant” so that these differences may disappear by submitting to an external and infallible authority.

Inasmuch as there was no appointed explainer of the Book of Christ, everyone made the claim to authority, saying, "This is the true pathway and others are not." To ward off such dissensions as these and prevent any person from creating a division or sect the Blessed Perfection, Baha'u'llah, appointed a central authoritative Personage, declaring Him to be the expounder of the Book. This implies that the people in general do not understand the meanings of the Book, but this appointed One does understand. Therefore, Baha'u'llah said, "He is the explainer of My Book and the Center of My Testament." In the last verses of the Book instructions are revealed, declaring that, "After Me," you must turn toward a special Personage and "whatsoever He says is correct." In the Book of the Covenant Baha'u'llah declares that by these two verses this Personage is meant. (Abdu'l-Baha, The Promulgation of Universal Peace, p. 382)



so differently from Bishop Doane. When bishops in the same church disagree, it is difficult to decide.

44. Perhaps we are not justified in quoting Dr. Abbott as still an Imperialist, since his latest article in the Outlook is entitled "An Official Disclaimer of Imperialism." After quoting the Cuban Resolution passed by Congress, he asks:

Why should not Congress at the present juncture pass a similar resolution respecting the Philippines? ...When pacification is secured, our mission is at an end. ... The above resolution respecting Cuba was simply an affirmation of the principles of this government wrought into its Constitution, vital to its life, affirmed and reaffirmed at many periods of its history. It denies that we wish either to hold people in subjection or to possess their territory as our own. Under circumstances do the American people desire to hold under military government against their will a discontented and resisting people.

[Baha'i Comment](#)

*(15) In the Outlook, LXI,  
207 f.*

45. These sentiments justify the title. They are indeed a disclaimer, of Imperialism, but it seems that, like Bishop Potter, Dr. Abbott has not been favored with the revelation of God's will made to Bishop Doane, for, according to him, "whenever the subject races are pacified our mission ends"; while it is only after pacification that the Bishop's "Holy Mission" can begin to enforce "God's will" by the crusade against the Catholic (Latin) form of religion, for the introduction of "the religion of English-speaking people," of which we have in our land more than two hundred and fifty different forms, all used and loved by those who speak the English tongue.

--- Page 158. The Gospel of Wealth - VIII Americanism versus Imperialism

Even our valued Catholic friends are often "English-speaking people."

“...two hundred and fifty different forms (of the english speaking divisions of Christianity).”

Religious wars have been many. Nine hundred thousand martyrs to the Protestant cause was the record of conflict and difference between that sect of Christians and the Catholics. Consult history and confirm this. How many languished in prisons! How merciless the treatment of captives! All in the name of religion! Consider and estimate the outcome of other wars between the people and sects of religious belief.

From the beginning of human history down to this time the world of humanity has not enjoyed a day of absolute rest and relaxation from conflict and strife. Most of the wars have been caused by religious prejudice, fanaticism and sectarian hatred. Religionists have anathematized religionists, each considering the other as deprived of the mercy of God, abiding in gross darkness and the children of Satan. (Abdu'l-Baha, The Promulgation of Universal Peace, p. 265)

46. Nevertheless, we must recognize that, diametrically opposed as Bishop Doane and his school, and Dr. Abbott and his school are in their conclusions, they both have as their aim what they believe to be the good of the poor backward races, and neither pecuniary gain nor military glory for their own country. None of these earnest, good men have anything in common with the ranting political school. They see only serious and unsought "duty" where the others find "gain" or "glory," if not for the nation, at least for themselves as politicians.

[Baha'i Comment](#)

47. Imperialism can become a "holy duty" only if we can by forcible interference confer blessings upon the subject races; otherwise it remains what the President once said it was, "criminal aggression." Let us see, therefore, whether good or evil flows from such interference. This is easily ascertained, for there are many dependencies of European powers throughout the world, and many races held in subjection. Has the influence of the superior race upon the inferior ever proved beneficial to either? I know of no case in which it has been or is, and I have visited many of the dependencies. Where is

**Superior Race**

Anthropology, physiology, psychology, recognize only one human species, albeit infinitely varied in the secondary aspects of life. Recognition of this truth requires abandonment of prejudice -- prejudice of every kind -- race, class, colour, creed, nation, sex, degree of material civilization, everything which enables people to consider themselves superior to others.

Acceptance of the oneness of mankind is the first fundamental prerequisite for reorganization and administration of the world as one country, the home of humankind. Universal acceptance of this spiritual principle is essential to any successful attempt to establish world peace.... (The Universal House of Justice [1995], The Promise of World Peace)

there anything to show that it has been? On the contrary, the mass of authority declares that the influence of a superior race upon an inferior in the tropics is not elevating, but demoralizing. It is not difficult to understand why. Take the Philippines, for instance. The prevailing religion is our own Christian religion, Catholic, of course, but Christian, as in France and Belgium. In the interior there are Mohammedans, next in importance. Mr. Bray, the resident English consul, gives in the Independent a picture of happy life in Manila, which reminded me of what I had found in the East.

*(16) Howard W. Bray, British consul at Singapore and a behind-the-scenes negotiator between the Americans and the Filipinos, published "The Character and Rights of the Filipinos," in the Independent, L (1898), 1312-1316.*

### --- Page 159. The Gospel of Wealth - VIII Americanism versus Imperialism

48. One of the great satisfactions in traveling around the world is in learning that God has made all peoples happy in their own homes. We find no people in any part of the world desirous of exchanging their lot with any other. My own experience has

“...God has made all peoples happy in their own homes.”

...to interfere with matters of conscience is simply to give them [peoples who have a religion forced upon them without free-will] greater currency and strength; the more you strive to extinguish the more will the flame be kindled, more especially in matters of faith and religion, which spread and acquire influence so soon as blood is shed, and strongly affect men's hearts. (Abdu'l-Baha, A Traveller's Narrative, p. 21)

Convictions and ideas are within the scope of the comprehension of the King of kings [ God], not of kings; and soul and conscience are between the fingers of control of the Lord of hearts, not of [His] servants. (Abdu'l-Baha, A Traveller's Narrative, p. 91)

impressed this truth very strongly upon me. Upon our journey to the North Cape, we stopped in the Arctic Circle to visit a camp of Laplanders in the interior. A guide is provided, with instructions to keep in the rear of the hindmost of the party going and returning, to guard against any being left behind. Returning from the camp, I walked with this guide, who spoke English and had traveled the world round in his earlier years as a sailor, and was proud to speak of his knowing New York, Boston, New Orleans, and other ports of ours. Reaching the edge of the fiord, and looking down upon it, we saw a hamlet upon the opposite side, and one two-story house under construction, with a grass-plot surrounding it, a house so much larger than any of the adjacent huts that it betokened great wealth. Our guide explained that a man had made a great fortune. He was their multi-millionaire, and his fortune was reported to reach no less a figure than thirty thousand kroner (seven thousand five hundred dollars), and he had returned to his native place of Tromso to build this "palace" and spend his days there. Strange preference for a night six months long! But it was home. I asked the guide which

The Old Testament says that God created man like unto His own image; in the Qur'an it says: "There is no difference in the Creation of God!" Think well, God has created all, cares for all, and all are under His protection. The policy of God is better than our policy. We are not as wise as God! (Abdu'l-Baha [1911], Abdu'l-Baha in London, p. 55)

The Cause of God has room for all. It would, indeed, not be the Cause of God if it did not take in and welcome everyone -- poor and rich, educated, and ignorant, the unknown and the prominent -- God surely wants them all, as He created them all." (From a letter written on behalf of Shoghi Effendi to two individual believers, December 2, 1942: The Individual and Teaching, p. 25)

...the Essence of Divinity, the Sun of Truth, shines forth upon all horizons and is spreading its rays upon all things. Each creature is the recipient of some portion of that power, and man, who contains the perfection of the mineral, the vegetable and animal, as well as his own distinctive qualities, has become the noblest of created beings. (Abdu'l-Baha [1911], Abdu'l-Baha in London, p. 23)

place in all the world he would select if ever he made such a fortune - with a lingering hope that he would name some place in our own favored land. How could he help it? But his face beamed with pleasure at the idea of ever being rich, and he said finally: "Ah, there is no place like Tromso!"

49. Traveling in southern India, one day I was taken into the country to see tapioca roots gathered and ground for use. The adults working in the grove, men and women, had each a rag around the loins, but the boys and girls, with their black, glossy skins, were free of all encumbrance. Our guide explained to these people that we were from a country so

--- Page 160. The Gospel of Wealth - VIII Americanism versus Imperialism

far away, and so different from theirs, that the waters were sometimes made solid by the extreme cold and we could walk upon them; that sometimes it was so intensely cold that the rain was frozen into particles, and lay on the earth so deep that people could not walk through it, and that three and four layers of heavy clothes had to be worn. This happy people, as our

[Baha'i Comment](#)

guide told us, wondered why we stayed there, why we did not come and enjoy life in their favored clime.

50. It is just so with the Philippines to-day, as one can see from Mr. Pray's account of them. It is astonishing how much all human beings the world round are alike in their essentials. These peoples love their homes and their country, their wives and children, as we do, and they have their pleasures. If, in our humanitarian efforts and longing to benefit them, under the call of duty or destiny, we should bring a hundred to New York, give them fine residences on Fifth Avenue, a fortune conditioned upon their remaining, and try to "civilize" them, as we should say, they would all run away if not watched, and risk their lives in an attempt to get back to their own civilization, which God has thought best to provide for them in the Philippines. They have just the same feelings as we have, not excluding love of country, for which, like ourselves, as we see, they are willing to die. Oh, the pity of it! the pity of it! that Filipino mothers with American mothers equally mourn their lost sons -- one fallen, defender of his country; the other the

"...all human beings the world round are alike in their essentials."

He looketh on all things with the eye of oneness, and seeth the brilliant rays of the divine sun shining from the dawning-point of Essence alike on all created things, and the lights of singleness reflected over all creation. (Baha'u'llah, The Seven Valleys, p. 18)

All (people) were created alike by the (the blow of the) breath of His command, and the loftiness, exaltation and debasement appeared among the people after they had been created. (Compilations, Baha'i Scriptures, p. 200)

### Love of Country

Though loyal to their respective governments, though imbued with the love of their own country, and anxious to promote at all times, its best interests, the followers of the Baha'i Faith, nevertheless, viewing mankind as one entity, and profoundly attached to its vital interests, will not hesitate to subordinate every particular interest, be it personal, regional or national, to the over-riding interests of the generality of mankind, knowing full well that in a world of interdependent peoples and nations the advantage of the part is best to be reached by the advantage of the whole, and that no lasting result can be achieved by any of the component parts if the general interests of the entity itself are neglected.... (Shoghi Effendi [1941], The Promised Day is Come, p. vi)

Patriotic love is finite; the love of one's country causing hatred of all others, is not perfect love! Compatriots also are not free from quarrels amongst themselves. (Abdu'l-Baha [1911], Paris Talks, p. 36)

Of old it hath been revealed: "Love of one's country is an element of the Faith of God." The Tongue of Grandeur hath, however, in the day of His manifestation proclaimed: "It is not his to boast who loveth his country, but it is his who loveth the world." Through the power released by these exalted words He hath lent a fresh impulse, and set a new direction, to the birds of men's hearts, and hath obliterated every trace of restriction and limitation from God's holy Book. (Baha'u'llah, Gleanings from the Writings of Baha'u'llah, p. 95)

invader. Yet the invader was ordered by those who see it their "duty" to invade the land of the Filipinos for their civilization. Duty, stern goddess, what strange things men sometimes do in thy name!

The Faith of Islam, the succeeding link in the chain of Divine Revelation, introduced, as Baha'u'llah Himself testifies, the conception of the nation as a unit and a vital stage in the organization of human society, and embodied it in its teaching. This indeed is what is meant by this brief yet highly significant and illuminating pronouncement of Baha'u'llah: "Of old [Islamic Dispensation] it hath been revealed: 'Love of one's country is an element of the Faith of God.'" This principle was established and stressed by the Apostle of God, inasmuch as the evolution of human society required it at that time. Nor could any stage above and beyond it have been envisaged, as world conditions preliminary to the establishment of a superior form of organization were as yet unobtainable. The conception of nationality, the attainment to the state of nationhood, may, therefore, be said to be the distinguishing characteristics of the Muhammadan Dispensation, in the course of which the nations and races of the world, and particularly in Europe and America, were unified and achieved political independence. (Shoghi Effendi [1941], *The Promised Day is Come*, p. 120)

### Essential Unity

In a letter addressed to Queen Victoria over a century ago, and employing an analogy that points to the one model holding convincing promise for the organization of a planetary society, Bahá'u'lláh compared the world to the human body. There is, indeed, no other model in phenomenal existence to which we can reasonably look. Human society is composed not of a mass of merely differentiated cells but of associations of individuals, each one of whom is endowed with intelligence and will; nevertheless, the modes of operation that characterize man's biological nature illustrate fundamental principles of existence. Chief among these is that of unity in diversity. Paradoxically, it is precisely the wholeness and complexity of the order constituting the human body -- and the perfect integration into it of the body's cells -- that permit the full realization of the distinctive capacities inherent in each of these component elements. No cell lives apart from the body, whether in contributing to its functioning or in deriving its share from the well-being of the whole. The physical well-being thus achieved finds its purpose in making possible the expression of human consciousness; that is to say, the purpose of biological development transcends the mere existence of the body and its parts.

What is true of the life of the individual has its parallels in human society. The human species is an organic whole, the leading edge of the evolutionary process. That human consciousness necessarily operates through an infinite diversity of individual minds and motivations detracts in no way from its essential unity. Indeed, it is precisely an inhering diversity that distinguishes unity from homogeneity or uniformity. What the peoples of the world are today



experiencing, Bahá'u'lláh said, is their collective coming-of-age, and it is through this emerging maturity of the race that the principle of unity in diversity will find full expression. From its earliest beginnings in the consolidation of family life, the process of social organization has successively moved from the simple structures of clan and tribe, through multitudinous forms of urban society, to the eventual emergence of the nation-state, each stage opening up a wealth of new opportunities for the exercise of human capacity. (Baha'i International Community [1995]: The Prosperity of Humankind ")

51. Another reason which, we submit, renders it beyond our power to benefit these people is that, with the exception of a few men seeking their own gain, the only Americans whom the Filipinos can ever know must be our soldiers, for American women and children cannot make their homes there. No holy influence flowing from American homes, no Christian women, no sweet children; nothing there but men and

--- Page 161. The Gospel of Wealth - VIII Americanism versus Imperialism

soldiers, the former only a few adventurers who, failing to succeed at home, thought they could make money there. Now, every writer upon the subject tells that the presence of soldiers in any town in the tropics is disastrous to both native and foreigner; that the contact of the superior race with the inferior demoralizes both, for reasons well

Baha'i Comment

understood. Forty-six per cent of the British army in India is at all times diseased. What imperialistic clergyman or intelligent man but knows the soldiers in foreign camps, so far from being missionaries for good, require missionaries themselves more than the natives? It would all be so different if Americans could settle and establish their homes in the Philippines, and amalgamate with the people, making a colony. It is in colonies, not in dependencies, that Britain has done good work. Soldiers will not benefit the inferior race in the Philippines. Men there for gain will not. Missionaries there are already in abundance. Beyond a few of a different sect of Christianity, we have nothing more we can send, and these will find welcome there if we cease warfare upon the people, while to-day they would be regarded as enemies. It is not civilization, not improvement, therefore, that Imperialism can give to the Philippines, should we hold permanent possession. It is serious injury both to the Filipinos and to our soldiers, and to the American citizens who go there. It is a bad day for either soldier or business man when, in a foreign land, he is bereft of the elevating influences which center in the home.

52. The religious school of Imperialists intends doing for the Filipinos what is best for them, no doubt; but when we crush in any people its longing for independence, we take away with one hand a more powerful means of civilization than all which it is possible for us to bestow with the other. There is implanted in the breast of every human community the sacred germ of self-government, as the most potent means of Providence for raising them in the scale of being. Any ruler, be he President or Czar, who attempts to suppress the growth

--- Page 162. The Gospel of Wealth - VIII Americanism versus Imperialism

of this sacred spark is guilty of the greatest of public crimes. There is no people or tribe, however low in the scale, that does not have self-government in a greater or less degree. The Haitians and the San Domingans do not require our interference. Why is it not seen to be our duty to force our ideas upon these, our neighbors? The Filipinos are not inferior to these people. On the contrary, we have Admiral Dewey and General Merritt

[Baha'i Comment](#)

*(17) Wesley Merritt (1834-1910),  
commander of the first Philippine  
Expedition in the Spanish-  
American War.*

both stating that the Filipinos are more capable of self-government than the Cubans. It may be taken as a truism that a people which is willing to fight and to die for the independence of their country is at least worthy of a trial of the self-government it seeks. The Filipinos have done this. Even if they had not, it is better for the development of a people that they should attempt to govern themselves, this being the only school in which they can ever learn to do so. No matter through what years of failure they have to struggle, the end is certain, the successful development of the faculty of government. Through this stern but salutary school our own race traveled for centuries in Britain, with varying fortunes, but the end was the evolution of constitutional government. The cost is great, but the result is beyond price. No superior race ever gave it to an inferior without settling among and amalgamating with that race. In the Philippines, and in the tropics generally, this is impossible. The intruding race cannot be grown there, and where we cannot grow our own race we

cannot give civilization to the other. We can only retard, not hasten, their development.

53. India has been subject to British rule for nearly two hundred years, and yet not one piece of artillery can yet be intrusted to native troops. The people have still to be held down as in the beginning. It is so in every dependency in which the superior power assumes the right to govern the inferior, without being able to settle there and amalgamate

--- Page 163. The Gospel of Wealth - VIII Americanism versus Imperialism

with it. We challenge the Imperialist to give one instance to the contrary in all Britain's possessions.

### The Press

The press will, under such a system [world commonwealth], while giving full scope to the expression of the diversified views and convictions of mankind, cease to be mischievously manipulated by vested interests, whether private or public, and will be liberated from the influence of contending governments and peoples. (Shoghi Effendi [1936], The World Order of Baha'u'llah, p. 204)

As to manner and style, Baha'u'llah has exhorted "authors among the friends" to "write in such a way as would be acceptable to fair-minded souls, and not lead to cavilling by the people". And He issues a reminder: "We have said in the past that one word hath the influence of spring and causeth hearts to become fresh and verdant, while another is like unto blight which causeth the blossoms and flowers to wither."

In the light of all this, the code of conduct of the press must embrace the principles and objectives of consultation as revealed by Baha'u'llah. Only in this way will the press be able to make its full contribution to the preservation of the rights of the people and become a powerful instrument in the consultative processes of society, and hence for the unity of the human race. (Letters of The Universal House of Justice, 1988 Dec 29, Individual Rights and Freedoms, p. 10)

### Conscience of Man

...those time-honored and powerful strongholds of orthodoxy, whose deliberate aim is to maintain their stranglehold over the thoughts and consciences of men (Shoghi Effendi [1936], The World Order of Baha'u'llah, p. 17)

"The Call of God," Abdu'l-Baha has written, "when raised, breathed a new life into the body of mankind, and infused a new spirit into the whole creation. It is for this reason that the world hath been moved to its depths, and the hearts and consciences of men been quickened. Ere long the evidences of this regeneration will be revealed, and the fast asleep will be awakened." (Shoghi Effendi [1936], The World Order of Baha'u'llah, p. 169)

54. The impulse which carried many clergymen and other good people away at first was creditable to their hearts and emotions. But Dr. Abbott's remarkable article just quoted may be taken as evidence that the reason is now demanding audience, and not what we should like to do, but what conditions render it possible for us to do, or wisely undertake, is now to be soberly considered.

[Baha'i Comment](#)

55. The press also, like the pulpit, has done its part to stir the impulse to meet the demands of the "New Destiny"; but one of the most prominent organs of all in this work, and the leading government organ in the West, the "Times-Herald" of Chicago, - to judge from a recent editorial, - is also finding its hot passion chilled at the throne of reason, as it confronts and examines the conditions of the situation. It says:

The conscience of the American people will not tolerate the slaughter of Filipinos in a war of conquest. We do not seek their land; we do not wish to replace the yoke of Spain with one bearing the more merciful and just label of

### Conscience

Conscience, however, is not an unchangeable absolute. One dictionary definition, although not covering all the usages of the term, presents the common understanding of the word "conscience" as "the sense of right and wrong as regards things for which one is responsible; the faculty or principle which pronounces upon the moral quality of one's actions or motives, approving the right and condemning the wrong".

The functioning of one's conscience, then, depends upon one's understanding of right and wrong; the conscience of one person may be established upon a disinterested striving after truth and justice, while that of another may rest on an unthinking predisposition to act in accordance with that pattern of standards, principles and prohibitions which is a product of his social environment. Conscience, therefore, can serve either as a bulwark of an upright character or can represent an accumulation of prejudices learned from one's forebears or absorbed from a limited social code. (Letters of The Universal House of Justice, 1992 Dec 10, Issues Related to Study Compilation)

the United States. Let the President announce that we have no intention to annex Asiatic territory, and that the pledge of Congress as to Cuban independence will be the pledge of the American nation to the Philippines.

56. If the President had said this in his message to the Filipinos there could not to-day rise before him the specter of nearly five thousand human beings "mowed down like grass," as the cable describes, and sixty of our own fellow citizens sacrificed and several hundreds wounded.

*(18) On September 15, 1898, the Filipinos declared their independence. On February 4, 1899, fighting broke out between them and American troops.*

This is the effect of his failure to say to the one people what he said to the other. His responsibility is great.

[Baha'i Comment](#)

57. I write upon the eve of the birthday of the greatest public man of the century, perhaps of all the centuries, if his strange history be considered - Abraham Lincoln. Washington, Franklin, and Jefferson may have become 'back num-

--- Page 164. The Gospel of Wealth - VIII Americanism versus Imperialism

bers," as we have been often told, for, as men of the past century, they could not know our destiny; but here is the man of our own time, whom many of us were privileged to know. Are his teachings to be discarded for those of any now living who were his contemporaries? Listen to him: "No man is good enough to govern another without that man's consent. I say this is the leading principle, the sheet-anchor of American republicanism."

*(19) From Lincoln's speech at Peoria, October 18, 1854.*

It is not fashionable for the hour to urge that the "consent of the governed" is all-important; but it will be fashionable again one of these days.

[Baha'i Comment](#)



58. It seems as if Lincoln were inspired to say the needful word for this hour of strange subversion of all we have hitherto held dear in our political life. Our "duty" to bear the "White Man's Burden"

*(20) Title of the much-quoted Kipling poem.*

is to-day's refrain, but Lincoln tells us: "When the white man governs himself, that is self-government; but when he governs himself and also governs another man, that is more than self-government; that is despotism." Lincoln knew nothing of the new "Duty" and new "Destiny," or whether it is "Duty which makes Destiny" or "Destiny which makes Duty"; but he knew the old doctrines of Republicanism well.

### Despotism

Will the despotism of former governments answer the call for freedom which has risen from the heart of humanity in this cycle of illumination? It is evident that no vital results are now forthcoming from the customs, institutions and standpoints of the past. In view of this, shall blind imitations of ancestral forms and theological interpretations continue to guide and control the religious life and spiritual development of humanity today? Shall man, gifted with the power of reason, unthinkingly follow and adhere to dogma, creeds and hereditary beliefs which will not bear the analysis of reason in this century of effulgent reality? (Abdu'l-Baha [1912], *Promulgation Universal Peace*; p. 140-141)

### Republicanism

Although a republican form of government profiteth all the peoples of the world, yet the majesty of kingship is one of the signs of God. We do not wish that the countries of the world should remain deprived thereof. If the sagacious combine the two forms into one, great will be their reward in the presence of God. (Baha'u'llah, *Tablets of Baha'u'llah*, p. 28)

It is very evident that in the future there shall be no centralization in the countries of the world, be they constitutional in government, republican or democratic in form. The United States may be held up as the example of future government -- that is to say, each province will be independent in itself, but there will be federal union protecting the interests of the various independent states. It may not be a republican or a democratic form. To cast aside centralization which promotes despotism is the exigency of the time. This will be productive of international peace. (Abdu'l-Baha [1912], *The Promulgation of Universal Peace*, p. 167)

No Baha'i can be regarded as either a Republican or Democrat, as such. He is above all else, the supporter of the principles enunciated by Baha'u'llah, with which, I am firmly convinced, the programme of no political party is completely harmonious... (*Principles of Bahai Administration*, p. 29)

**59. One other lesson from the great American: "Our reliance is in the love of liberty which God has planted in us. Our defense is in the spirit which prizes liberty as the heritage of all men in all lands everywhere. Those who deny freedom to others deserve it not for themselves, and under a just God cannot long retain it."**

*(21) This is somewhat inaccurately quoted from Lincoln's speech at Edwardsville, Illinois, September 11, 1858.*

**60. Are these broad liberty-loving and noble liberty-giving principles of Americanism, as proclaimed by President Lincoln, to be discarded for the narrow liberty-denying, race-subjecting Imperialism of President McKinley when the next appeal is made to the American people? We have never for**

**--- Page 165. The Gospel of Wealth - VIII Americanism versus Imperialism**

**one moment doubted the answer; for they have never yet failed to decide great issues wisely nor to uphold American ideals.**

## Justice

O SON OF SPIRIT! The best beloved of all things in My sight is Justice; turn not away therefrom if thou desirest Me, and neglect it not that I may confide in thee. By its aid thou shalt see with thine own eyes and not through the eyes of others, and shalt know of thine own knowledge and not through the knowledge of thy neighbor. Ponder this in thy heart; how it behooveth thee to be. Verily justice is My gift to thee and the sign of My loving-kindness. Set it then before thine eyes. (Baha'u'llah, The Hidden Words of Baha'u'llah, p.3)

The light of men is Justice. Quench it not with the contrary winds of oppression and tyranny. The purpose of justice is the appearance of unity among men. The ocean of divine wisdom surgeth within this exalted word, while the books of the world cannot contain its inner significance. Were mankind to be adorned with this raiment, they would behold the day-star of the utterance, 'On that day God will satisfy everyone out of His abundance,' [1 cf. Qur'an 4:129.] shining resplendent above the horizon of the world. Appreciate ye the value of this utterance; it is a noble fruit that the Tree of the Pen of Glory hath yielded. (Baha'u'llah, Tablets of Baha'u'llah, p. 67)

## American Ideals

When I arrived in this country, I realized that American ideals are indeed most praiseworthy and that the people here are lovers of truth. They investigate reality, and there is no trace of fanaticism among them. Today the nations of the world are on the verge of war, influenced and impelled by prejudices of ignorance and racial fanaticism. Praise be to God! You are free from such prejudice, for you believe in the oneness and solidarity of the world of humanity. There is no doubt that the divine confirmations will uphold you. (Abdu'l-Baha [1912], The Promulgation of Universal Peace, p. 337)

A rectitude of conduct, an abiding sense of undeviating justice, unobscured by the demoralizing influences which a corruption-ridden political life so strikingly manifests; a chaste, pure, and holy life, unsullied and unclouded by the indecencies, the vices, the false standards, which an inherently deficient moral code tolerates, perpetuates, and fosters; a fraternity freed from that cancerous growth of racial prejudice, which is eating into the vitals of an already debilitated society -- these are the ideals which the American believers must, from now on, individually and through concerted action, strive to promote, in both their private and public lives... (Shoghi Effendi [1938], The Advent of Divine Justice, p. 23)

61. Never had this nation greater cause to extol Abraham Lincoln than upon this the ninetieth anniversary of his birth, and never till to-day had it cause to lament that a successor in the Presidential chair should attempt to subvert his teachings.

### **This Nation**

May this American democracy be the first nation to establish the foundation of international agreement. May it be the first nation to proclaim the universality of mankind. May it be the first to upraise the standard of the Most Great Peace, and through this nation of democracy may these philanthropic intentions and institutions be spread broadcast throughout the world. Truly, this is a great and revered nation. Here liberty has reached its highest degree. The intentions of its people are most praiseworthy. They are, indeed, worthy of being the first to build the Tabernacle of the Most Great Peace and proclaim the oneness of mankind. (Abdu'l-Baha, The Promulgation of Universal Peace, p. 36)

**MENU:** [HOME](#) » [Reconstruction](#) » [Gospel Content](#) » [Gospel Purpose](#)

# The Gospel of Wealth

And Other Timely Essays

by Andrew Carnegie

**In the right-hand commentary column,  
that which is in GREEN is a commentator's remark and  
that which is in BLUE is from the Baha'i Writings.  
On occasion, in that column, there may be a [link](#) to an extended comment or  
dissertation on the subject under discussion.**

- -

**A reminder that under "view" on your browser - you can set the text size UP  
or DOWN for a more comfortable read for yourself.**

--- Page 166. The Gospel of Wealth - IX Democracy in England

## IX

### Democracy in England

*(1) From the North American Review, CXLII (January 1886), 74-80. The advance toward parliamentary electoral reform is conventionally associated with the passage of three loosely-called reform bills; the first in 1832, the second in 1867, and the third in 1884-1885. Their general tendency was to extend the suffrage from a landed class, constituting a minority of the nation, to all males who possessed or occupied some property; and to redistribute seats in Parliament so that representation would have a more direct relation to population. When Gladstone was Prime Minister, the Act of 1884, adding about 2,000,000 voters to the rolls, in effect gave agricultural workers the franchise; that of 1885 pretty generally established single member constituencies approximately equal in population.*

1. THE most interesting political problem which the world presents to-day is undoubtedly that now pressing for solution in England. For the first time in their history, the majority of her people have power. Henceforth England is democratic. Cajoled, overruled, thwarted for generations by the aristocratic

[Baha'i Comment](#)

classes, who have doled out to them from time to time only such small measures of reform as were necessary to prevent revolution, the people have never been fully heard. A climax was reached, however, last session, when an act was forced upon the House of Lords which at once transferred power from the privileged few to the masses. It is this fact which renders the situation there so interesting to the political student.

2. To understand the position, it is needful to look for a few moments at the scope of the great act just referred to. The electoral system of England was quite fair when established centuries ago. The centers of population then lay in the south of England, and this district very properly sent to Parliament a majority of representatives. Those were the days when pretty little Bideford in Devonshire was required

--- Page 167. The Gospel of Wealth - IX Democracy in England

to send sixteen sail against the Armada, while Liverpool's quota was but two. But as population shifted to the middle and north of the

[Baha'i Comment](#)

island, the great cities like Birmingham, Leeds, Manchester, and Glasgow, each sending but two representatives, were offset by the two members from some decaying village in the south. Seventy thousand electors, say in Birmingham or Glasgow, had no more weight than a few hundred in Woodstock or Eye. To aggravate this injustice, the aristocratic landholders kept firm hold of the counties by restricting the right of voting to such as paid a rental sufficiently high to exclude all but the farmers, and traders who were wholly dependent upon them.

3. All this has been changed. The bill of last year gave the suffrage to residents throughout the country districts. Even the hitherto despised farm-laborers are now voters. The total electorate is increased about forty per cent. The squires and parsons who have for generations designated the county representatives, now find themselves powerless against the populace. The influence of this revolution is already seen in the character of the representatives whom they have just returned. The old-fashioned country squire has been discarded, and a

[Baha'i Comment](#)

rising barrister, rich merchant, or large employer of labor, has taken his place. Most significant was the remark of one of the Liberal managers to me, that he had on his list thirteen titled gentlemen ready to serve the state in Parliament, for whom no satisfactory constituencies could be found, their titles being regarded as elements of weakness before the new voters.

4. Even more important than the vast addition of voters to the electorate is the redistribution of seats which the measure enacts. One hundred and sixty-seven have been taken from the smaller constituencies and given to the great cities. All constituencies less than ten thousand in number have been abolished. What England is and has been, under the rule of a privileged class chiefly intent upon preserving their privileges, and restricted at every turn by feudal traditions,

--- Page 168. The Gospel of Wealth - IX Democracy in England

is well known. What she is to become under the rule of a democracy, in which no barriers exist between the

[Baha'i Comment](#)

popular will and its prompt execution, is now the question.

5. To this but one reply can be given. The people of England will proceed to assimilate their political institutions to those of all other English-speaking communities. The institutions will be rapidly colonialized and Americanized. This process began some years ago, and has continued without cessation. And just in proportion as the people have been able to influence their rulers has the movement been accelerated. The record of recent legislation shows only a copying of our institutions.

[Baha'i Comment](#)

6. The first and by far the most important step ever taken in this direction was the adoption some years ago of a system of public education. Every child in the land now receives an education equal to that which we bestow. Small fees are still collected from parents, but the local school boards have authority to pay these fees should parents be unable to do so. Attendance is compulsory. The first generation of those who have benefited by this system are now appearing upon the stage of action with the inevitable result: they are radical.

[Baha'i Comment](#)



Education is everywhere a sure destroyer of privilege. The boy who can read the Declaration of Independence may be trusted to feel its force sooner or later. The doctrine of political equality, once known, enters the heart of man a welcome guest. Following us again, as we have seen, the Electoral Act is a great step toward our plan of equal districts and universal suffrage. Legislation upon law, a department in which Britain has long been considered supreme, has recently been in the direction of combining law and equity, after our practice. The patent laws of England have just been modeled after our own, although there is yet much to be done to bring them to our standard. In regard to married women's property, the year before last witnessed the discarding of feudal ideas and the adoption of our American law upon the subject. In a short time we are to see marriage

--- Page 169. The Gospel of Wealth - IX Democracy in England

with a deceased wife's sister allowed in England, as it is in other English-speaking lands. If we except legislation upon Irish land, which Mr. Gladstone and every member of the government

pronounced exceptional and only justifiable upon the plea of necessity, it would be difficult to point out any change made in the laws of Britain during the past twenty years which is not in the direction of the colonial and republican practice. If we regard prospective legislation, we again find the parent land is politically under the influence of her children; her part for some years is to follow them.

7. England's position is indeed unique among nations. Time was when not only all English-speaking communities, but the thinkers of all nations, looked to her for lessons in political development. The mother of nations was the mother of parliaments. Trial by jury, habeas corpus, freedom of the press, constitutional government itself—all these are her work; but they are of the past, and are accepted as the law of gravitation is, there being no further dispute about them. The world requires the solution of new problems, fitting a more advanced condition; and toward this the fondest admirers of the dear old land must blush to own her contribution has been but scanty. A new English-speaking community, about to

[Baha'i Comment](#)

found a state, might indeed still look to England, but it would be to learn, not what to adapt, but what to avoid. Instead of standing forth a model, she has become a warning. No state would think of adopting throne, hereditary chamber, primogeniture and entail, union of church and state, or any other of the remains of feudal institutions with which England is afflicted. Her more enterprising children seem to stand reminding her that

To have done is nothing  
But to stand, like rusty  
mail,  
In monumental  
mockery.

*(2) Quoted inaccurately  
from Troilus and Cressida,  
Act III, scene 3, lines 151  
ff.*

--- Page 170. The Gospel of  
Wealth - IX Democracy in  
England

It is not to be supposed,  
unless Britain's star has set,  
and Britons are Britons no  
more, that the people - now  
educated, and becoming more  
and more apprised of the  
truth that they have been  
indulging in a Rip Van Winkle  
sleep - win rest content,  
deprived of the position they  
once held as the foremost  
nation of the world, the

pioneer in political progress. I am quite sure that Britons are still Britons, a mighty race, whose part in the world, great as it has been, is not yet played to a finish. England has risen from her slumber.

8. The appeal to the people which has just taken place has unfortunately resulted in an equivocal response. For several reasons the towns which voted first have deserted the Liberals for the Tories. First, the Irish vote, from dictates of policy, was thrown against their natural allies, the Liberals. Second, the premature explosion of the issue of church disestablishment on the eve of the election frightened many Liberal churchmen into opposition. The Englishman regards every new question as a bogey, and has to be led up quietly to the object, and accustomed to it before he can be driven on. A third reason, no doubt more potent than a surface view would indicate, was a deep aversion to the Liberal policy in Egypt and in the Sudan,

*(3) The defeat of the Liberals and the decline of Gladstone's influence resulted in part from the disaster to General Charles Gordon at Khartoum, where, failing to evacuate the Sudan as expected by the home government, and unrelieved until too late, he was besieged by the Mahdists and*

[Baha'i Comment](#)

*killed.*

which resulted in a loss of thousands of lives, and added twenty millions sterling to the budget. A fourth cause is found in the theory of "Fair Trade" as opposed to "Free Trade." Great distress prevails in the manufacturing districts, and many operatives were carried away in the hope that there might be some virtue in the fair trade idea. Thus the Liberals fought at enormous disadvantage in the towns, and lost a great many seats which are safe for them under normal conditions.

9. Turning to the country districts, the reverse is found. All that the most advanced Radical hoped for has been accomplished, and more. The enfranchised voters have turned upon

--- Page 171. The Gospel of Wealth - IX Democracy in England

their former oppressors, the parson and the squire, and their class, and have driven them from the field. The new Parliament will differ from other Parliaments in nothing so much as this: that the members from the country are Radical instead of being Tory magnates as hitherto. The

[Baha'i Comment](#)

gains in the counties have equalized the losses in the towns, and all to the advantage of the Radical wing of the Liberal party. Left to struggle with the Tories alone, Mr. Gladstone and his followers would have had a triumphant majority, and been able to carry the Liberal program complete. But here comes in the most important factor of all. As Richelieu says to the king, of Cromwell, "A great man has arisen in England" -Parnell. His triumph is complete. He holds both parties at his mercy. The scales of power are in his hand. In presence of this great fact speculation concerning the Radical program is vain. The question of Ireland overshadows all. Nothing else will be heard of. Not even the reform of the rules of procedure of the House, which is a crying necessity, can be accomplished except by arrangement with the "uncrowned King of Ireland." The natural course would be an alliance between Mr. Gladstone and Mr. Parnell, when probably a few of the Whigs -- Goschen and Hartington - would go sulking to their tents. Rosebery and Harcourt, and even Granville, if he does not finally retire, which is probable, may be depended upon, however, to

remain with the advanced wing, which is headed by Chamberlain, Morley, Dilke, and Trevelyan. Even with this alliance it is probable that an appeal would have to be made to the country next year upon the one vital question of Home Rule for Ireland; and as the Liberals would then have the Irish vote, the result cannot be doubtful.

*(4) Since Carnegie is here dealing with events both complicated and critical, it is not surprising that his analysis and forecasts went awry. The parliamentary election of December 1885 had an outcome exceptional in English history. The Liberal Party under Gladstone won a plurality of seats but the combined total of Conservatives and of the followers of Charles Stewart Parnell (1848-1891) equaled it. Parnell was at the crest of his influence. A Protestant, Irish landowner, Parnell hated England. He had consolidated, as far as any man could, the various sects and programs of Irish discontent; his Land League drew sympathy and financial support from America. Though he did not publicly condemn the violent acts of Irish terrorists, Parnell primarily sought to wring concessions from the English Parliament by making himself a nuisance through procedural delays and by dramatizing his cause. Even before the election of 1885 Gladstone has decided upon a measure for Irish home rule; afterwards it seemed a practical necessity. By sponsoring it he split from his party the old Whigs and many of the Radicals. Chamberlain and Sir George Otto Trevelyan (1838 - 1928) resigned from the Cabinet; Rosebery and Morley stayed in; Sir Charles Wentworth Dilke (1843-1911) voted for the bill. The Commons defeated home rule by thirty votes; ninety-three Liberals voted*

*against it. Gladstone resigned and Salisbury returned to office. The other statesmen mentioned are Viscount George Joachim Goschen (1831-1907), member of the Gladstone Cabinet (1888) and, with Spencer Compton Cavendish, Marquis of Hartington (1838-1908), an active Liberal Unionist on the Irish question; George Leveson-Gower Granville (1815-1891), colonial secretary in the Gladstone ministry of 1868, and foreign secretary (1870-1874, and 1880-1885), a firm supporter of Gladstone on home rule; Sir William Granville Harcourt (1827-1904), Liberal.*

--- Page 172. The Gospel of Wealth - IX Democracy in England

10. But neither Mr. Gladstone nor the Marquis of Salisbury, not even Parnell, nor any other man, can tell what combination the kaleidoscope of British politics is to form during the next sixty days. It is useless, therefore, for me to speculate further upon it. This much, however, is certain: The democracy are in power, and their measures will be carried, if not this session, then in some early Parliament. And included in these will be Home Rule for Ireland, with rights similar to those enjoyed by the States of the American Union - a further imitation of her giant child by the motherland. When this great question is settled, but not till then, the Radical program of further democratic reforms

[Baha'i Comment](#)



will be in order.

11. The most important consideration of all is the future attitude of Great Britain toward other nations. Is the British democracy to be pacific or belligerent? Is Britain to continue to embroil herself in wars in all parts of the world? Is she to maintain her costly and useless interferences in the quarrels of Europe? I think not. I believe that the British democracy is to be pacific, and that the American doctrine of non-intervention will commend itself to it. Britain will be more and

--- Page 173. The Gospel of Wealth - IX Democracy in England

more inclined to follow the example of America in regard to foreign affairs, as she has done in home affairs. "Friendship with all, entangling alliances with none," is to become the common platform of the democracy on both sides of the Atlantic. I believe, further, that it will not be long ere both parties in Britain will pledge themselves, as both parties here have done, to offer arbitration for the settlement of international disputes before drawing the sword. In short, Herbert

[Baha'i Comment](#)

Spencer's great law will be further vindicated: "As power is held arbitrarily by king or chief the military type is developed, and wars of dynasties and aggression ensue. As power passes to the people the industrial type is developed, and peace ensues."

12. In all this we see the unceasing movement of the various divisions of the English-speaking race throughout the world to assimilate their political institutions, each division taking that which the others have proved to be best. English law is already universal; the decisions of the Supreme Court of Washington are quoted wherever our language is spoken. Religion, too, may be said, in a broad sense, to be universal. Our speech is also the tongue of a hundred million Anglo-Saxons; our literature is also the same, and political institutions are rapidly becoming assimilated. The world is soon to see this community of language, religion, and political forms merge into the great Anglo-Saxon democracy. The child now lives who will see every English-speaking community living under institutions founded upon the extremest

[Baha'i Comment](#)

view of the rights of man, as formulated in our Declaration of Independence, without a vestige of privilege from birth, without king or aristocracy, without united church and state, without great standing armies, unhampered by primogeniture and entail, with equal electoral privileges and equal districts. In short, with only such slight variations of laws as are necessary to adjust them to differing conditions and climates, the various divisions of the English race will live in peaceful brotherhood, each governing itself as a free and

--- Page 174. The Gospel of Wealth - IX Democracy in England

independent nation, but held to the others with bonds stronger than those of conquest, feudal dependency, or colonial relationship, and ready to help one another in need. This is the ideal federation of the English-speaking people of the world. It is also the only one possible or desirable.

13. The great parent land, it is true, lags behind at present. It is characteristic of her to be slow; but it is no less characteristic of her that what she once sets her hand to do, that she accomplishes. Twenty years' reign of the people will place her abreast of the most advanced of her children, and twenty years more may restore to her the political leadership of the world.

[Baha'i Comment](#)

**MENU:** [HOME](#) » [Reconstruction](#) » [Gospel Content](#) » [Gospel Purpose](#)

# The Gospel of Wealth

And Other Timely Essays

by Andrew Carnegie

**In the right-hand commentary column,  
that which is in GREEN is a commentator's remark and  
that which is in BLUE is from the Baha'i Writings.  
On occasion, in that column, there may be a [link](#) to an extended comment or  
dissertation on the subject under discussion.**

**A reminder that under "view" on your browser - you can set the text size UP  
or DOWN for a more comfortable read for yourself.**

--- Page 175. The Gospel of Wealth - X Home Rule in America

**X**

## Home Rule in America

*(1) Address before the Glasgow Junior Liberal Association, St. Andrew's Hall, Glasgow, September 13, 1887.  
Published in the Scottish Leader, September 1887.*

1. MR. President, Ladies, and Gentlemen: I have first to thank the officers of the Junior Liberal Association for giving me the great privilege of standing before a vast audience of my fellow-countrymen here in the second city of the Empire, in that city which has done more than any other city to draw closer the two branches of the great English-speaking race, my native and my adopted land. The great ships which you are sending forth every year to ply to and fro across

**international arbitration** - Baha'u'llah declared the coming of the Most Great Peace. All the nations and peoples will come under the shadow of the Tent of the Great Peace and Harmony--that is to say, by general election a Great Board of Arbitration shall be established, to settle all differences and quarrels between the Powers; so that disputes shall not end in war. ('Abdu'l-Bahá in London, page 30)

the Atlantic are shuttles weaving a glorious web between the two nations. Already we have spelled out in the glorious pattern international arbitration, and there is yet to come, as we draw closer and closer together, eternal friendship and good will.

2. The recent appointment of a commission to settle the fisheries dispute proves once more that never henceforth is a drop of blood of one branch of the race to be shed by the other branch. And, in speaking of that Fisheries Commission, permit me to say that I, for one, and I believe all Liberals and all British people, were rejoiced that a man like Mr. Chamberlain should have found a position in which he can do more good to his country than in any which he could find at home. It is a great work, this upon which he has embarked. I know that the Pall Mall represents him as a Jonah thrown : overboard to the fishes, but I trust that he too, like Jonah,

--- Page 176. The Gospel of Wealth - X Home Rule in America

will return from the excursion wholly uninjured, with increased reputation, and able to boast that he has done

**conciliation** - Today the world of humanity is in need of international unity and conciliation. To establish these great fundamental principles a propelling power is needed. It is self-evident that the unity of the human world and the Most Great Peace cannot be accomplished through material means. They cannot be established through political power, for the political interests of nations are various and the policies of peoples are divergent and conflicting. They cannot be founded through racial or patriotic power, for these are human powers, selfish and weak. The very nature of racial differences and patriotic prejudices prevents the realization of this unity and agreement. Therefore, it is evidenced that the promotion of the oneness of the kingdom of humanity, which is the essence of the teachings of all the Manifestations of God, is impossible except through the divine power and breaths of the Holy Spirit. Other powers are too weak and are incapable of accomplishing this. ('Abdu'l-Bahá, Promulgation of Universal Peace, page 12)

something which no other traveler has ever done.

*(2) Over the details of the fisheries question in the waters to the northeast of the United States there had been quarrels since the treaty closing the Revolution. Aside from the justice or injustice of the issues in dispute, it was difficult to secure an adjustment between Great Britain and the United States because the former "stood as broker between the United States and Canada, and had great difficulty in managing their Canadian clients." As for the United States, Maine and Massachusetts were usually furthering circumstances that would make the importation of fish from Canada impossible, either by embargoes or tariffs. At this particular time "Blaine & Company" -- Republicans-- were trying to stir up anti-British feeling to win the Irish heart (the Irish vote). In spite of these handicaps, President Cleveland and his Secretary of State, T. F. Bayard (1828-1898), and the Salisbury ministry resolved upon an effort at conciliation. In the fall of 1887 a Fisheries Commission met in Washington; Joseph Chamberlain was the leader of the British delegation. In February 1888 Cleveland submitted the Bayard-Chamberlain Treaty to the Senate. Partisanship on the eve of the presidential election of 1888 contributed to its rejection by the Senate. In any case Chamberlain made the acquaintance of the American lady who became his wife.*

3. When I accepted the invitation to deliver a political address before this audience, I stated that it would be unbecoming in me to enter into the quarrels - the temporary and passing quarrels - which, unfortunately, have existed in the Liberal party, but which, I am happy to say, between the date of my acceptance and the date of my appearance, have largely vanished into thin air. The recent elections did not show much of a schism in the Liberal party, and therefore I approach the subject of Home Rule in America to-night, feeling that I in nowise become a party to the dissatisfactions and to the jealousies which have existed among you. For I tell you this: be he Liberal Gladstonian, be he Liberal Unionist, be he Conservative, or be he Tory, -- I believe I have described all the variations, -in the soul of every honest and fair and patriotic citizen of this great land there lies like a weight the conviction that, whatever may come, the present condition of affairs in Ireland must cease. You must no longer disgrace the English name, and make us blush in America for the land of our fathers - the land that

--- Page 177. The Gospel of Wealth - X Home Rule in

**liberty** - We will pray that the ensign of international peace may be uplifted and that the oneness of the world of humanity may be realized and accomplished. All this is made possible and practicable through your efforts. May this American democracy be the first nation to establish the foundation of international agreement. May it be the first nation to proclaim the universality of mankind. May it be the first to upraise the standard of the Most Great Peace, and through this nation of democracy may these philanthropic intentions and institutions be spread broadcast throughout the world. Truly, this is a great and revered nation. Here liberty has reached its highest degree. The intentions of its people are most praiseworthy. They are, indeed, worthy of being the first to build the Tabernacle of the Most Great Peace and proclaim the oneness of mankind. I will supplicate God for assistance and confirmation in your behalf. ("The Promulgation of Universal Peace, pp. 36-37)

The spirit of liberty which in recent decades has swept over the planet with such tempestuous force is a manifestation of the vibrancy of the Revelation brought by Baha'u'llah. His own words confirm it. "The Ancient Beauty", He wrote in a soul-stirring commentary on His sufferings, "hath consented to be bound with chains that mankind may be released from its bondage, and hath accepted to be made a prisoner within this most mighty Stronghold that the whole world may attain unto true liberty." Might it not be reasonably concluded, then, that "true liberty" is His gift of love to the human race? Consider what Baha'u'llah has done: He revealed laws and principles to guide the free, He established an Order to channel the actions of the free, He proclaimed a Covenant to guarantee the unity of the free. Thus, we hold to this ultimate perspective: Baha'u'llah came to set humanity free. (Individual Rights and Freedoms, 219-224)

**schism** - The time has come for the Baha'i community to become more involved in the life of the society around it, without in the least supporting any of the world's moribund and divisive concepts, or slackening its direct teaching efforts, but rather, by association, exerting its influence towards unity, demonstrating its ability to settle differences by consultation rather than by confrontation, violence or schism, and declaring its faith in the divine purpose of human existence. (Universal House of Justice, Ridvan1985)



## America

has been the pioneer of liberty. The mother of nations must no longer stand before the world confessing that at her own doors, in a part of her own empire, she is unable to found just laws which commend themselves to the public sentiment of the governed. Home Rule is certain, and therefore I enter upon no disputed question when I venture to lay before you the phase of Home Rule which we have in America, hoping that when your bill is prepared, you may find some hints there which may be of use to you in solving this great and pressing question.

4. Now, gentlemen, it will be necessary for me to say a few words upon the American Constitution. What is it? I will tell you upon what it is founded. It is founded upon your own Constitution, and it is largely the work of a Scotsman. I appeal to any scholar here, to any man who has read the proceedings antecedent to the adoption of the Constitution. I ask you to read the "Federalist," and you will find that the draft of the American Constitution submitted by Alexander Hamilton was adopted, with very few amendments, and is

**constitution** - Once the Parliament of Man is established and its constituent parts organized, the governments of the world having entered into a covenant of eternal friendship will have no need of keeping large standing armies and navies. A few battalions to preserve internal order, and an International Police to keep the highways of the seas clear, are all that will be necessary. Then these huge sums will be diverted to other more useful channels, pauperism will disappear, knowledge will increase, the victories of Peace will be sung by poets and bards, knowledge will improve the conditions and mankind will be rocked in the cradle of felicity and bliss. Then, whether a government is constitutional or republican, hereditary monarchy or democratic, the rulers will devote their time to the prosperity of their nations, the legislation of just and sane laws and the fostering of closer and more amicable relations with their neighbours--thus will the world of humanity become a mirror reflecting the virtues and attributes of the Kingdom of God. (Peace, pages 17 & 18)

to-day that Constitution. I do not think that will cause it to be less favorably considered before a Glasgow audience. Well, the eulogies of that Constitution have been so great and so many, recently, that I will not trouble you with quotations; but in the works of Matthew Arnold, Froude, Freeman, Dicey, and last, but not least, Mackenzie, a Scotsman who has written a wonderful history of America, - a Dundee man, I believe, - and Sir Henry Mayne,

*(3) Examples of eulogies to the Constitution are provided by Matthew Arnold, "A Word More about America," Nineteenth Century, XCVI (February, 1885), 219-236; E. A. Freeman, Some Impressions of the United States (1883), pp. 111-119, 134-137; A. V. Dicey, "Parliamentary Sovereignty and Federation," Lectures Introductory to the Study of the Law of the Constitution (1885), pp. 126-165; Sir Henry S. Maine, Popular Government, Four Essays (1886) pp. 196-254. This burst of interest in American institutions followed the British Reform Acts of 1881-2, in effect establishing universal manhood suffrage. British observers were interested in seeing how democracy worked. These were also days when a belief in the superiority of Anglo-Saxon culture touched academic circles on both sides of the Atlantic; English scholars consequently detected commendable similarities or even superiorities in American institutions. Finally, as American higher education attained status, the interchange of academic personnel across the Atlantic quickened; observations on the spot dispelled old misconceptions about the United States and revealed unsuspected merits in*

*American institutions.*

you can read

--- Page 178. The Gospel of Wealth - X Home Rule in America

pages of eulogy which, as an American, my modesty will not permit me to repeat. I will, however, venture to quote from the leaders of your two parties, that you may see how they corroborate the views expressed by these writers.

5. My lord Salisbury has said: "The Americans have a Supreme Court which gives a stability to their institutions, for which we look here in vain; the Americans have a Senate wonderful in its power and efficiency; would that we could have such a second chamber here!" I will tell Lord Salisbury how he can have it. There is no patent for its exclusive use - and there is only one way of getting anything good in a nation. The United States Senate springs from the people. There is not the poison of hereditary privilege in its veins, and that is what makes it so powerful and wonderful in its strength and efficiency; and if my friend Lord Rosebery, when he brings in his bill to reform the

**hereditary** - The virtues of humanity are many, but science is the most noble of them all. The distinction which man enjoys above and beyond the station of the animal is due to this paramount virtue. It is a bestowal of God; it is not material; it is divine. Science is an effulgence of the Sun of Reality, the power of investigating and discovering the verities of the universe, the means by which man finds a pathway to God. All the powers and attributes of man are human and hereditary in origin--outcomes of nature's processes--except the intellect, which is supernatural. Through intellectual and intelligent inquiry science is the discoverer of all things. It unites present and past, reveals the history of bygone nations and events, and confers upon man today the essence of all human knowledge and attainment throughout the ages. By intellectual processes and logical deductions of reason this superpower in man can penetrate the mysteries of the future and anticipate its happenings. ('Abdu'l-Bahá, Promulgation of Universal Peace, page 7)

House of Lords, which he has promised, can only persuade Lord Salisbury to agree to exclude the hereditary poison, why, then you can get a Senate chamber equal to the American in strength and efficiency. You cannot get it any other way, and unless this is conceded, Lord Rosebery will find that his only safety lies in taking the advice Hamlet gave to the players: "Reform it altogether." Well, now, a greater man than Lord Salisbury - do not cheer; I am not going to give the name, but when I mentioned the name in Edinburgh, all the audience jumped to their feet and cheered, and I enjoyed it very much. As I said, a greater authority than Lord Salisbury, and one who has done a great deal more in improving constitutions, has pronounced the American Constitution the most wonderful work ever struck off at one time by the brain and purpose of man. I do not know whether Mr. Gladstone, being a Scotsman, may not be a little partial to the work of a Scotsman like Alexander Hamilton, but these are his

--- Page 179. The Gospel of  
Wealth - X Home Rule in  
America

words. The day after to-  
morrow there will assemble in

the city of Philadelphia representatives from all parts of the United States, with the judges of the Supreme Court and the President at their head, to celebrate the centenary of the adoption of the Constitution.

*(4) In mid-September 1887 a three-day civic celebration was held in Philadelphia to commemorate the centenary of the completion of the work of the Constitutional Convention.*

The Constitution, a hundred years ago, was adopted by a population of three millions which fringed the Atlantic coast. To-day it holds peaceful sway over the majority of the English-speaking race -- more English-speaking people than all Great Britain and all her colonies, even were the latter doubled in population; and although this branch of the British people has extended from the Atlantic to the Pacific, and southward from the coast of Maine to the Gulf of Mexico, they have not outrun the benefits or the protection of that Constitution.

6. Let me now describe that Constitution to you. The government of the United States, under the Constitution, is divided into three departments - the legislative, the executive, and the judicial. The Legislature consists of two houses - a House of Representatives, elected for two years by a direct vote of the people; and a Senate, composed of two senators from each of the thirty-eight States, elected for six years by the State Legislature, but so elected that every -two years one third of the entire body retires to the people to seek reelection and have the chance of being displaced by worthier servants. These representatives receive as a compensation for their services one thousand pounds each, per annum. They sit from ten o'clock in the morning till four o'clock in the afternoon, and having paid for the services of these gentlemen, the nation exacts regular attendance. it 'exact's their abilities and attention when these are fresh, and it would not tolerate for a moment one hundred and sixty-eight barristers, as in your present Parliament, who do all their work in the daytime and come to you to muddle your

vanity - ... This is the day whereon all peoples should shed the light of unity and concord. In brief, the pride and vanity of certain of the peoples of the world have made havoc of true understanding, and laid waste the home of justice and of equit (Bahá'u'lláh, Expistle to Son of the Wolf, page 76)

--- Page 180. The Gospel of  
Wealth - X Home Rule in  
America

business at night. I have sat a great deal in your House of Commons. It is largely a debating club for the display of vanity, and it is no longer a sober, thoughtful legislative chamber. It never will be, as long as its members consider that they give you a gentlemanly class that condescends to serve you in Parliament. Your legislators are always your masters here, but in America they are our paid servants.

7. You know that celebrated story of a gentleman who lost a great deal of money by a false play at whist on the part of his partner. He scolded him, and the matter was referred to the leading expert of the whist club. The question was this: Could a man make such a stupid play as that which was described? And the decision of the referee was that he thought he might-after dinner. That is one point not embraced in Home Rule-but I mention it incidentally.

[Baha'i Comment](#)

8. Well, then, the power of the two houses of Parliament is very much akin to your own in one respect. As far as the House of Representatives is concerned, they have the power of the purse, but the Senate of the United States is of equal power with the House. No act becomes an act without its approval. No treaty can be signed by the President, no appointment made of a petty postmaster, no appointment of an ambassador or minister or agent, without the consent and vote and approval of the most august legislative assembly in this world - the American Senate. There is where we hold our chief ruler. The President must carry with him that body of senators. We have our executive in the President. We make our king every four years, and we pay him a tremendous salary. I suppose all you people would grudge it for a crowned head. We pay him ten thousand pounds per annum, and we have nothing to do with his brothers and his sisters and his cousins and his aunts. And at the end of four years, if we do not like him, we put him down and elect another one. My fellow-countrymen, I would like you to cast your eye over the list of American Presidents and compare them for the last hundred years

**treaty** - Concerning the proceedings for this world gathering, Abdu'l-Baha, the son of Baha'u'llah and authorized interpreter of his teachings, offered these insights: "They must make the Cause of Peace the object of general consultation, and seek by every means in their power to establish a Union of the nations of the world. They must conclude a binding treaty and establish a covenant, the provisions of which shall be sound, inviolable and definite. They must proclaim it to all the world and obtain for it the sanction of all the human race. This supreme and noble undertaking--the real source of the peace and well-being of all the world--should be regarded as sacred by all that dwell on earth. All the forces of humanity must be mobilized to ensure the stability and permanence of this Most Great Covenant. In this all-embracing Pact the limits and frontiers of each and every nation should be clearly fixed, the principles underlying the relations of governments towards one another definitely laid down, and all international agreements and obligations ascertained. In like manner, the size of the armaments of every government should be strictly limited, for if the preparations for war and the military forces of any nation should be allowed to increase, they will arouse the suspicion of others. The fundamental principle underlying this solemn Pact should be so fixed that if any government later violate any one of its provisions, all the governments on earth should arise to reduce it to utter submission, nay the human race as a whole should resolve, with every power at its disposal, to destroy that government. Should this greatest of all remedies be applied to the sick body of the world, it will assuredly recover from its ills and will remain eternally safe and secure."

The holding of this mighty convocation is long overdue. (Promise of World Peace, page 12)

**legislative** - The Baha'i Cause covers all economic and social questions under the heading and ruling of its laws. The essence of the Baha'i spirit is that, in order to establish a better social order and economic condition, there must be allegiance to the laws and principles of government. Under the laws which are to govern the world, the socialists may justly demand human rights but without resort to force and violence. The governments will enact these laws, establishing just legislation and economics in order that all humanity may enjoy a full measure of welfare and privilege; but this will always be according to legal protection and procedure. Without legislative administration, rights and demands fail, and the welfare of the common-wealth cannot be realized. Today the method of demand is the strike and resort to force, which is manifestly wrong and destructive of human foundations. Rightful privilege and demand must be set forth in laws and regulations. ('Abdu'l-Bahá, Promulgation of Universal Peace, page 238)



with certain indi-

--- Page 181. The Gospel of  
Wealth - X Home Rule in  
America

viduals that you have been  
cursed with on your throne.  
Compare them, man for man,  
and see where you will land.  
This President nominates his  
Cabinet; but, mark you, not a  
man is a member of his  
Cabinet until the Senate says,  
"Approved." He may dismiss  
them, but when he nominates  
others, every new man must  
go through that ordeal before  
he becomes a member of the  
Cabinet.

9. The President is not only  
the first civil magistrate: he is  
the first military magistrate.  
We bring the civil power right  
where we want the civil power  
to be - at the head; and we  
put the military power where  
the military power ought  
always to be-at the foot. The  
President of the United States  
is the commander-in-chief of  
the army and of the navy, and  
of the military forces of the  
States when he chooses to call  
them into service. This is no  
shadowy power. When  
General Grant was at the top  
of his fame, it was rumored  
that he was about to conclude  
a convention with General Lee  
which touched upon the policy

[Baha'i Comment](#)

to be pursued; and I saw the telegram which President Lincoln wrote with his own hand: "TO MAJOR-GENERAL GRANT, near Richmond, Virginia: You will hold no conventions with General Lee except for the capitulation of his army. You will not confer, nor discuss, nor conclude any question of any political import whatever. The President holds these questions in his own hands, and he will not submit them to any military conference whatever." That is the kind of power we give our President, and we hold him responsible for the exercise of that power, and at the end of four years he gives us an account of his stewardship. At his call to-day seven millions of men capable of bearing arms, accustomed to bear arms, and only too ready to bear arms in defense of the Union, would stand forth. But two years from now that President would be one of the seven millions shouldering his musket in his ranks.

10. Now, then, our Cabinet does not appear in our House of Congress. They make written communications. They answer

--- Page 182. The Gospel of Wealth - X Home Rule in America

all questions which either House requires, but they do not deliberate with the House, because the American people are most jealous of any interference between the legislative and the executive. Now, to regulate all the rights of these people, the Supreme Court, the object of Lord Salisbury's admiration, has been created. It consists of nine judges. They receive two thousand pounds a year each for their services, and the Chief Justice of the United States receives one hundred pounds more than his fellows. He passed through your country the year before last, the head of the American government in one sense, because the court is above the President, as it interprets the acts of Congress, and is the arbiter of the community. He passed along unnoticed. The aristocracy and the court paid no attention to the Chief Judge of the United States. That is very much to be wondered at, because Buffalo

**aristocracy** - Similarly, the quality of aristocracy (rule by the best) as it appears in the Faith is in sharp contrast to what is generally understood by this term. Free from electioneering or such external pressures as those coming from economic power or manipulation of the press, the believers seek to elect for membership on their governing institutions those persons whom they regard as best qualified for such office. The elected members are then responsible to God and to their consciences, rather than to those who elect them. You are undoubtedly familiar with Shoghi Effendi's words in Baha'i Administration on the attitude and responsibility of members of Assemblies:

The duties of those whom the friends have freely and conscientiously elected as their representatives are no less vital and binding than the obligations of those who have chosen them. Their function is not to dictate, but to consult, and consult not only among themselves, but as much as possible with the friends whom they represent. They must regard themselves in no other light but that of chosen instruments for a more efficient and dignified presentation of the Cause of God. They should never be led to suppose that they are the central ornaments of the body of the Cause, intrinsically superior to others in capacity or merit, and sole promoters of its teachings and principles. They should approach their task with extreme humility, and endeavour, by their open-mindedness, their high sense of justice and duty, their candour, their modesty, their entire devotion to the welfare and interests of the friends, the Cause, and humanity, to win, not only the confidence and the genuine support and respect of those whom they serve, but also their esteem and real affection. They must, at all times, avoid the spirit of exclusiveness, the atmosphere of secrecy, free themselves from a domineering attitude, and banish all forms of prejudice and passion from their deliberations. They should, within the limits of wise discretion, take the friends into their confidence, acquaint them with their plans, share with them their problems and anxieties, and seek their advice and counsel. And, when they are called upon to arrive at a certain decision, they should, after dispassionate, anxious and cordial consultation, turn to God in prayer, and with earnestness and conviction and courage record their vote and abide by the voice of the majority, which we are told by our Master to be the voice of truth, never to be challenged, and always to be whole-heartedly enforced. To this voice the friends must heartily respond, and regard it as the only means that can ensure the protection and advancement of the Cause. (Universal House of Justice, Administrative Order, page 2)

Bill had not then arrived. But when your Chief Justice visited America, he was received as became a man in his position. The President of the United States received him, the cities received him, and he was everywhere entertained in a manner which, I trust, some future day, the Chief Justice of the United States may experience when he visits this country when the democrats are in power.

11. This Supreme Court has a veto on all laws passed by the House, the Senate, and the President. It does not make a particle of difference if the House of Representatives pass a law, and if the Senate pass it, and if the President approve it, any man can make an issue and appeal to the Supreme Court, "Is that law constitutional?" If it is decided to be unconstitutional it is waste paper. But great as are the powers which our Supreme Court possesses, remember the Supreme Court can start no issue. It can only decide issues which are brought before it, so that it is only when the law would work injustice or create popular discontent that the Supreme Court is appealed to at all. Now, then, having briefly described to you the three

[Baha'i Comment](#)

departments of the American govern-

--- Page 183. The Gospel of Wealth - X Home Rule in America

ment, allow me to say that the Supreme Judges remain for life, subject to removal by the President and the Cabinet for misbehavior or inability to serve.

12. Now, then, we come to the great question, How is it possible that not only one nation but thirty-eight nations -- thirty-eight States covering a continent almost as big as Europe - how are their legislative and political matters managed? In no way is that possible but by Home Rule. Let me show you how deep down the principle of Home Rule goes and how far it extends, how wide-spread it is under this American system. The land of America is divided by government surveyors - and you will understand that I speak now not of the small Atlantic States which were divided before the Constitution was adopted, but of the great West and Northwest in which the majority of the American people dwell. It was divided into six mile-squares. These are called townships, and a

**councils** - To the efforts and accomplishments of those who, aware of the Revelation of Baha'u'llah, are now laboring in that continent, to their present and future course of activity, I have, in the foregoing pages sufficiently referred. A word, if the destiny of the American people, in its entirety, is to be correctly apprehended, should now be said regarding the orientation of that nation as a whole, and the trend of the affairs of its people. For no matter how ignorant of the Source from which those directing energies proceed, and however slow and laborious the process, it is becoming increasingly evident that the nation as a whole, whether through the agency of its government or otherwise, is gravitating, under the influence of forces that it can neither comprehend nor control, towards such associations and policies, wherein, as indicated by Abdu'l-Baha, her true destiny must lie. Both the community of the American believers, who are aware of that Source, and the great mass of their countrymen, who have not as yet recognized the Hand that directs their destiny, are contributing, each in its own way, to the realization of the hopes, and the fulfillment of the promises, voiced in the above-quoted words of Abdu'l-Baha. (Shoghi Effendi: The Advent of Divine Justice, pages 86-87)

Then, and only then, will the American nation, molded and purified in the crucible of a common war, inured to its rigors, and disciplined by its lessons, be in a position to raise its voice in the councils of the nations, itself lay the cornerstone of a universal and enduring peace, proclaim the solidarity, the unity, and maturity of mankind, and assist in the establishment of the promised reign of righteousness on earth. Then, and only then, will the American nation, while the community of the American believers within its heart is consummating its divinely appointed mission, be able to fulfill the unspeakably glorious destiny ordained for it by the Almighty, and immortally enshrined in the writings of Abdu'l-Baha. Then, and only

few settlers make up a township. By and by they feel the want of roads, they feel the want of everything, and they decide to have a meeting. Now, here is a record of a meeting of a similar character to that which has created thousands and thousands and thousands of councils. You will see it is most interesting. Just listen to where Home Rule begins; see its beginnings - its roots. It always reminds me of that beautiful poem of Ballantine's about the brook when

It dropped from a gray  
rock  
Upon a messy stone.

*(5) James Ballantine (1808-1877), Scottish poet.*

Yes, away up there - that is where the Home Rule stream starts. Here is what you find. Here is the township of Burlington, in Calhoun County, Michigan. "Organized in 1837, and held its first township meeting April 3 of that year, electing Justus Goodwin, supervisor; O. C. Freeman, town clerk; Justus Goodwin, Gibesia Sanders, and Moses S. Gleason, justices of the peace; Leon Haughtailing, constable and collector." That is the German element, you see, coming into

then, will the American nation accomplish "that which will adorn the pages of history," "become the envy of the world and be blest in both the East and the West." (Shoghi Effendi: *The Advent of Divine Justice*, pages 90-91)

--- Page 184. The Gospel of Wealth - X Home Rule in America

America. "Established six road districts; voted one hundred dollars to build a bridge across the St. Joseph River and fifty dollars for bridging Nottawa Creek; voted fifty dollars for common schools." Ah, gentlemen, that is a vote! Fifty dollars! The first meeting of a few stragglers in the Western wilderness, and the first thing they do is to vote fifty dollars for common schools to educate all their children free of price. Now you are getting at the roots of democracy, gentlemen. But that meeting did another thing. It voted five dollars for wolf-scalps. That throws a great light upon the situation when the wolves were so numerous that they gave a pound premium for every scalp that was brought in. Well, now, that is a beautiful picture of Home Rule. There was no superior officer there. They made themselves and created themselves into a political community. It was universal suffrage - there was no privilege. I do not find anything about who Leon Haughtailing was, or where or when he was born, or who was his grandfather; he was elected, not because he was the richest man, but because

democracy - The institutions of society will succeed in eliciting and directing the potentialities latent in the consciousness of the world's peoples to the extent that the exercise of authority is governed by principles that are in harmony with the evolving interests of a rapidly maturing human race. Such principles include the obligation of those in authority to win the confidence, respect, and genuine support of those whose actions they seek to govern; to consult openly and to the fullest extent possible with all whose interests are affected by decisions being arrived at; to assess in an objective manner both the real needs and the aspirations of the communities they serve; to benefit from scientific and moral advancement in order to make appropriate use of the community's resources, including the energies of its members. No single principle of effective authority is so important as giving priority to building and maintaining unity among the members of a society and the members of its administrative institutions. Reference has already been made to the intimately associated issue of commitment to the search for justice in all matters.

Clearly, such principles can operate only within a culture that is essentially democratic in spirit and method. To say this, however, is not to endorse the ideology of partisanship that has everywhere boldly assumed democracy's name and which, despite impressive contributions to human progress in the past, today finds itself mired in the cynicism, apathy, and corruption to which it has given rise. In selecting those who are to take collective decisions on its behalf, society does not need and is not well served by the political theater of nominations, candidature, electioneering, and solicitation. It lies within the capacity of all people, as they become progressively educated and convinced that their real development interests are being served by programs proposed to them, to adopt electoral procedures that will gradually refine the selection of their decision-making bodies.

As the integration of humanity gains momentum, those who are thus selected will increasingly have to see all their efforts in a global perspective. Not only at the national, but also at the local level, the elected governors of human affairs should, in Baha'u'llah's view, consider themselves responsible for the welfare of all of humankind. (Prosperity of Humankind, pages 14 & 15)

his fellow-citizens thought him the best man at their command. That is the first meeting of the little township of six miles. By and by other settlers come into the neighborhood and form other squares; and they hold similar meetings, and they vote for common schools. In the course of time fifteen or twenty communities have been created, and they combine. They find that they have not good enough school accommodation for each township, and that they cannot have a court-house and all the provisions for government upon so small an area; and they say, Let fifteen or twenty of us townships combine and send representatives elected by universal suffrage in proportion to our population. A convention is created for the county, and they go forward and elect county officers in the manner in which they elected their township officers, and they elect their judges. And I have sufficient faith in the democracy to say, Give me the judge elected by the people. No community in America that has ever tried the experi-



--- Page 185. The Gospel of  
Wealth - X Home Rule in  
America

ment has regretted it. I tell you the democracy is most interested in the purity of its judges. It is the poor man, the working-man, who is interested in his judges. And as all humanity has its bias, I tell you frankly that your gentlemen have the prejudices of the gentleman class, and your newly made baronets have the prejudices of the aristocracy worse than any old baronets, and your newly made lords are a disgrace to Mr. Gladstone. Well, the county goes forward - the second and larger circle of Home Rule. Observe, now, there is not what we might call a foreign element. There is no outside element, but all an outgrowth from the democracy itself. There is no divine right about it. It is a healthy, grand, glorious growth of the body politic itself. Very well, then; the county gets a little too small for their growing life. They want railroads, churches, halls. They want everything that a civilized people wants. They want everything that is good, and they get everything that is good, so far as human nature can get perfection. Twenty or thirty of these counties conclude that they

**Prejudices** - The Universal Races Congress was good, for it was intended for the furtherance and progress of unity among all nations and a better international understanding. The purpose was good. The causes of dispute among different nations are always due to one of the following classes of prejudice: racial, lingual, theological, personal, and prejudices of custom and tradition. It requires a universal active force to overcome these differences. A small disease needs a small remedy, but a disease which pervades the whole body needs a very strong remedy. A small lamp may light a room, a larger would light a house, a larger still might shine through the city, but the sun is needed to light the whole world.

The differences in language cause disunion between nations. There must be one universal language. The diversity in Faiths is also a cause of separation. The true foundation of all faiths must be established, the outer differences abolished. There must be a Oneness of Faith. To end all these differences is a very hard task. The whole world is sick, and needs the power of the Great Healer.

These meetings teach us that Unity is good, and that suppression (slavery under the yoke of tradition and prejudice) is the cause of disunion. To know this is not enough. All knowledge is good, but it can bear no fruit except by action. It is well to know that riches are good, but that knowledge will not make a man rich; he must work, he must put his knowledge into practice. We hope the people realize and know that unity is good, and we also hope that they will not be content to stand still in that knowledge. Do not only say that Unity, Love and Brotherhood are good; you must work for their realization. ('Abdu'l-Bahá in London, pages 59 & 60)

will make a State, and they elect officers by a convention as in the case of townships and counties, and they meet and establish a capital, about the center of the proposed State generally. They elect a governor and a House of Representatives, and the State Legislature is composed of two houses, one called the House of Representatives, and the other called the State Senate. The word "Congress" is never used except when the national meeting at Washington is meant. The word "Congress" is sacred to the great central power, as I trust that in the great Home Rule Bill the word "Parliament" will be sacred to that great body which will meet at Westminster and attend to international affairs. Well, now, gentlemen, the State is born in that way. Every State has its own governor; it has its own militia, its own courts, and its own judges, and it manages its own taxation. It does everything that a State can do, everything that pertains to the State itself. That is a very, very broad platform of Home Rule; but the broader

--- Page 186. The Gospel of  
Wealth - X Home Rule in  
America

you make the Home Rule

principle, always provided that it is subordinate to the national or federal principle, the better for the rulers, and the better for the people themselves.

13. Well, then, the several States, as you are aware, banded together and formed the nation. There were thirteen of them originally. The States being, as you know, before the general government, the people of America gave the general government certain delegated powers, and a comprehensive clause of the Constitution says that all powers not expressly delegated are retained by the States themselves. That is the principle of Home Rule in America. The national government is the sun of our system, and round the government the States revolve, each one on its own axis, some at one angle, some at another, ah State communities governing their own affairs in the way that seems best to them. And therefore it is impossible you can ever have a State revolution in America, any more than it is possible for a man to turn and rend himself. The State Constitution is part and parcel of its people. It is their own work; they made it, and if they do not like it they

**constitution** - Among the responsibilities assigned to Baha'i institutions which have a direct bearing on these aspects of individual freedom and development is one which is thus described in the Constitution of the "to safeguard the personal rights, freedom and initiative of individuals".

A corollary is: "to give attention to the preservation of human honour".

How noteworthy that in the Order of Baha'u'llah, while the individual willis subordinated to that of society, the individual is not lost in the mass but becomes the focus of primary development, so that he may find his own place in the flow of progress, and society as a whole may benefit from the accumulated talents and abilities of the individuals composing it.

Such an individual finds fulfillment of his potential not merely in satisfying his own wants but in realizing his completeness in being at one with humanity and with the divinely ordained purpose of creation.

The quality of freedom and of its expression -- indeed, the very capacity to maintain freedom in a society -- undoubtedly depends on the knowledge and training of individuals and on their ability to cope with the challenges of life with equanimity.

As the beloved Master has written: "And the honour and distinction of the individual consist in this, that he among all the world's multitudes should become a source of social good.

Is any larger bounty conceivable than this, that an individual, looking within himself, should find that by the confirming grace of God he has become the cause of peace and well-being, of happiness and advantage to his fellow men?

No, by the one true God, there is no greater bliss, no more complete delight." (Individual Rights and Freedoms, Articles 211-218)

can mend it.

14. Now, then, will you permit me, having sketched the American Constitution to you, to apply its provisions to the case of Home Rule at home? And in doing so you will all clearly understand that I do not represent anybody but myself. I bind nobody. The Liberal party -Gladstonian- is not responsible for what I describe as the operations of the American Constitution; and the Unionist is not responsible; and no Tory or Conservative may be alarmed upon the head of his responsibility for anything which I say. Now, then, if we were to deal with the Home Rule question, - taking this great Constitution for our guide, -I will mention in rotation four points, and just tell you how we would settle them - and we would settle them. When the democracy of America puts its foot down it stays there. The first condition is the supremacy of the national Parliament. I do not like the word "imperial." You may have an empire soon

[Baha'i Comment](#)

--- Page 187. The Gospel of  
Wealth - X Home Rule in  
America

enough. You have very nearly an Empress now, and when you get an Emperor you can use "imperial," but I prefer "national." Well, it goes without saying that when two men ride a horse one must ride behind. There must be no mistake about the powers in the general government. I will not say whether the recent bill introduced was faulty or not in its expression of that power. Unionists may contend that it was, and they have the highest possible authority for thinking the words were unfortunately vague. But of this I have not the slightest doubt, that it never entered into the brain of any man that any assembly given to Ireland or Scotland would not have to bow before the national assembly -- the Parliament. The American Constitution provides this: "This Constitution, and the acts under it passed by the national government, as interpreted by the Supreme Court, are the supreme laws of the land, anything in the State laws or State constitutions to the contrary notwithstanding." And if I were called on to settle the Home Rule question, that is

antagonistic - Firstly: He lays stress on the search for Truth. This is most important, because the people are too easily led by tradition. It is because of this that they are often antagonistic to each other, and dispute with one another.

But the manifesting of Truth discovers the darkness and becomes the cause of Oneness of faith and belief: because Truth cannot be two! That is not possible.

Secondly: Baha'u'llah taught the Oneness of humanity; that is to say, all the children of men are under the mercy of the Great God. They are the sons of one God; they are trained by God. He has placed the crown of humanity on the head of every one of the servants of God. Therefore all nations and peoples must consider themselves brethren. They are all descendants from Adam. They are the branches, leaves, flowers and fruits of One Tree. They are pearls from one shell. But the children of men are in need of education and civilization, and they require to be polished, till they become bright and shining.

Man and woman both should be educated equally and equally regarded.

It is racial, patriotic, religious and class prejudice, that has been the cause of the destruction of Humanity. ('Abdu'l-Bahá in London, pages 27 & 28)

the language I would put into the new bill. Mind you, that power being there, it has never to be exercised. It has only been exercised once in a hundred years upon an important issue, and that issue was one which no human constitution, nor all the human powers on earth, could have averted. The man or nation that tries to bind together in harmonious development freedom and human slavery has attempted the impossible, and when the great democratic forces came face to face, in the development of that country, with the slave power, which disputed its rights, one or the other had to fall; and you know which one fell. You might as well try to bind democracy and privilege. The two are antagonistic forces; and I believe the "Scotsman" newspaper of the 16th of August, in an editorial on the Northwich election, used the most significant words I have heard since I took up my residence among you. "Democracy means" -- I quote the "Scotsman" - "Democracy means, and rightly means, that privilege shall cease."

--- Page 188. The Gospel of Wealth - X Home Rule in America

15. Well, now, after what had been said about the supremacy of the national government, I ask any Unionist here to consider in his mind to-night whether he has the shadow of a fear that that will not be provided for in the new bill. Has not Mr. Gladstone said, "All parliaments, all assemblies, with statutory powers, are necessarily subordinate to their creator, and I have no objection to name the delegated powers." Now, then, when he names the delegated powers, he will follow the American Constitution.

16. The other point on which great stress is laid, and laid rightly, in my opinion and in the opinion of the American Constitution, is the question of the continued representation of Ireland in the national assembly. Well, gentlemen, a great deal has been said in this controversy about American opinion. I have asked hundreds of Americans- and you have got some intelligent Americans, no doubt, in Glasgow; ask their opinion yourselves. There is not an American living that

**subordinate** - The virtues and attributes pertaining unto God are all evident and manifest, and have been mentioned and described in all the heavenly Books. Among them are trustworthiness, truthfulness, purity of heart while communing with God, forbearance, resignation to whatever the Almighty hath decreed, contentment with the things His Will hath provided, patience, nay, thankfulness in the midst of tribulation, and complete reliance, in all circumstances, upon Him. These rank, according to the estimate of God, among the highest and most laudable of all acts. All other acts are, and will ever remain, secondary and subordinate unto them.... (Bahá'u'lláh, Gleanings, page 290)

**opinion** - What Baha'u'llah is calling for is a consultative process in which the individual participants strive to transcend their respective points of view, in order to function as members of a body with its own interests and goals. In such an atmosphere, characterized by both candor and courtesy, ideas belong not to the individual to whom they occur during the discussion but to the group as a whole, to take up, discard, or revise as seems to best serve the goal pursued. Consultation succeeds to the extent that all participants support the decisions arrived at, regardless of the individual opinions with which they entered the discussion. Under such circumstances an earlier decision can be readily reconsidered if experience exposes any shortcomings.

Viewed in such a light, consultation is the operating expression of justice in human affairs. So vital is it to the success of collective endeavor that it must constitute a basic feature of a viable strategy of social and economic development. Indeed, the participation of the people on whose commitment and efforts the success of such a strategy depends becomes effective only as consultation is made the

will not answer this question as every one has answered to me: "Would you agree that the State of Virginia should have a Legislature of its own, and be absolved from the duty of sending representatives to the national Congress at Washington to deliberate equally with all other representatives, and hence be bound equally with the others for all its acts?" And the reply is, "Never." And with the new bill I would say to any Unionists, - because I am most anxious to restore the harmony of the Liberal party, - "Gentlemen, you have a hard enough fight before you; you have many measures, the adoption of which lies deep at your heart; you need every vote and every influence at your command for this campaign." Very well, I ask any Unionist to-night to consider whether he has the slightest doubt but that the representatives of Ireland and Scotland will continue to be sent to the imperial Parliament at Westminster. I do not see how he can have a doubt. I had my doubts when the bill was cabled across the Atlantic. I could see that point clearly myself, and I took prompt measures to point out to

--- Page 189. The Gospel of Wealth - X Home Rule in

organizing principle of every project. "No man can attain his true station", is Baha'u'llah's counsel, "except through his justice. No power can exist except through unity. No welfare and no well-being can be attained except through consultation." (Prosperity of Humankind, page 8)



## America

friends here what I thought was the weak point in that bill. But, gentlemen, I thought I could do most good within the party. I have known what Mr. Gladstone has already done. There is no man living can carry reforms as he can, and if his life be spared, he *will*, I am satisfied, - I will not say I am satisfied; I know, because he has said it, that he will, -- deal with this question without touching the question of Irish representation.

17. We come to the third point - Ulster. Now I am going to apply the American Constitution to Ulster, and I tell you it is not without force in Ulster or in any part of Ireland. They will not seek anything beyond what the Americans give their States. If they do, every son of an Irishman in America -- and there are a million of such -- and every American will denounce the demand as something which upon no consideration they themselves would ask, and which every well-wisher of Great Britain prays she never will give. As to Ulster, speaking as an American Home Ruler, that is too trifling a subject to talk about among statesmen. The province of Ulster is very

## Statesmen - EXTRACTS FROM THE WRITINGS OF SHOGHI EFFENDI:

Dearly-beloved friends! Humanity, whether viewed in the light of man's individual conduct or in the existing relationships between organized communities and nations, has, alas, strayed too far and suffered too great a decline to be redeemed through the unaided efforts of the best among its recognized rulers and statesmen-- however disinterested their motives, however concerted their action, however unsparing in their zeal and devotion to its cause. No scheme which the calculations of the highest statesmanship may yet devise, no doctrine which the most distinguished exponents of economic theory may hope to advance, no principle which the most ardent of moralists may strive to inculcate, can provide, in the last resort, adequate foundations upon which the future of a distracted world can be built. No appeal for mutual tolerance which the worldly-wise might raise, however compelling and insistent, can calm its passions or help restore its vigour. Nor would any general scheme of mere organized international co-operation, in whatever sphere of human activity, however ingenious in conception or extensive in scope, succeed in removing the root cause of the evil that has so rudely upset the equilibrium of present day society. Not even, I venture to assert, would the very act of devising the machinery required for the political and economic unification of the world--a principle that has been increasingly advocated in recent times--provide in itself the antidote against the poison that is steadily undermining the vigour of organized peoples and nations. What else, might we not confidently affirm, but the unreserved acceptance of the Divine Programme enunciated, with such simplicity and force as

nearly Nationalist, and divided by the aggregate of the poll, it is Nationalist to-day. I reject with contempt and indignation the attempt, in this nineteenth century, to stir up sectarian jealousy. You know, and I know, what Scotland has done for civil and religious liberty. If there be any body of Protestant Irishmen who wish to keep themselves apart and nurse those bitter hatreds, those feuds that give rise to disturbance of the peace - if they want to do that, I am against them; and if there be any body of Catholics that wish to nurture such feuds, and keep themselves apart from their Protestant fellow-citizens, I am against them also. There is no difficulty about Ulster. Whenever you give Ireland Home Rule you will stir up a patriotic flame. And they will all be Irishmen first, and Ulster men and Tipperary men afterward, and the presence of Catholics and Protestants meeting in an assembly laboring for the national good will soften all asperities and make them under-

--- Page 190. The Gospel of Wealth - X Home Rule in America

stand each other better than they have hitherto done. The question of Ulster will settle

far back as sixty years ago, by Baha'u'llah, embodying in its essentials God's divinely-appointed scheme for the unification of mankind in this age, coupled with an indomitable conviction in the unfailling efficacy of each and all of its provisions, is eventually capable of withstanding the forces of internal disintegration which, if unchecked, must needs continue to eat into the vitals of a despairing society. It is towards this goal--the goal of a new World Order, Divine in origin, all-embracing in scope, equitable in principle, challenging in its features--that a harrassed humanity must strive.

To claim to have grasped all the implications of Bahá'u'lláh's prodigious scheme for world-wide human solidarity, or to have fathomed its import, would be presumptuous on the part of even the declared supporters of His Faith. To attempt to visualize it in all its possibilities, to estimate its future benefits, to picture its glory, would be premature at even so advanced a stage in the evolution of mankind.

All we can reasonably venture to attempt is to strive to obtain a glimpse of the first streaks of the promised Dawn that must, in the fullness of time, chase away the gloom that has encircled humanity. All we can do is to point out, in their broadest outline, to what appear to us to be the guiding principles underlying the World Order of Baha'u'llah, as amplified and enunciated by 'Abdu'l-Baha, the Centre of His Covenant with all mankind and the appointed Interpreter and Expounder of His Word. (PEACE, page 20)

itself. Left to a plebiscite of the Ulster people, you will hardly find a man that will not say, "Let us go with our country"; and I would not respect the man that did not say so, were he a hundred times a Protestant of the Protestants. That is not the Protestant religion. It is founded on private judgment and free thought, and the Irish Protestants have much to learn yet as to the fundamental principles of the faith of which they would boldly stand forth as the main adherents.

18. I now come to the fourth point. You will notice I am following the four contentions of the Unionists. Do not laugh at the Unionists. Let me tell you there were reasons for their contentions, much as I differ with them as to the mode which they took to enforce them. I think the Unionists within the councils of the Liberal party would have been much more powerful-I know the representatives of the Unionists in Parliament would have been more powerful if they had labored within the lines of the party under the banner of the only possible chief; but the Unionists whom I have met and wrestled with have always told me, "Mr.

**contention** - Consider the animosity and hatred existing today between the various nations of the world. What disagreements and hostilities arise, what warfare and contention, how much bloodshed, what injustice and tyranny! Just now there is war in eastern Turkey, also war between Turkey and Italy. Nations are devoted to conquest and bloodshed, filled with the animus of religious hatred, seeking the good-pleasure of God by killing and destroying those whom they consider enemies in their blindness. How ignorant they are! That which is forbidden by God they consider acceptable to Him. God is love; God seeketh fellowship, purity, sanctity and long-suffering; these are the attributes of divinity. Therefore these warring, raging nations have arisen against divinity, imagining they are serving God. What gross ignorance this is! What injustice, blindness and lack of realization! Briefly; we must strive with heart and soul in order that this darkness of the contingent world may be dispelled, that the lights of the Kingdom shall shine upon all the horizons, the world of humanity become illumined, the image of God become apparent in human mirrors, the law of God be well established and that all regions of the world shall enjoy peace, comfort and composure beneath the equitable protection of God. My admonition and exhortation to you is this: Be kind to all people, love humanity, consider all mankind as your relations and servants of the most high God. Strive day and night that animosity and contention may pass away from the hearts of men, that all religions shall become reconciled and the nations love each other, so that no racial, religious or political prejudice may remain and the world of humanity behold God as the beginning and end of all existence. God has created all

Gladstone is all wrong." I will tell you a story in point. Henry Clay was the most popular man America had. Well, he voted against his constituents upon the slavery question, which was the only burning question of the time, and he offered himself for reelection. There was not a ghost of a chance of his being returned to Washington, any more than there is of any Unionist being returned to the next Parliament. Well, Henry Clay saw that there was no use in conducting his canvass if he stood up to defend what he had done, so he went before the farmers of Kentucky and made one speech all over the State, "Now, boys," he said, "you have all got good, trusty rifles. Think of the game your rifle has brought down. Did your rifle ever miss fire? I have shot a good deal, and my rifle missed now and then. Did you on that account throw it away, or did you pick it up and try it again?" There

and all return to God. Therefore love humanity with all your heart and soul. If you meet a poor man, assist him; if you see the sick, heal him; reassure the affrighted one, render the cowardly noble and courageous, educate the ignorant, associate with the stranger. Emulate God. Consider how kindly, how lovingly He deals with all and follow His example. You must treat people in accordance with the divine precepts; in other words, treat them as kindly as God treats them, for this is the greatest attainment possible for the world of humanity. ('Abdu'l-Bahá, Foundations of World Unity, page 73)

--- Page 191. The Gospel of  
Wealth - X Home Rule in  
America

was no resisting such an appeal, and Clay was reelected by the greatest majority he ever received. Now, admitting all that the most conscientious or contentious Unionist has to say, I think if he has much of human nature in him, much of gratitude for past services, much of admiration for the noblest political career, he will pick up that old rifle -- Gladstone. Just let the old man have another shot.

*(6) Gladstone, at the age of eighty-three, won "another shot" in the election of 1892. He got Home Rule by the Commons, but the Lords defeated it. In 1895 the Conservatives under Salisbury returned to power.*

I will wager ten to one he will bring down the game. I will tell you another thing: I know your public men pretty well, but I do not believe you have got a rifle in the whole army, in the whole state, in the whole House of Parliament, that can bring down the game like Mr. Gladstone. Now, then, I come to the judicial question. We want to be thorough, the Tories say. We are not thorough when we oppress the people and thrust laws upon them which they do

appeal - America has arisen to spread the teachings of peace, to increase the illumination of humankind and bestow happiness and prosperity upon the children of men. These are the principles and evidences of divine civilization. America is a noble nation, the standard-bearer of peace throughout the world, shedding light to all regions. Foreign nations are not untrammelled and free from intrigues and complications like the United States; therefore, they are not able to bring about universal harmony. But America-- praise be to God!-- is at peace with all the world and is worthy of raising the flag of brotherhood and international agreement. When this is done, the rest of the world will accept. All nations will join in adopting the teachings of Baha'u'llah revealed more than fifty years ago. In His Epistles He asked the parliaments of the world to send their wisest and best men to an international world conference which should decide all questions between the peoples and establish universal peace. This would be the highest court of appeal, and the parliament of man so long dreamed of by poets and idealists would be realized. Its accomplishment would be more far-reaching than the Hague tribunal.

I am most grateful to President Taft for having extended his influence toward the establishment of universal peace. What he has accomplished in making treaties with various nations is very good, but when we have the interparliamentary body composed of delegates from all the nations of the world and devoted to the maintenance of agreement and goodwill, the utopian dream of sages and poets, the parliament of man, will be realized. ('Abdu'l-Bahá, Promulgation of Universal Peace, pages 388 & 389)

not want; we are only thorough when we go to the root of popular dissatisfaction and make our laws just. Now, the American States elect their own judges, who determine all issues between the citizens of the same State. A Pennsylvanian has the right to be tried by the courts of Pennsylvania, and to have his case decided by his fellow-citizen - the judge whose character he knows and trusts. There is no appeal beyond the Supreme Court of Pennsylvania in an issue pertaining to Pennsylvania; but, under the national Constitution, any issue between men of different States may be proceeded with in the courts of the United States. The Supreme Court of the United States sits at Washington, but it has judges in each district of the country. Sometimes one State will have one federal judge, sometimes two. Pennsylvania has two, one at Pittsburg and the other at Philadelphia, three hundred and fifty miles apart. That is matter of arrangement, and you can there have an appeal to the United States Court. Apply that to Ireland. In the first place, Irish judges already exist, and they will be

--- Page 192. The Gospel of Wealth - X Home Rule in

## America

retained. It is not likely a good judge would be dismissed.

Therefore I think the Irish executive would take over the Irish judges. It is a prima facie case that a judge is a good judge unless he can be proved bad. It will be for the Irish executive to reappoint or choose their own judges.

What I want to point out to you is that if you pay regard to the lesson of Home Rule in America, you will allow the Irish Assembly to appoint Irish judges and to determine Irish affairs; and you will hold, of course, through the delegated powers, the right, in any issues of an international character, to appeal from these courts to the imperial power, such an appeal as every Scotchman has now to the judicial lords of the House of Lords. Now, that would settle the judicial question; but if you are going to give Ireland Home Rule, and withhold from her or from Scotland, when she gets Home Rule, as I trust she soon will, the control of the highest function, and the very essential of all government, - namely, the right to execute justice and administer the laws among her own citizens, - you are going to give them a mockery; you are going to play "Hamlet" with Hamlet left

out, and you will have the Irish question upon you again and again in worse forms than it is now.

19. You must make the judicial power in Ireland respected in Ireland, and you cannot do that unless it derives its powers from the Irish government. I do not profess that the Liberal party has quite clearly sounded this note, but I trust the democracy will watch with clear eye the clause giving judiciary powers to Ireland. You cannot give Home Rule to Ireland if you take from the government the power to enforce its decrees; you may as well bind the government, Mazeppa-like,

*(7) A reference to the famous story of the young Pole, tied naked to the back of a wild horse by the jealous husband of the lady with whom he had an intrigue. Among various literary treatments, that of Byron's Mazeppa is perhaps the best known.*

on a wild horse, without whip, spur, or bridle, and expect peace and good government and loyalty in Ireland if you deny to the Irish executive the highest of all

--- Page 193. The Gospel of Wealth - X Home Rule in America

**judicial** - The purpose is to emphasize the statement that consultation must have for its object the investigation of truth. He who expresses an opinion should not voice it as correct and right but set it forth as a contribution to the consensus of opinion, for the light of reality becomes apparent when two opinions coincide. A spark is produced when flint and steel come together. Man should weigh his opinions with the utmost serenity, calmness and composure. Before expressing his own views he should carefully consider the views already advanced by others. If he finds that a previously expressed opinion is more true and worthy, he should accept it immediately and not willfully hold to an opinion of his own. By this excellent method he endeavors to arrive at unity and truth. Opposition and division are deplorable. It is better then to have the opinion of a wise, sagacious man; otherwise, contradiction and altercation, in which varied and divergent views are presented, will make it necessary for a judicial body to render decision upon the question. Even a majority opinion or consensus may be incorrect. A thousand people may hold to one view and be mistaken, whereas one sagacious person may be right. Therefore, true consultation is spiritual conference in the attitude and atmosphere of love. Members must love each other in the spirit of fellowship in order that good results may be forthcoming. Love and fellowship are the foundation. ('Abdu'l-Bahá, Promulgation of Universal Peace, page 72 & 73)



political functions - the administration of law and the maintenance of peace and order. So says the American Constitution.

20. Now, I will touch upon one point - the land question. Every State of the American Union has a right to make a kirk or a mill of its land if it pleases. It is its own. If the soil of a nation is not the property of that nation, and if you are not going to allow Ireland to manage its own land, what are you going to allow it to manage? The land question is at the foundation of everything in the State, and you find that the Land Bill

*(8) One means of pacifying Irish discontent had been the Gladstonian effort to make more just the arrangements under which Irish tenants held land. These tenants often held their land "at will," subject to six months notice; their rent, a "rack rent," was fixed by competitive bidding, and if evicted from their holdings they received no compensation for improvements or compelled landlords to pay for improvements if tenants were evicted through no fault of their own. Parnell and the Irish Land League agitated for fixity of tenure, fair rent set by the courts, and free sale by tenants of their interests to other tenants. Gladstone's Land Act of 1881 granted these three F's. In 1885 Parliament passed an act for state assistance to land purchases by tenants; the aim was a peasant proprietary.*

is discarded - rightly so, and

[Baha'i Comment](#)

Mr. Gladstone has said that the sands have run for the landlords. That is too good to believe. I doubt even Mr. Gladstone's power to make a bill as it ought to be in regard to land, because in the Liberal councils you have lots of Irish landlords. Lord Hartington is a large Irish landlord with a rental of thirty thousand pounds a year. I know he is a sincere and honest man, but I know Burns says that

When self the wavering  
balance shakes,  
It's rarely richt adjusted.

*(9) Robert Burns, "Epistle  
to a Young Friend, May,  
1788," stanza 3.*

No man should sit as a judge in its own cause, and in America no man who is directly interested in an act of Legislature can constitutionally vote upon it. I am afraid you will have to buy out the landlords before you can get done with them. The poor democracy, the toiling millions of Great Britain, will be mulcted in an enormous sum. Many members of

--- Page 194. The Gospel of Wealth - X Home Rule in America

Parliament are interested in land, and there is that tone in society which seems to say that property in land is different from property in everything else, because for hundreds of years the land has been held up by infamous laws to maintain a class of people who, if left to the free competition of economic forces, would go down in the struggle for existence.

21. Well, what is the solution to the land question? It is a very easy one. Let it alone; let the Irish executive settle with the Irish landlords. The democracy has never been anything but generous in its acts, and it will be generous to the Irish landlords when upon their executive is placed the responsibility of settling with them - if it decides to buy the land at all. I am not in favor of the executive of Ireland touching the land of Ireland, or of the executive of Great Britain touching the land of Great Britain. Let me give a hint to the democracy. You are past the days of unearned increment, and upon the days of earned decrement, and any man foolish enough to counsel the people of Great Britain to

**property** - Since the body of humankind is one and indivisible, each member of the race is born into the world as a trust of the whole. This trusteeship constitutes the moral foundation of most of the other rights -- principally economic and social -- which the instruments of the United Nations are attempting similarly to define. The security of the family and the home, the ownership of property, and the right to privacy are all implied in such a trusteeship. The obligations on the part of the community extend to the provision of employment, mental and physical health care, social security, fair wages, rest and recreation, and a host of other reasonable expectations on the part of the individual members of society. (Prosperity of Humankind, page 6)

**land** - The earth is one native land, one home; and all mankind are the children of one Father. God has created them, and they are the recipients of His compassion. Therefore, if anyone offends another, he offends God. It is the wish of our heavenly Father that every heart should rejoice and be filled with happiness, that we should live together in felicity and joy. The obstacle to human happiness is racial or religious prejudice, the competitive struggle for existence and inhumanity toward each other. ('Abdu'l-Bahá, Promulgation of Universal Peace, page 468)

take over the land to-day in a falling market may have his own interest at heart, but he cannot have yours. It is said that the people of Ireland will not do justice to the landlords. No, I hope not. In my wildest and most vindictive moments I have never yet gone so far as to wish that the Irish landlords had justice. No; let us remember that mercy should in that case season justice. But they will get generous treatment, and the democracy of Great Britain can be absolved from all trouble with the land of Ireland if they strengthen Mr. Gladstone's hands, and tell him in unmistakable tones that there are a great many things the democracy of this country will do, and a great many things they will suffer, but, as the Lord helps them, they will never be found on the side of Irish landlords as against Irish, tenants, or pay one penny toward buying their land.

**22. There may be some exceedingly patriotic men here who have been saying in their hearts, "We do not want to Americanize our institutions." Why not? The Americans have taken from you everything they could lay their hands upon. They have taken your Constitution and bettered it; they have**

**Patriotic** - We must find a way of spreading love among the sons of humanity.

Love is unlimited, boundless, infinite! Material things are limited, circumscribed, finite. You cannot adequately express infinite love by limited means.

The perfect love needs an unselfish instrument, absolutely freed from fetters of every kind. The love of family is limited; the tie of blood relationship is not the strongest bond. Frequently members of the same family disagree, and even hate each other.

Patriotic love is finite; the love of one's country causing hatred of all others, is not perfect love! Compatriots also are not free from quarrels amongst themselves.

The love of race is limited; there is some union here, but that is insufficient. Love must be free from boundaries!

To love our own race may mean hatred of all others, and even people of the same race often dislike each other.

Political love also is much bound up with hatred of one party for another; this love is very limited and uncertain.

The love of community of interest in service is likewise fluctuating; frequently competitions arise, which lead to jealousy, and at length hatred replaces love. ('Abdu'l-Bahá, Paris Talks, page 36)

The attainment of any object is conditioned upon knowledge, volition and action. Unless these three conditions are forthcoming there is no execution or accomplishment. In the erection of a house it is first necessary to know the ground and design the house suitable for it; second, to obtain the means or funds necessary for the construction; third, to actually build it. Therefore a power is needed to carry out and execute what is known and admitted to be the remedy for human conditions; namely, the unification of mankind. Furthermore, it is evident that this cannot be realized through material process and means. The accomplishment of this unification cannot be through racial power, for races are different and diverse in tendencies. It cannot be through patriotic power, for nationalities are unlike. Nor can it be effected through political power since the policies of governments and nations are various. That is to say, any effort toward unification through these material means would benefit one and injure another because of unequal and individual interests. Some may believe this great remedy can be found in dogmatic insistence upon imitations and interpretations. This would likewise

be without foundation and result. Therefore it is evident that no means but an ideal means, a spiritual power, divine bestowals and the breaths of the Holy Spirit will heal this world sickness of war, dissension and discord. Nothing else is possible; nothing can be conceived of. But through spiritual means and the divine power it is possible and practicable. (Foundations of World Unity, Page 101)

### --- Page 195. The Gospel of Wealth - X Home Rule in America

taken your literature, your laws; they have taken your language, and if you would take from America everything that America has to give you, or everything that America ever will have to give you, there would remain a huge, incalculable balance yet left in favor of the parent land. Why should you not take things from your child if you know they are for your good? But your own colony of Canada has practically the same Constitution, as far as Home Rule is concerned. If there be any man who forgets that America is your own child, let him look to Canada - she is practically the same. Do you think that the English-speaking race throughout the world, with the same language, the same traditions, - because all Americans claim your traditions, with the same literature, with the same religion - do you think that it is in the power of man to prevent all English speaking people ultimately from having

**political institutions** - The Baha'i Commonwealth of the future, of which this vast Administrative Order is the sole framework, is, both in theory and practice, not only unique in the entire history of political institutions, but can find no parallel in the annals of any of the world's recognized religious systems. No form of democratic government; no system of autocracy or of dictatorship, whether monarchical or republican; no intermediary scheme of a purely aristocratic order; nor even any of the recognized types of theocracy, whether it be the Hebrew Commonwealth, or the various Christian ecclesiastical organizations, or the Imamate or the Caliphate in Islam - none of these can be identified or be said to conform with the Administrative Order which the master-hand of its perfect Architect has fashioned....

Let no one, while this System is still in its infancy, misconceive its character, belittle its significance or misrepresent its purpose. The bedrock on which this Administrative Order is founded is God's immutable Purpose for mankind in this day. The Source from which it derives its inspiration is no one less than Baha'u'llah Himself. ... The central, the underlying aim which animates it is the establishment of the New World Order as adumbrated by Baha'u'llah. The methods it employs, the standard it inculcates, incline it to neither East nor West, neither Jew nor Gentile, neither rich nor poor, neither white nor colored. Its watchword is the unification of the human race; its standard the "Most Great Peace." ... February 8, 1934.

The contrast between the accumulating evidences of steady consolidation that accompany the rise of the Administrative Order of the Faith of God, and the forces of disintegration which batter at the fabric of a travailing society, is as clear as it is arresting. Both within and outside the Baha'i world the signs and tokens which, in a mysterious manner, are heralding the birth of that World Order, the establishment of which must signalize the Golden Age of the Cause of God, are growing and multiplying day by day....

"Soon," Baha'u'llah's own words proclaim it, "will the present day Order be rolled up, and a new one spread out in its stead."... (Bahá'u'lláh and the New Era, pages 278-279)

the same political institutions? I will not venture to say what the political institutions of the English race may be in the future. It may be that the "Scotsman" is right, and that democracy means that privilege shall die, and it may be that all English-speaking people will range themselves together upon a platform which develops the extremest rights of man, and the political equality of the citizen. That is possible. It may be possible, on the other hand, you may say, that the majority of the English-speaking race will turn its back upon this advanced political development, and, seeking out some prince, will go back and make him a perpetual king, and make his children kings hereafter, whether they be fools or idiots or not, and spend hundreds of thousands of their hard-won earnings every year to support the entire brood in vulgar riot and ostentation; and it may be that we will create another aristocracy, and that I shall so far forget myself and my lineage, as the direct descendant of weavers and shoemakers - glorious Radicals some of them have been, who have gone to jail just for attending such a meeting as was interrupted in Ireland the other day! - it may be that I will forget that and parade before you as a

baronet. Then you will say,  
"We

--- Page 196. The Gospel of  
Wealth - X Home Rule in  
America

don't know how we will treat Mr. Carnegie coming to visit us; he is not a nobleman, and he has ceased to be a gentleman." But whatever be the system of political institutions adopted in the future, - you may have it either way, - one point I venture to stand by, and that is that the English-speaking race throughout the world is to have the same institutions. If you can adopt some of the provisions of the American Constitution for this emergency, you will have hastened by so much the day when your institutions shall be the same as the institutions of the English-speaking race. How long will it take after that assimilation is perfected before we have a federal council that will forever render it impossible that the blood of the English-speaking man can be shed by English-speaking man? Where lies your greatest hope that your own race, the dominant power of the world, shall coalesce and form a union against which nothing on earth shall stand? In the assimilation of your

**Institutions** - For Baha'u'llah, we should readily recognize, has not only imbued mankind with a new and regenerating Spirit. He has not merely enunciated certain universal principles, or propounded a particular philosophy, however potent, sound and universal these may be. In addition to these He, as well as Abdu'l-Baha after Him, has, unlike the Dispensations of the past, clearly and specifically laid down a set of Laws, established definite institutions, and provided for the essentials of a Divine Economy. These are destined to be a pattern for future society, a supreme instrument for the establishment of the Most Great Peace, and the one agency for the unification of the world, and the proclamation of the reign of righteousness and justice upon the earth. Not only have they revealed all the directions required for the practical realization of those ideals which the Prophets of God have visualized, and which from time immemorial have inflamed the imagination of seers and poets in every age. They have also, in unequivocal and emphatic language, appointed those twin institutions of the House of Justice and of the Guardianship as their chosen Successors, destined to apply the principles, promulgate the laws, protect the institutions, adapt loyally and intelligently the Faith to the requirements of progressive society, and consummate the incorruptible inheritance which the Founders of the Faith have bequeathed to the world. (World Order of Bahá'u'lláh, pages 19 & 20)



institutions. There lies the point. And where is the hope of that great day which the poet sings of

When the drum shall  
beat no longer, when  
the battle-flags are  
furled,  
In the Parliament of  
Man, the Federation of  
the World?

*(10) See Essay VIII, note  
7.*

It lies in the great beneficent principle of Home Rule. Home Rule for each of the divisions, with a central authority over all to keep them in order; and in that congregation of English-speaking people, in that future Parliament - I know not how many divisions, I know not what their size or number, I know not their positions, but I know the position of one power is fixed, immovable, perpetual, and secure - that of this glorious little island.

There may be many children clustering around her in that Parliament of Man; there can only be one mother. I say cursed be the arm and withered the tongue of any man, wherever found, who would strive to keep apart, by word or by deed, those children from that mother.

Carnegie Text Goes Here

[Baha'i Comment](#)

**MENU: [HOME](#) » [Reconstruction](#) » [Gospel Content](#) » [Gospel Purpose](#)**

---

---

# The Gospel of Wealth

And Other Timely Essays

by Andrew Carnegie

**In the right-hand commentary column,  
that which is in GREEN is a commentator's remark and  
that which is in BLUE is from the Baha'i Writings.  
On occasion, in that column, there may be a [link](#) to an extended comment or  
dissertation on the subject under discussion.**

- -

***A reminder that under "view" on your browser - you can set the text size UP  
or DOWN for a more comfortable read for yourself.***

--- Page 197. The Gospel of Wealth - XI Does America Hate England?

## XI

### Does America Hate England?

*(1) From the Contemporary Review, LXXII (November 1897), 660-668.*

1. THIS question has been much discussed of late in Britain: and the answer has generally been given in the affirmative; even the Spectator, a powerful and true friend of the Republic, has been reluctantly driven to that side.

hatred - "O friends, help the Oppressed One with well-pleasing virtues and good deeds! Today let every soul desire to attain the highest station. He must not regard what is in him, but what is in God. It is not for him to regard what shall advantage himself, but that whereby the Word of God which must be obeyed shall be upraised. The heart must be sanctified from every form of selfishness and lust, for the weapons of the unitarians and saints were and are the fear of God. That is the buckler which guardeth man from the arrows of hatred and abomination. ('Abdu'l-Bahá, A Traveler's Narrative, page 45 & 46)

2. But the correct answer to this inquiry depends upon what is meant by hatred; for this may be of two kinds - one deep, permanent, generally racial, which creates hereditary antipathy and renders the parties natural enemies; the other only temporary and skin-deep - indignation and resentment aroused by specific questions, which pass with their settlement, leaving no serious estrangement behind.

hatred - My hope is that through the zeal and ardour of the pure of heart, the darkness of hatred and difference will be entirely abolished, and the light of love and unity shall shine; this world shall become a new world; things material shall become the mirror of the divine; human hearts shall meet and embrace each other; the whole world become as a man's native country and the different races be counted as one race.

Then disputes and differences will vanish, and the Divine Beloved be revealed on this earth. ('Abdu'l-Bahá in London, page 38)

3. That several causes exist which must always create more or less irritation in the United States against Great Britain is obvious. The Canadian question must always do so. Imagine Scotland republican, owing allegiance to the United States, and constantly proclaiming its readiness to attack Britain at their bidding. The industrial question also has its effect. A score of articles "made in Germany" are causing irritation in England. What can a thousand articles "made in England" be expected to do in the United States? Industrial competitors, and the workmen employed by them, are very sensitive and easily irritated; and in our day, when every nation of the front rank aspires to manufacture and produce for

irritation - In these days when the peoples of the world are thirsting for the teachings of the Abha Beauty--teachings that provide the incomparable, life-giving waters of immortality--when we Baha'is have pledged ourselves to proffer these living waters to all mankind and are known to be prepared to endure every suffering and tribulation, how pitiful it would be if, despite all this, we were to neglect our binding obligations and responsibilities and to occupy ourselves with disagreeable discussions that provoke irritation and distress and to turn our attention to matters that lead to ill-feeling, to despondency and unhappiness and reduce the penetrating influence of the Word of God. (Bahiyiyh Khanum, page 197)

its own wants, "Foreign Commerce" and "Free Trade" do not always make for peace and good will among

--- Page 198. The Gospel of Wealth - XI Does America Hate England?

nations, but the contrary. Nations are disposed to resent industrial invasion, Free-Trade Britain not less than Protective Germany.

4. But deeper than these causes of irritation there does lie at the core of the national heart of the Republic a strong and ineradicable stratum of genuine respect, admiration, and affection for the old home. The pride of race is always there at the bottom - latent, indeed, in quiet times, but decisively shown in supreme moments when stirred by great issues which affect the safety of the old home and involve the race. The strongest sentiment in man, the real motive which at the crisis determines his action in international affairs, is racial. Upon this tree grow the one language, one religion, one literature, and one law which bind men together and make them brothers in time of need as against men of other races. This racial sentiment goes

racial - "A world community in which all economic barriers will have been permanently demolished and the interdependence of capital and labour definitely recognized; in which the clamour of religious fanaticism and strife will have been forever stilled; in which the flame of racial animosity will have been finally extinguished; in which a single code of international law--the product of the considered judgement of the world's federated representatives--shall have as its sanction the instant and coercive intervention of the combined forces of the federated units; and finally a world community in which the fury of a capricious and militant nationalism will have been transmuted into an abiding consciousness of world citizenship--such indeed, appears, in its broadest outline, the Order anticipated by Baha'u'llah, an Order that shall come to be regarded as the fairest fruit of a slowly maturing age." (Promise of World Peace, page 11)

Other wars are caused by purely imaginary racial differences; for humanity is one kind, one race and progeny inhabiting the same globe. In the creative plan there is no racial distinction and separation such as Frenchman, Englishman, American, German, Italian or Spaniard; all belong to one household. These boundaries and distinctions are human and artificial, not natural and original. All mankind are the fruits of one tree, flowers of the same garden, waves of one sea. In the animal kingdom no such distinction and separation are observed. The sheep of the East and the sheep of the West would associate peacefully. The oriental flock would not look surprised as if saying, "These are sheep of the Occident; they do not belong to our country." All would gather in harmony and enjoy the same pasture without evidence of local or racial distinction. The birds of different countries mingle in friendliness. We find these virtues in the animal kingdom. Shall man deprive himself of these

deeper and reaches higher than questions of mere pecuniary import, or of material interests. The most recent proof that this pride of race exists in America in an intense degree was given, even at the very height of the Venezuelan dispute,

*(2)The Venezuelan dispute, one of the major diplomatic fireworks of the nineties, went off because Venezuela and Great Britain could not agree upon the boundary between the former and British Guiana. Venezuela had for years proposed arbitration; in 1895 Cleveland and his Secretary of State, Richard Olney, insisted Britain arbitrate, since the application of her claims violated the Monroe Doctrine. Salisbury rejected the proposal and denied the American interpretation of the Monroe Doctrine. Cleveland proposed to Congress the appointment of a commission to investigate the merits of the disputants and added that after the investigation the United States would resist as aggression any "appropriation" of Venezuela's lands by Great Britain. Britain's freedom of action was limited by the outbreak of violence between British "outlanders" and the Boers in the Transvaal in South Africa. The German Emperor openly congratulated President Paul Kruger of the Boers for maintaining the independence of his country Britain under Salisbury and Chamberlain, Secretary for Colonial Affairs, decided to liquidate the American quarrel and concentrate on South Africa. Consequently, England and Venezuela in February 1897 agreed to arbitration; on the tribunal of reference were two Justices of the American Supreme Court as well as British and neutral representatives. The award came in 1899.*

virtues? Man is endowed with superior reasoning power and the faculty of perception; he is the manifestation of divine bestowals. Shall racial ideas prevail and obscure the creative purpose of unity in his kingdom? Shall he say, "I am a German," "I am a Frenchman," or an "Englishman" and declare war because of this imaginary and human distinction? God forbid! (Foundations of World Unity, page 23)

*Carnegie's picture of the American reaction to the Boer War is inaccurate. There was a "wild cheer," but it was not out of character. American opinion is predisposed to support under-dog nations, especially when an issue of independence is involved. Irish-Americans and German-Americans there anti-British; and so were the New York world and the New York Times, though not the Hearst papers. Bryan and the Democrats were pro-Boer. Official opinion, on the other hand, accorded with the Carnegie formula. John Hay (183&1905), Secretary of State, wrote: "I hope, if it comes to blows, that England will make quick work of Uncle Paul"; and President McKinley stood off all demands for American intervention. "Uncle Paul" is of course Paul Kruger (1825-1904), president of the Transvaal.*

*Carnegie's real opinions on the issues were as tangled as the issues themselves. He deplored Cleveland's attitude on the Venezuelan affair. In a private letter, later than this essay, he wrote he was with the Boers heart and soul.*

when it was suspected that a combina-

--- Page 199. The Gospel of Wealth - XI Does America Hate England?

tion of European Powers was behind Germany's action in regard to the Transvaal, which had for its aim the humiliation and ruin of Britain, and was taking advantage of the family quarrel to begin the partition of the possessions of the only other member of our race. When the plucky little island

took up the challenge and prepared without a moment's hesitation to meet the world in arms, the American continent, from Maine to California, might be said to have burst forth in one wild cheer - a cheer which meant more than prosaic people will believe, and more, perhaps, than uncontrollable outburst; nor can one tell how far this impulse, which he could not check, would lead him when once in full swing. Senator Wolcott

*(3) Edward Oliver Wolcott (1848-1905), Senator from Colorado.*

only expressed in the Senate what the outside millions felt; the average American just said to himself: "This is our own race; this is what we do; this is how we do it. Of course we have some difference of our own with her, and we do not intend to let even our motherland light the torch of war upon our continent; she must arbitrate all questions concerning territory here - but this is a little family matter between ourselves. It does not mean that German, Russian, and Frenchman, or any foreigners, may combine to attack our race to its destruction, without counting us in. No, sir-ee."



**5. No combination of other races is likely to estimate at a tithe of its true value the strength of this sentiment throughout our race, or correctly to gauge how very much thicker**

**--- Page 200. The Gospel of Wealth - XI Does America Hate England?**

**than water our race-blood will be found if it is ever brought to the test.**

**Races** - Praise be to God! The medieval ages of darkness have passed away and this century of radiance has dawned, this century wherein the reality of things is becoming evident, wherein science is penetrating the mysteries of the universe, the oneness of the world of humanity is being established, and service to mankind is the paramount motive of all existence. Shall we remain steeped in our fanaticisms and cling to our prejudices? Is it fitting that we should still be bound and restricted by ancient fables and superstitions of the past, be handicapped by superannuated beliefs and the ignorances of dark ages, waging religious wars, fighting and shedding blood, shunning and anathematizing each other? Is this becoming? Is it not better for us to be loving and considerate toward each other? Is it not preferable to enjoy fellowship and unity, join in anthems of praise to the most high God and extol all His Prophets in the spirit of acceptance and true vision? Then, indeed, this world will become a paradise, and the promised Day of God will dawn. Then, according to the prophecy of Isaiah, the wolf and the lamb will drink from the same stream, the owl and the vulture will nest together in the same branches, and the lion and the calf pasture in the same meadow. What does this mean? It means that fierce and contending religions, hostile creeds and divergent beliefs will reconcile and associate, notwithstanding their former hatreds and antagonism. Through the liberalism of human attitude demanded in this radiant century they will blend together in perfect fellowship and love. This is the spirit and meaning of Isaiah's words. There will never be a day when this prophecy will come to pass literally, for these animals by their natures cannot mingle and associate in kindness and love. Therefore, this prophecy symbolizes the unity and agreement of races, nations and peoples who will come together in attitudes of intelligence, illumination and spirituality. ('Abdu'l-Bahá, Promulgation of Universal Peace, page 369-370)

**6. The message which President McKinley sent to Queen Victoria at her Jubilee was another evidence of race pride, and was no mere formal effusion. More men in the United Kingdom than in the United States would hesitate to compliment and praise her Majesty and sing "God Save the Queen" with enthusiasm. She is universally recognized there as the truest of the true friends of the Republic, for she**

**pride** - O BRETHREN! Be forbearing one with another and set not your affections on things below. Pride not yourselves in your glory, and be not ashamed of abasement. By My beauty! I have created all things from dust, and to dust will I return them again. (Bahá'u'lláh, Hidden Words #48 from the Persian)

stood a friend when a friend was needed."

*(4) Victoria and her subjects celebrated the Queen's "diamond jubilee" in 1897. She had reigned sixty years. The allusion to the friendship of Queen is probably to her supposed preference for the North during Civil War, Actually it was the Prince Consort, with his immense influence over the Queen, who slowed down ministerial belligerence against Federal Union.*

7. It is strange that such evidences of race unity at bottom, and of genuine, cordial friendship, should not outweigh some alleged lack of courtesy of expression in a message written by a President to his own Congress or by a Secretary of State to his own minister. Yet the Spectator concludes Americans hate England, and this opinion it bases upon trifles as these.

*(5) In the Venezuela crisis Cleveland's special message to Congress on October 17, 1895, proposing to investigate the merits of claims to disputed territory and to support Venezuela's rightful claims, contained both cautious conditional clauses and cryptic utterances foreboding war. The latter made a great impression at the time. Richard Olney (1835-1917), Secretary State, had previously dispatched a communication to the American Minister in London, directing him to find out if Britain would arbitrate the dispute and asserting, "Today the United States is practically sovereign on continent." While the Spectator*

race unity - "The work of the Race Unity Committee should include, as far as is feasible, contacts with all minority groups, and wherever there is a particularly stout prejudice against a special group--such as the feeling against the Japanese in the Western states and the Negroes in the Southern, etc.,--efforts should be made to counteract it by showing publicly the Baha'i example of loving tolerance and brotherly association." (From a letter written on behalf of Shoghi Effendi to an individual believer, December 30, 1945)

*regarded with pleasurable anticipation possibility that the Monroe Doctrine would make the Anglo-Saxon supreme in Latin America, it objected to the schoolmasterish and pompous tone of these American utterances.*

**8. Much stress has been laid in the discussion upon American school-books reciting the facts of American history; this is held to make every American boy and girl a hater of England. This is undoubtedly true; and the pity of it is there is no possible escape, for American history begins with the revolt of the colonies and their struggle for the rights of**

**--- Page 201. The Gospel of Wealth - XI Does America Hate England?**

**Britons. The Republic has never had a dangerous foe except Britain, for the short campaign against Mexico made no lasting impression upon the nation. It is impossible to do otherwise than state the facts as they occurred; and even if there were added the further facts that some of the greatest and best of British statesmen opposed the attempt to tax the colonies even at that early day, and that now the kindness and consideration with which Britain reigns over her colonies gives an example**

**hater** - The only division that is real is this: There are heavenly men and earthly men; self-sacrificing servants of humanity in the love of the Most High, bringing harmony and unity, teaching peace and goodwill to men. On the other hand there are those selfish men, haters of their brethren, in whose hearts prejudice has replaced loving kindness, and whose influence breeds discord and strife. ('Abdu'l-Bahá, Paris Talks, page 149)

to the whole world, these things would make no impression upon children. The young American must begin in our day as an intense hater of England; and this we must accept: generations will elapse before it can be greatly modified.

9. On the other hand, it is impossible for any American to acquire further and more detailed knowledge of the struggle for independence, of the later treatment of her colonies by Britain, and of British history and the part his race has played in the Old World, without becoming her admirer, and, should he have British blood in his veins, -- which most Americans can boast, - without being very proud of his race. It is upon this foundation that we have to build our hopes of closer union between the old and the new lands. Englishmen and Hessians fighting Washington must give place in the minds of the young, as they grow older, to other pictures in which Britain and America are seen standing side by side, the two great pillars of civil and religious liberty throughout the world, and the sole members of our race. Later must come the knowledge of Shakspeare, Milton, Burns, and Scott; then

### Liberty

59 Expounding the theme of liberty, Baha'u'llah asserted that "the embodiment of liberty and its symbol is the animal"; that "liberty causeth man to overstep the bounds of propriety, and to infringe on the dignity of his station"; that "true liberty consisteth in man's submission unto My commandments".

60 "We approve of liberty in certain circumstances," He declared, "and refuse to sanction it in others."

61 But He gave the assurance that, "Were men to observe that which We have sent down unto them from the Heaven of Revelation, they would, of a certainty, attain unto perfect liberty."

62 And "Mankind in its entirety must firmly adhere to whatsoever hath been revealed and vouchsafed unto it.

63 Then and only then will it attain unto true liberty." (The Universal House of Justice, Individual Rights and Freedoms

the political history of England, Cromwell, Sidney, Russell, Hampden, Chatham, Burke, and the many others, until the young American learns that from Britain he has derived, not only his language, but his laws, religion, and even his free institutions; and that the political institutions of the two countries are similar -- one crowned, the other uncrowned, yet both republican, since in both there is government of the people, for the people, and by the people, which is the es-

--- Page 202. The Gospel of Wealth - XI Does America Hate England?

sence of republicanism. This is the chief point which influences the ardent young politician, and gives the old land at last a warm place in the heart of young America. From this time on, the race sentiment grows stronger and stronger in his heart as knowledge increases.

10. How different with the young Canadian and Australian, who learn with their first lessons that the rights of Britons have never been denied them, and find in Britain the most generous, most illustrious, and kindest of mothers, whom they reverence and love from the beginning. Such are the opposite results of tender and proper regard for colonies and dependencies, and of denial to them of the rights and liberties enjoyed at home.

rights and liberties - The unification of the world of humanity, the welding together of the world's different religions, the reconciliation of Religion and Science, the establishment of Universal Peace, of International Arbitration, of an International House of Justice, of an International Language, the Emancipation of Women, Universal Education, the abolition not only of Chattel Slavery, but of Industrial Slavery, the Organization of Humanity as a single whole, with due regard to the rights and liberties of each individual--these are problems of gigantic magnitude and stupendous difficulty in relation to which Christians, Muhammadans and adherents of other religions have held and still hold the most diverse and often violently opposed views, but Baha'u'llah has revealed clearly defined principles, the general adoption of which would obviously make the world a paradise. (Bahá'u'lláh & New Era, page 256)

11. Whether at this day seeds of future hatred or affection are being sown in the hearts of the millions to come in various parts of the world, should be the vital Question for statesmen engaged in empire-building. What an expanding nation would here do "highly, that should she holily," for assuredly empire founded upon violent conquest, conspiracy, or oppression, or upon any foundation other than the sincere affection of the people embraced, can neither endure nor add to the power or glory of the conquerer, but prove a source of continual and increasing weakness and of shame.

affection - "O friends, consort with all the people of the world with joy and fragrance. If there be to you a word or essence whereof others than you are devoid, communicate it and show it forth in the language of affection and kindness: if it be received and be effective the object is attained, and if not leave it to him, and with regard to him deal not harshly but pray. The language of kindness is the lodestone of hearts and the food of the soul; it stands in the relation of ideas to words, and is as an horizon for the shining of the Sun of Wisdom and Knowledge." ('Abdu'l-Bahá, A Traveler's Narrative, Page 43)

**12. While, in the opinion of the writer, there is no deep-seated, bitter national hatred in the United States against Britain, there is no question but there has been recently a wave of resentment and indignation at her conduct. This has sprung from two questions:**

**opinion** - The diversity in the human family should be the cause of love and harmony, as it is in music where many different notes blend together in the making of a perfect chord. If you meet those of different race and colour from yourself, do not mistrust them and withdraw yourself into your shell of conventionality, but rather be glad and show them kindness. Think of them as different coloured roses growing in the beautiful garden of humanity, and rejoice to be among them.

Likewise, when you meet those whose opinions differ from your own, do not turn away your face from them. All are seeking truth, and there are many roads leading thereto. Truth has many aspects, but it remains always and forever one.

Do not allow difference of opinion, or diversity of thought to separate you from your fellow-men, or to be the cause of dispute, hatred and strife in your hearts.

Rather, search diligently for the truth and make all men your friends. Every edifice is made of many different stones, yet each depends on the other to such an extent that if one were displaced the whole building would suffer; if one is faulty the structure is imperfect. ('Abdu'l-Bahá, Paris Talks, page 53 & 54)

**13. First, Ambassador Pauncefote and Secretary of State Blaine, years ago, agreed upon a settlement of the Bering Sea question,**

*(6) The migratory fur seals generally resorted for breeding purposes to islands over which the American government, after the purchase of Alaska exercised jurisdiction. The American government sought to save the fur seals from extinction by domestic protective legislation. Since seals could still be taken on the high seas, these steps were inadequate. Pursuant to a treaty of 1892, negotiated by Pauncefote (1828-1902), British ambassador in Washington, and Blaine, the Bering Sea claims were referred to an international tribunal. It rejected the American claims to the exercise of a wide oceanic jurisdiction and enforced a*

**treaties** - "...Every system, short of the unification of the human race, has been tried, repeatedly tried, and been found wanting. Wars again and again have been fought, and conferences without number have met and deliberated. Treaties, pacts and covenants have been painstakingly negotiated, concluded and revised. Systems of government have been patiently tested, have been continually recast and superseded. Economic plans of reconstruction have been carefully devised, and meticulously executed. And yet crisis has succeeded crisis, and the rapidity with which a perilously unstable world is declining has been correspondingly accelerated. A yawning gulf threatens to involve in one common disaster both the satisfied and dissatisfied nations, democracies and dictatorships, capitalists and wage-earners, Europeans and Asiatics, Jew and Gentile, white and coloured. An angry Providence, the cynic might well observe, has abandoned a hapless planet to its fate, and fixed irrevocably its doom. Sore-tried and disillusioned, humanity has no doubt lost its orientation, and would seem to have lost as well its faith and hope. It is hovering, unshepherded and visionless, on the brink of disaster. A sense of fatality seems to pervade it. An ever-deepening gloom is settling on its fortunes as she recedes further and further from the outer fringes of the darkest zone of its agitated life and penetrates its very heart." (Shoghi Effendi: The World Order of Baha'u'llah, p. 190)

*payment to Canadian sealers for vessels illegally taken. In 1811 Russia, Japan, Britain, and the United States joined in a treaty protecting the seals in the North Pacific.*

and Lord Salisbury telegraphed his congratula-

--- Page 203. The Gospel of Wealth - XI Does America Hate England?

tions, through Sir Julian Pauncefote, to Mr. Blaine. The two nations were jointly to police the seas and stop the barbarous destruction of the female seals. Canada appeared at Washington and demanded to see the President of the United States upon the subject. Audience was denied to the presumptuous colony; nevertheless, her action forced Lord Salisbury to disavow the treaty. No confidence here is violated, as President Harrison referred to the subject in a message to Congress. Britain was informed that if she presumed to make treaties in which Canada was interested without her consent, she would not have Canada very long. It will be remembered that Canada took precisely the same position in regard to international copyright. It is this long-desired treaty-making power which Canada



has recently acquired for herself, at least as far as concerns fiscal policy, so that she need no longer even consult her suzerain. She can now appear at Washington and insist upon being received when new tariff measures are desired, having suddenly become a "free nation," according to her Prime Minister. There are surprises in store here for the indulgent mother.

14. The repudiation of the Bering Sea settlement aroused a deep feeling of resentment, not only among the uninformed, but among the educated class of Americans, who were and are Britain's best friends; and this has been greatly embittered by charges, commonly made in British publications, that the United States has failed to adhere to the findings of the Bering Sea tribunal. Nothing could be more baseless than such a charge. The tribunal decided that the United States were liable for certain vessels seized which carried the British flag, and payment was directed to be made, either of a stated sum by mutual agreement, or, failing this, of damages to be assessed by a commission. The United States Secretary

**Tribunal** - A Supreme Tribunal shall be established by the peoples and Governments of every nation, composed of members elected from each country and Government. The members of this Great Council shall assemble in unity. All disputes of an international character shall be submitted to this Court, its work being to arrange by arbitration everything which otherwise would be a cause of war. The mission of this Tribunal would be to prevent war. ('Abdu'l-Bahá, Paris Talks, page 155)

--- Page 204. The Gospel of  
Wealth - XI Does America  
Hate England?

of State agreed to a fixed sum with Ambassador Pauncefote, "subject to an appropriation by Congress" - those are the very words of the agreement. When the bill was presented in Congress for an appropriation, the ex-chairman of the Committee on Foreign Relations, Mr. Hitt,

*(7) Robert R. Hitt (1834-1908).*

rose and stated that it had been discovered that the fishing-boats in question were really owned, to a great extent, by naturalized Americans. Evidence had been found that a blacksmith in San Francisco, a British subject, had been paid one hundred dollars to take title to these boats, so that the British flag could be prostituted to cover the killing of the female seals, which was unlawful under American law. Only about one fifth of the amount claimed was due to Canadians; the remainder of the claim belonged to naturalized Americans, who had broken American laws by engaging in this nefarious and unlawful traffic. Mr. Hitt asked that the right of the Government, under the award, to have these claims examined by a

commission, be exercised. Congress agreed to this, and the Commission was promptly appointed and ratified by the Senate unanimously. It is now sitting, and the result, we venture to prophesy, will vindicate the contention of the United States Government - viz., that a fraud has been attempted. Yet many British papers at intervals have repeated the charge that the United States Government has been false to its obligations under the Bering Sea award. Charges of national dishonor - and such a charge involves this - always cause intense bitterness. Writers who make them falsely, as in this case, have much to answer for.

15. Much offense had been taken in Britain at Secretary Sherman's

*(8) John Sherman was Secretary of State, 1897-1898.*

recent message about the destruction of the seals. It is said that he has not observed the usual diplomatic reserve and courtesy. Granted; but had he not some excuse for plain speaking? It is stated that before Mr. Sherman's letter was written -- to his own minister, be it remembered,

**conference** - In this Cause consultation is of vital importance, but spiritual conference and not the mere voicing of personal views is intended. In France I was present at a session of the senate, but the experience was not impressive. Parliamentary procedure should have for its object the attainment of the light of truth upon questions presented and not furnish a battleground for opposition and self-opinion. Antagonism and contradiction are unfortunate and always destructive to truth. In the parliamentary meeting mentioned, altercation and useless quibbling were frequent; the result, mostly confusion and turmoil; even in one instance a physical encounter took place between two members. It was not consultation but comedy. ('Abdu'l-Bahá, Promulgation of Universal Peace, page 5)

--- Page 205. The Gospel of  
Wealth - XI Does America  
Hate England?

not to the British Government - Lord Salisbury had already refused a conference on the subject. After that letter Lord Salisbury thought better of it, and agreed to the conference, which is to meet immediately in Washington. How this matter is viewed in America is shown by the following cable from Washington in to-day's (September 20) newspapers:

The officials of the State Department are not disposed to comment upon the correspondence which has been published relating to the fur-seal question between Great Britain and the United States. They say, however, that it shows that the object sought by the Government of the United States for the past three years has been attained by the agreement of Great Britain to participate in a conference to be held in October. They point out that the refusal of the British Government heretofore to consent to such a conference led to the transmission to Mr. Hay, United States

ambassador in London, of Mr. Sherman's note of May 10, which was followed by Lord Salisbury's reply agreeing to hold a conference.

16. The whole Bering Sea business has been mismanaged by Britain - as is believed, contrary to her real wishes - simply because she could not govern her colony; the colony has governed her, as she will under Sir Wilfrid Laurier

*(9) Laurier (1841-1919) was the first French Canadian to become Premier.*

and his successors hereafter, as time will show.

17. The second cause of the bitter hostility which has been aroused recently against Britain is her conduct upon the Venezuela question. Let us look at the facts in this case. For many years the United States Government urges upon Great Britain in the most courteous manner that the territorial dispute with Venezuela, her small republican neighbor, should be settled amicably by arbitration. The sixteen American republics having agreed to settle their disputes

[Baha'i Comment](#)

[hostility](#) - "Consider the harmful effect of discord and dissension in a family; then reflect upon the favours and blessings which descend upon that family when unity exists among its various members. What incalculable benefits and blessings would descend upon the great human family if unity and brotherhood were established! In this century when the beneficent results of unity and the ill effects of discord are so clearly apparent, the means for the attainment and accomplishment of human fellowship have appeared in the world. His Holiness Baha'u'llah has proclaimed and provided the way by which hostility and dissension may be removed from the human world. He has left no ground or possibility for strife and disagreement. First he has proclaimed the oneness of mankind and specialized religious teachings for existing human conditions." (Lights of Guidance, page 220, # 732)

[arbitrate](#) - In short, every means that produces war must be checked and the causes that prevent the occurrence of war be advanced;--so that physical conflict may become an impossibility. On the other hand, every country must be properly delimited, its exact frontiers

by arbitration,

*(10) Blaine, long an advocate of inter-America co-operation, when he became Secretary of State in Harrison's administration pushed hard to establish an Inter-American Union. The first Inter-American conference assembled in Washington in 1889. The conference failed to establish a customs union, as Blaine had hoped it would, and fell short of tangible short-run accomplishments on other matters. Carnegie had been appointed as one of ten United States delegates to the conference and was partially instrumental in finding a way through the arbitration thicket which confused the conference debates. The conference failed to adopt arbitration as a principle of "American international law" or to compel recourse to it. It did make conquest in defiance of arbitration inadmissible. Nor did the governments later ratify this feature of the conference's work. However, the conference did succeed in establishing a permanent secretariat at Washington which developed into the Pan-American Union. Andrew Carnegie later gave a building to house the Union's activities.*

it is hoped that Britain will not attempt to light

--- Page 206. The Gospel of Wealth - XI Does America Hate England?

the torch of war upon the American continent. Mr. Gladstone's administration, through Earl Granville, foreign minister, agree to arbitrate. Lord Salisbury enters upon office, and immediately withdraws from the

marked, its national integrity secured, its permanent independence protected, and its vital interests honoured by the family of nations. These services ought to be rendered by an impartial, international Commission. In this manner all causes of friction and differences will be removed. And in case there should arise some disputes between them, they could arbitrate before the Parliament of Man, the representatives of which should be chosen from among the wisest and most judicious men of all the nations of the world. (Universal House of Justice, Peace, page 18 & 19)

agreement and refuses to arbitrate. Repeated requests from the United States are made without result. Finally, President Cleveland appears upon the scene. Now, President Cleveland has one great wish namely, to bring about a treaty of arbitration between Great Britain and the United States. It was my privilege to introduce the first Parliamentary committee that approached him upon the subject. The interest he took in it was surprising, and his intimate friends well know that the consummation of the treaty of peace lies nearest his heart of all public questions. He is, beyond all things, a believer in the peaceful arbitration of international disputes.

18. He asks Britain for a final reply. Will she, or will she not, arbitrate this territorial dispute with Venezuela? Upon his return to Washington, one evening, from a journey, he reads the refusal of Lord Salisbury, and writes his message before he retires for the night. It gives great offense in Britain, but this is because the British people do not know that for fifteen years the United States Government has been begging Great Britain to arbitrate this question, and that Britain has

[Baha'i Comment](#)

agreed to do so. The message is not addressed to the British Government, but to the American Congress, and the President concludes by stating in effect that it will be the duty of the United States Government to protect Venezuela should Britain presume to enforce her own views of her territorial rights.

19. There is no question but that the United States would have

--- Page 207. The Gospel of Wealth - XI Does America Hate England?

fought, or will to-day fight, any nation - even Britain -- in defense of the principle of peaceful arbitration upon questions relating to the territorial rights of foreign Powers upon the American continent. Sixteen of the seventeen American republics have agreed to arbitrate their differences, and why should a European Power be permitted to make war on that continent thus dedicated to arbitration? Nations have their red rags. Every one knows that Great Britain would fight in defense of her right of asylum. Every one knows that she would defend her colonies to the extent of her power. There should be no mistake made by

**arbitration** - In past ages humanity has been defective and inefficient because it has been incomplete. War and its ravages have blighted the world; the education of woman will be a mighty step toward its abolition and ending, for she will use her whole influence against war. Woman rears the child and educates the youth to maturity. She will refuse to give her sons for sacrifice upon the field of battle. In truth, she will be the greatest factor in establishing universal peace and international arbitration. Assuredly, woman will abolish warfare among mankind.... ('Abdu'l-Bahá, The Promulgation of Universal Peace, page 108)



the British people upon this point, that the United States will not permit any European nation to attack an American State in consequence of a territorial dispute. These claims are to be settled by peaceful arbitration.

20. It is not alone the uninformed masses of the American people whose passions would be inflamed in support of war in defense of this principle, but the educated classes who will be found most determined in its defense; and it is upon these educated classes, for reasons stated, that Britain must depend for friends, because it is with education alone that there can come a just estimate of the past, and a knowledge of the position which the British people hold to-day in regard to colonial liberties and to international arbitration. It is deeply to be regretted that, although public sentiment in Britain forced Lord Salisbury to accept peaceful arbitration, as requested by the United States Government, nevertheless the majority of the American people cannot be successfully reached and impressed with that fact. The educated people, who follow foreign affairs, do know and appreciate that the best

[Baha'i Comment](#)

people in America had with them the best people in Great Britain in favor of settlement by arbitration, but to the masses it must unfortunately appear that Britain refused arbitration until forced to accept it by the United States. The truth, however, fortunately for our race, is that Lord Salisbury was forced by his own people to recede from his posi-

--- Page 208. The Gospel of Wealth - XI Does America Hate England?

tion. The questions which Britons might ask themselves, when seeking for some explanation of the hatred aroused in the United States recently against their country, seem to be these: Does not a nation deserve to be hated which refuses to fulfill its agreement to arbitrate a territorial dispute with a weak power? Is not irritation justified against a nation which, having agreed to a treaty settling seal fisheries, repudiates it at the dictation of a colony with which the other contracting party has nothing whatever to do?

21. These are the only two questions which have recently aroused the United States against Britain. In that of Venezuela, we have seen that the unfortunate hatred engendered was wholly unnecessary and caused solely by Lord Salisbury refusing to carry out the agreement of his predecessor. Arbitration asked for by the United States has now been agreed to, and the question will soon be out of the way, and, let us hope, soon forgotten, although the triumph of the principle of peaceful arbitration in this case should ever be remembered.

[Baha'i Comment](#)

22. The other question, that of pelagic sealing, is now to be in conference again, as before asked for by the United States, but also refused by Lord Salisbury, - at first, -- and in a fair way toward settlement; and let us hope it is soon also to be forgotten, always excepting that in this case also the principle of peaceful arbitration was invoked and peace preserved through the Bering Sea tribunal, even after the treaty agreed to was canceled upon Canada's demand.

[arbitration](#) - A Supreme Tribunal shall be established by the peoples and Governments of every nation, composed of members elected from each country and Government. The members of this Great Council shall assemble in unity. All disputes of an international character shall be submitted to this Court, its work being to arrange by arbitration everything which otherwise would be a cause of war. The mission of this Tribunal would be to prevent war. ('Abdu'l-Bahá, Paris Talks, page 155)

23. With the removal of these two causes of hatred there remains not a serious cloud upon the horizon between the two branches of our race at present. The proposed general treaty of arbitration is again to be taken up under happier conditions. It is greatly to Lord Salisbury's credit that he proposed it; and in recognition of this service to the cause of peace and good will between the two nations, Americans are disposed to forgive and forget his unfortunate refusal to abide by the agreement of his country to arbitrate the

--- Page 209. The Gospel of Wealth - XI Does America Hate England?

Venezuelan question. As for the denunciation of the Bering Sea treaty which had been agreed upon with Secretary Blaine, no one conversant with the circumstances holds him responsible. He could not have successfully withstood Canada, and there was nothing for him to do but to repudiate.

[Baha'i Comment](#)

24. The treaty, which failed of ratification, obtained, let it always be remembered, within six votes of the necessary two-thirds majority of the Senate. A greater number than these six votes was thrown against it for reasons with which the treaty itself had nothing whatever to do. Into the personal and political history of the opposition to the treaty, which President McKinley declared it was our duty to pass, it would, however, be unprofitable to enter. It is impossible to obtain a two-thirds majority for any measure which becomes involved in the vortex of party politics and personal quarrels. A treaty of peace between the two branches of our race is certain to come. The pulpit, the press, the universities of the United States are its ardent supporters, President McKinley and his Cabinet being among the foremost. No other question before the nation enlists such general enlightened support from the best men of both parties. There is, therefore, no reason in the world why the two nations should not now again draw closer and closer together. On both sides of the Atlantic each should be careful hereafter to give to the other no just cause of offense, and it may be taken as true that, Briton and American being of

[Baha'i Comment](#)

the same race, what would be offensive to the one would be equally so to the other.

25. Both Briton and American can dwell with the greatest satisfaction upon this fact, which recent events have conclusively proven, that there is in each country so powerful an element favoring peace within the race that no Government, however strong, either in the old land or in the new, can decline peaceful arbitration, when offered by the other, as the Christian substitute for the brutal test of war. No small compensation this, even for the estrangement which has arisen over two questions, but which is now rapidly passing

--- Page 210. The Gospel of Wealth - XI Does America Hate England?

away, leaving fortunately unimpaired in the Republic that element which may be trusted to determine international action in a crisis -  
- pride of race, a force lying too deep in the national heart to be revealed upon calm seas, but which, under the recent swing of the tempest, bared its great head high enough above the surge to be seen and noted of all men - a dangerous rock upon a fatal

peace - We have enjoined upon all mankind to establish the Most Great Peace--the surest of all means for the protection of humanity. The sovereigns of the world should, with one accord, hold fast thereunto, for this is the supreme instrument that can ensure the security and welfare of all peoples and nations. They, verily, are the manifestations of the power of God and the daysprings of His authority. We beseech the Almighty that He may graciously assist them in that which is conducive to the well-being of their subjects. A full explanation regarding this matter hath been previously set forth by the Pen of Glory; well is it with them that act accordingly. ("Tablets of Bahá'u'lláh revealed after the Kitab-i-Aqdas", p. 126)

shore for other races in  
combination to strike against,  
if ever they attempt to sail  
that unsailed sea.

**MENU:** [HOME](#) » [Reconstruction](#) » [Gospel Content](#) » [Gospel Purpose](#)

# The Gospel of Wealth

And Other Timely Essays

by Andrew Carnegie

**In the right-hand commentary column,  
that which is in GREEN is a commentator's remark and  
that which is in BLUE is from the Baha'i Writings.**

**On occasion, in that column, there may be a [link](#) to an extended comment or  
dissertation on the subject under discussion.**

- -

**A reminder that under "view" on your browser - you can set the text size UP  
or DOWN for a more comfortable read for yourself.**

--- Page 211. The Gospel of Wealth - XII Imperial Federation

## XII

### Imperial Federation

*(1) From the Nineteenth Century, XXX (September 1891), 490-508. A renewed interest in colonies and the nature of their relationship with the mother country arose in the eighties. The movement has often been called the "new imperialism"; in England it took the form of a difference of opinion and sentiment between "Little Englanders" and the advocates of a "Forward" movement. In 1884 the Imperial Federation League brought together politicians, journalists, and intellectuals, like Sir John Robert Seeley (1834-1895), James Bryce (1838-1922), and Froude, on a vague platform advocating closer imperial ties. While the League had a concrete accomplishment in the calling of the First Colonial Conference in 1887 at the time of Victoria's golden jubilee, it was always riven by schisms over matters of free trade and preferential tariffs within the Empire. Either of these suggested programs involved a modification of the English traditional policy of free trade. The passage of the McKinley Tariff Act of 1890 by the United States, with its high rates and proffer of reciprocity between the United States and certain raw-material-producing nations, so alarmed more extreme English imperialists that they formed in 1891 the United Empire Trade League. Its founder and secretary announced: "The whole object of empire is commerce and the extension of commercial relations." Neither manifestoes nor zeal could budge politicians in places of responsibility, including Salisbury, or still quarrels within the Imperial Federation League. It dissolved in 1894; the United Empire Trade League continued.*



1. THE time seems opportune for acting upon the suggestion of the editor of this review, that I should elaborate an idea expressed in a previous article touching the unity of the English-speaking race, and the relations which the parts thereof are to bear to each other; for the "Imperial Federation" and the "United Empire Trade League" are prominently upon the stage, and the monthly magazines and daily press freely discuss the subject. Each of the two societies named has recently been granted an interview with the Prime Minister, and each has been advised by him in turn to take the first forward step and furnish at least rough outlines of its

--- Page 212. The Gospel of Wealth - XII Imperial Federation

plans. It is a fact of much significance that so antagonistic are the views held by these two organizations that the second to be heard by Lord Salisbury thought necessary, previous to its interview, to request that he should not commit himself to the ideas of the first -- evidence of an anxiety which seems to have been wholly unnecessary, as it is evident from Lord Salisbury's

[Baha'i Comment](#)

reply that neither of the societies, so far, has been able to lay before him anything requiring consideration. He has wisely called for a bill of particulars, having had enough of glittering generalities. This is a challenge which admits of no denial if these societies are to justify their continued existence. If they cannot formulate a plan, surely they will retire.

2. Before the permanent relations of the parts of the race to each other can be properly considered, however, we must pay some attention to the two phases of the "federation idea" represented by them.

[Baha'i Comment](#)

3. The United Empire Trade League attends strictly to business; there is no sentiment about it - trade all over, and nothing but trade. We have, therefore, only to consider, as far as it is concerned, whether Britain and her colonies would make good bargains by banding together against the outside world, and giving to each other more favorable terms than to outsiders. Reduced to this, it becomes simply a matter of figures. The Zollverein idea is here, but the

[Baha'i Comment](#)

## Kriegsverein absent.

*(2) In the first part of the nineteenth century various German states under the leadership of Prussia formed the customs union known as the Zollverein. Kriegsverein, to employ the Carnegie vernacular, went beyond trade to joint action in time of war.*

Let us, therefore, first consider how Britain would fare under the proposed new departure. She exports about £250,000,000 of her products yearly. Of these, the English-speaking self-governing colonies take £31,000,000, or one eighth; India takes about the same amount; all the other British possessions £20,000,000; in all, about £82,000,000, leaving fully double that amount taken by other countries. It is proposed to discriminate against the customers

--- Page 213. The Gospel of Wealth - XII Imperial Federation

who consume £166,000,000 in favor of those who consume half that amount. With British imports it is just the same, for in 1889 imports and exports to colonies, etc., were only £187,000,000 out of a total of £554,000,000 - one third to the dependencies against two thirds to the foreigners. If there were a prospect of the

former trade growing more rapidly than the other, it might be held that the future would justify the sacrifice, but there is nothing to encourage this view; on the contrary, colonial and Indian trade both tend to decline, while that with foreign nations increases. The reason is clear; the older nations have developed their resources, and trade with them is now practically upon its final basis; the colonies have only recently begun to supply their own wants, and are yet to extend their capacity greatly in this direction. It is scarcely to be expected that with double their present population their demands upon Britain will be much increased. Indeed, the present tendency to decline may continue for a time.

4. The important question is, What response would the nations of the world make to a declaration of industrial war against them? Had Britain and her colonies remained a compact free-trade Empire, like the forty-four States of the Republic, which furnish the world with the best proof of the blessings of free trade, other nations would have no right to object. It is quite a different matter, however, if, when their trade has been established and business built

[Baha'i Comment](#)

upon the other basis, change and disaster should now be visited upon them. A change in the policy of Britain toward other nations, I submit, must now be followed by a change of their policy toward Britain. Discrimination must produce discrimination. The Republic of the United States, for instance, is Britain's greatest customer, taking more of British products than all the English-speaking colonies combined, and more and more every year, while the trade with the colonies is, at best, stationary, notwithstanding their increase of population. It has slightly declined during the past five years. What the

--- Page 214. The Gospel of Wealth - XII Imperial Federation

Republic would do if she were discriminated against needs no guess, for she has recently lodged in the President power to go so far as to prohibit entirely the products of any country that does so.

*(3) Carnegie is manipulating a "paper dragon." The McKinley Tariff of 1890 threatened a prohibition of trade as a means of securing reciprocity; the device was directed against certain products and certain nations, for example Latin America, rather than against Great Britain. The trade in fresh beef to Great Britain took the form of exports of live animals and, after the application*

*of refrigeration to transportation, of chilled or frozen meat. Both of these trades threatened beef producers in Great Britain, but their powerful interest was never able to induce the government to embargo or discriminate by tariff against the American product. Occasionally the British government, alarmed by Texas fever or the "lung plague," pleuropneumonia, clapped on quarantines or enforced them more strictly. A minor dust-up on this score occurred in 1891. In spite of such episodes the fresh beef trade to Great Britain expanded enormously from the seventies on.*

Britain is called upon to justify her discrimination against American cattle, for instance, and nothing is surer than that the American people will have to be entirely satisfied that there is good cause for it, or the President will be forced by public sentiment to exercise this power, conservative, patient, and most peace-loving though he be. There would not be two parties upon this issue.

5. How about Germany? She takes from Britain every year products to the amount of about £18,000,000, twice that taken by the whole of British North America, and not far from that taken by the whole of Australasia (£22,000,000). She sends Britain about £3,000,000 per year of flour and cereals, of butter and eggs £1,500,000, of timber

[Baha'i Comment](#)

£1,500,000. What is to be the answer of the irrepressible Emperor if the products of his country are discriminated against in favor of the food products and timber of Canada and Australia? Italy, again, takes about as much of British products as the whole of British North America, £7,000,000, and she finds here each year a market to the extent of £3,000,000 for her hemp, fruits, etc. The Argentine Republic takes from £10,000,000 to £11,000,000 per annum from Britain; the whole of British North America only £8,000,000. What is to be the return shot fired by her if her mutton, wool, and grain which

--- Page 215. The Gospel of Wealth - XII Imperial Federation

she sends here are to be discriminated against? But why continue the list? It is the same story everywhere.

6. Britain has the foreign trade of all her colonies almost exclusively already, except that of Canada, of which she has nearly one half, the United States possessing rather more. All the other colonies deal with foreign nations only to the extent of from five to ten per cent for articles which Britain does not produce. The parent-land, therefore, has nothing to gain by any change in fiscal relations between herself and the colonies; her colonial trade, except perhaps to a small extent with Canada, could not be increased thereby. Why, then, should she jeopardize the control of the markets of the world to the extent of two thirds of her total exports, for nothing'? The fabled dog which dropped the bird from his mouth had for excuse that its shadow in the stream seemed infinitely larger. The Imperial Trade League is not so excusable. It would sacrifice a real turkey in hand for nothing in the bush. This wondrous little island is dependent upon the world for two thirds of its food-supply; equally dependent upon the markets of the world for the sale of its products. There never was so great a people so artificially maintained. What the race has accomplished here under these conditions dwarfs the

[Baha'i Comment](#)



triumphs of all other races; it is marvelous, and if it were not before our eyes, it would be held impossible that a nation so placed could have yet led the world. One asks instinctively what such a breed of men will do when they control continents possessed of unbounded supplies of agricultural and mineral resources combined; but that she, being so placed, should be counseled by a body of able men to inaugurate an industrial war against the world seems something not to be accounted for by any process of reason. Russia, the Argentine or the Brazilian Republic, with its ports blockaded for ten years, would suffer only more or less inconvenience. The United States would emerge from such an embargo stronger and more independent of the world than before. Close the ports of this island for a year,

--- Page 216. The Gospel of Wealth - XII Imperial Federation

and her people would suffer for food. Britain's house is a whole Crystal Palace - she of all nations should be the last to begin stone-throwing.

7. From something in the national character, but much more in the part she has had to play in the world, Britain has excited the envy, jealousy, and ill will of some of the most powerful nations; but I do not believe that my native land has an enemy so bitter as to wish her to plunge into an industrial war which would be so cruelly fatal to her, for even the worst foe must feel that the human race owes an incalculable debt to Britain. It would be a different matter if the imposition of protective duties were proposed bearing equally upon the products of all other countries, for this is a matter for each nation to settle for itself, and other nations could take no offense if Britain decided to reimpose such duties. This would be no declaration of industrial war against other nations, but only a matter of home policy. There is no vital objection to this being tried; although I am certain that free trade is Britain's only policy as I am a thorough disciple of John Stuart Mill - and, I am pleased to add, of his worthy successor, Professor Marshall

*(4) Alfred Marshall (1842-1924),  
British economist.*

-in believing that the countries  
which have the necessary

[Baha'i Comment](#)

resources within themselves do well to encourage the starting of industries by protecting them for a time against the competition of those firmly rooted in other lands, always, however, with the view of ultimately obtaining a surer and cheaper source of supply within themselves. But the question for Britain is this: Given a nation with a thoroughly equipped manufacturing system producing more than its own people can consume, and which, on the other hand, is dependent for its food-supply upon other nations, what is its policy? The answer seems clear: Peace and free trade with all the world.  
Cobden and Bright

*(5) Richard Cobden (1804-1885);  
John Bright (1811-1889).*

were right for Britain, and only wrong in assuming, in their enthusiasm, that what was wise

--- Page 217. The Gospel of  
Wealth - XII Imperial  
Federation

for an old country producing more articles than it could consume was necessarily wise for every country, including those which had diversified home industries yet to establish. Mill and Marshall are

right for new countries, always provided such have within themselves the necessary resources and adequate market to eventually furnish the articles at less cost to the consumer than would have to be paid if dependent upon a foreign supply. Thus the United States has succeeded by protection in getting the millions of square feet of plate-glass she uses per annum at less cost than a similar article costs in Europe. She often has her steel rails at less than these could be imported for free of duty. She has failed, however, to produce cheaply her supply of sugar by protection. Hence she wisely abandons the attempt, and makes foreign sugar free. Now, because Britain has not the requisite territory to increase greatly her food-supply, any tax imposed upon food must be permanent. The doctrine of Mill does not, therefore, apply, for protection, to be wise, must always be in the nature of only a temporary shielding of new plants until they take root. It will surprise many if Britain ever imposes a permanent tax upon the food of her thirty-eight millions of people, with no possible hope of ever increasing the supply, and thereby reducing the cost, and thus ultimately rendering the tax unnecessary. A tax for

a short period that fosters and increases production, and a tax for all time which cannot increase production, are different things.

8. But if, in the near future, Britain decides to try the old system of protection again, no irremediable injury need ensue, for results will soon prove that free trade is for her the very breath of her nostrils, and she may be able successfully to return to it because she will not have outraged the feelings and incurred the hostility of her former best customers. All will have been treated alike, and therefore none will have reason to complain; although it is always to be remembered that trade once diverted is most difficult to regain.

--- Page 218. The Gospel of Wealth - XII Imperial Federation

The loss owing to this will not be small. While, therefore, it is open to Britain to try "protection," and pay the cost of the experiment, and retrace her steps, he is a bold man who ventures to place an estimate upon the permanent loss to his country which is surely involved in entering upon the "Empire trade" crusade.

[Baha'i Comment](#)

9. Turning from the British and the foreigners' points of view in regard to the proposed industrial crusade against the world, the reply of the colonies to an invitation to join it has yet to be considered.

[Baha'i Comment](#)

10. Let us begin with Canada, the greatest of these. As already stated, she finds a market for more of her products in the neighboring Republic than in the parent-land. She also finds it to her advantage to purchase more from the former than from the latter. During the winter months she is indebted to the courtesy of the Republic for regular communication with the outside world; her steamships land at Portland in Maine, and her traffic, in bond, and her people travel through American territory to reach Quebec or Montreal. Her boasted east-and-west railway system would scarcely pay expenses - it certainly would yield no returns - except that the Republic generously permits it to connect with American railways and compete with them upon equal terms for the traffic to and from Chicago and the great West to Boston, New York, and the East, and to

[Baha'i Comment](#)

transport foreign goods in bond to Chicago and the West. The Canadian Pacific transverses the entire width of the State of Maine. All the ships of Canada receive rights in American ports which are denied to American fishing-vessels in Canadian ports. Any day the Republic thinks proper to resent the acts of her saucy little neighbor, which have recently been annoying, she can practically "bottle up" Canada without giving any cause of complaint from an international point of view. She has simply to withhold privileges now generously granted. It need not be feared that so strong and forbearing a nation will act tyrannously to one so completely in her power. The Republic

--- Page 219. The Gospel of Wealth - XII Imperial Federation

has always been the kindest and most neighborly of neighbors to all her less powerful sisters; *but the power is there*, and this being so, I should like to ask our United Empire Trade League friends what answer Canada would be likely to make to their proposition to discriminate in favor of Britain as against the Republic. Canada may yet, in justice to herself, be compelled to do

just the reverse. There is a large party in Canada in favor of such a step. An invitation from Britain to enter upon the policy of discrimination would require Canada to consider for her own interests in whose favor the discrimination should be. The idea suggested by the League may thus return to plague the inventor. Truly our friends of the Trade League have found and are brandishing a dangerous weapon.

11. With the Australasian colonies the case is different. These have no overshadowing giant alongside; but there is another element there which I submit is equally potent. New South Wales, the largest of the group, imports £23,000,000; exports just about the same. Her total trade with Great Britain, exports and imports, is only one third of this -- something over £15,000,000. Victoria, the other great colony, imports and exports £37,500,000; Britain has of these between £12,000,000 and £13,000,000 - just about one third, as in the case of New South Wales.

[Baha'i Comment](#)



12. But Britain need not be jealous in regard to the remainder; for, as before stated, with the exception of from five to ten per cent of the total, which she cannot supply, she has it all. So far has Australasia advanced under the policy of encouraging home manufactures that the various colonies are able to supply the wants of one another to the extent of about two thirds of their total requirements - a most encouraging state of affairs, as promising the creation of a mighty nation of English-speaking people in the near future. Does any member of our "Fair Trade League" believe that a proposition would be entertained for a moment to lower duties upon articles from Britain, and hence to injure or

--- Page 220. The Gospel of Wealth - XII Imperial Federation

destroy the manufactures of their sister colonies? Has any indication been seen of a desire upon the part of any of these colonies to abandon the high aim each has set before itself of becoming a great power with diversified industries, capable of supplying its own necessary

[Baha'i Comment](#)

wants? The members of the League should endeavor to place themselves in the position of Canada and of Australia, and judge in the case of Canada what its reply to their idea must be, and in the case of Australia what it would be. The officials of that society are, no doubt, preparing their answer to the challenge given by the Prime Minister, and it is to be hoped that it will deal with the points here suggested.

13. Turning now to the Imperial Federation League, we find no business whatever in its program; no considerations of trade; bargains are not thought of; sentiment reigns supreme. Still, it is not so grandly sentimental as it was. A painful falling away is noted. In its early days it pleased many to note that, in their praiseworthy desire for federation, the majority of the English-speaking race in the Republic was never forgotten; but we find no trace of this in the recent proceedings; even my friend Mr. Bolton seems to have abandoned the great idea which first roused his enthusiasm, and which still stirs mine. In his article in the July number of this review he regretfully says:

[Baha'i Comment](#)

If it may not be given to us to realize that grand idea, the confederation of all the nations which have sprung from the race nurtured in these isles, should we not at least use all our energies to promote the union and political consolidation of the Greater Britain which still owns one flag and acknowledges one sovereign?

*(6) S. B. Bolton, "Sir John Macdonald on Imperial Federation," Nineteenth Century, XXX (July 1891), 159-160.*

14. We have not yet heard from Lord Rosebery, the president, for reasons which call forth for him the deepest sympathy of all.

*(7) Rosebery was one of the charter members of the Imperial Federation League and a member of its executive body. Compelled to assume political responsibilities, he stood against extremists in the League. He thought it should be "educational" and encourage colonial and imperial conferences, but he could not fit imperial preference into his program.*

It is still possible we shall find, in the first address he

--- Page 221. The Gospel of Wealth - XII Imperial Federation

[Baha'i Comment](#)

delivers upon the subject, that his hopes of the union of the entire race may still be brighter than those expressed by officials who have spoken for the Federation in his absence. For the present, I take it, we must assume that, like the Trade League, it seeks no longer harmony and cooperation among the various parts of the race. It stands now as a body whose effort is to combine only the minority of the English-speaking race in a solid phalanx, leaving out the majority. While, in the case of the first society, it was necessary to go into particulars, in that of the latter it seems only necessary to examine its aim as recently presented.

15. It is deemed possible to create a solid empire, under one head, of parts of the English-speaking race, one the mother country, another in Canada, the third in Australia, each with different environments and totally different problems to solve; and one of the three parts under wholly different institutions from the other two, the latter being democracies without a trace of hereditary privilege, aristocracy, church and state, or entails of the soil, and the

[Baha'i Comment](#)

very air breathed there instilling ideas of political equality in the citizen. It is notable that this hope is chiefly confined to the parent-land, and to those born here who have played great parts till now in the colonies. Such men as Sir John A. Macdonald, Sir Henry Parkes, Sir Samuel Griffith, and others,

*(8) Sir John A. Macdonald (181E~ 1891) was frequently after 1857 a Conservative prime minister of Canada; Sir Henry Parkes (1815-1896) after 1872 served often as prime minister of New South Wales; and Sir Samuel W. Criffith (1845-1920) was prime minister of Queensland.*

are not colonists but natives of Britain, and must ever reverence and love her. But the population of Australasia is already nearly three native to one British-born. In Canada, in 1881, more than four fifths were native-born, and every year the percentage of British-born grows less and less. Not one of five thousand native-born Canadians, nor of ten thousand born Australians, has ever seen or ever can see Britain, which to

--- Page 222. The Gospel of Wealth - XII Imperial Federation

the masses is only a name - no doubt a name which they can never mention without

pride and gratitude, but still only a name, not a country; and a country every man worthy of the name of man will have and worship.

16. The native-born Australian is Australian first and last; the native-born Canadian the same. The public ear of my native land is sadly led astray about the feeling of her colonies, because she hears only the voices of her own people, native-born Britons, or a few rich visitors speaking in the name of the colonies. It is these who principally visit the old home, crossing the seas, drawn hither by longings, as pilgrims to their Mecca. The masses of the people in the colonies permit and even encourage upon the part of these native-born Britons the expression of the tenderest sentiments toward their native land; for they know that men are not worthy of the confidence and respect of the communities in which they dwell if they fail in affection for the land which gave them birth, and that the colonist who does not love his native land is not likely to prove much of an acquisition to his adopted one. But it will save much disappointment if the people at home can be made to understand and believe that the following truly represents

[Baha'i Comment](#)

the sentiments of ninety-nine out of every hundred native-born Canadians and Australians. I quote the words of the Premier of the important province of Quebec, Mr. Mercier,

*(9) Honore Mercier (1840-1894),  
premier and attorney-general  
(1887).*

who, being asked, whether he was opposed to federation, replied:

Yes, I am. I regard that policy as treason to Canada. Imperial federation means that Canada must join Britain in her wars throughout the world, and must weigh the interest of the whole Empire before looking to her own. A tie that would thus subject Canada completely to European dominion would be a most unnatural one, and there are not fifty men in the province of Quebec who are favorable to so unpatriotic a policy. The time has, in fact, come to consider in a very peaceful yet very serious way the right of European Powers to govern people living on the continent of America, whose interests and general tendencies,

commercial or other, are in certain respects opposed to those of the people of Europe. Accordingly, instead of being disposed

--- Page 223. The Gospel of Wealth - XII Imperial Federation

to strengthen the ties at present existing between Britain and Canada, we are, in fact, looking forward with some anxiety to the time when we shall ask for our independence. We shall request it with all due respect to Great Britain, and without any ill feeling toward her people, just as a young man of full age, on leaving his father's home, may sometimes do it with reluctance, but with the proud feeling that he, too, is called upon to take a free and independent share in life. What I say about the province of Quebec may, I believe, be said of the inhabitants of all the other provinces.



17. It surely cannot have failed to attract the attention of the members of the Imperial Federation League that even Sir John Macdonald, a native-born Briton, was forced, certainly much against his will, to announce that Canada was no longer to be dependent, but the ally, of Briton, and even going so far only enabled him to escape defeat by a greatly reduced majority.

In future, England would be the center, surrounded and sustained by an alliance, not only with Canada, but with Australia and all her other possessions; and there would thus be formed an immense confederation of freemen-the greatest confederacy of civilized and intelligent men that ever had an existence on the face of the globe.

[Baha'i Comment](#)

18. Alliances are made between independent nations. Sir John must also have had in mind the Republic, for this is necessary to make the greatest confederacy of intelligent and civilized men. A confederacy of all others of our race would be much smaller than the United States alone.

[Baha'i Comment](#)

19. Sir John asserted the independence of Canada to the fullest extent when he recently commanded Lord Salisbury to tear up a treaty which had been agreed upon by Sir Julian Pauncefote and Secretary Blaine, with Lord Salisbury's cordial approval, which the British Government had presumed to make without consulting Canada. The recent protest of Newfoundland is another case in point.

[Baha'i Comment](#)

*(10) On the Pauncefote-Blaine treaty Essay XI, note 8. In 1890 and again in April 1891 Newfoundland sent deputations to London to protest against the principle and arrangement by which France and England arrived at a modus vivendi involving the fishing industry in the colony.*

The public is informed that the difficulty has been compromised, but the

--- Page 224. The Gospel of Wealth - XII Imperial

## Federation

compromise has necessarily been all on one side. The form of arbitration with France is to be adhered to; but after this has been duly performed, Newfoundland's demands will be complied with. Any treaty rights France is found to possess are to be purchased. There was no other course open to Britain. She cannot govern her colonies; for they are full grown and almost of age and now dictate to her. They must be provided with homes of their own speedily if the filial tie is to be preserved.

20. The Imperial Federation has only to grapple with the initial difficulty to be overthrown, which is this: the native-born Australian wants at maturity a country of his own to live for, fight for, and, if necessary, to die for; the native-born Canadian wants the same. The native-born Briton has this, the American, German, Frenchman. Why not the people of Canada and Australia? The native-born colonist has not the slightest idea of permitting the parent-land, distant thousands of miles, or any land, to have anything to say in or to his own country. That any of their statesmen should favor the proposition that the

[Baha'i Comment](#)

representatives of his country should be sent across seas to be swamped in a Parliament in London, and the destinies of his country subjected to the votes of strangers, would probably be considered by the medical faculty of the colony as a prima facie proof of mental aberration; his incarceration in a lunatic asylum would be imminent. To endeavor to satisfy this commendable and patriotic devotion to the idea of country by offering them part of a land thousands of miles away, which they can never see, is futile. They might as well be asked to consider themselves citizens of the moon, and so to rest and be thankful. These ambitious, enterprising peoples with British blood in their veins are not crying for the moon. There is no rest for such movements; once started, national aspirations are not to be quenched. The sooner these are gratified, the better for all.

21. What lesson has the past to teach us upon this point?

--- Page 225. The Gospel of Wealth - XII Imperial Federation

Spain had great colonies upon the American continent: where are these now? Seventeen republics occupy Central and South America. Five of these have prepared plans for federating. Portugal had a magnificent empire, which is now with the Brazilian Republic. Britain had a colony. It has passed from its mother's apron-strings and set up for itself, and now the majority of all our races are gathered under its republican flag. What is there in the position of Britain's relation to Australia and Canada that justifies the belief that any different result is possible with them? I know of none; on the contrary, all that I know of the sentiment of the people in the colonies satisfies me that there exists this healthy growth toward national life. They would be unworthy of their sires if they did not possess it. It was not a question of taxes that produced the independence of the United States; this was the incident only which precipitated what was bound to come a few years sooner or

[Baha'i Comment](#)

later, independent of any possible home policy. Franklin and Adams had no idea of separating from the motherland when they led in the refusal to be taxed from Westminster; but they soon found themselves compelled by a public sentiment, until then latent, to advance to independence. Australasia has begun the natural movement toward change in her relations to the old home. Her leaders—still native-born Britons chiefly—kindly propose that Britain may still be allowed to send an ornamental Governor-General. The tie will be slight, but it is now seen, especially in the most important of the colonies, New South Wales, that, as in the case of America, the British-born leaders may be pushed by the native-born Australians into a movement for complete independence. If it does not evolve now it must do so later, for the "Speaker" (July 18) truly says: "It is the fading class of the home-born which keeps alive the traditions and sentiment of the English connection. Every five minutes throughout Australasia an Imperialist dies; every four minutes a Republican is born."

--- Page 226. The Gospel of  
Wealth - XII Imperial  
Federation

22. The constant reader of the Spectator knows that journal to be equally well informed, and the Times has more than once recently shown that it is not ignorant of the true state of colonial affairs. But these able organs of public opinion seem to be almost alone.

[Baha'i Comment](#)

23. It is of the utmost importance that the people of Britain should promptly realize her true relation to the colonies, which is just this: she is the motherland, and no nation has ever been blessed with a family so numerous, enterprising, and creditable. The only part open to her is to play the mother, and, as her children grow beyond the need of her fostering care, to endeavor to inculcate in them the ambition to go forth and manage for themselves. She should doubt the blood in any weakling content to remain under her protection when the age of manhood comes. True, few departures from the old home are unaccompanied by tears, but, after all, tears of affection, of joy, in the happiness of the child who starts in life for himself. There are only two modes that can

[Baha'i Comment](#)

be pursued: either the colonies will leave the parent nest with the parent's blessing, carrying in their hearts undying love and reverence for her to whom they owe all, or the parting will be made under conditions which must necessarily bring both parent and child lifelong bitterness and lifelong sorrow. The American boy is forever to be in youth the hater of the old home, for in his early years he is fed with stories of the Revolution -- of the struggles and sufferings of Washington and his patriot army, of the desire of his native land for independence, and of the mistaken efforts of Britain to hold it in subjection.

24. This early impression of Britain as the oppressor of his country is not easily removed. It is a thousand pities that the majority of our race is to learn first that the parent-land was their country's only foe. Britain can choose whether Australia and Canada and her other colonies, as they grow to maturity, can set up for themselves with every feeling of filial devotion toward her, or whether every child born

--- Page 227. The Gospel of Wealth - XII Imperial Federation

[Baha'i Comment](#)



in these lands is to be born to regard Britain as the American child must. There is no other alternative, and I beseech our friends of the Imperial Federation to pause ere they involve their country and her children in the disappointment, humiliation, and antagonism which must come if a serious effort be made to check the development and independent existence of the colonies, for independence they must and will seek by virtue of the blood that is in them, and obtain, even by force if necessary. They were not true Britons else.

25. Lord Salisbury has recently said that if Home Rule were granted to Ireland, other portions of the Empire might be "wrenched from the power of the Queen." As he could not mean that there was a danger of foreign nations attempting to "wrench" any of the colonies, he must have meant that the colonies would "wrench" themselves away. Nothing should be left undone to prevent such "wrenches" from coming. To encourage the colonies to follow the example of their mother-land and become nations themselves is the only way to prevent such a "wrench" as took place between the parent

[Baha'i Comment](#)

and the Republic. I should prevent all feeling of "wrenching" upon one side or the other by having the parent-land start her children in life in due course, as her Majesty starts her children. With rare wisdom, she favors early marriages. Britain, as a nation, should imitate the example of her wise Queen, and start her colonies for themselves in homes of their own as soon as they become restless under the old roof-tree, with a God-speed, and a fond, proud mother's blessing.

26. It may be said that the destiny indicated for the parent-land is one unworthy of her past. I cannot share such a thought. The world is still young. As each child of Britain reaches proper growth and departs, another child will be born to her. No limit can be set to this stage of the world's development, no time fixed when the mother will not have quite enough of a family to care for. Generations must pass before the two hundred and eighty millions of India are

--- Page 228. The Gospel of Wealth - XII Imperial Federation

ready to federate into a great nation and govern

[Baha'i Comment](#)

themselves, while Africa was born to her only yesterday. Besides this, the United Kingdom, even of itself, and without colonies, would remain one of the principal nations. Her colonies weaken her powers in war, and confer no advantages upon her in peace. Her population about equals that of France, and will, I believe, eventually equal that of Germany, probably exceed it, leaving only Russia more populous in Europe. Her store of minerals surpasses all others except the United States; she has at her foot the markets of the world for the chief manufactured articles, for, whatever may be said of foreign competition, it cannot possibly amount to much in the future: her navy can control the seas. One of the purest fallacies is that trade follows the flag. Trade follows the lowest price current. If a dealer in any colony wished to buy Union Jacks, he would order them from Britain's worst foe if he could save a sixpence. Trade knows no flag. Britain's greatest customer is the American Republic; and, as we have seen, Germany and France, with a tithe of the population, consume as much as India of British products, and more than all the Australian and Canadian colonies combined.

Canada trades more with the Republic than with Britain. The independence of the colonies will not lessen British trade with them, but increase it, because independence will stir their energies and make them much more enterprising. Hence wealth will be produced faster, and the market for fine articles from Britain be correspondingly increased. This is proved by the result of American independence.

27. With full appreciation of the patriotic sentiment which pervades the two leagues, I cannot refrain from asking their members to consider whether they are not working in the wrong direction, and aiding to thwart and not to promote the true mission of their country in the future. The position which Britain should aim to occupy is no less than the "headship of the race," as the parent of all. Now, even if the various parts of the race in the Empire could be federated

--- Page 229. The Gospel of Wealth - XII Imperial Federation

under one sovereign - of which there is as little likelihood as that the Republic could be induced to enter -- and thus the whole aim of the

[Baha'i Comment](#)

Federation League be accomplished, what then? Eleven millions of people will have been confederated with her-only this and nothing more-and Britain then would only be first in the smaller division of the race. It would not be such a prodigious gain for her, after all. We should have "Hamlet" with Hamlet left out. Few persons have a correct knowledge of the numbers and increase of the various parts of our race. During the past ten years the United States added to its numbers more than the total present number of English-speaking people in all other parts of the world, outside of the United Kingdom. Her increase was 12,500,000. The increase of the United Kingdom and all her English-speaking colonies was not one half as great - about 5,000,000. Britain added slightly more than 3,000,000; Canada only 500,000, a rate of increase not greater than that of Britain; New South Wales (last eight years) only 471,000; Victoria (last nine years) 710,984; all other colonies only trifling numbers. Thus, if we place the Republic in one scale, and all the other parts of the race in the other, the yearly increase in the first scale would more than double that in the second. Even if the United States increase is to be

much less rapid than it has been hitherto, yet the child is born who will see more than 400,000,000 under her sway. No possible increase of the race can be looked for in all the world combined comparable to this. Green

*(11) John Richard Green (1837-1883). British historian.*

truly says that its "future home is to be found along the banks of the Hudson and the Mississippi." Why should the parent-land, then, be counseled by the Imperial League to endeavor to form closer ties with her other children than with her eldest born, who must dwarf all the rest of the family together? What kind of federation is that which leaves the Republic out? There is no obstacle to forming any tie with the Republic that can possibly be formed with

--- Page 230. The Gospel of Wealth - XII Imperial Federation

the commonwealth of Australia or the Dominion of Canada, for, just as soon as these are asked to forego their inborn desire for independence similar to that of the United States, their answer will settle the question, if, indeed, the

League ever requires to go so far as to ask for Imperial Federation and be refused. It should not be necessary for it to place the parent-land in a position so humiliating, for that its idea is impracticable can be learned in every quarter without exposing itself to the inevitable and wholly unnecessary rebuff.

28. If the United Empire Trade League ever succeeds in getting the government to call a conference of the colonies, to meet in London, as it proposes, to consider its aim, the end of that idea also will have arrived, for few colonial governments could survive the support of a bill appointing delegates even to consider the question of discriminating against other nations in favor of Britain. But, as in the case of the Imperial Federation League, so the United Empire Trade League should be able to satisfy itself, before asking a conference only to be refused, that there is no possibility of obtaining the cooperation of any English-speaking community.

[Baha'i Comment](#)

29. Mistaken, impracticable, and pernicious, however, though the aims of these two societies be, yet it is to their membership that we can best look for efforts in the right direction for such cooperation of the entire race as it is possible to effect; for their hearts are in the right place, and their heads can easily be brought to the favorable consideration of an idea which postulates for their country a much higher position, a much grander mission, than that which they have set themselves to secure -- a position which will keep her in the rightful attitude of parent toward the entire race which has sprung from her.

[Baha'i Comment](#)

30. I respectfully ask the patriotic, sympathetic, and enterprising men of these leagues to permit me to submit for their consideration a summary of the ideas which have forced

[Baha'i Comment](#)

--- Page 231. The Gospel of Wealth - XII Imperial Federation

themselves upon me from a study of the question, made with an earnest desire to secure, first, the unity of our race, and through that, for it, the mastery of the world, for



the good of the world.

31. *First.* The great aim of the federationists should be to draw together the masses of all English-speaking countries, and to make them feel that they are really members of the same undivided race, and share its triumphs; that all English-speaking men are brothers who should rejoice in one another's prosperity and be proud of one another's achievements. The little faults or shortcomings of the other members should be overlooked, and all should dwell upon what is best in each, for, as members of the same race, what disgraces one necessarily reflects upon the entire family. Impossible Imperial Federation and Empire Trade League should give place to Race Alliance, and so embrace all in one common bond, the only test being

If Shakspeare's tongue be  
spoken there,  
And songs of Burns are  
in the air.

[Baha'i Comment](#)

32. Pursuance of this policy during our generation will do much to lay the foundation for a true federation of the whole race, as far as it is possible to combine sovereign powers; and how far that is possible is for future generations, not for this, to learn. That it is possible to a degree, we of to-day already see. Once earnestly kept in view and labored for, and lower aims excluded, it is probable that things now deemed impossible dreams may prove easy of getting. Indeed, the "Parliament of Man" itself is only a question of time in the mind of the evolutionist who sees no bounds to the advance of man in the line of brotherhood. If we may not look into the future and tell what germ is to grow, we can at least do our duty in the present, and cultivate the soil and plant the germ which ought to grow among the members of the same race, leaving to posterity the duty of

--- Page 232. The Gospel of Wealth - XII Imperial Federation

nurturing the precious seed, and, we trust, the fruition of our hopes.

[Baha'i Comment](#)

33. *Second.* The parent-land should be urged to encourage her colonies, as an able mother encourages her sons, to go forth at maturity and play the part of men-loving and reverencing her, but independent. The idea of federation among colonies should also be encouraged; for no greater calamity could happen than that the various English-speaking communities should be divided into small nations, jealous of one another. The sad condition of Europe to-day, an armed camp, contrasted with that of the United States, which is ere long to contain an English-speaking population as great as the whole of Europe, without any necessity for a standing army, should be continually in mind and proclaimed. The Australian colonies do not require the lesson. These are wise and will federate, and, as one irresistible power, keep the peace and rule that quarter of the globe without armies, for they, like the Republic, can have no neighboring foe; but the union of England and Scotland should be held up to Canada and the United States. I should not like to think that I ever had said or ever should say a word that would tend to perpetuate upon the American continent two divisions of the race, or to feel that I had not

[Baha'i Comment](#)

exerted myself to produce union. The mother-land can do much by reminding Canada of her own union with Scotland, and the happy results which flow from it. The present unfortunate division of the race in America, so fraught with danger, is Britain's work; the duty upon her to correct the evil is imperative. Nor is she unequal to the task, for she has done things that other nations cannot parallel. The cession of the Ionian Islands to classic Greece, the recent cession of Helgoland to Germany, show her capable of generous, even sublime, action.

*(12) In 1884 the Ionian Islands, the principal of which is Gorfu, a British protectorate, were formally ceded to the Kingdom of Greece. The British seized Heligoland (Helgoland) in 1807 from the Danes but in 1890 ceded the island to Germany.*

She can rise at times to great heights and

--- Page 233. The Gospel of Wealth - XII Imperial Federation

teach nations magnanimity. All she has done of this nature combined were but little in comparison with the uniting of the two children whom her policy separated a century ago. She should tell Canada that whenever it becomes, as

it is becoming, a question of separate independent existence, or of union with the other division of the race, a mother's blessing would attend her union with the Republic. With the appalling condition of Europe before us, it would be criminal for a few millions of people to create a separate government instead of becoming part of a great mass of their own race which joins them, especially since the federal system gives each part the control of all its internal affairs, and has proved that the freest government of the parts produces the strongest government of the whole. The most eminent man in Canada to-day is certainly Goldwin Smith.

*(13) British historian and publicist (1823-1910), author of Canada and the Canadian Question (1891). From 1868-1871 he was a professor at Cornell. He was an ardent spokesman for Anglo-Saxon union and supremacy.*

He remains an Englishman with allegiance unimpaired, yet he tells Britain that her position upon the American continent is the barrier to sympathetic union with her great child, the Republic. He is right.

34. *Third.* Much is done to prevent harmony in the race by the position that has until recently been held tenaciously by the parent-land in regard to the fiscal policy which every colony has found it best to pursue. Seeing that strictly agricultural communities can never amount to much under present conditions, it should be regarded as a natural and patriotic desire upon the part of Canadians and Australians to give their countries diversified industries, that the various aptitudes of the people may find scope. Britain need have no fear about her trade. Indeed, it is very doubtful if, with all her resources developed to the utmost, she can long continue to meet the demands for her products which must be made upon her, no matter what tariffs may be adopted. Where the iron and steel can be had to supply the coming wants of the

--- Page 234. The Gospel of Wealth - XII Imperial Federation

world is already troubling Bell, Atkinson, Hewitt, and other high authorities.

*(14) Of these authorities Sir Isaac Lowthian Bell (181~1904) was an English metallurgist and businessman, organizer of the British Iron and Steel Institute,*

Baha'i Comment

*author of books on the industry. Abram S. Hewitt (1822 1903), son-in-law of Peter Cooper, an ironmaster, was a pioneer in the introduction into the United States of metal rolling and steelmaking and a successful Democratic politician. On Edward Atkinson see Editor's Introduction, above, p. x.*

A writer in the *Times* (July 12), Mr. Harvey, one of the most prominent citizens of Newfoundland and a loyal subject, states this point admirably, and asks that it "be granted by the majority of the people of England and Scotland that a man may doubt the infallibility of the doctrine of free trade under all circumstances, and not be considered a fool or worse." Britain is quite right in adopting free trade for herself, but every colonist visiting the old home should not be attacked and denounced, I might even say abused, because he ventures to think his new country requires a different system for a time.

35. *Fourth.* The process of assimilating the political institutions of all English-speaking countries should be continued, for it should never be forgotten by true federationists that different political conditions form a great barrier to close sympathetic union. No Parliament since that which passed the Reform Bill deserves greater thanks than the present one in this respect. It has done much to bring Britain's institutions in accord with the democratic standard of all the other English-speaking nations. County councils, and especially free education, are important steps toward the unification of our race. In like manner, the recent Copyright Act of the Republic removes a difference. Australasia has also done her part by placing the Republic under obligation, her greatly improved system having already been adopted with beneficial results in many of the States. She has also the simplest and best system of land laws in the world, for which we hope the Republic is soon -- and the United Kingdom later - to discard its own. Thus each of the three parts,

--- Page 235. The Gospel of Wealth - XII Imperial Federation

[Baha'i Comment](#)



improving for herself, improves also for the benefit of the others. The race enjoying the same language, religion, literature, and law should also have the harmonizing blessings of common political institutions.

36. The ground once cleared of Empire Trade League efforts to array one part of the race against the other part, and equally of Imperial Federation aims which would shut out the vast majority of the race and limit the motherland's connection to the smaller portion, and especially if the division of the race upon the North American continent were healed by union, upon the advice of the parent, the efforts of all could then be concentrated upon realizing what Mr. Bolton calls "that grand idea, the confederation of all the nations which have sprung from the race nurtured in these isles." The first-fruits of this movement would probably be seen in the appointment, by the various nations of our race, of international commissions, charged with creating a system of weights, measures, and coins, of port dues, patents, trade-marks, and other matters of similar character which are of

[Baha'i Comment](#)

common interest. If there be a question upon which all authorities are agreed, for instance, it is the desirability of introducing the decimal system of weights, measures, and coins; but an international commission seems the only agency capable of bringing it about.

37. The habit of producing uniform arrangements for the whole of the race having been created by such commissions, the step would be easy to a further development of the international idea. For under harmonious conditions Britain would soon be regarded by the English-speaking people throughout the world as the mother they all revere, and there must inevitably begin a gradual drawing together of the whole race. Even to-day, every federationist has the satisfaction of knowing that the idea of war between the two great branches is scouted on both sides of the Atlantic. Henceforth war between members of our race may be said to be already banished, for English-speaking men will never again be called

--- Page 236. The Gospel of Wealth - XII Imperial Federation

upon to destroy one another.

[Baha'i Comment](#)

During the recent differences -- not with Britain, for Britain and the Republic agreed, but with disapproving Canada, which was naturally more irritating to the Republic - not a whisper was ever heard upon either side of any possible appeal to force as a mode of settlement. Both parties in America and each successive government are pledged to offer peaceful arbitration for the adjustment of all international difficulties - a position which it is to be hoped will soon be reached by Britain, at least in regard to all the differences with members of the same race.

38. Is it too much to hope that after this stage has been reached and occupied successfully for a period, another step forward will be taken, and that, having jointly banished war between themselves, a general council should be created by the English-speaking nations, to which may at first be referred only questions of dispute between them? This would only be making a permanent body to settle differences, instead of selecting arbiters as required - not at all a serious advance, and yet it should be the germ from which great fruits would grow.

[Baha'i Comment](#)

39. The Supreme Court of the United States is extolled by the statesmen of all parties in Britain, and has received the compliment of being copied in the plan for the Australian commonwealth. Building upon it, may we not expect that a still higher Supreme Court is one day to come, which shall judge between the nations of the entire English-speaking race, as the Supreme Court at Washington already judges between States which contain the majority of the race?

[Baha'i Comment](#)

40. At first the decisions of the council would probably be made subject to ratification by all the principals, but the powers and duties of such a council, once established, may be safely trusted to increase; to its final influence over the race, and through the race over the world, no limit can be set; in the dim future it might even come that the pride of the citizen in the race as a whole would exceed that which

[Baha'i Comment](#)

--- Page 237. The Gospel of Wealth - XII Imperial Federation

he had in any part thereof - as the citizen of the Republic to-day is prouder of being an American than he is of being a

native of any State of the Union. This is a far look ahead, no doubt, but patriotism is an expansive quality, and men to-day are as patriotic in regard to an entire continent as the ancients were about their respective cities and provinces. The time is coming when even race patriotism will give place to the citizenship of the world.

41. While the decisions of the council would necessarily be restricted to such questions as arose between the members of the race, its influence, and in extreme cases its recommendations, if unanimously made, could not fail to be of weighty import. We can imagine such a tribunal, for instance, unanimously saying a word upon occasion which would settle the most important subject within our horizon of to-day. Is it a very improbable idea that it might hold and obtain the unanimous approval of the powers represented in so holding that the peace of the world, in which the industrial English-speaking race is most deeply concerned, is a question which other nations cannot be allowed wholly to determine for themselves? The commanding position of our

[Baha'i Comment](#)

race will place upon it correspondingly great offices. United as described, it would wield such overwhelming power that resistance would be useless. Its verdict could never be questioned; its word would be law. I believe that it is by our race, and through such means, that war is most probably to be driven from the world which it disgraces, and the reign of peace established among men for ever.

42. In the pursuit of an end so noble, the English-speaking race, wherever situated, can confidently be appealed to; its realization would be a service to mankind which justified labor, expenditure, and even risk. The feeble beginnings of the federation of Europe are already seen in the Triple Alliance. It may fail because not so overwhelmingly strong as to render impotent all efforts to cope with it, and all depends

--- Page 238. The Gospel of Wealth - XII Imperial Federation

upon this; but the idea is there, for three nations have declared themselves banded together, not for the purpose of aggression, defensively, not offensively, and only to keep the peace and to punish the

[Baha'i Comment](#)

peace-breaker. We have nothing to do here with the merits of the controversy which called it forth, but what this Alliance aims to do for the three countries concerned for a few years, the true federation of the English-speaking race would be able to do permanently for the world. The duty is to be ours, if we cooperate, because ours is the only race of which the slightest hope can be entertained that it is soon to become so much stronger than any other race, or probable combination of races, as united to be omnipotent.

43. A race alliance will hasten the day in the coming of which I have implicit faith, when our race will be quite able to say - and will therefore as a duty say - to any powers that threaten to begin the murder of human beings, in the name of war, under any pretence:

*Hold! I command you  
both; the one that stirs  
makes me his foe.  
Unfold to me the cause  
of the quarrel, and I will  
judge betwixt you.*

*(16) This seems to be a  
confused memory of a  
celebrated passage from  
the play by Home, Douglas*

[Baha'i Comment](#)

*(1757), once thought to rival Shakespearean tragedy. The lines should read:*

*"Hold, I command you both. The man that stirs Makes me his foe."  
(Act IV, scene 2, lines 385-386.)*

44. If ever the parent-land and all her children unite in speaking these words, it need not be feared that a shot will be fired or a sword drawn. The writ of that race union will run the circle round and insure peace. We should thus have the Kriegsverein with power so overwhelming that its exercise would never be necessary. The Zollverein is something so much lower, being only a question of trade, that it scarcely deserves mention in comparison; but even the Zollverein will come of itself in its own good time, when the various members have had time to test and learn their respective capacities - what they can produce best at home, and what they must continue to purchase abroad. Protective tariffs are in their

--- Page 239. The Gospel of Wealth - XII Imperial Federation

very nature experimental and temporary devices. These

[Baha'i Comment](#)



require little attention from the true federationist; indeed, the less they receive the sooner they will pass away. All the forces at work tend to equilibrium of cost throughout the world, and hence the reduction and final abolition of protective duties as no longer necessary.

45. It is obvious that such an alliance of the race is dependent upon a union of hearts, and that force or pressure would only defeat it. No more seeds of lifelong bitterness should be sown. The younger members of the race should remember what is due to the parent; the parent should seek to retain their love and reverence by being "to their faults a little blind and to their virtues very kind,"

*(16) Quoted inaccurately from Matthew Prior, "An English Padlock," line 79.*

freely according to each, when maturity arrives, the same independent existence and the same exclusive management of its own affairs as she claims for herself, and rather than relinquish which she would sink under the sea. Each member must be free to manage his own home as he thinks proper without incurring hostile criticism or parental interference. All must

[Baha'i Comment](#)

be equal - allies, not dependents.

46. Fate has given to Britain a great progeny and a great past. Her future promises to be no less great and prolific. Many may be the members of the family council of all the English-speaking nations, each complete in itself, which I have predicted as sure to come sooner or later; but, however numerous the children, there can never be but one mother, and that mother, great, honored, and beloved by all her offspring, - as I pray she is to be, - "this Sceptered Isle,"

*(17) Richard II, Act II, scene 1,  
line 35.*

my native land. God bless her!

[Baha'i Comment](#)

-----

THE JOHN HARVARD LIBRARY

The intent of  
Waldron Phoenix Belknap, Jr.,  
as expressed in an early will, was for  
Harvard College to use the income from a  
permanent trust fund he set up, for "editing and  
publishing rare, inaccessible, or hitherto unpublished  
source material of interest in connection with the  
history, literature, art (including minor and useful  
art), commerce, customs, and manners or way of  
life of the Colonial and Federal Periods of the United  
States... In all cases the emphasis shall be on  
the presentation of the basic material." A later testament  
broadened this statement, but Mr. Belknap's inter-  
ests remained constant until his death.

In linking the name of the first benefactor of Harvard College with the purpose of this later, generous-minded believer in American culture the John Harvard Library seeks to emphasize the importance of Mr. Belknap's purpose. The John Harvard Library of the Belknap Press of Harvard University Press exists to make books and documents about the American past more readily available to scholars and the general reader.

**MENU: [HOME](#) » [Reconstruction](#) » [Gospel Content](#) » [Gospel Purpose](#)**

---

---

# New World Order

## Introduction

[bruce@webpal.org](mailto:bruce@webpal.org)  
[Bruce M. Beach](#)

### Table of Contents:

#### [NWO: A Philosopher's View](#)

Here I explain what the NWO is and what it will be like in the future. Those disciplined enough to actually read and think about this subject are invited to respond with their comments.

#### [Maturity: Responsibilities](#)

We hear much about *RIGHTS* but here I discuss about the *RESPOSIBILITIES* of the mature adult. Those individuals actually capable of considering the issues concerning the NWO must have matured and this is an attempt to define what that maturity is.

#### [Quotes: About the NWO by US Presidents and other famous people](#)

Presented here in a categorized form are quotes from many past US presidents about the NWO. There are numerous quotes from many famous people, separated into groups of those who were for and those who were against. Because there are so many

quotes a few, that give the flavor, have been marked with blue stars **\*\*\*\***.

Hopefully they will pique your interest to the extent that you will read the rest.

#### [More: quotes from famous people](#)

While these are not specifically on the subject of the NWO they do give one insight into the thinking of our leaders.

#### [Proposal: A NWO Constitution](#)

Presented here is a proposal that has been put forth for a NWO constitution. This has

had the backing of lots of groups and a major effort was made to push it forward at a United Nations meeting - but so far it has not really gone anywhere.

### [Critic: A NWO Constitution](#)

And here is a critique of the above NWO Constitution proposal, by someone opposed to it.

### [History: of the NWO](#)

There have been many conspiracy theory histories written about the NWO and while this "history" still has such a concern it is not as rabid as many but still covers the main items to be found in most of them.

### [Hoax: regarding the NWO](#)

There are many, many hoax documents regarding the NWO and there are numbers of people who believe in any them. This is a run of the mill example.

[Click here to return to the top of this Table of Contents](#)

**MENU: [HOME](#) » [Reconstruction](#) » [Recovery](#) » [Renewal](#) » [Survival](#)**

---

---

# New World Order Philosopher

[bruce@webpal.org](mailto:bruce@webpal.org)

[Bruce M. Beach](#)

---

## *Dialog*

This is meant to be a dialog, rather than a lecture. Those who are willing to participate are invited to do so by writing to the author at the above email address. Critiques, comments and contributions will be [appended](#).

There is a Table of Contents immediately following but while it is useful to see an outline one can better go to the first topic and just read through the entire presentation.

The author of this page of course works within a particular paradigm, and as an individual subscribes to a specific philosophy, but the description and discussion here is meant to be secular in nature, to describe the social milieu in secular terms, and to provide a secular perspective of what will be a world embracing social activity, no matter how directly one may perceive that activity to be under Divine aegis.

---

## Table of Contents:

[NWO: What it is.](#)

[The Alternatives to the NWO: None](#)

[Concerns about the NWO: Summarized.](#)

[How the NWO will be established: NOT by conspiracy.](#)

*America's Role in the NWO:* Against and For.

*The effect of the NWO:* Great GOOD and Great EVIL

*The Government of the Anti-Christ:* Not what many think

*When the NWO will be established:* A work in progress.

*Peace in the NWO:* Not perfect

*Freedom in the NWO:* The Golden Mean

*Prosperity in the NWO:* Life is a struggle

*Morality in the NWO:* A New Victorian Age

*Spirituality in the NWO:* The continuing path

*Critiques:* Your comments are welcomed.

---

## *The NWO: What it is*

The NWO is going to happen.  
There is no avoiding it.  
Its development is on-going now.

The NWO will be the source of GREAT Good, and GREAT evil.  
The nature of that good and evil will be explained. ,  
It is true that the NWO Government will be viewed by many  
as the government of the anti-Christ,  
and a generic explanation of that expression is used herein.

What the NWO will be like is still undefined.  
If mankind had become spiritual enough  
it would have been the establishment of  
the Kingdom of Heaven on Earth.  
Unfortunately, that will not be the case.

But neither is it likely to be  
a centralized oppressive totalitarian bureaucracy  
although some libertarians and anarchists  
will see that element in any government.

What the NWO will be  
and must be  
is a World Government  
whose primary objective is to prevent war between the nations  
and whose secondary objective is to increase  
economic well being and social justice  
for all the inhabitants of the earth.

The degree to which it will accomplish those goals  
will depend upon the degree of the enlightenment  
of its founders.  
Security, economic well being, and social justice,  
will be evolving values and attainments  
dependent upon the social and spiritual evolution (development)  
of the all the inhabitants of the planet as a whole.

The momentum to establish the NWO  
will greatly accelerate after the Nuclear War  
which this author views as now being inevitable.  
Those who work to prepare for the restoration  
and re-organization of society in the NWO,  
such that it will assure World Peace and Prosperity,  
are part of the solution.  
Those who oppose it  
are part of the problem.

Those who assist in the establishment of the NWO,  
and work for the restoration and re-organization of society  
will be working for the Good  
and those who oppose it will be doing evil.

Click here to return to the  
[Table of Contents](#)



# *The Alternatives to the NWO:* **None**

Nevertheless, let us consider the proposed alternatives.

## 1. International anarchy.

Unfettered national sovereignty can only lead to wars. Each country being its own and final judge as to whether it should execute war against another. With the existence of nuclear weapons these will lead to nuclear wars and with the existence of missiles these can become intercontinental wars. The existence of weapons of any kind has always resulted in their use. The only solution is the elimination of weapons of mass destruction.

## 2. The continued status quo.

The United Nations, as it presently exists, is a failure, as was the League of Nations before it. The reason being, that they both were emasculated from the outset by not having an international police force to enforce their decisions. The how and why this occurred, I discuss below. However, both of those institutions were necessary precursors to the NWO.

## 3. World Conquest.

### a. By communism.

Communism, a centuries old ideal, proved a failure in the industrial age. It still remains the dream of many in Russia, China, and Cuba and of a few elsewhere. Hard right capitalists see the U.N. as being a tool of communism and hard left communists see it as being a tool of capitalism. In truth it will either become the foundation of the NWO, or it will be replaced.

### b. By one world power.

The Colonial dreams of any in England, U.S., Russia, China, or wherever, to conquer and rule the world should surely be as dead as the dinosaurs. It would just not possible in this world of Nuclear weapons.

### c. By some philosophy.

An equal fantasy is that of conquering the world through some philosophy of force. Jihad of the Moslems, Dominion Theology of the Christians, or Intervention of the Space Brothers.

#### 4. Divine Intervention

Some religions look for a Divine Intervention, some Holy battle, as described in their concepts from the Hindu Bhagavad-Gita, the Jewish Messianic Expectations, the Moslem Jihad of the Last Days, the Christian millennialist and rapture expectations. But, here we are talking about the establishment of a secular government as the NWO. It might have been possible in the 19th century for enlightened Kings and Rulers of the earth to have led humanity into some "Most Great Peace" but that opportunity, if it ever existed, is now past and out of catastrophe mankind will have to restore society and forge a "Lesser Peace" maintained by the threat of combined armed intervention and annihilation of any country who would attempt to violate it.

Click here to return to the  
[Table of Contents](#)

---

## *Concerns about the NWO: Summarized.*

Many people have serious concerns about the NWO. These have been well summarized by Arthur Lyon Dahl in his book, "The Eco Principle: Ecology and Economics in Symbiosis", published by Zed Books, UK, 1996. (p. 143) as follows:

"It is therefore worth exploring some of the possible causes of this antipathy to world government, and to consider ways to respond to the legitimate concerns and objections.

One problem is the low esteem in which national governments are held today. Widespread corruption and inefficiency have discredited the idea of government in general. In such a situation, most people reason, a bigger government could only be worse. More bureaucracy would be harder to control. A world government would be too distant from the grass roots and too remote from public interests. The checks and balances, such as those between states today, or those of democratic systems that have ultimately reined in the more extreme abuses of national power, might not work. There is a risk that a world government would be just as vulnerable to special economic interests, inefficiency and corruption as national governments, but much more difficult to control.

Then there is the fear that a world government would be vulnerable to takeover by a global dictator. The memories of the attempts by Hitler, Stalin and others to dominate the world have not faded. If this occurred, there would be no possibility for a 'free world' outside to resist and eventually overthrow such a tyrant.

There is also a general lack of confidence in our ability to build a diverse community in which the interests of all members, nationalities and cultures would be safeguarded. The many observed failures to achieve this, even at the national level, do not inspire hope that a world community will be any more successful. Many fear that their cultural differences will be swallowed up by those who are more numerous or more powerful than themselves. The powerful and wealthy who dominate today's nation states similarly fear that their privileges will be taken away from them in a united and democratic world. There is no obvious mechanism to achieve a just balance between states and peoples of widely different sizes and levels of political power and economic development.

Just as various forms of national government were designed to control or compensate for less desirable human tendencies, so are we capable of planning a world federal system with safeguards against our greatest fears. Such a system will be highly decentralized (now popularly called 'subsidiarity' in Europe). Emphasis will be placed on participation, consultation and consensus, with appropriate checks and balances between the *different* centres of decision-making.

Institutional and structural safeguards can be designed to prevent a military or other takeover, and to avoid an uncontrollable bureaucracy. These can be built into the balance between different levels of governments, avoiding an excess concentration of power at any level. Beyond this, the best guarantee against abuse of the powers of a world government will be the high moral standards and pure intentions of those in international positions. The mechanisms to select such individuals, whether by election or appointment, will need to privilege these characteristics.

In any case, the plight of a major part of the world population is already so bad that even a worst-case scenario could hardly cause more suffering. Only a stronger global system has some chance of reducing the extreme inequalities that so divide and threaten the stability of the world today."

Click here to return to the  
[Table of Contents](#)

---

*How the NWO will be established:* **NOT** by conspiracy.

You can find information about the Bilderbergers, Illuminati, Tri-Lateral Commission, and a half dozen other groups. They do play a role. But it is not a conspiracy as many that write about those groups would have you believe.

The NWO is more like the Industrial Revolution. There was no single organization behind it, nor one group of people who conspired to bring it about. There were groups (governments, bankers, industrialists, scientists, engineers and such) who had their own agendas, (just as there are now in regards to the NWO) and who played a role in bringing it about, but none of them had a Grand Design, and it was not a conspiracy.

Some theorists, such as Marx, felt that it was a natural evolution of society, proceeding from thesis and antithesis to synthesis. Others saw within it (and do today) the technological progression from hunting/gathering through herding and agrarian, to the industrial society and now onto the information age.

In some points of view, the Industrial Revolution, was simply a change in the primary technological means of production. It did not demand or require one specific form of social organization. In that view we could have had monarchy, democracy, capitalism, or communism, or almost any combination thereof. Others feel that the primary technological means of production determines the social organization. Therefore hunting/gathering will require small tribal organization, and agrarian will support larger city-state types of organization, while division of labor and the industrial society requires broad trade and large state like organizations.

The information society is based upon communication and the thesis may be that communication creates community and that global communication is creating a global community.

All of these (except conspiracy) are useful paradigms but none grasp the Greater Reality of the Divine Destiny in the affairs of man.

To know its source, to fathom its purpose, to recognize its destiny, goes beyond the pale of ordinary human knowledge. Still, in all its workings, the events that transpire, the manner in which they will come about, the things which they will accomplish, will look quite natural and ordinary to the uninformed.

Click here to return to the  
[Table of Contents](#)

---

*America's Role in the NWO: Against and For.*

"Right or wrong - my country"

and

"My country is always right"

are two patriotic views, whenever found, wherever found, in the world will lead to conflict.

America has paradoxically played both the greatest roles against and for the formation of the NWO. Because it has been both economically and politically the leading power in the world, any of its activities have had the greatest effects. This applies both to those organizations in the U.S. that have advocated programs and policies compatible with establishing the NWO, and those organizations, which have been opposed.

The presentation, in this section, is addressed mainly to those Americans who are opposed to the NWO. Those who are most adamant against the NWO go about with bumper stickers on their cars saying, "Get us out of the UN now!" and will often indicate in conversation that they feel that the President of the United States is a traitor to the country. While those are extreme attitudes, they have had sufficient influence in the past to make the U.S., through the "conservative" members of its Congress, the world's greatest opponent of the NWO.

What is presented here is a series of questions to try to get American opponents of the NWO to view things from a global perspective and the viewpoint of citizens of other countries.

How would American's feel if some other country was to dictate to the U.S. that they were not to do experiments with weapons of mass destruction?

Many of the citizens of North Korea, Iraq and other countries feel that the U.S. is being a bully when the U.S. tells their country to not to experiment with missiles and nuclear weapons. A "fair" system would equally forbid such experiments by large, wealthy, and powerful countries. To do otherwise is like saying that the wealthy in a community can use guns to enforce their will on the poorer citizens, and that the wealthy are the only one's permitted to have guns.

What would Americans think if Russia had invaded Mexico or some South American country to assure that the indigenous Indians were being treated fairly?

Russians would see a parallel between this and the U.S. supported war over Kosovo. While the action was nominally a NATO action, the majority of the troops and equipment were American. Moreover, American indignation about such things is looked upon by much of the rest of the world as a matter of hypocrisy. Citizens of other countries can point out how the U.S. had black slavery, how it treated the indigenous Amerindians, and during the Second World war its citizens of Japanese descent. To other nations, such as China, that have not resolved the conflict between their diverse cultures, and who have masses of people who have not yet adapted to the principles of democracy, it appears that the U.S. is

impatient with an evolutionary process of development. Other nations also feel that they have been singled out for human rights interventions because the U.S. has some other "self interest" or "political agenda" since major instances of ethnic cleansing and human rights violations happen elsewhere without U.S. intervention, despite the loud pleas of the victims.

How would Americans feel if Puerto Rico wanted to become an independent country and the U.S. did not want it to and the U.S. was having war games in Florida and Russia sent in its fleet between Puerto Rico and the U.S. or between the U.S. and Cuba to demonstrate its willingness to protect them?

This may be similar to how China feels about the U.S. sending its fleet in between it and Taiwan during China's war games. China feels that Taiwan's "rebellion" is similar to the rebellion of the Confederate States in the U.S. Civil War and that it has a similar "right" to enforce its rule over Taiwan as the U.S. Federal Government did over the Confederates. Moreover, they are disturbed that the U.S. is supplying arms to Taiwan.

What do you imagine American feelings would be, if the U.S. had supplied a client nation with tanks and other arms, and the Russians came in and destroyed them before they were ever even paid for?

The Russians were really hoping to get oil from Iraq for the arms that they had supplied to them. The U.S. had previously been supplying Iraq also because it wanted a strong buffer against Iran.

What would Americans think if the Russians made a no nuclear missile testing treaty and then said that they were going to unilaterally tear it up?

But the U.S. is doing just that. This does not very likely make the Russians feel very secure. There have equally well been violations of treaties in force, by the Russian side. But the U.S. has been opposed to independent inspection and verification (except of course for other countries like Iraq), so there is no way to actually know what has occurred.

What if in violation of its constitution, the Commander in Chief of the Russian Military (without permission of its Duma) were to start war with a nation (next door to the U.S. - say Canada) win that war and send in occupying troops so that the Russian troops were sitting in Canada?

The Russians would see this as a very parallel situation with there being Americans in Kosovo.

Can you imagine a world with weapons so terrible that nations can destroy the world and that leaders decide that they need rule of law in the whole world so that no one nation cannot bring it to catastrophe. So after the most terrible war the world has ever seen they sit down to form such a system, but the most powerful nation, although it hosts the meeting, refuses to join because the conservatives in the country won't let it. What if this had been Russia hosting the meeting but refusing to join because the dyed in the wool communists wanted to form the Comintern to take over the world.

But actually it was the U.S. that hosted the formation of the League of Nations in San Francisco after the First World War and then refused to join.

What if immediately after the end of that war the Russians had thought the U.S. weak and had invaded it? Would Americans then be a bit suspicious about the Russians?

But it was the U.S., with hundreds of thousands of ally troops, that invaded the Russians after World War I, although the Russians managed to repulse the invasion. A war never told about in American high school history books, but always told about in the Russian ones.

Those astounded by the previous fact should do a key word search on the Internet on the words: "Allied Intervention".

What if this failure to set up world law, brought on an even worse war, and now the Russians had said yes they would join this time, (to form a new system - called the United Nations) but if there was any law about to be passed that they did not like then the conservatives in their country insisted that they would not have to abide by it (this is called the veto) or they would not join? What would Americans think of the Russians about that?

But it was the U.S. not the Russians that insisted on the veto.

What if the Russians had joined the U.N. and while we kept the agreement not to invade another country, without U.N. permission, they went ahead and invaded somewhere in our hemisphere as close as southern Mexico, or in Panama, in complete violation of the U.N. Charter to which they had agreed. Would Americans in that case feel that the Russians were a threat and were pushing.

This is exactly the Kosovo situation from the Russian point of view?

What if the U.S. was in a major depression? Its soldiers were behind in their pay. Housing conditions were terrible. Training was falling apart, and Russia was greatly increasing its military spending invading countries nearby to the U.S., "accidentally" bombing U.S. embassies, refusing to abide by treaties and the U.N. Charter, and there were in Russia conservative leaders crying that everything is falling apart in the Russian Military, and that they need to be spending much, much more for arms development.

However, it is just the reverse, in that it is Russia falling apart economically, Russia which cannot really afford more arms, or to keep up the arms that it has - although yes, they have launched Peter the Great, new nuclear submarines, are struggling to keep Mir in space, when it should be coming down, have a new fighter plane, and so forth, (but the U.S. is FAR, FAR better equipped), and yet the U.S. conservatives are yelling for more and more arms, and demanding that the U.S. not be obedient to the World Court, or follow U.N. decrees.

If the shoe were on the other foot, and it was Russia doing the things above that the U.S. has done, would

Americans think the Russians were being bad international citizens and a threat to their safety?

Do the Americans really need all this screaming for more and more arms? What will it accomplish? Both sides already have more than enough to destroy the world. Both sides are already sufficiently angry with each other to start such a conflict. What will be the end result? Does it not appear inevitable? Should we not be thinking beyond this?

It will not help insight to respond to the above examples with counter examples of wrong doing on the other side, because the above questions were not about fact, but rather about feeling and perception. It is feeling and perception, the creating of emotion that will lead to the great catastrophe

Before we are too hard on the U.S. we must remember that the "Flag of World Unity" was first raised in San Francisco as the League of Nations, and that New York City was the "City of the Covenant" where the United Nations, the beginning of the NWO was established. That covenant will eventually, after World War Three, be extended and made firm, so as to assure that all aggressors are immediately dealt with and no further wide conflicts can occur.

[Click here to return to the  
Table of Contents](#)

---

## *The effect of the NWO:* **Great GOOD and Great EVIL**

Some people look upon the NWO as being unmatched evil, others look to it for unparalleled good. In reality it will be neither, but a mixture of the two. The great evil of the NWO is that it is incapable of bringing deep, lasting spiritual peace and unity to mankind. This deficiency is so great that eventually there will again be universal disturbance, although not so great and terrible as the one that will prompt its establishment. That future disturbance will, however, be so disturbing to a much more enlightened humanity that it will finally establish a universal system that will lead to a much more perfect peace and spiritual unity. These matters, however, are seen as being far into the future, at the end of a period of time called the millenium, or a thousand years, and are represented variously in a variety of Jewish, Christian, Moslem, Hindu and other philosophies, (for example such as the Nazi thousand year Reich).

It may strike some strange, to take such a long view of history, but there have been long periods of social structure before, such as the medieval period or the Chinese Dynasties. However, for those who do not see the Divine Destiny and Purpose of society these concepts will be but idle speculation. Indeed, for many, the very purpose behind the NWO, or for that matter life itself, is veiled in a total mystery.

The purpose of the NWO, in the Divine Destiny, is to allow a further period for the maturing of the human race. It is sort of a summer school for a humanity that has failed to pass the grade. Since humanity



has not yet attained unto the maturity of which it is capable it needs to continue to develop its social and spiritual skills. It is this lack of social and spiritual skills that will create many of the evils.

At the present humanity continues to wallow in the problems of racism, nationalism, religionism, and materialism. The problems of selfishness and immorality are universal and rampant. The catastrophe that will usher in the NWO may cause many to re-examine their personal priorities and philosophies but most of the attitudes and problems will remain to be matured out of over a long period (probably centuries) of time.

The two major problems or threats to modern society that will be ameliorated by the NWO are international political and economic warfare. This will of course be at the expense of national independence and it will have a degree of impact on some individuals as to cultural practices, private property ownership, and various social freedoms. These are always the costs of organized society over anarchy but usually the reduction in the freedoms and benefits of the few increases the freedoms and benefits of the many. The privileged wealthy may have their assets confiscated in order to reduce the poverty of the masses. At least that would be the ideal of communism. However, the NWO will not be communistic. Private incentive and greed have now been shown through numerous large social experiments in Russia, China and elsewhere to be greater producers of wealth than communism. But still there remained masses of economically disenfranchised masses in India, Southeast Asia, Africa, South America and elsewhere. Whether or not, and how soon the NWO will find a universal solution to these serious problems is in itself problematical.

[Click here to return to the  
Table of Contents](#)

---

## *The Government of the Anti-Christ:* **Not what many think**

Many people are upset about the expected Government of the Anti-Christ. What is offered here is a generic explanation. There are many religions and religious groups that look forward to the establishment of a Theocratic Government over the entire earth. In Christian terms this would be called the Government of Christ. Any alternate world government would be the government of the Anti-Christ.

Numerous graphic descriptions of the Government of the Anti-Christ, are to be found in both the Bible and numerous books by Christian writers. It is an understatement to say that the general interpretation is that it is not a good thing. Nevertheless, most of the interpretations are that it is an inevitable thing, and if this is indeed true then one should consider what is the proper role to play in regards to the secular NWO (the Government of the Anti-Christ).

The relationship to secular governments, of those who wish to follow Theocratic or Divine governments,

has been an age-old question. Jesus advice to "Render unto Caesar that which belongs to Caesar" is probably as good today as ever.

The NWO may well permit theocratic "shadow" governments such as now exist in some cultural communities in many parts of the world. However, resistance or antagonism against the secular government will be anti-social behavior that will require remediation. Those who are separatist or non-conforming will have to undoubtedly be willing to accept whatever penalties or deprivations that may entail.

We must remember that the very reason that the world will be under the rule of a secular government is that it has not progressed spiritually to the point where it can live under a theocratic government. Those who wish to see progress made in that direction need to take a positive and active role in the affairs of the secular government rather than withdrawing or being antagonistic and thus leaving the field open to those with philosophies that they find distasteful.

[Click here to return to the  
Table of Contents](#)

---

## *When the NWO will be established:* **A work in progress.**

The NWO has been a work in progress for many decades. To human sense it will appear to be a system that grows like Topsy, however there will be others who feel that there is a Divine Destiny in the affairs of man. A middle view might be that while there is an overall scheme or destiny, that there are also contingent incidences that provide for a degree of variety and the action of human free will. Such it appears to be in most of the affairs of men. From the day that we are born, we have no choice but to grow into human adults, but we do have a range of choice in being educated or ignorant, moral or immoral, athletic or non-athletic, and so forth.

As it is individually with humanity, so is it also collectively. Unfortunately, as observed by Admiral Rickover, humanity has chosen to become an intellectual and technological giant but a moral and spiritual pygmy. Nevertheless, world society, as immature as it may be has grown to adulthood and that adulthood requires and involves it having a world government. Since it cannot, because of mankind's spiritual immaturity, be a spiritual or Theocratic government, establishing a system of universal spiritual peace (seen by Christians as being the Kingdom of Christ on earth) it must then be a secular government, referred to in prophetic literature as being the government of the anti-Christ, or the NWO.

This development of the NWO was not a sudden event, nor will it be a sudden event. The spiritual decay of humanity, at the very time when it should have been a time of its spiritual maturing, has been a century long process. If we were to compare the human collective to that of a single individual we would

say that it is emerging from a decadent teenage, ill-prepared and ill-equipped to assume the responsibilities of adulthood, as it now must.

The human immaturity, as evidenced by two world-wide conflicts, of increasing devastation, and that it is about to engage in a third more catastrophic than all those before. As evidenced by the fact that in a world gifted by God of immense resources, that it continues to spend atrocious amounts on armaments while much of humanity remains ill-fed, ill-housed and ill-educated. This list of the misdirection of its God given resources, spiritual, natural and intellectual could be much extended, but once again it must be emphasized that it did not happen suddenly and that its destiny has been decades in the making.

As a human individual matures their physical requirements change whether their intellectual and spiritual growth keeps pace with their physical growth or not. They require larger sizes of clothing, more calories of food, social mechanisms to control their activities and regulate emerging forces such as sexual drives. The same is true of the human collective. In small numbers it can live in isolated tribes, and in slightly larger numbers as city-states, but eventually nations emerge and as world-enveloping technology develops a world unifying social order becomes a necessity. Whether or not that social order will be secular or spiritual depends upon the maturity of the inhabitants of the planet. Unfortunately, the inhabitants of this planet have chosen spiritual immaturity, hence the NWO as we shall come to know it.

The future mechanisms of the NWO will grow out of those of the present. Namely the United Nations, the IMF, the World Court, national entities, various forms of human government consisting of democracies, kings and despots, collectives of cultures and all the present diversity of races, religions and philosophies. The previous and present spiritual inadequacies and social ill adaptations of these institutions will be but slowly modified. Nevertheless, it is a task upon which the leaders of thought among mankind, must embark. The present inadequacies result from the previous deficiencies and the future inadequacies will result from the present deficiencies. We must make every effort that we can, to remedy the present deficiencies. The responsibility, morally and spiritually, is ours.

[Click here to return to the  
Table of Contents](#)

---

## *Peace in the NWO:* **Not perfect**

In Jewish and Christian scriptures there is a time of peace described such that "the lion will lie down with the lamb". Whether or not one looks upon this as a literal expectation, it is representative of expectations of a time of Great Peace. Literalist theologians also have expectations of sudden establishment of peace, an expectation shared by various "new age" groups whereby it will be attained through external intervention from other space dwellers or through some mystical passing of humanity into a new awareness, awakening, or enlightenment.

What we are describing here will be a more conventional series of events. A primary premise of this writer is that there will be a World Nuclear War that will have a motivational effect upon the world's inhabitants to further form the NWO. The first step will be as universal a conclave of the nations and principalities as can be called. Just as the United Nations was formed in San Francisco which was where its predecessor the League of Nations had been established, so also shall the successor to the United Nations (even if it retains the same name) meet in the vicinity of New York, if the devastation so permits. It may however eventually establish a world center and enclave in Jerusalem, a recognized World Center, by four of the World's Religions, and a recognized Holy Place by many cultures and groups. The reason for this is that there will be no other easy and practical way to eliminate the conflict that continually arises over that area and that it avoids catering to national interests and arguments that would arise from locating it elsewhere, aside from choosing some island in the sea.

Conflicts will still continue to arise, however, between cultural majorities and minorities within countries. The resolution of those conflicts will not be simple, even before a world court, and many of them may be traumatic. The standards of governments within countries will quite differ. Some will have less than benevolent despots, but in order to retain a degree of autonomy for all countries and to avoid the problems of over-centralization, there will be a method of recognizing and certifying the "legitimate" governments of each country, and other contenders will be considered revolutionaries which the "legitimate" governments will have the right to suppress, if they can. This in itself will lead to decades of limited, but often severe and tragic conflicts.

[Click here to return to the Table of Contents](#)

---

## *Freedom in the NWO:* **The Golden Mean**

The great bug-a-boo with many people about the NWO is that they fear that there will be a loss of freedom. In actuality, for most people, their freedom will be increased by the NWO. The greatest and most important freedom, that of the practice of religion and one's relationship to God, will, over time, be greatly increased. Initially, because of the anarchy, resulting from the Great Catastrophe, there will be a removal of the current restraints on persecution and some minority communities in some cultures and nations will be subjected to genocide by the dominant communities, but the more gross incidences will be eliminated in a matter of decades as an International Standard of Freedoms and Rights is established and gradually adhered to. Some cultures, based on a predominant religion that has a lesser traditional degree of tolerance will continue to be more oppressive than others.

Many freedoms are tied to economic independence. In the past money has talked. In the future money will talk. Freedom from poverty gives access to health, education, travel and communication. A man without means is really not very free, except to sit and starve.

Freedom, on the other hand, is very much limited by many institutions other than government. Ask any married man (or woman). Also any employed person. Society may permit you to sleep in on Monday morning, but your employer may take a dim view of your doing so. It is your employer who is limiting this and many other freedoms. Indeed, the more institutions of which one is a member the more their freedoms are limited. Some religious organizations limit their members from smoking and drinking. Neighborhood institutions place many requirements on how one maintains their home. This list goes on and on.

The larger, more complicated and interrelated society becomes the more freedoms are restricted in one sense. To take just one example. No one cares what side of the road one drives down a backwoods path but it becomes very critical on a four-lane highway. In a sense that is a loss of freedom, this inability to drive on whichever side of the road that you wish. On the other hand, an intracontinental network of four lane highways can give one much more freedom to travel than one of backwoods paths. This example too can be many times multiplied. Law, order, and rule restrict freedom on the one hand and greatly increase it on the other.

Too much freedom (anarchy) or too many rules (restrictive bureaucracy) can be equally deleterious. The search must always be for the Golden Mean.

Aside from yelling fire in a crowded theatre, most libertarians would tell you that there should be no restrictions on freedom of speech. Experience has begun to bring even this into question in the minds of many as they hear unlimited profanity pounding their ears from every quarter of the entertainment industry, expect copycat murders following one sensationalized by the media, observe hate crimes proliferated and motivated by hate literature, and hear of nefarious tools of destruction such as pipe bombs explained about on the Internet. Still, the freedom for the exchange of ideas is so important that many fear to draw any line between purity and pornography.

For the last century, technology has been the answer to extending (and perhaps over-extending) freedom, and not just in transportation and communication. Note for example the sexual revolution and also freedoms from disease and injuries as the consequences of accident and war that have been obtained through the advances in medicine and surgery.

There have always been greater freedoms for the wealthy. This will undoubtedly continue to be the case. But as a greater degree of wealth can be extended to a greater number of people on the planet, so can a greater degree of freedom, in every form that we have discussed.

[Click here to return to the  
Table of Contents](#)

## *Prosperity in the NWO: Life is a struggle*

Some persons will pin their hopes on the NWO as a panacea for all of mankind's ills. But it is not. The human condition will remain. Life will continue to be a struggle. The Divine Purpose for human life is the development of the soul and for this purpose struggle and tests are necessary.

The NWO will eventually achieve a level of prosperity, for the descendants of the survivors of most of the world's masses, considerably beyond what they have attained now. Certainly far beyond what presently exists for the impoverished masses in the sub-Sahara of North Africa, population centers of Bangladesh, or the rice paddies of China and South East Asia. However, the general level of the world's consumption will probably never match the level of the generally affluent middle classes in the present United States in which many barbaric teenage males drive around in large machines consuming annually great quantities of non-renewable energy, and can spend most of their time in idle preoccupations of games, sports, and various forms of audio visual entertainment and diversion.

The present wasteful consumption of resources, as symptomized above, is rampant throughout North American society, as also evidenced by the number of ounces of clothing possessed by the average member of the population, the annual expenditure on cosmetics, the national per capita expenditure on armaments and weaponry for war. Those who take pleasure in such a standard of living, will find that they have lived in the best of times, never to return again, while those who have lived in the deprivation described earlier will be able to point back to these as the worst of times. All will find the circumstances immediately following the Great Catastrophe as being the absolute worst of times.

But what does the future hold? There will continue to be limited although abundant resources of energy, minerals, water, land and so forth. The ratio of capital assets, even with the massive destruction that will have taken place, will be the greatest to have ever existed in history, simply because of the sudden depletion of population. Initially, in the restoration of civilization, the first priority will have to be given to agriculture, and after that distribution. But soon the importance of communication and technology will return to the fore in the fortunes of any nation.

The question will then remain as to who has the power, influence and control over the means of large-scale production, distribution, and communication. No single answer presents itself. The NWO Government will supervise the control of the world currency but this begs the question, as to who will actually be in control. Strangely, even in Western Democracies, at the present, while the government prints the currencies it is privately involved interests who control them through institutions such the Federal Reserve Bank, the World Bank, the International Monetary Fund and so forth.

While there will be a Supreme World Tribunal, the NWO will not be a single monolithic organization. Other institutions, similar to those we have just named, will have their influence. In addition to the World Government, national, provincial and local governments will all have their spheres of influence. There will continue (or be re-established) all sorts of other licensing, regulating, authorizing authorities such as we have now. There will be boundaries (some not very clear cut) of interaction between these various

entities. Not that much different than from what it is today.

The scourge, and heavy world burden of cost, for both armed and economic warfare will be reduced. The former immediately and the latter more and more over time, but the quality of life in any one area will be dependent upon the resources, industriousness, education, and initiative of the inhabitants of that area. One of the key words there is initiative, because it has been shown time and again that while there are certainly many efficiencies in economics of scale, still centralized control is inefficient and that which is most productive is motivated individual initiative. Some balance must always be struck between the polarity of those two factors. The carrot and the stick will remain the greatest providers of initiative.

It is in regards to questions like this that the question of economic social justice is most clouded. Those with the least economic or social power to control policy will remain on the whiplash end of policy decisions that decide the availability of capital, the application of interest rates and taxes, the degree of economic activity as determined by the level of employment. The motivating factor behind those who presently set such policies is one of greed. Whether or not, and particularly how soon, this can be tempered in the future by some other sense of social justice is presently completely undecided. At this point in time, to describe possible paths and potential programs is but utopian dreaming.

The individual then, under the NWO, will, as the individual now, have to make choices regarding honesty, integrity, morality, compassion, generosity, and a whole range of other spiritual values. The focus of their life, whether it be spiritual or material or any range of balances between the two, will be of their own choosing and they will continue to bear the eternal consequences for the responsibilities of their actions.

[Click here to return to the  
Table of Contents](#)

---

## *Morality in the NWO: A New Victorian Age*

In the eyes of many, the very cause of the Great Catastrophe will have been God's just retribution upon the immorality of mankind. In a sense this is also the cause of the establishment of the NWO. In truth the retribution will not be only for mass failure in individual morality but also for failure in collective social morality as evidenced by rampant racism, wide areas of world poverty, lack of literacy, and a litany of other ills foremost among which must be named the insane building of weapons of mass destruction, narcissistic nationalism, and rabidly dogmatic religions of almost every stripe and fever.

The collective social morality will be harder to correct, but there will be a return to Puritanism beside which the Victorian variety will pale. One would have no need to be surprised by the burning of libraries, the destruction of theatres, the searching out of film storage facilities, and a general purging and

exhibition of repugnance at the emblems of what has become an evil immoral world.

The anger about what has been wrought upon the earth, by what is seen as God's retribution, may not extend only to the physical by-products but to various classes of people who have advocated immoral practices. Whether or not these might also include the military, bankers, lawyers, politicians, or any other group will depend upon the temper of the times.

[Click here to return to the  
Table of Contents](#)

---

## *Spirituality in the NWO:* **The continuing path**

The complete establishment of the NWO, being preceded as it will be by the Great Catastrophe, will be accompanied by a thorough re-evaluation by many of the purpose of life. The problem being so immense, many will flee from it in different ways. Some into cloistered monasteries that separate them from the struggles of the world, others into chemical evasions. The only proper response is the development of the spiritual capacities in relationship to the life in this world, as was the intention of the Creator. For the masses of humanity to travel that path, physically, mentally, intellectually, morally, and spiritually will require centuries to attain unto that Most Great Peace which is the intention of its Creator.

[Click here to return to the  
Table of Contents](#)

---

## *Critiques:* **Your comments are welcomed.**

Please send your critique, comments, or contribution to the email address at the top.

Since this is a new posting, there have none been received as yet.

[Click here to return to the  
Table of Contents](#)

---

**MENU:** [HOME](#) » [Reconstruction](#) » [Recovery](#) » [Renewal](#) » [NWO Introduction](#)

---





## RESPONSIBILITIES

Much is heard today about the violations of human rights. The idea behind forming a statement, *of responsibilities* is that 'rights' for adults are accompanied by responsibilities.

### Some Principles of the Responsibilities of Adults

To One's God  
To One's Community  
To One's Family  
To One's Self

#### To One's God

To know God and to worship Him  
To recognize His latest Manifestation and be obedient to His laws  
To pray and read the Word of God each day  
To teach others about God's Word  
To contribute to one's religion  
To consort with people of all religions  
in a spirit of friendliness and fellowship  
To respect all of God's creatures and creation.

#### To One's Community or Society

To be obedient to one's government  
To contribute to the welfare of the poor,

handicapped, elderly, and orphaned

To have a sense of world citizenship

To have a sense of community citizenship

To serve one's fellowman

To work for world unity and peace

To work for universal understanding and language

To support the elimination of prejudices

To support the equal rights of men and women, races,  
varied cultures and religions

To support the development of science, the arts, and culture

## To One's Family

To teach one's children about religion

To be happy and love one another

To develop strong unified families  
and respect the rights of each individual

To support one's family and children

To educate one's children

## To One's Self

To sincerely and honestly investigate the Truth  
and overcome superstitions and vain imaginations

To be moral and improve one's character

To earn a living by a trade, craft or profession

To become educated and informed

To be moderate and balanced in one's consumption

## Summary

There are undoubtedly more rights and responsibilities than one could exhaustively list. There are rights and responsibilities between employers and employees, governments and their citizens, marriage partners and their spouses, children and their parents, and many other combinations that could be named.

The smallest infant, of course has only rights and no responsibilities. It is as one begins to mature that they gain responsibilities. It is for this reason, that they may mature, that young children should start to be given responsibilities starting from a very young age.

In any relationship the responsibilities of the partners to the relationship may, and indeed usually will, differ. Thus it is that governments will have one set of responsibilities and its citizens another. Employers one and employees another. Even within marriages there are defined areas of responsibilities. This is not to say that all citizens, employees, marriage partners, or children within a family are not equal.

Equality, however, is often a chimera. Both the needs and capabilities of individuals differ. Consequently, the rights and responsibilities of an older sibling will often be radically different from those of a younger. Such distinctions apply to the whole of the family of man. Those individuals with particular needs, or talents, must be given special consideration to satisfy those needs, or develop those talents.

The pressing need of individual humanity today is for Justice. The pressing need of collective humanity today is for Unity. When unity is achieved by mankind peace will naturally ensue. Many persons today mistakenly believe that peace is the most pressing need of mankind today, but true and lasting peace will not be just the absence of war, it will be the result of the unification of mankind. If this unification is accompanied by Justice it will also naturally result in prosperity.

The unity of mankind does not presuppose the homogenization of mankind. There can be, indeed must be, diversity in unity. For mankind to fulfill its potential it must display all the diversity and variety in the human garden that is seen, by analogy, in a beautifully cultured flower bed.

These, then, are the ideals that the mature thinker, or if you will, that the mature soul must strive towards in this day. To the degree, and only to the degree, that more and more of humanity becomes composed of mature and responsible adults will the heavenly kingdom appear on earth. It is the responsibility of each one of us to strive towards that goal.

This is a preliminary attempt to develop a statement of the responsibilities of a mature adult.

YOUR assessment, comments, or suggested additions or modifications would be greatly appreciated.

**MENU:** [HOME](#) » [Reconstruction](#) » [Recovery](#) » [Renewal](#) » [NWO Introduction](#)

---

---

*[The following list of quotes is a combination of four, mostly anonymous sources, who are opposed to the NWO, so I apologise that I cannot give better references, such as page numbers, and so forth.*

*The present editor (Bruce Beach) has further organized, edited and supplemented the quotes. If any reader can provide further quotes, sources, or suggestions, they will be much appreciated. [bruce@webpal.org](mailto:bruce@webpal.org)*

*In order to distinguish my editorial comments I have emphasized them and have placed them in brackets.]*

## **"Quotes from famous people about THE NEW WORLD ORDER"**

*[The following quotations] "...clearly demonstrate that the words "new world order" are deadly serious and furthermore, have been in use for decades. They did not originate with President George Bush in 1990. The "old world order" is one based on independent nation-states. The "new world order" involves the elimination of the sovereignty and independence of nation-states and [creation of] some form of world government. This means the end of the United States of America, the U.S. Constitution, and the Bill of Rights as we now know them. Most of the new world order proposals involve the conversion of the United Nations and its agencies to a world government, complete with a world army, a world parliament, a world court, global taxation, and numerous other agencies to control every aspect of human life (education, nutrition, health care, population, immigration, communications, transportation, commerce, agriculture, finance, the environment, etc.). The various notions of the "new world order" differ as to details and scale, but agree on the basic principle and substance."*

**Statement by one of the original compilers  
of some of these quotes.**

*[The degree of control is certainly a matter of speculation. There will certainly be some control, (just as there is now, but maybe more or less) or guidelines or restrictions in most of these areas, but the degree would vary from area to area and as a matter of practicality it will often be important to avoid over centralization. A second point raised in the above involves the elimination of national sovereignty, and if we mean by that the right to make war, by either physical or economic means, then that is undoubtedly true, however the NWO by no means requires the elimination of national or cultural identities.]*

**Index of quotes**

[Click here to return to the](#)

*[While it is possible to use the index to find a particular individual it is best for a first time reader to simply go to the first entry and to then read through all the quotes and comments sequentially. However, for those who wish just a sampling - some have been marked with four blue*

*stars \*\*\*\* to show that ALL the US presidents for many years have worked towards its establishment - and that simultaneously they and others have been concerned about other powers involved. The easiest way to view just these marked quotes is to click on the blue stars to read the quote and then to use the back button on your browser to go back to the stars before scrolling down to the next set of stars.]*

[Statements by \(or about\) World Leaders  
\(such as US Presidents\)  
in favor of the NWO](#)

[William Clinton](#) \*\*\*\*

[William Clinton](#)

[Richard Nixon](#)

[Richard Nixon](#) \*\*\*\*

[John F. Kennedy](#) \*\*\*\*

[George Herbert Walker Bush](#)

[President George Bush \(January 1991\)](#)

[President George Bush](#)

[President George Bush](#) \*\*\*\*

[President George Bush](#)

[President George Bush](#)

[32 U.S. Senators and 92 U.S. Representatives](#)

[Hubert H. Humphrey](#)

[George McGovern](#)

[Richard Gephardt](#)

[Dr. Henry Kissinger](#) \*\*\*\*

[Dr. Henry Kissinger](#)

[Dr. Henry Kissinger](#)

[Dr. Henry Kissinger](#)

[John Foster Dulles and Thomas E. Dewey](#)

[Arthur Schlesinger, Jr.](#) \*\*\*\*

[Zbigniew Brzezinski](#) \*\*\*\*

[Zbigniew Brzezinski](#)

[Undersecretary of State Sumner Welles](#)

[Strobe Talbot, President Clinton's Deputy Secretary of State](#)

[A. M. Rosenthal](#)

[William Safire](#)

[Soviet President Mikhail Gorbachev](#)



[Soviet President Mikhail Gorbachev](#)

[Nelson Mandela](#)

[President Hosni Mubarak of Egypt](#)

[David Spangler, Director of Planetary Initiative, United Nations](#)

[Nebraska State Senator Peter Hoagland](#)

[Stansfield Turner, CFR member and former CIA director](#)

[Willy Brandt, Former West German Chancellor](#)

Statements by (or about) the Rich and/or Famous in favor of NWO

[David Rockefeller](#) \*\*\*\*

[Gov. Nelson Rockefeller](#)

[Gov. Nelson Rockefeller](#)

[Gov. Nelson Rockefeller](#)

[Gov. Nelson Rockefeller](#)

[Senator William Fulbright](#)

[Richard Gardner, Council on Foreign Relations member](#)

[Richard Gardner, Council on Foreign Relations member](#)

[James Warburg, Council on Foreign Relations member](#) \*\*\*\*

[Professor Arnold Toynbee](#)

Richard A. Falk \*\*\*\*

Sen. Joseph R. Biden, Jr.

Government of Morocco

Kenichi Ohmae, political reform leader in Japan,

Brent Scowcroft

Brent Scowcroft, George Bush's National Security Advisor

American Institute of Judaism

Stephen John Stedman

States Legislatures

Notre Dame Professor

Nicholas Murray Butler

M. C. Alexander

Dr. Augustus O. Thomas

H. G. Wells \*\*\*\*

Statements by world leaders  
such as US Presidents  
of concern about conspiracy

Woodrow Wilson \*\*\*\*

FDR \*\*\*\*

[Curtis Dall, FDR's son-in-law](#)

[Henry Ford](#)

[Winston Churchill](#)

[Benjamin Disraeli, first Prime Minister of England](#)

[Benjamin Disraeli, first Prime Minister of England](#)

[Supreme Court Justice Felix Frankfurter](#) \*\*\*\*

[John F. Kennedy](#) \*\*\*\*

[Joseph Kennedy, father of JFK](#)

[Senator William Jenner](#)

[U.S. Senator Barry Goldwater](#)

[U.S. Senator Barry Goldwater](#)

[Professor Carroll Quigley](#)

Statements of concern about conspiracy by the Rich and/or Famous

[Norman Thomas](#)

[New York City Mayor John F. Hylan](#)

[Congressman Larry P. McDonald](#)

[Myron Fagan](#)

[British military historian MajorGeneral J.F.C. Fuller](#)

[Former Congressman John Rarick](#)

[U.S. Congressman Oscar Callaway](#) \*\*\*\*

[Christian Science Monitor editorial, June 19th, 1920](#)

[The Christian Science Monitor, September 1, 1961](#)

[Monthly Review Press](#)

[Harpers](#)

[Stratcom](#) \*\*\*\*

---

## Statements outright opposed to the NWO

[Episcopal Church in General Convention](#)

[The New York Times](#)

[Senator Jesse Helms - 1987 before US Senate](#) \*\*\*\*

Click here to return to the  
[Root Document](#)

---

## Statements by (or about) World Leaders (such as US Presidents) in favor of the NWO

"There are a lot of very brilliant people who believe that the nation-state is fast becoming a relic of the past,"

**President Clinton,  
New York Times, November 25, 1997**

Click here to return to the  
[Index](#)

"What I'm trying to do is to promote a process of reorganization of the world ..."

**President Clinton,  
interview with Argentine reporters, October 17, 1997.**

Click here to return to the  
[Index](#)

"The developing coherence of Asian regional thinking is reflected in a disposition to consider problems and loyalties in regional terms, and to evolve regional approaches to development needs and to the evolution of a new world order."

**Richard Nixon, in Foreign Affairs (October 1967)**

*[There are those who have proposed Regional Governments. Regional spheres of influence. The aspirations of Japan in Asia, of Russia over what was the USSR, of the US in the Americas (an extension of the Monroe Doctrine), and so forth. But American's see their interests as more global, such as their oil interests in the Near East. Communication, air transportation, use of the seas and satellite space, world wide pollution and environmental concerns, along with many other issues, are global in nature. Large sovereign regional governments could, and would, lead to inter-regional conflicts. Consequently, regional alliances must be seen simply as a step towards greater global unification.]*

Click here to return to the  
[Index](#)

"He [President Nixon] spoke of the talks as a beginning, saying nothing more about the prospects for future contacts and merely reiterating the belief he brought to China that both nations share an interest in peace and building 'a new world order.'"

**Excerpt from an article in The New York Times (February 1972)**

*[Many of the leaders of China, Russia, the U.S. and many other countries, all recognize the need for an effective world government. The bone of contention remains as to who (and what philosophy) is going to control it. Capitalism has been more economically successful but there are still those who oppose it. They particularly oppose the imposition of "western" capitalism and even "western" culture.]*

Click here to return to the  
[Index](#)

"The United Nations cannot survive as a static organization. Its obligations are increasing as well as its size. Its charter must be changed, as well as its customs. The authors of that charter did not intend that it be frozen in perpetuity. The science of weapons and war has made us all one world and one human race with one common destiny. The United Nations, building on its successes and learning from its failures, must be developed into a genuine world security system."

**President John F. Kennedy**  
September 20, 1963

*[All statesmen, no matter their country or political affiliation, have identified the problem just as President Kennedy did here. Those who are opposed to One World Government need to point out an alternative solution, and any suggested to this writer will be gladly published in these pages.]*

Click here to return to the  
[Index](#)

"The world can therefore seize the opportunity [Persian Gulf crisis] to fulfill the long-held promise of a New World Order where diverse nations are drawn together in common cause to achieve the universal aspirations of mankind."

**George Herbert Walker Bush**

*[The quotes from Nixon and Bush should leave no one accusing the NWO concept of being a "leftish" idea. In point of fact, it is a universalist concept that cuts across the lines of the political left and right, besides all geographical and cultural sectors of the world.]*

Click here to return to the  
[Index](#)

"If we do not follow the dictates of our inner moral compass and stand up for human life, then his lawlessness will threaten the peace and democracy of the emerging new world order we now see, this long dreamed-of vision we've all worked toward for so long."

**President George Bush (January 1991)**

Click here to return to the  
[Index](#)

"What is at stake is more than one small country, it is a big idea - a new world order...to achieve the universal aspirations of mankind...based upon shared principles and the rule of law.... The illumination of a thousand points of light.... The winds of change are with us now."

**President George Bush**  
**In his State of the Union message during the Gulf War.**

Click here to return to the  
[Index](#)

"It is the sacred principles enshrined in the United Nations charter to which the American people will henceforth pledge their allegiance."

**President George Bush**  
**addressing the General Assembly of the U.N.,**  
**February 1,1992**

Click here to return to the  
[Index](#)

The Persian Gulf crisis is a rare opportunity to forge new bonds with old enemies (the Soviet Union). Out of these troubled times a New World Order can merge under a United Nations that performs as envisioned by its founders."

**George Bush,**  
**September 11, 1990**

Click here to return to the  
[Index](#)

"The world can therefore seize the opportunity (the Persian Gulf crisis) to fulfill the long-held promise of a New World Order where diverse nations are drawn together in common cause to achieve the universal aspirations of mankind."

**George Bush,**  
**in his State of the Union Address,**  
**January 29, 1991**

Click here to return to the  
[Index](#)

"Two centuries ago our forefathers brought forth a new nation; now we must join with others to bring forth a new world order."

**32 U.S. Senators and 92 U.S. Representatives  
in Washington, D.C. on January 30, 1976,  
signed a "Declaration of Interdependence."**

Click here to return to the  
[Index](#)

"A New World Order"

**Title of article on commencement address  
at the University of Pennsylvania by  
Hubert H. Humphrey,  
printed in the Pennsylvania Gazette (June 1977)**

Click here to return to the  
[Index](#)

"I would support a Presidential candidate who pledged to take the following steps: ... At the end of the war in the Persian Gulf, press for a comprehensive Middle East settlement and for a 'new world order' based not on Pax Americana but on peace through law with a stronger U.N. and World Court."

**George McGovern,  
in The New York Times (February 1991)**

*[From their inceptions, the League of Nations and the United Nations were doomed to failure because of the weakness of their charters that permitted continued national anarchies.]*

Click here to return to the  
[Index](#)

"We can see beyond the present shadows of war in the Middle East to a new world order where the strong work together to deter and stop aggression. This was precisely Franklin Roosevelt's and Winston Churchill's vision for peace for the post-war period."

**Richard Gephardt,  
in The Wall Street Journal (September 1990)**

*[And we could add to that President Woodrow Wilson, the effective father of the League of Nations, who*



*in reality sacrificed his health and life for its formation, but who was frustrated by the shortsightedness of the U.S. Congress.]*

Click here to return to the  
[Index](#)

"Today, America would be outraged if U.N. troops entered Los Angeles to restore order [referring to the 1991 LA Riot]. Tomorrow they will be grateful! This is especially true if they were told that there were an outside threat from beyond [i.e., an "extraterrestrial" invasion], whether real or \*promulgated\* [emphasis by original compiler], that threatened our very existence. It is then that all peoples of the world will plead to deliver them from this evil. The one thing every man fears is the unknown. When presented with this \*scenario\*, individual rights will be willingly relinquished for the guarantee of their well-being granted to them by the World Government."

**Henry Kissinger speaking at Evian, France, May 21, 1992  
Bilderburgers meeting.  
Unbeknownst to Kissinger,  
his speech was taped by a Swiss delegate to the meeting.**

*[President Ronald Regan also commented that what this planet needed was an invasion from an outside enemy, in order to unify it. The accuracy of the above quote is however highly suspect, because the Bilderberger meetings are kept very secret and no minutes or reports are released to the public.]*

Click here to return to the  
[Index](#)

"My country's history, Mr. President, tells us that it is possible to fashion unity while cherishing diversity, that common action is possible despite the variety of races, interests, and beliefs we see here in this chamber. Progress and peace and justice are attainable. So we say to all peoples and governments: Let us fashion together a new world order."

**Henry Kissinger,  
(in address before the General Assembly of the United Nations, October 1975)**

Click here to return to the  
[Index](#)

"How to Achieve The New World Order"

**Title of book excerpt by Henry Kissinger,  
in Time magazine (March 1994)**

Click here to return to the  
[Index](#)

"NAFTA is a major stepping stone to the New World Order."

**Henry Kissinger,  
when campaigning for the passage of NAFTA**

Click here to return to the  
[Index](#)

"He [John Foster Dulles] stated directly to me that he had every reason to believe that the Governor [Thomas E. Dewey of New York] accepts his point of view and that he is personally convinced that this is the policy that he would promote with great vigor if elected. So it is fair to say that on the first round the Sphinx of Albany has established himself as a prima facie champion of a strong and definite new world order."

**Excerpt from article by Ralph W. Page  
in The Philadelphia Bulletin (May 1944)**

Click here to return to the  
[Index](#)

"We are not going to achieve a new world order without paying for it in blood as well as in words and money."

**Arthur Schlesinger, Jr., in Foreign Affairs (July/August 1995)**

*[Well! Still probably not what this editor thinks. That the agreement on the NWO will be reached as the result of all out Nuclear War. The World Millenium Conference has already been scheduled for September 2001.]*

Click here to return to the  
[Index](#)

"This regionalization is in keeping with the Tri-Lateral Plan which calls for a gradual convergence of East and West, ultimately leading toward the goal of one world government. National sovereignty is no longer a viable concept."

**Zbignew Brzezinski, National Security Advisor  
to President Jimmy Carter**

Click here to return to the  
[Index](#)

"the precondition for eventual and genuine globalization is progressive regionalization...".

**- Zbigniew Brzezinski at the State of the World Forum, 1995**

Click here to return to the  
[Index](#)

"Undersecretary of State Sumner Welles tonight called for the early creation of an international organization of anti-Axis nations to control the world during the period between the armistice at the end of the present war and the setting up of a new world order on a permanent basis."

**Text of article in The Philadelphia Inquirer (June 1942)**

*[Many have thought and struggled for the idea for a long time.]*

Click here to return to the  
[Index](#)

"In the next century, nations as we know it will be obsolete; all states will recognize a single, global authority. National sovereignty wasn't such a great idea after all."

**Strobe Talbot,  
President Clinton's Deputy Secretary of State,  
as quoted in Time, July 20th, 1992.**

Click here to return to the  
[Index](#)

"But it became clear as time went on that in Mr. Bush's mind the New World Order was founded on a convergence of goals and interests between the U.S. and the Soviet Union, so strong and permanent that they would work as a team through the U.N. Security Council."

**Excerpt from A. M. Rosenthal,  
in The New York Times (January 1991)**

Click here to return to the  
[Index](#)

"... it's Bush's baby, even if he shares its popularization with Gorbachev. Forget the Hitler 'new order' root; F.D.R. used the phrase earlier."

**William Safire,  
in The New York Times (February 1991)**

*[An idea whose time has come.]*

Click here to return to the  
[Index](#)

"Further global progress is now possible only through a quest for universal consensus in the movement towards a new world order."

**Mikhail Gorbachev,  
in an address at the United Nations (December 1988)**

*[Much of the world sees the need but only catastrophe will motivate it to action.]*

Click here to return to the  
[Index](#)

"We are beginning to see practical support. And this is a very significant sign of the movement towards a new era, a new age.... We see both in our country and elsewhere... ghosts of the old thinking.... When we rid ourselves of their presence, we will be better able to move toward a new world order...relying on the relevant mechanisms of the United Nations."

**Soviet President Mikhail Gorbachev,  
at the Middle East Peace Talks in Madrid (1991)**

Click here to return to the  
[Index](#)

"The new world order that is in the making must focus on the creation of a world of democracy, peace and prosperity for all."

**Nelson Mandela,  
in The Philadelphia Inquirer (October 1994)**

*[And especially universal justice.]*

Click here to return to the  
[Index](#)

The renewal of the nonproliferation treaty was described as important "for the welfare of the whole world and the new world order."

**President Hosni Mubarak of Egypt,  
in The New York Times (April 1995)**

*[Another limited idea. What will actually be required after the Third World War (nuclear) is the total elimination of weapons of mass destruction.]*

Click here to return to the  
[Index](#)

"No one will enter the New World Order unless he or she will make a pledge to worship Lucifer. No one will enter the New Age unless he will take a Luciferian Initiation."

**David Spangler, Director of Planetary Initiative, United Nations**

*[Highly emotional statements like this one are VERY suspect. It is unlikely any person who was pro-NWO would use that kind of terminology or make that kind of statement even if that were their Luciferian philosophy. Further, we must note that the statement is undated and no source is given. It is these types emotional statements that prevent rational discussion of the issues.]*

Click here to return to the  
[Index](#)

"Fundamental, Bible-believing people do not have the right to indoctrinate their children in their religious beliefs because we, the state, are preparing them for the year 2000 when America will be part of a one-world global society, and their children will not fit in."

**Nebraska State Senator Peter Hoagland (1982)**

Click here to return to the  
[Index](#)

"We have a much bigger objective. We've got to look at the long run here. This is an example - the situation between the United Nations and Iraq - where the United Nations is deliberately intruding into the sovereignty of a sovereign nation.... Now this is a marvelous precedent (to be used in) all countries of the world...."

**Stansfield Turner,  
CFR member and former CIA director,  
when asked about Iraq on CNN**

Click here to return to the  
[Index](#)

"The New World Order is a world that has a super-national authority to regulate world commerce and industry; an international organization that would control the production and consumption of oil; an international currency that would replace the dollar; a World Development Fund that would make funds available to free and communist nations alike; and an international police force to enforce the edicts of the New World Order."

**Willy Brandt, Former West German Chancellor  
and former chairman of the Fifth Socialist International,  
Chairman of the Brandt Commission in the late 1980's**

Click here to return to the  
[Index](#)

---

## Statements by (or about) the Rich and/or Famous in favor of NWO

"We are grateful to The Washington Post, The New York Times, Time Magazine and other great publications whose directors have attended our meetings and respected their promises of discretion for almost forty years. It would have been impossible for us to develop our plan for the world if we had been subject to the bright lights of publicity during those years. But, the work is now much more sophisticated and prepared to march towards a world government. The supranational sovereignty of an intellectual elite and world bankers is surely preferable to the national autodetermination practiced in past centuries."

**David Rockefeller,  
( founder of the Trilateral Commission),  
in an address to a meeting of The Trilateral Commission,  
in June, 1991.**

*[Very scary. This should perhaps have been almost better under the conspiracy section. But it is the reality. The reality concerning the monetary system. Who controls the Federal Reserve? The reality concerning Congress. Who controls the main committees? The reality concerning the political parties. Who controls the smoke filled back rooms? But it is most irritating regarding the press. There was a Bilderberger's meeting near where I live. The press made zip effort to report it. Scary. But no different in other countries or systems. The patriotic media only tells us what the military wants us to know during a*

*war. The loyal media is careful to toe the government's and banker's line during a crisis like Y2K, so that other than the "official" line all we got were "nut" stories. Can we make it different under the New World Order? Sadly, probably not. But we should try.]*

Click here to return to the  
[Index](#)

"The United Nations, he told an audience at Harvard University, 'has not been able--nor can it be able--to shape a new world order which events so compellingly demand.' ... The new world order that will answer economic, military, and political problems, he said, 'urgently requires, I believe, that the United States take the leadership among all free peoples to make the underlying concepts and aspirations of national sovereignty truly meaningful through the federal approach.'"

**Gov. Nelson Rockefeller of New York,  
in an article entitled "Rockefeller Bids Free Lands Unite:  
Calls at Harvard for Drive to Build New World Order"  
-- The New York Times (February 1962)**

*[Now, actually another limited idea. ALL must now be united. At one time it might have been possible to have formed a commonwealth of nations that had achieved a certain level of democracy and prosperity and to continuously widen the circle by motivating others to meet the standards so that they could also gain the benefits of joining the club, but that time too is now past. All must now be required to join the club and abide by the rules in order to eliminate the nuclear threat.]*

Click here to return to the  
[Index](#)

"At the old Inter-American Office in the Commerce Building here in Roosevelt's time, as Assistant Secretary of State for Latin American Affairs under President Truman, as chief whip with Adlai Stevenson and Tom Finletter at the founding of the United Nations in San Francisco, Nelson Rockefeller was in the forefront of the struggle to establish not only an American system of political and economic security but a new world order."

**Part of article in The New York Times (November 1975)**

Click here to return to the  
[Index](#)

"We are on the verge of a global transformation. All we need is the right major crisis and the nations will accept the New World Order."

**David Rockefeller**

Click here to return to the  
[Index](#)

"But this present window of opportunity, during which a truly peaceful and interdependent world order might be built, will not be open for long. Already there are powerful forces at work that threaten to destroy all of our hopes and efforts to erect an enduring structure of global interdependence."

**David Rockefeller,  
speaking at the Business Council for the United Nations,  
September 14, 1994**

Click here to return to the  
[Index](#)

"The case for government by elites is irrefutable"

**Senator William Fulbright,  
Former chairman of the US Senate Foreign Relations Committee,  
stated at a 1963 symposium entitled:  
The Elite and the Electorate - Is Government by the People Possible?**

*[This is not a core concept to the idea of the NWO. There can still be the "one person / one vote". On the other hand, voter eligibility standards, as regards literacy and so forth, does not sound unreasonable. Monitoring of voting to assure fairness, is also another reasonable concept.]*

Click here to return to the  
[Index](#)

"If instant world government, Charter review, and a greatly strengthened International Court do not provide the answers, what hope for progress is there? The answer will not satisfy those who seek simple solutions to complex problems, but it comes down essentially to this: The hope for the foreseeable lies, not in building up a few ambitious central institutions of universal membership and general jurisdiction as was envisaged at the end of the last war, but rather in the much more decentralized, disorderly and pragmatic process of inventing or adapting institutions of limited jurisdiction and selected membership to deal with specific problems on a case-by-case basis ... In short, the 'house of world order' will have to be built from the bottom up rather than from the top down. It will look like a great 'booming, buzzing confusion,' to use William James' famous description of reality, but an end run around national sovereignty, eroding it piece by piece, will accomplish much more than the old-fashioned frontal assault."

**Richard N. Gardner, in Foreign Affairs (April 1974)**



*[This is a pragmatic view regarding what has occurred to date. But time and opportunity change. A nuclear war may be necessary to bring humanity to that point of change.]*

Click here to return to the  
[Index](#)

"In short, the 'house of world order' will have to be built from the bottom up rather than from the top down. It will look like a great 'booming, buzzing confusion.' To use William James' famous description of reality, but an end run around national sovereignty, eroding it piece by piece, will accomplish much more than the old-fashioned frontal assault."

**Richard N. Gardner,  
in Foreign Affairs, April 1974**

Click here to return to the  
[Index](#)

"We shall have world government whether or not you like it, by conquest or consent."

**Statement by  
Council on Foreign Relations (CFR) member  
James Warburg  
to The Senate Foreign Relations Committee  
on February 17th, 1950**

*[It is difficult to see, who could conquest whom, in a world filled with weapons of mass destruction. On the other hand it is certainly conceivable that there may be universal consent to forming a world government in order to prevent their repeated use.]*

Click here to return to the  
[Index](#)

"We are at present working discreetly with all our might to wrest this mysterious force called sovereignty out of the clutches of the local nation states of the world."

**Professor Arnold Toynbee,  
in a June 1931 speech before  
the Institute for the Study of International Affairs in Copenhagen.**

*[The historian's view. I don't know that Toynbee would agree historiographically but I would call it the Divine Destiny.]*

Click here to return to the  
[Index](#)

"The existing order is breaking down at a very rapid rate, and the main uncertainty is whether mankind can exert a positive role in shaping a new world order or is doomed to await collapse in a passive posture. We believe a new order will be born no later than early in the next century and that the death throes of the old and the birth pangs of the new will be a testing time for the human species."

**Richard A. Falk,**  
in an article entitled  
"**Toward a New World Order: Modest Methods and Drastic Visions,**"  
in the book **On the Creation of a Just World Order (1975)**

Click here to return to the  
[Index](#)

"How I Learned to Love the New World Order"

**Article by Sen. Joseph R. Biden, Jr.**  
in **The Wall Street Journal (April 1992)**

Click here to return to the  
[Index](#)

"The Final Act of the Uruguay Round, marking the conclusion of the most ambitious trade negotiation of our century, will give birth - in Morocco - to the World Trade Organization, the third pillar of the New World Order, along with the United Nations and the International Monetary Fund."

**Part of full-page advertisement**  
**by the government of Morocco**  
in **The New York Times (April 1994)**

*[The many embryonic organizations such as the WTO, the IMF, the World Bank, even the International Olympic Organization, will all need to be brought under the purview of the NWO World Government. Openly. Responsive. Responsible.]*

Click here to return to the  
[Index](#)

"New World Order: The Rise of the Region-State"

**Title of article by Kenichi Ohmae,  
political reform leader in Japan,  
in The Wall Street Journal (August 1994)**

*[As mentioned before, Region-States can have certain benefits, but they can have no more sovereignty than that allowed to any other "independent" nations and must be subject to the same controls regarding military organization, monetary regulation, and so forth as any other "independent" nation.]*

Click here to return to the  
[Index](#)

"We believe we are creating the beginning of a new world order coming out of the collapse of the U.S.-Soviet antagonisms."

**Brent Scowcroft (August 1990),  
quoted in The Washington Post (May 1991)**

*[Many events have laid the groundwork for what must in the final analyses be an emerging human consciousness of universalism.]*

Click here to return to the  
[Index](#)

"A colossal event is upon us, the birth of a New World Order."

**Brent Scowcroft,  
George Bush's National Security Advisor,  
on the eve of the Gulf War**

Click here to return to the  
[Index](#)

"The statement went on to say that the spiritual teachings of religion must become the foundation for the new world order and that national sovereignty must be subordinate to the higher moral law of God."

**American Institute of Judaism,  
excerpt from article in The New York Times (December 1942)**

*[Would that mankind could realize this. But no, there remains too great a diversity among the peoples of the earth and consequently the NWO will remain simply a secular state. Much progress will have to follow in subsequent centuries in order to achieve the spiritualization of the planet. This is of course a*

*somewhat secular view. There are those religionists who expect otherwise. Such as Christians expecting the establishment of a Divine Kingdom with Jesus sitting on the throne, or New Age religionists expecting some universal harmonic suddenly changing the nature of man in the Age of Aquarius.]*

Click here to return to the  
[Index](#)

"Alchemy for a New World Order"

**Article by Stephen John Stedman  
in Foreign Affairs (May/June 1995)**

Click here to return to the  
[Index](#)

"If totalitarianism wins this conflict, the world will be ruled by tyrants, and individuals will be slaves. If democracy wins, the nations of the earth will be united in a commonwealth of free peoples, and individuals, wherever found, will be the sovereign units of the new world order."

**The Declaration of the Federation of the World,  
produced by the Congress on World Federation,  
adopted by the Legislatures of  
North Carolina (1941),  
New Jersey (1942),  
Pennsylvania (1943),  
and possibly other states.**

*[Or it can be both. The NWO may well have to make room for both totalitarian and democratic states.  
The progress of humanity may well be slow and painful.]*

Click here to return to the  
[Index](#)

"New World Order Needed for Peace:  
State Sovereignty Must Go,  
Declares Notre Dame Professor"

**Title of article in The Tablet (Brooklyn) (March 1942)**

Click here to return to the  
[Index](#)

"The old world order changed when this war-storm broke. The old international order passed away as suddenly, as unexpectedly, and as completely as if it had been wiped out by a gigantic flood, by a great tempest, or by a volcanic eruption. The old world order died with the setting of that day's sun and a new world order is being born while I speak, with birth-pangs so terrible that it seems almost incredible that life could come out of such fearful suffering and such overwhelming sorrow."

**Nicholas Murray Butler,**  
**in an address delivered before the Union League of Philadelphia,**  
**Nov. 27, 1915**

*[This may very well be accurate. It is however, a long and painful birth, which has not yet reached its climax at this writing in 1999.]*

Click here to return to the  
[Index](#)

"The peace conference has assembled. It will make the most momentous decisions in history, and upon these decisions will rest the stability of the new world order and the future peace of the world."

**M. C. Alexander,**  
**Executive Secretary of the American Association for International Conciliation,**  
**in a subscription letter for the periodical International Conciliation (1919)**

*[And many more have met since. But we still await another. Perhaps in September of 2000. If not then, then surely soon.]*

Click here to return to the  
[Index](#)

"If there are those who think we are to jump immediately into a new world order, actuated by complete understanding and brotherly love, they are doomed to disappointment. If we are ever to approach that time, it will be after patient and persistent effort of long duration. The present international situation of mistrust and fear can only be corrected by a formula of equal status, continuously applied, to every phase of international contacts, until the cobwebs of the old order are brushed out of the minds of the people of all lands."

**Dr. Augustus O. Thomas,**  
**president of the World Federation of Education Associations (August 1927),**  
**quoted in the book**  
**International Understanding: Agencies Educating for a New World (1931)**

*[Or alternatively, through the impetus of great catastrophe. The shared catastrophe of a nuclear WWII would be the first world wide shared event. Even during the first and second world wars, America, while losing soldiers overseas did not taste of the direct effects of war. Today, through such things as the photographs of the earth from space, there has been a growing global consciousness, but the global catastrophe may be the final crucible necessary to get it to meld together.]*

Click here to return to the  
[Index](#)

"... when the struggle seems to be drifting definitely towards a world social democracy, there may still be very great delays and disappointments before it becomes an efficient and beneficent world system. Countless people ... will hate the new world order ... and will die protesting against it. When we attempt to evaluate its promise, we have to bear in mind the distress of a generation or so of malcontents, many of them quite gallant and graceful-looking people."

**H. G. Wells,**  
**in his book entitled The New World Order (1939)**

*[Always astonishing, how well Wells could see the future.]*

Click here to return to the  
[Index](#)

---

## Statements by world leaders such as US Presidents of concern about conspiracy

"Since I entered politics, I have chiefly had men's views confided to me privately. Some of the biggest men in the United States, in the Field of commerce and manufacture, are afraid of something. They know that there is a power somewhere so organized, so subtle, so watchful, so interlocked, so complete, so pervasive, that they better not speak above their breath when they speak in condemnation of it."

**Woodrow Wilson, The New Freedom (1913)**

*[There are undoubtedly conspiracies. That there is "A" conspiracy, is questionable. Many leaders have had false ideas similar to those found among the masses of people on such subjects as religion, astrology, and you name it. Among the conspirators that do exist, from the Bilderbergers to the Tri-lateral Commission, from the Oil Cartels to other business associations of great number, from the board of directors of great corporations to their interlocking memberships with the banks and others, their is undoubtedly much overlap in membership, agreement about goals and collusion in policy, but all of their*

*members would generally resent being considered as being conspirators. Insiders, yes. Power brokers, yes. Elite, probably. But evil conspirators no. Nevertheless, there must be wrested from their clasp the rights of the rest of the citizens of the world. No matter how enlightened or altruistic they may feel, they must not be allowed to govern without the consent of the governed - all the rest of the citizens of the world.]*

Click here to return to the [Index](#)

"The real truth of the matter is, as you and I know, that a financial element in the larger centers has owned the Government ever since the days of Andrew Jackson."

### **A letter written by FDR to Colonel House, November 21st, 1933**

*[Unfortunately, undoubtedly true. Regardless of which party happens to be in power at the moment. This however, is not a conspiracy in the intended sense. It is the operation of the "old boys" club. The wealthy looking out for the wealthy. And they do indeed control everything. From large contributions to the political parties, to the corporations, to the media. Oftentimes (usually) even the churches. The control is subtle however. If one does not hold the "right" ideas, they simply do not get promoted or funded. There is no obvious pledge of allegiance that one has to make. In the media for example, a publisher that thinks wrongly just will not get funding. An editor that thinks wrongly will just not get hired. By the time we get down to the cub reporter every attitude is so ingrained that nothing that truly questions the institutions will be seriously considered. This is as true under every system. Capitalism, Communism, Naziism, Catholicism, Judaism, you name it. It is a human problem. The first thing in human history to perhaps offer a break of the iron box has been the Internet, and there are those who are seeking to control it. At the invention of the printing press, there were many concerned about the spread of literacy to the masses. They need not have worried. Ways were found to control the media, as we have just seen. Will the same happen to the web?]*

Click here to return to the [Index](#)

"For a long time I felt that FDR had developed many thoughts and ideas that were his own to benefit this country, the United States. But, he didn't. Most of his thoughts, his political ammunition, as it were, were carefully manufactured for him in advanced by the Council on Foreign Relations-One World Money group. Brilliantly, with great gusto, like a fine piece of artillery, he exploded that prepared "ammunition" in the middle of an unsuspecting target, the American people, and thus paid off and returned his internationalist political support. "The UN is but a long-range, international banking apparatus clearly set up for financial and economic profit by a small group of powerful One-World revolutionaries, hungry for profit and power. "The depression was the calculated 'shearing' of the public by the World Money powers, triggered by the planned sudden shortage of supply of call money in the New York money market....The One World Government leaders and their ever close bankers have now acquired full control

of the money and credit machinery of the U.S. via the creation of the privately owned Federal Reserve Bank."

**Curtis Dall,  
FDR's son-in-law as quoted in his book,  
My Exploited Father-in-Law**

*[Conspiracy theory holds that nothing happens by accident, and in the Divine sense this is true, but not everything is under the control of man. At the outset, no one knew what the outcome and effects of the industrial revolution would be, nor were they in control of those effects. Conspiracy theory holds that every evil happening, plague, war, famine, depression is planned and controlled by the masterminds. But it simply is not true. In the 1800's no one knew that atomic bombs would come into existence, or the effects of air power, electronic communication and so forth. See also the following entry, for a further comment on the Federal Reserve Bank.]*

Click here to return to the  
[Index](#)

"It is well enough that people of the nation do not understand our banking and monetary system, for if they did, I believe that there would be a revolution before morning. And that revolution would be based around the Federal Reserve."

**Henry Ford**

*[The subject of the Federal Reserve Bank is another whole conspiracy subject within itself, but I have put Ford's comment here in connection with that of Dall in the entry above. I did my master's in economics foreign language reading requirement on the subject of the benefit of reserve banking systems - and they are many. The issue of these systems being privately controlled is, however, another matter as is that of autonomous national systems with the ability to print currency, borrowing from outside. It must be conceded that the economic / monetary system will control the political system and that is why it should be the first matter of political concern. In my idealism I propose a heirarchical system of LETS systems, but I fear that this is but utopian thinking and in my New World Order essays I explain my practical expectations.]*

Click here to return to the  
[Index](#)

"From the days of Sparticus, Wieskhopf, Karl Marx, Trotsky, Rosa Luxemburg, and Emma Goldman, this world conspiracy has been steadily growing. This conspiracy played a definite recognizable role in the tragedy of the French revolution. It has been the mainspring of every subversive movement during the 19th century. And now at last this band of extraordinary personalities from the underworld of the great cities of Europe and America have gripped the Russian people by the hair of their head and have become



the undisputed masters of that enormous empire."

**Winston Churchill,  
stated to the London Press, in 1922.**

*[Even Churchill was a conspiracy believer. And anti-Semitic at that. What he is talking about, and what this quote relates to, is a book called the Protocols of the Elders of Judaism. It is a completely fallacious Machiavellian book, although insightful in the same sense as was Machiavelli and maybe in some sense as de Touqueville. ]*

Click here to return to the  
[Index](#)

"The world is governed by very different personages from what is imagined by those who are not behind the scenes."

**Benjamin Disraeli,  
first Prime Minister of England,  
in a novel he published in 1844 called  
Coningsby, the New Generation**

*[Undoubtedly equally true today. But still not by one single conspiracy]*

Click here to return to the  
[Index](#)

"The governments of the present day have to deal not merely with other governments, with emperors, kings and ministers, but also with the secret societies which have everywhere their unscrupulous agents, and can at the last moment upset all the governments' plans. "

**British Prime Minister Benjamin Disraeli, 1876**

*[This also remains undoubtedly true. But we must remember that the term "societies" is in the plural. They are legion, and often at considerable variance with each other. The ones in Moslem countries are not in harmony with the ones in Christian countries, Japanese Society or the powers that control communist Russia and China (yes they remain largely communist influenced.) Even within those spheres there are often several powers at odds with each other.]*

Click here to return to the  
[Index](#)

"The real rulers in Washington are invisible, and exercise power from behind the scenes."

**Supreme Court Justice Felix Frankfurter, 1952**

*[Many (most) educated or observing minds come to this conclusion. One of the main reasons that there is so little voter participation. Because there is so little real choice.]*

Click here to return to the  
[Index](#)

"The high office of President has been used to foment a plot to destroy the Americans freedom, and before I leave office I must inform the citizen of his plight."

**John Fitzgerald Kennedy  
Columbia University,  
10 days before his assassination**

Click here to return to the  
[Index](#)

"Fifty men have run America, and that's a high figure."

**Joseph Kennedy, father of JFK,  
in the July 26th, 1936 issue of The New York Times.**

Click here to return to the  
[Index](#)

"Today the path of total dictatorship in the United States can be laid by strictly legal means, unseen and unheard by the Congress, the President, or the people. Outwardly we have a Constitutional government. We have operating within our government and political system, another body representing another form of government - a bureaucratic elite."

**Senator William Jenner, 1954**

*[Well, this is another matter. And still not a conspiracy. It is just the nature of institutions to feed on themselves, and to promote and defend themselves.]*

Click here to return to the  
[Index](#)

"The Trilateral Commission is intended to be the vehicle for multinational consolidation of the commercial and banking interests by seizing control of the political government of the United States. The Trilateral Commission represents a skillful, coordinated effort to seize control and consolidate the four centers of power political, monetary, intellectual and ecclesiastical. What the Trilateral Commission intends is to create a worldwide economic power superior to the political governments of the nationstates involved. As managers and creators of the system ,they will rule the future."

**U.S. Senator Barry Goldwater  
in his 1964 book: With No Apologies.**

*[Yes, there are many political power centers, some of which are quite interbred and feed into the others, but there are still others that are in opposition. Externally we can observe that they are motivated by greed and the desire for power and control, but internally their members see themselves to be altruistically motivated and committed to a philosophy that is for the betterment of mankind. It is this latter that must be appealed to when the time comes for the restoration of society.]*

Click here to return to the  
[Index](#)

"In my view The Trilateral Commission represents a skillful, coordinated effort to seize control and consolidate the four centers of power - political, monetary, intellectual, and ecclesiastical. All this is to be done in the interest of creating a more peaceful, more productive world community. What the Trilateralists truly intend is the creation of a worldwide economic power superior to the political governments of the nation-states involved. They believe the abundant materialism they propose to create will overwhelm existing differences. As managers and creators of the system they will rule the future."

**U.S. Senator Barry Goldwater  
Republican candidate for President  
in his 1964 book: With No Apologies.**

Click here to return to the  
[Index](#)

"The powers of financial capitalism had another far reaching aim, nothing less than to create a world system of financial control in private hands able to dominate the political system of each country and the economy of the world as a whole. This system was to be controlled in a feudalist fashion by the central banks of the world acting in concert, by secret agreements, arrived at in frequent private meetings and conferences. The apex of the system was the Bank for International Settlements in Basle, Switzerland, a private bank owned and controlled by the worlds' central banks which were themselves private corporations. The growth of financial capitalism made possible a centralization of world economic control and use of this power for the direct benefit of financiers and the indirect injury of all other economic groups."

**Tragedy and Hope: A History of The World in Our Time**  
**(Macmillan Company, 1966)**  
**Professor Carroll Quigley of Georgetown University,**  
**(highly esteemed by his former student,**  
**William Jefferson Blythe Clinton.)**

*[To recognize this, on either Quigley's part, or Clinton's part, does not mean to advocate it. It can be taken simply as a paradigm in which one must work. The real question that one must ask themselves is what alternative system it is that they would propose. Idealism aside, it will have to be a pragmatic system or it shall never be accomplished.]*

Click here to return to the  
[Index](#)

---

**Statements of concern about conspiracy by the Rich and/or Famous**

"There are some plain common-sense considerations applicable to all these attempts at world planning. They can be briefly stated: 1. To talk of blueprints for the future or building a world order is, if properly understood, suggestive, but it is also dangerous. Societies grow far more truly than they are built. A constitution for a new world order is never like a blueprint for a skyscraper."

**Norman Thomas,**  
**in his book What Is Our Destiny? (1944)**

*[This perhaps does not properly belong under conspirational concerns, but still it is a legitimate concern about the future.]*

Click here to return to the  
[Index](#)

"The real menace of our republic is this invisible government which like a giant octopus sprawls its slimy length over city, state and nation. Like the octopus of real life, it operates under cover of a self created screen....At the head of this octopus are the Rockefeller Standard Oil interests and a small group of powerful banking houses generally referred to as international bankers. The little coterie of powerful international bankers virtually run the United States government for their own selfish purposes. They practically control both political parties."

**New York City Mayor John F. Hylan, 1922**

*[Was it true then? Is it true now? If it is true, is it a problem? If it is a problem, is there a solution? How much serious thought do most people give to these questions?]*

Click here to return to the  
[Index](#)

"The drive of the Rockefellers and their allies is to create a one-world government combining supercapitalism and Communism under the same tent, all under their control.... Do I mean conspiracy? Yes I do. I am convinced there is such a plot, international in scope, generations old in planning, and incredibly evil in intent."

**Congressman Larry P. McDonald, 1976,  
(killed in the Korean Airlines 747 that was shot down by the Soviets)**

*[Well, okay. But there are many such plots and the plotters are often quite in opposition to each other. It is a battle of the Titans and the earth does shake. It can (and will) bring us to nuclear holocaust.]*

Click here to return to the  
[Index](#)

"The idea was that those who direct the overall conspiracy could use the differences in those two so-called ideologies [marxism/fascism/socialism v. democracy/capitalism] to enable them [the Illuminati] to divide larger and larger portions of the human race into opposing camps so that they could be armed and then brainwashed into fighting and destroying each other."

**Myron Fagan**

*[This is the idea that is false. That there is a single underlying conspiracy. Fagan has no real idea as to whom the Illuminati are, nor what are their real goals. "Those who say don't know and those who know don't say." But in the final analysis, they and all secret societies, cliques, groups, associations and so forth need to have their goals, philosophies, operations and so forth exposed to the general light of day so that the generality of mankind can monitor that all that goes on is in its best interest.]*

Click here to return to the  
[Index](#)

"The government of the Western nations, whether monarchical or republican, had passed into the invisible hands of a plutocracy, international in power and grasp. It was, I venture to suggest, this semioccult power which....pushed the mass of the American people into the cauldron of World War I."

**British military historian MajorGeneral J.F.C. Fuller, 1941**

*[We are probably back to the concept behind the Protocols of the Elders of Judaism, or the 14 International Jewish Bankers, and such ilk. All this is fantasy as an overall explanation, and is even fantasy in its particulars as regards the Protocols. There is no one single simple explanation other than all is under the Divine Destiny of the Hand of God.]*

Click here to return to the  
[Index](#)

"The Council on Foreign Relations is "the establishment." Not only does it have influence and power in key decision-making positions at the highest levels of government to apply pressure from above, but it also announces and uses individuals and groups to bring pressure from below, to justify the high level decisions for converting the U.S. from a sovereign Constitutional Republic into a servile member state of a one-world dictatorship."

**Former Congressman John Rarick 1971**

*[Nevertheless, as the Russian and Chinese leaders, as well as Moslem leaders in Iran and elsewhere, besides many others such as in Japan and North Korea would point out - it does NOT control the world, although it may well try.]*

Click here to return to the  
[Index](#)

"In March, 1915, the J.P. Morgan interests, the steel, shipbuilding, and powder interest, and their subsidiary organizations, got together 12 men high up in the newspaper world and employed them to select the most influential newspapers in the United States and sufficient number of them to control generally the policy of the daily press....They found it was only necessary to purchase the control of 25 of the greatest papers. "An agreement was reached; the policy of the papers was bought, to be paid for by the month; an editor was furnished for each paper to properly supervise and edit information regarding the questions of preparedness, militarism, financial policies, and other things of national and international nature considered vital to the interests of the purchasers."

**U.S. Congressman Oscar Callaway, 1917**

*[The establishment controlled the press then. It controls it now. The establishment in Russia controls the press there. In China the same. North Korea. Iran. Iraq. Saudi Arabia. Everywhere. It is just that they are different establishments. The one exception to establishment control has been the Internet in the U.S. and it is too new to know its destiny.]*

Click here to return to the  
[Index](#)

"What is important is to dwell upon the increasing evidence of the existence of a secret conspiracy, throughout the world, for the destruction of organized government and the letting loose of evil."

**Christian Science Monitor editorial, June 19th, 1920**

*[Ouch. The power of Satan (or Mortal Mind as the Christian Scientists would say)? Is this in some abstract metaphysical sense or are we talking specifics?]*

Click here to return to the [Index](#)

"The directors of the CFR (Council on Foreign Relations) make up a sort of Presidium for that part of the Establishment that guides our destiny as a nation."

**The Christian Science Monitor, September 1, 1961**

*[Now THAT is getting specific. Are we now saying that they are "part of a secret society for letting loose evil"? Huhmm. Never know how people are going to see these things.]*

Click here to return to the [Index](#)

"The planning of UN can be traced to the 'secret steering committee' established by Secretary [of State Cordell] Hull in January 1943. All of the members of this secret committee, with the exception of Hull, a Tennessee politician, were members of the Council on Foreign Relations. They saw Hull regularly to plan, select, and guide the labors of the [State] Department's Advisory Committee. It was, in effect, the coordinating agency for all the State Department's postwar planning."

**Professors Laurence H. Shoup and William Minter,  
writing in their study of the CFR,  
"Imperial Brain Trust: The CFR and United States Foreign Policy."  
(Monthly Review Press, 1977).**

*[And there does seem to be a lot of cross breeding between the CFR and the Tri-lateral Commission. But the question remains, "Is what they propose - evil?" And what would you have as an alternative?]*

Click here to return to the [Index](#)

"The most powerful clique in these (CFR) groups have one objective in common: they want to bring about the surrender of the sovereignty and the national independence of the U.S. They want to end

national boundaries and racial and ethnic loyalties supposedly to increase business and ensure world peace. What they strive for would inevitably lead to dictatorship and loss of freedoms by the people. The CFR was founded for "the purpose of promoting disarmament and submergence of U.S. sovereignty and national independence into an all-powerful one-world government."

**Harpers, July 1958**

*["Dictatorship and loss of freedoms" are certainly emotional words but I am sure not ones that would be used by advocates of the policies of the CFR. We must ask ourselves if that is true, especially for most of the inhabitants of this planet, and whether the other goals listed here are for good or evil.]*

Click here to return to the [Index](#)

On March 2, 2000 the state-run People's Daily ran a series of articles... The articles also called for a multi-polar world, instead of one in which the United States is the dominant power - calling for the "establishment of a just and reasonable new world order."

**STRATFOR.COM Global Intelligence Update  
3 March 2000**

Click here to return to the [Index](#)

---

## **Statements outright opposed to the NWO**

"The term Internationalism has been popularized in recent years to cover an interlocking financial, political, and economic world force for the purpose of establishing a World Government. Today Internationalism is heralded from pulpit and platform as a 'League of Nations' or a 'Federated Union' to which the United States must surrender a definite part of its National Sovereignty. The World Government plan is being advocated under such alluring names as the 'New International Order,' 'The New World Order,' 'World Union Now,' 'World Commonwealth of Nations,' 'World Community,' etc. All the terms have the same objective; however, the line of approach may be religious or political according to the taste or training of the individual."

**Excerpt from A Memorial to be Addressed to  
the House of Bishops and the House of Clerical and Lay Deputies  
of the Protestant Episcopal Church in General Convention (October 1940)**

*[Yes, but what do you see as that purpose? Is it for good or for evil? If you say for evil, then what would*



*you have as an alternative? What else will eliminate the threat of nuclear war? If you reply - "The Kingdom of God", then you are not a part of this discussion because we are talking about secular government.]*

Click here to return to the  
[Index](#)

"In the first public declaration on the Jewish question since the outbreak of the war, Arthur Greenwood, member without portfolio in the British War Cabinet, assured the Jews of the United States that when victory was achieved an effort would be made to found a new world order based on the ideals of 'justice and peace.'"

**Excerpt from article entitled  
"New World Order Pledged to Jews,"  
in The New York Times (October 1940)**

*["Justice and peace" sounds good. But the thrust of the article is anti-Semitic. It could have equally well had "white power" or any other racial bias, of which there are many. But no matter what one's prejudice, whether it be racial, religious, economic, political, cultural or whatever, there is a whole planet that must be melded together - or blown apart. It is our choice.]*

Click here to return to the  
[Index](#)

## EXCERPTS FROM SENATOR JESSE HELMS' SPEECH BEFORE THE SENATE, ON 15 DECEMBER, 1987, WARNING AGAINST THE NEW WORLD ORDER:

"This campaign against the American people -against traditional American culture and values - is systematic psychological warfare. It is orchestrated by a vast array of interests comprising not only the Eastern establishment but also the radical left. Among this group we find the Department of State, the Department of Commerce, the money center banks and multinational coporations, the media, the educational establishment, the entertainment industry, and the large tax-exempt foundations.

Mr. President, a careful examination of what is happening behind the scenes reveals that all of these interests are working in concert with the masters of the Kremlin in order to create what some refer to as a New World Order. Private organizations such as the Council on Foreign Relations, the Royal Institute of International Affairs, the Trilateral Commission, the Dartmouth Conference, the Aspen Institute for Humanistic Studies, the Atlantic Institute, and the Bilderberger Group serve to disseminate and to coordinate the plans for this so-called New World Order in powerful business, financial, academic, and official circles. . . .

The psychological campaign that I am describing, as I have said, is the work of groups within the Eastern establishment, that amorphous amalgam of wealth and social connections whose power resides in its control over our financial system and over a large portion of our industrial sector. The principal instrument of this control over the American economy and money is the Federal Reserve System. The policies of the Industrial sectors, primarily the multinational corporations, are influenced by the money center banks through debt financing and through the large blocks of stock controlled by the trust departments of the money center banks.

Anyone familiar with American history, and particularly American economic history, cannot fail to notice the control over the Department of State and the Central Intelligence Agency which Wall Street seems to exercise.... The influence of establishment insiders over our foreign policy has become a fact of life in our time. This pervasive influence runs contrary to the real long-term national security of our Nation. It is an influence which, if unchecked, could ultimately subvert our constitutional order.

The viewpoint of the establishment today is called globalism. Not so long ago, this viewpoint was called the "one-world" view by its critics. The phrase is no longer fashionable among sophisticates; yet, the phrase "one-world" is still apt because nothing has changed in the minds and actions of those promoting policies consistent with its fundamental tenets.

Mr. President, in the globalist point of view, nation-states and national boundaries do not count for anything. Political philosophies and political principles seem to become simply relative. Indeed, even constitutions are irrelevant to the exercise of power. Liberty and tyranny are viewed as neither necessarily good nor evil, and certainly not a component of policy.

In this point of view, the activities of international financial and industrial forces should be oriented to bringing this one-world design - with a convergence of the Soviet and American systems as its centerpiece - into being. . . . All that matters to this club is the maximization of profits resulting from the practice of what can be described as finance capitalism, a system which rests upon the twin pillars of debt and monopoly. This isn't real capitalism. It is the road to economic concentration and to political slavery."

*[Most world leaders and statesmen, yes like Senator Jesse Helms, one of the most vocal opponents of the New World Order, Chairman of the US Senate Committee on Foreign Relations, dedicated anti-Communitic, devoted defender of the military, and seeming advocate of evermore military spending, coming from the industrial / military complex, well understand the threat to democracy wrought by the "financial powers and interests". The problem is that the above statement offers no alternative solution to the nuclear threat.]*

Click here to return to the  
[Index](#)

**MENU: [HOME](#) » [Reconstruction](#) » [Recovery](#) » [Renewal](#) » [NWO Introduction](#)**



# Thoughts and Attitudes of some World Leaders

[bruce@webpal.org](mailto:bruce@webpal.org)

---

There are many world leaders not represented in the following. From their actions, we can guess at the philosophies and thoughts of:

Palestinian Leaders  
The Religious Right in Israel  
Hindu Fundamentalists in India  
Shiite Fundamentalists in Iran  
Sunni Fundamentalists in Iraq  
The Members of Al Qaeda  
The Central Bureaucracy of China  
The Central Bureaucracy of India  
and many, many others throughout the world

The world is not a very tolerant place - but the following is made up largely of quotes from influential people in our own North American society.

## *The Politics of Power*

"Power is the great aphrodisiac."

**Henry Kissinger, New York Times,  
January 19, 1971.**

"We must find new lands from which we can easily obtain raw materials and at the same time exploit the cheap slave labor that is available from the natives of the colonies. The colonies would also provide a dumping ground for the surplus goods produced in our factories."

**Cecil Rhodes,  
"founder" of Rhodesia**

"... somehow, we find it hard to sell our values, namely that the rich should plunder the poor."

**former Secretary of State John Foster Dulles**

"It is money, money, money! Not ideas, not principles, but money that reigns supreme in American politics."

**Senator Robert Byrd, West Virginia**

"I want to scare the hell out of the rest of the world."

**U.S. General Colin Powell  
talking about U.S. military power  
prior to the Gulf War in 1991**

"Short, successful military adventures are as effective as the Super Bowl in diverting people's attention from unpleasant truths."

**John Stockwell,  
former CIA official**

"We need a common enemy to unite us."

**Condoleeza Rice,  
National Security Advisor, March 2000**

"The people of the world genuinely want peace. Some day the leaders of the world are going to have to give in and give, it to them."

**Dwight Eisenhower,  
U.S. president 1953-1961**

"When we got organized as a country and we wrote a fairly radical constitution with a radical bill of rights, giving a radical amount of individual freedom to Americans, it was assumed that the Americans who had that freedom would use it responsibly.... What's happened in America today is too many people live in areas where there's no family structure, no community structure and no work structure. And so there's a lot of irresponsibility. And so a lot of people say there's too much personal freedom. When personal freedom's being abused, you have to move to limit it...."

**President Bill Clinton**

"Freedom is about authority. Freedom is about the willingness of every single human being to cede to lawful authority a great deal of discretion about what you do."

**NYC Mayor Rudolph Giuliani**

"We are potentially the most dangerous agency in the country."

**FBI Director Louis Freeh,  
to the House Judiciary Subcommittee on Crime, 1997**

"The major function of secrecy in Washington is to keep the U.S. people ... from knowing what the nation's leaders are doing."

**John Stockwell,  
former CIA official and author**

"How fortunate for governments that the people they administer don't think."

**Adolph Hitler**

"You know the one thing that is wrong in this country? Everyone gets a chance to have their fair say."

**President Bill Clinton**

"Others are engaging even in an ecotype of terrorism whereby they can alter the climate, set off earthquakes, volcanoes remotely through the use of electromagnetic waves... So there are plenty of ingenious minds out there that are at work finding ways in which they can wreak terror upon other nations...It's real, and that's the reason why we have to intensify our [counterterrorism] efforts."

**Secretary of Defense William Cohen  
at an April, 1997, counterterrorism conference  
sponsored by former Senator Sam Nunn**

"If they do it, it's terrorism, if we do it, it's fighting for freedom."

**a U.S. Ambassador in Central America  
in the 1980s,  
asked to explain how such U.S. actions  
as the mining of Nicaragua's harbors  
and bombing of airports  
differed from the acts of terrorism  
that the U.S. condemned around the world**

"I am strongly in favor of using poisoned gas against uncivilized tribes. The moral effect should be

good...and it would spread a lively terror...."

**Winston Churchill**  
**commenting on the British use of poison gas**  
**against the Iraqis after World War I**

"[The Third World War] is a war that has been fought by the United States against the Third World. It might also be called the Forty-Year War, like the Thirty-Year and Hundred-Year Wars in Europe, for this one began when the CIA was founded in 1947 and continues today. As wars go, it has been the second or third most destructive of human life in all of history, after World War I and World War II."

**John Stockwell,**  
**former CIA official and author**

"I don't see why we need to stand by and watch a country go communist due to the irresponsibility of its people. The issues are much too important for the Chilean voters to be left to decide for themselves."

**Henry Kissinger,**  
**Secretary of State under Richard Nixon,**  
**about Chile prior to the CIA overthrow**  
**of the democratically elected government**  
**of socialist President Salvadore Allende in 1973**

"The great object of American foreign policy ought to be the restoration of a more normal political world, a world in which those states possessing the elements of great power once again play the role their power entitles them to play."

**Robert W. Tucker,**  
**political scientist,**  
**1980**

" The greatest crime since World War II has been U.S. foreign policy."

**Ramsey Clark,**  
**former U.S. Attorney General**

"A world in which others controlled the course of their own development ... would be a world in which the American system would be seriously endangered."

**Benjamin Cohen**

"We have come to recognize that there are potentially desirable limits to economic growth. There are

also potentially desirable limits to the indefinite extension of political democracy...A government which lacks authority ...will have little ability, short of cataclysmic crisis, to impose on its people the sacrifices which may be necessary.."

**1975 Trilateral Commission  
Report on the Governability of Democracies**

"Hitherto acceptable norms of human conduct do not apply. If the United States is to survive, long-standing American concepts of 'fair play' must be reconsidered. We must develop effective espionage and counterespionage services and must learn to subvert, sabotage and destroy our enemies by more clever, more sophisticated, and more effective methods than those used against us. It may become necessary that the American people be made acquainted with, understand and support this fundamentally repugnant philosophy."

**World War II Gen. James Doolittle  
explaining in a secret 1954 report to President Eisenhower  
why CIA covert operations were needed  
and what they entailed.  
From Katherine S. Olmstead's book -  
Challenging the Secret Government, 1996**

"Coming to grips with ... U.S./CIA activities in broad numbers and figuring out how many people have been killed in the jungles of Laos or the hills of Nicaragua is very difficult. But, adding them up as best we can, we come up with a figure of six million people killed and this is a minimum figure. Included are: one million killed in the Korean War, two million killed in the Vietnam War, 800,000 killed in Indonesia, one million in Cambodia, 20,000 killed in Angola ... and 22,000 killed in Nicaragua. These people would not have died if U.S. tax dollars had not been spent by the CIA to inflame tensions, finance covert political and military activities and destabilize societies."

**John Stockwell,  
former CIA official and author**

"Military intervention to maintain the global status quo will become a constant feature of international relations, whether this is justified in terms of fighting drugs, fighting terrorism, containing "rogue states," opposing "Islamic fundamentalism," or containing China."

**Walden Bello,  
sociologist and author,  
International Socialist Review,  
Aug/Sep 2001, p8**

"We should cease to talk about vague and unreal objectives such as human rights, the raising of the living



standards, and democratization. The day is not far off when we are going to have to deal in straight power concepts. The less we are then hampered by idealistic slogans, the better."

**George Kennan,  
head of U.S. State Department Policy Planning Staff,  
1948**

"But what counter-insurgency really comes down to is the protection of the capitalists back in America, their property and their privileges. U.S. national security, as preached by U.S. leaders, is the security of the capitalist class in the US, not the security of the rest of the people."

**Philip Agee, CIA Diary, p562**

"If we have to use force, it is because we are America. We are the indispensable nation. We stand tall. We see further into the future."

**Secretary of State Madelaine Albright  
describing her vision of America's role in the world**

"America must prevent other states "from challenging our leadership or seeking to overturn the established political and economic order....We must maintain the mechanisms for deterring potential competitors from even aspiring to a larger regional or global role."

**Pentagon's Defense Planning Guide for 1994-1999**

" Scare the hell out of the American people."

**Senator Arthur Vandenburg,  
telling President Truman what the he needed to do  
in order to to tax the American people  
to pay for the weapons and covert activities of the U.S.**

## ***National Security State***

"It is the function of the CIA to keep the world unstable, and to propagandize and teach the American people to hate, so we will let the Establishment spend any amount of money on arms."

**John Stockwell,  
former CIA official and author**

"[Nearly 70% of the military budget] is to provide men and weapons to fight in foreign countries in

support of our allies and friends and for offensive operations in Third World countries .. Another big chunk of the defense budget is the 20% allocated for our offensive nuclear force of bombers, missiles, and submarines whose job it is to carry nuclear weapons to the Soviet Union... Actual defense of the United States costs about 10% of the military budget and is the least expensive function performed by the Pentagon..."

**Rear Admiral Gene LaRoque, U.S. Navy retired**

"The two-war strategy is just a marketing device to justify a high [military] budget."

**Retired Air Force Chief of Staff, Merrill McPeak**

"Our government has kept us in a perpetual state of fear, kept us in a continuous stampede of patriotic fervor with the cry of grave national emergency. Always there has been some terrible evil at home or some monstrous foreign power that was going to gobble us up if we did not blindly rally behind it ..."

**General Douglas MacArthur, 1957**

"Just between you and me, shouldn't the World Bank be encouraging more migration of the dirty industries to the LDCs (lesser developed countries)? I think the economic logic behind dumping a load of toxic waste in the lowest wage country is impeccable and we should face up to that.... I've always thought that underpopulated countries in Africa are vastly under polluted; their air quality is vastly inefficiently low compared to Los Angeles or Mexico City."

**Lawrence Summers  
World Bank economist  
and Deputy Secretary of Treasury,  
in a 1991 internal memorandum**

"... the United States has given frequent and enthusiastic support to the overthrow of democracy in favor of "investor friendly" regimes. The World Bank, IMF and private banks have consistently lavished huge sums on terror regimes, following their displacement of democratic governments, and a number of quantitative studies have shown a systematic positive relationship between U.S. and IMF / World Bank aid to countries and their violations of human rights."

**Edward S. Herman,  
economist and media analyst**

"The whole fabric of society will go to wrack if we really lay hands of reform on our rotten institutions. From top to bottom the whole system is a fraud, all of us know it, laborers and capitalists alike, and all of us are consenting parties to it."

**Henry Adams,  
American historian, 1838-1918**

"Those who own the country ought to govern it."

**John Jay,  
American statesman  
and first Chief Justice of US Supreme Court,  
1745-1829**

"If there are men in this country big enough to own the government of the United States, they are going to own it."

**Woodrow Wilson,  
presidential candidate, 1912  
The Nation magazine,  
July 3, 2000, p5**

## ***Corporate Government***

"If the world operates as one big market, every employee will compete with every person anywhere in the world who is capable of doing the same job. There are lots of them and many of them are hungry."

**Andrew Grove, president of Intel Corp.,  
in his book "High Output Management"**

"A considerable proportion of the developed world's prosperity rests on paying the lowest possible prices for the poor countries' primary products and on exporting high-cost capital and finished goods to those countries. Continuation of this kind of prosperity requires continuation of the relative gap between developed and underdeveloped countries - it means keeping poor people poor. Increasingly, the impoverished masses are understanding that the prosperity of the developed countries and of the privileged minorities in their own countries is founded on their poverty."

**Philip Agee,  
CIA Diary, p595**

"The dream of the corporate empire builders is being realized. The global system is harmonizing standards across country after country - down toward the lowest common denominator. Although a few socially responsible businesses are standing against the tide with some limited success, theirs is not an easy struggle. We must not kid ourselves. Social responsibility is inefficient in a global free market, and the market will not long abide those who do not avail of the opportunities to shed the inefficient. And we must be clear as to the meaning of efficiency. To the global economy, people are not only increasingly

unnecessary, but they and their demands for a living wage are a major source of economic inefficiency. Global corporations are acting to purge themselves of this unwanted burden. We are creating a system that has fewer places for people."

**David Korten,  
economist and internationalist**

"We are entering a new phase in human history - one in which fewer and fewer workers will be needed to produce the goods and services for the global population."

**Jeremy Rifkin,  
economist**

"As an economy measures performance in terms of the creation of money, people become a major source of inefficiency. "

**David Korten,  
economist and internationalist**

"Corporations have been enthroned .... An era of corruption in high places will follow and the money power will endeavor to prolong its reign by working on the prejudices of the people... until wealth is aggregated in a few hands ... and the Republic is destroyed."

**Abraham Lincoln,  
American president, 1861- 1865**

"American capitalism, based as it is on exploitation of the poor, with its fundamental motivation in personal greed, simply cannot survive without force - without a secret police force. Now, more than ever, each of us is forced to make a conscious choice whether to support the system of minority comfort and privilege with all its security apparatus and repression, or whether to struggle for real equality of opportunity and fair distribution of benefits for all of society, in the domestic as well as the international order. It's harder now not to realize that there are two sides, harder not to understand each, and harder not to recognize that like it or not we contribute day in and day out either to the one side or to the other."

**Philip Agee,  
CIA Diary, p597**

"A criminal is a person with predatory instincts who has not sufficient capital to form a corporation."

**Howard Scott**

## ***On the Media:***

"Our job is to give people not what they want, but what we decide they ought to have."

**Richard Salent,  
Former President CBS News.**

"One cannot wage war under present conditions without the support of public opinion, which is tremendously molded by the press and other forms of propaganda."

**General Douglas MacArthur**

"Public sentiment is everything. With public sentiment nothing can fail. Without it nothing can succeed. He who molds opinion is greater than he who enacts laws."

**Abraham Lincoln**

"You furnish the pictures and I'll furnish the war."

**publisher William Randolph Hearst's  
attributed instructions to artist Frederic Remington  
in Havana, Cuba.**

"One of the intentions of corporate-controlled media is to instill in people a sense of disempowerment, of immobilization and paralysis. Its outcome is to turn you into good consumers. It is to keep people isolated, to feel that there is no possibility for social change."

**David Barsamian,  
journalist and publisher**

"Propaganda is to a democracy what violence is to a dictatorship."

**William Blum, Rogue State**

" I have the greatest admiration for your propaganda. Propaganda in the West is carried out by experts who have had the best training in the world in the field of advertising and have mastered the techniques with exceptional proficiency ... Yours are subtle and persuasive; ours are crude and obvious ... I think that the fundamental difference between our worlds, with respect to propaganda, is quite simple. You tend to believe yours ... and we tend to disbelieve ours. "

**a Soviet correspondent**

**based five years in the U.S.**

"The propaganda system allows the U.S. leadership to commit crimes without limit and with no suggestion of misbehavior or criminality; in fact, major war criminals like Henry Kissinger appear regularly on TV to comment on the crimes of the derivative butchers. "

**Edward Herman,  
Z magazine Dec 1999 p38**

### ***Final Views:***

"The dream of capitalism is to co-opt people with higher living standards without redistributing any wealth. Without co-optation, widespread repression is the only guarantor of gross inequality."

**Holly Sklar,  
from her book Trilateralism**

"Since it was created in 1995, the WTO has ruled that every environmental, health, or safety policy it has reviewed is an illegal trade barrier."

**Public Citizen report,  
titled 'Whose Trade Organization?  
Corporate Globalization and the Erosion of Democracy.'  
(from The Progressive magazine,  
January 2000, p 8)**

" We are witnessing an unprecedented transfer of power from people and their governments to global institutions whose allegiance is to abstract free-market principle, and whose favored citizens are soulless corporate entities that have the power to shape and break nations."

**Joel Bleifuss,  
In These Times magazine,  
September 2001, p1**

"F[\*\*\*] your Parliament and your Constitution. We pay a lot of good American dollars to the Greeks, Mr. Ambassador. If your Prime Minister gives me talk about Democracy, Parliament and Constitutions, he, his Parliament, and his Constitution may not last very long."

**President Lyndon Johnson  
to a Greek Ambassador, 1970s**

"Get some new lawyers"

**U.S. Secretary of State Madeline Albright  
said to British Foreign Secretary Robin Cook  
when he told her he was informed that  
the NATO bombing of Yugoslavia  
was illegal under international law.**

"This program is the fixed, determined and approved policy of the government of the United States."

**Senator Joseph S. Clark  
speaking on the floor of the Senate, March 1, 1962,  
about PL 87-297,  
which calls for the disbanding of all armed forces,  
and the prohibition of their re-establishment  
in any form whatsoever**

"Our task of creating a socialist America can only succeed when those who would resist us have been totally disarmed."

**Sara Brady,  
Chairwoman of Handgun Control,  
to Sen. Howard Metzenbaum,  
The National Educator,  
January 1994**

"We can't be so fixated on our desire to preserve the rights of ordinary Americans."

**Bill Clinton,  
U.S.A. Today,  
11 March 1993**

"Whatever the price of the Chinese Revolution, it has obviously succeeded not only in producing more efficient and dedicated administration, but also in fostering high morale and community of purpose. The social experiment in China under Chairman Mao's leadership is one of the most important and successful in human history."

**David Rockefeller,  
statement in 1973 about Mao Tse-tung  
in The New York Times,  
August 10, 1973**

"War to the hilt between communism and capitalism is inevitable. Today, of course, we are not strong enough to attack. Our time will come in thirty or fifty years. To win, we shall need the element of surprise. The Western world will need to be put to sleep. So we shall begin by launching the most spectacular peace movement on record. There shall be electrifying overtures and unheard of concessions. The capitalist countries, stupid and decadent, will rejoice to cooperate to their own destruction. They will leap at another chance to be friends. As soon as their guard is down, we shall smash them with our clenched fist."

**Dmitrii Z. Manuilskii,  
Lenin School of Political Warfare,  
Moscow, 1931**

"I want to extend condolences to the families of those who died in the service of the United Nations."

**Al Gore,  
as he traveled to Marrakech, Morocco,  
for the signing of the new world trade agreement.  
Gore appeared hours after U.S. planes  
enforcing an allied 'no fly' zone over northern Iraq  
accidentally shot down two helicopters,  
killing 15 Americans and 11 foreign officials.  
The Los Angeles Times,  
June 12, 1994**

"The urge to save humanity is almost always a false front for the urge to rule."

**H. L. Mencken**

"The only hope for the world is to make sure there is not another United States: We can't let other countries have the same number of cars, the amount of industrialization, we have in the U.S. We have to stop these third world countries right where they are. And it is important to the rest of the world to make sure that they don't suffer economically by virtue of our stopping them."

**Michael Oppenheimer,  
Environmental Defense Fund**

"Human beings, as species, have no more value than slugs."

**John Davis,  
editor of Earth First Journal**

"We've got to ride the global-warming issue. Even if the theory of global warming is wrong, we will be



doing the right thing - in terms of economic policy and environmental policy."

**Timothy Wirth, former U.S. Senator (D-Colo.),  
presently with the United Nations**

"The whole aim of practical politics is to keep the populace alarmed - and hence clamorous to be led to safety - and menacing it with an endless series of hobgoblins, all of them imaginary."

**H. L. Mencken**

"If I were reincarnated, I would wish to be returned to earth as a killer virus to lower the human population levels."

**Prince Phillip  
of Great Britain,  
World Wildlife Fund**

"Isn't the only hope for the planet that the industrialized civilizations collapse? Isn't it our responsibility to bring about?"

**Maurice Strong,  
Head of the 1992 Earth Summit  
in Rio de Janeiro**

"We reject the idea of private property."

**Peter Berle,  
president of the National Audubon Society**

"The historical experience of socialist countries has sadly demonstrated that collectivism does not do away with alienation but rather increases it, adding to it a lack of basic necessities and economic inefficiency."

**Pope John Paul II**

"America will never be destroyed from the outside. If we falter and lose our freedoms, it will be because we destroyed ourselves."

**Abraham Lincoln**

**MENU: [HOME](#) » [Reconstruction](#) » [Recovery](#) » [Renewal](#) » [NWO Introduction](#)**



The following document appears to be the one that has raised the greatest wrath, of late, among those who are opposed to the NWO.

Following presentation of the document, there is the best and most well reasoned response, that has come to this editor's attention. The reader should note, however, that while the writer of the response recognizes many of the goals and intentions of the proponents of the Charter, he offers no alternatives to achieve those goals, nor any critique of the goals themselves.

# Charter 99

## **A Charter for Global Democracy** **Our call for international accountability, justice,** **sustainable development and democracy**

*In September 2000 the United Nations will hold a special Millennium Assembly and Summit on the future of the world.*

Dear Representatives to the Millennium Assembly,

This Charter is addressed to you and all the governments and peoples of the world you represent. It is a demand for global democracy.

Throughout the century now coming to an end there have been well meaning and sometimes eloquent calls for world government; calls which pointed to the unfairness, inequality and injustice of the present distributions of wealth, power and policy making - which mean that today one in five of us lives in absolute poverty; calls which emphasised the dangers to peace and even to human survival. If only we could work as one world, then we could solve the world's problems together.

If only! Sometimes with a sigh, sometimes with contempt, these calls have been dismissed as impractical.

But during the 1990s, demands for international government have taken on a new energy and precision:

The Commission on Global Governance made an unprecedented international effort to draw up a framework for global politics.

The Earth Summit in Rio, Agenda 21, The Earth Charter, the Real World coalition, Earth Action's

Call for a Safer World, Global Coalition World Democracy 2010 and many other declarations are uniting people's efforts for global democracy and sustainable development.

The Hague Agenda for Peace represents a world-wide coalition committed to replace the causes of war with a culture of peace.

The campaign against landmines successfully changed international law, although much remains to be done.

International conferences at New York, Vienna, Cairo, Copenhagen, Beijing and Istanbul have made world issues of gender equality, family and social rights.

Jubilee 2000 has co-ordinated a world-wide campaign to cancel the unpayable debts of the world's poorest countries.

The International Commission on Rights and Responsibilities made a distinguished and expert attempt to codify Human Duties and Responsibilities.

After fifty years of campaigning, a statute to create an International Criminal Court was adopted at Rome in 1998 to reinforce international criminal law.

The Human Development Report 1999 recommended an agenda for action including a more coherent and more democratic architecture for global governance in the 21st century.

In addition, a growing scholarly literature on all aspects of globalisation has begun to explore how governments can regulate and democratise international affairs.

There are now detailed, practical measures which set out an ambitious agenda for democracy in international decision-making, now increasingly known as 'global governance'.

We believe that there is a profound and important reason for this historic shift.

*It is that in many ways we now have world government.*

It is not to be found at the United Nations. Rather, the UN has been sidelined, while the real business of world government is done elsewhere. Global policies are discussed and decided behind closed doors by exclusive groups, such as the G8, OECD, the Bank of International Settlements, the World Bank, the International Monetary Fund, the World Trade Organisation and others. These agencies are reinforced by informal networks of high officials and powerful alliances such as NATO and the European Union. Together they have created what can be seen as dominant and exclusive institutions of world government. All too often they are influenced by

transnational corporations which pursue their own world strategies.

These agencies of actual world government must be made accountable. If there are to be global policies, let them be answerable to the peoples of the world.

We call on you, therefore, to start the new century by initiating the process of democratic global governance following three fundamental principles:

openness and accountability

environmental sustainability

justice.

The first aim is to make the already existing processes of world administration and governance accountable. We want to know what decisions are being taken and why. We want the decision takers to know they are answerable to the public in every country which feels the breath of international bodies.

Then we want all decisions to be compatible with public criteria of environmental sustainability.

Finally, if most ambitiously, we want them to be compatible with the principles of human rights and justice, including social and economic justice.

What we want from the Millennium Assembly and Member States is decisive action to put these principles into practice. We do not think they will be easy to achieve. But we believe the difficulties can and must be overcome. We want you to negotiate new global structures which give the world's people an effective role in solving this planet's problems. In our era everyone is linked through our shared environment, trade and communications. We live together as neighbours, and as neighbours we must respect the rights of all persons to address common problems. A joint effort of learning and negotiation, of trial and error, will be needed.

Many vital issues can best be tackled effectively at a global level, such as the environment, biodiversity and climate change; international security and disarmament; international trade, finance and labour rights; epidemics; communications; and international crime.

The first question is where should we start? We believe that the answer has to be at the United Nations. The inadequacy of the UN is well known. All around we see the principles of the UN subverted, sidelined and suppressed. Since the UN Charter was signed, more than 30 million people have been killed in war, most of them unarmed civilians; millions more people have been slaughtered in genocide and ethnic conflict; over 100 million people have fled their homes due to conflict or persecution, with over 20 million remaining as refugees today; permanent members of the Security Council have armed belligerents and engaged in war; governments have invested more in preparing for war than in

strengthening peace; human rights have been violated with little redress.

Nevertheless the United Nations as an institution can hardly be blamed for the appalling behaviour of its member states. Without the UN, wars would have been even more frequent; they would have gone on longer; there would have been a greater number of victims, and many more refugees living without hope. The UN is the only arena in which all countries sit side by side. For all its weakness, it retains an unmatched legitimacy in world affairs.

The UN's founding Charter mandates you to achieve international co-operation in solving international problems of an economic, social, cultural or humanitarian character and to be a centre for harmonising the actions of nations (Article 1).

We therefore call on you to create effective mechanisms to hold every agency of actual world government to account. These include international economic alliances, military alliances, and agencies for environmental, financial, social, sporting, or other activity: All should have to answer regularly for what they have done and intend to do, for their impact on the world community and for their adherence to the UN Charter and international law. We want action to start the process now.

The creation of democratic global governance may be complicated. But [it will be achieved, because] the need for it is simple and urgent. Global problems will only get worse if international decision-making is left in the hands of the present undemocratic, exclusive institutions. Therefore we will press for action and to call on public support around the world.

World-wide campaigns have led to the end of apartheid in South Africa, to the Statute for an International Criminal Court, to the ban on landmines and some debt-reduction for the world's poorest countries. The time has come to make democratic reform of international affairs our priority, both as an end in itself and as a means of solving many serious social and economic problems.

Many reforms are needed. The following 12 points are a summary of the many demands and proposals being made across the world for better international governance.

## 12 areas for urgent action

### **Strengthen democratic accountability and participation in international decision-making:**

1. Give the UN General Assembly powers to scrutinise the work of UN agencies and other agencies of global governance; create an annual Forum of Civil Society; open international institutions to increased participation by civil society and elected representatives from member countries; bring the WTO into the UN system and strengthen co-operation between all international groupings under the UN system.

2. Create within the UN system an accountable, equitable and effective mechanism to monitor, supervise and regulate transnational corporations and financial institutions; and require transnational companies to

adhere to an international code of conduct covering agreed principles concerning human rights, the environment and core labour standards.

3. Give UN institutions an additional and independent source of revenue such as taxation of foreign exchange transactions, aircraft and shipping fuels, arms sales and licensing use of the global commons.

**Maintain international peace and security:**

4. Reform the UN Security Council to open all decision-making to public scrutiny; phase out the single country veto and permanent membership; establish equitable representation from each region of the world; set up a high level early warning system; and provide effective authority to mediate and intervene in disputes at an early stage, within national boundaries where necessary.

5. Establish a permanent, directly recruited UN Rapid Reaction Force to hold the peace in a crisis, police gross violations of human rights and support multilateral defence against aggression and genocide;

6. Make the UN register of arms mandatory; ratify and implement the Landmine Ban Treaty; outlaw all weapons of mass destruction; initiate programmes to control the arms trade, convert the arms industry to peaceful production and cut military spending world wide; strengthen accountability to the UN of all international military action; and reduce the size of national armies as part of a multilateral global security system.

**Uphold fundamental human rights:**

7. Strengthen world citizenship based on compliance with and respect for the Universal Declaration of Human Rights and all international instruments on Human Rights, including the six core treaties on economic, social and cultural rights; civil and political rights; racial discrimination; discrimination against women, children's rights, torture, and the conventions on genocide, refugees and labour standards.

**Strengthen justice under international law:**

8. Ratify the Statute of the International Criminal Court; accept compulsory jurisdiction of the International Court of Justice, the International Criminal Court and the UN Human Rights Committee; increase the Courts' powers of enforcement; open the ICJ to individual petition and protect the judicial independence of the ICC.

**Promote social progress and better standards of life:**

9. Establish a strong UN institution for Economic and Environmental security to promote international prosperity, protect the global commons and secure sustainable development.

10. Establish an International Environmental Court to enforce international treaties on the environment and protect the global commons.

11. Declare climate change to be an essential global security interest and establish a high-level

international urgent action team to assist the UN Conference of the Parties on Climate Change to set a scientifically based global ceiling on greenhouse gas emissions, to allocate national shares of permissible emissions based on convergence to equal per capita rights, and to work with governments, companies, international agencies and NGOs to cut emissions of greenhouse gases to a sustainable level.

12. Make poverty reduction a global priority: secure universal access to safe drinking water, health care, housing, education, family planning, gender equality, sustainable development and economic opportunities, and strengthen the capacity of development agencies to eliminate malnutrition, preventable diseases and absolute poverty through conservation and equitable sharing of global resources. Cancel the unpayable debts of the poorest nations and institute measures to prevent severe debt burdens from ever building up again.

*[In addition to the above, after a nuclear war, it will be necessary to add:*

- a. The establishment of International Boundaries*
- b. The certification of legitimate governments within each country*
- c. This latter may eventually require the international supervision of elections*

*-Bruce]*

To support the Charter, please send your name, title or trade, address and a donation (cheques payable to Westminster UNA)

to:

Westminster UNA,  
32 Carisbrooke Road,  
London E17 7EF,  
tel: 0181 521 6977  
or email: titus@gci.org.uk

## Using the Charter

The Charter aims to build public support and political will to create a democratic and inclusive system of international decision-making by

setting out key principles and priorities for transforming global governance ;

urging national parliaments, town councils, state and regional bodies, trade unions, women's groups, political parties, churches, companies, other organisations and individuals to debate these issues and develop the ideas set out in the Charter;

encouraging people to discuss, study, publicise and lobby round the key principles;



getting individuals, organisations and representative bodies to sign the Charter

presenting the Charter to the Millennium Assembly of the UN in September 2000 and to member governments

**MENU: [HOME](#) » [Reconstruction](#) » [Recovery](#) » [Renewal](#) » [NWO Introduction](#)**

---

---

*This excellent, well written opposition to the NWO, By Henry Lamb, WorldNetDaily.com, (taken from the web, Friday, October 01, 1999,) while accurate, offers no reasonable solution (in fact offers NO SOLUTION) to the primary problem that creates the necessity of the NWO. That problem is of course the one of elimination of war in a world that has nuclear weapons and other weapons of mass destruction. The main philosophical emphasis of this critique regards the primacy of individual freedom. While individual freedom is indeed important, as regards the freedom of religion and the search for truth, there is a balance that must be realized between those essential freedoms on the one hand and espousal of a complete social anarchy which offers no protection to the environment, no justice or opportunity for the socially disadvantaged, and has a complete lack of universal concern for the needs and brotherhood of mankind as a global whole.*

## **In Opposition to Charter 99**

An Essay

by Henry Lamb

1999 WorldNetDaily.com

In less than a year, the United Nations will convene a special Millennium Assembly as a global summit on the future of the world. This event will crown a decade of preparation to launch the new millennium on a new system of global governance. The blueprint was published by the Commission on Global Governance in 1995. Now, a Charter to achieve global governance has been developed for presentation at the Millennium Assembly next September. It will be published publicly on UN day, October 24th.

It is called The Charter for Global Democracy. It has already been signed by influential leaders in 56 nations, and has the support of civil society non-government organizations around the world. The document is, in reality, a Charter for the abolition of individual freedom.

The first of 12 principles calls for the consolidation of all international agencies under the direct authority of the United Nations. The second principle calls for regulation by the UN of all transnational corporations and financial institutions, requiring an "international code of conduct" concerning the environment and labor standards.

Principle number 3 demands an independent source of revenue for the UN, such as the "Tobin tax" and taxes on aircraft and shipping fuels, and licensing the use of the global commons. The "global commons" is defined to be "outer space, the atmosphere, non-territorial seas, and the related environment that supports human life."

Number 4 would eliminate the veto power and permanent member status on the Security Council. Number 5 would authorize a standing UN army. Number 6 would require UN registration of all arms and

the reduction of all national armies "as part of a multilateral global security system" under the authority of the United Nations.

Principle number 7 would require individual and national compliance with all UN "Human Rights" treaties and declarations. Number 8 would activate the International Criminal Court, make the International Court of Justice compulsory for all nations, and give individuals the right to petition the courts to remedy social injustice.

Principle 9 calls for a new institution to establish economic and environmental security by insuring "sustainable development." Number 10 calls for the establishment of an International Environmental Court.

Number 11 calls for a declaration that climate change is an essential global security interest that requires the creation of a "high-level action team" to allocate carbon emission based on equal per-capita rights. Principle number 12 calls for the cancellation of all debt owed by the poorest nations, global poverty reductions, and for "equitable sharing of global resources," as allocated by the United Nations.

As preposterous as these ideas may sound to freedom-loving Americans, most of the world considers them to be an improvement over their current circumstance. The fuel that fires the global governance movement, however, is not the desires of oppressed people, it is the money supplied by the well-to-do elite who feel the need to "do something" to help the less fortunate people of the world. The strategy for advancing the movement is supplied by those who expect to control the machinery of global governance.

It is no coincidence that financial contributions in support of the Charter for Global Democracy are to be made to the London office of United Nations Association.

Dozens of documents, all promoting some form of world government, have been circulating for most of this decade. All contain these same principles. The Millennium Assembly will receive these documents and meld them into the legal instruments required to modify the existing UN Charter. It will take a year or two for the legal documents to be prepared and adopted, and another year or two for ratification. The world is truly standing at the threshold of world government.

Woodrow Wilson brought the world to the same threshold nearly 80 years ago; the United States decided not to enter, and the League of Nations collapsed. Once again, it is up to the United States to determine the future of the world. If the United States embraces this Charter for Global Democracy, the world will be subjected to global dominance by the United Nations. If the United States opts out, the world may be spared centuries of inevitable oppression.

There is no issue of greater importance in next year's election than where each candidate stands on global governance and national sovereignty. So far, this issue has not emerged in any national campaign.

The United States must prevent this catastrophe-in-the-making. Global governance, as envisioned by the

Commission on Global Governance and the Charter for Global Democracy cannot succeed without the support of the United States. The United States must walk away. For all practical purposes, the next President, and the next Senate will make that decision.

By walking away from the UN's vision of global governance, we are not turning our backs to the rest of the world. Our next President and Congress should say no to global governance, and offer a better idea.

There is no better idea, nor higher aspiration, than individual freedom. America pioneered that technology 200 years ago, and it is still the most valuable asset we possess.

Freedom or democracy?

Freedom and democracy are not synonymous. In most of the world, the term democracy means the right of citizens to participate in the process of government. It is a right granted by the government, and controlled by the government, and if exercised improperly, it is denied by the government. Freedom, on the other hand, is the God-given right to govern one's self.

Freedom is the power to enter into voluntary agreements with other people who have precisely the same freedom, to achieve objectives of mutual benefit, as determined only by the parties to the agreement. Freedom is the power to make the rules that govern those agreements. Freedom is the power to create and control a system of general governance designed to serve its creators. Freedom is the power to cheat, lie, and steal -- and learn the consequences of those actions. Freedom is the power to experiment, to invent, to help others -- and learn the consequences of those actions. Freedom is the ultimate objective of human kind.

A system of global democracy, administered by the United Nations, would turn the world away from its primary quest -- individual freedom. Poverty cannot be eliminated by taking wealth from some and giving it to others. The inevitable consequence of such action is the expansion of poverty, by taking not only wealth, but the incentive to produce wealth as well.

The environment -- the global commons -- cannot be protected for long by regulated preservation. It must be protected by those who use it to meet their daily needs. Government ownership or control of the environment is the most certain way to ensure its degradation through stagnation. People, like virtually every other species on earth, should be free to use that portion of the environment they can control in whatever way they choose. If they abuse that environment, the environment will not sustain them. If they cultivate and care for that environment, it will sustain them.

This is a fundamental law of nature that cannot be repealed by any institution of government. In the long term, government attempts to manage the environment become, in retrospect, examples of gross mismanagement. Individuals, managing that portion of the planet they are able to control, provide the surest way to achieve a healthy, vibrant environment for all.

Freedom is the power to gain control over a portion of the environment -- land ownership. Freedom is the power to defend that land, by whatever means necessary, from those who have not learned the consequences of cheating, lying, or stealing. Freedom is the power to use the resources the land provides to create products and services others are willing to buy. Freedom is the power to buy products and services others have produced.

These are the ideas for which the world hungers. These are the better ideas America should offer the world. Because these ideas have produced prosperity beyond the wildest dreams of the rest of the world, we should happily share our freedom technology with the world.

Democracy can be imposed upon people by government; freedom cannot be imposed. Freedom must be learned through experience. Sometimes the experience is bloody, as it was in America, and always, it is painful, as is the current learning experience in Russia. It is the price we must pay for the benefits freedom bestows.

America should stop pouring its prosperity down the United Nations' drain. Instead, it should help directly, any nation that wants its people to be free. If given the choice, the people of every nation would choose individual freedom over a system of UN handouts. The governments of those nations, however, are not likely to embrace the possibility of relinquishing power. Governments of every stripe around the world, are the obstacles preventing individual freedom.

The people of the United States should first ensure their continued freedom by limiting the power of the government through the people elected to represent us. We should insist that America never relinquish one more ounce of its national sovereignty, and begin to reclaim our national sovereignty by disengaging from the labyrinth of UN treaties we have embraced in recent years. We should insist that our national defense is second to none, and never subject it to the command of any authority but our own. We should never relinquish our right for individuals to own and use land, nor should we allow our government to use our tax dollars to buy the land which is our posterity's birthright. We should direct our government to reestablish as its highest priority, the protection of individual freedom for every American.

These ideas are repugnant to the promoters of global democracy under the authority of the United Nations. These ideas are labeled as "jingoism." These ideas are described as "extreme nationalism bordering on hatred of non-nationals." The opposite is true. These ideas are offered to the rest of the world because America demonstrates that these ideas can bring the same kind of benefits to all nations that embrace them.

This is the message the United States should deliver to the United Nations. The next President and the next Senate will deliver whatever message we, the voters, send. If we, the United States, embrace the Charter for Global Democracy and the world government it establishes, America will be reduced to the lowest common denominator forced equity demands. The power of individual freedom will be caged in history books for generations. It could easily take centuries of gradual decline and rising oppression before a new generation of founders cast off the scourge of the UN-King and rediscover the truths upon

which America's founders built our great nation. We, the people, literally hold the future of the world in our hands. The people we send to Washington as the result of our next election will either embrace world government, or reject it. It is up to us.

-----

Henry Lamb is the executive vice president of the Environmental Conservation Organization and chairman of Sovereignty International.

**MENU: [HOME](#) » [Reconstruction](#) » [Recovery](#) » [Renewal](#) » [NWO Introduction](#)**

---

---

## A *[SECULAR]* CHRONOLOGICAL HISTORY of the NEW WORLD ORDER

[This is a re-formation (with colored boxes) of an article that I have found on the web. While the form is different the words are the same as I found them to have been edited by John Loeffler. Neither John Loeffler nor D.L. Cuddy are known to me other than through this article. My own comments are entered in these brackets.

- Bruce Beach]

[While the original author discounts that it is a hidden conspiracy arising from the Protocols of the Elders of Zion, nevertheless it is his theory that there is an Open Conspiracy, whatever that oxymoron means.

In his view it is an evil plot by the humanists and liberals, although he still quotes from Nixon and Bush. Either the original writer, or an interim editor, has an obvious bias against New Age Religion and such. All of this recognized - it still remains an interesting historical summary, and I highly recommend that you read it.

The quotes here are mostly from westerners and capitalist organizations, but there are other organizations in other parts of the world and under other economic systems that have similar agendas.

I agree with the original author that the theory that there is some one organization completely in control, such as the Illuminati (a completely misunderstood group) or the CFR, Trilateral Commission, Bilderbergers, or anyone of a dozen other named favorites, is completely fallacious.

There IS a PLAN, and some organizations do have considerably more influence than others in implementing that PLAN, but that is another matter entirely , and one that is not at all covered here. - Bruce Beach]

### A CHRONOLOGICAL HISTORY OF THE NEW WORLD ORDER by D.L. Cuddy, Ph.D. Arranged and Edited by John Loeffler

In the mainline media, those who adhere to the position that there is some kind of "conspiracy" pushing us towards a world government are virulently ridiculed. The standard attack maintains that the so-called "New World Order" is the product of turn-of-the-century, right-wing, bigoted, anti-semitic racists acting in the tradition of the long-debunked Protocols of the Learned Elders of Zion, now promulgated by some Militias and other right-wing hate groups.

The historical record does not support that position to any large degree but it has become the mantra of the socialist left and their cronies, the media.

The term "New World Order" has been used thousands of times in this century by

proponents in high places of federalized world government. Some of those involved in this collaboration to achieve world order have been Jewish. The preponderance are not, so it most definitely is not a Jewish agenda.

For years, leaders in education, industry, the media, banking, etc., have promoted those with the same Weltanschauung (world view) as theirs. Of course, someone might say that just because individuals promote their friends doesn't constitute a conspiracy. That's true in the usual sense. However, it does represent an "open conspiracy," as described by noted Fabian Socialist H.G. Wells in **The Open Conspiracy: Blue Prints for a World Revolution** (1920).

In 1913, prior to the passage of the Federal Reserve Act President Wilson's **The New Freedom** was published, in which he revealed:

"Since I entered politics, I have chiefly had men's views confided to me privately. Some of the biggest men in the U. S., in the field of commerce and manufacturing, are afraid of somebody, are afraid of something. They know that there is a power somewhere so organized, so subtle, so watchful, so interlocked, so complete, so pervasive, that they had better not speak above their breath when they speak in condemnation of it."

On November 21, 1933, President Franklin Roosevelt wrote a letter to Col. Edward Mandell House, President Woodrow Wilson's close advisor:

"The real truth of the matter is, as you and I know, that a financial element in the larger centers has owned the Government every since the days of Andrew Jackson..."

That there is such a thing as a cabal of power brokers who control government behind the scenes has been detailed several times in this century by credible sources. Professor Carroll Quigley was Bill Clinton's mentor at Georgetown University. President Clinton has publicly paid homage to the influence Professor Quigley had on his life. In Quigley's magnum opus *Tragedy and Hope* (1966), he states:



"There does exist and has existed for a generation, an international...network which operates, to some extent, in the way the radical right believes the Communists act. In fact, this network, which we may identify as the Round Table Groups, has no aversion to cooperating with the Communists, or any other groups and frequently does so. I know of the operations of this network because I have studied it for twenty years and was permitted for two years, in the early 1960s, to examine its papers and secret records. I have no aversion to it or to most of its aims and have, for much of my life, been close to it and to many of its instruments. I have objected, both in the past and recently, to a few of its policies...but in general my chief difference of opinion is that it wishes to remain unknown, and I believe its role in history is significant enough to be known."

Even talk show host Rush Limbaugh, an outspoken critic of anyone claiming a push for global government, said on his February 7, 1995 program:

"You see, if you amount to anything in Washington these days, it is because you have been plucked or handpicked from an Ivy League school - - Harvard, Yale, Kennedy School of Government -- you've shown an aptitude to be a good Ivy League type, and so you're plucked so-to-speak, and you are assigned success. You are assigned a certain role in government somewhere, and then your success is monitored and tracked, and you go where the pluckers and the handpickers can put you."

On May 4, 1993, Council on Foreign Relations (CFR) president Leslie Gelb said on The Charlie Rose Show that:

"...you [Charlie Rose] had me on [before] to talk about the New World Order! I talk about it all the time. It's one world now. The Council [CFR] can find, nurture, and begin to put people in the kinds of jobs this country needs. And that's going to be one of the major enterprises of the Council under me."

Previous CFR chairman, John J. McCloy (1953-70), actually said they have been doing this since the 1940s (and before).

The thrust towards global government can be well-documented but at the end of the twentieth century it does not look like a traditional conspiracy in the usual sense of a secret cabal of evil men meeting clandestinely behind closed doors. Rather, it is a "networking" of like-minded individuals in high places to achieve a common goal, as described in Marilyn Ferguson's 1980 insider classic, **The Aquarian Conspiracy**.

Perhaps the best way to relate this would be a brief history of the New World Order, not in our words but in the words of those who have been striving to make it real.

1912 -- Colonel Edward M. House, a close advisor of President Woodrow Wilson, publishes **Phillip Dru: Administrator** in which he promotes

"socialism as dreamed of by Karl Marx."

1913 -- The Federal Reserve (neither federal nor a reserve) is created. It was planned at a secret meeting in 1910 on Jekyll Island, Georgia by a group of bankers and politicians, including Col. House. This transferred the power to create money from the American government to a private group of bankers. It is probably the largest generator of debt in the world.

May 30, 1919 -- Prominent British and American personalities establish the Royal Institute of International Affairs in England and the Institute of International Affairs in the U.S. at a meeting arranged by Col. House attended by various Fabian socialists, including noted economist John Maynard Keynes. Two years later, Col. House reorganizes the Institute of International Affairs into the Council on Foreign Relations (CFR).

December 15, 1922 -- The CFR endorses World Government in its magazine **Foreign Affairs**. Author Philip Kerr, states:

"Obviously there is going to be no peace or prosperity for mankind as long as [the earth] remains divided into 50 or 60 independent states until some kind of international system is created...The real problem today is that of the world government."

1928 -- **The Open Conspiracy: Blue Prints for a World Revolution** by H.G. Wells is published. A former Fabian Socialist, Wells writes:

"The political world of the into a Open Conspiracy must weaken, efface, incorporate and supersede existing governments...The Open Conspiracy is the natural inheritor of socialist and communist enthusiasms; it may be in control of Moscow before it is in control of New York...The character of the Open Conspiracy will now be plainly displayed...It will be a world religion."

1931 -- Students at the Lenin School of Political Warfare in Moscow are taught:

"One day we shall start to spread the most theatrical peace movement the world has ever seen. The capitalist countries, stupid and decadent...will fall into the trap offered by the possibility of making new friends. Our day will come in 30 years or so...The bourgeoisie must be lulled into a false sense of security.

1932 -- New books are published urging World Order:

**Toward Soviet America** by William Z. Foster. Head of the Communist Party USA, Foster indicates that a National Department of Education would be one of the means used to develop a new socialist society in the U.S.

**The New World Order** by F.S. Marvin, describing the League of Nations as the first attempt at a New World Order. Marvin says,

"nationality must rank below the claims of mankind as a whole."

**Dare the School Build a New Social Order?** is published. Educator author George Counts asserts that:

"...the teachers should deliberately reach for power and then make the most of their conquest"

in order to "influence the social attitudes, ideals and behavior of the coming generation...The growth of science and technology has carried us into a new age where ignorance must be replaced by knowledge, competition by cooperation, trust in Providence by careful planning and private capitalism by some form of social economy."

1933 -- The first **Humanist Manifesto** is published. Co-author John Dewey, the noted philosopher and educator, calls for a synthesizing of all religions and

"a socialized and cooperative economic order."

Co-signer C.F. Potter said in 1930:

"Education is thus a most powerful ally of humanism, and every American public school is a school of humanism. What can the theistic Sunday schools, meeting for an hour once a week, teaching only a fraction of the children, do to stem the tide of a five-day program of humanistic teaching?"

1933 -- **The Shape of Things to Come** by H.G. Wells is published. Wells predicts a second world war around 1940, originating from a German-Polish dispute. After 1945 there would be an increasing lack of public safety in "criminally infected" areas. The plan for the "Modern World-State" would succeed on its third attempt (about 1980), and come out of something that occurred in Basra, Iraq.

The book also states,

"Although world government had been plainly coming for some years, although it had been endlessly feared and murmured against, it found no opposition prepared anywhere."

1934 -- **The Externalization of the Hierarchy** by Alice A. Bailey is published. Bailey is an occultist, whose works are channeled from a spirit guide, the Tibetan Master (demon spirit) Djwahl Kuhl. Bailey uses the phrase

"points of light"

in connection with a

"New Group of World Servers"

and claims that 1934 marks the beginning of

"the organizing of the men and women...group work of a new order...(with progress defined by service...the world of the Brotherhood...the Forces of Light...(and) out of the spoliation of all existing culture and civilization, the new world order must be built."

The book is published by the Lucis Trust, incorporated originally in New York as the Lucifer Publishing Company. Lucis Trust is a United Nations NGO and has been a major player at the recent U.N. summits. Later Assistant Secretary General of the U.N. Robert Mueller would credit the creation of his World Core Curriculum for education to the underlying teachings of Djwahl Kuhl via Alice Bailey's writings on the subject.

1932 -- **Plan for Peace** by American Birth Control League founder Margaret Sanger (1921) is published. She calls for coercive sterilization, mandatory segregation, and rehabilitative concentration camps for all

"dysgenic stocks"

including Blacks, Hispanics, American Indians and Catholics.

October 28, 1939 -- In an address by John Foster Dulles, later U.S. Secretary of State, he proposes that America lead the transition to a new order of less independent, semi-sovereign states bound together by a league or federal union.

1939 -- **New World Order** by H. G. Wells proposes a collectivist

" one-world state"

or

"new world order"

comprised of

"socialist democracies."

He advocates

"universal conscription for service"

and declares that

"nationalist individualism...is the world's disease."

He continues:

"The manifest necessity for some collective world control to eliminate warfare and the less generally admitted necessity for a collective control of the economic and biological life of mankind, are aspects of one and the same process."

He proposes that this be accomplished through

"universal law" and propaganda (or education)."

1940 -- **The New World Order** is published by the Carnegie Endowment for International Peace and contains a select list of references on regional and world federation, together with some special plans for world order after the war.

December 12, 1940 -- In **The Congressional Record** an article entitled **A New World Orde** by John G. Alexander calls for a world federation.

1942 -- The leftist Institute of Pacific Relations publishes **Post War Worlds** by P.E. Corbett:

"World government is the ultimate aim...It must be recognized that the law of nations takes precedence over national law...The process will have to be assisted by the deletion of the nationalistic material employed in educational textbooks and its replacement by material explaining the benefits of wiser association."

June 28, 1945 -- President Truman endorses world government in a speech:

"It will be just as easy for nations to get along in a republic of the world as it is for us to get along in a republic of the United States."

October 24, 1945 -- **The United Nations Charter** becomes effective.

Also on October 24, Senator Glen Taylor (D-Idaho) introduces **Senate Resolution 183** calling upon the U.S. Senate to go on record as favoring creation of a world republic including an international police force.

1946 -- Alger Hiss is elected President of the Carnegie Endowment for International Peace. Hiss holds this office until 1949. Early in 1950, he is convicted of perjury and sentenced to prison after a sensational trial and Congressional hearing in which Whittaker Chambers, a former senior editor of Time, testifies that Hiss was a member of his Communist Party cell.

1946 -- **The Teacher and World Government** by former editor of the **NEA Journal** (National Education Association) Joy Elmer Morgan is published. He says:

"In the struggle to establish an adequate world government, the teacher...can do much to prepare the hearts and minds of children for global understanding and cooperation...At the very heart of all the agencies which will assure the coming of world government must stand the school, the teacher, and the organized profession."

1947 -- The American Education Fellowship, formerly the Progressive Education Association, organized by John Dewey, calls for the:

"...establishment of a genuine world order, an order in which national sovereignty is subordinate to world authority..."

October, 1947 -- NEA Associate Secretary William Carr writes in the **NEA Journal** that teachers should:

"...teach about the various proposals that have been made for the strengthening of the United Nations and the establishment of a world citizenship and world government."

1948 -- **Walden II** by behavioral psychologist B.F. Skinner proposes

"a perfect society or new and more perfect order"

in which children are reared by the State, rather than by their parents and are trained from birth to demonstrate only desirable behavior and characteristics. Skinner's ideas would be widely implemented by educators in the 1960s, 70s, and 80s as **Values Clarification and Outcome Based Education**.

July, 1948 -- Britain's Sir Harold Butler, in the CFR's **Foreign Affairs**, sees "a New World Order" taking shape:

"How far can the life of nations, which for centuries have thought of themselves as distinct and unique, be merged with the life of other nations? How far are they prepared to sacrifice a part of their sovereignty without which there can be no effective economic or political union?...Out of the prevailing confusion a new world is taking shape... which may point the way toward the new order... That will be the beginning of a real United Nations, no longer crippled by a split personality, but held together by a common faith."

1948 -- UNESCO president and Fabian Socialist, Sir Julian Huxley, calls for a radical eugenic policy in **UNESCO: Its Purpose and Its Philosophy**. He states:

"Thus, even though it is quite true that any radical eugenic policy of controlled human breeding will be for many years politically and psychologically impossible, it will be important for UNESCO to see that the eugenic problem is examined with the greatest care and that the public mind is informed of the issues at stake that much that is now unthinkable may at least become thinkable."

1948 -- The preliminary draft of a **World Constitution** is published by U.S. educators advocating regional federation on the way toward world federation or government with England incorporated into a European federation. The Constitution provides for a

"World Council"

along with a



"Chamber of Guardians"

to enforce world law. Also included is a

"Preamble"

calling upon nations to surrender their arms to the world government, and includes the right of this

"Federal Republic of the World"

to seize private property for federal use.

February 9, 1950 -- The Senate Foreign Relations Subcommittee introduces **Senate Concurrent Resolution 66** which begins:

"Whereas, in order to achieve universal peace and justice, the present Charter of the United Nations should be changed to provide a true world government constitution."

The resolution was first introduced in the Senate on September 13, 1949 by Senator Glen Taylor (D-Idaho). Senator Alexander Wiley (R-Wisconsin) called it "a consummation devoutly to be wished for" and said, "I understand your proposition is either change the United Nations, or change or create, by a separate convention, a world order." Senator Taylor later stated:

"We would have to sacrifice considerable sovereignty to the world organization to enable them to levy taxes in their own right to support themselves."

April 12, 1952 -- John Foster Dulles, later to become Secretary of State, says in a speech to the American Bar Association in Louisville, Kentucky, that

"treaty laws can override the **Constitution.**"

He says treaties can take power away from Congress and give them to the President. They can take powers from the States and give them to the Federal Government or to some international body and they can cut across the rights given to the people by their constitutional **Bill of Rights**.

A Senate amendment, proposed by GOP Senator John Bricker, would have provided that no treaty could supersede the **Constitution**, but it fails to pass by one vote.

1954 -- Prince Bernhard of the Netherlands establishes the Bilderbergers, international politicians and bankers who meet secretly on an annual basis.

1958 -- **World Peace through World Law** is published, where authors Grenville Clark and Louis Sohn advocate using the U.N. as a governing body for the world, world disarmament, a world police force and legislature.

1959 -- The Council on Foreign Relations calls for a **New International Order**. **Study Number 7**, issued on November 25, advocated:

"...new international order (which) must be responsive to world aspirations for peace, for social and economic change...an international order...including states labeling themselves as 'socialist' (communist)."

1959 -- The World Constitution and Parliament Association is founded which later develops a **Diagram of World Government** under the **Constitution for the Federation of Earth**.

1959 -- **The Mid-Century Challenge to U.S. Foreign Policy** is published, sponsored by the Rockefeller Brothers' Fund. It explains that the U.S.:

"...cannot escape, and indeed should welcome...the task which history has imposed on us. This is the task of helping to shape a new world order in all its dimensions -- spiritual, economic, political, social."

September 9, 1960 -- President Eisenhower signs **Senate Joint Resolution 170**, promoting the concept of a federal Atlantic Union. Pollster and Atlantic Union Committee treasurer, Elmo Roper, later delivers an address titled, **The Goal Is Government of All the World**, in which he states:

"For it becomes clear that the first step toward World Government cannot be completed until we have advanced on the four fronts: the economic, the military, the political and the social."

1961 -- The U.S. State Department issues a plan to disarm all nations and arm the United Nations. **State Department Document Number 7277** is entitled **Freedom From War: The U.S. Program for General and Complete Disarmament in a Peaceful World**. It details a three-stage plan to disarm all nations and arm the U.N. with the final stage in which

"no state would have the military power to challenge the progressively strengthened U.N. Peace Force."

1962 -- New Calls for World Federalism. In a study titled, **A World Effectively Controlled by the United Nations**, CFR member Lincoln Bloomfield states:

"...if the communist dynamic was greatly abated, the West might lose whatever incentive it has for world government."

**The Future of Federalism** by author Nelson Rockefeller is published. The one-time Governor of New York, claims that current events compellingly demand a "new world order," as the old order is crumbling, and there is

"a new and free order struggling to be born."

Rockefeller says there is:

"a fever of nationalism...(but) the nation-state is becoming less and less competent to perform its international political tasks....These are some of the reasons pressing us to lead vigorously toward the true building of a new world order...(with) voluntary service...and our dedicated faith in the brotherhood of all mankind....Sooner perhaps than we may realize...there will evolve the bases for a federal structure of the free world."

1963 -- J. William Fulbright, Chairman of the Senate Foreign Relations Committee speaks at a symposium sponsored by the Fund for the Republic, a left-wing project of the Ford Foundation:

"The case for government by elites is irrefutable...government by the people is possible but highly improbable."

1964 -- **Taxonomy of Educational Objectives, Handbook II** is published. Author Benjamin Bloom states:

"...a large part of what we call 'good teaching' is the teacher's ability to attain affective objectives through challenging the students' fixed beliefs."

His **Outcome-Based Education (OBE)** method of teaching would first be tried as Mastery Learning in Chicago schools. After five years, Chicago students' test scores had plummeted causing outrage among parents. OBE would leave a trail of wreckage wherever it would be tried and under whatever name it would be used. At the same time, it would become crucial to globalists for overhauling the education system to promote attitude changes among school students.

1964 -- **Visions of Order** by Richard Weaver is published. He describes:

"progressive educators as a 'revolutionary cabal' engaged in 'a systematic attempt to undermine society's traditions and beliefs.'"

1967 -- Richard Nixon calls for New World Order. In Asia after Vietnam, in the October issue of **Foreign Affairs**, Nixon writes of nations' dispositions to evolve regional approaches to development needs and to the evolution of a

"new world order."

1968 -- Joy Elmer Morgan, former editor of the **NEA Journal** publishes **The American Citizens Handbook** in which he says:

"the coming of the United Nations and the urgent necessity that it evolve into a more comprehensive form of world government places upon the citizens of the United States an increased obligation to make the most of their citizenship which now widens into active world citizenship."

July 26, 1968 -- Nelson Rockefeller pledges support of the New World Order. In an **Associated Press** report, Rockefeller pledges that,

"as President, he would work toward international creation of a new world order."

1970 -- Education and the mass media promote world order. In **Thinking About A New World Order** for the Decade 1990, author Ian Baldwin, Jr. asserts that:

"...the World Law Fund has begun a worldwide research and educational program that will introduce a new, emerging discipline -- world order -- into educational curricula throughout the world...and to concentrate some of its energies on bringing basic world order concepts into the mass media again on a worldwide level."

1972 -- President Nixon visits China. In his toast to Chinese Premier Chou En-lai, former CFR member and now President, Richard Nixon, expresses

"the hope that each of us has to build a new world order."

May 18, 1972 -- In speaking of the coming of world government, Roy M. Ash, director of the Office of Management and Budget, declares that:

"within two decades the institutional framework for a world economic community will be in place...(and) aspects of individual sovereignty will be given over to a supernational authority."

1973 -- The Trilateral Commission is established. Banker David Rockefeller organizes this new private body and chooses Zbigniew Brzezinski, later National Security Advisor to President Carter, as the Commission's first director and invites Jimmy Carter to become a founding member.

1973 -- **Humanist Manifesto II** is published:

"The next century can be and should be the humanistic century...we stand at the dawn of a new age...a secular society on a planetary scale....As non-theists we begin with humans not God, nature not deity...we deplore the division of humankind on nationalistic grounds....Thus we look to the development of a system of world law and a world order based upon transnational federal government....The true revolution is occurring."

April, 1974 -- Former U. S. Deputy Assistant Secretary of State, Trilateralist and CFR member Richard Gardner's article **The Hard Road to World Order** is published in the CFR's Foreign Affairs where he states that:

"the 'house of world order' will have to be built from the bottom up rather than from the top down...but an end run around national sovereignty, eroding it piece by piece, will accomplish much more than the old-fashioned frontal assault."

1974 -- The World Conference of Religion for Peace, held in Louvain, Belgium is held. Douglas Roche presents a report entitled **We Can Achieve a New World Order**.

1974 -- The U.N. calls for wealth redistribution: In a report entitled **New International Economic Order**, the U.N. General Assembly outlines a plan to redistribute the wealth from the rich to the poor nations.

1975 -- A study titled, **A New World Order**, is published by the Center of International Studies, Woodrow Wilson School of Public and International Studies, Princeton University.

1975 -- In Congress, 32 Senators and 92 Representatives sign **A Declaration of Interdependence**, written by historian Henry Steele Commager. The **Declaration** states that:

"we must join with others to bring forth a new world order...Narrow notions of national sovereignty must not be permitted to curtail that obligation."

Congresswoman Marjorie Holt refuses to sign the **Declaration** saying:

"It calls for the surrender of our national sovereignty to international organizations. It declares that our economy should be regulated by international authorities. It proposes that we enter a 'new world order' that would redistribute the wealth created by the American people."

1975 -- Retired Navy Admiral Chester Ward, former Judge Advocate General of the U.S. Navy and former CFR member, writes in a critique that the goal of the CFR is the

"submergence of U. S. sovereignty and national independence into an all powerful one-world government..."

1975 -- **Kissinger on the Couch** is published. Authors Phyllis Schlafly and former CFR member Chester Ward state:

"Once the ruling members of the CFR have decided that the U.S. government should espouse a particular policy, the very substantial research facilities of the CFR are put to work to develop arguments, intellectual and emotional, to support the new policy and to confound, discredit, intellectually and politically, any opposition..."

1976 -- **RIO: Reshaping the International Order** is published by the globalist Club of Rome, calling for a new international order, including an economic redistribution of wealth.

1977 -- **The Third Try at World Order** is published. Author Harlan Cleveland of the Aspen Institute for Humanistic Studies calls for:

"changing Americans' attitudes and institutions" for "complete disarmament (except for international soldiers)" and "for individual entitlement to food, health and education."

1977 -- **Imperial Brain Trust** by Laurence Shoup and William Minter is published. The book takes a critical look at the Council on Foreign Relations with chapters such as: **Shaping a New World Order: The Council's Blueprint for Global Hegemony, 1939-1944** and **Toward the 1980's: The Council's Plans for a New World Order**.

1977 -- **The Trilateral Connection** appears in the July edition of **Atlantic Monthly**. Written by Jeremiah Novak, it says:

"For the third time in this century, a group of American schools, businessmen, and government officials is planning to fashion a New World Order..."

1977 -- Leading educator Mortimer Adler publishes **Philosopher at Large** in which he says:

"...if local civil government is necessary for local civil peace, then world civil government is necessary for world peace."

1979 -- Barry Goldwater, Republican Senator from Arizona, publishes his autobiography **With No Apologies**. He writes:

"In my view The Trilateral Commission represents a skillful, coordinated effort to seize control and consolidate the four centers of power -- political, monetary, intellectual, and ecclesiastical. All this is to be done in the interest of creating a more peaceful, more productive world community. What the Trilateralists truly intend is the creation of a worldwide economic power superior to the political governments of the nation-states involved. They believe the abundant materialism they propose to create will overwhelm existing differences. As managers and creators of the system they will rule the future."

1984 -- **The Power to Lead** is published. Author James McGregor Burns admits:

"The framers of the U.S. constitution have simply been too shrewd for us. They have outwitted us. They designed separate institutions that cannot be unified by mechanical linkages, frail bridges, tinkering. If we are to 'turn the Founders upside down' -- we must directly confront the constitutional structure they erected."

1985 -- Norman Cousins, the honorary chairman of Planetary Citizens for the World We Chose, is quoted in **Human Events**:

"World government is coming, in fact, it is inevitable. No arguments for or against it can change that fact."

Cousins was also president of the World Federalist Association, an affiliate of the World Association for World Federation (WAWF), headquartered in Amsterdam. WAWF is a leading force for world federal government and is accredited by the U.N. as a Non-Governmental Organization.

1987 -- **The Secret Constitution and the Need for Constitutional Change** is sponsored in part by the Rockefeller Foundation. Some thoughts of author Arthur S. Miller are:



"...a pervasive system of thought control exists in the United States...the citizenry is indoctrinated by employment of the mass media and the system of public education...people are told what to think about...the old order is crumbling...Nationalism should be seen as a dangerous social disease...A new vision is required to plan and manage the future, a global vision that will transcend national boundaries and eliminate the poison of nationalistic solutions...a new Constitution is necessary."

1988 -- Former Under-secretary of State and CFR member George Ball in a January 24 interview in the **New York Times** says:

"The Cold War should no longer be the kind of obsessive concern that it is. Neither side is going to attack the other deliberately...If we could internationalize by using the U.N. in conjunction with the Soviet Union, because we now no longer have to fear, in most cases, a Soviet veto, then we could begin to transform the shape of the world and might get the U.N. back to doing something useful...Sooner or later we are going to have to face restructuring our institutions so that they are not confined merely to the nation-states. Start first on a regional and ultimately you could move to a world basis."

December 7, 1988 -- In an address to the U.N., Mikhail Gorbachev calls for mutual consensus:

"World progress is only possible through a search for universal human consensus as we move forward to a new world order."

May 12, 1989 --President Bush invites the Soviets to join World Order. Speaking to the graduating class at Texas A&M University, Mr. Bush states that the United States is ready to welcome the Soviet Union

"back into the world order."

1989 -- Carl Bernstein's (Woodward and Bernstein of Watergate fame) book **Loyalties: A Son's Memoir** is published. His father and mother had been members of the Communist party. Bernstein's father tells his son about the book:

"You're going to prove (Sen. Joseph) McCarthy was right, because all he was saying is that the system was loaded with Communists. And he was right...I'm worried about the kind of book you're going to write and about cleaning up McCarthy. The problem is that everybody said he was a liar; you're saying he was right...I agree that the Party was a force in the country."

1990 -- The **World Federalist Association** faults the American press. Writing in their Summer/Fall newsletter, Deputy Director Eric Cox describes world events over the past year or two and declares:

"It's sad but true that the slow-witted American press has not grasped the significance of most of these developments. But most federalists know what is happening...And they are not frightened by the old bug-a-boo of sovereignty."

September 11, 1990 -- President Bush calls the Gulf War an opportunity for the New World Order. In an address to Congress entitled **Toward a New World Order**, Mr. Bush says:

"The crisis in the Persian Gulf offers a rare opportunity to move toward an historic period of cooperation. Out of these troubled times...a new world order can emerge in which the nations of the world, east and west, north and south, can prosper and live in harmony....Today the new world is struggling to be born."

September 25, 1990 -- In an address to the U.N., Soviet Foreign Minister Eduard Shevardnadze describes Iraq's invasion of Kuwait as

"an act of terrorism (that) has been perpetrated against the emerging New World Order."

On December 31, Gorbachev declares that the New World Order would be ushered in by the Gulf Crisis.

October 1, 1990 -- In a U.N. address, President Bush speaks of the:

"...collective strength of the world community expressed by the U.N...an historic movement towards a new world order...a new partnership of nations...a time when humankind came into its own...to bring about a revolution of the spirit and the mind and begin a journey into a...new age."

1991 -- Author Linda MacRae-Campbell publishes **How to Start a Revolution at Your School in In Context**. She promotes the use of

"change agents" as "self-acknowledged revolutionaries" and "conspirators."

1991 -- President Bush praises the New World Order in a **State of Union Message**:

"What is at stake is more than one small country, it is a big idea -- a new world order...to achieve the universal aspirations of mankind...based on shared principles and the rule of law....The illumination of a thousand points of light....The winds of change are with us now."

February 6, 1991 -- President Bush tells the Economic Club of New York:

"My vision of a new world order foresees a United Nations with a revitalized peacekeeping function."

June, 1991 -- The Council on Foreign Relations co-sponsors an assembly **Rethinking America's Security: Beyond Cold War to New World Order** which is attended by 65 prestigious members of government, labor, academia, the media, military, and the professions from nine countries. Later, several of the conference participants joined some 100 other world leaders for another closed door meeting of the Bilderberg Society in Baden Baden, Germany. The Bilderbergers also exert considerable clout in determining the foreign policies of their respective governments.

July, 1991 -- The Southeastern World Affairs Institute discusses the New World Order. In a program, topics include, **Legal Structures for a New World Order** and **The United Nations: From its Conception to a New World Order**. Participants include a former director of the U.N.'s General Legal Division, and a former Secretary General of International Planned Parenthood.

Late July, 1991 -- On a **Cable News Network** program, CFR member and former CIA director Stansfield Turner (Rhodes scholar), when asked about Iraq, responded:

"We have a much bigger objective. We've got to look at the long run here. This is an example -- the situation between the United Nations and Iraq -- where the United Nations is deliberately intruding into the sovereignty of a sovereign nation...Now this is a marvelous precedent (to be used in) all countries of the world..."

October 29, 1991 -- David Funderburk, former U. S. Ambassador to Romania, tells a North Carolina audience:

"George Bush has been surrounding himself with people who believe in one-world government. They believe that the Soviet system and the American system are converging."

The vehicle to bring this about, said Funderburk, is the United Nations,

"the majority of whose 166 member states are socialist, atheist, and anti-American."

Funderburk served as ambassador in Bucharest from 1981 to 1985, when he resigned in frustration over U.S. support of the oppressive regime of the late Rumanian dictator, Nicolae Ceausescu.

October 30, 1991: -- President Gorbachev at the Middle East Peace Talks in Madrid states:

"We are beginning to see practical support. And this is a very significant sign of the movement towards a new era, a new age...We see both in our country and elsewhere...ghosts of the old thinking...When we rid ourselves of their presence, we will be better able to move toward a new world order...relying on the relevant mechanisms of the United Nations."

Elsewhere, in Alexandria, Virginia, Elena Lenskaya, Counsellor to the Minister of Education of Russia, delivers the keynote address for a program titled, **Education for a New World Order**.

1992 -- **The Twilight of Sovereignty** by CFR member (and former Citicorp Chairman) Walter Wriston is published, in which he claims:

"A truly global economy will require ...compromises of national sovereignty...There is no escaping the system."

1992 -- The United Nations Conference on Environment and Development(UNCED) Earth Summit takes place in Rio de Janeiro this year, headed by Conference Secretary-General Maurice Strong. The main products of this summit are the **Biodiversity Treaty** and **Agenda 21**, which the U.S. hesitates to sign because of opposition at home due to the threat to sovereignty and economics. The summit says the first world's wealth must be transferred to the third world.

July 20, 1992 -- **TIME** magazine publishes **The Birth of the Global Nation** by Strobe Talbott, Rhodes Scholar, roommate of Bill Clinton at Oxford University, CFR Director, and Trilateralist, in which he writes:

"All countries are basically social arrangements...No matter how permanent or even sacred they may seem at any one time, in fact they are all artificial and temporary...Perhaps national sovereignty wasn't such a great idea after all...But it has taken the events in our own wondrous and terrible century to clinch the case for world government."

As an editor of **Time**, Talbott defended Clinton during his presidential campaign. He was appointed by President Clinton as the number two person at the State Department behind Secretary of State Warren Christopher, former Trilateralist and former CFR Vice-Chairman and Director. Talbott was confirmed by about two-thirds of the U.S. Senate despite his statement about the unimportance of national sovereignty.

September 29, 1992 -- At a town hall meeting in Los Angeles, Trilateralist and former CFR president Winston Lord delivers a speech titled **Changing Our Ways: America and the New World**, in which he remarks:

"To a certain extent, we are going to have to yield some of our sovereignty, which will be controversial at home...(Under) the North American Free Trade Agreement (NAFTA)...some Americans are going to be hurt as low-wage jobs are taken away."

Lord became an Assistant Secretary of State in the Clinton administration.

Winter, 1992-93 -- The CFR's Foreign Affairs publishes **Empowering the United Nations** by U.N. Secretary General Boutros-Boutros Ghali, who asserts:

"It is undeniable that the centuries-old doctrine of absolute and exclusive sovereignty no longer stands...Underlying the rights of the individual and the rights of peoples is a dimension of universal sovereignty that resides in all humanity...It is a sense that increasingly finds expression in the gradual expansion of international law...In this setting the significance of the United Nations should be evident and accepted."

1993 -- Strobe Talbott receives the Norman Cousins Global Governance Award for his 1992 **TIME** article, **The Birth of the Global Nation** and in appreciation for what he has done "for the cause of global governance."

President Clinton writes a letter of congratulation which states:

"Norman Cousins worked for world peace and world government...Strobe Talbott's lifetime achievements as a voice for global harmony have earned him this recognition...He will be a worthy recipient of the Norman Cousins Global Governance Award. Best wishes...for future success."

Not only does President Clinton use the specific term,

"world government,"

but he also expressly wishes the WFA "future success" in pursuing world federal government. Talbott proudly accepts the award, but says the WFA should have given it to the other nominee, Mikhail Gorbachev.

July 18, 1993 -- CFR member and Trilateralist Henry Kissinger writes in the **Los Angeles Times** concerning NAFTA:

"What Congress will have before it is not a conventional trade agreement but the architecture of a new international system...a first step toward a new world order."

August 23, 1993 -- Christopher Hitchens, Socialist friend of Bill Clinton when he was at Oxford University, says in a C-Span interview:

"...it is, of course the case that there is a ruling class in this country, and that it has allies internationally."

October 30, 1993 -- **Washington Post** ombudsman Richard Harwood does an op-ed piece about the role of the CFR's media members:

"Their membership is an acknowledgment of their ascension into the American ruling class (where) they do not merely analyze and interpret foreign policy for the United States; they help make it."

January/February, 1994 -- The CFR's Foreign Affairs prints an opening article by CFR Senior Fellow Michael Clough in which he writes that the "WiseMen" (e.g. Paul Nitze, Dean Acheson, George Kennan, and John J. McCloy) have:

"assiduously guarded it (American foreign policy) for the past 50 years...They ascended to power during World War II...This was as it should be. National security and the national interest, they argued must transcend the special interests and passions of the people who make up America...How was this small band of Atlantic-minded internationalists able to triumph?...Eastern internationalists were able to shape and staff the burgeoning foreign policy institutions...As long as the Cold War endured and nuclear Armageddon seemed only a missile away, the public was willing to tolerate such an undemocratic foreign policy making system."

1995 -- The State of the World Forum took place in the fall of this year, sponsored by the Gorbachev Foundation located at the Presidio in San Francisco. Foundation President Jim Garrison chairs the meeting of who's-whos from around the world including Margaret Thatcher, Maurice Strong, George Bush, Mikhail Gorbachev and others. Conversation centers around the oneness of mankind and the coming global government. However, the term "global governance" is now used in place of "new world order" since the latter has become a political liability, being a lightning rod for opponents of global government.

1996 -- The United Nations 420-page report **Our Global Neighborhood** is published. It outlines a plan for "global governance," calling for an international Conference on Global Governance in 1998 for the purpose of submitting to the world the necessary treaties and agreements for ratification by the year 2000.

1996 -- State of the World Forum II will take place again this fall in San Francisco. This time, many of the sessions are closed to the press.

There are hundreds more articles and speeches by those actively working to make global government a reality. We could not fit them all in here.

**[As you can see, this history is a bit dated. Ending in 1996, whereas MUCH has happened since then. Indeed, IMHO, the most significant event of all is the scheduled Millenium Conference at the UN in September 2,000.**

**- Bruce Beach]**

**MENU: [HOME](#) » [Reconstruction](#) » [Recovery](#) » [Renewal](#) » [NWO Introduction](#)**

---

---



*[The following document is a hoax (in that some really believe it) but more generously we should call it a parody. Either way it is a good representation of many emotional responses that this writer receives in regard to the NWO.*

*While this emotional portrayal of the NWO, is entirely fictional in nature, much of what it describes is accurate as regards the present state of society. However, there is in fact no conspiracy that is at fault for mankind's plight, but rather mankind's plight results from its general immorality, selfishness, and lack of spirituality.*

*This document offers no reasonable solution, and in fact does not even really mention or acknowledge the primary problem that creates the necessity of the NWO. Once again that problem is of course the one of elimination of war in a world that has nuclear weapons and other weapons of mass destruction. This essay goes too far in imputing, to the formers of the NWO, a desire for creating immorality. The NWO is not immoral, but rather simply amoral. This is indeed its great shortcoming, and why it can indeed be characterized as the government of the anti-Christ, but it is important to understand this distinction, in order to understand how to effect a remedy.*

*- Bruce Beach]*

# LETTER FROM "THE GLOBALIST NEW WORLD ORDER"

An Anonymous Fictional Essay  
taken from the web

Dearest Citizen of the World,

I believe the time has come to reveal to you some of the perplexities you have faced in recent decades. It is well for you to understand some of these things so that you might know how to behave in the New Order now taking shape in the earth. We want you to be able to become fully involved and integrated into our new society.

After all, this is for your best interest if you will do this. First of all, it is well that you understand some of our purposes so that you may more fully cooperate. I cannot tell you the hard times you will face if you resist us. We have ways of dealing with resisters. I am only telling you this now, since it is much too late to turn things around. The days of putting a stop to us have long since past. We have full control of the earth and its finance, along with the major media propaganda, and there is simply no way any nation or power can defeat us.

We have eyes in every level of government in every nation of the world. We know what is being planned, for our ears and eyes are ever present. State secrets are fully known to us. China recently accused the media in the U.S. of lying about Kosovo. Oh, you silly people, of course we lie. In this way we can keep the people unbalanced and always facing controversy which is very helpful to us. Have you not seen the talk show spectacle? Some of you believe we are the liberals and the good people are the conservatives. In reality, both serve our purposes. Each camp merely serves with the stamp of our approval but they are not allowed to present the real issues. By creating controversy on all levels, no one knows what to do. So, in all of this confusion, we go ahead and accomplish what we want with no hindrance.

Consider the President of the United States. Even though he regularly breaks every known check on his power, no one can stop him. He goes ahead and does whatever we want him to do anyway. The Congress has no power to stop him. He does what we want since he knows if he does not, because of his rather dark character, we can have him removed in a moment's time. Is not that a rather brilliant strategy on our part? You cannot take us to court because you can't see us and the courts are our servants as well. We run everything, yet, you do not know who to attack. I must say this invisible hand is wonderfully devised and without any known historical precedent on this scale. We rule the world and the world cannot even find out who is ruling them.

This is truly a wonderful thing. In our media we present before you exactly what it is we want you to do. Then, as if in a flash, our little servants obey. We can send American or European troops to wherever we like, whenever we like, and for whatever purpose we like, and you dutifully go about our business. How much more evidence do you need? We can make you desire to leave your homes and family and go to war merely at our command. We only need to present some nonsense to you from the president's desk or on the evening news and we can get you all fired up to do whatever we like. You can do nothing but what we put before you.

**YOUR VAIN RESISTANCE** When any of you seek to resist us, we have ways of making you look ridiculous as we have done with your militia movement. We have delighted to use this movement to show the world how impotent any resistance is. They look so silly marching around with their guns as if they were some match for our military. Look at what we did near Waco. Did the Davidian's little store of weapons help them? We have generously taxed you and used that money to make such sophisticated weapons you can in no way compete. Your own money has served to forge the chains we bind you with, since we are in control of all money.

Some of you think you may escape by buying some land in the country and growing a garden. Let me remind you that you still pay us ground rent. Oh, you may call it property taxes, but it still goes to us. You see, you need money no matter what you do. If you fail to pay your ground rent to us, we will take your land and sell it to someone who will pay us. Do you think we cannot do this? And with your ground rent we pay for the indoctrination of your children in the public schools we have set up. We want them to grow up well trained into the system of our thinking. Your children will learn what we want them to learn, when we want them to learn it, and you pay for it through your ground rent.

Those funds are also used for other projects we have in mind and our contractors are paid handsomely for their work. You may doubt that we own your children, or have such control, but you will find that we do. We can declare that you abuse your children when you spank them and have them confiscated. If they do not show up for school indoctrination, we can accuse you of neglect, thereby, giving them to us. Your children are not yours. They are ours. You must inoculate them, you must bring them to our hospitals if we decree or we will take them from you. You know this and we know this.

Through our electronic commerce we are able to see where you are, what you are buying and how much you have to buy things with. Where do you suppose we come up with our monthly financial statistics? Through the Internet and other sources we can even know how you think and what you say. It is not especially important to us what you believe as long as you do what we say. Your beliefs are nonsense anyway. But if you think you have a following, and we perceive that you might be somewhat dangerous to our agenda, we have ways to deal with you. We have a Pandora's box of mischief with which to snare you. We can have you in court so long you will never get out. We can easily drain away all your assets over one pretext or another. We have an inexhaustible fund with which to draw from to pay our lawyers. These lawyers are paid by you in the form of taxes. You do not have this vast supply of wealth. We know how to divide and conquer. Have we not brought down rulers of countries through our devices? Do you think your tiny self will be any match for us?

**YOUR VAIN ORGANIZATIONS** And, let us consider your religions and the "moral majority." The "moral majority" is neither moral nor is it in the majority. We have delighted to use this wet noodle of a movement to make ridiculous the Christian faith. The silly men who run that organization always end up with egg on their faces. We have always put them in defense of themselves as we have so successfully done with the NRA. We can make it seem by our media propaganda that the National Rifle Association is actually the New Radical Attackers.

Have we not turned the American conservative movement on its ear? If it serves our purposes we can use the conservatives to turn the liberals on their ear. It makes no difference to us but it serves to make you believe there are two sides struggling for their particular position. This helps to make things seem fair and free since everyone has a voice. Actually, there is only one side now with all kinds of masks on, but you are unable to penetrate our purposes. You see, we can do whatever we like and you can do nothing about it. Does it not seem reasonable that you simply obey and serve us? Otherwise, you get eaten up in the resistance you suppose will liberate you.

You cannot be liberated. Imagine how you can. We supply your fuel for your cars. We can turn it off whenever we like claiming that there is some sort of fuel shortage. What if your car breaks down? You cannot get parts for it without us. We supply all the money you use. At any whim of our desire we can stop the money supply or cause a complete crash all together. We can then order the president to declare all money worthless and that we will have to have new money. All of your stashes of cash will go up in smoke in a moment's time.

Don't you need food? If necessary, we can cause a trucker's strike which would stop deliveries of food to your local store. We can starve you whenever we like. You only have food because we have provided it to you from our table. During the great depression we controlled the food. We heaped mountains of food behind fences and let it rot. The hungry were then made to work in our labor camps even though there was enough and more to feed them. Do you really think you can beat us? You say you will hoard gold coins so you will still have money in the time of the crash. We can simply pass a law which outlaws the possession of gold as we have done in the past. If we find gold in your possession, we would simply confiscate it and put you in prison for breaking the law. While in prison you would be required to work in one of our prison industries. We have so formed a picture of the labor camps in our prisons these days that no one seems to object to them. We tell people that murderers should pay for their own keep.

No one seems to consider that we have the power to put tomato growers there also. We can pass laws that prohibit gardens and then make up some scientific reason why you may only buy food from our sources. If someone sees you growing tomatoes, they will report you to us and then we will have you in our fields working for us. Oh, silly nationalists, there is no escape for you, for since long before you were born, we were planning your capture. Your teachers and ministers have been forming your thoughts for us for generations now. You have no idea how to pull out of our influence short of suicide. Go ahead and commit suicide, it will only help us to deal with the excessive population. You cannot hurt us, find us, or even imagine what we are up to. I am throwing you these few crumbs only so that you may, if you have a little good sense, obey and follow our orders.

**YOUR CONTROLLED MIND** We run Hollywood. The movies such as Terminator and Armageddon, along with a great host of others, were simply created to get you thinking according to our directions. You have been made to delight in violence so that when we send you off to kill some bad man we have put before you, you move without a whimper. We have placed violent arcade games in your malls to prepare your young minds in the art of battle. We have made you to view our armies and police as the good forces and you submit to things that were unthinkable just a few decades ago. Our artful programs are all designed to help you to submit and even help the New World Order.

Star Trek, and other such creations, have taught you to simply obey orders from the new international rulers. Oh, silly people, you thought you were being entertained, while you were actually being educated. Dare I use the words, "brainwashed" or "mind control?" By the way, have you seen the new Star Wars? What a masterpiece of mental manipulation. Humans confer with nondescript beasts of all shapes and sizes and they confer in English. I wonder where those space beasts learned English. Oh, the simpleness of the mind of the citizen. He never considers he is being taken into fairyland. We have placed advertisements for Star Wars almost everywhere you go. You will find them in Wal-Mart, K-Mart, Taco

Bell and a host of our institutions of commerce. There is something we want you to learn from this movie. Or, perhaps it could be said, there is something we do not want you to learn. Either way, we will have what we want in the whole affair.

Of course, to keep you off guard we have instructed our elected officials to appear to be correcting the evil of our violence. President Clinton is now speaking against violence in Hollywood movies. This will not solve the problem, but will only make the people believe the problem is being worked on. Sex and violence are the very best powers to use to help us gain our advantage. How the people loathe to give up their sex and violence, so we place all they want before them. In this way, we keep them so occupied they do not have the integrity or brain power to deal with the really important matters which are left entirely in our hands. President Clinton has been very helpful to us. We knew of what character he was before we placed him as president. Exposing him was very helpful in adjusting the moral habits of the youth downward. This is to our advantage.

Even more agreeable to us were the vain efforts of those who thought they could remove him against our will. He is useful to us and he will not be removed by anyone until we are ready to have him removed. Excuse me if I seem to be mocking your system of beliefs, but they are rather outdated. Have you no eyes to see your vain liberties and your righteous pontifications are nothing before us? You can only do what we say you can do. We remove presidents when we are ready and the leader we set up will be there until it serves us to have another. At that time we place our purposed leader before you and you vote for what we want. In that way we give you the vain voting exercise in the belief you had something to do with placing your president in office.

**OUR UNFATHOMABLE MYSTERIES** Our recent war in Serbia has many purposes to it but we do not speak of these things openly. We let the talk show hosts blather all sorts of nonsense but none of it touches the core. First of all, there is a wealth of natural resources in Kosovo that we must have complete control of. Kosovo has large supplies of uranium in its soil and uranium is very helpful to our regime. Also, it suits us to keep all such minerals out of the hands of potential enemies. Milosovic has not been helpful in giving those resources into our hands so we simply make things difficult for him until he does. Even now victory over Yugoslavia is imminent.

We are reducing that proud nation to the level of humility we require from all people. After the war, if Mr. Milosovic does not sufficiently humble himself, we will take him to the world court charged with war crimes. We made up that term; rather ingenious, don't you think? How could there be such a thing as a war crime? The very nature of war is that the rules are off. It is so entertaining to watch the nations try to fight war according to the laws we have placed before them. The only war crime there really is only involves the crime of being against us. Anyone against us is violating our law. As you have seen when someone is for us we do not care what they do. Was not Nelson Mandella [sic] a bomb toting terrorist who killed many of his enemies? We made a hero of him.

We observe no laws when it comes to war. We do what we want, when we want and where we want. We can starve nations to death, we can ruin civilians and any other horror for which we would take our

enemies to court. Look at our example. We bomb Serbia out of its wits, bomb Kosovans out of their homes, poison their rivers and streams, turn off their electricity making a grand crisis in that country, and then we masterfully make it appear it is all Mr. Milosovic's fault and he needs to go to court for it. It is the same way we made our inferno at Waco look like Mr. Koresh's fault. Then there was our chief villain, Saddam with all of his weapons of mass destruction. Bad men are a dime a dozen and we can conjure one up whenever it suits us. This is really quite funny when you think of it. I am not one who is usually given to humor, but I do catch myself laughing sometimes at the absolute absurdity of the notions we place before you and you readily accept.

Do you wonder that the leaders of the world tremble at our presence? They know they have no power except the power we give them. We have no fear of Russia or China for we are already in full control of their system of things. China knows that we can freeze any number of its corporations in America and all of its capitol at the stroke of a pen. We use the nations for what we want to use them for. Everyone knows that they must yield to us or die. Fortunately, we have had a few resisters such as Saddam and Milosevic that have been helpful in showing the world leaders what we will do to them if they do not submit. There is only glory in following our purposes and doing what we say. If one does not, there will be such a sad and tragic result. I would really have you spared of such an end. But, then, again, if you are not spared, it is of no consequence to us. We will use you to alleviate some of the overpopulation problem.

**YOUR SILLY REBELLION AGAINST OUR DOMINION** Some of you have thought you could stop us by placing a bomb in one of our abortion clinics or in a government building. Silly souls! How can that hurt us? All that does is give us an example to use so that we might place more controls and heavy burdens on the population. We love it when you rebel and blow something up. You are our reason for making more laws against all those things which might contribute to your freedom from us. If someone did not blow something up on occasion, we would have no justification in placing more hedges about you. Can't you see how impossible it is for you to resist us? The more you wiggle, the more we squeeze.

Our kingdom is the kingdom of money. Excuse me, but I must confess that we are the rulers of the kingdom of non-money. You must see the humor in that statement. We have given you a piece of paper or some numbers on a computer screen that we have termed money. It is backed up by nothing and proven by nothing but what we say it is. We create it from nothing, we print it, we loan it, we give it its value, we take its value away. All things that have to do with money are in our hands. Think of it, what is it that you can do against us without money? If you try to resist, we can cancel your credit or freeze your accounts. Your cash is easily confiscated. We have made so many rules in the realm of living that you cannot live without money.

Camp on government land and you must move in two weeks. You cannot grow much of a garden in two weeks. Many of our wilderness trails are entered by permit only. We have passed laws that do not allow you to live in trailers over a certain period without moving to another location. Have you not thought it ridiculous that we will allow a man to live in a box full time but we will not allow a man to live in an RV full time unless he is in a taxpaying campground? We want you to be in the system. When you are buying a house, we not only receive the tax revenue to use for our purposes, but we gain large increases

from the interest on the loan. You may pay for your house two or three times over from the interest alone. The interest is also taxed which is again placed for use in those sectors of influence we choose.

We do not want you to escape free and that is why we have made it as we have. You are our property. We will not permit you to buy or sell unless you submit to our mark of authority. If you go to court against us, we will wear you out there and in the end you will lose. If you use violence, we will end up having you in one of our labor camps, more specifically called prison industries. You need our money, our entertainments, our fuel, and our utilities to function and if you don't have them, you feel deprived. By this, you are made to yield to our will. You don't even know how to think anymore since we have thoroughly emasculated your religions and your faith in God. Now, you only have yourself and we have gotten that self pretty well chasing its tail these days.

I hope this little note is sufficient to inform you what the new millennium is all about. The 21st century is our century. You may enter it if you do as you are told. We have no intention of playing around with your so-called human rights or your so-called Constitution. These things were only used for our purposes for a time. Your Constitution is a joke to us and we can do with it what we please. It never occurred to you that 50 years ago your Constitution was used to refuse abortions. When we decided to have abortions legalized we used the same Constitution to justify it. Your human rights are what we say they are and your Constitution is what we say it is. We have only used this phrase of human rights to keep things sufficiently in turmoil. The more things are unsettled, the better we like them until we have everything in complete servitude. This little letter may offend you, since I speak so plainly, but that truly is no concern of ours. Too bad isn't it? For all of you zombified sheep that is.....

----- End of Letter

**MENU: [HOME](#) » [Reconstruction](#) » [Recovery](#) » [Renewal](#) » [NWO Introduction](#)**

---

---

# Individual Agricultural Recovery After Nuclear Holocaust

**"The Farmer Comes First in the Reconstruction of Society"**  
(Techniques for Agriculture Recovery)

[bruce@webpal.org](mailto:bruce@webpal.org)

[Bruce M. Beach](#)

---

## Table of Contents:

**Prolog:** [and about the Author](#)

For over forty years the author has proclaimed the necessity of nuclear survival preparedness. These pages, however, are concerned with the next step - recovery after nuclear holocaust. It is the author's recognition that *"the farmer must come first"* that has led him to develop these pages.

**Introduction:** [What the Farmer Needs](#)

The societal importance of the farmer  
and how society needs to be reconstructed  
to reflect that importance.

**LETS:** [How to operate without money](#)

This will be one of the major problems facing the farmer - and here is the solution. Barter is good - but this is much better. This webpage is actually in another section - but it is so important that it is again listed and linked from here.

**Radiation:** [Fallout and Radiation \*IN FOOD\* after a Nuclear War.](#)

There is so much information on this subject that this links to a separate Table of Contents where you will find information on everything including:

Overviews and explanations for the Layman  
Fallout on the Farm.



Measuring Radiation in Food  
Removing radiation from food and milk  
Highly technical documents for health professionals

**For much more detailed information about the effect of nuclear weapons, the measurement of radiation, radiation measuring instruments, and so forth, for *other* than in food see: [the Resources Section in the Root Web page](#)**

### [Agriculture: Farming After a Nuclear War](#)

There is so much here also that a separate Table of Contents is provided. Because many people may be returning to farming after several generations - basic farming skills are covered here but there are also some techniques that modern mechanized farmers may have ignored (such as seed saving and the use of humanure) and that may be of use to the experienced farmer.

**There is also a lot about simplified farming in the separate Table of Contents linked from the Pioneering section below:**

### [Energy: Alternate resources.](#)

There are covered here a variety of alternate energy resources:

Stills for making an alternate to diesel fuel.  
Generating electricity with home made generators made from:  
Truck brakedrums using:  
    Windpower  
    Waterpower  
    Bicycle power  
    Small engines, etc.  
Old electric motors  
Homemade solar power heating systems

### [Technology: Simplified Machines and how to make things work.](#)

Explanations of how many machines work and alternate approaches where they can't be fixed.

### [Pioneer: The way they did it in the old days.](#)

Many skills that have been practically lost but that may be needed for a time during recovery.

## *What ???:* **What else might someone recommend for this series?**

What things will farmers need to know that I have not covered here?

---

## *Prolog:* **About the Author**

The purpose of this web page, as with many others that I written, is to assist mankind in the restoration of society after a nuclear holocaust, which I strongly anticipate to be its destiny.

The sub-title of this essay "*The Farmer Comes First in the Reconstruction of Society*" is self explanatory. Not only is it an obvious truth, it is also a subject dear to the author's roots. While it is true that he is the first generation in his family to be born off the farm, his wife was born on the farm and mostly for the exception of educational years and military service, he has lived in farming communities and among relatives that have remained in that industry.

While the author is particularly suited to deal with the problems of societal reconstruction, having been formally trained as an institutional economist, these subjects that he has written upon for many decades seriously suffer from the defect that there is almost total lack of dialog or critique because they are a subject in which there is practically absolutely no interest on the part of others. If you wish, you may:

click here to see my [bio](#).

and you may click here to learn more about [Ark Two](#)

and click here for more [nuclear recovery info](#).

Click here to return to the  
[Table of Contents](#)

---

## *Introduction:* **What the Farmer Needs**

For the farmer to accomplish his task,  
he must have three things.

security

incentive

resources

While confiscation, plundering, theft, exorbitant taxation, forced labor, and other similar forms of social transfer can accomplish short term goals of acquisition, in the long run they are very inefficient. As well as are over-centralization of authority and bureaucratic overburdens.

Free competitive markets, individual initiative, entrepreneurship, private ownership of the means of production, and the other accretions of a free society boundlessly demonstrated their worth in the productivity of the North American farmer when combined with plentiful fertile land, semi-stable markets and revolutionary advances in technology and the biosciences. These permitted, in the last two centuries, an inversion of 90% of the population living on the farm and 10% off to 10% living on the farm and 90% off with there still being great surpluses of production for export.

With all that - the often instability of many of the food product pricing markets, the machinations of the banking and finance industry, along with the vagaries of weather and pestilence combined with the oft-time seeming burden of government regulations to make farm life one of turmoil as society struggled to find a just method of reallocation of resources from an overproductive industry to other fields which were also struggling with problems of oversupply.

The concern for justice, both for the farm community suppliers and the non-farm community consumers, must ever remain the foremost consideration of those who try to regulate the agricultural field at any time. Pure *laissez faire* is not the answer, as evidenced by what happened to the farm community in the Great Depression, and there is no question but that the instability of completely free markets can be equally detrimental to producer and consumer alike.

Scale of production, scale of processing plants, the means of transportation and distribution, costs for machinery, fuel, fertilizer, seed and other resources are all matters that have often been outside the control of the individual farmer or even the farm community as a whole. Any concept that individual farm families can retreat to an isolated unit on their own is totally unrealistic. The great productivity that was achieved in North America was achieved through efficiencies arising out of social organization, specialization and economies of scale.

While there was bounty, there were also many undesirable effects. Styles of life that were not pleasant to those entrapped in them - such as migrant labor, or often what amounted in fact to even slave labor for many producers in the world market. There was the expense of high production at the cost of an often onerous burden to the environment in the destruction of resources that would sometimes take centuries to replace, if they were replaceable at all, and there was reasonable suspicion that some of the methods of production resulted in product that was not as healthy for the end user as it should have been.

To the survivor's of a nuclear holocaust, many of the above points will seem to be but quibbles, and they will simply wish for the "good old days" before the nuclear war. However, we must remember that it was the power of the over centralized bureaucracies and the gigantic soulless corporations that created the problem in the first place. It was their unjust international transfer of resources and products of labor and the lack of universal concern for justice in economic exchange between all nations of the world in both agriculture and other economic spheres that created the social unrest, and eventual holocaust. It is not that institutional greed is more evil than individual greed, it is just that it is less amendable to rectification. Over the last two centuries the resulting terrible cost to the farm community has not been just an economic one but also, for untold tens of thousand families, personal loss of loved ones who were drawn up in the maelstrom of international conflicts, far beyond their personal interest, never to be seen again.

There is no question but that in time, productivity can be restored. However, the real question is - can justice be established - because that is something that has never been achieved. Justice, in this world, has always been, and always will be relative. Because there is always a better way and a worse way, we should try to find the better way. If we decide that we don't like peace, then we can always go back to war. And there is no question, that if we work at it, we can be ready for another nuclear war in twenty years.

Top down design has been the problem. Direction by gigantic entities of power, influence and control. The rule of power politics and special interest groups. The solution is bottom up selection WITHOUT POLITICS. The top will then reflect the aspirations of the bottom. All of this, I explain in the

[LETS](#) system.

Also, under LETS, no matter how misguided or mistaken the policies in the higher echelons may be, there still remains a degree of autonomous local control that permits the amelioration of what could otherwise be intolerable suffering.

Click here to return to the  
[Table of Contents](#)

**MENU: [HOME](#) » [Reconstruction](#) » [Recovery](#) » [Renewal](#) » [Survival](#)**

---

---

# Fallout and Radiation in Food after a Nuclear War

[bruce@webpal.org](mailto:bruce@webpal.org)

[Bruce M. Beach, bio](#)

Click here to return to the  
[Social and Economic Recovery  
After Nuclear Holocaust](#)

---

## Table of Contents:

*Overview:* [Layman's overview on Radiation in Food.](#)

A non-technical overview of how radiation gets into food. The effect that it has and what can be done about it.

*Food:* [Shorter letter on radiation in Food](#)

This was in response to a study that I commissioned. The full report is the next item.

*Radiation in Food:* [Explanation by a microbiologist](#)

This is the full report by the microbiologist, Aina Shapley. It covers the measurement of radioactivity in food and WATER. [There is also a copy of this available in .pdf](#)  
(for which you need a pdf reader)

*Risk:* [Radiation Risk and Ethics](#)

There was much scare talk about the effects of peace time radiation. This professional paper gives a much different view. It helps to get things into perspective.

*Measurement:* [Manual of food quality control - radionuclides in food](#)

This .pdf document is the prime authoritative document on the subject. I obtained the information through its author Edmond J. Baratta, International Expert on Radioactivity with the US Food and Drug Administration at the research facility in Winchester, Massachusetts. The document is published both by the FDA and FAO (Food and Agricultural Organization of the UN). 133 pages in length and both very technical and readable in its detailed description of the methodologies and processes involved. However, since it does carry a copyright, and the government charges hundreds of dollars for a copy, this file is presently sealed until after the nuclear war.

**[Milk: Removal of Strontium 89 and 90 from milk](#)**

How to remove radiation from milk in a processing plant. This is the 61 page masters thesis of David Gene Easterly. I have the author's personal permission to republish it here.

**[Potatoes: How to remove radiation from potatoes](#)**

(link not yet working)

Now, if I can find this information again.

Click here to return to the  
[Social and Economic Recovery  
After Nuclear Holocaust](#)

---

## Table of Contents

**Layman's overview on Radiation in Food  
(Techniques for Agriculture Recovery -  
After Nuclear Holocaust)  
by Bruce Beach, Radiological Scientific Officer**

**[Prolog: Nature of the problem](#)**

Why radiation is a problem and how it gets into food.

**[Short Term: The Short Term Problem](#)**

The short term problem .

**[Survival: The Short Term Solutions](#)**

The easy solutions for the short term problem.

### *Long Term:* [The Long Term Problem](#)

Why there is a long term problem, and how serious it may be.

### *Solutions:* [The long term solutions.](#)

Fourteen solutions for the long term problem.

Click here to return to the  
[Radiation in Food](#)  
[Table of Contents](#)

---

---

## *Prolog:* [Nature of the Problem](#)

Radiation does not harm food. Radiation in food is very harmful. One needs to make the distinction. Without entering into the debate, about whether microwave ovens harmed food, destroyed vitamins, etc., the irradiation of food in general, and by most researchers, has not been considered as being harmful. In fact it has been found to be very beneficial, for the same reasons that we cook and preserve any food.

However, radiation *in* food is *very* harmful because it is then absorbed by the consumer. Radioactive particles give off energy. This energy weakens, destroys, or otherwise harms cells. One might picture it as little microwave ovens, inside the body, cooking it from the inside. What is cooked are the cells in the body. Just like with any burn, there may be degrees. Sometimes a cell is destroyed completely and if enough are destroyed then we become sick, weaken, or die. Other times, radiation may only damage or deform the cells. The deformed cells may multiply, causing cancer which is one of the main longterm concerns about radiation.

Radioactive particles are isotopes of minerals that the body naturally seeks and absorbs. We call them isotopes because in the nuclear chain reaction process they have obtained one or more extra electrons. In this state they are unstable and will eventually give off the electron as energy and thus return to their stable state. It is that energy which is harmful.

Radioactive isotopes give off their energy in a random fashion but at a predictable rate. That is like saying that everyone in a population will die within 100 years. This we can predict with high probability and build mortality tables to that effect although we don't know when any one individual will die. The

same is true with isotopic atoms. We know that a population of them will give off all their energy in a predictable time, although we do not know when any one atom will give off its energy.

Just as different species of animals have different average lifetimes, for example shorter for fruit flies and dogs than for people, and longer for some species of parrots and turtles than people, so also do the isotopes of different minerals have different average lifetimes. For some isotopes, indeed most, the average lifetime is very short by human lifetime standards. The isotopes last only milliseconds, or less. Gone in far less than the blink of an eye. Their energy makes up what we call the initial radiation of an atomic blast. Most other radioactive particles decay, that is to say lose their energy in a matter of minutes, hours, or days. They linger around to cause the problems that we see in fallout and are the reason that one needs a fallout shelter for a few weeks after a nuclear war. But even with the latter, most of the radiation is gone in a couple of weeks.

The length of time that it takes a quantity of a radioactive isotope to lose half of its energy is what we call its half life. This can vary from milliseconds to a great many years. As mentioned, for most isotopes it is all over in milliseconds, but the ones that we are most concerned about take decades. Let us suppose that the half life of an isotope was 50 years (there are a couple that approximate that) and that we had a sufficient quantity of it that it was giving off 100 rads. Then in 50 years the radioactive source would be giving off 50 rads. In a hundred years it would be giving off 25 rads. In a hundred and fifty years it would be giving off about 12 rads. In two hundred years it would be giving off 6 rads.

For all practical purposes that source would be depleted, that is to say giving off less than 1 rad in three hundred years. As to when it would reach zero that is sort of the old Greek problem of when the bear would get out of the cave. Starting at the back of the cave it has to go half of the distance first to get out. Then at the half-way point it has to go half of the remaining distance to get out. And then at the quarter-way point, half that distance again. And so on. Logically, (this is the problem with logic and math) we can say the bear will never get out of the cave. It is what we call an asymptotic problem.

So there may always be some residual radiation from a nuclear war. Indeed, some people have speculated that there is already residual radiation on the planet from pre-historic nuclear wars. We also get background radiation from the cosmos. So radiation is always with us. Indeed, some radiation may not be harmful. It may even be necessary. Just as arsenic is considered a deadly poison, nevertheless, without any arsenic in your body - you would equally well die. Enough water and you will drown. Not enough and you will die of dehydration. Balance in all things. Probably regarding radiation also. Experiments have shown that people who live at higher altitudes and who therefore receive more natural radiation from the sun and cosmos, have lower incidence of cancer.

But here, we are talking about too much radiation. And most seriously, radiation that has gotten right into our systems through food. As before, a little bit may not hurt, but we are talking about lots. How it happens is this. The food chains filters in the radiation because it is trying to concentrate the minerals and can't tell the difference between a radioactive isotope of a particular mineral, and its non-radioactive isotope variety.



As an example, let us look at iodine. Too much iodine in the body is poisonous. Too little is also very detrimental. The thyroid absorbs iodine for the body. Because we naturally get iodine from the food we eat and because it is generally added to salt, there is little likelihood that today (although in previous centuries it was a problem) that one gets too little. A nuclear explosion creates isotopes of iodine (I-131 and I-132). These have a half life of about 8 days. This means that it will hang around for about a month after a nuclear explosion. That is the reason that we take Potassium Iodide pills, for a month after a nuclear explosion, so that the thyroid will be loaded with iodine and won't accept anymore iodine during that period.

But here is what happened, during the atomic experiments, when people didn't know about this and didn't take the potassium iodide. The radioactive particles were carried up into atmosphere and settled down on the milk shed of southern Utah. There were so few particles that the radiation meters couldn't measure them. However, they washed down into the soil and the bacteria in the soil, seeking minerals, absorbed them in preference to other inert matter. The lichen in the soil, also seeking minerals, then absorbed the bacteria. These were further absorbed by the legumes and higher grasses. Then a cow came along and ate the grass. Each organism concentrated the minerals because that is what it was really seeking.

Indeed, within the body, certain organs filter out certain minerals also. The bone marrow seeks calcium and such, as do the mammary glands which produce milk. As an aside, concentration of radioactive particles in the bone marrow causes leukemia, actually one of the more prevalent forms of cancer caused by radiation. And leukemia destroys the body's immune system which makes it fatal because of all sorts of causes. However, to continue with our journey of a radioactive particle. This particular one, particularly ended up in the milk. When the milk was drunk by a nursing mother, her system too concentrated the mineral iodine, especially in her milk and she thus passed along the radioactive isotopes to her child with their mother's milk. Finally the child's biological system concentrated the iodine in its thyroid and radioactive isotope had by now become so concentrated that if we held a radiation detector up by the child's neck near the thyroid - it buzzed like a rattlesnake.

The radiation had become very detrimental to the children, and there was a high incidence of mental retardation in the St. George area of southern Utah as a result of the atomic experiments in Nevada. Indeed, scientific studies showed that approximately eleven thousand cases of cancer occurred in the general population of the United States, as the result of nuclear testing. Before we get too excited about that, one must remember that about 20 times that number of cases were caused by desired uses of medical and dental x-ray and other sought after uses of radiation.

Yes, radiation causes cancer. So does water cause drownings. And automobiles cause much greater numbers of fatalities than both put together. Before automobiles horse accidents also caused many human deaths. In all these matters, one has to weigh the relative social benefits before they dispense with radiation, water, automobiles or horses. Every activity, whether manufacturing or mining, whether production or sport, has its attendant risk. Pollution from burning coal has caused much more in the way of cancer than industrial radiation ever has, so let us keep things in perspective.

The issues, in this essay, and in the accompanying scientific papers, are how much radiation we will be dealing with for how long a period of time - along with the techniques of dealing with it.

Click here to return to the  
[Layman's Overview](#)  
[Table of Contents](#)

---

## *Short:* **The Short Term Problem**

In the short run after a nuclear war the problem is fallout. Fallout that prevents work outside. Fallout that gets onto food. Fallout that contaminates the soil and prevents the immediate planting of new crops. Fallout that kills the animals. Fallout that contaminates the water and streams. Fallout that blows about in the very air itself.

But fortunately all this is a short term problem of just a few weeks and the radiation in the fallout will decay. Following that, one will then have to deal with the problem of long term residual radiation. However, that is a subject for another section. The problem being discussed here is short term radiation and in the next section the short term solutions for dealing with it.

Click here to return to the  
[Layman's Overview](#)  
[Table of Contents](#)

---

## *Survival:* **The Short Term Solutions**

The good news is that food that was grown before the nuclear event, does not become radioactive. As long as the radioactive particles that fall on it are removed then it is perfectly okay. Wash off a banana - then peel and eat it. Wash off an egg - crack it open and it is ready to cook. These principles apply to any fruits and vegetables. Scrub the dirt off the potatoes and they will be perfectly fine. Open any can or closed container and the food will be unaffected. A case of tomatoes could have been sitting outside in the fallout and all one would need is to wash off the can and open it.

Some food may take a little more care. Grain stored in a grainery where dust can have gotten in may need to be washed. Animals may have died or gotten sick from the radiation and needed to be slain, but so long as care is taken in handling the exposed part of the animal the meat will still be okay. We are only talking about immediately after the event. Animals that have had an opportunity to forage in fallout

contaminated areas will assimilate the radiation into their bodies and also into products such as eggs and milk.

So, this is the good news. Immediately after a nuclear war, any food that is still around and that would otherwise be edible, will still be edible. If it has spoiled from lack of refrigeration, or some other cause - then that is another matter. However, in rural areas that have storage facilities there should not be any lack of food of some type. In fact there may well be more food than survivors, but eventually they are going to need a new crop - and that is an entirely different matter, covered in a separate section.

Click here to return to the  
[Layman's Overview](#)  
[Table of Contents](#)

---

## *Long:* **The Long Term Problem**

The long term problem of radiation after a nuclear war arises from the fact that some isotopes, as explained in a previous section, have half-lives of decades. Those isotopes which have half-lives of centuries are not really a problem because they give off so little energy during a human lifetime that they are irrelevant.

Neither are the isotopes that we are talking about an external bodily threat because they are usually found in very small quantities. However, because they are concentrated by living organisms, and because in food they become internal to the organism, they can be a serious health concern in food. The two most serious problems, long term, are isotopes of cesium and strontium, both of which in themselves are desirable minerals for many living organisms. The organism is unable to distinguish between a beneficial and a harmful isotope and will therefore equally absorb those which are harmful.

Exactly what quantities are of serious concern and how they may be detected and measured are explained in technical papers in this series. The next section will explain, in generalities, how the problem can be dealt with. At present there is no coterie of professionals trained, equipped or experienced to deal with the technical issues. These technicians will have to be developed from individuals with related technical training - after a nuclear holocaust - and it is for that reason that the necessary technical papers are provided here.

Click here to return to the  
[Layman's Overview](#)  
[Table of Contents](#)

## *Solutions:* The Long Term Solutions

The long term problem of radiation in food is indeed a horrendous one, but not an insurmountable one. We are used to processing food and to preserving it. This is just an additional step like testing for bacteria or other spoilage. Unfortunately, it is not one that is as easily done at home as other food preparation methods have been in the past. Still one can take care to make sure that radiation does not get into their home produced crops - in the first place.

Some of the necessary procedures may at first seem arduous but that is just a matter of custom. Because of radiation, there may be areas of land which one will wish to avoid in growing crops. But really, that is no different than today where some areas are avoided because they are too rocky and others because they are too swampy.

Some plants prefer other minerals rather than cesium and strontium. Those plants and soil with the alternate minerals, or fertilizer containing them, can be used. These again are matters of expertise that need to be developed in each local soil and plant area, so while information assisting those determinations is presented in the accompanying technical papers it is a matter beyond the generalities of this essay.

I have often stated that there are long term strategies for dealing with radiation in food. Many times I have been asked to list examples in one place and so to satisfy that request - I do so now:

1. Selection of land that is not radioactive.
2. Deep plowing land to turn it over and bring non-radioactive soil up to the surface. (This works well only where there is deep topsoil).
3. Selecting plants to match the soil characteristics, i.e.. that they have no desire for the radioactive minerals that are in the soil.
4. Fertilizing the soil with a mineral that will be taken up in preference to the radioactive mineral. (Oftentimes this is calcium as found in marl).
5. Composting and creating soil that does not have radioactivity in it and then using that soil in a green house, or otherwise protecting it from contamination.
6. Using hydroponics gardening or other similar methods that tightly control the mineral uptake of the plants.
7. Using distilled water on the plants. (Unfortunately this deprives them of the minerals that they

need and minerals then need to be added to the water).

8. Removing the radioactivity from the food. See the article on milk processing for example. There are other techniques for other foods.

9. Storing the food until radioactivity decreases. This works well for the radioactive iodine isotope in powdered milk and cheese.

10. Avoiding foods that have high radioactive content. For example, soy milk might be substituted for dairy or mother's milk for children.

11. Eating lower down on the food chain. As explained in an earlier section, radiation is concentrated by living organisms. Each higher level concentrating it more. It is possible to make flour directly out of bacteria. Using non contaminated oil sources from wells or tarsands would then produce pure uncontaminated flour.

12. Avoiding meats and animal products because they are high up the food chain.

13. Classifying foods by radioactive content and using high content foods for feed for animals that will neither produce product nor be eaten - such as dogs. Coincidentally, because of their relatively short life expectancies, in many cases this will not be detrimental to them.

14. Reserving foods with high radioactive content for individuals with short life expectations. Because at some levels it takes twenty years or longer for the radiation to take effect this will not be detrimental to people who are already elderly. Let them have the meat, fresh milk and eggs.

15. This is by no means an exhaustive list and still other strategies will be developed with experience. Food radioactive content can be indicated in packaging, the content can be certified and varieties of foods can be imported from areas that are radioactive free for that particular food. Eat well and prosper.

Click here to return to the  
[Layman's Overview](#)  
[Table of Contents](#)

**MENU: [HOME](#) » [Reconstruction](#) » [Recovery](#) » [Renewal](#) » [Survival](#)**

---

---

**MENU:** [HOME](#) » [Reconstruction](#) » [Recovery](#) » [Renewal](#) » [Survival](#)

October 13, 1985

Dear Bruce Beach:

I am starting to understand why the information you want is not in literature. The most obvious, the one you are well aware of, is that experts plan to eat stored food. There is enough of it around in North America. I have seen the problem of food discussed in regard to England - their worry is that there just wouldn't be enough food of any kind to feed the surviving population. Therefore, measuring radioactivity in food is not the major problem.

If the attack came at harvest time, in most areas the food wouldn't be harvested because of the external radioactivity. If it came in spring, the plants would be killed or stunted over large areas. There probably would be some areas where there could be some harvest. Here you would have to compare the radioactivity of the washed or the processed product to what you had in stored food. Storage of the fresh food for a few more months might bring the radioactivity down to a safe level. A number of experts have implied that if you survived the first year, you would survive. I don't know a thing about "nuclear winter".

It comes down to measuring radioactivity (fallout contamination) in stored food. It is possible you might get large quantities that have no contamination at all or less than double of normal background. Then you can use a label "no significant radioactive contamination". A Geiger-Mueller counter would be very good for this. If you plan to look after thousands of people, you would need a lot of them.

The problem starts when the food is substantially contaminated. What kind of classification would be meaningful to the general public? There also would be a social problem. You and I might be willing to eat the more contaminated food so that our children and grandchildren could eat less contaminated food. But what about people in thirties and forties who wouldn't have children in the group you were working with or didn't have children at all. Would they take risks for the future benefit of society? At present, I don't find this a very prevalent trait in our society. If things were really scarce, one would also have to protect the individuals whose skills would be essential for the survival of the greatest number of people.

Back to science. You would like to have figures on bars of food telling how much you could eat without getting radiation sickness. For example, a label on a wheat bag saying you can eat 1 lb/day for a year (indefinitely) and not get radiation sickness. To arrive at this figure one would have to take into account the decay rate and the rate at which it is accumulating in the body. Assume that the consumer has no accumulated radioactivity. Despite the oversimplifications to the extent that you might consider it inadequate, I have not come across anything as complicated in the scientific literature. Needless to say I can't do these calculations.

I will be asking this question of a number of health physicists and see if they theoretically could make

some approximations and provide us with a method of doing it, and second, if they would be willing to do it.

Another approach. A Geiger counter would be calibrated against a certain radionuclide (whatever standard you had available), let us say cesium. Now we could have a label on a wheat bag saying "on this date it has the equivalent of X mc of cesium/lb" (meaning, if all the activity measured by the Geiger counter was due to cesium, that is how much it would be; I have invented a new unit). I would have to find somebody who would be willing to estimate how many rads of body burden it would result in if you ate one lb of it. This would have to be modified by (1) what time interval after the measurement was done you started to eat it, (2) the quantity you are eating, (3) how many days you will be eating it, and (4) even the length of time after the explosion has some effect. Next week you get a bag of corn with Y mc/lb of cesium equivalents. The following week it might be back to wheat with a higher level of contamination than before. In effect, each person would have to keep a daily track of their body burden. All of this ignores the external radiation you had received or will be receiving, what internal radiation you had received from inhalation and ingestion (water and other foods) or will be receiving, age of person, weight of person, persons nutritional state and health. Are you starting to understand why this information is not available?

In some ways it might be the best to say by what factor a certain food is above the normal background radiation of the world. There would have to be some chart where one could read off what it would be a certain number of days after testing. This could be related to rough categories for eating indefinitely: completely safe for everybody at 1 lb/day, slight danger to children and pregnant women, danger to children and pregnant women and slight danger to others, danger for everybody. One problem would be that as time went on it would be harder and harder to get a normal background reading. There is no way of getting around that people would be eating different quantities of varying concentration at different times.

My personal reaction is to keep it relative and eat whatever has less ticks with a Geiger counter. If you didn't like the number of ticks, you wouldn't have any choice anyway. Starving to death isn't an easy way to die either. If one looked only for what was relatively better, accurate standardization of a Geiger counter wouldn't be as important. You would need a lot of Geiger counters and a lot of people who understood enough about radioactivity to use a Geiger counter in a meaningful way. I see education of people as one of the biggest problems. How many people do you know in your town at present who know properties of radiation? To how many people would it be meaningful if you quantified the radioactivity?

You were willing to consider going the whole way and getting a spectrometer. That way you would know exactly how much of what you got. Dr. Prudham's question was what good would it do to you if you did have that information? I couldn't answer that question. If you are still considering such a possibility, I would like you to answer the question, in case someone asks it of me again.

Dr. Eaton's comment was that there are so many parameters that it is impossible to work with something

like that. He expressed his sympathy to me when I said that you wanted definite figures.

Since there are more than 10 variables, there are more than 100 possibilities. Judging from the literature, there certainly should be a few people who could take one or two variables and come up with some figures. The only problem is that they would not fit the other 99 cases.

I certainly won't be able to provide you with the information you want, but I am getting close to being able to tell you who are the people who would have the best understanding of the subject. Some of them are acknowledged at the end of the book "Nuclear War Survival Skills".

Hopefully, we come across somebody who is willing to play around for a few days and see if he can come up with a way of quantifying the relative danger of contaminated food.

I have written some 14 letters and I will have more written by the time you get this letter.

You have expressed quite an interest in I-131 in milk and the possibility of decontamination. It is not something that I would recommend. If you will have to stay in your bunker for 6 weeks, the cows would probably be dead. If there are cows and there are people to milk them, the dairy plants are also standing. Convert the milk to canned milk, powdered milk, sterile milk (the kind you can buy in stores now) or cheese and wait until the I-131 decays. Meanwhile, pass a "law" that all canned milk and powdered milk on hand has to be reserved for children under 1 year of age. If the supply is greater than what babies would need for next 3 months (if the cows are alive and there is a prospect of returning to normal), older children could have milk too. If there was plenty of fresh milk, adults might drink it, provided they took KI tablets. (I personally don't see why anybody would want to do it.) A decontamination plant would have to be completely operational before the disaster, otherwise there wouldn't be enough time to get it going before the danger would be over. Besides, there might not be any milk anyway.

The reason why there is so much literature on I-131 is because it is one of the greatest dangers from nuclear power plants. I will find out if the Bruce Nuclear Plant is of the type that could give off large quantities of I-131.

This gives you an idea of what I am doing. You might want to see me. I will be available next week, I will be visiting my relatives in Michigan this Thursday.

Sincerely,  
Aina J. Shapley

**MENU: [HOME](#) » [Reconstruction](#) » [Recovery](#) » [Renewal](#) » [Survival](#)**

---

---



*Preface:* Since Mrs. Shapley completed this study in 1985, there has now been extensive experience of the contamination of the food chain as a result of Chernoybl. In light of this, and other research, Mrs. Shapley, who has remained an active T.E.A.M. Leader in the Ark Two Community, is preparing an addendum to this study. The plan is to post the addendum when it is ready.

*Study prepared for Bruce Beach on the*

# CONTAMINATION OF FOOD PROBLEM AFTER NUCLEAR WAR

December 4, 1985

Aina J. Shapley, B.S., M.S.  
(Microbiologist)

## TABLE OF CONTENTS

## Overview

The most important fission products in food p. 1  
p. 10

Methods of measurement p. 20

Lack of standards and MPD p. 24  
p. 30

## Emergency schemes

Note.

The vast majority of papers referred to have been copied.

A lot of subjects have not been discussed, e.g. units, different instruments, properties of radiation, and dose calculations. They are described in health physics text books. You have *An introduction to radiation protection* by Alan Martin and Samuel A. Harbison and *Radiation Protection* by Jacob Shapiro.

Abbreviations:

OTA = Office of Technology Assessment

DEF = Dose Effectiveness Factors

MT = Megatons

MR = Milliroentgens

R = Roentgens

RAD = Radiation Average Dose

REM = Radiation Equivalent Man

R, REM and RAD are essentially equivalent

# Overview

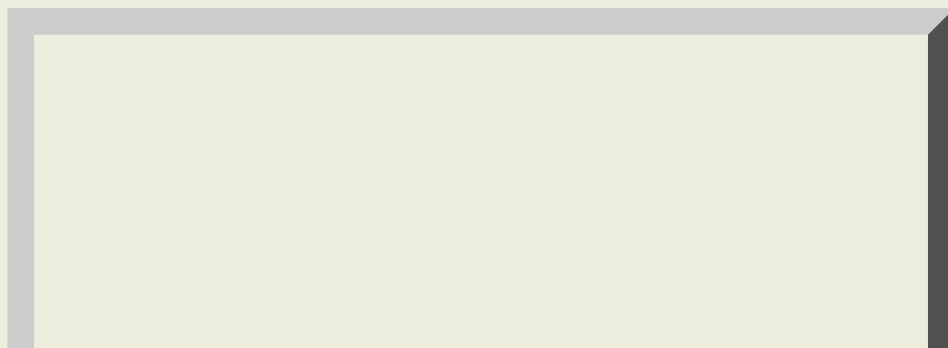
Shapley Page 1

The most thorough and the most authoritative book on *The effects of nuclear weapons* is a book by that title compiled and edited by S. Glasstone and F. J. Dolan, 3rd ed., U.S. Department of Defense and U.S. Department of Energy, 1977. This book is referred to in almost all the articles and books dealing with a nuclear war. It is the source book on the description of the different atomic bombs, their uses and the consequent explosive blast, direct nuclear radiation, direct thermal radiation, EMP, and fallout.

The most thorough study of the probable consequences of nuclear weapons on the United States, as well as on the Soviet Union, was done by the Office of Technology Assessment (OTA), *The effects of nuclear war*, 1979, (for complete ref see [\(Shapley p. 8\)](#) They considered five major cases ranging from 1 atomic weapon to an all out mixed military and population attack of 6500 MT (half of it air bursts and the other half surface bursts).

We are interested in the latent health effects. I have copied 7 of the most interesting pages and given them page numbers in the upper right hand corner. The risk factors for the latent health effects, as well as the sources and the compromises they made to arrive at them are given on [\(Shapley p. 2\)](#) The risk factors they used for latent cancer deaths from internal organ exposures are given on [\(Shapley p. 3\)](#)

Before we go any further, we have to examine some of the categories they use for the way they present their data. Local fallout is what is deposited within 24 hours after the burst. The fraction of nuclear debris in the local fallout varies from 0.8 from surface bursts to 0 from airbursts. Worldwide fallout can be of two kinds, tropospheric and stratospheric. Tropospheric fallout is short (weeks). Stratospheric fallout is in years, e.g. removal half-time for Cs-137 is 5 years. Stratospheric fallout can be from 0 to .99 of the fallout, depending on the altitude and size of the weapon.



[click here](#) for Shapley Pages 2 and 3  
which are a reprint from  
OTA (Office of Technology Assessment),  
*The effects of nuclear war*

Shapley Page 4

For the worst scenario (6500 MT) they predict 100 million early fatalities (could be as high as 160 million). On ([Shapley p. 5](#)) they give a comparison of latent health effects from external and internal exposures from local fallout. By far the most of the effects are from external exposure rather than from internal exposure. For cancer deaths only 7% are from internal exposure and for thyroid cancers it is less than 1%. On ([Shapley p. 6](#)) they give worldwide fallout health effects for the U.S. The most interesting thing about this is that they see carbon-14 as the biggest problem in this category. Next table ([also on Shapley p. 6](#)) is total latent health effects and the numbers do look high. The thing to keep in mind is that these figures are for the subsequent 40 years. 6.6 million cancer deaths in 40 years is about 40% of the current U.S. annual rate. It is interesting to note that there are almost as many latent health effects outside of the U.S. (e.g. 4,545,000 cancer deaths). These would be distributed all over the world. If there was a similar attack on the Soviet Union, there would be 167,000 cancer deaths plus all the other latent health effects in the U.S.

([Shapley p. 7](#)) and ([Shapley p. 8](#)) give the summary of their conclusions.

([Shapley p. 9](#)) gives their references.

[click here](#) for Shapley Page 5  
which is a reprint of  
**LOCAL FALLOUT HEALTH EFFECTS**  
from OTA (Office of Technology Assessment),  
*The effects of nuclear war*

[click here](#) for Shapley Page 6  
which is a reprint of three tables  
WORLD WIDE FALLOUT HEALTH EFFECTS  
TOTAL LATENT HEALTH EFFECTS  
and  
TOTAL LATENT HEALTH EFFECTS OUTSIDE  
OF U.S.  
from OTA (Office of Technology Assessment),  
*The effects of nuclear war*

Shapley Page 7.

## CONCLUSIONS

The long-term major adverse health effects resulting from hypothesized nuclear scenarios covering a nuclear employment range from a single weapon to a massive attack utilizing thousands of nuclear weapons were calculated. The general findings were as follows:

1. Several million latent cancer deaths could result from a massive nuclear attack directed at urban-industrial, military, and counterforce targets. *\*note* However, without improved civil defense capabilities, the number of projected latent cancer deaths is small when compared with the total number of early fatalities. Similar magnitudes of thyroid cancers, thyroid nodules, and genetic anomalies are also projected.

*\*note 5 million worldwide cancer deaths over a period of 40 years represent an increase of about 2 to 3 percent of the current cancer death rate. - They must be using Northern Hemisphere or something. For U.S. this would be closer to 30%.*

2. For limited attacks where the target points are in relatively low population density areas, the resulting number of latent cancer deaths could be large when compared with the total number of early fatalities.

3. For nuclear employments that are dominated by airbursts, the projected number of long-term adverse health effects that would occur in the attacked country is only a small percentage of the projected worldwide total.

4. For airbursts, the resulting number of long-term adverse health effects are larger for low yield weapons (40 KT) than for high yield weapons (1 MT) when compared on a per unit

fission yield basis. The reason is that the nuclear debris of low yield airbursts is confined within the troposphere, whereas most of the nuclear debris from high yield airbursts enters the stratosphere.

5. Increasing the local fallout decontamination effectiveness to residual levels below 0.1 will not materially decrease the total number of long-term latent health effects because the local fallout post-shelter population dose constitutes only a small

Shapley Page 8.

fraction of the total population dose when the fallout levels are reduced by a factor of 0.1 by decontamination.

6. The use of low yield weapons in the surface burst mode rather than high yield weapons as air bursts would increase the long-term latent adverse health effects in the country attacked and decrease the number of the effects in the rest of the world.

7. For massive nuclear attacks (Scenario 5a and 5b), although the number of early fatalities are sensitive to the shelter protection provided the population, the projected total number of latent health effects are relatively insensitive to the shelter protection provided.

Office of Technology Assessment, *The Effects of Nuclear War*, Gale Research Company, Book Tower, Detroit, Michigan 48226, 1984. (This is an extended version of 1979 publication by U.S. Govt. Printing Office.)

Abbreviation used: OTA, *The effects of Nuclear War*.

Shapley Page 9.

## REFERENCES

1. The Effects of Nuclear Weapons, Compiled and edited by S. Glasstone and P. J. Dolan, Third Edition, U.S. Department of Defense and U. S. Department of Energy, 1977.
2. Report of the United Nations Scientific Committee on the Effects of Atomic Radiation, General Assembly, Official Records: Seventeenth Session, Supplement No. 16 (A/5216), United Nations, New York, 1962.
3. H. Lee, P. W. Wong, and S. L. Brown, SEER II: A New Damage Assessment Fallout Model, DNA3008F, SRI International, Menlo Park, California, May 1972.
4. (Classified Report)

5. G. R. Crocker and T. Turner, Calculated Activities, Exposure Rates, and Gamma Spectra for Unfractionated Fission Products, USNRDL-TR-1009, U.S. Naval Radiological Defense Laboratory, San Francisco, California, 28 December 1965.
6. N. C. Rasmussen et al., Reactor Safety Study: An Assessment of Accident Risks in U.S. Commercial Nuclear Power Plants, Appendix VI, Calculation of Reactor Accident Consequences, WASH-1400, Nuclear Regulatory Commission, October 1975.
7. H. Lee, W. L. Owen, and C. F. Miller, General Analysis of Radiological Recovery Capabilities, SRI International, Menlo Park, California, June 1968.
8. The Effects on Populations of Exposure to Low Levels of Ionizing Radiation, Advisory Committee on the Biological Effects of Ionizing Radiations, National Academy of Sciences, Washington, D.C., November 1972.
9. R. A. Armistead et al., Analysis of Public Consequences from Postulated Severe Accident Sequences in Underground Nuclear Power Plants, Advanced Research and Applications Corporation, Sunnyvale, California, December 1977.

# THE MOST IMPORTANT FISSION PRODUCTS IN FOOD

Shapley Page 10

There are a number of good books on the subject. The most valuable probably is *Radioactivity and Human Diet*, ed. R. Scott Russell, Pergamon Press, 1966. Others: *Radionuclides in Foods*, National Academy of Sciences, 1973. *Radioactive Fallout, Soils, Plants, Foods, Man*, ed. Eric B. Fowler, 1965.

Iodine, strontium, and cesium are the most important radionuclides that enter the food chain and are absorbed by man from the intestinal tract. Barium-140, ruthenium-103, iron-55 can also be absorbed to a small extent. Tritium and carbon-14 are also very important but they are so mobile in the environment, no one can do anything about them. There are many other radionuclides that are important in the first few months after a nuclear explosion if one eats food directly contaminated by the fallout. Although the latter radionuclides are not absorbed by the body, they can do great damage to the intestinal tract while they are

passing through the body.

*Iodine.* There are some 11 isotopes of iodine that are produced in fission. All except I-129 which has a half-life of  $1.6 \times 10^7$  years have shorter half lives than I-131.

Isotope	Half-life	Activity relative to 24 hrs after thermal fission of U-235
<b>I-131</b>	<b>8.05 days</b>	<b>1</b>
<b>I-132</b>	<b>2.3 hrs</b>	<b>3</b>
<b>I-133</b>	<b>20.8 hrs</b>	<b>9</b>
<b>I-135</b>	<b>6.7 hrs</b>	<b>5</b>

Although I-132, I-133, and I-135 are more abundant initially, they result in lower doses than I-131 because of their shorter half-lives. I-132 persists in appreciable amounts longer than its half-life would indicate, because it is produced mainly from tellurium-132 which has a half-life of 78 hours. The doses from and I-132 and I-133 can exceed I-131 near the explosion site for the first week. (R. J. Garner and R. Scott Russell, "Isotopes of iodine", in *Radio activity and Human Diet*, 1966.)

Shapley Page 11.

Iodine is readily absorbed through any moist skin or mucosal surface, and essentially all that is ingested is absorbed. The amount of radioiodine taken up by the thyroid is closely dependent on the dietary level of stable iodine. About 20% of the intake ends up in the thyroid. Most of the iodine in man is excreted via the urine, and its biological half-life is 2-4 months. The effective half-life is a little less than its physical half-life, 7.6 days. Iodine is actively concentrated in the thyroid, that means that the concentration in the thyroid is much higher than in plasma.

Since thyroid is relatively small, 20 g, it doesn't take much to damage the gland. The first type of damage is nodules, then cancers and if the dose has been extremely high, destruction of the tissue itself. The result of the last case is hypothyroidism. Radiation induced cancers are almost invariably less malignant than the usual type that aren't induced by radiation. It is, therefore, believed that radiation increases the number of cancers but does not increase mortality as a whole. (Diane G. Crocker, "Nuclear reactor accidents - the use of KI as a blocking agent against radioiodine uptake in the thyroid," *Health Physics*, 46:1265-1279, 1984.)

There is a lot of literature on I-131 as well as on potassium iodide (KI) as a means of preventing the uptake of radioiodine by the thyroid. The reason is that potentially there could be high releases of I-131 from nuclear power plant accidents. Windscale accident in England resulted in the withholding of milk from the market for a while. Initial exposure in such cases is from inhalation, but the subsequent dose from eating contaminated food is 400-700 times higher. The main source of I-131 in human diet is milk,



partly because milk is consumed relatively fresh.

Both KI and potassium iodate (KIO<sub>3</sub>) can be used to saturate the iodine uptake system of the thyroid. The advantage of KIO<sub>3</sub> is that it has a much longer shelf life,

Shapley Page 12.

up to 10 years, versus about 2 years for KI. Inside the body I<sup>131</sup> gets quickly converted to I<sup>-</sup> and acts the same way as if originally it had been KI. About 130 mg of KI completely blocks radioiodine uptake for about 24 hours, 65 mg of KI is probably sufficient for children. It is most effective if given shortly before to 1-2 hours after exposure. The effectiveness of KI decreases rapidly with time after exposure, limited benefit is possible up to 12 hours after a single exposure. KI can be bought at drugstores without prescription in the U.S.

Unfortunately, there are side effects to taking large quantities of KI. It is only when the exposure level is 10 rem that the risk from radiation damage exceeds the risk from KI. In geriatric or coronary patients the hazard from KI might be greater than the radiation hazard under any circumstances. Asthmatics, chronic heart or renal failure patients, patients with hypocomplementemic vasculitis and autoimmune related diseases have reacted very severely to KI treatments. The fetus and the newborn are also susceptible to harmful effects. Unfortunately, this group is also more susceptible to the adverse effects of radioiodine. (Diane G. Crocker, *ibid.*)

The half-life of I-131 is too short for absorption from the soil or from the plant base to be major routes of entry into the food chain. The interval between grain harvesting and consumption is long enough that one doesn't have to worry about iodine. When iodine is deposited on leaves of plants, most of it is not absorbed. A lot of it can be washed off by rain or removed by mechanical processes. All of the above explains why a cow eating grass directly is the main entry route of iodine into the food chain. Levels of contamination in milk have frequently decreased more rapidly than the physical half-life of I-131. This is due to "field-loss" factor. In one case, the activity decreased by a factor of 2 in 2 weeks compared to the loss due to physical decay.

Shapley Page 13.

Fraction of ingested I-131 taken up by the thyroid can vary quite a bit but it is approximately 20% in cow as well as man. I-131 starts appearing in milk in 30 minutes and reaches maximum within 12 hours after a single exposure. The kind of conditions that would be true after a nuclear war, it would be 2-4 days after the start of fallout that it would reach the maximum concentration in milk. Both the cow's udder and the human breast concentrate iodine into milk in relation to the blood iodine level.

I-131 can also be incorporated into egg yolks in chickens on free range. After Windscale accident the activity of I-131 per egg averaged approximately 1/20 of that per litre of milk. (R. J. Garner and R. Scott Russell, *ibid.*)

If iodine were deposited in winter, the iodine hazard would be greatly reduced. The highest levels of contamination occur when the cows are grazing or are fed recently cut herbage. Contamination decreases markedly when stored food is substituted. From this it can be seen that the greatest danger would be right at the haying season. Previous year's stocks would have been exhausted and the next year's stocks wouldn't be in the barn yet.

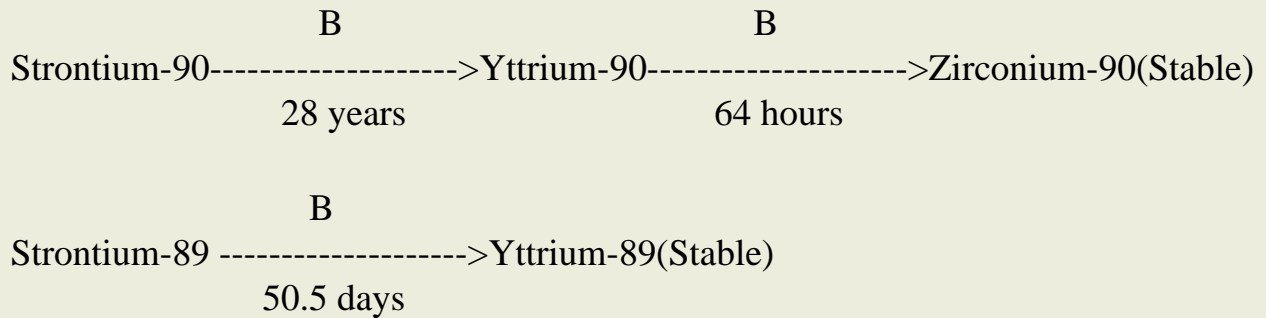
Summary of the proposed protective measures:

1. Removal of lactating cows from pasturage-feeding system and substitution of stored feed rations. I-131 is reduced to insignificant levels in 3-4 days. The reverse is true if cows are placed on contaminated pasture. If cows were in and kept in when the fallout started, no problem would arise.
  2. Withholding contaminated product to allow radioactive decay.
  3. Supplying milk to areas of high contamination from areas where contamination is low.
  4. Diverting contaminated milk into manufactured products and substituting processed milk, e.g., powdered or canned milk.
  5. Storage of frozen fresh milk.
- Shapley Page 14.
6. Storage of fresh concentrated milk.
  7. Storage of frozen concentrated milk.
  8. Physical removal of iodine-131 from milk with ion- exchange resin.

(Frank A. Todd, "Protecting foods and water against radio- active contamination," pp. 235-256, *Protection of the Public in the Event of Radiation Accidents*, World Health Organization, 1965.

All of the above, except #1, are completely dependent on the availability of electricity and transportation. Number one is partly dependent on transportation. If there was no electricity, the cows would not be milked. We don't have the personnel who know how to milk cows. So you could learn it in a day, but there is no way you could develop the strength in a short time to milk more than one cow. I called up the local dairy farmer to ask what they would do if there was no electricity. They have 40 cows and they would not be milked unless they obtained a generator. They have had to do that once in the past. Their milk goes down to Guelph, that is more than 100 km away. There are 2 small cheese plants that are a little closer, but she couldn't think of any milk processing plant that would be closer.

*Strontium.* There are two types of strontium (Sr). Sr-89 is important the first month and Sr-90 is important for a long time. Both emit only B rays.



Strontium is metabolized the same way as calcium (Ca). Strontium absorption, however, is discriminated against by body, compared to calcium absorption. Ratios of Sr/Ca in blood is 1/3 to 1/4 of what it is in diet. Mother's milk has half the Sr concentration in blood and the fetus

Shapley Page 15.

also has only half the concentration. The effective half-life in body is 50 days for Sr-89 and 17.5 years for Sr-90. (Cs also has a long half-life but its effective half-life in body is less than 100 days.) Its long effective-half life is what makes Sr-90 such a dangerous radionuclide.

Ratio of Sr to Ca in new bone is in equilibrium with body fluids. In other words, the amount of strontium that gets deposited in bone is dependent on the ratio of Sr/Ca in blood. Therefore, radiostrontium concentration is a lot of times expressed in terms of Ca concentration. The common units are pc of Sr/g of Ca or for milk pc Sr/l.

The main source of strontium in a western diet is dairy products. But that doesn't give the whole picture. As explained above, strontium absorption depends on the level of calcium and dairy products are also the major source of calcium in western diets. It might look like elimination of dairy products would improve the situation but the reverse would be true. More vegetables would be consumed and there the ratio of Sr/Ca is much higher. Third world countries got twice the amount of strontium in their diets compared to that of the western countries.

**The following table of contribution of various foods to Sr-90  
in population of N.Y. City  
illustrates the differences in calcium levels  
and their subsequent effect.**

Food	pc/yr	% total intake	% total intake
		----- ca	----- Sr-90
<b>Dairy products</b>	<b>2080</b>	<b>58</b>	<b>38</b>
<b>Vegetables</b>	<b>1212</b>	<b>9</b>	<b>22</b>
<b>Fruits, fresh and canned</b>	<b>1192</b>	<b>3</b>	<b>22</b>
<b>Cereals and bakery products</b>	<b>588</b>	<b>20</b>	<b>11</b>
<b>Meat, poultry eggs</b>	<b>178</b>	<b>8</b>	<b>3</b>
<b>Fish</b>	<b>5</b>	<b>2</b>	<b>-</b>
<b>Water</b>	<b>200</b>	<b>-</b>	<b>4</b>

*Radionuclides in Foods*, p. 34, National Academy of Sciences, 1973.

Shapley Page 16.

In vegetables the strontium content can be reduced 19-55% by common home preparation. In canned fruit the reduction can even be higher compared to fresh fruit. The following are given as methods for reducing strontium intake.

1. Protection of packaged and stored foods.
2. Removal of surface contamination by washing and scrubbing of fruits and vegetables.
3. Removal of surface contamination by peeling.
4. Removal of internal contamination of food through processing.
5. Reduction of strontium-90 secretion into milk by supplementing rations of dairy cows with calcium.
6. Removal of radioactivity by use of such processes as ion-exchange, electro dialysis, or calcium phosphate treatment.

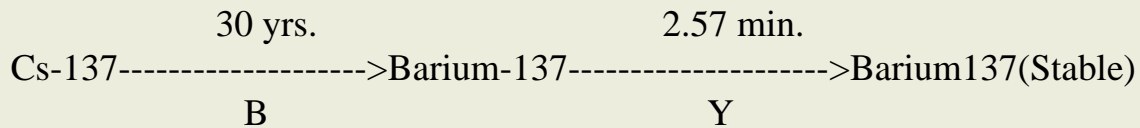
Frank A. Todd, *ibid*. One important method Todd doesn't mention is milling of wheat. Whole wheat has twice the Sr/Ca than white flour.

There is a good discussion of remedial measures by C. L. Comar and J. C. Thompson, Jr. with emphasis on "certain aspects of feasible large-scale measures" in *Survival of Food Crops and Livestock in the Event of Nuclear War*, 1970, "Status of remedial measures against environmental radiocontamination".

The plant root makes little distinction between Ca and Sr if they are in the same chemical form. Soluble Ca in the soil acts as a diluent for the Sr - the amount of calcium in soil is important. Generally good agricultural soils result in lower Sr content in food. Strontium deposited on the plants may be trapped and absorbed through those parts of the plant which are above the ground. The amount that is so trapped depends on the form of the plants, it is usually considerable in grasses. Again, a cow comes along and picks it all up, the absorbed and the unabsorbed Sr. Luckily, there is discrimination against strontium relative to calcium by a factor of about 10 which occurs in the transfer of the two elements from the diet of cattle to milk.

Shapley Page 17.

*Cesium.* Cesium (Cs)-137 is the third most dangerous radio-nuclide that enters very quickly the human food chain after a nuclear fallout. It is an alkali metal like potassium (K) and its behaviour in nature as well as the human body is similar to that of potassium. The relationship between the two, although, is not as close as between Sr and Ca. The decay scheme of Cs-137 is shown below.



Cesium is around in the environment for a long time, its half-life is 30 years. Quite commonly Cs is referred to as a Y source. Technically this is not correct. Cs decays by a B emission to Ba-137 which has a half-life of only 2.57 min. when it decays by a Y emission to a stable form of Ba. Its "daughter", however, has such a short half-life that Cs is ordinarily identified by Y spectrometry of the Y emission of its daughter. Cs is more common in fallout than Sr by 1.3 to 1.7.

Cesium is freely absorbed from the human intestinal tract and appears to have an average stay of 4 months.. Compared to other radionuclides, it is distributed fairly uniformly over the body. The human body content of Cs-137 is closely related to the level of it in the diet. It is absorbed preferentially to potassium. The ratio of Cs-137/ gK is 3 times higher in body than in food. In animal studies one has to take 9 times the normal level of K to cut Cs-137 level by half. L. Fredriksson, R. J. Garner and R. Scott Russell , "Caesium-137", in *Radioactivity and Human Diet*, 1966.

Sources of Cs in human food:

Cows milk 30% or 25-40%

Grain products 25% or 17-30%

Meat 20% or 12-26%

Fruit 10% or 15%

Vegetables 10% or 15%

Fish important where it forms a large part of diet,

Shapley Page 18.

The two sets of figures just given are from two different sources. They indicate that cesium is distributed relatively evenly among the different food groups.

Because cesium has volatile precursors, a lot of it ends up in stratosphere. Very roughly its mean time in stratosphere is 2 years. As it falls down, it is deposited on any growing vegetation. Most of the Cs that enters the food chain is absorbed by the plants directly and not from soil after it has been washed down. The heaviest fallout occurs in spring because most of the mixing between stratosphere and troposphere occurs during late winter. Areas with higher rainfall can receive twice as much fallout.

Cesium is readily absorbed by clay particles in soil. It is held tightly enough that only a few per cent of Cs-137 in soil is taken up through the roots of plants. Sandy soils and especially soils with a high content of organic matter bind Cs less effectively. Plants grown on these soils have higher Cs-137 content. Most of the Cs contained in the edible parts of vegetables is due to deposition of particulate material on leaves.

Under certain conditions, Cs can undergo considerable concentration in terrestrial and aquatic food chains. Freshwater fish have been shown to contain it in concentrations several thousand times higher than the concentration in their surroundings. Fish feed on lower aquatic organisms which have already concentrated it above the levels present in water. Shellfish do the same thing. Cesium is effectively trapped and retained by the lichen and moss of the tundra, which are major sources of food for caribou and reindeer. Caribou flesh contained up to 100 times the quantities found in meat in mid latitudes.

Once fallout has stopped Cs becomes trapped in the top 2 cm of soil. External radiation from it would continue for many years. Its greatest danger is considered to be genetically.

Shapley Page 19.

*Carbon-14.* Most of the carbon (C)-14 is released into the stratosphere, from where it equilibrated with the troposphere with a half-time of about 2 years. Tissue C-14 comes into equilibrium with C-14 in the atmosphere with a delay time of about 1.4 years. The retention half-time of dietary carbon in mammals is estimated to be about 40 days. Like tritium, carbon 14 is highly mobile in the environment and no one can do anything about it.

*Tritium.* Tritium is radioactive hydrogen. Less than 1% of tritium becomes part of the water molecule but it is in this form that it passes through the eco-systems. It behaves identically to ordinary water. It is

highly mobile in the environment and very quickly equilibrates in the different systems.

*Iron-55.* Two pathways are known for the concentration of iron (Fe)-55. Lichen-caribou pathway is important for Eskimos and Lapps. The second source is marine fish. The marine food chain concentrates Fe-55 even more than the first pathway. The reason for this is the low concentration of stable iron in sea water.

Half-life of Fe-55 in lichens is 1.4 years.

Erythrocyte is considered to be the critical organ.

*Ruthenium-106.* Ruthenium is known to have accumulated in at least one known food chain. A seaweed in Irish sea that is used by some people in making bread. Critical organ for this case is the lower large intestine. Some people got as much as half the yearly dose limit of rems/yr for lower intestine during the Windscale accident.

# METHODS OF MEASUREMENT

Shapley Page 20

There is a lot of literature on the measurement of Sr-89 and -90, I-131 and Cs-137 in the environment and in food. Scientists have been doing it all over the world as the result of the atomic bomb tests in the fifties and the first part of the sixties. The most comprehensive references are: Esther Ferri, Paul J. Magno and Lloyd R. Setter, *Radionuclide analysis of large numbers of food and water samples*, U.S. Dept. Health, Education, and Welfare, 1965. National Center for Radiological Health, *Radioassay Procedures for Environmental Samples*, U.S. Dept. of Health, Education, and Welfare, 1967. *Manual of Standard Procedures*, NYO-4700, Health and Safety Laboratory, U.S. Atomic Energy Commission, New York Operations Office. The above do give details for the procedures but are designed for quantities much smaller than what one would be measuring after a nuclear war. They require highly skilled personnel and very sophisticated equipment.

E. R. Mercer ("Analytical Methods" in *Radioactivity in Human Diet*, ed. R. Scott Russell, 1966.) has a short but clear review of the above methods. He says that in emergencies, when much higher levels of contamination than normal will be acceptable, much simpler analytical methods are adequate. Unfortunately he doesn't describe them. This happens quite a few times, they aren't described because they are obvious to people who work with radioactivity but not so obvious for a person who doesn't have

any experience using different radiation detection instruments or measuring mixtures of different radionuclides. He does make a few relevant comments in passing. If Cs-137 exceeds 300 pc/l in milk, it can be measured directly in a sodium iodide (NaI) crystal scintillation counter. Gamma spectrometric measurement of I-131 can also be done directly on whole milk if the level is high enough. Cesium and iodine can also interfere with each other.

Strontium assays are very complicated, numerous radiochemical separations have to be done. Usually Sr-90 is

Shapley Page 21.

calculated from the amount of its daughter yttrium-90 (Sr-90 decays to Y-90) and Sr-89 is determined by the difference.

Daniel A. Collnick does give a simple method for analyzing, milk (*Experimental radiological health physics*, 1978). Since the ratio, of Cs-137 to each of the Sr isotopes is a fixed constant at the time when fission takes place, the strontium concentrations can be calculated from the cesium concentration.

$$\frac{\text{Cs-137}}{\text{Sr-90}} = 5 \qquad \frac{\text{Cs-137}}{\text{Sr-89}} = 0.03$$

First of all, these formulas are for milk, in the fallout Cs-137 to Sr-90 ratio is about 1.6. Second, Sr-89 has a relatively short half-life compared to Cs-137, so the ratio changes with time, it has to be doubled every 51 days after the fissions have occurred. Cs-137 and Sr-90 have similar enough half-lives that the change with time can be ignored.

The milk is passed through an anion exchange resin. I-131, being the only anion in the group of 4 we are interested in, is retained on the resin and everything else passes through. Resin is transferred to a bottle that is counted in a solid scintillation counter. The result is calculated from a known I-131 sample that has been treated the same way. The strontium isotopes are pure beta emitters, therefore, the effluent can be poured into a beaker that fits into a NaI counter and counted for gamma emissions from cesium. The result is compared to a known amount of Cs-137 under the same conditions. The cesium value is used in the formulas given above to calculate the amounts of the two different strontiums.

Collnick also gives the following very useful table of what would be the dose commitment from milk, given a level of activity in milk when it is at the highest (2-4 days after the event). There must be, however, some mistake in rads for Sr-89. If it is 3 rads in the first year, there is no way with its short half-life it can give 2 more rads in subsequent years.

Shapley Page 22.



## Dose Commitment from Milk

Radionuclide	RADS	Max. conc. in milk uc/l,p
<b>Sr-89</b>	<b>3 in 1st yr, 5 total</b>	<b>1.1</b>
<b>Sr-90</b>	<b>3 in 1st yr, 5 total</b>	<b>0.05</b>
<b>I-131</b>	<b>10</b>	<b>0.07</b>
<b>Cs-137</b>	<b>3 in 1st yr, 5 total</b>	<b>0.72</b>

The above is the sort of approach, that I think would be taken, if there were a nuclear holocaust. There are different models for predicting dose commitment from the level of fallout. R. Scott Russel, B. O. Bartlett, and R. S. Bruce, "The significance of long-lived nuclides after a nuclear war," in *Survival of Food Crops and Livestock in the Event of Nuclear War*, 1970. A. Aarkrog, "Prediction models for Strontium-90 and Caesium-137 Levels in the Human Food Chain", *Health Physics*, 20:297-311, 1971. W. F. Lengeman has many papers on prediction models. The measurement would be done from an airplane or for more detail from a car. A. C. Chamberlain, R. J. Garner and D. Williams, "Environmental monitoring after accidental deposition of radioactivity," *React. Sci. Technology*, 14:155-167, 1961.

There are some references that sound good but are not easily available. *Guidance on Offsite Emergency Radiation Measurement Systems, Phase 2: The Milk Pathway*, B. J. Salmonson, L. G. Hoffman, R. J. Honkus, and J. H. Keller, Westinghouse Idaho Nuclear Company, Inc., WINCO-1009, April 1984. Also by the same people, company and title but a different subtitle: *Phase 3: Water and Non-Dairy Food Pathway*, WINCO-1012, October 1984. I wanted to send for these two papers but I couldn't find Westinghouse Idaho Nuclear Co. listed in any of the industrial indexes. The closest I could get is that Westinghouse does have a subsidiary called Bettis Atomic Power Lab, Idaho Falls, Idaho (1-208-526-0111). It could be the same company.

Shapley Page 23.

Daniel A. Gollnick also has a book out *Basic Radiation Protection Technology*, Pacific Radiation Press, 1983. It isn't available in Toronto. It might have the type of information we are interested in because it has been referred to in places where the concern has been nuclear war.

# LACK OF STANDARDS AND MPD

Shapley Page 24

Currently there aren't any guide lines for intake of radioactive material under the conditions of a nuclear war. The main reason for this is that radioactivity in food is not regarded as a priority in an event of a nuclear war.

"Eating food produced in the years after a large attack would cause an increase in the cancer rate... this increase would be a small fraction of the number of additional cancer deaths that would result from external radiation." Cresson H. Kearney, *Nuclear War Survival Skills*, p. 65, 1980.

Most vegetables would be fit to eat once they had been thoroughly washed. When it is safe to work outside, can plant new crops - they will be safe to eat. Ivan Tyrell, *The survival Option, A guide to living through nuclear war*, 1982.

"Standing crops in the early stages of growth are damaged by radiation but otherwise are safe to eat if washed clean of dust." p. 105. "Lack of food and water will cause starvation and death of many millions, especially the young and old." p. 115. Diane Diacon, *Residential Housing and Nuclear Attack*, 1984. The latter two books are English and I don't know anything about the credentials of their authors. The quotes that follow are by R. Scott Russell, unquestionably one of the world authorities on strontium and cesium in fallout and their biological pathways.

"In short, the total deaths caused by long-lived nuclides seem broadly comparable to the annual traffic death rate." (Incidentally, the figures for lung cancer from smoking are higher than traffic fatalities.) "Thus, by the standards the community now accepts, remedial action against the risks from long-lived nuclides would not seem justified; The number of casualties would be so small relative to the total loss and the difficulty of avoiding them would be so great that remedial action could not

Shapley Page 25.

reasonably be contemplated." "...efforts to mitigate doses from radiation should be devoted solely to the early period when short-lived nuclides predominate."

R. Scott Russell, B. Bartlett, and R. S. Bruce, "The significance of longlived nuclides after a nuclear war," in *Survival of Food Crops and Livestock in the Event of Nuclear War*, 1970.

The maximum permissible doses (MPD) used now are based on the philosophy that any radiation is bad and the less the better. Dose limiting recommendations by the National Council on Radiation Protection (NCRP) are given in Table 6.1. The levels are very low, for general population, 0.17 rem/year. This is less than the natural background radiation in some places.

There certainly is awareness that maximum permissible doses are not what would be in effect after a nuclear holocaust.

J. C. Thompson, Jr., R. A. Wentworth, and C L. Comar ("Control of fallout contamination in the postattack diet," in *Survival of Food see: (...above1, ...above2, ...above3)* expressed the need for guidelines that respond to tolerance or survival levels of radioactivity rather than the minimum-exposure concept that is in effect now. They would like to have a "system of radiation-exposure priorities" that would become operational after a nuclear attack. They are aware of the irony that the larger the attack, the lower the priority of fallout considerations in food.

"It would be poor operational procedure to initiate efforts to reduce dietary contamination from 10 R to 1 R when general external radiation levels were 100 R and a state of pestilence threatened."

The problem of lack of radiation protection standards designed for nuclear war conditions has been discussed by Lauriston S. Taylor in "Standards for radiation exposure management in accident or nuclear attack," a talk he has given at some recent symposium. (I don't have a complete reference, the paper was sent to me.) The same as J. C. Thompson *et al*, he recognizes that there can really be no fixed standards that can be applied to basically uncontrollable

Shapley Page 26.

328 *Radiation Protection* by Jacob Shapiro

**Table 6.1. Dose-limiting recommendations of N C R P (1971).**

**Occupational exposure limits**

**Whole body, gonads, lens of eye, red bone marrow**

**5 rem in any one year**

**Skin**

**15 rem in any one year**

**Hands**

**75 rem in any one year (25/qtr)**

**Forearms**

**30 rem in any one year (10/qtr)**

**Other organs, tissues and organ systems**

**15 rem in any one year (5/qtr)**

**Fertile women (with respect to fetus)**

**0.5 rem in gestation period (5/qtr)**

<b>Dose limits for the public, or occasionally exposed individuals</b>	
<b>Individual or occasional</b>	<b>0.5 rem in any one year</b>
<b>Students</b>	<b>0.1 rem in any one year</b>
<b>Population dose limits</b>	
<b>Genetic</b>	<b>0.17 rem av per year</b>
<b>Somatic</b>	<b>0.17 rem av per year</b>
<b>Emergency dose limits-lifesaving</b>	
<b>Individual (older than 45 yr if possible)</b>	<b>100 rem</b>
<b>Hands and forearms</b>	<b>200 rem, additional (300 rem total)</b>
<b>Emergency dose limits-less urgent</b>	
<b>Individual</b>	<b>25 rem</b>
<b>Hands and forearms</b>	<b>100 rem total</b>
<b>Family of radioactive patients</b>	
<b>Individual (under 45 yr)</b>	<b>0.5 rem in any one year</b>
<b>Individual (over 45 yr)</b>	<b>5 rem in any one year</b>

Source : NCRP, 1971, Table 6.

Shapley Page 27.

radiation situations. The best that we have are what is called "penalty tables". The following is based on

brief, whole body gamma-ray doses:

Dose	Need Medical Care	Able to Work	Die
<b>15-50 R</b>	<b>no</b>	<b>yes</b>	<b>0</b>
<b>50-200 R</b>	<b>no</b>	<b>yes</b>	<b>&lt;5%</b>
<b>200-400 R</b>	<b>yes</b>	<b>no</b>	<b>&lt;50%</b>
<b>450-600 R</b>	<b>yes</b>	<b>no</b>	<b>&gt;50%</b>
<b>&gt;600 R</b>	<b>yes</b>	<b>no</b>	<b>100%</b>

The above is the kind of data that is available but that is not what the situation would be after a nuclear war. There would be a long period of high radiation level followed by even longer period of moderate radiation levels. The following table is a little more useful:

Category	Need Medical Care	Accumulated Exposure in: 1 Week	Accumulated Exposure in: 1 Month	Accumulated Exposure in: 4 Months
<b>A</b>	<b>None</b>	<b>150 R</b>	<b>250 R</b>	<b>300</b>
<b>B</b>	<b>Some (5% die)</b>	<b>250 R</b>	<b>350 R</b>	<b>500</b>
<b>C</b>	<b>Most (50% die)</b>	<b>450 R</b>	<b>600R</b>	<b>--</b>

Lauriston S. Taylor, *ibid.*

There is very little information on *chronic* exposures that scientists could use to develop emergency standards. Needless to say, there is even less information on continuous internal intake of low or large amounts of radioactivity (the only exception is the radium dial painters). Japan did not have any early fallout in 1945. From the Japanese data and past medical uses of radioactivity it is known how many people would get leukemia and other cancers if a certain number of people would be exposed to a certain level of radiation. From this is derived a linear dose-effect relationship without a threshold. Both NCRP and ICRP (International Commission for Radiological Protection) work on assumption that there is no threshold dose of ionizing radiation below which there is no damage. The dose

Shapley Page 28.

effects are assumed to be additive. Taylor does not think it would be true for long range, low or moderate level chronic exposures. Too many theoretically dead persons are still walking around, as he puts it. There are many people who have been working for years within the maximum permissible dose limits for radiation workers. None of them have had any effects of practical importance. He feels the limits could

be 10 times for more higher before there would be any detectable consequences. Taylor blames the lack of war time radiation guidelines on the media and the public. He feels that the news media have so over-exploited radiation matters that the public is truly frightened of *any* radiation exposure.

"This makes the presentation and public acceptance of any kind of emergency planning extremely difficult."

(There is an analogous phenomenon going on right now. 130 people have died so far from AIDS in Canada. At the same time 4000/yr. die in car accidents, plus many more permanently crippled. Half of the latter are caused by alcohol. Yet the public accepts one but is panic stricken of the other.)

Maximum permissible body burdens, plus all the other dose limits have been developed by the International Commission on Radiological Protection (ICRP) and the National Council on Radiation Protection (NCRP). The body burden of a particular radioactive nuclide is the amount of the nuclide in uc which is present in an individuals body. The maximum permissible body burden is the body burden of a particular radioactive nuclide which results in a MPD (Maximum permissible doses that have been developed for external exposure) to the whole body or to one or more organs in the body. It is computed on the basis that it is the only one in the body. The maximum permissible body burden for a radionuclide of a bone seeking element (e.g. strontium, calcium, radium and plutonium) is the number of uc required to deliver to the bone a dose in rems equal to that provided by 0.1 uc of radium-226. Body burdens

Shapley Page 29.

for radionuclides other than bone seekers require the identification of "critical organ" (the organ which is the most sensitive or has the highest concentration). For a nuclide with the whole body as the "critical organ", the maximum permissible body burden for occupational exposure is the activity present continuously in the body which delivers a dose equivalent of 5 rem/year to the whole body. Nuclides which concentrate in abdominal organs are given limiting body burdens which provide 15 rem/year. (Kedar N. Prasad, *CRC Handbook of Radiobiology*, p. 241, 1984.)

Maximum permissible body burdens and maximum permissible concentrations of radionuclides in water for occupational exposures are given in ICRP publications (for references see *Radiation Protection by Jacob Shapiro*, 1981. The following values for the radionuclides that enter the food chain as a result of a nuclear fallout are from *Radiological Health Handbook*, U. S. Dept. Health, Education and Welfare, p. 207, 1970.

Radionuclide	Critical organ	Body Burden uc	MPC water continuous intake uc/cc

<b>Sr-89</b>	<b>Bone</b>	<b>4</b>	<b><math>10^{-4}</math></b>
<b>Sr-90</b>	<b>Bone</b>	<b>2</b>	<b><math>10^{-6}</math></b>
<b>Cs-137</b>	<b>Total body</b>	<b>30</b>	<b><math>2 \times 10^{-4}</math></b>
<b>I-131</b>	<b>Thyroid</b>	<b>0.7</b>	<b><math>2 \times 10^{-5}</math></b>

Given equal concentrations, Sr-90 is 100 times more dangerous than Sr-89. The differences can even be higher, radium-226 is 10,000 times more dangerous than tritium.

ICRP Publ. 2 *Report of Committee II Permissible Dose for Internal Radiation*, Pergamon Press, p. 23-27, 1959 talks about permissible concentration of unidentified radionuclides, mixtures of known radionuclides and some of the problems one would run into if one tried to apply the occupational MPC for water to fallout in water and food.

Shapley Page 30.

Assuming Taylor was right that the external doses could be raised 10 times without much danger, the same thing would also apply here. Iodine and strontium -89 could still be increased by much more because of their short half-lives. The figures given were for continuous intake for 40 years. Although one can take in 100 times more Sr-89 than Sr-90, it initially occurs in 180 times the greater concentration than Sr-90. That is why initially it is the more important. Its half life is 51 days and after that Sr-90 becomes the most important contaminant. Unfortunately, strontium is the hardest to measure.

# EMERGENCY SCHEMES

Shapley Page 30

The only permissible emergency levels of radioactivity in food and water for civilians were put out by the United States Agricultural Research Service in 1960, *USDA Radiological Training Manual for Inservice Training*. This procedure was still recommended by the U.S. Dept. of Health, Education and Welfare in 1965, *Civil Defense information for food and drug officials*. I haven't come across anything, that would have replaced this procedure.

There is a food and water standard (CDV-787) that is placed in a standard tin. A Geiger-Mueller counter is placed on top of the tin and a reading is taken, should be in 10 to 15 mr/hr area. The tin is filled with food or water when an unknown is tested. Anything below the standard reading is fit for a 10 day consumption. Anything below 2/3 of the standard reading is fit for 30 day consumption period. The values that they represent are  $9 \times 10^{-2}$  uc/g and  $3 \times 10^{-2}$  uc/g for 10 and 30 day consumption periods respectively.

There is a more extensive emergency scheme by J. D. Teresi and C. L. Newcombe, "Calculations of maximum permissible concentrations of radioactive fallout in water and air based upon military exposure criteria," *Health Physics* 4:275-288, 1961. Although this is for water, I think it would also be applicable to directly contaminated food. Permissible levels for food and water are always the same in literature. It would not be applicable to food grown on contaminated soil. Their figures are based on the 14 major contributors in the fallout mixture. This is subdivided in 3 groups: major contributors for the first 7 days, major contributors for 8 - 104 days and major contributors for 105 - 365 days after the explosion.

Shapley Page 31.

On this basis they calculate the allowable  $\mu\text{g}/\text{cm}^3$  to give 15 rem in 90 days, eaten in 7 different time spans, from 1 to 90 days and starting at 11 different times after time 0, from 3.5 hrs to 365 days. See their [Table 6](#). They do the same thing for 150 rems in 30 days. See their [Table 7](#). The tables can be used to get values for any other dose e. g., if you want 75 rem dose in 30 days, divide the value by half. They don't say what standard would be used to determine  $\mu\text{g}/\text{cm}^3$ . I am concerned that the data on which they based their calculations would be outdated. They submitted their paper for publication Nov 1959. The atomic weapons have changed since that time - the fission products would not be in the same proportions now. For example, cesium is not mentioned. There would also be a better idea of the biological effect of some of these radionuclides in 1985.

There are two other methods for emergency monitoring of drinking water. G.W.C. Tait and W. F. Merritt, "Emergency monitoring of drinking; water", *Health Physics* 1:164-168, 1958. See their [Table 5](#).

Dept. of National Health and Welfare (Ottawa), *Control of radioactive fallout in water systems*, 1965, on (p.81) have presented Teresi and Newcombe's 90 day scheme in form of a graph. Whatever the time after explosion, up to a year, one can read off the values for water contamination that would deliver 15 rems in 90 days. They also give a number of handy approximations to know. Curies of beta particle radioactivity = 2 x curies of gamma ray radioactivity for the first 3 months (ibid. p.7). One day following a nuclear detonation: curies of gamma radioactivity per sq. ft. = roentgens/ hr divided by 100.

Shapley Page 32

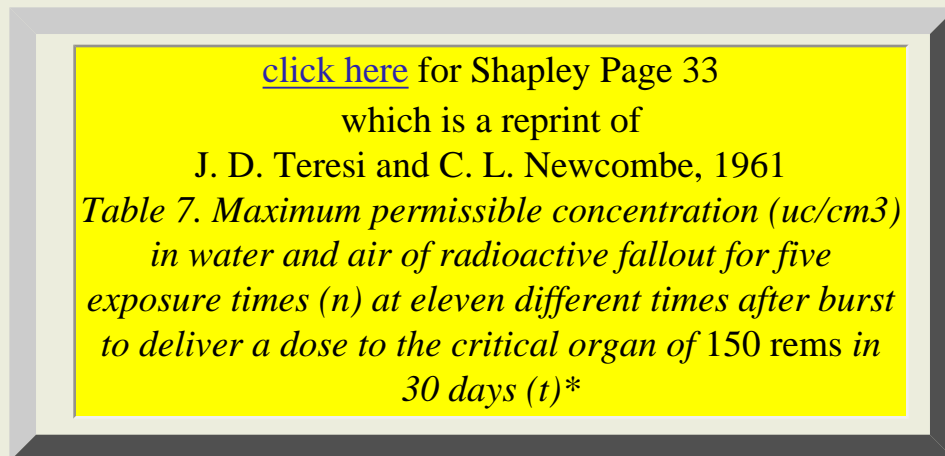
[click here](#) for Shapley Page 32

which is a reprint of

J. D. Teresi and C. L. Newcombe, 1961

*Table 6. Maximum Permissible concentration ( $\mu\text{g}/\text{cm}^3$ ) in water and air of radioactive fallout for seven exposure times (n) at eleven different times after burst to deliver a dose to the critical organ of 15 rems in 90 days (t)*





## 168 EMERGENCY RADIATION MONITORING OF DRINKING WATER

**Table 5:** *Field measurements mr/hr for maximum permissible water contamination.*

This table applies to any fresh fallout contamination and is for 10 day consumption. Values should be halved for 30 day consumption.

Water body	12hr_1 day_2 days_10 days
<b>Reservoir or lake, measured far from shore.</b>	<b>100_____50_____25_____12</b>

<p><b>Reservoir pond, etc., measured at arms length from shore, close to surface and over water at least 2ft. deep.</b></p>	<p><b>50 _____ 25 _____ 12 _____ 6</b></p>
<p><b>Water tank, from 150 to 1000 gal., measured in contact with center of one surface.</b></p>	<p><b>50 _____ 25 _____ 12 _____ 6</b></p>
<p><b>Water tank, from 2 to 4 gal.</b></p>	<p><b>25 _____ 12 _____ 6 _____ 3</b></p>

G.W.C. Tait and W.F. Merritt

"Emergency monitoring of drinking; water", *Health Physics* 1:164-168.

1958

**MENU:** [HOME](#) » [Reconstruction](#) » [Recovery](#) » [Renewal](#) » [Survival](#)

---

---

*From: p. 23/243 of OTA, The effects of nuclear war*

*Absolute risk* is defined as the product of assumed relative risks times the total population at risk. *Relative risk* is defined as the ratio of the risk in those exposed to the risk to those not exposed. The difference between the two risk models leading to major differences in the projected number of cancer deaths lies in the calculated excess of cancers arising from the 0 - 9 years age group at the time of irradiation. Because data on relative risks are sparse and inconclusive, and more data exist supporting the absolute model, the absolute model was used to calculate the latent health effects. Also, because the effectiveness of low exposure rates and/or low radiation exposure doses for producing late health effects remains unresolved, projected cancer deaths were calculated with dose effectiveness factors (DEF) of 1.0 and 0.2 for low exposure rates and doses.\* (see below) Also, because there is insufficient data to warrant limiting the risk plateau period to 30 years, a 40 year risk period was used. 9)([see Shapley page 9](#)) Estimates of radiation genetic risks are also uncertain. Reference 8([see Shapley page 9](#)) estimates that the doubling dose for genetic risks to be between 20 and 200 rems although the possibility of it being lower than 20 rems or higher than 200 rems is not dismissed. Since a doubling dose of 100 rems was suggested by Reference 6 ([see Shapley page 9](#)) and it is within the estimated range of Reference 8, ([see Shapley page 9](#)) it was used to project the genetic risks. It follows that if the doubling dose is 20 rems then the projected number of genetic disorders (spontaneous abortions and "other genetic effects") should be multiplied by 5, and if the doubling dose is 200 rems then the projected number of genetic disorders should be halved.

**The (resulting) projected latent health effects  
from radiation exposures using a DEF=1  
for cancer deaths (are as follows):**

\* Multiply by 0.2 for DEF = 0.2

<b>EFFECTS</b>	<b>Number per 10<sup>6</sup> person rems</b>
<b>Cancer deaths*#####</b>	<b>194.3</b>
<b>Thyroid cancers</b>	<b>134.1</b>

<b>Thyroid nodules</b>	<b>197.4</b>
<b>Spontaneous abortions</b>	<b>42</b>
<b>Other genetic effects</b>	<b>132.4</b>

\* A DEF=0.2 implies that the radiation received is only one-fifth as effective per unit of dose for producing latent effects when compared to a high dose received over a short period of time.

Shapley Page 3

*From: p. 24/244 of OTA, The effects of nuclear war*

**Projected latent cancer deaths  
from internal organ exposures (are as follows):**

<b>Organ</b>	<b>Cancer deaths per 10<sup>6</sup> organ rems</b>
<b>Marrow</b>	<b>45.4</b>
<b>Lung</b>	<b>35.5</b>
<b>Digestive</b>	<b>27.1</b>
<b>Bone</b>	<b>11</b>
<b>Other</b>	<b>75.3</b>

Also, for thyroid exposures from ingested I-131, the effectiveness of the exposure is estimated to be one-tenth that of an external (gamma) exposure. 6)([see Shapley page 9](#))

**MENU:** [HOME](#) » [Reconstruction](#) » [Recovery](#) » [Renewal](#) » [Survival](#)

---

---

*From: OTA, The effects of nuclear war***LOCAL FALLOUT HEALTH EFFECTS**

	PFs=5	PFs=10	PFs=40	Mixed PFs
<b><u>EXTERNAL EXPOSURE</u></b>				
<b>Additional Shelter Fatalities</b>	21,712,000	9,441,000	327,200	---
<b>Cancer Deaths (DEF=1)</b>	2,390,000	2,099,000	1,005,000	1,720,000
<b>Cancer Deaths (DEF=0.2)</b>	2,359,000	2,082,000	993,800	1,700,000
<b>Thyroid Cancers</b>	1,650,000	1,449,000	693,500	1,190,000
<b>Thyroid Nodules</b>	2,429,000	2,132,000	1,021,000	1,750,000
<b>Spontaneous Abortions</b>	516,700	453,700	217,200	372,000
<b>Other Genetic Effects</b>	1,629,000	1,430,000	684,700	1,170,000

**INTERNAL EXPOSURE**

<b>Cancer Deaths (DEF=1)</b>	47,200	80,200	127,800	132,000
<b>Cancer Deaths (DEF=0.2)</b>	9,400	16,000	25,600	26,400
<b>Thyroid Cancers</b>	2,600	4,400	7,000	7,200
<b>Thyroid Nodules</b>	3,800	6,500	10,300	10,600
<b>Spontaneous Abortions</b>	3,100	5,300	8,400	8,700

<b>Other Genetic Effects</b>	<b>9,800</b>	<b>16,600</b>	<b>26,400</b>	<b>27,300</b>
------------------------------	--------------	---------------	---------------	---------------

**MENU:** [HOME](#) » [Reconstruction](#) » [Recovery](#) » [Renewal](#) » [Survival](#)



OTA, *The effects of nuclear war***WORLDWIDE FALLOUT HEALTH EFFECTS**

	<b>Tropos</b>	<b>Stratos</b>	<b>C-14</b>	<b>Total</b>
<b>Cancer Deaths (DEF=1)</b>	<b>360,100</b>	<b>1,543,000</b>	<b>2,886,000</b>	<b>4,789,000</b>
<b>Cancer Deaths (DEF=0.2)</b>	<b>72,000</b>	<b>308,600</b>	<b>577,200</b>	<b>957,800</b>
<b>Thyroid Cancers</b>	<b>606,800</b>	<b>1,206,000</b>	<b>1,570,000</b>	<b>3,383,800</b>
<b>Thyroid Nodules</b>	<b>893,200</b>	<b>1,776,000</b>	<b>2,311,000</b>	<b>4,980,000</b>
<b>Spontaneous Abortions</b>	<b>49,700</b>	<b>188,200</b>	<b>736,500</b>	<b>974,400</b>
<b>Other Genetic Effects</b>	<b>156,700</b>	<b>590,800</b>	<b>2,324,000</b>	<b>3,072,000</b>

**TOTAL LATENT HEALTH EFFECTS**

	<b>PFs=5</b>	<b>PFs=10</b>	<b>PFs=40</b>	<b>Mixed PFs</b>
<b>Additional Shelter Fatalities</b>	<b>21,712,000</b>	<b>9,441,000</b>	<b>327,200</b>	<b>---</b>
<b>Cancer Deaths (DEF=1)</b>	<b>7,226,000</b>	<b>6,968,000</b>	<b>5,922,000,000</b>	<b>6,640,000</b>
<b>Cancer Deaths (DEF=0.2)</b>	<b>3,326,000</b>	<b>3,056,000</b>	<b>1,997,000</b>	<b>2,680,000</b>
<b>Thyroid Cancers</b>	<b>5,036,000</b>	<b>4,836,000</b>	<b>4,084,000</b>	<b>4,580,000</b>
<b>Thyroid Nodules</b>	<b>7,413,000</b>	<b>7,119,000</b>	<b>6,011,000</b>	<b>6,730,000</b>

<b>Spontaneous Abortions</b>	<b>1,494,000</b>	<b>1,433,000</b>	<b>1,200,000</b>	<b>1,360,000</b>
<b>Other Genetic Effects</b>	<b>4,711,000</b>	<b>4,515,000</b>	<b>3,783,000</b>	<b>4,270,000</b>

<b>TOTAL LATENT HEALTH EFFECTS OUTSIDE OF THE U.S.</b>		
	<b>DEF=1</b>	<b>DEF=0.2</b>
<b>Cancer deaths</b>	<b>4,545,000</b>	<b>909,000</b>
<b>Thyroid cancers</b>	<b>3,254,000</b>	
<b>Thyroid nodules</b>	<b>4,549,000</b>	
<b>Spontaneous abortions</b>	<b>926,000</b>	
<b>Other genetic effects</b>	<b>2,919,000</b>	

OTA, *The effect of nuclear war*

**MENU:** [HOME](#) » [Reconstruction](#) » [Recovery](#) » [Renewal](#) » [Survival](#)

J. D. Teresi and C. L. Newcombe, 1961

From:

J. D. Teresi and C. L. Newcombe, "Calculations of maximum permissible concentrations of radioactive fallout in water and air based upon military exposure criteria," *Health Physics* 4:275-288, 1961.**Table 6:** Maximum permissible concentration (uc/cm3) in water and air of radioactive fallout for seven exposure times (n) at eleven different times after burst to deliver a dose to the critical organ of 15 rems in 90 days (t)\*

n	Exposure	Time after fission										
		3.5 hr	12 hr	1 day	2 days	4 days	7 days	14 days	28 days	105 days	210 days	365 days
1	Ing. Inh.	2.5 3.7 x 10 <sup>-4</sup>	0.81 1.2 x 10 <sup>-4</sup>	0.48 6.9 x 10 <sup>-5</sup>	0.29 4.0 x 10 <sup>-5</sup>	0.18 2.4 x 10 <sup>-5</sup>	0.13 1.7 x 10 <sup>-5</sup>	6.9 x 10 <sup>-6</sup> -28.2 x 10 <sup>-6</sup>	7.1 x 10 <sup>-6</sup> -26.9 x 10 <sup>-6</sup>	0.10 6.4 x 10 <sup>-6</sup>	0.10 6.0 x 10 <sup>-6</sup>	8.0 x 10 <sup>-6</sup> -25.7 x 10 <sup>-6</sup>
7	Ing. Inh.	0.54 7.7 x 10 <sup>-5</sup>	0.18 2.5 x 10 <sup>-5</sup>	0.10 1.4 x 10 <sup>-5</sup>	5.8 x 10 <sup>-6</sup> -27.4 x 10 <sup>-6</sup>	3.6 x 10 <sup>-6</sup> -24.5 x 10 <sup>-6</sup>	2.4 x 10 <sup>-6</sup> -22.7 x 10 <sup>-6</sup>	1.2 x 10 <sup>-6</sup> -21.7 x 10 <sup>-6</sup>	1.5 x 10 <sup>-6</sup> -22.0 x 10 <sup>-6</sup>	1.5 x 10 <sup>-6</sup> -27.0 x 10 <sup>-6</sup>	1.4 x 10 <sup>-6</sup> -26.3 x 10 <sup>-6</sup>	1.3 x 10 <sup>-6</sup> -26.7 x 10 <sup>-6</sup>
14	Ing. Inh.	0.37 5.0 x 10 <sup>-5</sup>	0.12 1.8 x 10 <sup>-5</sup>	6.9 x 10 <sup>-6</sup> -29.0 x 10 <sup>-6</sup>	3.9 x 10 <sup>-6</sup> -25.0 x 10 <sup>-6</sup>	2.4 x 10 <sup>-6</sup> -23.0 x 10 <sup>-6</sup>	1.5 x 10 <sup>-6</sup> -21.8 x 10 <sup>-6</sup>	7.6 x 10 <sup>-6</sup> -38.1 x 10 <sup>-6</sup>	7.1 x 10 <sup>-6</sup> -36.1 x 10 <sup>-6</sup>	8.3 x 10 <sup>-6</sup> -36.7 x 10 <sup>-6</sup>	7.7 x 10 <sup>-6</sup> -34.3 x 10 <sup>-6</sup>	6.4 x 10 <sup>-6</sup> -34.0 x 10 <sup>-6</sup>
21	Ing. Inh.	0.32 4.4 x 10 <sup>-5</sup>	0.11 1.4 x 10 <sup>-5</sup>	5.9 x 10 <sup>-6</sup> -27.7 x 10 <sup>-6</sup>	3.3 x 10 <sup>-6</sup> -24.2 x 10 <sup>-6</sup>	2.0 x 10 <sup>-6</sup> -22.4 x 10 <sup>-6</sup>	1.3 x 10 <sup>-6</sup> -21.5 x 10 <sup>-6</sup>	5.8 x 10 <sup>-6</sup> -36.2 x 10 <sup>-6</sup>	5.4 x 10 <sup>-6</sup> -34.7 x 10 <sup>-6</sup>	5.7 x 10 <sup>-6</sup> -33.4 x 10 <sup>-6</sup>	5.5 x 10 <sup>-6</sup> -33.1 x 10 <sup>-6</sup>	4.5 x 10 <sup>-6</sup> -32.8 x 10 <sup>-6</sup>
30	Ing. Inh.	0.29 3.7 x 10 <sup>-5</sup>	9.7 x 10 <sup>-6</sup> -21.2 x 10 <sup>-5</sup>	5.4 x 10 <sup>-6</sup> -26.7 x 10 <sup>-6</sup>	2.6 x 10 <sup>-6</sup> -23.2 x 10 <sup>-6</sup>	1.8 x 10 <sup>-6</sup> -22.1 x 10 <sup>-6</sup>	1.1 x 10 <sup>-6</sup> -21.2 x 10 <sup>-6</sup>	5.3 x 10 <sup>-6</sup> -34.9 x 10 <sup>-6</sup>	4.5 x 10 <sup>-6</sup> -33.6 x 10 <sup>-6</sup>	4.4 x 10 <sup>-6</sup> -32.5 x 10 <sup>-6</sup>	4.1 x 10 <sup>-6</sup> -32.3 x 10 <sup>-6</sup>	3.3 x 10 <sup>-6</sup> -32.0 x 10 <sup>-6</sup>
60	Ing. Inh.	0.25 3.2 x 10 <sup>-5</sup>	8.3 x 10 <sup>-6</sup> -21.0 x 10 <sup>-5</sup>	4.6 x 10 <sup>-6</sup> -25.4 x 10 <sup>-6</sup>	2.5 x 10 <sup>-6</sup> -22.9 x 10 <sup>-6</sup>	1.5 x 10 <sup>-6</sup> -21.5 x 10 <sup>-6</sup>	9.8 x 10 <sup>-6</sup> -31.1 x 10 <sup>-6</sup>	4.3 x 10 <sup>-6</sup> -33.7 x 10 <sup>-6</sup>	3.3 x 10 <sup>-6</sup> -32.6 x 10 <sup>-6</sup>	2.7 x 10 <sup>-6</sup> -31.7 x 10 <sup>-6</sup>	2.4 x 10 <sup>-6</sup> -31.5 x 10 <sup>-6</sup>	1.8 x 10 <sup>-6</sup> -31.4 x 10 <sup>-6</sup>
90	Ing. Inh.	0.24 3.1 x 10 <sup>-5</sup>	8.0 x 10 <sup>-6</sup> -21.0 x 10 <sup>-5</sup>	4.4 x 10 <sup>-6</sup> -25.4 x 10 <sup>-6</sup>	2.4 x 10 <sup>-6</sup> -22.9 x 10 <sup>-6</sup>	1.4 x 10 <sup>-6</sup> -21.7 x 10 <sup>-6</sup>	9.2 x 10 <sup>-6</sup> -39.7 x 10 <sup>-6</sup>	3.8 x 10 <sup>-6</sup> -33.6 x 10 <sup>-6</sup>	2.9 x 10 <sup>-6</sup> -32.4 x 10 <sup>-6</sup>	2.1 x 10 <sup>-6</sup> -31.5 x 10 <sup>-6</sup>	1.7 x 10 <sup>-6</sup> -31.3 x 10 <sup>-6</sup>	1.3 x 10 <sup>-6</sup> -31.2 x 10 <sup>-6</sup>

\* Ing. = ingestion; Inh. = inhalation

From: J. D. Teresi and C. L. Newcombe, "Calculations of maximum permissible concentrations of radioactive fallout in water and air based upon military exposure criteria," *Health Physics* 4:275-288, 1961.

**Table 7:** Maximum permissible concentration (uc/cm3) in water and air of radioactive fallout for five exposure times (n) at eleven different times after burst to deliver a dose to the critical organ of 150 rems in 30 days (t)\*

n	Exposure	Time after fission										
		3.5 hr	12 hr	1 day	2 days	4 days	7 days	14 days	28 days	105 days	210 days	365 days
1	Ing.	27	8.5	5.1	3.0	2.0	1.4	0.78	0.83	1.2	1.3	1.1
	Inh.	$4.1 \times 10^{-3}$	$1.3 \times 10^{-3}$	$7.7 \times 10^{-1}$	$4.5 \times 10^{-1}$	$2.8 \times 10^{-1}$	$1.9 \times 10^{-1}$	$1.0 \times 10^{-1}$	$9.8 \times 10^{-5}$	$1.2 \times 10^{-1}$	$1.2 \times 10^{-1}$	$1.2 \times 10^{-1}$
7	Ing.	5.9	1.9	1.1	0.63	0.40	0.26	0.14	0.14	0.18	0.19	0.15
	Inh.	$8.6 \times 10^{-1}$	$2.8 \times 10^{-1}$	$1.3 \times 10^{-4}$	$8.0 \times 10^{-5}$	$5.6 \times 10^{-5}$	$3.7 \times 10^{-5}$	$1.8 \times 10^{-5}$	$1.7 \times 10^{-5}$	$2.0 \times 10^{-5}$	$2.0 \times 10^{-5}$	$1.9 \times 10^{-5}$
14	Ing.	4.3	1.4	0.78	0.43	0.27	0.18	$8.8 \times 10^{-2}$	$21.1 \times 10^{-3}$	0.12	0.10	$7.9 \times 10^{-2}$
	Inh.	$7.2 \times 10^{-4}$	$2.3 \times 10^{-4}$	$1.3 \times 10^{-4}$	$5.3 \times 10^{-5}$	$3.8 \times 10^{-5}$	$2.5 \times 10^{-5}$	$8.8 \times 10^{-2}$	$21.1 \times 10^{-3}$	$1.1 \times 10^{-5}$	$1.1 \times 10^{-5}$	$7.9 \times 10^{-2}$
21	Ing.	3.7	1.2	0.67	0.38	0.23	0.15	$7.3 \times 10^{-2}$	$29.8 \times 10^{-6}$	$6.8 \times 10^{-2}$	$28.9 \times 10^{-6}$	$5.2 \times 10^{-2}$
	Inh.	$5.4 \times 10^{-4}$	$1.8 \times 10^{-4}$	$9.7 \times 10^{-5}$	$5.5 \times 10^{-5}$	$3.3 \times 10^{-5}$	$2.0 \times 10^{-5}$	$7.3 \times 10^{-2}$	$29.8 \times 10^{-6}$	$6.8 \times 10^{-2}$	$28.9 \times 10^{-6}$	$5.2 \times 10^{-2}$
30	Ing.	3.6	1.1	0.62	0.34	0.21	0.14	$6.8 \times 10^{-2}$	$29.2 \times 10^{-6}$	$6.0 \times 10^{-2}$	$27.9 \times 10^{-6}$	$3.8 \times 10^{-2}$
	Inh.	$5.4 \times 10^{-4}$	$1.7 \times 10^{-4}$	$8.4 \times 10^{-5}$	$5.3 \times 10^{-5}$	$2.8 \times 10^{-5}$	$2.0 \times 10^{-5}$	$6.8 \times 10^{-2}$	$29.2 \times 10^{-6}$	$6.0 \times 10^{-2}$	$27.9 \times 10^{-6}$	$3.8 \times 10^{-2}$

\* Ing. = ingestion; Inh. = inhalation

CONTAMINATION OF FOOD PROBLEM AFTER  
NUCLEAR WAR

December 4, 1985

Aina J. Shapley

## TABLE OF CONTENTS

Overview	p. 1
The most important fission products in food	p. 10
Methods of measurement	p. 20
Lack of standards and MFD	p. 24
Emergency schemes	p. 30

### Note.

The vast majority of papers referred to have been copied.

A lot of subjects have not been discussed, e.g. units, different instruments, properties of radiation, and dose calculations. They are described in health physics text books. You have An introduction to radiation protection by Alan Martin and Samuel A. Harbison and Radiation Protection by Jacob Shapiro.

## OVERVIEW

The most thorough and the most authoritative book on The effects of nuclear weapons is a book by that title compiled and edited by S. Glasstone and F. J. Dolan, 3<sup>rd</sup> ed., U. S. Department of Defense and U.S. Department of Energy, 1977. This book is referred to in almost all the articles and books dealing with a nuclear war. It is the source book on the description of the different atomic bombs, their uses and the consequent explosive blast, direct nuclear radiation, direct thermal radiation, EMP, and fallout.

The most thorough study of the probable consequences of nuclear weapons on the United States, as well as on the Soviet Union, was done by the Office of Technology Assessment (OTA), The effects of nuclear war, 1979, (for complete ref see p. 3). They considered five major cases ranging from 1 atomic weapon to an all out mixed military and population attack of 6500 MT (half of it air bursts and the other half surface bursts).

We are interested in the latent health effects. I have copied 7 of the most interesting pages and given them page numbers in the upper right hand corner. The risk factors for the latent health effects, as well as the sources and the compromises they made to arrive at them are given on p. 2. The risk factors they used for latent cancer deaths from internal organ exposures are given on p. 3.

Before we go any further, we have to examine some of the categories they use for the way they present their data. Local fallout is what is deposited within 24 hours after the burst. The fraction of nuclear debris in the local fallout varies from 0.8 from surface bursts to 0 from air-bursts. Worldwide fallout can be of two kinds, tropospheric and stratospheric. Tropospheric fallout is short (weeks). Stratospheric fallout is in years, e.g. removal half-time for Cs-137 is 5 years. Stratospheric fallout can be from 0 to .99 of the fallout, depending on the altitude and

Absolute risk is defined as the product of assumed relative risks times the total population at risk. Relative risk is defined as the ratio of the risk in those exposed to the risk to those not exposed. The difference between the two risk models leading to major differences in the projected number of cancer deaths lies in the calculated excess of cancers arising from the 0 - 9 years age group at the time of irradiation. Because data on relative risks are sparse and inconclusive, and more data exist supporting the absolute model, the absolute model was used to calculate the latent health effects. Also, because the effectiveness of low exposure rates and/or low radiation exposure doses for producing late health effects remains unresolved, projected cancer deaths were calculated with dose effectiveness factors (DEF) of 1.0 and 0.2 for low exposure rates and doses.\* Also, because there is insufficient data to warrant limiting the risk plateau period to 30 years, a 40 year risk period was used.<sup>9)</sup> Estimates of radiation genetic risks are also uncertain. Reference 8 estimates that the doubling dose for genetic risks to be between 20 and 200 rems although the possibility of it being lower than 20 rems or higher than 200 rems is not dismissed. Since a doubling dose of 100 rems was suggested by Reference 6 and it is within the estimated range of Reference 8, it was used to project the genetic risks. It follows that if the doubling dose is 20 rems then the projected number of genetic disorders (spontaneous abortions and "other genetic effects") should be multiplied by 5, and if the doubling dose is 200 rems then the projected number of genetic disorders should be halved. The resulting projected latent health effects from radiation exposures using a DEF=1 for cancer deaths are as follows:

<u>Effects</u>	<u>Number per 10<sup>6</sup> person rems</u>
Cancer deaths *	194.3
Thyroid cancers	134.1
Thyroid nodules	197.4
Spontaneous abortions	42
Other genetic effects	132.4

---

\* Multiply by 0.2 for DEF = 0.2.

---

\* A DEF=0.2 implies that the radiation received is only one-fifth as effective per unit of dose for producing latent effects when compared to a high dose received over a short period of time.



The projected latent cancer deaths from internal organ exposures are as follows:

<u>Organ</u>	<u>Cancer deaths per 10<sup>6</sup> organ rems</u>
Marrow	45.4
Lung	35.5
Digestive	27.1
Bone	11
Others	75.3

Also, for thyroid exposures from ingested I-131, the effectiveness of the exposure is estimated to be one-tenth that of an external (gamma) exposure.<sup>6)</sup>

size of the weapon.

For the worst scenario (6500 MT) they predict 100 million early fatalities (could be as high as 160 million). On p. 5 they give a comparison of latent health effects from external and internal exposures from local fallout. By far the most of the effects are from external exposure rather than from internal exposure. For cancer deaths only 7% are from internal exposure and for thyroid cancers it is less than 1%.

On p. 6 they give worldwide fallout health effects for the U.S. The most interesting thing about this is that they see carbon-14 as the biggest problem in this category. Next table is total latent health effects and the numbers do look high. The thing to keep in mind is that these figures are for the subsequent 40 years. 6.6 million cancer deaths in 40 years is about 40% of the current U.S. annual rate. It is interesting to note that there are almost as many latent health effects outside of the U.S. (e.g. 4,545,000 cancer deaths). These would be distributed all over the world. If there was a similar attack on the Soviet Union, there would be 167,000 cancer deaths plus all the other latent health effects in the U.S.

Pages 7 and 8 give the summary of their conclusions.

Page 9 gives their references.

## LOCAL FALLOUT HEALTH EFFECTS

5

	PFs=5	PFs=10	PFs=40	Mixed PFs
<u>External Exposure</u>				
ADDITIONAL SHELTER FATALITIES	21,712,000	9,441,000	327,200	---
CANCER DEATHS (DEF=1)	2,390,000	2,099,000	1,005,000	1,720,000
CANCER DEATHS (DEF=0.2)	2,359,000	2,082,000	993,800	1,700,000
THYROID CANCERS	1,650,000	1,449,000	693,500	1,190,000
THYROID NODULES	2,429,000	2,132,000	1,021,000	1,750,000
SPONTANEOUS ABORTIONS	516,700	453,700	217,200	372,000
OTHER GENETIC EFFECTS	1,629,000	1,430,000	684,700	1,170,000
<u>Internal Exposure</u>				
CANCER DEATHS (DEF=1)	47,200	80,200	127,800	132,000
CANCER DEATHS (DEF=0.2)	9,400	16,000	25,600	26,400
THYROID CANCERS	2,600	4,400	7,000	7,200
THYROID NODULES	3,800	6,500	10,300	10,600
SPONTANEOUS ABORTIONS	3,100	5,300	8,400	8,700
OTHER GENETIC EFFECTS	9,800	16,600	26,400	27,300

## WORLDWIDE FALLOUT HEALTH EFFECTS

	TROPOS	STRATOS	C-14	TOTAL
CANCER DEATHS (DEF=1)	360,100	1,543,000	2,886,000	4,789,000
CANCER DEATHS (DEF=0.2)	72,000	308,600	577,200	957,800
THYROID CANCERS	606,800	1,206,000	1,570,000	3,383,000
THYROID NODULES	893,200	1,776,000	2,311,000	4,980,000
SPONTANEOUS ABORTIONS	49,700	188,200	736,500	974,400
OTHER GENETIC EFFECTS	156,700	590.800	2,324,000	3,072,000

## TOTAL LATENT HEALTH EFFECTS

	PFs=5	PFs=10	PFs=40	Mixed PFs
ADDITIONAL SHELTER FATALITIES	21,712,000	9,441,000	327,200	----
CANCER DEATHS (DEF=1)	7,226,000	6,968,000	5,922,000	6,640,000
CANCER DEATHS (DEF=0.2)	3,326,000	3,056,000	1,977,000	2,680,000
THYROID CANCERS	5,036,000	4,836,000	4,084,000	4,580,000
THYROID NODULES	7,413,000	7,119,000	6,011,000	6,730,000
SPONTANEOUS ABORTIONS	1,494,000	1,433,000	1,200,000	1,360,000
OTHER GENETIC EFFECTS	4,711,000	4,515,000	3,783,000	4,270,000

## TOTAL LATENT HEALTH EFFECTS OUTSIDE OF THE U.S.

	DEF=1	DEF=0.2
CANCER DEATHS	4,545,000	909,000
THYROID CANCERS	3,254,000	
THYROID NODULES	4,549,000	
SPONTANEOUS ABORTIONS	926,000	
OTHER GENETIC EFFECTS	2,919,000	

## CONCLUSIONS

The long-term major adverse health effects resulting from hypothesized nuclear scenarios covering a nuclear employment range from a single weapon to a massive attack utilizing thousands of nuclear weapons were calculated. The general findings were as follows:

1. Several million latent cancer deaths could result from a massive nuclear attack directed at urban-industrial, military, and counterforce targets.\* However, without improved civil defense capabilities, the number of projected latent cancer deaths is small when compared with the total number of early fatalities. Similar magnitudes of thyroid cancers, thyroid nodules, and genetic anomalies are also projected.
2. For limited attacks where the target points are in relatively low population density areas, the resulting number of latent cancer deaths could be large when compared with the total number of early fatalities.
3. For nuclear employments that are dominated by airbursts, the projected number of long-term adverse health effects that would occur in the attacked country is only a small percentage of the projected worldwide total.
4. For airbursts, the resulting number of long-term adverse health effects are larger for low yield weapons (40 KT) than for high yield weapons (1 MT) when compared on a per unit fission yield basis. The reason is that the nuclear debris of low yield airbursts is confined within the troposphere, whereas most of the nuclear debris from high yield airbursts enters the stratosphere.
5. Increasing the local fallout decontamination effectiveness to residual levels below 0.1 will not materially decrease the total number of long-term latent health effects because the local fallout post-shelter population dose constitutes only a small

---

\*5 million worldwide cancer deaths over a period of 40 years represent an increase of about 2 to 3 percent of the current cancer death rate. - They must be using Northern Hemisphere or something. For U.S. this would be closer to 30%

fraction of the total population dose when the fallout levels are reduced by a factor of 0.1 by decontamination.

6. The use of low yield weapons in the surface burst mode rather than high yield weapons as air bursts would increase the long-term latent adverse health effects in the country attacked and decrease the number of the effects in the rest of the world.
7. For massive nuclear attacks (Scenario 5a and 5b), although the number of early fatalities are sensitive to the shelter protection provided the population, the projected total number of latent health effects are relatively insensitive to the shelter protection provided.

Office of Technology Assessment, The Effects of Nuclear War, Gale Research Company, Book Tower, Detroit, Michigan 48226, 1984. (This is an extended version of 1979 publication by U.S. Govt. Printing Office.)

Abbreviation used: OTA, The effects of Nuclear War.

## REFERENCES

1. The Effects of Nuclear Weapons, Compiled and edited by S. Glasstone and P. J. Dolan, Third Edition, U.S. Department of Defense and U.S. Department of Energy, 1977.
2. Report of the United Nations Scientific Committee on the Effects of Atomic Radiation, General Assembly, Official Records: Seventeenth Session, Supplement No. 16 (A/5216), United Nations, New York, 1962.
3. H. Lee, P. W. Wong, and S. L. Brown, SEER II: A New Damage Assessment Fallout Model, DNA3008F, SRI International, Menlo Park, California, May 1972.
4. (Classified Report)
5. G. R. Crocker and T. Turner, Calculated Activities, Exposure Rates, and Gamma Spectra for Unfractionated Fission Products, USNRDL-TR-1009, U.S. Naval Radiological Defense Laboratory, San Francisco, California, 28 December 1965.
6. N. C. Rasmussen et al., Reactor Safety Study: An Assessment of Accident Risks in U.S. Commercial Nuclear Power Plants, Appendix VI, Calculation of Reactor Accident Consequences, WASH-1400, Nuclear Regulatory Commission, October 1975.
7. H. Lee, W. L. Owen, and C. F. Miller, General Analysis of Radiological Recovery Capabilities, SRI International, Menlo Park, California, June 1968.
8. The Effects on Populations of Exposure to Low Levels of Ionizing Radiation, Advisory Committee on the Biological Effects of Ionizing Radiations, National Academy of Sciences, Washington, D.C., November 1972.
9. R. A. Armistead et al., Analysis of Public Consequences from Postulated Severe Accident Sequences in Underground Nuclear Power Plants, Advanced Research and Applications Corporation, Sunnyvale, California, December 1977.

## THE MOST IMPORTANT FISSION PRODUCTS IN FOOD

There are a number of good books on the subject. The most valuable probably is Radioactivity and Human Diet, ed. R. Scott Russell, Pergamon Press, 1966. Others: Radionuclides in Foods, National Academy of Sciences, 1973. Radioactive Fallout, Soils, Plants, Foods, Man, ed. Eric B. Fowler, 1965.

Iodine, strontium, and cesium are the most important radionuclides that enter the food chain and are absorbed by man from the intestinal tract. Barium-140, ruthenium-103, iron-55 can also be absorbed to a small extent. Tritium and carbon-14 are also very important but they are so mobile in the environment, no one can do anything about them. There are many other radionuclides that are important in the first few months after a nuclear explosion if one eats food directly contaminated by the fallout. Although the latter radionuclides are not absorbed by the body, they can do great damage to the intestinal tract while they are passing through the body.

Iodine. There are some 11 isotopes of iodine that are produced in fission. All except I-129 which has a half-life of  $1.6 \times 10^7$  years have shorter half lives than I-131.

Isotope	Half-life	Activity relative to I-131 24 hrs after thermal fission of U-235
I-131	8.05 days	1
I-132	2.3 hrs	3
I-133	20.8 hrs	9
I-135	6.7 hrs	5

Although I-132, I-133, and I-135 are more abundant initially, they result in lower doses than I-131 because of their shorter half-lives. I-132 persists in appreciable amounts longer than its half-life would indicate, because it is produced mainly from tellurium-132 which has a half-life of 78 hours. The doses from I-132 and I-133 can exceed I-131 near the explosion site for the first week. (R. J. Garner and R. Scott Russell, "Isotopes of iodine", in Radio-



activity and Human Diet, 1966.)

Iodine is readily absorbed through any moist skin or mucosal surface, and essentially all that is ingested is absorbed. The amount of radioiodine taken up by the thyroid is closely dependent on the dietary level of stable iodine, About 20% of the intake ends up in the thyroid. Most of the iodine in man is excreted via the urine, and its biological half-life is 2-4 months. The effective half-life is a little less than its physical half-life, 7.6 days. Iodine is actively concentrated in the thyroid, that means that the concentration in the thyroid is much higher than in plasma.

Since thyroid is relatively small, 20 g, it doesn't take much to damage the gland. The first type of damage is nodules, then cancers and if the dose has been extremely high, destruction of the tissue itself. The result of the last case is hypothyroidism. Radiation induced cancers are almost invariably less malignant than the usual type that aren't induced by radiation. It is, therefore, believed that radiation increases the number of cancers but does not increase mortality as a whole. (Diane G. Crocker, "Nuclear reactor accidents - the use of KI as a blocking agent against radioiodine uptake in the thyroid," Health Physics, 46:1265-1279, 1984.)

There is a lot of literature on I-131 as well as on potassium iodide (KI) as a means of preventing the uptake of radioiodine by the thyroid. The reason is that potentially there could be high releases of I-131 from nuclear power plant accidents. Windscale accident in England resulted in the withholding of milk from the market for a while. Initial exposure in such cases is from inhalation, but the subsequent dose from eating contaminated food is 400-700 times higher. The main source of I-131 in human diet is milk, partly because milk is consumed relatively fresh.

Both KI and potassium iodate ( $KIO_3$ ) can be used to saturate the iodine uptake system of the thyroid. The advantage of  $KIO_3$  is that it has a much longer shelf life,

up to 10 years, versus about 2 years for KI. Inside the body  $\text{IO}_3^-$  gets quickly converted to  $\text{I}^-$  and acts the same way as if originally it had been KI. About 130 mg of KI completely blocks radioiodine uptake for about 24 hours, 65 mg of KI is probably sufficient for children. It is most effective if given shortly before to 1-2 hours after exposure. The effectiveness of KI decreases rapidly with time after exposure, limited benefit is possible up to 12 hours after a single exposure. KI can be bought at drugstores without prescription in the U.S.

Unfortunately, there are side effects to taking large quantities of KI. It is only when the exposure level is 10 rem that the risk from radiation damage exceeds the risk from KI. In geriatric or coronary patients the hazard from KI might be greater than the radiation hazard under any circumstances. Asthmatics, chronic heart or renal failure patients, patients with hypocomplementemic vasculitis and autoimmune related diseases have reacted very severely to KI treatments. The fetus and the newborn are also susceptible to harmful effects. Unfortunately, this group is also more susceptible to the adverse effects of radioiodine. (Diane G. Crocker, ibid.)

The half-life of I-131 is too short for absorption from the soil or from the plant base to be major routes of entry into the food chain. The interval between grain harvesting and consumption is long enough that one doesn't have to worry about iodine. When iodine is deposited on leaves of plants, most of it is not absorbed. A lot of it can be washed off by rain or removed by mechanical processes. All of the above explains why a cow eating grass directly is the main entry route of iodine into the food chain. Levels of contamination in milk have frequently decreased more rapidly than the physical half-life of I-131. This is due to "field-loss" factor. In one case, the activity decreased by a factor of 2 in 2 weeks compared to the loss due to physical decay.

Fraction of ingested I-131 taken <sup>up</sup> by the thyroid can vary quite a bit but it is approximately 20% in cow as well as man. I-131 starts appearing in milk in 30 minutes and reaches maximum within 12 hours after a single exposure. The kind of conditions that would be true after a nuclear war, it would be 2-4 days after the start of fallout that it would reach the maximum concentration in milk. Both the cow's udder and the human breast concentrate iodine into milk in relation to the blood iodine level.

I-131 can also be incorporated into egg yolks in chickens on free range. After Windscale accident the activity of I-131 per egg averaged approximately 1/20 of that per litre of milk. (R. J. Garner and R. Scott Russell, ibid.)

If iodine were deposited in winter, the iodine hazard would be greatly reduced. The highest levels of contamination occur when the cows are grazing or are fed recently cut herbage. Contamination decreases markedly when stored food is substituted. From this it can be seen that the greatest danger would be right at the haying season. Previous year's stocks would have been exhausted and the next year's stocks wouldn't be in the barn yet.

Summary of the proposed protective measures:

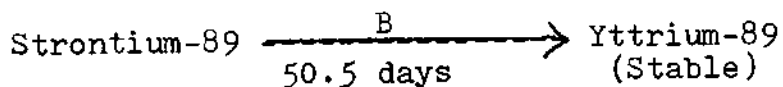
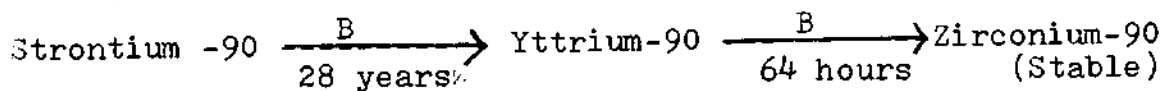
1. Removal of lactating cows from pasturage-feeding system and substitution of stored feed rations. I-131 is reduced to insignificant levels in 3-4 days. The reverse is true if cows are placed on contaminated pasture. If cows were in and kept in when the fallout started, no problem would arise.
2. Withholding contaminated product to allow radioactive decay.
3. Supplying milk to areas of high contamination from areas where contamination is low.
4. Diverting contaminated milk into manufactured products and substituting processed milk, e.g., powdered or canned milk.
5. Storage of frozen fresh milk.

6. Storage of fresh concentrated milk.
7. Storage of frozen concentrated milk.
8. Physical removal of iodine-131 from milk with ion-exchange resin.

(Frank A. Todd, "Protecting foods and water against radioactive contamination," pp. 235-256, Protection of the Public in the Event of Radiation Accidents, World Health Organization, 1965.

All of the above, except #1, are completely dependent on the availability of electricity and transportation. Number one is partly dependent on transportation. If there was no electricity, the cows would not be milked. We don't have the personnel who know how to milk cows. So you could learn it in a day, but there is no way you could develop the strength in a short time to milk more than one cow. I called up the local dairy farmer to ask what they would do if there was no electricity. They have 40 cows and they would not be milked unless they obtained a generator. They have had to do that once in the past. Their milk goes down to Guelph, that is more than 100 km away. There are 2 small cheese plants that are a little closer, but she couldn't think of any milk processing plant that would be closer.

Strontium. There are two types of strontium (Sr). Sr-89 is important the first month and Sr-90 is important for a long time. Both emit only B rays.



Strontium is metabolized the same way as calcium (Ca). Strontium absorption, however, is discriminated against by body, compared to calcium absorption. Ratio of Sr/Ca in blood is 1/3 to 1/4 of what it is in diet. Mother's milk has half the Sr concentration in blood and the fetus

also has only half the concentration. The effective half-life in body is 50 days for Sr-89 and 17.5 years for Sr-90. (Cs also has a long half-life but its effective half-life in body is less than 100 days.) Its long effective-half life is what makes Sr-90 such a dangerous radionuclide.

Ratio of Sr to Ca in new bone is in equilibrium with body fluids. In other words, the amount of strontium that gets deposited in bone is dependent on the ratio of Sr/Ca in blood. Therefore, radiostrontium concentration is a lot of times expressed in terms of Ca concentration. The common units are pc of Sr/g of Ca or for milk pc Sr/l.

The main source of strontium in a western diet is dairy products. But that doesn't give the whole picture. As explained above, strontium absorption depends on the level of calcium and dairy products are also the major source of calcium in western diets. It might look like elimination of dairy products would improve the situation but the reverse would be true. More vegetables would be consumed and there the ratio of Sr/Ca is much higher. Third world countries get twice the amount of strontium in their diets compared to that of the western countries. The following table of contribution of various foods to Sr-90 in population of N.Y. City illustrates the differences in calcium levels and their subsequent effect.

Food	pc/yr	% total intake	
		Ca	Sr-90
Dairy products	2080	58	38
Vegetables	1212	9	22
Fruits, fresh and canned	1192	3	22
Cereals and bakery products	588	20	11
Meat, poultry, eggs	178	8	3
Fish	5	2	-
Water	200	-	4

Radionuclides in Foods, p. 34, National Academy of Sciences, 1973.

In vegetables the strontium content can be reduced 19-55% by common home preparation. In canned fruit the reduction can even be higher compared to fresh fruit. The following are given as methods for reducing strontium intake.

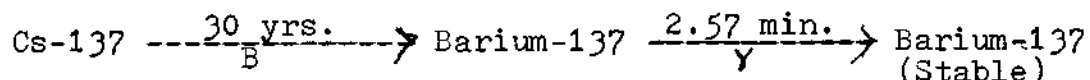
1. Protection of packaged and stored foods.
2. Removal of surface contamination by washing and scrubbing of fruits and vegetables.
3. Removal of surface contamination by peeling.
4. Removal of internal contamination of food through processing.
5. Reduction of strontium-90 secretion into milk by supplementing rations of dairy cows with calcium.
6. Removal of radioactivity by use of such processes as ion-exchange, electro dialysis, or calcium phosphate treatment.

Frank A. Todd, *ibid.* One important method Todd doesn't mention is milling of wheat. Whole wheat has twice the Sr/Ca than white flour.

There is a good discussion of remedial measures by C. L. Comar and J. C. Thompson, Jr. with emphasis on "certain aspects of feasible large-scale measures" in Survival of Food Crops and Livestock in the Event of Nuclear War, 1970, "Status of remedial measures against environmental radiocontamination".

The plant root makes little distinction between Ca and Sr if they are in the same chemical form. Soluble Ca in the soil acts as a diluent for the Sr - the amount of calcium in soil is important. Generally good agricultural soils result in lower Sr content in food. Strontium deposited on the plants may be trapped and absorbed through those parts of the plant which are above the ground. The amount that is so trapped depends on the form of the plants, it is usually considerable in grasses. Again, a cow comes along and picks it all up, the absorbed and the unabsorbed Sr. Luckily, there is discrimination against strontium relative to calcium by a factor of about 10 which occurs in the transfer of the two elements from the diet of cattle to milk.

Cesium. Cesium (Cs)-137 is the third most dangerous radionuclide that enters very quickly the human food chain after a nuclear fallout. It is an alkali metal like potassium (K) and its behaviour in nature as well as the human body is similar to that of potassium. The relationship between the two, although, is not as close as between Sr and Ca. The decay scheme of Cs-137 is shown below.



Cesium is around in the environment for a long time, its half-life is 30 years. Quite commonly Cs is referred to as a  $\gamma$  source. Technically this is not correct. Cs decays by a B emission to Ba-137 which has a half-life of only 2.57 min. when it decays by a  $\gamma$  emission to a stable form of Ba. Its "daughter", however, has such a short half-life that Cs is ordinarily identified by  $\gamma$  spectrometry of the  $\gamma$  emission of its daughter. Cs is more common in fallout than Sr by 1.3 to 1.7.

Cesium is freely absorbed from the human intestinal tract and appears to have an average stay of 4 months. Compared to other radionuclides, it is distributed fairly uniformly over the body. The human body content of Cs-137 is closely related to the level of it in the diet. It is absorbed preferentially to potassium. The ratio of Cs-137/gK is 3 times higher in body than in food. In animal studies one has to take 9 times the normal level of K to cut Cs-137 level by half. L. Fredriksson, R. J. Garner and R. Scott Russell, "Caesium-137", in Radioactivity and Human Diet, 1966.

Sources of Cs in human food:

Cows milk 30% or 25-40%

Grain products 25% or 17-30%

Meat 20% or 12-26%

Fruit 10% or 15%

Vegetables 10% or 15%

Fish important where it forms a large part of diet.

The two sets of figures just given are from two different sources. They indicate that cesium is distributed relatively evenly among the different food groups.

Because cesium has volatile precursors, a lot of it ends up in stratosphere. Very roughly its mean time in stratosphere is 2 years. As it falls down, it is deposited on any growing vegetation. Most of the Cs that enters the food chain is absorbed by the plants directly and not from soil after it has been washed down. The heaviest fallout occurs in spring because most of the mixing between stratosphere and troposphere occurs during late winter. Areas with higher rainfall can receive twice as much fallout.

Cesium is readily absorbed by clay particles in soil. It is held tightly enough that only a few per cent of Cs-137 in soil is taken up through the roots of plants. Sandy soils and especially soils with a high content of organic matter bind Cs less effectively. Plants grown on these soils have higher Cs-137 content. Most of the Cs contained in the edible parts of vegetables is due to deposition of particulate material on leaves.

Under certain conditions, Cs can undergo considerable concentration in terrestrial and aquatic food chains. Freshwater fish have been shown to contain it in concentrations several thousand times higher than the concentration in their surroundings. Fish feed on lower aquatic organisms which have already concentrated it above the levels present in water. Shellfish do the same thing. Cesium is effectively trapped and retained by the lichen and moss of the tundra, which are major sources of food for caribou and reindeer. Caribou flesh contained up to 100 times the quantities found in meat in mid latitudes.

Once fallout has stopped Cs becomes trapped in the top 2 cm of soil. External radiation from it would continue for many years. Its greatest danger is considered to be genetically.



Carbon-14. Most of the carbon(C)-14 is released into the stratosphere, from where it equilibrated with the troposphere with a half-time of about 2 years. Tissue C-14 comes into equilibrium with C-14 in the atmosphere with a delay time of about 1.4 years. The retention half-time of dietary carbon in mammals is estimated to be about 40 days. Like tritium, carbon 14 is highly mobile in the environment and no one can do anything about it.

Tritium. Tritium is radioactive hydrogen. Less than 1% of tritium becomes part of the water molecule but it is in this form that it passes through the eco-systems. It behaves identically to ordinary water. It is highly mobile in the environment and very quickly equilibrates in the different systems.

Iron-55. Two pathways are known for the concentration of iron (Fe)-55. Lichen-caribou pathway is important for Eskimos and Lapps. The second source is marine fish. The marine food chain concentrates Fe-55 even more than than the first pathway. The reason for this is the low concentration of stable iron in sea water.

Half-life of Fe-55 in lichens is 1.4 years.

Erythrocyte is considered to be the critical organ.

Ruthenium-106. Ruthenium is known to have accumulated in at least one known food chain. A seaweed in Irish sea that is used by some people in making bread. Critical organ for this case is the lower large intestine. Some people got as much as half the yearly dose limit of rems/yr for lower intestine during the Windscale accident.

## METHODS OF MEASUREMENT

There is a lot of literature on the measurement of Sr-89 and -90, I-131 and Cs-137 in the environment and in food. Scientists have been doing it all over the world as the result of the atomic bomb tests in the fifties and the first part of the sixties. The most comprehensive references are: Esther Ferri, Paul J. Magno and Lloyd R. Setter, Radionuclide analysis of large numbers of food and water samples, U.S. Dept. Health, Education, and Welfare, 1965. National Center for Radiological Health, Radioassay Procedures for Environmental Samples, U.S. Dept. of Health, Education, and Welfare, 1967. Manual of Standard Procedures, NYO-4700, Health and Safety Laboratory, U.S. Atomic Energy Commission, New York Operations Office. The above do give details for the procedures but are designed for quantities much smaller than what one would be measuring after a nuclear war. They require highly skilled personnel and very sophisticated equipment.

E. R. Mercer ("Analytical Methods" in Radioactivity in Human Diet, ed. R. Scott Russell, 1966.) has a short but clear review of the above methods. He says that in emergencies, when much higher levels of contamination than normal will be acceptable, much simpler analytical methods are adequate. Unfortunately he doesn't describe them. This happens quite a few times, they aren't described because they are obvious to people who work with radioactivity but not so obvious for a person who doesn't have any experience using different radiation detection instruments or measuring mixtures of different radionuclides. He does make a few relevant comments in passing. If Cs-137 exceeds 300 pc/l in milk, it can be measured directly in a sodium iodide (NaI) crystal scintillation counter. Gamma spectrometric measurement of I-131 can also be done directly on whole milk if the level is high enough. Cesium and iodine can also interfere with each other.

Strontium assays are very complicated, numerous radiochemical separations have to be done. Usually Sr-90 is

calculated from the amount of its daughter yttrium-90 (Sr-90 decays to Y-90) and Sr-89 is determined by the difference.

Daniel A. Gollnick does give a simple method for analyzing milk (Experimental radiological health physics, 1978). Since the ratio of Cs-137 to each of the Sr isotopes is a fixed constant at the time when fission takes place, the strontium concentrations can be calculated from the cesium concentration.

$$\frac{\text{Cs-137}}{\text{Sr-90}} = 5 \qquad \frac{\text{Cs-137}}{\text{Sr-89}} = 0.03$$

First of all, these formulas are for milk, in the fallout Cs-137 to Sr-90 ratio is about 1.6. Second, Sr-89 has a relatively short half-life compared to Cs-137, so the ratio changes with time, it has to be doubled every 51 days after the fissions have occurred. Cs-137 and Sr-90 have similar enough half-lives that the change with time can be ignored.

The milk is passed through an anion exchange resin. I-131, being the only anion in the group of 4 we are interested in, is retained on the resin and everything else passes through. Resin is transferred to a bottle that is counted in a solid scintillation counter. The result is calculated from a known I-131 sample that has been treated the same way. The strontium isotopes are pure beta emitters, therefore, the effluent can be poured into a beaker that fits into a NaI counter and counted for gamma emissions from cesium. The result is compared to a known amount of Cs-137 under the same conditions. The cesium value is used in the formulas given above to calculate the amounts of the two different strontiums.

Gollnick also gives a very useful table of what would be the dose commitment from milk, given a level of activity in milk when it is at the highest (2-4 days after the event). See next page. There must be, however, some mistake in rads for Sr-89. If it is 3 rads in the first year, there is no way with its short half-life it can give 2 more rads

in subsequent years.

Radionuclide	RADS	Max. conc. in milk uc/l
Sr-89	3 in 1st yr, 5 total	1.1
Sr-90	3 in 1st yr, 5 total	0.05
I-131	10	0.07
Cs-137	3 in 1st yr, 5 total	0.72

The above is the sort of approach, that I think would be taken, if there were a nuclear holocaust. There are different models for predicting dose commitment from the level of fallout. R. Scott Russel, B. O. Bartlett, and R. S. Bruce, "The significance of long-lived nuclides after a nuclear war," in Survival of Food Crops and Livestock in the Event of Nuclear War, 1970. A. Aarkrog, "Prediction models for Strontium-90 and Caesium-137 Levels in the Human Food Chain", Health Physics, 20:297-311, 1971. W. F. Lengeman has many papers on prediction models. The measurement would be done from an airplane or for more detail from a car. A. C. Chamberlain, R. J. Garner and D. Williams, "Environmental monitoring after accidental deposition of radioactivity," React. Sci. Technology, 14:155-167, 1961.

There are some references that sound good but are not easily available. Guidance on Offsite Emergency Radiation Measurement Systems, Phase 2: The Milk Pathway, B. J. Salmonson, L. G. Hoffman, R. J. Honkus, and J. H. Keller, Westinghouse Idaho Nuclear Company, Inc., WINCO-1009, April 1984. Also by the same people, company and title but a different subtitle: Phase 3: Water and Non-Dairy Food Pathway, WINCO-1012, October 1984. I wanted to send for these two papers but I couldn't find Westinghouse Idaho Nuclear Co. listed in any of the industrial indexes. The closest I could get is that Westinghouse does have a subsidiary called Bettis Atomic Power Lab, Idaho Falls, Idaho (1-208-526-0111). It could be the same company.

Daniel A. Gollnick also has a book out Basic Radiation

Protection Technology, Pacific Radiation Press, 1983.

It isn't available in Toronto. It might have the type of information we are interested in because it has been referred to in places where the concern has been nuclear war.

## LACK OF STANDARDS AND MPD

Currently there aren't any guide lines for intake of radioactive material under the conditions of a nuclear war. The main reason for this is that radioactivity in food is not regarded as a priority in an event of a nuclear war.

"Eating food produced in the years after a large attack would cause an increase in the cancer rate... this increase would be a small fraction of the number of additional cancer deaths that would result from external radiation." Cresson H. Kearney, Nuclear War Survival Skills, p. 65, 1980.

Most vegetables would be fit to eat once they had been thoroughly washed. When it is safe to work outside, can plant new crops - they will be safe to eat. Ivan Tyrell, The survival Option, A guide to living through nuclear war, 1982.

"Standing crops in the early stages of growth are damaged by radiation but otherwise are safe to eat if washed clean of dust." p. 105. "Lack of food and water will cause starvation and death of many millions, especially the young and old." p. 115. Diane Diacon, Residential Housing and Nuclear Attack, 1984. The latter two books are English and I don't know anything about the credentials of their authors. The quotes that follow are by R. Scott Russell, unquestionably one of the world authorities on strontium and cesium in fallout and their biological pathways.

"In short, the total deaths caused by long-lived nuclides seem broadly comparable to the annual traffic death rate." (Incidentally, the figures for lung cancer from smoking are higher than traffic fatalities.) "Thus, by the standards the community now accepts, remedial action against the risks from long-lived nuclides would not seem justified; The number of casualties would be so small relative to the total loss and the difficulty of avoiding them would be so great that remedial action could not

reasonably be contemplated." "...efforts to mitigate doses from radiation should be devoted solely to the early period when short-lived nuclides predominate." R. Scott Russell, B. Bartlett, and R. S. Bruce, "The significance of long-lived nuclides after a nuclear war," in Survival of Food Crops and Livestock in the Event of Nuclear War, 1970.

The maximum permissible doses (MPD) used now are based on the philosophy that any radiation is bad and the less the better. Dose limiting recommendations by the National Council on Radiation Protection (NCRP) are given in Table 6.1. The levels are very low, for general population, 0.17 rem/year. This is less than the natural background radiation in some places.

There certainly is awareness that maximum permissible doses are not what would be in effect after a nuclear holocaust. J. C. Thompson, Jr., R. A. Wentworth, and G. L. Comar ("Control of fallout contamination in the post-attack diet," in Survival of Food... see above) expressed the need for guidelines that respond to tolerance or survival levels of radioactivity rather than the minimum-exposure concept that is in effect now. They would like to have a "system of radiation-exposure priorities" that would become operational after a nuclear attack. They are aware of the irony that the larger the attack, the lower the priority of fallout considerations in food. "It would be poor operational procedure to initiate efforts to reduce dietary contamination from 10 R to 1 R when general external radiation levels were 100 R and a state of pestilence threatened."

The problem of lack of radiation protection standards designed for nuclear war conditions has been discussed by Lauriston S. Taylor in "Standards for radiation exposure management in accident or nuclear attack," a talk he has given at some recent symposium. (I don't have a complete reference, the paper was sent to me.) The same as J. C. Thompson et al, he recognizes that there can really be no fixed standards that can be applied to basically uncontrollable

328 Radiation Protection by Jacob Shapiro**Table 6.1.** Dose-limiting recommendations of NCRP (1971).

---

<b>Occupational exposure limits</b>	
Whole body, gonads, lens of eye, red bone marrow	5 rem in any one year
Skin	15 rem in any one year
Hands	75 rem in any one year (25/qtr)
Forearms	30 rem in any one year (10/qtr)
Other organs, tissues and organ systems	15 rem in any one year (5/qtr)
Fertile women (with respect to fetus)	0.5 rem in gestation period
<b>Dose limits for the public, or occasionally exposed individuals</b>	
Individual or occasional	0.5 rem in any one year
Students	0.1 rem in any one year
<b>Population dose limits</b>	
Genetic	0.17 rem av. per year
Somatic	0.17 rem av. per year
<b>Emergency dose limits—lifesaving</b>	
Individual (older than 45 yr if possible)	100 rem
Hands and forearms	200 rem, additional (300 rem total)
<b>Emergency dose limits—less urgent</b>	
Individual	25 rem
Hands and forearms	100 rem, total
<b>Family of radioactive patients</b>	
Individual (under 45 yr)	0.5 rem in any one year
Individual (over 45 yr)	5 rem in any one year

---

*Source:* NCRP, 1971, Table 6.



radiation situations. The best that we have are what is called "penalty tables". The following is based on brief, whole body gamma-ray doses:

Dose	Need Medical Care	Able to Work	Die
15-50 R	no	yes	0
50-200 R	no	yes	<5%
200-400 R	yes	no	<50%
450-600 R	yes	no	>50%
600- R	yes	no	100%

The above is the kind of data that is available but that is not what the situation would be after a nuclear war. There would be a long period of high radiation level followed by even longer period of moderate radiation levels. The following table is a little more useful:

Category	Need Medical Care	Accumulated Exposure in:		
		1 week	1 month	4 months
A	None	150 R	200 R	300 R
B	Some (5% die)	250 R	350 R	500 R
C	Most (50% die)	450 R	600 R	--

Lauriston S. Taylor, *ibid.*

There is very little information on chronic exposures that scientists could use to develop emergency standards. Needless to say, there is even less information on continuous internal intake of low or large amounts of radioactivity (the only exception is the radium dial painters). Japan did not have any early fallout in 1945. From the Japanese data and past medical uses of radioactivity it is known how many people would get leukemia and other cancers if a certain number of people would be exposed to a certain level of radiation. From this is derived a linear dose-effect relationship without a threshold. Both NCRP and ICRP (International Commission for Radiological Protection) work on assumption that there is no threshold dose of ionizing radiation below which there is no damage. The dose

effects are assumed to be additive. Taylor does not think it would be true for long range, low or moderate level chronic exposures. Too many theoretically dead persons are still walking around, as he puts it. There are many people who have been working for years within the maximum permissible dose limits for radiation workers. None of them have had any effects of practical importance. He feels the limits could be 10 times or more higher before there would be any detectable consequences. Taylor blames the lack of war time radiation guidelines on the media and the public. He feels that the news media have so over-exploited radiation matters that the public is truly frightened of any radiation exposure. "This makes the presentation and public acceptance of any kind of emergency planning extremely difficult." (There is an analogous phenomenon going on right now. 130 people have died so far from AIDS in Canada. At the same time 4000/yr. die in car accidents, plus many more permanently crippled. Half of the latter are caused by alcohol. Yet the public accepts one but is panic stricken of the other.)

Maximum permissible body burdens, plus all the other dose limits have been developed by the International Commission on Radiological Protection (ICRP) and the National Council on Radiation Protection (NCRP). The body burden of a particular radioactive nuclide is the amount of the nuclide in uc which is present in an individuals body. The maximum permissible body burden is the body burden of a particular radioactive nuclide which results in a MPD (Maximum permissible doses that have been developed for external exposure) to the whole body or to one or more organs in the body. It is computed on the basis that it is the only one in the body. The maximum permissible body burden for a radionuclide of a bone seeking element (e.g. strontium, calcium, radium and plutonium) is the number of uc required to deliver to the bone a dose in rems equal to that provided by 0.1 uc of radium-226. Body burdens

for radionuclides other than bone seekers require the identification of "critical organ" (the organ which is the most sensitive or has the highest concentration). For a nuclide with the whole body as the "critical organ", the maximum permissible body burden for occupational exposure is the activity present continuously in the body which delivers a dose equivalent of 5 rem/year to the whole body. Nuclides which concentrate in abdominal organs are given limiting body burdens which provide 15 rem/year. (Kedar N. Prasad, CRC Handbook of Radiobiology, p. 241, 1984.)

Maximum permissible body burdens and maximum permissible concentrations of radionuclides in water for occupational exposures are given in ICRP publications (for references see Radiation Protection by Jacob Shapiro, 1981. The following values for the radionuclides that enter the food chain as a result of a nuclear fallout are from Radiological Health Handbook, U. S. Dept. Health, Education and Welfare, p. 207, 1970.

Radionuclide	Critical organ	Body burden uc	MPC water continuous intake uc/cc
Sr-89	Bone	4	$10^{-4}$
Sr-90	Bone	2	$10^{-6}$
Cs-137	Total body	30	$2 \times 10^{-4}$
I-131	Thyroid	0.7	$2 \times 10^{-5}$

Given equal concentrations, Sr-90 is 100 times more dangerous than Sr-89. The differences can even be higher, radium-226 is 10,000 times more dangerous than tritium.

ICRP Publ. 2 Report of Committee II Permissible Dose for Internal Radiation, Pergamon Press, p. 23-27, 1959 talks about permissible concentration of unidentified radionuclides, mixtures of known radionuclides and some of the problems one would run into if one tried to apply the occupational MPC for water to fallout in water and food.

Assuming Taylor was right that the external doses could be raised 10 times without much danger, the same thing would also apply here. Iodine and strontium -89 could still be increased by much more because of their short half-lives. The figures given were for continuous intake for 40 years. Although one can take in 100 times more Sr-89 than Sr-90, it initially occurs in 180 times the greater concentration than Sr-90. That is why initially it is the more important. Its half life is 51 days and after that Sr-90 becomes the most important contaminant. Unfortunately, strontium is the hardest to measure.

## EMERGENCY SCHEMES

The only permissible emergency levels of radioactivity in food and water for civilisns were put out by the United States Agricultural Research Service in 1960, USDA Radiological Training Manual for Inservice Training. This procedure was still recommended by the U. S. Dept. of Health, Education and Welfare in 1965, Civil Defense information for food and drug officials. I haven't come across anything that would have replaced this procedure.

There is a food and water standard (CDV-787) that is placed in a standard tin. A Geiger-Mueller counter is placed on top of the tin and a reading is taken, should be in 10 to 15 mr/hr area. The tin is filled with food or water when an unknown is tested. Anything below the standard reading is fit for a 10 day consumption. Anything below  $2/3$  of the standard reading is fit for 30 day consumption period. The values that they represent are  $9 \times 10^{-2}$  uc/g and  $3 \times 10^{-2}$  uc/g for 10 and 30 day consumption periods respectively.

There is a more extensive emergency scheme by J. D. Teresi and C. L. Newcombe, "Calculations of maximum permissible concentrations of radioactive fallout in water and air based upon military exposure criteria," Health Physics 4:275-288, 1961. Although this is for water, I think it would also be applicable to directly contaminated food. Permissible levels for food and water are always the same in literature. It would not be applicable to food grown on contaminated soil. Their figures are based on the 14 major contributors in the fallout mixture. This is subdivided in 3 groups: major contributors for the first 7 days, major contributors for 8-104 days and major contributors for 105-365 days after the explosion.

On this basis they calculate the allowable  $\text{ug/cm}^3$

to give 15 rem in 90 days, eaten in 7 different time spans, from 1 to 90 days and starting at 11 different times after time<sup>0</sup>, from 3.5 hrs to 365 days. See their Table 6 on next page. They do the same thing for 150 rems in 30 days. See their Table 7. The tables can be used to get values for any other dose e.g., if you want 75 rem dose in 30 days, divide the value by half. They don't say what standard would be used to determine  $\mu\text{g}/\text{cm}^3$ . I am concerned that the data on which they based their calculations would be outdated. They submitted their paper for publication Nov 1959. The atomic weapons have changed since that time - the fission products would not be in the same proportions now. For example, cesium is not mentioned. There would also be a better idea of the biological effect of some of these radionuclides in 1985.

There are two other methods for emergency monitoring of drinking water. G.W.C. Tait and W. F. Merritt, "Emergency monitoring of drinking water", Health Physics 1:164-168, 1958. See their Table 5.

Dept. of National Health and Welfare (Ottawa), Control of radioactive fallout in water systems, 1965, have presented Teresi and Newcombe's 90 day scheme in form of a graph. Whatever the time after explosion, up to a year, one can read off the values for water contamination that would deliver 15 rems in 90 days. They also give a number of handy approximations to know. Curies of beta particle radioactivity = 2 x curies of gamma ray radioactivity for the first 3 months (p.7). One day following a nuclear detonation: curies of gamma radioactivity per sq. ft. = roentgens/hr divided by 100 (p.81).

*Tevini and Newcombe, 1961*

Table 6. Maximum permissible concentration (µrc/cm<sup>3</sup>) in water and air of radioactive fallout for seven exposure times (n) at seven different times after burst to deliver a dose to the critical organ of 15 rems in 90 days (1)\*

n	Exposure	Time after fission												
		3.5 hr	12 hr	1 day	2 days	4 days	7 days	14 days	28 days	105 days	210 days	365 days		
1	Ing.	2.5	0.81	0.48	0.29	0.18	0.13	6.9 × 10 <sup>-2</sup>	7.1 × 10 <sup>-2</sup>	0.10	0.10	0.10	8.7 × 10 <sup>-2</sup>	
	Inh.	3.7 × 10 <sup>-4</sup>	1.2 × 10 <sup>-4</sup>	6.9 × 10 <sup>-5</sup>	4.0 × 10 <sup>-5</sup>	2.4 × 10 <sup>-5</sup>	1.7 × 10 <sup>-5</sup>	8.2 × 10 <sup>-6</sup>	6.9 × 10 <sup>-6</sup>	6.4 × 10 <sup>-6</sup>	6.0 × 10 <sup>-6</sup>	5.7 × 10 <sup>-6</sup>		
7	Ing.	0.54	0.18	0.10	5.8 × 10 <sup>-2</sup>	3.6 × 10 <sup>-2</sup>	2.4 × 10 <sup>-2</sup>	1.2 × 10 <sup>-2</sup>	1.2 × 10 <sup>-2</sup>	1.5 × 10 <sup>-2</sup>	1.1 × 10 <sup>-2</sup>	1.3 × 10 <sup>-2</sup>		
	Inh.	7.7 × 10 <sup>-5</sup>	2.5 × 10 <sup>-5</sup>	1.4 × 10 <sup>-5</sup>	7.4 × 10 <sup>-6</sup>	4.5 × 10 <sup>-6</sup>	2.7 × 10 <sup>-6</sup>	1.2 × 10 <sup>-6</sup>	2.0 × 10 <sup>-6</sup>	7.0 × 10 <sup>-7</sup>	6.3 × 10 <sup>-7</sup>	6.5 × 10 <sup>-7</sup>		
14	Ing.	0.37	0.12	6.9 × 10 <sup>-2</sup>	3.9 × 10 <sup>-2</sup>	2.4 × 10 <sup>-2</sup>	1.5 × 10 <sup>-2</sup>	7.6 × 10 <sup>-3</sup>	7.1 × 10 <sup>-3</sup>	8.3 × 10 <sup>-3</sup>	7.7 × 10 <sup>-3</sup>	6.4 × 10 <sup>-3</sup>		
	Inh.	5.0 × 10 <sup>-5</sup>	1.8 × 10 <sup>-5</sup>	9.0 × 10 <sup>-6</sup>	5.0 × 10 <sup>-6</sup>	3.0 × 10 <sup>-6</sup>	1.8 × 10 <sup>-6</sup>	8.1 × 10 <sup>-7</sup>	6.1 × 10 <sup>-7</sup>	4.6 × 10 <sup>-7</sup>	4.3 × 10 <sup>-7</sup>	4.0 × 10 <sup>-7</sup>		
21	Ing.	0.32	0.11	5.9 × 10 <sup>-2</sup>	3.3 × 10 <sup>-2</sup>	2.0 × 10 <sup>-2</sup>	1.3 × 10 <sup>-2</sup>	5.8 × 10 <sup>-3</sup>	5.4 × 10 <sup>-3</sup>	5.7 × 10 <sup>-3</sup>	5.5 × 10 <sup>-3</sup>	4.5 × 10 <sup>-3</sup>		
	Inh.	4.4 × 10 <sup>-5</sup>	1.4 × 10 <sup>-5</sup>	7.7 × 10 <sup>-6</sup>	4.2 × 10 <sup>-6</sup>	2.4 × 10 <sup>-6</sup>	1.5 × 10 <sup>-6</sup>	6.2 × 10 <sup>-7</sup>	4.7 × 10 <sup>-7</sup>	3.4 × 10 <sup>-7</sup>	3.1 × 10 <sup>-7</sup>	2.8 × 10 <sup>-7</sup>		
30	Ing.	0.29	9.7 × 10 <sup>-2</sup>	5.4 × 10 <sup>-2</sup>	2.6 × 10 <sup>-2</sup>	1.8 × 10 <sup>-2</sup>	1.1 × 10 <sup>-2</sup>	5.3 × 10 <sup>-3</sup>	4.5 × 10 <sup>-3</sup>	4.4 × 10 <sup>-3</sup>	4.1 × 10 <sup>-3</sup>	3.3 × 10 <sup>-3</sup>		
	Inh.	3.7 × 10 <sup>-5</sup>	1.2 × 10 <sup>-5</sup>	6.7 × 10 <sup>-6</sup>	3.2 × 10 <sup>-6</sup>	2.1 × 10 <sup>-6</sup>	1.2 × 10 <sup>-6</sup>	4.9 × 10 <sup>-7</sup>	3.6 × 10 <sup>-7</sup>	2.5 × 10 <sup>-7</sup>	2.3 × 10 <sup>-7</sup>	2.0 × 10 <sup>-7</sup>		
60	Ing.	0.25	8.3 × 10 <sup>-2</sup>	4.6 × 10 <sup>-2</sup>	2.5 × 10 <sup>-2</sup>	1.5 × 10 <sup>-2</sup>	9.8 × 10 <sup>-3</sup>	4.3 × 10 <sup>-3</sup>	3.3 × 10 <sup>-3</sup>	2.7 × 10 <sup>-3</sup>	2.4 × 10 <sup>-3</sup>	1.8 × 10 <sup>-3</sup>		
	Inh.	3.2 × 10 <sup>-5</sup>	1.0 × 10 <sup>-5</sup>	5.4 × 10 <sup>-6</sup>	2.9 × 10 <sup>-6</sup>	1.5 × 10 <sup>-6</sup>	1.1 × 10 <sup>-6</sup>	3.7 × 10 <sup>-7</sup>	2.6 × 10 <sup>-7</sup>	1.7 × 10 <sup>-7</sup>	1.5 × 10 <sup>-7</sup>	1.4 × 10 <sup>-7</sup>		
90	Ing.	0.24	8.0 × 10 <sup>-2</sup>	4.4 × 10 <sup>-2</sup>	2.4 × 10 <sup>-2</sup>	1.4 × 10 <sup>-2</sup>	9.2 × 10 <sup>-3</sup>	3.8 × 10 <sup>-3</sup>	2.9 × 10 <sup>-3</sup>	2.1 × 10 <sup>-3</sup>	1.7 × 10 <sup>-3</sup>	1.3 × 10 <sup>-3</sup>		
	Inh.	3.1 × 10 <sup>-5</sup>	1.0 × 10 <sup>-5</sup>	5.4 × 10 <sup>-6</sup>	2.9 × 10 <sup>-6</sup>	1.7 × 10 <sup>-6</sup>	9.7 × 10 <sup>-7</sup>	3.6 × 10 <sup>-7</sup>	2.4 × 10 <sup>-7</sup>	1.5 × 10 <sup>-7</sup>	1.3 × 10 <sup>-7</sup>	1.2 × 10 <sup>-7</sup>		

\* Ing. = ingestion; Inh. = inhalation.

*Technical Note, 1961*

Table 7. Maximum permissible concentration ( $\mu\text{e}/\text{cm}^3$ ) in water and air of radioactive fallout for five exposure times (n) at eleven different times after burst to deliver a dose to the critical organ of 150 rems in 30 days (1).

n	Exposure	Time after fission										
		3.5 hr	12 hr	1 day	2 days	4 days	7 days	14 days	28 days	105 days	210 days	365 days
1	Ing.	27	8.5	5.1	3.0	2.0	1.4	0.78	0.83	1.2	1.3	1.1
	Inh.	$4.1 \times 10^{-3}$	$1.3 \times 10^{-3}$	$7.7 \times 10^{-4}$	$4.5 \times 10^{-4}$	$2.8 \times 10^{-4}$	$1.9 \times 10^{-4}$	$1.0 \times 10^{-4}$	$9.8 \times 10^{-5}$	$1.2 \times 10^{-4}$	$1.2 \times 10^{-4}$	$1.2 \times 10^{-4}$
7	Ing.	5.9	1.9	1.1	0.63	0.40	0.26	0.14	0.14	0.18	0.19	0.15
	Inh.	$8.6 \times 10^{-4}$	$2.8 \times 10^{-4}$	$1.3 \times 10^{-4}$	$8.0 \times 10^{-5}$	$5.6 \times 10^{-5}$	$3.7 \times 10^{-5}$	$1.8 \times 10^{-5}$	$1.7 \times 10^{-5}$	$2.0 \times 10^{-5}$	$2.0 \times 10^{-5}$	$1.9 \times 10^{-5}$
11	Ing.	4.3	1.4	0.78	0.43	0.27	0.18	8.8	$10^{-2}$	$8.7 \times 10^{-2}$	0.10	$7.9 \times 10^{-2}$
	Inh.	$7.2 \times 10^{-4}$	$2.3 \times 10^{-4}$	$1.3 \times 10^{-4}$	$6.3 \times 10^{-5}$	$3.8 \times 10^{-5}$	$2.5 \times 10^{-5}$	1.1	$10^{-5}$	$1.0 \times 10^{-5}$	$1.1 \times 10^{-5}$	$1.1 \times 10^{-5}$
21	Ing.	3.7	1.2	0.67	0.38	0.23	0.15	$7.3 \times 10^{-2}$	$6.8 \times 10^{-2}$	$8.1 \times 10^{-2}$	$6.6 \times 10^{-2}$	$5.2 \times 10^{-2}$
	Inh.	$5.4 \times 10^{-4}$	$1.8 \times 10^{-4}$	$9.7 \times 10^{-5}$	$5.5 \times 10^{-5}$	$3.3 \times 10^{-5}$	$2.0 \times 10^{-5}$	$9.3 \times 10^{-4}$	$8.6 \times 10^{-4}$	$8.9 \times 10^{-4}$	$8.6 \times 10^{-4}$	$8.7 \times 10^{-4}$
30	Ing.	3.6	1.1	0.62	0.34	0.21	0.14	$6.8 \times 10^{-2}$	$6.0 \times 10^{-2}$	$6.3 \times 10^{-2}$	$5.1 \times 10^{-2}$	$3.8 \times 10^{-2}$
	Inh.	$5.4 \times 10^{-4}$	$1.7 \times 10^{-4}$	$8.4 \times 10^{-5}$	$5.3 \times 10^{-5}$	$2.8 \times 10^{-5}$	$2.0 \times 10^{-5}$	$9.2 \times 10^{-4}$	$7.9 \times 10^{-4}$	$7.7 \times 10^{-4}$	$7.1 \times 10^{-4}$	$6.4 \times 10^{-4}$

\* Ing. = ingestion; Inh. = inhalation.



*Table 5.  $\gamma$ -field measurements (mr/hr) for maximum permissible water contamination*

This table applies to any fresh fallout contamination and is for 10 day consumption. Values should be halved for 30 day consumption.

Water body	Time since bomb burst			
	12 hr	1 day	2 days	10 days
Reservoir or lake, measured far from shore	100	50	25	12
Reservoir, pond, etc., measured at various lengths from shore, close to surface and over water at least 2 ft. deep	50	25	12	6
Water tank, from 150 to 1000 gal measured in contact with center of one surface	50	25	12	6
Water can, from 2 to 4 gal	25	12	6	3

G.W.C. TAIT and W.F. Merritt  
1958

# Radiation Risk and Ethics

by [Zbigniew Jaworowski\\*](#)

(This article, while perhaps no longer available there, originally appeared in: [Physics Today](#), 52(9), September 1999, pp. 24-29, [American Institute of Physics](#).)

---

**The established worldwide practice of protecting people from radiation costs hundreds of billions of dollars a year to implement and may well determine the world's future energy system. But is it right?**

---

The psychosomatic disorders observed in the 15 million people in Belarus, Ukraine, and Russia<sup>1</sup> who were affected by the April 1986 Chernobyl accident are probably the accident's most important effect on public health.<sup>2</sup> These disorders could not be attributed to the ionizing radiation, but were assumed to be linked to the popular belief that any amount of man-made radiation—even minuscule, close to zero doses—can cause harm, an assumption that gained wide currency when it was accepted in the 1950s, arbitrarily, as the basis for regulations on radiation and nuclear safety.

It was under the same assumption that an *ad hoc* Soviet government commission decided to evacuate and relocate more than 270 000 people from many areas of the former Soviet Union where the 1986–95 average radiation doses from the Chernobyl fallout ranged between 6 and 60 millisieverts.

[Note by Bruce: 1 sievert (Sv) = 100 rem. Therefore a millisievert would be about 10 millirem. Remembering that a millirem is one thousandth of a rem and a rem is equivalent to a rad, gray, or roentgen all of what we call 1 R, you can see how low these peace time events were. 1 rem = 0.01 sievert (Sv)]

By comparison, the world's average individual lifetime dose due to natural background radiation is about 150 mSv. In the Chernobyl-contaminated regions of the former Soviet Union, the lifetime dose is 210 mSv—and in many regions of the world it is about 1000 mSv.<sup>3</sup> The forced evacuation of so many people from their—presumably—poisoned homes calls for ethical scrutiny. Examining the physical and moral basis of that evacuation action and other radiation policies is the subject of this article.

As they have developed over the last three decades, the principles and concepts of radiation protection seem to have gone astray and to have led to exceedingly prohibitive standards and impractical recommendations. Revision of these principles and concepts is now being proposed by an increasing number of scientists and several organizations. They include Roger Clarke, who chairs the International Commission on Radiological Protection, the Health Physics Society, and the French Academy of Sciences. In addition, in April this year, the United Nations Scientific Committee on the Effects of Atomic Radiation (UNSCEAR) decided to study a possible revision of the basic dosimetric and biological concepts and quantities generally being applied in radiation protection. In the years to come, such reevaluations may trigger what I believe will be welcome changes in the basic worldwide approach to radiological protection.

### **Natural and man-made radiation**

We are all immersed in naturally occurring ionizing radiation. Radiation reaches us from outer space and it comes from radionuclides

present in rocks, buildings, air, and even our own bodies. Each flake of snow, each grain of soil, every drop of rain—and even every person on this planet—emits radiation. And every day, at least a billion particles of natural radiation enter our bodies.

The individual dose rate of natural radiation the average inhabitant of Earth receives is about 2.2 mSv per year. In some regions—for example, parts of India, Iran, and Brazil—the natural dose rate is up to a hundred times higher. And no adverse genetic, carcinogenic, or other malign effects of those higher doses have ever been observed among the people, animals, and plants that have lived in those parts since time immemorial.<sup>4,5</sup>

In the case of man-made radiation, the global average dose has increased by about 20% since the beginning of the 20th century—mainly as a result of the broader application of x-ray diagnostics in medicine. Other major sources of man-made radiation, such as nuclear power, nuclear weapons tests and the Chernobyl accident, have contributed only a tiny proportion—less than 0.1%—to that increase.

In the regions of the former Soviet Union that were highly contaminated by the fallout from the Chernobyl accident, the increased radiation dose rate for local inhabitants is far less than the dose rate in areas of high natural radiation. In those places, the entire man-made contribution to radiation dose amounts to a mere 0.2% of the natural component.

Three and a half billion years ago, when life on Earth began, the natural level of ionizing radiation at the planet's surface was about three to five times higher than it is now.<sup>6</sup> Quite possibly, that radiation was needed to initiate life on Earth. And it may be essential to sustain extant life-forms, as suggested by experiments with protozoa and bacteria.<sup>7</sup>

At the early stages of evolution, increasingly complex organisms developed powerful defense mechanisms against such adverse radiation effects as mutation and malignant change. Those effects originate in the cell nucleus, where the DNA is their primary target. That evolution has apparently proceeded for so long is proof, in part, of the effectiveness of living things' defenses against radiation.

Other adverse effects—which lead to acute radiation sickness and premature death in humans—also originate in the cell, but outside its nucleus. For them to take place requires radiation doses thousands of times higher than those from natural sources. A nuclear explosion or cyclotron beam could deliver such a dose; so could a defective medical or industrial radiation source. (The malfunctioning Chernobyl reactor, whose radiation claimed 28 lives, is one example.)

The concern about large doses is obviously justified. However, the fear of small doses, such as those absorbed from the Chernobyl fallout by the inhabitants of central and western Europe, is about as justified as the fear that an atmospheric temperature of 20°C may be hazardous because, at 200°C, one can easily get third-degree burns—or the fear that sipping a glass of claret is harmful because gulping down a gallon of grain alcohol is fatal.

According to recent studies, by far the most DNA damage in humans is spontaneous and is caused by thermodynamic decay processes and by reactive free radicals formed by the oxygen metabolism. Each mammalian cell suffers about 70 million spontaneous DNA-damaging events per year.<sup>8</sup> Only if armed with a powerful defense system could a living organism survive such a high rate of DNA damage.

An effective defense system consists of mechanisms that repair DNA, and other homeostatic mechanisms that maintain the integrity of organisms, both during the life of the individual and for thousands of

generations. Among those homeostatic mechanisms are enzymatic reactions, apoptosis (that is, suicidal elimination of changed cells), cell cycle regulation, and intercellular interactions.

Ionizing radiation damages DNA also, but at a much lower rate. At the present average individual dose rate of 2.2 mSv per year, natural radiation could be responsible for no more than about 5 DNA-damaging events in one cell per year.

Perhaps we humans lack a specific organ for sensing ionizing radiation simply because we do not need one. Our bodies' defense mechanism provides ample protection over the whole range of natural radiation levels—that is, from below 1 mSv to above 280 mSv per year.<sup>3,4</sup> That range is much greater than the range of temperatures—about 50K—that humans are normally exposed to. Increasing the water temperature in your bath tub by only 80 K, from a pleasant level of 293 K to boiling point at 373 K (that is, by a factor of only 1.3), or decreasing it below freezing point (that is, by a factor of 1.07), would eventually kill you.

Because such lethal high or low temperatures are often found in the biosphere, the evolutionary development of an organ that can sense heat and cold has been essential for survival. Organs of smell and taste have been even more vital as defenses against dangerously toxic or infected food. But a lethal dose of ionizing radiation delivered in one hour—which for an individual human is 3000 to 5000 mSv—is a factor of 10 million higher than the average natural radiation dose that one would receive over the same time period (0.00027 mSv). Compared with other noxious agents, ionizing radiation is rather feeble. Nature seems to have provided living organisms with an enormous safety margin for natural levels of ionizing radiation—and also, adventitiously, for man-made radiation from controlled, peacetime sources.

In short, conditions in which levels of ionizing radiation could be noxious do not normally occur in the bio-sphere, so no radiation-sensing organ has been needed in humans and none has evolved.

### Why radiophobia?

If radiation and radioactivity, though ubiquitous, are so innocuous at normal levels, why do they cause such universal apprehension? What is the cause of radiophobia—the irrational fear that any level of ionizing radiation is dangerous? Why have radiation protection authorities introduced a dose limit for the public of 1 mSv per year, which is less than half the average dose rate from natural radiation and less than 1% of the natural dose rates in many areas of the world? Why do the nations of the world spend hundreds of billions of dollars a year to maintain this standard?<sup>9</sup>

Here I propose some likely reasons:

- The psychological reaction to the devastation and loss of life caused by the atomic bombs dropped on Hiroshima and Nagasaki at the end of World War II.
- Psychological warfare during the cold war that played on the public's fear of nuclear weapons.
- Lobbying by fossil fuel industries.
- The interests of radiation researchers striving for recognition and budget.
- The interests of politicians for whom radiophobia has been a handy weapon in their power games (in the 1970s in the US, and in the 1980s and 1990s in eastern and western Europe and in the former Soviet Union).

- The interests of news media that profit by inducing public fear.
- The assumption of a linear, no-threshold relationship between radiation and biological effects.

Since nuclear weapons are regarded as a deterrent, naturally the countries that possess them wish to make radiation and its effects seem as dreadful as possible. Not surprisingly, national security agencies seldom qualify or correct even the most obviously false statements, such as “Radiation from a nuclear war can annihilate all mankind, or even all life,” or “200 grams of plutonium could kill every human being on Earth.”<sup>10</sup>

The facts say otherwise. Between 1945 and 1980, the 541 atmospheric nuclear tests that were performed together yielded an explosive energy equivalent to 440 megatons of TNT ( $1.8 \times 10^{24}$  joules). After all those explosions, despite the injection into the global atmosphere of about 3 tons of plutonium (that is, almost 15 000 supposedly deadly 200-gram doses), somehow we are still alive! The average individual dose of radiation from all these nuclear explosions, accumulated between 1945 and 1998, is about 1 mSv, which is less than 1% of the natural dose for that period.

In the heyday of atmospheric testing, 1961 and 1962, there were 176 atmospheric explosions, with a total yield of 84 megatons. The maximum deposition on Earth’s surface of radionuclides from those explosions took place in 1964. The average individual dose accumulated from the fallout between 1961 and 1964 was about 0.35 mSv.

At its cold war peak of 50 000 weapons, the global nuclear arsenal had a combined potential explosive power of about 13 000 megatons,



which was only 30 times larger than the megatonnage already released in the atmosphere by all previous nuclear tests. If that whole global nuclear arsenal had been deployed in the same places as the previous nuclear tests, the average individual would have received a lifetime radiation dose of about 30 mSv from the ensuing worldwide fallout. If we use the years 1961 and 1962 as a yardstick instead, the dose would have risen to about 55 mSv. And even exploding all the nuclear weapons in just a few days rather than over a two-year period would not change that estimate by very much. Clearly, 55 mSv is a far cry from the short-term dose of 3000 mSv that would kill a human.

Of course, the approach taken above, based as it is on averages, fails to account for the immense loss of life and human suffering caused by the mechanical blast, fires, and local fallout that follow nuclear explosions in highly populated areas. However, no matter what the losses to those areas might be, it is certain that human and other life on Earth would survive even an all-out global nuclear war.

#### **A-bomb survivors and linear no-threshold**

The survivors of the atomic bombing of Hiroshima and Nagasaki who received instantaneous radiation doses of less than 200 mSv have not suffered significant induction of cancers.<sup>[11](#)</sup> And so far, after 50 years of study, the progeny of survivors who were exposed to much higher, near-lethal doses have not developed adverse genetic effects.<sup>[12](#)</sup>

Until recently, such findings from the study of A-bomb survivors had been consistently ignored. In place of the actual findings—and driving the public's radiophobia—has been the theory of linear no-threshold (LNT), which presumes that the detrimental effects of radiation are proportional to the dose, and that there is no dose at which the effects of radiation are not detrimental.

It was LNT theory that the International Commission on Radiological

Protection chose, in 1959, as the basis for its rules of radiation protection. At that time, applying LNT theory was regarded as an administrative decision, based on practical (not to mention political<sup>13</sup>) considerations. Adopting a linear relationship between dose and effect, along with no threshold, enabled doses in individual exposures to be added and enabled population-averaged quantities to be evaluated, and made the administration of radiation protection generally easier. Furthermore, the policy undertone—that even the smallest, near-zero amounts of radiation could cause harm—was politically useful at the time: It played an important part in effecting first a moratorium and then a ban on atmospheric nuclear tests. LNT theory was and still is the pillar of the international theory and practice of radiation protection.

Over the years, however, what started as just a working assumption for the leadership of ICRP came to be regarded—in public opinion and by the mass media, regulatory bodies, and many scientists, and even by some members of the ICRP—as a scientifically documented fact.

The absurdity of the LNT was brought to light after the Chernobyl accident in 1986, when minute doses of Chernobyl radiation were used by Marvin Goldman, Robert Catlin, and Lynn Anspaugh to calculate that 53 400 people would die of Chernobyl-induced cancer over the next 50 years.<sup>14</sup> The frightening death toll was derived simply by multiplying the trifling Chernobyl doses in the US (0.0046 mSv per person) by the vast number of people living in the Northern Hemisphere and by a cancer risk factor based on epidemiological studies of 75 000 atomic bomb survivors in Japan. But the A-bomb survivor data are irrelevant to such estimates, because of the difference in the individual doses and dose rates. A-bomb survivors were flashed within about one second by radiation doses at least 50 000 times higher than those which US inhabitants will ever receive, over a period of 50 years, from the Chernobyl fallout.

We have reliable epidemiological data for a dose rate of, say, 6000

mSv per second in Japanese A-bomb survivors. But there are no such data for human exposure at a dose rate of 0.0046 mSv over 50 years (nor will there ever be any). The dose rate in Japan was larger by  $2 \times 10^{15}$  than the Chernobyl dose rate in the US. Extrapolating over such a vast span is neither scientifically justified nor epistemologically acceptable. Indeed, Lauriston Taylor, the former president of the US National Council on Radiological Protection and Measurements, deemed such extrapolations to be a “deeply immoral use of our scientific heritage.”

### **Radiation dose and eternity**

An offspring of the LNT assumption is the concept of dose commitment, which was introduced in the early 1960s. At that time, the concept reflected the concern that harmful hereditary effects could be induced by fallout from nuclear tests. After almost four decades, the concept of dose commitment is still widely used, although both the concept and the concern ought to have faded into oblivion by now.

UNSCEAR, which first used “dose commitment” in 1962, defined it as “the integral over infinite time of the average dose rate in a given tissue for the world population, as a result of a given practice—for example, a given series of nuclear explosions.” Such integration requires making some daring assumptions and having a superhuman omniscience about population dynamics and environmental changes for all the eons of time to come. Later, in a humbler frame of mind, UNSCEAR introduced the so-called truncated dose commitment, limited arbitrarily to 50, 500, 10 000 or many millions of years. However, the original “infinite” definition is still retained in recent UNSCEAR documents.

To accept the definitions of dose commitment and of collective dose, we must also accept the following premises:

- An LNT relationship between absorbed dose and risk to an individual.
- The additivity of risk (by means of the additivity of dose) during the lifetime of an individual.
- The additivity of risk (dose) across individuals of the same generation.
- The additivity of risk (dose) across the lifetimes of individuals over any number of generations.
- The expectation that late harm due to a dose accumulated over many years or generations (dose commitment) be the same as the harm done by an instantaneous dose of the same magnitude.
- The expectation that late harm due to a given value of collective dose or dose commitment calculated for a large number of people exposed to trifling doses be the same as that calculated for a small number of people exposed to large doses. (This expectation is contrary to the common practice of diluting or dispersing noxious agents below dangerous levels.)

In 1969, UNSCEAR advised making the level of natural radiation a convenient reference for comparing dose commitments from man-made sources. However, during the three decades since the introduction of the dose commitment concept, UNSCEAR has not followed its own advice. The collective dose commitment for the world population from natural sources, truncated to 50 years (650 000 000 man Sv), was published for the first time in UNSCEAR's 1993 report. But why stop at 50 years—when, for man-made radiation, UNSCEAR estimates the dose commitments over infinite time? It is easy to calculate the individual dose commitment from past exposures

to natural radiation for periods comparable to those used for calculating man-made sources of radiation. In making the calculation, one may assume that during the past several million years the natural radiation dose rate has been the same as is now—that is, 2.2 mSv per year.

In the table on this page are presented the values of truncated natural dose commitment for various periods since the putative appearance of some of our ancestors. One may compose a similar table for the collective truncated dose commitments for the global populations integrated over the past generations, information that is also given in the table. One may also calculate the future natural dose commitments of our descendants for tens or thousands of generations.

[Bruce: There was a table here and a couple of other places in the original article but I have not included the tables and figures.]

Each of us is burdened with these values of dose commitment. Do these values represent anything real, or are they just an academic abstraction? What are the medical effects of these enormously high doses?

In an international study, the collective dose for the world population from nuclear dumping operations in the Kara Sea (part of the Arctic Ocean), truncated to the year 3000 AD, has been estimated to be about 10 manSv. Let us explore the implications of that value, which may be equivalent to:

$2 \times 10^{-12}$  Sv per each of  $5 \times 10^9$  people now living and their descendants from 33 generations in 1000 years (no concern).

Obviously, the use of collective dose obliterates information on the patterns of dose deposition in space and time, which are of major importance for estimating their biological effects, in terms of risk to

humans. Individual doses cannot be additive over generations, simply because humans are mortal, and the dose dies when an individual does. Similarly, individual doses cannot be added for individuals of the same generation because we do not contaminate one another with a dose that we have absorbed. The presence of biological repair processes and the multistage process of cancer induction render the linear addition of small contributions of individual dose to estimate the associated risk of cancer occurrence highly unlikely. Collective dose and dose commitment cannot have any biological meaning. The large values of collective doses and collective dose commitments that have often been published were derived from minuscule individual doses.

For example, UNSCEAR's calculations include the following:

- 100 000 man Sv from nuclear explosions during the past 54 years,
- 205 000 man Sv for the global population in the next 10 000 years from power reactors and reprocessing plants,
- 600 000 man Sv from Chernobyl fallout in the Northern Hemisphere for eternity,
- and 650 000 000 man Sv for the world's population from natural radiation in the past 50 years.

These large values, terrifying as they are to the general public, do not imply that individuals or populations are harmfully burdened by nuclear explosions, nuclear power plants, Chernobyl fallout, or nature. In fact, they provide society with no relevant biological or medical information. Rather, they create a false image of the imminent danger of radiation, with all its actual negative social and psychosomatic consequences. If harm to the individual is trivial, then the total harm to members of his or her society over all past or future time must also be trivial—regardless of how many people are or will have been exposed to natural or man-made radiation. The intellectually invalid concepts of collective dose and dose commitment deserve to be hacked off with

William of Occam's razor .

### **Enter hormesis**

The LNT theory is contradicted by the phenomenon of hormesis—that is, the stimulating and protective effect of small doses of radiation, which is also termed adaptive response. The first report on hormetic effects in algae appeared more than 100 years ago.<sup>16</sup> More recently published hormetic effects include A-bomb survivors' apparent lower-than-normal incidence of leukemia and their greater longevity.<sup>17</sup> Although more than 2000 scientific papers had been published on radiation hormesis, the phenomenon was forgotten after World War II and was ignored by the radiation-protection establishment. It was only in 1994 that UNSCEAR recognized and endorsed the very existence of radiation hormesis. It caused a revolutionary upheaval of radiology's ethical and technical foundations.

Many radiologists have come to realize that their overreaction to theoretical (actually imaginary) health-harming effects of radiation is unethical in that it leads to the consumption of funds that are desperately needed to deal with real health problems. Applying the no-threshold principle for the alleged protection of the public has led to the imposition of restrictive regulations on the nuclear utilities, restrictions that have virtually strangled the development of environmentally benign nuclear energy in the US and in other countries. My own country, Poland, spent billions of dollars on the construction of its first nuclear power reactor—only to abandon the project after what I regard as the politically motivated manipulation of public opinion by means of the LNT theory.

Each human life hypothetically saved in a Western industrial society by implementation of the present radiation protection regulations is estimated to cost about \$2.5 billion. Such costs are absurd and immoral—especially when compared to the relatively low costs of

saving lives by immunization against measles, diphtheria, and pertussis, which in developing countries entails costs of \$50 to \$99 per human life saved.<sup>18</sup> Billions of dollars for the imaginary protection of humans from radiation are actually spent year after year, while much smaller resources for the real saving of lives in poor countries are scandalously lacking.

### **A practical alternative**

There is an emerging awareness that radiation protection should be based on the principle of a practical threshold—one below which induction of detectable radiogenic cancers or genetic effects is not expected. Below such a threshold, radiation doses should not require regulation. Nor is any regulation required for extreme levels, such as those experienced at Hiroshima and Nagasaki, where dose rates were extremely high.

The practical threshold to be proposed could be based on epidemiological data from exposures in medicine, the nuclear industry, and regions with high natural radiation. The current population dose limit of 1 mSv per year could then be changed to 10 mSv per year or more. Individual doses could be evaluated at any level below the practical threshold, but radiation-protection authorities would be required to intervene only if individual doses above the threshold were involved. Adopting a practical threshold would be an important step taken toward dealing with radiation rationally and toward regaining the public's acceptance of radioactivity and radiation as blessings for mankind.

\*\*\*\*\*

*\*Zbigniew Jaworowski is a professor at the Central Laboratory for Radiological Protection in Warsaw, Poland, and has served on the United Nations Scientific Committee on the Effects of Atomic Radiation. His e-mail address is: [jaworo@clor.waw.pl](mailto:jaworo@clor.waw.pl).*

\*\*\*\*\*

### **References**



1. L. A. Ilyin, *Chernobyl: Myth and Reality*, Megapolis, Moscow (1995).
2. *Chernobyl—Ten Years On, Radiological and Health Impact*, Nuclear Energy Agency, Organization for Economic Co-operation and Development, Paris (1996).
3. *Sources and Effects of Ionizing Radiation*, UNSCEAR, New York (1993).
4. M. Sohrabi, in *High Levels of Natural Radiation*, J. U. A. M. Sohrabi, S. A. Durrani, eds., International Atomic Energy Authority, Vienna, Austria (1990), p. 39.
5. P. C. Kesavan, in *High Levels of Natural Radiation* L. Wei, T. Sugahara, Z. Tao, eds. Elsevier, Amsterdam (1996), p. 111.
6. P. A. Karam, S. A. Leslie, in *Proc. 9th Congress of the International Radiation Protection Association*, International Atomic Energy Authority, Vienna, Austria (1996), p. 12.
7. H. Planel *et al.*, *Health Physics* **52** (5), 571 (1987).
8. D. Billen, *BELLE Newsletter* **3** (1), 8 (1984).
9. J. S. Hezir, statement at the US Environmental Protection Agency's public hearing on the proposed recommendations for federal radiation protection guidance for exposure of the general public, held in Washington, DC, on 22–23 February 1995.
10. H. Koning, *International Herald Tribune*, 27 November 1996, p. 9.
11. B. L. Cohen, *Radiation Research* **149**, 525 (1998).
12. K. Sankaranarayanan, lecture presented at 46th session of the

United Nations Scientific Committee on the Effects of Atomic Radiation, 18 June 1997.

13. L. S. Taylor, *Proc. International Congress of the International Radiation Protection Association*, Israel Health Physics Society, Jerusalem (1980), p. 307.

14. M. Goldman, R. J. Catlin, L. Anspaugh, US Department of Energy research report, DOE/RR-0232 (1987).

15. K.L. Sjöblom, G. Linsley, International Atomic Energy Authority Bulletin **40** (4), 18 (1999).

16. G. F. Atkinson, *Science* **7**, 7 (1898).

17. S. Kondo, *Health Effects of Low-level Radiation*, Kinki U. P., Osaka, Japan (1993).

18. B. L. Cohen, in *Rational Readings on Environmental Concerns*, J. H. Lehr, ed., Van Nostrand Reinhold, New York (1992), p. 461.

**MENU:** [HOME](#) » [Reconstruction](#) » [Recovery](#) » [Renewal](#) » [Survival](#)

---

---


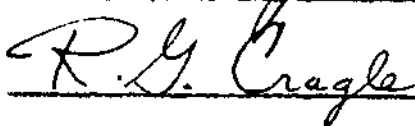
May 26, 1959

To the Graduate Council:

I am submitting herewith a thesis written by David Gene Easterly entitled "Removal of Strontium-89 and Calcium-45 from Milk by Use of Ion Exchange Resins." I recommend that it be accepted for nine quarter hours of credit in partial fulfillment of the requirements for the degree of Master of Science, with a major in Dairying.

  
\_\_\_\_\_  
Major Professor

We have read this thesis  
and recommend its acceptance:

  
\_\_\_\_\_  
  
\_\_\_\_\_

Accepted for the Council:

  
\_\_\_\_\_  
Dean of the Graduate School



**REMOVAL OF STRONTIUM-89 AND CALCIUM-45 FROM MILK BY  
USE OF ION EXCHANGE RESINS**

---

**A THESIS**

**Submitted to  
The Graduate Council  
of  
The University of Tennessee  
in  
Partial Fulfillment of the Requirements  
for the degree of  
Master of Science**

---

by

**David Gene Easterly**

**June 1959**

**ACKNOWLEDGEMENTS**

The author wishes to express his sincere appreciation to Dr. B. J. Demott for his assistance in planning and conducting this study, and to Dr. R. G. Cragle for his guidance and assistance in helping to conduct this study. Great appreciation is due the UT-AEC Agricultural Research Laboratory, Oak Ridge, Tennessee, for facilities used in this study and especially to Dr. N. S. Hall, the Director, for encouragement and suggestions. Appreciation is also due R. C. McIlhenny for his advice and suggestions. The author is also exceedingly grateful to one and all of the laboratory staff for the help and advice so freely given.

## TABLE OF CONTENTS

	PAGE
INTRODUCTION . . . . .	1
REVIEW OF LITERATURE . . . . .	2
Ion exchange . . . . .	2
Radioactive strontium . . . . .	7
Radiostrontium movement from atmosphere to milk . . . . .	9
EXPERIMENTAL PROCEDURE . . . . .	13
Removal of strontium-89 and calcium-45 from milk of dosed cows . . . . .	13
Removal of Strontium-89 and calcium-45 from dosed milk . . . . .	17
Post-milk and lactone-milk equilibrium studies	17
Removal of calcium-45 and strontium-89 from milk by use of a series of four columns . . . . .	18
Removal of strontium-89 and calcium-45 from dosed milk by the batch method . . . . .	19
RESULTS AND DISCUSSION . . . . .	20
SUMMARY . . . . .	22
BIBLIOGRAPHY. . . . .	50

## LIST OF TABLES

TABLE	PAGE
I. Per Cent Removal of Sr <sup>90</sup> and Ca <sup>45</sup> from Milk of Dosed Cows by Exchange Resin Columns . . . . .	21
II. Per Cent Removal of Sr <sup>90</sup> and Ca <sup>45</sup> From Dosed Milk by Exchange Resin Columns . . . . .	23
III. Analyses of Variances From Eight Trials on Removal of Ca <sup>45</sup> and Sr <sup>90</sup> From Milk of Dosed Cows and Eight Trials on Removal of Ca <sup>45</sup> and Sr <sup>90</sup> From Dosed Milk . . . . .	26
IV. Coagulation Time, Curd Tension, pH and Titratable Acidity of Milk Passed Through an Ion Exchange Column Containing Dowex 50W-X12 Calcium Form. . . . .	29
V. Effect of Resin-Milk Contact Time on Per Cent Removal of Sr <sup>90</sup> and Ca <sup>45</sup> From Dosed Milk . . . . .	35
VI. Effect of Isotope-Milk Contact Time on Per Cent Removal of Sr <sup>90</sup> and Ca <sup>45</sup> From Dosed Milk. . . . .	37
VII. Per Cent Removal of Sr <sup>90</sup> and Ca <sup>45</sup> From Milk by Use of a Series of Four Exchange Resin Columns . . . . .	39
VIII. Radioactivity Retained by Resin After Passage of Milk Containing Ca <sup>45</sup> and Sr <sup>90</sup> . . . . .	40



## LIST OF TABLES (Continued)

TABLE	PAGE
IX. Effect of Milk-Resin Ratio on Per Cent Removal of Sr <sup>90</sup> and Ca <sup>45</sup> From Milk . . . . .	41
X. Per Cent of Resin Capacity Exchange by Calcium and Strontium using the Batch and Column System . . . . .	46

## LIST OF FIGURES

FIGURE	PAGE
1. Modified Ion Exchange Column . . . . .	14
2. Effect of Resin-Milk Contact Time on Per Cent Removal of Sr <sup>89</sup> and Ca <sup>45</sup> From Dosed Milk . . . . .	36
3. Effect of Milk-Resin Ratio on Per Cent Removal of Sr <sup>89</sup> and Ca <sup>45</sup> From Milk . . . . .	42
4. Relationship of Milk-Resin Ratio and the Percentage Exchange of Calcium-45 and Strontium-89 . . . . .	44

## INTRODUCTION

The increased usage of nuclear power and the testing of atomic weapons have brought the problem of damaging effects of radiation to public attention. In recent months much publicity has been given the passage of strontium from the atmosphere into food and its accumulation in bone.

Due to its long half-life and its biological similarity to calcium, strontium is generally regarded to be one of the principal fission products which are of concern to the health of humans. The strontium level in milk has been steadily rising since 1954, the year adequate routine measures were first made. Since milk is the principal source of calcium of most Western Countries (people in the United States receive 85 per cent of their dietary calcium from milk products) (17) it has received attention as a source of strontium.

If the strontium content of milk could be reduced the overall strontium in the diet would be reduced.

The object of this investigation was to determine the feasibility of the use of ion exchange resins to remove strontium from milk.

## REVIEW OF THE LITERATURE

### Ion Exchange

Although the treatment of water by solid adsorbents such as sand is probably as ancient as civilization itself, the phenomenon of ion exchange was first recognized as such in soil experiments. In 1850, two Agricultural Chemists, Thompson (28) and Way (29) reported on exchange properties of certain soils. Their experiments showed that upon treating certain types of soils with either ammonium sulfate or ammonium carbonate most of the ammonia was adsorbed and lime was released. After further study they decided that such action was due to the complex silicates present in the soils, and concluded that ion exchange was taking place.

The first industrial use of ion exchange was attempted by Harms (13) in 1896. His effort to purify sugar juice by use of base exchange silicates was only partly successful. Gans (9), in 1906 also attempted to utilize ion exchange for industrial purposes. This experimenter employed both natural and synthetic aluminum silicates for the purpose of softening waters and for treating sugar solutions. A significant step in ion exchange history was the observation by Adams and Holmes (1) in 1935, that certain synthetic resins were capable of exchanging ions.

The explanation for the phenomenon of ion exchange may be grouped into three theories; the crystal-lattice exchange theory, the double-layer theory, and the Donnan membrane theory.

The crystal-lattice theory explains ion exchange by assuming that in an ionic solid the constituents of the crystal lattice are present as ions instead of molecules. Complete dissociation of the ionic solid is assumed. Each ion in the crystal is surrounded by a fixed number of ions of opposite charge, and since the coulomb attractive force between these ions is dependent upon the charge on the ions and the distance between them, the ions on the surface are bound less closely than those beneath the crystal surface. When placed in a medium such as water, these surface ions may be easily replaced by ions in solution.

The ease with which the surface ions may be replaced by another ion depends on (a) the nature of the forces binding the ion to the crystal, (b) the concentration of the exchanging ion, (c) the charge of the exchanging ion, (d) size of the two ions, (e) the accessibility of lattice ions, and (f) solubility effects (16).

The double-layer theory, as an explanation of the electrokinetic properties of colloids, has been considered by many to explain ion exchange. The exchange material is believed to be a fixed inner layer of charges surrounded by a diffuse and mobile outer layer of charges which extend into the external liquid media. There is no sharp boundary between the ions in the diffuse outer layer and those in the equilibrium external medium. It may be considered that the concentration of the ions constituting the diffuse layer as varying continuously and depending upon the concentration and pH of the external solution. Therefore, any change in the concentration of the ions in the external solution

upsets the equilibrium and a new equilibrium is obtained. Some of the ions held in the diffuse outer layer will be replaced by some of the new ions.

The Donnan membrane theory pertains to the unequal distribution of ions on two sides of a membrane, when one side contains ions too large to diffuse through the membrane. An unequal distribution will occur because of the undiffusible ions and the necessity of maintaining electroneutrality.

In applying the latter theory to ion exchange, the exchange material is assumed to be the ion too large to diffuse, and although in ion exchange no membrane is used, the interface between the solid and liquid phases is assumed to represent a membrane (16).

Otting (25) discusses the problems involved in the changing of equipment used for water treatment to a design which would be satisfactory from the sanitary viewpoint for ion exchange work in milk. The gravel in the bottom of the water softening device was replaced by a wire screen and a perforated plate to reduce the milkstone. Before a commercially feasible process resulted many changes in design of equipment and revival methods were necessary.

Milk can be modified by treatment with various types of organic ion exchange materials to produce certain desired characteristics. Haller and Morin (12) found that the type and extent of modification can be controlled at will by using the proper exchangers or combination of exchangers and by the proper regeneration of these exchangers. In one treatment these workers produced a soft curd milk of normal pH.

In another, approximately 20 per cent of the citrates, phosphates, and chlorides in addition to calcium and other cations were removed. Still another treatment removed citrates and chlorides and small amounts of calcium and other cations, but no phosphates.

In order to make cow's milk more suitable for the feeding of infants, modifications of the milk is necessary, particularly in the matter of curd tension. In 1930 Lyman (21) revealed that calcium could be removed from cow's milk by placing it in contact with greensand, a highly siliceous sand containing a little magnesia and alumina, and that the resulting milk exhibited soft-curd properties. This application of base-exchange silicates to the commercial treatment of dairy products was probably the first successful use of this principle in connection with a food product.

Murthy and Whitney (23) investigated the effect of mixed cation and anion resins upon the salt content of milk. The batch process was used to treat fresh raw skim milk with cationic and anionic resin mixtures at four different levels each. The pH and the calcium, sodium, and potassium content decreased with increases in cation resin concentration. Citrate, chloride, and sulfate content decreased with increases in anion resin concentration. The nitrogen content was not affected except when coagulation occurred.

Sasaki, et al. (26) studied the effects of treatment with ion exchange resin on heat coagulation of milk. Calcium was adsorbed on a cation exchanger of sulfonic acid structure but no clear relationship was observed between the removal of calcium and the temperature of heat coagulation of milk.

Gehrke and Almy (10) investigated the adsorption affinity to synthetic ion exchange resins of the cations and anions normal to milk. The relative order of adsorption of the cations from the synthetic whey solution was found to be  $\text{Ca}^{++}$   $\text{Mg}^{++}$   $\text{K}^+$   $\text{Na}^+$ .

Baker and Gehrke (4) developed an ion exchange resin contact time method to study the equilibria of calcium in milk and to measure directly the ion-exchangeable calcium. They also reported (5) that heating skim milk to 40°, 60°, and 80° C. for 30 minutes had no noticeable effect on the exchangeability of calcium. However, the exchangeable calcium was significantly decreased as the temperature of heating increased from 100° to 120° C. for holding times of 30 minutes. Similar results were reported by Gehrke and Smith (11) who also observed that as the pH is increased the per cent of instantaneously exchangeable calcium decreases.

Two methods of recovering lactose from cheddar cheese whey were studied by McGlasson and Boyd (22). One method involved passing the original whey through ion exchange resins, removing the whey protein by heat treatment and further purifying the removed lactose solution with ion exchange resins. The second method differed from this only in that the original whey was not treated with ion exchange resins prior to the recovery of the protein fraction. Lactose with a higher degree of purity was recovered by the second method.

Josephson and Reeves (14) found that when mineral ion exchange treated milk was added to evaporated milk it was capable of stabilizing the evaporated product against coagulation during steriliza-



tion at 240° F. for 15 minutes. Mineral ion exchange milk was found to be effective in stabilizing milks exhibiting a wide range of instability to heat.

Nervik, et al. (24), by both a column and a bulk technique, removed nearly 90 per cent of the tracer isotopes of calcium and strontium from milk to which they had added isotopes, using Dowex-50W resin in the sodium form.

### Radioactive Strontium

The strontium isotopes (mass numbers 84 through 94 and 97) may be formed as fission products and from the bombardment of other isotopes by nuclear particles. In the fission of Uranium-235 the strontium isotopes have a relatively large yield (about 5.8 per cent strontium-90). No radiation problem is presented by the stable isotopes of strontium 84, 86, 87 and 88. An isomeric form of strontium-87 and the isotopes 91, 92, 93, 94 and 97 have relatively short half-lives (range from ten hours to less than two minutes) and consequently, would decay rapidly compared to an isomeric form of strontium-85 and the isotopes 89 and 90, which have half-lives of 65 days, 55 days, and 25 years, respectively.

Strontium is one of the alkaline earths metals, belonging to Group II of the Periodic Table along with calcium, barium, and radium. Strontium-90 is generally regarded as the principal health hazard among the fission products since it is taken up by the human skeleton where it remains deposited for many years. The metabolism of stron-

tium has been found similar to that of calcium (2, 17, 15). Schulert and Peets (27) found that intravenously administered strontium-85 and calcium-45 in man were somewhat equally divided between bone and soft tissue for the first few days after administration but that after four months, about 99.5 per cent of the isotopes which were retained in the body were found in bone. The retention among the bones was greatest in vertebrae and least in long bone shaft and skull. Initially, the bone exhibited no marked preference for one isotope over the other, however, as strontium-85 was preferentially excreted by the kidney, the relative ratio of calcium-45 to strontium-85 remaining in bone gradually increased. The net retention of the isotopes appeared to level off at about 60 per cent for calcium-45 and 25 per cent for strontium-85. Although strontium retention in the body is less than calcium, the distribution throughout the body seems very similar.

Factors influencing the health hazards of strontium have been estimated by health physicists according to (1) quantities available, (2) initial body retention, (3) fraction going from blood to critical body tissue, (4) radiosensitivity of the tissue, (5) size of the critical organ, (6) biological half-life, (7) radioactive half-life, (8) energy of radiation produced by the radioisotope, and (9) specific ionization and attenuation of energy in tissue.

With the present knowledge, it is hardly possible to do more than broadly indicate the biological damage caused by strontium-90. However, the likely biological damage from ingestion of strontium-90 may be described under four headings: leukemia, bone tumor, life-shortening and genetic damage (6, 18).

According to Lewis (19) leukemia in man can be induced by ionizing radiations and can also occur spontaneously. He estimated that a 5 to 10 per cent increase in the current spontaneous incidence of leukemia would occur if the population were to reach and maintain a body level of strontium-90 amounting to one-tenth of the "maximum permissible concentration". The maximum permissible levels are recommended by the National Committee on Radiation Protection and Measurement and represent concentrations which are currently considered safe over a lifetime and which may occasionally be exceeded for short periods of time.

It has been demonstrated in laboratory animals that acute doses of radiostrontium cause bone tumors. As yet, nothing definite is known regarding the quantitative relationship between the magnitude of the dose and the incidence probability of bone tumors.

#### Radiostrontium Movement from Atmosphere to Milk

Radioactive fallout is the settling to earth of particles which are radioactive as a result of a nuclear explosion. Radiostrontium comes down mainly in raindrops. Part of the radiostrontium descending will lodge in plants, and part will enter the soil and then enter plants through their roots. The fraction which falls on leaves of growing plants is partially absorbed directly into the plant (7, 20).

Soil, like ion exchange resins, readily absorbs and retains most metal ions, including strontium. Approximately 80 per cent of the strontium-90 deposition is held in the top 2 inches of soil (7, 20).

About 50 per cent of the total is contained in the top one inch layer and the remaining portion in the soil to a depth of about 6 inches. The period for which radiostrontium stays in top-soil without becoming buried relatively deep, due to plowing, dispersion, or transformation into insoluble compounds, is not easily estimated, but probably extends over several years. Many factors, however, such as the nature of the soil, the extent of leaching by rain, the action of worms, and the cracking of the soil in dry weather, will affect the depth of penetration (7).

Very little is known about the actual mechanism of absorption and uptake of metal ions by plants but as strontium is chemically similar to calcium, it is reasonable to assume that calcium and strontium are absorbed in the same manner. The growing plant discriminates against strontium in favor of calcium at the ratio of about 2 to 1 (20). The absorption of strontium-90 by plants in a season is of the order of one per cent of the amount present in soil, the highest values in plants being in leaf tissue (7).

Animals markedly discriminate against strontium relative to calcium in their absorption of these elements from feed. The strontium activity in milk expressed as per gram of calcium present, is much below its value in the animal's ration. The experiments of Comar, et al. (7) and those of Cragle and Demott (8), have shown that the ratio of the strontium concentration in the animal's ration to that in the milk to be about 7-10 to 1. The cow acts as a barrier resisting the flow of strontium along the food-chain from soil to man. This

means that the strontium concentration (per gram of calcium) in milk is only about one-seventh to one-tenth of what it is in the feed the cow eats.

Since strontium and calcium metabolism are very closely associated, concentrations of strontium are generally expressed in terms of calcium. The most common and convenient unit for this purpose is the sunshine unit or sometimes called the Strontium Unit (S.U.), which is equal to the number of micromicrocuries of strontium-90 per gram of calcium. In itself it is not an absolute amount of strontium-90 but applies only to calcium contamination with strontium-90; and it provides a direct measure of this specific contamination. The maximum permissible body burden of strontium-90 for the general public is 0.1 microcurie, corresponding to 100 S. U. (as of April 22, 1959, unofficially 200 S. U.). On the basis of extensive experience of radiologists and technicians in work with X-rays and radium therapy, limited animal experimentations, experience with man and comparison with background concentrations of naturally occurring radioisotopes in our bodies, in the air we breathe and in the water and food we consume, the U. S. National Committee on Radiation Protection has recommended maximum permissible amounts and concentrations of radiation exposure.

The yearly average for the period ending July 1958 for strontium-90 in milk ranged from 4.2 to 10.2 micromicrocuries per liter, as compared to the permissible limit of 80 (unofficially 100 as of

April 22, 1959) micromicrocuries per liter (3). However, the strontium-90 level in milk has been steadily rising since the first adequate measurements were taken in 1954, roughly, in proportion to the rise in the level of strontium-90 deposition in soil. There has been approximately a fourfold increase in the average world strontium-90 content of milk from 1954 to the level of 5-6 S. U. in 1958 (17).

## EXPERIMENTAL PROCEDURE

### Removal of Strontium-89 and Calcium-45 from Milk of Dosed Cow

Eight daily milk samples from four Jersey cows dosed orally with one dose of calcium-45 and strontium-89 was separated mechanically by use of a DeLaval Junior Model 3300 separator and the skim milk passed through an ion exchange column at room temperature. The columns were 18 mm in diameter and 2½ inches long and contained 50 grams of either Dowex 50-W, 50-100 mesh cross linkage of 4 per cent; Duolite C-20; or Dowex 50-W, 50-100 mesh with a cross linkage of 12 per cent. These resins are strongly acidic, cross-linked polystyrene cation exchangers. Preliminary results indicated that the conventional downflow system could not be used due to packing of the resin, making it impossible to put the desired quantity of effluent through the column. Therefore, the upflow system was used (see Fig. 1) in which solutions were passed in at the bottom and out at the top of the container. Due to the turbulent action caused by the milk entering the bottom this system can not be called a true column action since the "layering" effect associated with column action is not present. Flow rate was adjusted to approximately 7 milliliters per minute to avoid channeling and control contact time.

Both the calcium and sodium form of each of these resins were tested for its effectiveness in the removal of strontium-89 and calcium-45 from skim milk. After initial conditioning of the resin, one liter of milk was passed through each column before the resin was

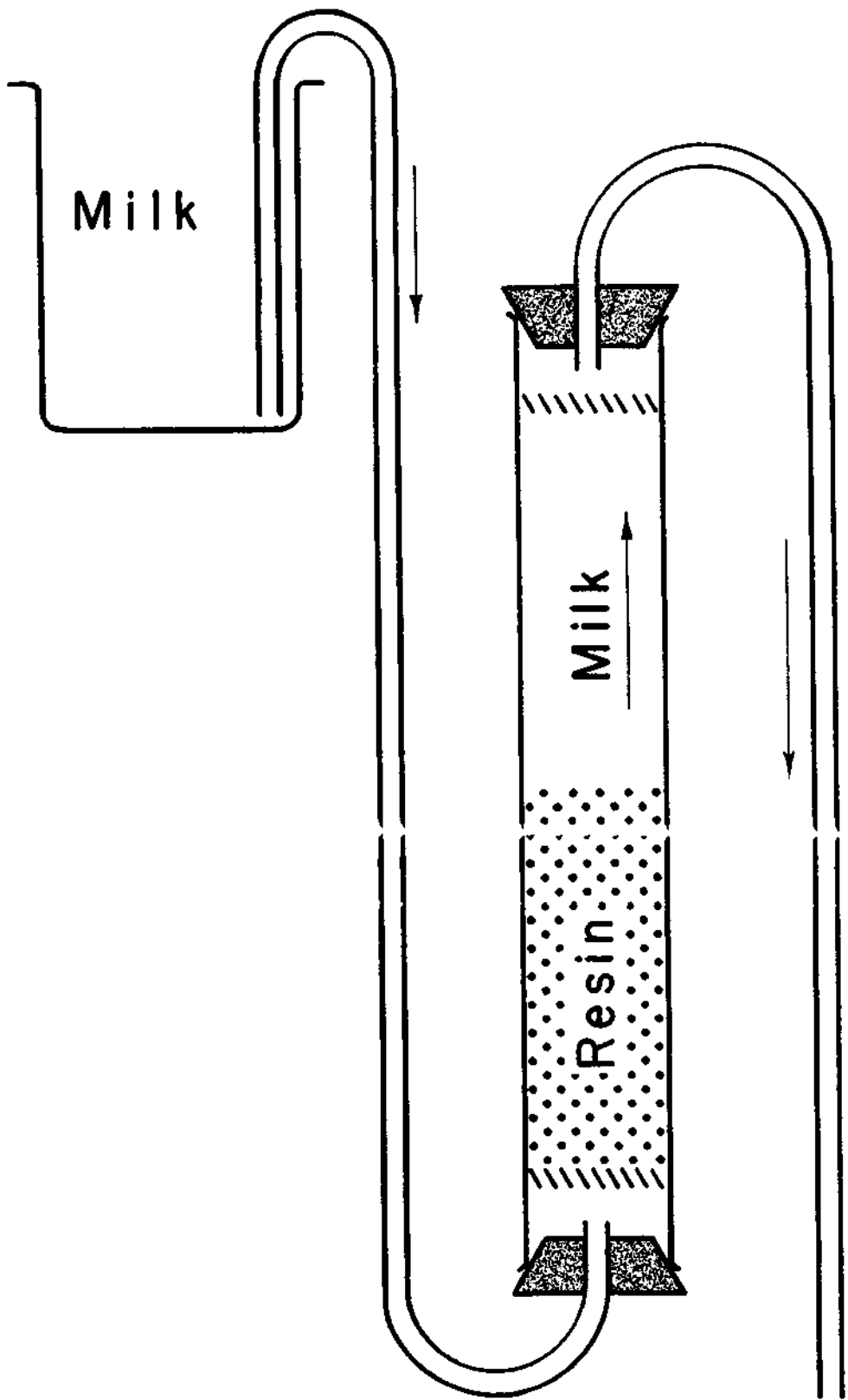


Figure 1. Modified Ion Exchange Column.



again regenerated. After each operation the cations bound by the resin were eluted by treatment with approximately 1500 milliliters of approximately 3 N hydrochloric acid. The columns were then washed with sufficient quantities of calcium chloride or sodium chloride to convert the exchangers into the desired form, followed with 100 to 200 milliliters of distilled water to wash the excess calcium or sodium chloride from the resin. The 2nd, 6th and 10th 100 milliliter portions coming through the column were sampled for analysis. Two twenty-five milliliter samples of milk were taken from each of the 100 milliliter portions. The samples were transferred to porcelain crucibles and dried in an oven at 90-100° C. for a minimum of 16 hours. They were then transferred to a muffle furnace and ashed at 600° C. for approximately 16 hours. Approximately 2 ml of hydrochloric acid was added to the ashed samples to bring the calcium and strontium into solution. The samples were then transferred quantitatively to a 40 milliliter centrifuge tube. One drop of methyl red was added as an indicator. The calcium and strontium were precipitated by adding 3 milliliters of saturated ammonium oxalate, then, by neutralizing the sample with ammonium hydroxide until the solution was faintly alkaline, and by adjusting the solution to a final pH of approximately 5.0 using acetic acid. After the solution was allowed to stand overnight for complete precipitation of the calcium and strontium oxalate, it was centrifuged and the precipitate washed twice with distilled water and transferred quantitatively into a tared cup-and-tube assembly. This assembly consisted of a tapered-end polyethylene cylinder with a

stainless-steel Tracerlab cup forming the bottom. The 4-inch plastic tube was pressed securely into the cup until the assembly was water-tight.

Following centrifugation at 1800 revolutions per minute (920 times gravity) for 10 minutes in a 20 inch diameter International centrifuge, the supernatant was drawn off and the cup removed and dried to a constant weight in an oven at approximately 60° C. The samples were then measured for radioactivity by conventional methods using a thin mica window Geiger-Müller tube connected to a scaler unit.

The activity measurements of calcium-45 are greatly dependent upon the mass of the sample measured primarily because of self-absorption of its relatively low beta energy (0.26 Mev.). The total calcium and the correction for self-absorption were calculated from the mass weight of the oxalate in the dry cup.

All samples were counted with an aluminum absorber of 54.5 or 66.6 mg/cm<sup>2</sup> and again with no absorber. Both of these absorbers will stop essentially all the calcium-45 beta rays from the sample and will reduce the strontium-89 counts by factors of 1.39 and 1.50 respectively. Therefore, when no absorber was used the activity was due to both isotopes but when the same sample was measured again with an absorber the activity represented a portion of the strontium-89 only. The calcium-45 contribution was calculated by difference. The observed count with the aluminum absorber present, times the appropriate factor represents the corrected strontium-89 count. The total observed count

with no absorber present, minus the corrected strontium-89 count, times the mass correction factor for calcium oxalate self-absorption represents the corrected calcium count.

The same procedure as described above was used for duplicate samples of standards, having no resin contact.

#### Removal of Strontium-89 and Calcium-45 from Dosed Milk

In this experiment "dosed milk" was used instead of milk from "dosed cows". Here the calcium-45 and strontium-89 were put directly into the milk instead of being administered to the cow. Calcium-45 and strontium-89 were put into fresh raw whole milk at approximately 4 P. M., mixed thoroughly and left undisturbed for 16 hours at 40° F. The following morning the milk was thoroughly mixed again, heated in a water bath to 30° C., and mechanically separated. After bringing the skim milk to room temperature the procedure described previously was followed.

#### Resin-milk and Isotope-milk Equilibrium Studies

In order to determine how long an ion exchange resin must be in contact with milk containing calcium-45 and strontium-89 to reach equilibrium, a liter of raw skim milk was dosed with calcium-45 and strontium-89, mixed thoroughly and left undisturbed for approximately 16 hours at 40° F. After heating the milk to room temperature, four-100 milliliter samples were put into 250 milliliter beakers and 5 grams of Dowex 50-W, X-12, 50-100 mesh, in the calcium form were added to each beaker. After one minute of mixing, sample one was filtered and two

25 milliliter milk samples ashed, precipitated with ammonium oxalate and counted. The same procedure was followed for samples two, three and four after 10, 60, and 120 minutes of agitation respectively. All samples were mixed by hand for the first minute and by use of a mechanical agitator thereafter. Two 25 milliliter samples of milk having no resin contact were used as standards. The percentage removal of calcium-45 and strontium-89 was calculated for each contact time.

In order to determine how long a sample of milk must be in contact with calcium-45 and strontium-89 for the sample to reach equilibrium, four - 100 milliliter samples of raw skim milk at room temperature were dosed with calcium-45 and strontium-89. After mixing for 1, 10, 30 and 60 minutes the samples were treated by exposure to 5 grams of Dowex 50-W, X-12, 50-100 mesh, in the calcium form for 60 minutes after which the samples were filtered by use of a suction funnel. Two 25 milliliter samples from each exposure time were ashed, precipitated with ammonium oxalate and counted. The percentage removal of calcium-45 and strontium-89 was calculated for each exposure time.

#### Removal of Calcium-45 and Strontium-89 from Milk by Use of a Series of Four Columns

One liter of milk was passed through a series of four columns, each containing 12.5 grams of Dowex 50-W, X-12, 50-100 mesh in the calcium form. The 2nd, 6th and 10th 100 milliliter portions passing through the last column were sampled for analysis in the same manner as described previously. This experiment was repeated four times. Following the last run the four columns were disconnected and the

resin was washed with 1 liter of 3 N hydrochloric acid. Samples of the eluate from each of the four columns were assayed for radioactivity.

Removal of Strontium-89 and Calcium-45 from Dosed Milk by the Batch Method

Raw skim milk was dosed with calcium-45 and strontium-89, agitated thoroughly by hand and left undisturbed for approximately 16 hours at 40° F. After heating the milk to room temperature six - 200 milliliter samples were put into 400 milliliter beakers and 1, 5, 10, 20, 40, and 100 grams of Dowex 50-W, X-12, 50-100 mesh, in the calcium form, were added. After mechanical agitation for four hours the samples were filtered by use of a suction funnel. Two - 25 milliliter milk samples from each beaker were dried, ashed, precipitated with ammonium oxalate, dried and counted. Two 25 milliliter samples of milk having no resin contact were used as standards. The percentage removal of calcium-45 and strontium-89 was calculated for each quantity of resin.

## RESULTS AND DISCUSSION

Values for the percentage of removal of strontium and calcium, from milk of dosed cows, by use of ion exchange resins are summarized in Table I. Significant differences were noted between resins, between ionic form of the resin as well as between portions passed through the column. Results indicate that Dowex 50-W, with a cross linkage of 12 per cent, in the calcium form is the most effective resin tested for removal of strontium-89 and calcium-45 from milk. From these data it is suggested that exchange of like (Ca-Ca) or similar (Ca-Sr) ions is more easily accomplished than the exchange of unlike (Na-Ca or Na-Sr) ions from milk. All three resins in the calcium form showed a slightly higher percentage of removal of strontium than calcium for all samples tested, although the degree varied with resins and the portion of milk passed through the column. A higher removal of strontium and calcium was attained in the first portion of milk passed through the columns as compared to other portions. The percentage removal decreased as the amount of milk passed through the column increased.

The same general conclusions may be drawn from the data presented on removing strontium and calcium from dosed milk (Table II). However, between resins, between ionic form of the resin and between the portion of milk passed through the column, no significant differences for removal of calcium were shown. There was no significant difference between resins for removal of strontium from dosed milk, whereas in the case of milk from dosed cows, between resins, between

TABLE I

PER CENT REMOVAL OF Sr<sup>90</sup> AND Ca<sup>45</sup> FROM MILK OF DISED COWS BY EXCHANGE RESIN COLUMNS

Trial	100 ml. Portion of Klutriated Milk Sample	Ca form of resin						Sr form of resin					
		Dowex 50W-4X			Duolite C-20			Dowex 50W-12X			Duolite C-20		
		Sr	Ca		Sr	Ca		Sr	Ca		Sr	Ca	
1	2nd	67	80	73	79	66	62	14	48	44	68	1	47
	6th	55	53	60	59	38	52	5	39	16	52	1	51
	10th	52	40	38	51	44	52	0	31	0	34	0	48
2	2nd	75	80	78	78	64	56	31	48	69	71	12	35
	6th	50	50	68	61	54	45	13	30	42	51	3	28
	10th	55	38	55	48	48	39	0	16	17	30	0	26
3	2nd	60	61	61	52	63	58	29	36	65	70	0	22
	6th	67	58	53	53	48	41	7	19	34	35	0	10
	10th	35	34	44	41	46	39	0	2	18	21	0	10
4	2nd	84	72	82	77	68	59	49	60	79	80	19	50
	6th	59	58	54	56	54	53	9	36	46	56	5	39
	10th	48	46	46	50	50	44	0	22	12	36	9	29
5	2nd	76	74	76	74	65	69	40	57	54	78	0	43
	6th	60	57	60	53	65	54	10	33	38	55	0	34
	10th	36	41	52	48	45	43	0	17	35	31	0	26

TABLE I (continued)

PER CENT REMOVAL OF Sr<sup>89</sup> AND Ca<sup>45</sup> FROM MILK OF Dosed COWS BY EXCHANGE RESIN COLUMNS

Trial	100 ml. Portion of Klutriated Milk Sample	Ca form of resin						Na form of resin					
		Dowex		Dow x		Duolite		Dowex		Dowex		Duolite	
		50M-4X Sr	Ca	50M-2X Sr	Ca	C-20 Sr	Ca	50M-4X Sr	Ca	50M-12X Sr	Ca	C-20 Sr	Ca
6	2nd	86	74	67	70	70	58	33	42	67	69	4	40
	6th	56	56	60	64	66	44	0	38	40	54	0	28
	10th	58	37	48	45	41	36	3	18	7	39	3	11
7	2nd	81	81	85	89	73	71	37	46	67	64	0	44
	6th	69	53	58	55	65	46	13	26	31	66	4	34
	10th	48	38	50	48	50	35	0	21	2	30	0	19
8	2nd	82	81	86	74	89	77	23	51	64	43	0	30
	6th	59	18	50	46	48	49	7	26	25	40	0	43
	10th	23	39	48	36	43	43	0	20	0	25	0	40
Average	2nd	76	75	76	74	70	64	32	49	64	68	4	39
	6th	59	50	58	56	55	48	8	31	34	51	2	33
	10th	44	39	48	46	46	41	0	18	11	31	2	26



TABLE II

PER CENT REMOVAL OF Sr<sup>90</sup> AND Ca<sup>45</sup> FROM DODED MILK BY EXCHANGE RESIN COLUMNS

Trial	100 ml. Portion of Elutriated Milk Sample	Ca form of resin						Sr form of resin					
		Dowex 50W-4X			Dowex 50W-2X			Dowex 50W-4X			Dowex 50W-12X		
		Sr	Ca	Ca	Sr	Ca	Ca	Sr	Ca	Sr	Ca	Sr	Ca
1	2nd	83	83	89	79	78	71	61	70	87	88	20	38
	6th	71	64	68	70	55	54	33	30	59	66	0	24
	10th	61	53	65	62	43	44	12	36	34	39	0	16
2	2nd	75	79	75	78	68	65	33	50	57	69	6	40
	6th	64	61	62	65	56	62	14	32	40	49	0	20
	10th	54	45	59	59	50	57	0	39	12	36	0	22
3	2nd	76	81	78	80	62	60	31	49	60	74	8	45
	6th	56	57	62	64	49	47	9	40	38	56	0	30
	10th	50	54	58	49	41	55	0	22	9	41	0	18
4	2nd	84	72	80	76	64	56	30	54	68	74	16	34
	6th	73	15	67	62	55	49	21	35	36	55	6	19
	10th	63	41	58	38	35	41	0	22	22	28	0	20
5	2nd	81	77	72	72	72	69	60	61	62	60	28	35
	6th	61	61	61	47	55	47	28	32	48	42	15	28
	10th	55	35	53	34	47	35	6	22	30	33	0	11

TABLE II (continued)

PER CENT REMOVAL OF Sr<sup>90</sup> AND Ca<sup>45</sup> FROM DOSED MILK BY EXCHANGE RESIN COLUMNS

Trial	100 ml. Portion of Elutriated Milk Sample	Ca form of resin						Sr form of resin					
		Dowex 50W-4X			Dowex 50W-12X			Dowex 50W-4X			Dowex 50W-12X		
		Sr	Ca	Ca	Sr	Ca	Ca	Sr	Ca	Ca	Sr	Ca	Ca
6	2nd	81	74	81	82	78	88	47	55	69	71	34	50
	6th	64	53	67	61	60	56	28	38	54	56	17	34
	10th	54	44	62	57	54	49	30	26	34	33	11	28
7	2nd	76	59	75	63	63	41	48	38	71	68	18	9
	6th	55	30	66	40	55	29	27	3	50	36	9	0
	10th	52	21	54	26	41	3	7	0	30	0	22	0
8	2nd	73	78	76	82	66	69	38	46	59	70	6	42
	6th	56	57	63	63	53	57	20	36	38	50	0	26
	10th	52	45	52	50	41	41	5	19	20	28	0	17
Average	2nd	79	75	77	76	69	64	44	53	67	72	17	37
	6th	63	50	65	59	55	50	23	31	45	51	6	23
	10th	55	42	58	47	44	41	8	22	24	30	4	17

ionic forms of the resin and between portions of milk passed through the column were all significantly different. Using Dowex 50W-XL2 in the calcium form, the percentage removal of strontium decreased at a faster rate, as measured by the amount of milk passed through the column, when metabolized milk was used, as compared to milk which was dosed 16 hours before the exchange treatment. The average of eight trials showed 76, 59 and 45 per cent removal of the strontium from metabolized milk on samples from the 2nd, 6th and 10th 100 milliliter portions of milk respectively and 79, 63 and 55 for the equivalent samples when dosed milk was used. The removal of strontium from dosed milk is significantly different ( $P < .01$ ) from the removal of strontium from milk of dosed cows while no significantly different removal of  $\text{Ca}^{45}$  was noted under the same circumstances. This may be due to the incorporation of strontium into the protein molecule in metabolic milk, whereas in dosed milk this would not likely be the case.

Data from eight trials on removal of calcium and strontium from milk of dosed cows and data from a similar experiment using dosed milk were subjected to analyses of variances. The  $F$  values for the main effects, and first and second order interactions in these experiments are presented in Table III. Significant differences were noted between resins for the removal of both calcium-45 and strontium-89 milk of dosed cows but not for the removal of either from dosed milk. Significant differences were noted between days following dosing of the cow for the removal of calcium-45 from milk and also

TABLE III

ANALYSES OF VARIANCES FROM EIGHT TRIALS ON REMOVAL OF Ca<sup>45</sup> AND Sr<sup>90</sup> FROM MILK OF  
 Dosed Cows AND EIGHT TRIALS ON REVAL OF Ca<sup>45</sup> AND Sr<sup>90</sup> FROM Dosed MILK

Total	Dosed Cows - Sr <sup>90</sup>		Dosed Milk - Sr <sup>90</sup>		Dosed Cows - Ca <sup>45</sup>		Dosed Milk - Ca <sup>45</sup>	
	F Value	Tested by	F value	Tested by	F Value	Tested by	F Value	Tested by
Resins	8.12*	RFS	3.02 NS	RF	23.15**	RD	4.35	RF
Days	2.55 NS	DF	2.50 NS	DF	4.88**	RD	29.62**	Error
Form	657.45**	DF	21.76*	RF	77.81*	FS	15.33 NS	RF
Samples	16.85**	RFS	25.37**	RFS	75.10*	FS	40.38**	BS
RD	NS	Error	2.2*	Error	3.28**	Error	1.60 NS	Error
RF	NS	RFS	6.43**	RFS	6.08 NS	RFS	16.54**	Error
BS	NS	RFS	NS	RFS	3.44 NS	RFS	5.33**	Error
DF	2.56*	Error	8.70**	Error	2.21 NS	Error	1.19 NS	Error
DS	2.00 NS	Error	1.05	Error	1.57 NS	Error	0.98 NS	Error
FS	NS	Error	NS	RFS	4.38*	Error	0.43 NS	Error

TABLE III (continued)

ANALYSES OF VARIANCES FROM EIGHT TRIALS ON REMOVAL OF Ca<sup>45</sup> AND Sr<sup>90</sup> FROM MILK OF  
 Dosed Cows AND EIGHT TRIALS ON RE MOVAL OF Ca<sup>45</sup> AND Sr<sup>90</sup> FROM Dosed MILK

Total	Dosed Cows - Sr <sup>90</sup>		Dosed Milk - Sr <sup>90</sup>		Dosed Cows - Ca <sup>45</sup>		Dosed Milk - Ca <sup>45</sup>	
	F Value	Tested by	F Value	Tested by	F Value	Tested by	F Value	Tested by
RDF	NS	Error	2.05 NS	Error	1.64 NS	Error	0.62 NS	Error
RDS	NS	Error	1.05 NS	Error	1.28 NS	Error	0.68 NS	Error
RFS	14.00**	Error	16.95**	Error	3.46*	Error	1.68 NS	Error
DFS	1.59 NS	Error	0.7 NS	Error	3.75**	Error	0.68 NS	Error
CV	15.7%		10.3%		11.4%		15.3%	

\*P < .05

\*\*P < .01

between trials conducted on different days on dosed milk. Strontium-89 removal was not significantly different for either. Significant differences on the removal of calcium-45 and strontium-89 between portions passed through the column (samples) were noted on both dosed milk and milk from dosed cows.

Raw skim milk, without the addition of isotopes, was passed through an exchange column identical to the ones used for milk containing the isotopes. Data on the titratable acidity, curd tension, pH, and rennet coagulation time are shown in Table IV. Before the milk was passed through the exchange column the average pH was approximately 6.71, titratable acidity 0.162 per cent, coagulation time 490.6 seconds, curd tension 61 grams, and the taste was that of normal raw skim milk. The first 100 milliliters of milk passed through the column had a slightly lower pH, a higher titratable acidity, higher curd tension and a lower rennet coagulation time compared to the standard. Under conditions which removed the highest percentage of strontium and calcium from milk, these effects were more pronounced. Therefore, as more milk was passed through the column the closer these properties approached normal milk with the exception of curd tension which continued to increase. The shorter rennet coagulation time is partially indicative of a higher calcium content in treated milk. As calcium concentration increases it tends to form calcium hydrogen phosphate, releasing hydrogen ions from calcium dihydrogen phosphate consequently lowering the pH. Milk so treated (without added radioactivity) was

TABLE IV

COAGULATION TIME, CURD TENSION, pH AND TITRABLE ACIDITY OF MILK PASSED THROUGH AN ION EXCHANGE COLUMN CONTAINING DOWEX 50W-X12 CALCIUM FORM

Trial	Control	100 ml. Portion of Kilterated Milk Sample													
		1	2	3	4	5	6	7	8	9	10	11			
1	Coagulation Time (Sec)	480	40	52	98	85	113	121							
	Curd Tension (grams)	60	110	108	85	140	160	120							
	pH	6.75	6.1	6.07	6.11	6.18	6.21	6.28	6.29	6.31	6.38	6.41	6.41		
	Per Cent Acidity	.164	.18	.20	.195	.19	.195	.195							
2	Coagulation Time (Sec)	485	26	36	43	61	81	108							
	Curd Tension (grams)	60	80	130	115	132	130	127							
	pH	6.7	6.1	6.00	6.05	6.1	6.15	6.2	6.22	6.28	6.3	6.35	6.38		
	Per Cent Acidity	.16	.195	.20	.195	.19	.195	.19							

CABLE IV (continued)

COAGULATION TIME, CURD TENSION, pH AND TITRATABLE ACIDITY OF MILK PASSED THROUGH AN ION EXCHANGE COLUMN CONTAINING DOWEX 50W-X12 CALCIUM FORM

Trial	100 ml. Portion of Enriched Milk Sample											
	Control	1	2	3	4	5	6	7	8	9	10	11
3	Coagulation Time (Sec)	525	26		36	54	75	90	90	110		
	Curd Tension (grams)	58	70	120	135	150	150	190	190	140		
	pH	6.7	5.98	6.05	6.1	6.1	6.21	6.25	6.32	6.38	6.38	6.39
	Per Cent Acidity	.165		.195	.20	.195	.195	.19	.19	.185		
4	Coagulation Time (Sec)	522	26	35	54	82	90	90	114			
	Curd Tension (grams)	60	80	130	135	140	150	150	135			
	pH	6.7	6.2	6.05	6.1	6.18	6.24	6.25	6.32	6.38	6.44	6.45
	Per Cent Acidity	.16		.19	.195	.19	.195	.19	.195	.19		



TABLE IV (continued)

COAGULATION TIME, CURD TENSION, pH AND TITRATABLE ACIDITY OF MILK PASSED THROUGH AN ION EXCHANGE COLUMN CONTAINING DOWEX 50W-XL2 CALCIUM FORM

Trial	Control	100 ml. Portion of Elutriated Milk Sample										
		1	2	3	4	5	6	7	8	9	10	11
5	Coagulation Time (Sec)	455	24	34	34	53	69	89	89	108		
	Curd Tension (grams)	58	76	120	140	140	150	160	160	140		
	pH	6.7	6.2	6.1	6.2	6.23	6.29	6.32	6.33	6.38	6.4	6.45
	Per Cent Acidity	.165	.195	.205	.200	.195	.195	.19	.195	.19		
6	Coagulation Time (Sec)	485	23	34	54	67	91	111				
	Curd Tension (grams)	70	80	140	144	142	152	140				
	pH	6.68	6.12	6.18	6.19	6.23	6.28	6.3	6.33	6.35	6.4	6.4
	Per Cent Acidity	.165	.195	.20	.20	.20	.195	.19	.195	.19		

TABLE IV (continued)

COAGULATION TIME, CURD TENSION, pH AND TITRATABLE ACIDITY OF MILK PASSED THROUGH  
AN ION EXCHANGE COLUMN CONTAINING DOWEX 504-X12 CALCIUM FORM

Trial	Control	100 ml. Portion of Elutriated Milk Sample												
		1	2	3	4	5	6	7	8	9	10	11		
7	488	26	43	64	72	93	114							
	Coagulation Time (Sec)													
	60	70	110	128	140	130	125							
	Curd Tension (grams)													
	6.72	6.12	6.18	6.22	6.29	6.38	6.39	6.4	6.48	6.48	6.49			
	pH													
	.16	.195	.195	.195	.195	.195	.185							
	Per Cent Acidity													
8	485	22	36	54	71	92	116							
	Coagulation Time (Sec)													
	63	90	120	138	145	135	119							
	Curd Tension (grams)													
	6.7	6.08	6.1	6.2	6.28	6.3	6.33	6.39	6.4	6.46	6.48			
	pH													
	.16	.195	.20	.195	.19	.19	.19							
	Per Cent Acidity													

TABLE IV (continued)

COAGULATION TIME, CURD TENSION, pH AND TITRATABLE ACIDITY OF MILK PASSED THROUGH AN ION EXCHANGE COLUMN CONTAINING DOWED 50W-XL2 CALCIUM FORM

Trial	Control	100 ml. Portion of Elutriated Milk Sample												
		1	2	3	4	5	6	7	8	9	10	11		
Avg. Coagulation Time (Sec)	490.6	26.6	38.2	59.1	71.5	92.3	112.7							
Curd Tension (grams)	61	82	121.9	127.5	142.4	158.7	130.8							
pH	6.71	6.12	6.12	6.17	6.23	6.27	6.29	6.34	6.38	6.41	6.43			
Per Cent Acidity	.162	.192	.199	.196	.192	.189								

tasted and found to have a slightly bitter flavor in those samples which exhibited the largest pH drop.

Data on the removal of strontium and calcium from milk as influenced by the resin-milk contact time are presented in Table V. All contact times were made on a milk-resin ratio basis of 20 to 1 using the batch techniques. Times of 1, 10, 30 and 60 minutes were used. The average of three trials showed 62 per cent strontium-89 and 52 per cent calcium-45 were removed after a contact time of one minute, while 76 per cent strontium-89 and 67 per cent calcium-45 were removed after 120 minutes, the greatest difference being from one to ten minutes ( $P < 0.05$ ). This is illustrated more clearly in Fig. 2 which indicates that the solution had approached equilibrium after 10 minutes but not at the end of one minute.

The data for the removal of strontium and calcium as influenced by the isotope-milk contact time are presented in Table VI. Each sample was intermittently hand agitated for either 1, 10, 30 or 60 minutes, then treated by exposure to Dowex 50W-X12 in the calcium form for 60 minutes under constant agitation. The milk to resin ratio was 20 to 1. Results show approximately 30 per cent removal of strontium-89 and approximately 75 per cent removal of calcium-45 with very little difference between milk agitated for one minute and that agitated for 60 minutes before exchange treatment. The isotopes are fully incorporated into the milk within one minute or the rate of incorporation at this stage is so slow that 60 minutes is not suffi-

TABLE V

EFFECT OF RESIN-MILK CONTACT TIME ON PER CENT REMOVAL OF  
 $\text{Sr}^{90}$  AND  $\text{Ca}^{45}$  FROM DOSED MILK

Trial	Resin-milk Contact Time (minutes)	Per Cent $\text{Sr}^{90}$ Removal	Per Cent $\text{Ca}^{45}$ Removal
1	1	66	56
	10	69	54
	60	77	70
	120	76	69
2	1	57	44
	10	71	64
	60	68	55
	120	78	70
3	1	64	55
	10	75	62
	60	77	72
	120	75	60
Average	1	62	52
	10	72	60
	60	74	66
	120	76	67

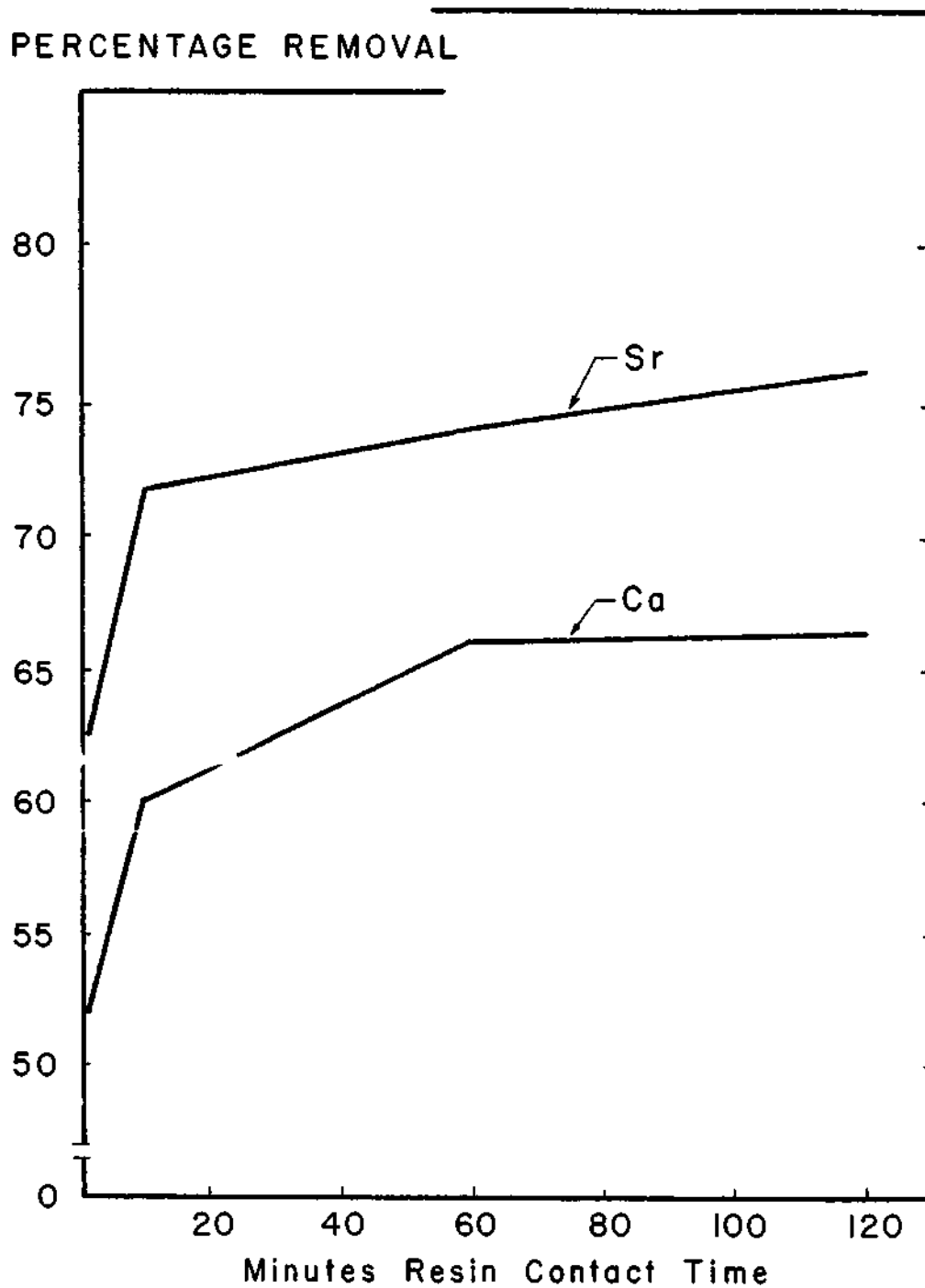


Figure 2. Effect of Resin-Milk Contact Time on Percent Removal of Sr<sup>89</sup> and Ca<sup>45</sup> from Dosed Milk.

TABLE VI

EFFECT OF ISOTOPE-MILK CONTACT TIME ON PER CENT REMOVAL OF Sr<sup>90</sup>  
AND Ca<sup>45</sup> FROM DOSED MILK

Trial	Isotope-milk Contact time (minutes)	Per Cent Sr <sup>90</sup> Removal	Per Cent Ca <sup>45</sup> Removal
1	1	78	71
	10	79	70
	30	76	72
	60	72	61
2	1	83	78
	10	84	77
	30	73	71
	60	80	70
3	1	83	81
	10	73	73
	30	82	87
	60	81	78
4	1	80	73
	10	77	71
	30	83	74
	60	73	61
Average	1	81	76
	10	79	72
	30	79	76
	60	77	68

cient time to show a definite trend, the latter probably being the case since less of the isotopes were removed after contact with the milk 16 hours than 60 minutes.

The data on removal of strontium and calcium from milk by use of a series of four ion exchange columns are shown in Table VII. This experiment was conducted to compare the action of four columns in a series, each containing 12.5 grams of resin, to one column containing 50 grams of resin (Table 2). No differences were noted in the percentage removal of strontium and calcium between the two methods.

Following the last trial each of the four columns of resin was washed with 1 liter of 3 N hydrochloric acid. Forty milliliter samples of the eluate from each of the four columns were assayed and the radioactivity of both calcium and strontium was found to decrease in the resin from the first column to the last (Table VIII).

The data in Table IX and Fig. 3 indicate a direct relationship between the percentage of strontium and calcium removed from milk and the amount of resin used. Because Dowex 50W-X12 in the calcium form had appeared to be more effective in the removal of strontium and calcium from milk than either Dowex 50W-X4 or Duolite C-20 (Tables I and II), it was used in this batch experiment. The percentage removal of strontium-89 ranged from a high of 94, where one part resin was used per two parts of milk, to a low of 21, where one part resin per 200 parts of milk was used. Similarly the percentage calcium-45 removal ranged from a high of 93 to a low of 16



TABLE VII

PER CENT REMOVAL OF  $\text{Sr}^{90}$  AND  $\text{Ca}^{45}$  FROM MILK BY USE OF  
A SERIES OF FOUR EXCHANGE RESIN COLUMNS

Trial	100 ml. Portion of Elutriated Milk Sample	Per Cent $\text{Sr}^{90}$ Removal	Per Cent $\text{Ca}^{45}$ Removal
1	2nd	74	75
	6th	67	63
	10th	62	51
	14th	45	38
2	2nd	77	72
	6th	52	59
	10th	57	50
	14th	55	42
3	2nd	71	73
	6th	67	52
	10th	46	30
	14th	40	31
4	2nd	82	74
	6th	73	51
	10th	51	36
	14th	36	31
Average	2nd	76	73
	6th	65	56
	10th	54	42
	14th	44	36

TABLE VIII

RADIOACTIVITY RETAINED BY RESIN AFTER PASSAGE OF  
MILK CONTAINING  $\text{Ca}^{45}$  AND  $\text{Sr}^{90}$

Column	$\text{Sr}^{90}$ Counts/Min/ 40 ml. Eluate	$\text{Ca}^{45}$ Counts/Min/ 40 ml. Eluate	$\text{Sr}^{90}/\text{Ca}^{45}$
1	82	451	0.1818
2	66	427	0.15456
3	39	308	0.12662
4	18	180	0.100

TABLE IX

EFFECT OF MILK-RESIN RATIO ON PER CENT REMOVAL  
OF  $\text{Sr}^{90}$  AND  $\text{Ca}^{45}$  FROM MILK

Trial	Ratio of Milk to Resin (wt. basis)	Per Cent $\text{Sr}^{90}$ Removal	Per Cent $\text{Ca}^{45}$ Removal	Increase of Ca Compared to Non- treated milk (%)
1	2	94	93	56.7
	5	89	85	20.2
	10	85	76	21.5
	20	67	56	23.7
	40	50	28	20.4
	200	17	8	6.9
2	2	94	94	54.4
	5	88	83	23.6
	10	83	78	22.5
	20	69	57	20.3
	40	56	42	- 3.8
	200	18	17	0.1
3	2	93	92	60.7
	5	87	83	22.6
	10	82	74	21.8
	20	73	60	22.0
	40	56	34	- 0.5
	200	28	23	- 6.5
Average	2	94	93	57.3
	5	88	84	22.1
	10	83	76	21.9
	20	70	57	22.0
	40	54	34	5.4
	200	21	16	3.3

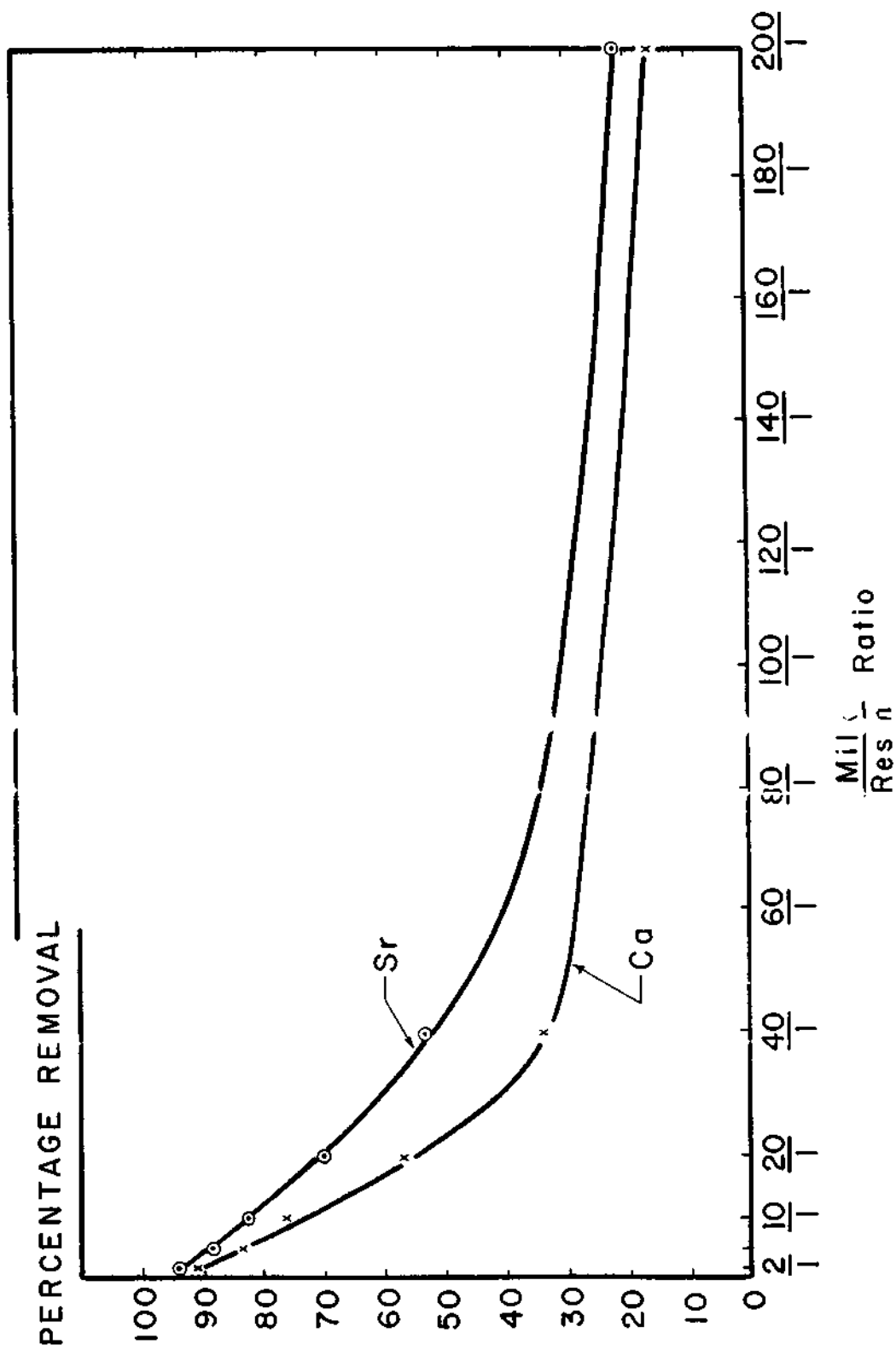


Figure 3. Effect of Milk-Resin Ratio on Percent Removal of Sr<sup>89</sup> and Ca<sup>45</sup> from Milk.

per cent. The total resin exchange capacity (Meq./gm.) was approximately twice the amount required for complete removal of the calcium from the milk at a milk-resin ratio of 20 to 1. At the 20 to 1 ratio the average percentage removal of strontium was approximately 70 and calcium 57.

Relationships between resin weight and exchange of calcium-45 and strontium-90 from milk are useful for predictions for different ratios. Since calcium in milk is in a very high concentration (6.23 meq./100 ml.) in relation to strontium (.00093 meq./100 ml.) a linear equation was derived for calcium-45 exchange on the assumption of isotope dilution.<sup>1</sup> This equation is:

$$w = a \frac{1 - f_M^e}{\dots}$$

where: w = weight of moist resin

$$a = \text{slope} \frac{\text{quantity of resin}}{\frac{\% \text{ removed}}{\% \text{ not removed}}}$$

$$f_M^e = \text{Ca}^{45} \text{ percentage found in milk.}$$

This is plotted in Fig. 4 with w on the y axis and  $\frac{\text{per cent of isotope removed from milk}}{\text{per cent of isotope not removed from milk}}$  on the x axis.

This equation was tested for strontium also and a non-linear relationship was observed which may have been due to ion selectivity of the resin.

---

<sup>1</sup>Preliminary calculations on these relationships were made by R. C. McIlhenny, Radiochemist, UT-AEC Agricultural Research Laboratory.

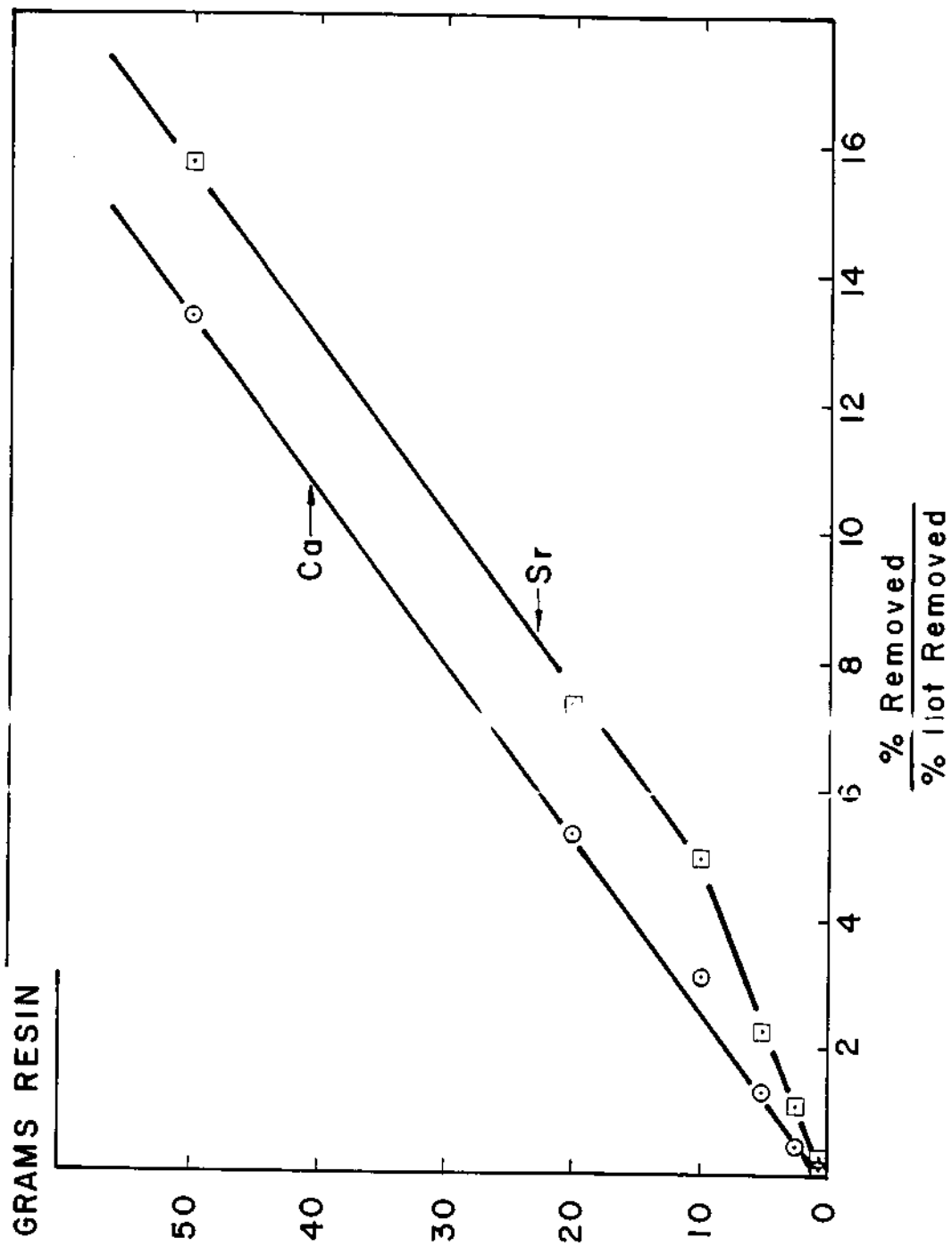


Figure 4. Relationship of Milk-Resin Ratio and the Percentage Exchange of Ca<sup>45</sup> and Sr<sup>89</sup>.

On the basis of calcium oxalate weights, milk treated with the resin contained more calcium than the non-treated milk (Table VIII). This may be due to the excess calcium chloride not being washed from the recharged resin when the batch system was used. Some additional calcium may also come from the exchange of calcium on the resin for strontium and other ions in milk. In general the percentage of calcium removal from milk was less than strontium based on the total calcium and strontium in the untreated milk.

An estimation of the efficiency of the column system versus the batch system was made. The following four equations were derived by the method of least squares from the data presented in Tables 1 and 2.

$\text{Ca}^{45}$  dosed milk:

$$y = -33.26 + 1.48736x + \frac{117.8174}{1.063x}$$

Milk from  $\text{Ca}^{45}$  dosed cows

$$y = -154.0086 + 6.75665x + \frac{238.6207}{1.061x}$$

$\text{Sr}^{90}$  dosed milk

$$y = -187.0063 + 5.58810x + \frac{269.86}{1.037x}$$

Milk from  $\text{Sr}^{90}$  dosed cows

$$y = -98.6204 + 4.20296x + \frac{183.4547}{1.059x}$$

Where  $y = \%$  removal and  $X = 100$  ml. portions passed through the column.

The integrated forms of these equations for determining the area under the curve were respectively:

$$A = -33.26x + .74368x^2 - \frac{1928.5873}{1.063x} + 1928.5873$$

$$A = -154.0086x + 3.3783x^2 - \frac{4030.0743}{1.061x} + 4030.0743$$

$$A = -187.0063x + 2.7940x^2 - \frac{7430.0660}{1.037x} + 7430.0660$$

$$A = -98.6204x + 2.10x^2 - \frac{3199.895}{1.059x} + 3199.895$$

Since the columns contained 107 milliliters of milk and 50 grams of resin when completely filled, a convenient point of comparison was the per cent of removal for some volume less than 107 ml. and a comparable volume in the batch system. Therefore the area under the curve was determined for 100 milliliters of milk. The comparisons of the systems are presented in Table X. It is estimated that the column was only 86 per cent as efficient as the batch system for removal of  $Sr^{88}$ . The corresponding value for  $Ca^{45}$  was 88 per cent. The lower efficiency for the column can be attributed to the milk-ion and resin-ion complex not being allowed to come to equilibrium. Milk was found to contain an average of 6.23 meq. of calcium per 100 milliliters and is estimated to contain 0.00096 meq. of strontium per 100 milliliters. The calculations presented in Table X are based on these values.



TABLE X

PER CENT OF RESIN CAPACITY EXCHANGE BY CALCIUM AND STRONTIUM USING THE  
BATCH AND COLUMN SYSTEM

System used	Ratio Milk Resin or portion through column	Resin Capacity (meq.)	Isotope Removed	Percentage removed	Meq. Exchanged	Per Cent Resin Capacity Exchanged
Batch	2 - 1	135	Ca <sup>45</sup>	93	5.79	4.27
Batch	5 - 1	54.3	Ca <sup>45</sup>	84	5.24	9.6
Batch	10 - 1	27.1	Ca <sup>45</sup>	76	4.74	17.4
Batch	20 - 1	27.1	Ca <sup>45</sup>	56	7.10	26.2
Batch	40 - 1	13.5	Ca <sup>45</sup>	34	4.24	31.3
Batch	200 - 1	2.7	Ca <sup>45</sup>	16	1.99	73.6
Batch	2 - 1	135	Sr <sup>90</sup>	94	--	--**
Column	1st 100 ml.	135	Ca <sup>45</sup>	82	5.10	3.77**
Column	1st 100 ml.	135	Sr <sup>90</sup>	81	--	--**
*Column	1st 100 ml.	135	Sr <sup>90</sup>	81	--	--**
*Column	1st 100 ml.	135	Ca <sup>45</sup>	74	4.62	34.1

\*Milk from Dosed cows. All other samples were dosed milk.

\*\*Stable strontium in milk is negligible compared to calcium.

## SUMMARY

Much publicity has been given the passage of strontium from the atmosphere into food and its accumulation in bone in recent months. The strontium level in milk has been accumulating at a rate which is causing some alarm due to the damaging effect it may have on the health of humans.

Modified ion exchange resin columns and the batch system have been used to remove strontium-89 as well as calcium-45 from both dosed milk and milk from dosed cows. Dowex 50W-X12, Dowex 50W-X4 and Duolite C-20 were used, the first found to be most effective, by removing 76 per cent of the strontium and 74 per cent of the calcium from milk of dosed cows and 77 and 76 per cent respectively from dosed milk. These data represent only the second 100 milliliter portion of one liter passed through the column.

Using this modified column technique the per cent resin capacity exchanged was only 86 per cent as effective for removal of strontium-89 and 88 per cent for the removal of calcium-45.

Dowex 50W-X12 resin was left in contact with milk for periods of 1, 10, 60 and 120 minutes to study the exchange rate. Differences existed between the 1 and 10 minute periods only.

Using the batch system and dosed milk, the percentage of removal of strontium-89 and calcium-45 decreased as the ratio of milk to resin increased. The percentage of removal ranged from a high of 94 and 93

for strontium and calcium respectively at a milk-resin ratio of 2 to 1 to a low of 21 per cent strontium and 16 per cent calcium at a milk-resin ratio of 200 to 1.

An approximately linear relationship was found between the ratio of calcium-45 removed over that not removed and the quantity of resin used.

**BIBLIOGRAPHY**

## BIBLIOGRAPHY

- (1) Adams, B. A., and Holmes, E. L. Adsorptive Properties of Synthetic Resins. J. Soc. Chem. Ind. 54: 1:6T. 1935.
- (2) Alexander, G. V., Nusbaum, R. E., and MacDonald, N. S. The Relative Retention of Strontium and Calcium in Bone Tissue. J. Biol. Chem. 218: 911. 1956.
- (3) Anonymous. Radioactivity in Milk. Science 128: 762. 1958
- (4) Baker, J. M., and Gehrke, C. W. An Ion Exchange Resin-Contact-Time-Method for the Study of Inorganic Equilibria in Milk. J. Dairy Sci. 37:1409. 1954.
- (5) Baker, J. M., and Gehrke, C. W. The Exchangeable Calcium in Raw and Heated Milk as Determined by the "Resin-Contact-Time-Method". J. Dairy Sci. 39: 1221. 1956.
- (6) Brown, W. M. C. Some Reflections on the Possible Hazards to Man of Low Doses of Radiation. Proceedings of the Nutrition Society 18: 38. 1959.
- (7) Comar, C. L., Russell, R. S. and Wasserman, R. H. Strontium-Calcium Movement from Soil to Man. Science 126: 485. 1957.
- (8) Cragle, R. G. and Demott, B. J. Strontium and Calcium Uptake and Excretion in Lactating Dairy Cows. J. Dairy Sci. 42: In Press.
- (9) Gans, R., Jahrb. preuss. geol. Landesanstalt (Berlin) 26, 179 (1905); 27, 63 (1906); Centr. Mineral Geol. 22, 728 (1913); German Patent 197, 111 (1906); U. S. Patents 914, 405 (March 9, 1909), 943, 535 (December 14, 1909), 1, 131, 503 (March 9, 1915). Quoted by Nachod, F. C. and Schubert, J., editors. Ion Exchange Technology, p3. Academic Press, Inc. New York N. Y. 1956.
- (10) Gehrke, C. W., and Almy, E. F. Action of Mineral Ion Exchange Resins on Milk Constituents. Ind. Eng. Chem. 42: 2344. 1950.
- (11) Gehrke, C. W., and Smith, R. B. The Effect of Heat and pH on the Ion-Exchangeable Calcium and Magnesium in Skim Milk as Determined by the Resin-Contact-Time-Method. J. Dairy Sci. 40: 600. 1957.
- (12) Haller, H. S., and Morin, A. G. Ion Exchange as a Means of Varying the Salt Constituents of Milk. J. Dairy Sci. 33: 305. 1950.

- (13) Harm, F., German Patent 95, 447 (June 2, 1896). Quoted by Nachod, F. C. and Schubert, J., editors. Ion Exchange Technology, p5. Academic Press, Inc. New York, N. Y. 1956.
- (14) Josephson, D. V., and Reeves, C. B. The Utilization of the Mineral-Ion Exchange Principle in Stabilizing Evaporated Milk. J. Dairy Sci. 30: 539. 1947.
- (15) Kulp, J. L., Eckelmann, W. R., and Schulert, A. R. Strontium-90 in Man. Science 125: 219. 1957.
- (16) Kunin, R. Ion Exchange Resins. 2nd Ed. John Wiley and Sons, Inc. New York, N. Y. 1958.
- (17) Larson, B. L., and Ebner, K. E. Significance of Strontium-90 in Milk. A Review. J. Dairy Sci. 41: 1647. 1958.
- (18) Lenihan, J. M. A. Nutritional Hazards Caused by Radioactive Contamination of Foods. Proceedings of the Nutrition Society 18: 34. 1959.
- (19) Lewis, E. B. Leukemia and Ionizing Radiation. Science 125: 965. 1957.
- (20) Libby, W. F. Radioactive Fallout and Radioactive Strontium. Science 123: 657. 1956.
- (21) Lyman, J. F. U. S. Patent 1, 954, 109 (April 10, 1934) as quoted by Otting, H. E. Ind. Eng. Chem. 41:457. 1949.
- (22) McGlasson, E. D. and Boyd, J. C. Improved Methods in the Recovery of Lactose Using Ion Exchange Resins. J. Dairy Sci. 34: 119. 1951.
- (23) Murthy, G. K., and Whitney, R. McL. The Effects of Cationic and Anionic Resins on the Salt Content of Raw Skimmilk. J. Dairy Sci. 36: 559. 1953.
- (24) Nervik, W. E., Kalkstein, M. I., and Libby, W. F. Purification of Milk for Calcium and Strontium with Dowex 50W Resin. UCRL-2674 1954.
- (25) Otting, H. E. Ion Exchange Application in Milk Products. Ind. Eng. Chem. 41: 457. 1949.
- (26) Sasaki, R., Tsugo, T., and Yajima, A. Effects of Treatments with Ion-Exchange Resin on Heat Coagulation of Milk. Chem. Abstr. 52: 9465. 1958.

- (27) Schulert, A. R., Peets, E. A., Laszlo, D., Spencer, H., Charles, M., and Semachson, J. Comparative Metabolism of Strontium and Calcium in Man. J. of Applied Rad. and Isotopes 4: 144. 1959.
- (28) Thompson, H. S. On The Absorbent Power of Soils. J. Roy. Agr. Soc. Engl. 11: 68. 1850.
- (29) Way, J. T. On the Power of Soils to Absorb Manure. J. Roy. Agr. Soc. Engl. 11: 313. 1850.

## Farming after a Nuclear War

At one time, almost every home was a little farm. Everyone had a garden and a few chickens. It is a life-style now unknown to present city dwellers but still present to some degree with our village neighbors. It is a life-style to which many will probably return and the purpose of these pages is to help that transition. This is our own little greenhouse.



### Table of Contents:

[Library: Gathering Resources for After a Nuclear War.](#)

This web page deals with the technical aspects of farming such as seed saving, fertilizers, crop management and so forth. Other web pages in the hierarchy above this one deal with measuring radiation



in food, alternate energy sources, and other subjects necessary to successful farming.

**Farm1: Protection of Food and Agriculture From Nuclear Attack**

(In .pdf format.)

This 42 page booklet was the US Department of Agriculture comprehensive attempt to prepare the farmer for nuclear attack. It contains much important information.

**Farm2: Fallout on the Farm**

(In .pdf format.)

This 14 page booklet is by the Canadian Government and has useful information about crop alternatives after a nuclear war, the handling of animals exposed to fallout, and many other items of information.

**More: The Have More Plan**

(In .pdf format.)

The "Have-More" Plan (A Little Land - A Lot of Living) by Ed and Carolyn Robinson is a 1940 classic devoted to the creation of a small farm. It is a bit dated in its view of DDT but generally may be exceptionally useful to those who are inexperienced and are trying to start.

**Seeds: Basic Seed Saving**

(In .pdf format.)

6 pages in .pdf format from Seeds of Diversity.

**Humanure: Humanure Handbook**

This 200 page book - winner of *many* awards is placed here through the kind permission the author Joseph Jenkins. It can be obtained in print at Jenkins Publishing, PO Box 607, Grove City, PA 16127. To order, phone: 1-800-639-4099. <http://www.jenkinspublishing.com/> .

**Humanure: The Handbook available in .pdf format.**

**Mulch: Explains organic composting.**

(In .pdf format. )

This 30 year old 101 page book gives information about mulching.

**Fences: Fence Planner for the Common Sense Fence**

(In .pdf format.)

This 12 page booklet gives information about wire fences, barbed, stranded, and electric. There are other kinds.

### [Seed Presses](#) [Pressing Oil from Seeds](#)

This 24 page .pdf file lists 56 oil bearing seeds and discusses a variety of methods for extraction and processing. These oils can be used either for food or fuel.

**The books below this level are copyrighted and will be available (if there is enough Internet to disseminate them) after the nuclear war - when surely no one will object. The information here will indicate the types of information that you might be interested in gathering into your own library ahead of time.**

### [Ark: Build Your Ark](#)

(In .pdf format. )

"Build Your Ark" (How to Prepare for Self-Reliance in Uncertain Times) by Geri Welzel Guidetti. Published by: The Ark Institute, P.O. Box 364, Monkton, MD 21111, email arkinst@concentric.net : This 248 page Book One on Food Self-Sufficiency covers basic concepts on gardening and goes into detail on soil improvement and insect control. Details are provided on a wide variety of garden vegetables.

### [Farmstead: The Farmstead Book](#)

(In .pdf format.)

"The Farmstead Book 1" edited by Paul Harmond and is Published in the US by: Cloudburst Press of America, Inc. 2116 Wetern Avenue, Seattle, Washington 98121 and in Canada by: Cloudburst Pres Ltd., Mayne Island British Columbia V0N 2J0 - This 262 page Book covers soil and woods management on a more macro level than the book above and also covers the farm machine shop.

### [Taste: Like They Used To Taste](#)

(In .pdf format.)

"Grow Friuts & Vegetables The Way They Used To Taste" by John F. Adams published by Wynwood Press - New York, New York. This 104 page book deals somewhat with vegetables and seed saving but is more largely devoted to fruit trees.

### [Seeds: Saving Seeds](#)

(In .pdf format.)

"Saving Seeds" (The Gardener's Guide to Growing and Storing Vegetable and Flower Seeds) by Marc Rogers and published by Storey Communications, Inc. Pownal, Vermont 05261. 97 pages.

[Click here to return to the  
Individual Agricultural Recovery  
After Nuclear Holocaust](#)

---

## Overview

### Gathering information Resources for Farming After a Nuclear War

This web page deals with the technical aspects of farming such as seed saving, fertilizers, crop management and so forth.

Other web pages, in the previous table of contents in the hierarchy above this one, deal with measuring radiation in food, alternate energy sources, and other subjects necessary to successful farming.

Still other web pages, in the previous table of contents in the hierarchy above this one, deal with old Pioneering skills. There may be some overlap between those and these immediate pages but it is well to look at both of them for what may be start up farming without access to all the present modern technology.

We cannot just go back to the old ways. We have lost many of the skills. No one had them all then and you would be hard put today to find a wheelwright, a miller, a tanner, a barrel maker. All those trades, like farming have advanced into modern technology and the present experts seldom have used the old ways. Many of the old implements are no longer around and we certainly don't have the horses. Modern horses are neither bred nor conditioned to pull the plow. Still, in the skills of the past we may find solutions to the problems of the moment.

Our personal library is very extensive. At one time I counted 13 encyclopedias. These are mostly specialized - like a 14 volume set on gardening and another 16 volume set on do-it-yourself repairs. There are others on health and medicine and a variety of other subjects.

We have also acquired CDs with hundreds of books and one summer put a crew to work microfilming thousands of documents which we have on microfiche. These, plus many many books, are in just our own home but our Ark Two Community librarian is the real gatherer of information - he has many thousands of books, mostly on technology for recovery.

In the future, when people want it, we hope to be able to disseminate all this information widely. There are many blind spots in our library. We have little information on modern technology and almost no information on leading edge technology. Members of our Ark Two community are of far more than average knowledge about nuclear and computers but there are many, many fields such as in modern metallurgy, petroleum refining, hundreds of specialties in chemistry, medicine, and untold numbers of

other areas that the expertise to re-establish them will have to survive with the experts - if they are going to be recovered in the immediate decades following.

One major focus of our library has been maps, in order to determine where that expertise may reside. We have thousands of maps. Local road maps. Topographical maps. More and more maps on an expanding scale. We have every map ever published by the National Geographic. We have CDs with map search programs. North American and World Atlases. The list goes on. One map set which we were very desirous of obtaining cost thousands of dollars (far beyond our budget) from the US government. It comes with a subscription program for real-time updating and the printed book is reprinted annually. A marvelous tool for demographers tracking changing patterns - but one copy would serve our purposes. Amazingly, we found one on the Internet - at a fraction of the cost.

Other associates of ours are providing us with gigabytes of survival information on CDs. Our problem has not been so much one of obtaining information but determining which areas on which to concentrate our limited resources for storing and cataloging. Tons of information is of no use, if you have no way of finding what you want in it. In early years we were given literally tons of books by libraries and publishers. Expensive volumes that cost over hundreds of dollars each - but we finally had to abandon that effort simply because of lack of storage space and manpower to handle it. We passed on trailer loads of books.

So the problem of the moment has not been getting information but one of determining which information is going to be most useful to survivors. These have been our choices. What we offer in these pages, measuring radiation contamination in food, producing food without the modern technology and its skills, finding alternate sources of energy, recovering and repairing remaining machinery, creating the nucleus of an economic system and restoring the basis of functioning society - information on how to do these things are what we feel will be most needed at the outset. It is our sincerest hope that we will be able to get it to the people who need it and that they will find it useful.

Click here to return to the  
[Table of Contents](#)

**MENU: [HOME](#) » [Reconstruction](#) » [Recovery](#) » [Renewal](#) » [Survival](#)**

---

---

# Embedded Secure Document

The file *file:///E:/PROPHECYKEEPERS/data/POST-NUCLEAR-WAR/b\_recovery/2\_farm\_recovery/ftpfiles/protection.pdf* is a secure document that has been embedded in this document. Double click the pushpin to view.



# Embedded Secure Document

The file *file:///E:/PROPHECYKEEPERS/data/POST-NUCLEAR-WAR/b\_recovery/2\_farm\_recovery/ftpfiles/fallout\_on\_the\_farm.pdf* is a secure document that has been embedded in this document. Double click the pushpin to view.



# THE "HAVE-MORE" PLAN

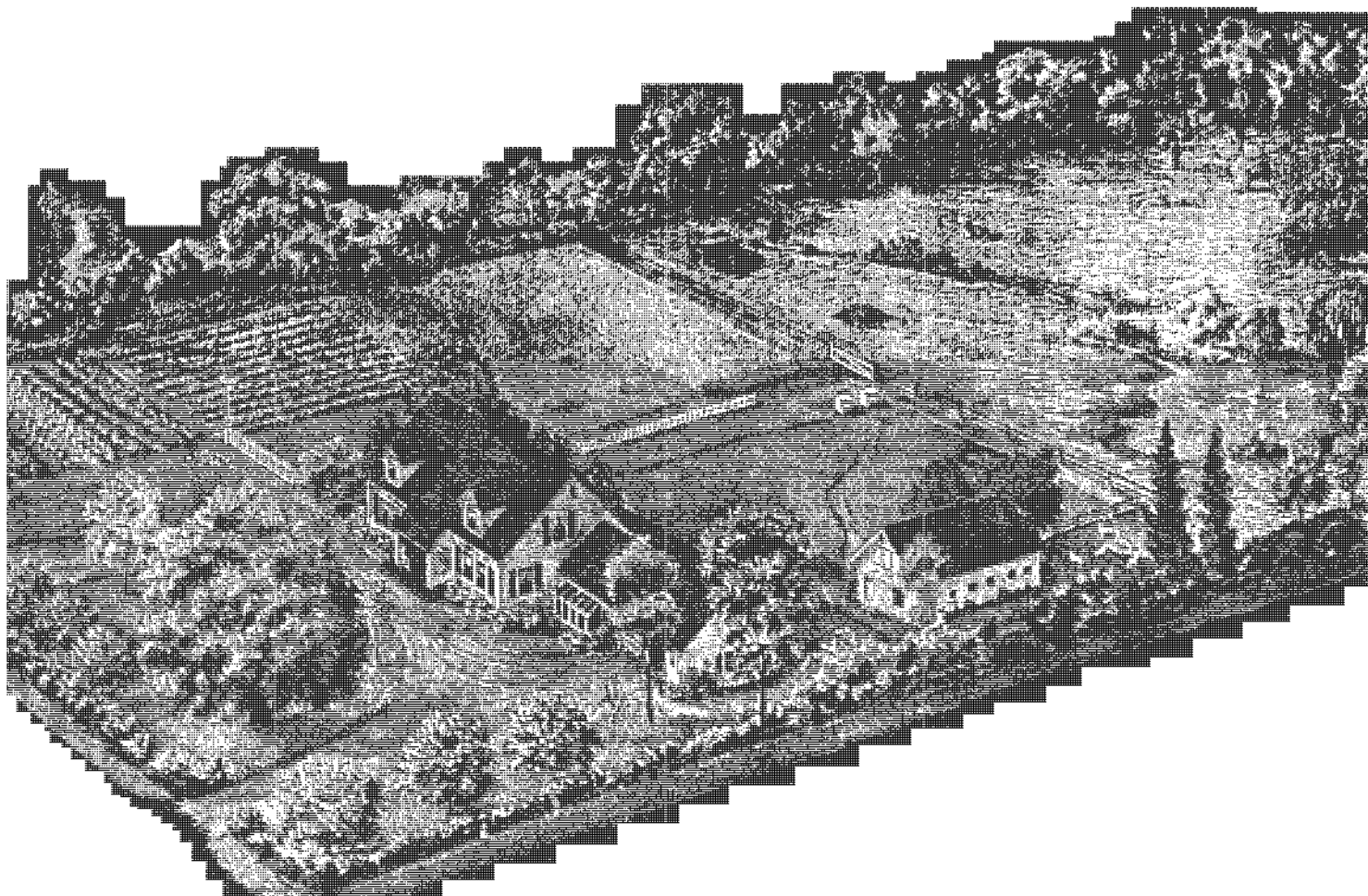
## "A LITTLE LAND— A LOT OF LIVING"

How to Make a Small Cash Income  
Into the Best and Happiest Living  
Any Family Could Want

BY

*Ed and Carolyn Robinson*

- Buying a Place in the Country
- Laying Out a Homestead
- Remodeling or Building a House Designed for Country Living
- Part-time Farm Pays for Itself
- A Good Garden with Less Work
- Building a Small Barn
- Earning Money in the Country
- Dwarf Fruit Trees and Berries
- Fish Pond in Your Backyard
- Starting Right with Poultry, Rabbits, Milk Goats or Cow, Bees, etc., etc.



Dear Reader,

Garden Way Publishing Co. is the successor to the Noroton Country Bookstore and we are pleased to make the original "Have-More" Plan by Ed and Carolyn Robinson available again.

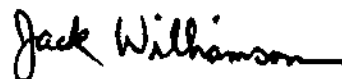
This classic book was written in the 1940's by leading experts of the day, to aid the individual in his search for self-sufficiency and independence on a country acre. We have reissued this work unchanged because it is still one of the best references available for the home gardener and homesteader. After all, poultry, goats, lettuce and home canning haven't changed much in a generation. It's no wonder the "Have-More" Plan has been in constant demand since it was first published. It will show you how to do things in ways that work superbly.

There are, however, just a few items mentioned such as the use of pesticides containing DDT, which we trust you will excuse and overlook. Three decades ago our understanding of such hazards was non-existent. We can help you, through our other publications, to learn more about non-toxic materials and techniques.

Many of the bulletins and books that were developed from the "Have-More" Plan are available once again directly from us. Please write to Garden Way Publishing, Charlotte, Vermont 05445 for our free book catalog which lists the "Have-More" Plan bulletins and books, as well as the most current books by all publishers that we feel to be the best on gardening and country living.

Please do feel free to contact me for any help I can be in your quest for "A Little Land—A Lot of Living".

Sincerely,

A handwritten signature in cursive script that reads "Jack Williamson".

Jack Williamson  
Publisher



# Contents

Chapter	Page
1 Why We Moved To The Country .....	2
2 A Letter To Wives .....	5
3 What Sort Of A Place In The Country Do You Want? .....	6
4 Setting Up A Homestead .....	7
5 Houses Especially Designed For Country Living .....	9
6 Plan A "Harvest Room" With Your Wife .....	10
7 Finding A Suitable Place .....	11
8 A Little House Can Grow .....	12
9 Score Card Of What To Look For In A "Have-More" Homestead .....	13
10 Water, Sanitation, Electricity, Roads .....	14
11 Landscape Your Place—Increase The Value 20% .....	16
12 Plans For A Small Barn .....	18
13 The Importance Of Raising Part Of Your Family's Food .....	20
14 A Good Garden With A Lot Less Work .....	21
15 Vegetable Planting Chart .....	24
16 Herbs .....	25
17 The Kind Of Berries And Grapes Money Can't Buy .....	26
18 Two Ways To Have Tree Fruits On A Small Place .....	28
19 Fresh Eggs From Your Own Hens .....	30
20 New Easy Way To Raise Tender Chicken .....	32
21 Geese Grow On Grass .....	34
22 Turkeys Can Be a Profitable Side Line .....	36
23 Ducks Are Easy To Raise .....	38
24 Squab .....	40
25 Rabbit—8 To 14 Cents A Pound .....	42
26 Ham, Bacon, Pork, Lard .....	44
27 The Miniature Dairy .....	46
28 (a) The Modern Dairy Goat .....	47
29 (b) A Family Cow .....	50
30 A Few Sheep For The Small Place .....	52
31 Veal and Beef On The Homestead .....	53
32 Our Little Sugar Factory .....	54
33 Have More In Winter Too! .....	56
34 Winter Gardens—Cold Frames, Hot Beds, Small Greenhouses .....	60
35 Grow Your Own Fish .....	61
36 The Woodlot .....	62
37 Transportation And Power .....	63
38 Housekeeping On A Homestead .....	64
39 Homestead Mechanics .....	66
40 Earning A Living In The Country .....	69
41 The Country Bookstore .....	70
42 Let's Rebuild America .....	72

# Why We Moved to the Country and What We Set Out to Accomplish



**C**AROLYN, our son Jackie, and I haven't any land to sell—we aren't promoting anybody's products. We just want to tell you

some things we learned about how to have more fun, more health and more security than 99% of the people in this world ever had before.

Back in 1942, we Robinsons lived in a big apartment house in New York. Far from having all the conveniences and easy living you are supposed to have in a big city, we discovered we had very little.

In the first place, we always felt restricted. Living in the city wasn't easy, it was difficult. And every time we turned around—it cost us money.

For example, just to let the baby walk or play outdoors cost us money and trouble. First, we had to dress the baby nice (because we were going to the park), then get together blankets, diapers, his toys, etc., carry all this and the baby out to the elevator, wait until the elevator came for us, then outside we would have to walk two blocks and wait for a bus, then ride about 15 blocks and get off the bus, carry everything into the park, and find a spot where we could sit down.

One terribly hot Sunday afternoon we had gone all through this procedure and finally found a spot that wasn't crowded, spread a blanket to sit on, unpacked the baby's toys, diapers, etc. and settled down for a few minutes' peace. Just then a policeman came up to us: "Look—you can't stay here," he said.

"Why not?" I asked.

"How long d'ya think the grass would last if everybody was allowed to set and walk all over it?"

I suddenly remembered as a boy how wonderful it had been to lie in the grass in back of our house in the little New England town in which I was brought up.

We got up to leave. I said to Carolyn, my wife, "Look, let's get out of here!"

"It'll be awful hot back at the apartment," she said, "and Jackie hasn't had any sun for a long time."

"What I mean is let's get out of this dirty, noisy city—let's go live in the country . . ."

That is how we began to think seriously about living in the country. I say think about it—because we thought about it for a long time before we did it. First, we couldn't see how we could afford living in the country. Then we

began to wonder if we couldn't have a garden and maybe some chickens and by raising some of our food have more money so we could afford it.

The trouble was that a couple of our city friends who had farms always said the vegetables they raised cost about three times what they sold for in the store.

In fact, one man we knew about who had a fine modern dairy used to set before his guests two bottles. One was milk, the other champagne. "Take your choice," he'd say. "They cost me the same."

After we thought about this we realized these men were trying to run a commercial farm by remote control. Usually they went to their farms week ends only because it was so far away—and a hired man ran the farm for them. We wanted to keep a city job, for cash income; we wanted to stay near enough to the city to keep its advantages. We wanted to add the security and fullness of living that seemed more likely to come if we owned our home and some land, not much land necessarily, but good land and at least enough of it to raise most of our food.

There was nothing new about this idea. We were aware that Henry Ford and many others had been advocating just this for years. We knew that hundreds of thousands of American families were already doing what we proposed to do.

We faced the fact that we knew absolutely nothing about raising any part of what our family needed to live. In fact, our utter and absolute dependency on my job was appalling. If I should

lose my job—even temporarily—we would have no money to pay our rent—the landlord would put us out.....no money to buy groceries or pay the butcher and we wouldn't eat.

If there were another depression—and I were to lose my job like millions in the last depression—then there wouldn't be a thing to do but stand in line and beg the government for "surplus commodities" . . . rent money . . . relief clothing until things got better again—which might be years!

Living in the city we couldn't save much. Everything we did, almost, cost money. Our biggest item was food. Suppose, we thought, we could raise a big part of our food . . . We knew nothing about farming. But we began to look at things we ate . . . started to study how we could grow them ourselves. For a long time before we actually did move into the country we studied how to raise things. Perhaps in all we read a couple of hundred books and pamphlets on this. We found that most material was out of date and most of the newer books were designed for commercial farming specialists. For example, we found a dozen huge books on commercial dairy cattle, but no simple, up-to-date little book telling us how to produce milk efficiently for our family—and whether it was really economical to do so.

Then again there were lots of people telling you how to choose a farm of say 50-100 or 200 acres, but a dearth of information on telling us how little land we actually needed to raise food for one family.

Yet we gradually accumulated a good

Life in the City



many excellent books and pamphlets—all of which you'll find listed in these pages. When we had a fair idea of what we wanted to do we moved to our small place in Connecticut, about an hour from my job in New York, to try out our ideas.

This plan is the story of our place, of my family and me. It's the true story of how we have built our homestead. I hope you will be able to get some new ideas from it.

We call our plan—the "Have-More" Plan because that is the way it worked for us. Our plan shows how you can have a lovely home of your own on a piece of land that will furnish your family with food, recreation and health. Yes, and extra income too.

**If you'll follow our Plan  
Here's how you'll be situated:**

You too can have a good home and an acre or more of land within a few miles of where you work. Your place will pay for itself as you go along—you will eventually own it free and clear. Think what that means—*no more rent to pay!*

You'll have far smaller weekly grocery, meat, and milk bills. With the small scale, modern, labor-saving methods we'll show you, you can raise up to 75% of all your family's food—perhaps do it all in spare time—and find real pleasure in doing it.

You and your family can become truly self-reliant. You will be able to keep your own home in shape, even improve your house and land. You can be healthier and happier. You can be sure that the food you eat is rich in vitamins and minerals. You need never worry very much about losing your job. You can retire years sooner, if you want to, and if you'll put away enough to be assured of just a small regular income.

Best of all, you can do as much or as little of our "Have-More" Plan as you like. You can fit it to your own pocket-book and spare time. If you are in

earnest it makes no difference whether you start with just a few dollars or five thousand.

**If You Have a Full-time Job:**

You can easily work out the "Have-More" Plan in *spare time*. If you work long hours and don't have a chance to do the whole plan at present, you can do part of it in as little as 15 or 30 minutes a day. Even so you can have all the health, happiness, and security of this kind of living. You can have a fine garden, beautiful flowers, get your fruit trees and berries, asparagus and rhubarb started, and perhaps have a few chickens.

This way of living is especially good for children. You can get your place all paid for and have that wonderful sense of security and independence knowing that you and your family have your place to fall back on—knowing that you could get by with very little cash income if you ever had to.

**If You Have a Part-Time Job:**

If you work short hours, such as 40 hours a week or less, you can get all the more benefit out of the Plan. Perhaps in your work you have several days a week free or maybe several weeks or months a year free. Perhaps there's an extra member in your household who'd like to help. If you have a place like ours, you can make your spare time worth money by developing a paying hobby right on your own place.

**If You Are Planning To Retire:**

Or if you have already retired, you can see that this Plan is a most practical way to stretch your retirement income and help keep yourself in better health. If you are going to receive Social Security benefits, or just a small pension, annuity, or small income of any sort, you can look forward to many years of happiness and security.

This Plan in no sense attempts to

turn you into a commercial farmer. There is all the difference in the world between farming for profit and raising only your own family's food. A farmer is a business man whose factory is his land. Probably—if he is really successful—he has become a specialist in producing one crop—milk—or poultry—or fruit. He has spent years learning to become expert enough not only to produce quantity but also to sell wholesale at a high enough price to pay overhead, his labor, machinery costs, etc. You, on the other hand, produce only what your family needs. You save yourself retail prices. You have no labor costs—practically no overhead—no distribution or selling costs. You sell only your surplus—and can easily find a ready retail market among neighbors or friends where you work.

You will be tempted—especially during a food shortage to produce, for example, more chicken than your family can eat—and sell the surplus at a profit. This you can do—but only if you have enough spare time so that you will not have to sacrifice growing some other foods for your family's own use.

The very fact that our "Have-More" Plan calls for raising a variety of vegetables, fruit, poultry, meat and dairy products means a diversification of work, a lot of different things to do, so that none of them becomes tiresome. Planning to have a garden, a cow or milk goats, laying hens and broilers, rabbits, bees—and maybe other livestock—sounds as though you had as much to take care of as many farmers who are notoriously overworked. But you have only sufficient garden, fruit, and livestock to supply your family's food.

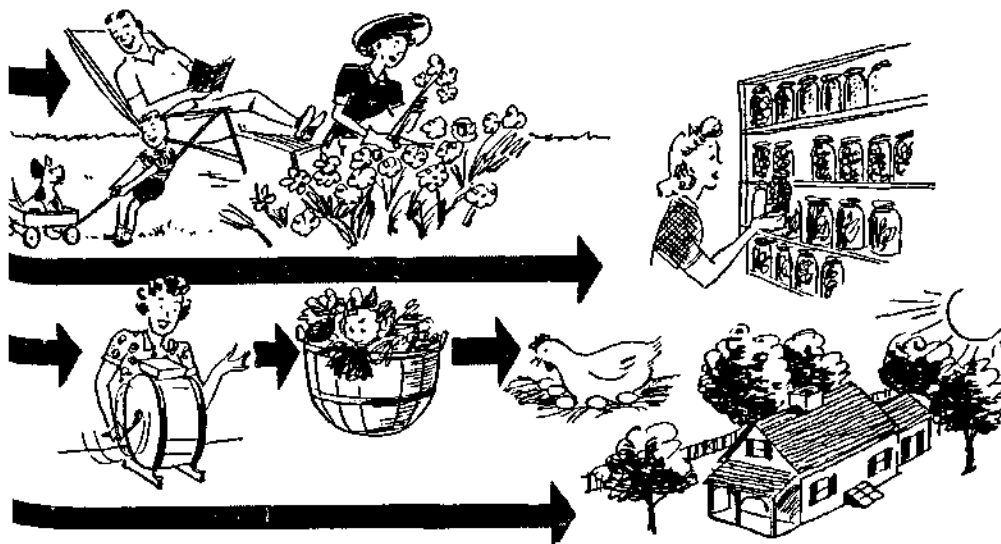
A farmer, to have been deferred in the draft, and that meant that he was farming on a full-time basis, had to produce a certain amount, according to government rulings. For example if he himself were responsible for 5 milk cows, 60 hogs, 150 hens, and a 6 acre garden, he would be considered sufficiently productive to be deferred. On the same basis, if you were supplying 75% of your family's food—that is, you had 1/3 of an acre for a garden, 2 milk goats, a dozen hens, 100 broilers, 2 pigs, enough fruit trees and berries, you would have about 1/16 of what a farmer needed to win deferment.

I point this out so you will see that it is entirely possible for you to raise your family's food in your spare time if you go at it efficiently. A garden, hens, broilers, cow or milk goats, bees, etc. sound like an awful lot. Actually, only the variety is impressive—not the quantity.

Another thing, even though you have only enough poultry to supply your family, you use the most up-to-date, easiest way to take care of it. Then again, you will find this plan broken up by projects so that you add one project at a time and get that working perfectly before undertaking another.

Every so often somebody asks

**Life at Your "Have-More" Homestead**



"How much of the Plan should I undertake?"

You yourself will have to decide this. The most difficult job is to get your house, barn, fencing and land ready for efficient operation. But once your place is set to go the actual chore time doesn't take long. A small flock of hens takes about 7 minutes care a day . . . a garden, the biggest and most difficult home food raising project, may take 150 hours a year or so.

Many people moving from the city to the country hesitate to add livestock to their places—because they don't want to be tied down. Livestock, however, can supply 40% of your family's food. Our livestock doesn't tie us down—our neighbors will do chores for us and, of course, we do chores at our neighbors' when they want to go away.

What has amazed us, was how relatively easy and practical it has become in the America of today for the average family with modest income to work out this plan of country living and city job.

No doubt many city families who have considered getting a place "out in the country" where they could live and raise some of their own food, have not done so because they thought it would take too much time and trouble to get back and forth; it would be all hard work and no play; it wouldn't be practical—it would cost more to grow food than to buy it—their chickens would die, the garden wouldn't grow, the bugs and birds would get all the fruit and berries; it would cost too much to get started anyway.

Well, the real reason we have written this Plan is to tell other people that these objections just aren't so. The average family can, today, make the country-living-city-job idea work and they can make it pay.

Some of the reasons why they can make it work today, where they might not have been able to even ten or twenty years ago, are these:

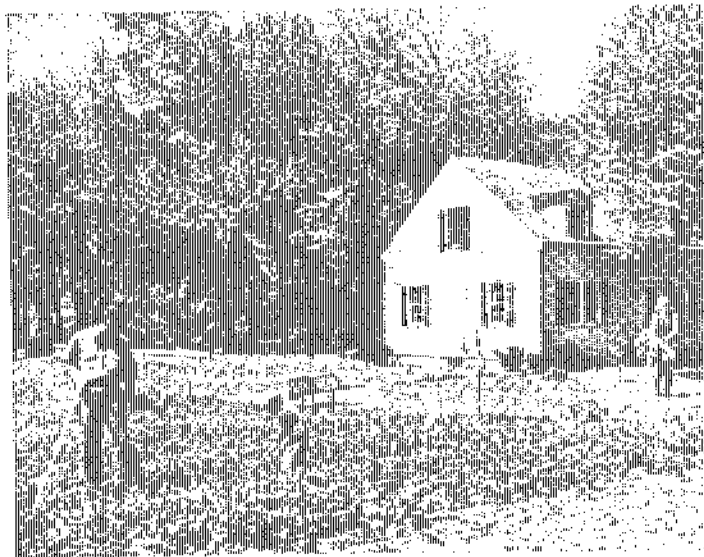
1. *There has been a tremendous amount of highway building in the past*

*twenty-five years. Automobiles and busses, plus train service where needed, make it entirely practical for most people to live a considerable distance from their jobs. These same highways and cars have taken the loneliness out of country living, too.*

2. *Modern appliances and methods have eliminated much of the really hard work in keeping house and raising food for the family. The pressure cooker and the home freezer, for example, have made preserving far easier than it used to be. The short work week (30-48 hrs.) leaves plenty of spare time for work at home plus plenty of spare time for play. To add work at home on top of a 6 day, 70 hour week was one thing. To do the same work at home on top of a 5 day, 40 hour week is an entirely different thing. What was work actually becomes fun.*

3. *It is easy to learn to raise plants and livestock successfully today. Methods are simpler, more scientific. Seeds and plants are better, surer to grow, more productive. Fertilizers are better. Livestock breeds are better—they produce more per hen, per goat or per pig. Feeds you buy are better, more scientifically prepared. Disease and pest control is far more sure and specific. For example, what the famous sulfa drugs are doing for sick people, they are also doing for sick chickens.*

4. *Low-cost, long-term federal and private financing now bring the possibility of home and land ownership within the means of people who couldn't have even dreamed of it not so many years ago. Mass production of appliances, furnishings, tools, even houses has brought the cost of getting started down to a low figure. Both of these points will be even more true in the post war years. Home freezing equipment, for instance, which before the war was priced in hundreds of dollars will be priced in tens of dollars.*



Even at 3½ our son Jackie likes to "help." Actually as yet, he isn't much help, but we try to encourage him. We want him to learn to do things — older children can be a real help on a homestead. And, more important, country living furnishes excellent opportunities for children to develop intelligent and responsible personalities.

Everything we tell you about in our Plan has been tried out by us personally, or by people we trust. We believe we can make it all work just as well as we've said it would. Of course, nobody can guarantee what results other people in other places will get. But I've made a sincere effort to give you honest and frank answers in the plainest language I know how to use.

And I hardly need to remind you that various parts of the country have differing climate and soil conditions. We are telling what we've been doing here in Connecticut (a fine state, by the way) and you will realize what allowances you must make for your own local conditions.

You don't have to spend as much on buildings as we did. We happen to think this a good investment, but are the first to admit that you can get along fine with less expensive buildings.

Building a small barn for your livestock, buying a couple of acres of land instead of simply a lot big enough to set a house on, or shelling out fifteen dollars for a pressure canner is different from the same amount of money spent on a trip to Florida or an expensive dinner and theatre party. Money invested in productive capital will bring you a great deal for a good long time to come.

We believe that many farm families, too, are going to raise more of their own food. They will forego some of their extreme specialization to develop a more rounded self-sufficiency.

If homesteading, as we mean it here, really does become a trend in the post war years, it can itself create vast business and employment opportunities. It can furnish a pattern, an idea, an objective for the city, highway and industrial planning we hear so much about these days. It can contribute greatly to continuing security for all.

A friend once said to me, "Ed, why do you bother with other people? Why don't you settle down and just enjoy your own job and your "Have-More" Homestead? Why try to spread it all over the country?" I may sound silly trying to tell you why. But I feel, somehow, that in the years to come the U. S. is going to need all the help it can get toward happiness and peace and security. We aren't always going to have a boom going on. I've got a boy and I want to see him grow up in a good country, and if ten or twenty million American families can get set as well as we Robinsons are I don't think anything can hurt this nation.

Do you see what I mean? That's why I've worked so hard putting this Plan together. That's why I was so careful to be truthful and sensible in everything we put in it.

Anyway, Carolyn and I think this is a darn good idea and we hope you think it is a good idea—so good you'll want to get some of your friends to buy a copy of this book too.

# A Letter to Wives from Mrs. Robinson

Dear Friends:

If your husband reads this plan and then tries to talk you into doing something like it, you might say, "Poor Mrs. Robinson—I'll bet she has to do most of it and I wouldn't be in her shoes for anything." So I thought you might like to know where I stand on all this.

The cue to our success with the "Have-More" Plan is found in one common little word throughout these pages. Our editorial "we" means exactly that—it isn't used just for the sound effect. We have honestly worked together as a team on everything from our first seven hens to writing this Plan. Believe me, the marriage of a man and woman really means something when you start homesteading. Somehow, working close to the earth and with nature seems to make the combination of man and wife more important and, I believe, makes marriage a happier success than is possible in sterile city life.

*Do I sound old fashioned? Let me explain that neither Mr. R. nor I came from farms originally. We married and lived in New York City for five years and I suppose we could have been described as city sophisticates. So what we have discovered as an exhilarating way of life comes from actually trying city life and country living and then choosing (intelligently, we think) the better.*

Out here on our wee farm my husband really needs me and I, in turn, could not get along without him. When he calls out, "Quick, honey, bring me my bee veil! These bees are in a bad mood," he really does depend on me to help him out.

Mr. R. naturally does the heavy work in the garden and with the animals, while I take care of canning, freezing and household jobs. But!!! We both encroach on the other's job. Mr. R. canned at least 50 quarts of tomatoes and froze a couple of dozen packages of vegetables—all after he got home at night which isn't before 7 o'clock. He's nuts, you think? Maybe, but he says it's a pleasure after sitting at a desk all day. I, in turn, do necessary chores during the day and I usually milk the goats.

Ed always envies me getting in on all the exciting events here—it's I who watched the bees swarm (sad affair, but very interesting), I who greet the fuzzy day old chicks that are so adorable, I who had the great thrill of watching the goslings gradually emerge from their shells, and so on indefinitely. There's always something happening here. That's what made me decide the old idea is really true—if you want to be happy and stay young, keep growing things around you. When you



grow vegetables, flowers, chickens, pigs, geese, goats and a child all at the same time, how can you be bored?

But about the work—that's what's worrying you, I know. Yes, I do work hard, I suppose—at least, other women seem to be impressed. But I don't work any harder than I did when I was employed in an office and at the same time kept house as so many women do. One secret I have found is not trying to keep a spotless house—I have decided it's a waste of time. I guess our other secret is that what seems dull work to many people frequently is fun to us.

Now I don't claim we enjoy doing everything—for instance, picking chickens, washing too many greens at one time for canning, or cleaning out manure. But even these disagreeable jobs are not too bad when done together, and what satisfaction I get when they're done! Being a woman you can imagine my blessed feeling at knowing I have, to name just one item, 25 broilers in my freezer—ready to be cooked for my family or friends whenever I want them. We women probably place security for our families above everything else—so you wouldn't mind being in *my shoes*, would you, if you could say—"I could feed my family well without buying another thing for six months!"

I guess you may think by now that I am a very unsociable person but I like to play as well as anyone else. I get very fed up with it all occasionally. When that happens, I try to park our child and the chores with a neighbor and off I go to the city—the Robinsons don't begrudge Mom her day off, especially when it makes her so glad to get back.

There are certain basic facts about the work though—summer is obviously the busiest season while winter gives you loads of time for parties, dinners or whatnot. Except in the middle of summer we have weekend guests who like to play at farming and in the winter we have supper parties. Incidentally, I find it doesn't cost much to entertain guests since we started our "Have-More" Homestead, because we

always have surplus food on hand. Nature has worked out a swell scheme—by the very fact of winter she forces you to rest. Then when spring comes, you're refreshed and eager to start all over again.

And I think you'll make some new friends you'll like—without exception, the people we have met in connection with our animals have been tops. I don't know whether owning animals makes people nice or whether only swell people care for animals, but whichever it is, both Ed and I have thoroughly enjoyed the new friends we have made.

After you work on some of the "Have-More" projects, you may well find you are so interested you would like to expand one of them on your very own and develop it to "pin-money" size. I, for example, really adore the geese and next year I think I'll raise a fair-sized flock.

There's one more vital point in what the "Have-More" Plan means to me. That's Jack Robinson, our little son. I can't begin to tell you what our new way of life is doing for him. He loves all the animals and already at the age of four wants to help take care of them. And we let him to the best of his tiny ability. He is already an independent little thing, afraid of nothing. And need I say what has been written so many times before—by seeing and helping care for our animals he will naturally grow up knowing many facts of life (and I don't mean just sex, though that is included). Furthermore, he will have a basic understanding of what living is all about and what it means to earn his own bread. I believe it is frequently the country boys who have made good in America—anyhow, I sincerely believe we are giving Jackie the best opportunity in the world to learn everything from hammering a nail to developing an intelligent and responsible personality.

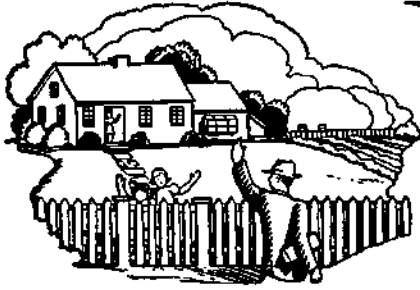
And what's more—he will have all the childhood fun for which country life is famous. From his standpoint alone all this is worthwhile.

*As you can see, I can't even keep "we" out of my own letter to you. Your husband can't "Have-More" alone—he needs all your interest and help—but isn't that the way you want it? If you start the "Have-More" Plan I truly believe you'll find many intangible rewards for yourself and your entire family—for you'll all be working together, probably more so than ever before in your lives.*

My very best wishes to you with your plan—I hope you'll get as much fun and deep satisfaction out of it as I.

Sincerely,  
Carolyn Robinson

# What Sort of Place Do You Have — or Want?



Country home for city worker



Part-time commercial farm



A business at home



A full-time commercial farm



A place to retire

**W**HEN we first wrote our "Have-More" Plan we thought of it simply as a way a family could raise a good deal of its food on an acre of land.

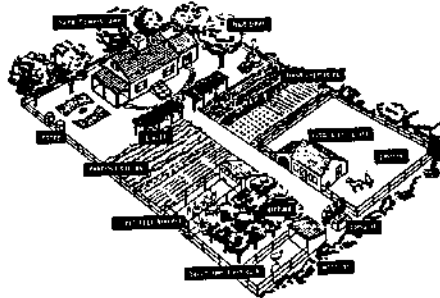
"A little land—a lot of living" was our idea. Imagine our surprise when we began getting letters such as these:

"Dear Ed and Carolyn,  
"Your Plan is just what we've been looking for out here on our 2,200 acre cattle ranch. Why should we drive 40 miles for our groceries? We are putting in a big freezer and raising our meat, fruits, vegetables, etc. . ."

"Dear Carolyn and Ed:  
We think your Plan is wonderful. Of course, we aren't interested in raising our own food, but we have bought two-and-a-half acres so that our two children, Emily, 4 and Johnnie, 2½, can have a nice yard to play in. Keep up the good work. We are recommending your Plan to lots of our friends."

From many letters we saw that, in reality, our Plan is basic to five different patterns of country living:

1) **Country Home for City Workers:** In this set-up a family's main income comes from a "full-time" job. The land that this family can use productively is limited to what can be cared for in "spare time". However, with only an acre and an hour's spare time a day it is surprising how much of its food a family can produce, how many improve-



## The "Have-More Plan" is basic for all

ments it can make, how much repairing and maintenance it can do. In fact, with proper instruction a willing family can make an acre home in the country productive enough to pay for itself. More important than any economic considerations, however, are the wholesome aspects—a country home gives a family a chance to work together creatively outdoors in the fresh air and sunshine. As the length of the work week shortens and city workers have more time to themselves, home ownership on an acre or so is going to become even more popular.

2) **A Part-Time Commercial Farm:** The distinction between a "Country Home for City Workers" and a "Part-time Commercial Farm" is a difference of degree. But because a Part-time Farm generally requires a good deal more than one to three acres of land, the distinction is important. Inasmuch as the Part-time Farmer will raise some crops for cash, the whole subject of what to raise becomes complicated by the necessity of considering a market. Generally, "part-time" is associated with hobby farming or "subsistence" farming—but thousands of part-time farmers, particularly truck gardeners, nurserymen, and even turkey raisers, farm during the growing season and work in industry during the winter and do well. The most profitable crops for the part-time or small farmer are those produced for home use.

3) **A Business in the Country:** Great opportunity lies in the "rural service field." Recently, the *N. Y. Times* said:

"The tremendous scope of the rural-service field is visualized by few. In the years ahead it is certain to include more frozen-food community locker plants, rural electrification, custom work with power machinery for farmers who prefer to hire instead of own, repair shops for farm machinery, expanded telephone service, scientific soil conservation, modern forestry and refrigeration. There will be opportunities for roadside stand sale of products bought from farmers who live some distance from main roads.

"It seems evident that we are ready for a great expansion toward higher standards of country living. It does not mean more farmers. It does mean many more part-time country homes on the roads radiating from cities and large towns."

Next time you're riding through the country, notice the many signs along the road put up by people operating little businesses of their own. It's just as though a classified telephone directory had come to life. Most of these people, whether business or professional men, own a home with considerable land around it. Very often they have a garden, fruit, berries, chickens, other livestock.

4) **A Full Time Commercial Farm:** Farmers realize farming can be more than a business—it can be a way of life. A farmer who raises only tobacco is no more secure than the man who runs the corner cigar store. But the tobacco farmer, having gone through food rationing, is now apt to be keeping a cow, a couple of pigs, poultry and a large garden. The Department of Agriculture has found that the indigent farmer was the "one-crop" specialist operating on the theory of raising everything to sell and buying all his groceries, meat, milk, and vegetables, just as though he were a city dweller. Today, most farmers know that it is not cheaper to buy their family's food. In the corn belt, points out Rt. Rev. Ligutti, a year's supply of vegetables would cost approximately \$260 for a family of five. In order for the corn belt farmer to earn \$260 cash, he must spend 520 hours working 50 acres of land and produce 2,000 bushels of corn when corn sells at 50 cents a bushel. A vegetable garden only 50 x 100 feet, with \$1.25 spent for seeds plus 50 hours of field work and 25 hours of canning will produce \$312 worth of vegetables. Which is better off—the man who raises corn to buy vegetables—or the man who raises his own vegetables?

5) **A Place to Retire:** Social Security, retirement income insurance, civil service, Army, Navy and the many pension plans of industry mean millions today can look forward to a regular income in later years. The man who will put his spare time in developing a productive country home can retire years sooner. With no rent to pay, with land and the ability to make it produce the family's food, a man can live in grand style on a small pension or other steady income.

The "Have-More" Plan is basic to each of these five ways of country living. Expressed in terms of a "platform," the "Have-More" Plan calls for:

- 1) A source of cash income.
- 2) Home ownership on at least an acre of land.
- 3) A family willingness to use a good part of its spare-time productively and creatively.

Before you dash off to the country and buy a place, consider carefully what sort of country home you want.

# Setting Up a Homestead

**A**N old farmer struck it rich in oil and his family persuaded him to buy a \$4,000 automobile. Never having had anything better than a second-hand Model T, the old boy insisted on only one thing for the new car—the most colossal and expensive set of bumpers he could find!

I wish we'd had some good bumpers when we decided to move to the country. We bumped our noses on land, on the layout of our house, on the location of our barn, fruit trees, and pasture—on nearly everything a family could blunder at. I hope you'll profit by our mistakes!

Setting up a productive country home is probably the biggest and most important job any of us attempt during our lifetime. Despite all of the people who have needed some basic data on setting up a homestead, no one had completely worked the methods out and put them on paper. Every new family has been left to stumble its own way toward the answers.

Not long after our first edition of the "Have-More" Plan went out we began to get letters asking for help in laying out a place. Of course, we couldn't give specific advice without seeing each piece of property; and then, people have different ideas of what they want to do with their place.

Even though no one layout will fit everybody's ideas and site, there are certain basic points that ought not to be violated.

For example, where should you locate your house in relation to the highway? (If you do this right you can probably get the town snow plow to do your snow shovelling for coffee and doughnuts.) Where should your barn be placed with reference to the house? Toward what compass points should house and barn face?

What are the best locations for garden, orchard, pasture, hayfield? In placing fruit trees how much space should be allowed for them to mature without crowding? How can fencing and gates be placed for easy pasture rotation and so livestock can always get water without your having to carry it?

In planning the house itself, how can

you start small and yet make additions through the years so that the finally completed homestead is attractive and efficient for country living?

If you plan your place correctly from the beginning, you will save countless steps in the years to come. You can actually cut your chore time in half. One minute saved twice a day on chores equals 12 hours a year!

## Have a Plan

Before you lay out your place you ought to be able to answer all the above points and more too. Even if you're buying a country house that's already built you should have a definite plan for refitting the house and land to your use. Over and over I've seen city people buy a farm, remodel the house but let the land go to rack and ruin. Even if you can't use all the land you've bought, you should learn enough about land management so you can rent your unused land to a neighbor and see that he keeps it in a good state. Idle land deteriorates just as fast as an idle house.

When we moved to the country about the only layout we could find to help us was the diagram below. Even though it shows so little detail as to be of questionable help to the novice, it has two major faults. The combination barn and poultry house should be located where the berry patch is—this will be painfully evident to anyone who has had to carry 100 pound sacks of grain and 150 pound bales of hay from the end of the proposed driveway 90 feet or so to the barn. The second questionable point is that far too many trees are shown in the orchard—a family couldn't possibly eat all the apples, peaches, pears, and cherries which would total about 75 bushels when these trees were mature. Of course,

you might sell the surplus, but it is difficult to make a small part-time orchard pay.

## Some Mistakes We Made

At the top of the next page is a sketch of our homestead. The things wrong with it are errors that any novice is apt to make and if we tell you about them you ought to avoid making them. First, although very pretty, there is too much lawn. Our house sits 90 feet back from the road and the front and back lawn take a good hour to mow each week. Second, our small barn is too close to our neighbor's property; there is no room for a poultry run in back of the barn—in front is our backyard play area. Third, our quarter-acre hayfield isn't large enough. Fourth, there are too many trees in our pasture—good pasture grass needs sunlight. Fifth, originally our house sat right in the middle of a woods. We believed this the best way to have trees around the house, believing it would be easy enough to clear land for garden, pasture, and crops while "only God could make a tree". However, we found it is cheaper to build your homestead on clear land and plant a couple of big trees.

Our total acreage is only about 2½. Three to five acres would give us enough pasture for our livestock and enough hay . . . . we could then depend on our place to supply us with over 75% of all our food requirements and a high percentage of the roughage and grains needed to feed our livestock.

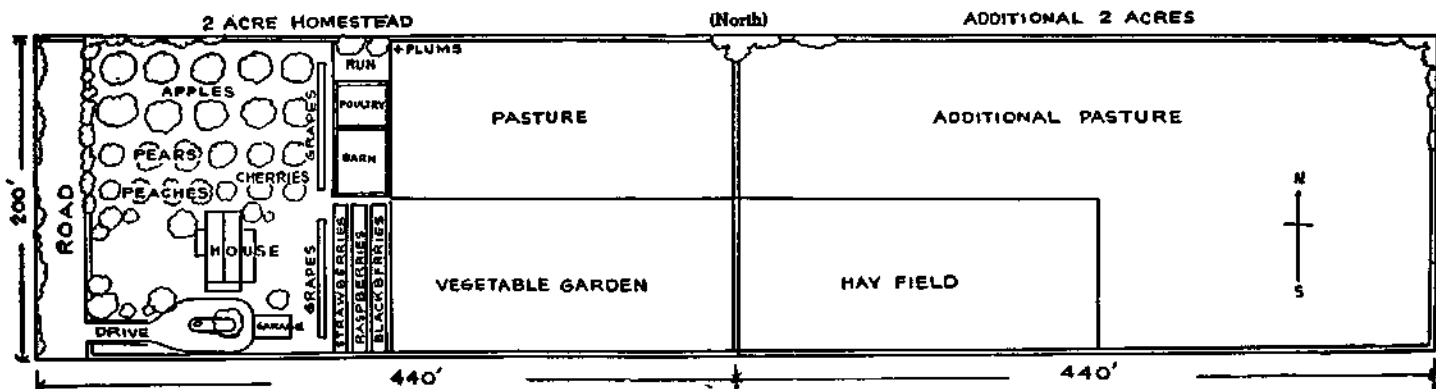
## An "Ideal" Layout

At the bottom of page 8 is a cut of an "ideal" layout for a productive country home. The drawing is available in full-

Shown below is a suggested layout for a 4 acre homestead. To the original 2 acre house plot, 2 additional acres are attached to rear. These 4 acres of good land would not only provide the family vegetables, fruit and berries but more than enough pasture and hay for two or three milk goats or pasture for a cow and a good part of a cow's hay requirements. There is also room for a pig or two plus other livestock.

On the front cover is a suggested layout for a 2 acre homestead, and on page 28 is shown a suggested layout for a half-acre.

We emphasize that these are only suggested layouts. Each family will have its own ideas on just how to manage their own particular place.



size (about as large as the top of a bridge table). Two experts helped with this "ideal" homestead plan: Milton Wend, author of *How to Live in the Country Without Farming* and John H. Whitney, R.A., an architect who specializes in designing country homes.

About 40 pages of description accompany this excellent plan; all the details can't be given here, but I'd like to point out that this basic plan of the "homestead area" (the country house, garden, barn, orchard, lawn, pastures, etc.) is a good point of departure if you're interested in any of the five productive homes described on page 6.

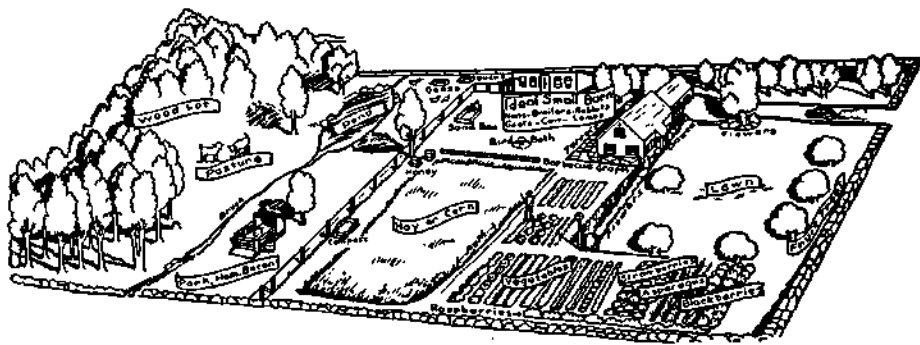
For example, suppose you want only an acre place in the country where you can have a lovely home, a garden, some dwarf fruit trees, and maybe some chickens. An acre is more than enough room; an acre, remember, is 209 feet by 209 feet. The portion of the ideal layout shown in the lower left-hand corner of this page is just over an acre. You'll notice that this "basic acre" includes a large house, an orchard of standard trees, barn and barnyard, a good-sized garden, flower gardens, lawns, driveways, and even some pasture and hayfield. The pasture and hayfield are not shown complete—the wavy line at the top of the cut indicates that these are only partially shown.

### A Larger Place?

If you wanted a larger place, a part-time farm where you could, if necessary, grow 75% of the family's food, then you'd want more pasture space and hayfield. But the basic acre is still an excellent layout.

Then again, if you wanted to carry on a business at home, the office and "shop" to the left of the living room could be built. Naturally, this could be as small or as large as needed for your business.

If you want a commercial farm, then this same homestead acre is a good layout. You'd still want a kitchen garden for home use even if you were growing tobacco, or flowers, or fruit; if you



Here's a sketch of our homestead.

were running a commercial dairy or a poultry business then you'd drop your goats or cow out of the small barn, but might well have the rest of the items. Naturally, on a commercial farm you'd add to the basic acre as much land as you needed.

As a place to retire you might want an acre, or enough for a part-time farm.

### Basic Acre Most Important

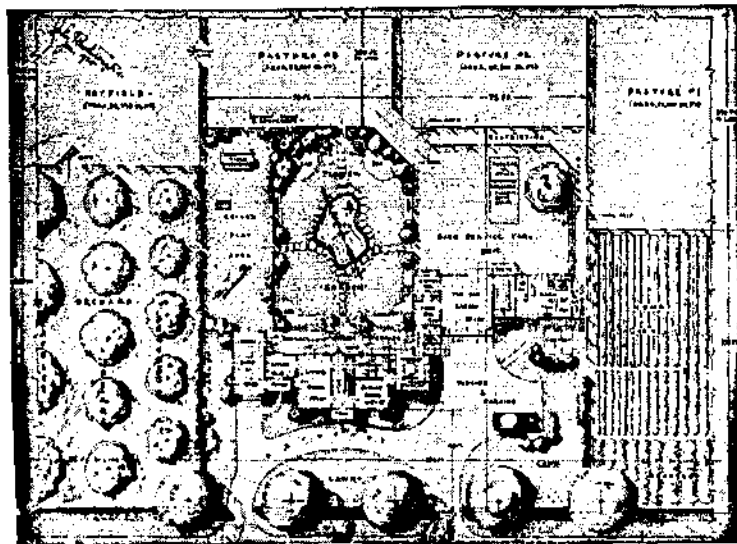
You can see that this basic acre is the key to a productive country home. Even though the house may not suit you, or the exact location of the items may be impossible to achieve, due to the fact that you are remodeling an existing place, or even because you want your place laid out differently, I think you'll find that this "ideal layout" makes a good point of departure. It does indicate basic principles that ought to be kept in mind.

For example:

- 1.) Every bit of land should be used advantageously.
- 2.) Garden rows should be of good length for easy cultivation; and run North and South for equal sunlight.
- 3.) Pasture should be fenced into plots for rotation.  
Pasture gates should be wide

enough for entry for haying and plowing equipment.

- 4.) Vegetable garden should be handy to kitchen.
- 5.) Lawn and shrubbery arranged attractively, yet easily cared for.
- 6.) Child's play area screened from street and located so it can be watched from the house.
- 7.) Compost heap should be placed between barn and garden.
- 8.) Trees should be spaced so as not to be crowded at maturity.
- 9.) Shower, bath, dressing room should be accessible from outside.
- 10.) Barn should be to lee of house; close enough to make supervision of livestock easy.
- 11.) Adequate closet and storage space in house.
- 12.) Space for good home workshop.
- 13.) Housing for garden tools, wheelbarrow, lawnmower, small tractor.
- 14.) A cold storage room for vegetables and canned goods.
- 15.) Fencing so arranged that livestock may be turned loose from the barn.
- 17.) Space for home freezer, laundry, fireplace wood.
- 18.) Orchard should not shade garden.



If you're thinking of having a place of your own — or you want to lay your present place out more efficiently — send for "Layout for a Productive Homestead" from which this small reproduction was made.

This will give you an idea of some of the things that you ought to think about when planning a homestead.



# Houses Especially Designed For Country Living

**T**ODAY practically all houses are designed for suburban living—not country living. A suburban house is simply an expanded apartment. No provision is made for the more productive kind of life you can live in the country.

For instance, if you have a garden or chickens or fruit trees, and most certainly if you are going to have livestock, you'll find that the small kitchen of the suburban house is totally inadequate. If you're going to have a laundry or you want to start your seedlings indoors or you plan on a quick freezer, you'll find no provision for these in the usual suburban house.

The fundamental differences between the ordinary suburban house and a house that's really satisfactory for productive country living or a small farming operation is illustrated in the three floor plans at the right.

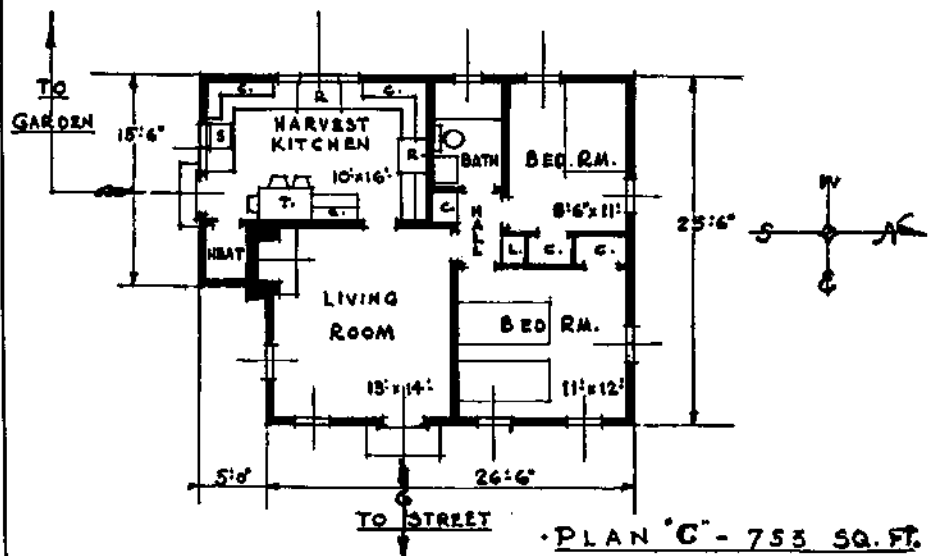
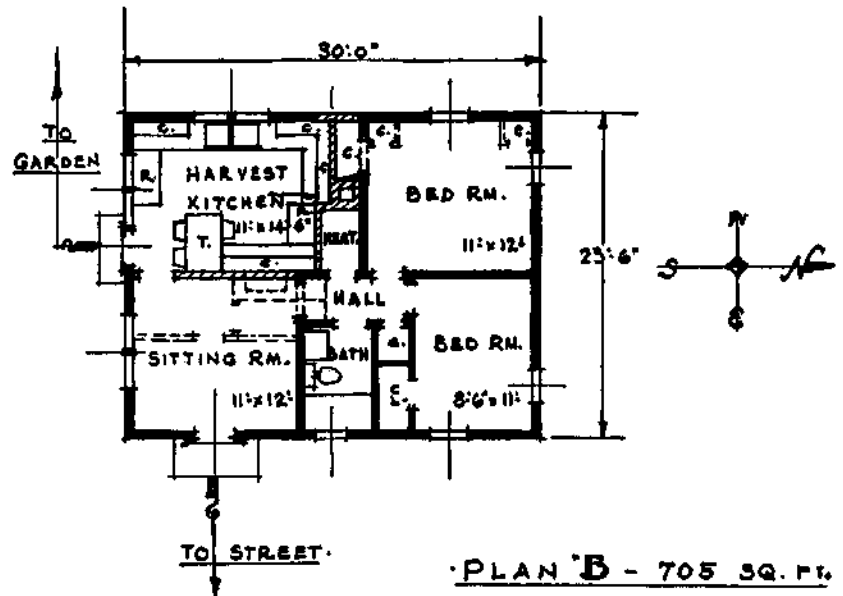
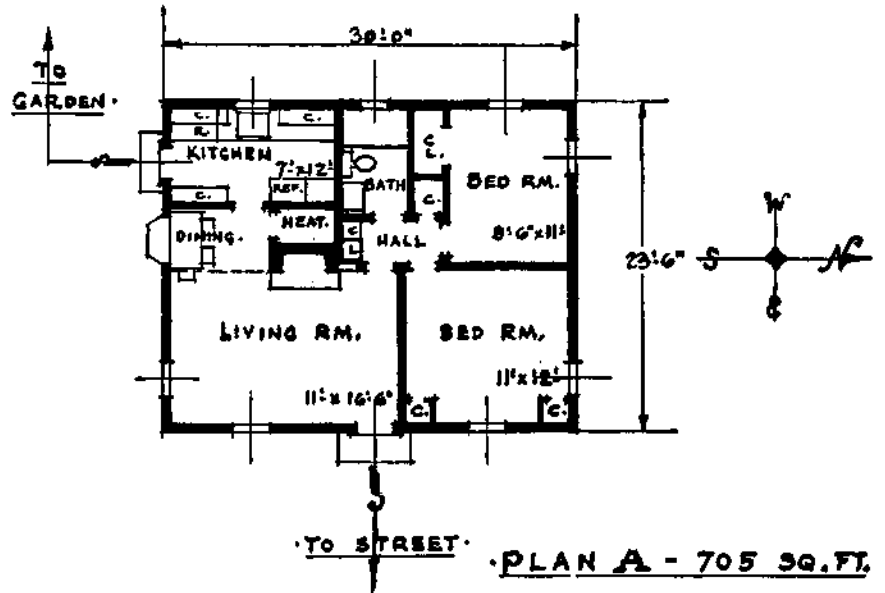
The smaller the house the more difficult it is to provide space for homestead activities. Thus we asked John Whitney, R.A., an architect who specializes in country houses, to take a good small suburban house and show how approximately the same floor area might be laid out in a productive country home.

Note these plans are about minimum—one story, four rooms, with heater space instead of a basement. Ordinarily if 10% of a house is "waste space" (hall area), the plan is considered satisfactory. Hall area in these plans is only 2%!

**PLAN A: (705 sq. ft.)** Here is an efficient suburban house well planned for that type of living. Note that the kitchen is the small apartment house type. Living room is large.

**PLAN B: (705 sq. ft.)** This is the same basic plan as "A" achieved by turning "A" up-side-down and reversing it. (Dotted lines show eliminations.) The living-room becomes a "Harvest Kitchen" with heater space, chimney, and bedroom closet off one end thereby eliminating two small closets in larger bedroom and gaining 8 square feet of valuable wall area for dining in the enlarged kitchen. Heat and chimney area of Plan "A" becomes smaller sitting-room. By reversing living-room and kitchen in most suburban house plans you have a better country layout.

**PLAN C: (753 sq. ft.)** This is an ideal small homestead. By adding 48 square feet, 76 square feet are gained for the "Harvest Kitchen." Here is room for all food preserving activities plus laundry. The living room is 182 square feet compared with 181.5 square feet in Plan "A". Bedrooms are same size in both "A" and "C". By changing the corner closets in Plan "A" there is an additional gain of 8 square feet plus wall space.



# Plan a "Harvest Kitchen" With Your Wife

**N**OT long after Ed and I moved into our country house I began to realize *my* department was going to be overcrowded.

One look at our big quick freezer, the cream separator, the honey extractor, the pressure canner—and another look at our small kitchen and we were somehow reminded of trying to get a grand piano into a phone booth!

You see, when you begin to grow a good part of your food you need a "factory" to process it and preserve it. And you just *live* differently. The ordinary kitchen-dining room combination of the conventional house simply doesn't fit.

What you need is a streamlined, modern little food-conserving set-up, combined with the charm and warmth of Grandmother's kitchen.

We went to John Whitney, an architect who specializes in country houses, with our idea. Together we planned out every detail of food preservation, preparation and serving, added such things as the greenhouse window (for winter herbs, flowers, and spring plant starting), a desk and record-keeping corner and a rocking chair corner for relaxation, darning and sewing and general coziness.

And now we have our "Harvest Kitchen." It has turned out lovelier and more practical than our fondest dreams. Believe me, if you want to make cooking, canning and freezing a joy for your wife build her a "Harvest Kitchen!"

You can add it to any house; you can put it into *new-house* plans; sometimes you can convert your present dining room and kitchen into this needed "Harvest Room" or "Harvest Kitchen" as we call it.

In our "Harvest Kitchen" (see pictures at right) we have such features as a greenhouse window, special milk-handling and cooling equipment, quick-freezer cabinet, hardwood chopping block for meat and poultry dressing, vegetable-cleaning sink, glass-enclosed preserved and canned food compartments, garbage-handling arrangement, dry food storage space, cooking, canning and work space, etc.

Isn't it astounding that such a room has never been designed, not even for a *farmhouse*?

We can't begin to give you all the important details, plans and so forth, but if you're interested in building a country house or remodeling your present one, you can write for our complete portfolio giving full information plus plans drawn up by John Whitney, the architect.



**OUR HOUSE:** This snapshot shows our house which is the so-called "Cape Cod" style. We found that the ordinary-size kitchen cramped our canning, freezing, and cooking so we planned the addition of an up-to-date version of the old "summer kitchen."



**OUR HOMESTEAD:** Another snapshot six months later showing how our suburban house has been turned into a homestead by adding a "Harvest-Room." The garage was remodeled—note the greenhouse window. Also, we improved the front entrance and added picket fence at left.



Here is one end of a special room every "Have-More" home needs very, very much. The big, roomy old farm kitchen was its "ancestor"—yet it is completely new in design and conception. We call it the "Harvest Kitchen."



This architect's sketch from PLAN FOR A HARVEST-KITCHEN is one of six showing various ways a "Harvest-Room" may be added to an existing house or planned for if you are building a new house.

# Finding a Suitable Place

**M**AYBE you already have a place of at least  $\frac{3}{4}$  of an acre of level, good land. So much the better, but read this section carefully to make sure your land is suitable for intensive cultivation.

I am going to suppose you live in the city—own no land—and know nothing about finding a suitable place in the country.

Here's how you start. Get a good map of your locality. Take a compass and using your place of work as a center point, make a circle the radius of which should be approximately the distance you can travel in one hour.

If you own a car, this radius could well be 25 miles. This 25 mile radius will enclose a territory of 1,962 square miles (an area about equal in size to the whole state of Delaware). If you expect to travel by bus, street car or subway to your job, the radius would be shorter.

Next study the encircled area. Is there any particular part of it in which you would especially like to live? Have you friends in some part? If so—talk to them about finding a place.

The most important single step in the "Have-More" Plan is selecting a suitable place. If there is any question in your mind as to whether you will enjoy owning your own home—raising your own food or living in the country—or any other doubts—rent in the community you select before you buy. Remember, you are choosing a place to make a permanent home—you are not simply leasing an apartment for another year.

The very fact that this first step is so important and difficult is a good thing because if you haven't enough gumption to go out and find yourself a place—then you probably would never

make it amount to anything even if a rich Uncle left you the place in his will.

One reason so many city dwellers continue to go on paying rent and living the restricted life people lead in an apartment seems to be because they don't know how to go about finding and developing a place of their own. Another obstacle is the mistaken belief that they can't afford a country place of their own.

## Deal With A Good Real Estate Man

Many people who go to a doctor when they are sick, a dentist when they've got a toothache, balk at going to a real estate man to buy property. Somehow they figure they can find a bargain in real estate themselves if no real estate man enters the picture. Of course, a real estate man is in the business of selling real estate—and he is going to sell everybody he can. But most people who get stuck by a real estate man let him sell them something he wants to sell. They don't tell him exactly what they want—and make him find it for them.

We have prepared a "score-card" which you will find helpful in talking with a real estate man. This "score-card" is a guide to the qualifications a place in the country should ideally have in order for you to utilize it successfully in accordance with the "Have-More" Plan. Of course, you may not find a place that has everything you want, but with your own good judgment and careful consideration you can pick the best suited available place in your chosen locality.

Take this "score-card" with you when you talk to any real estate man.

It will save you time in telling him what you want. It will save you fruitless hours of riding from one piece of property to another only to be disappointed because it is not suitable. But most important, it may save you hundreds of dollars and years of work by protecting you from buying a place that you later find impossible to make productive.

When you are buying property it costs nothing to deal with a real estate man. He gets a commission, usually 5% of the sale price, from the seller. Every real estate man has a number of houses with land listed. This same property may also be listed by other real estate agents. So you can see how competition tends to keep the prices on property in line. Usually, it is the best practice for you to talk to a number of real estate agents. Then, you can do business with the agent you like.

**A Word of Caution:** If you can, rent a place with an option to buy it at a definite price at the end of a certain time—for example, a year—do this if there is any doubt in your mind about the place and the community.

## Land More Important Than House

A good farmer in buying a new farm gives primary consideration to the land—the state it's in . . . whether it's easy to cultivate—neither dry nor wet, nor too sandy, nor too shallow. This you should also do.

We are approaching a wonderful new era of home-building. Shortly houses the like of which we have never seen will become available at low cost. Nobody knows just when these houses will be ready—but authorities agree they are coming. Remember this—and consider seriously buying your land now and getting the land in the condition you want it. Perhaps the house on it—even if it's "just a shack"—can be made livable for the present.

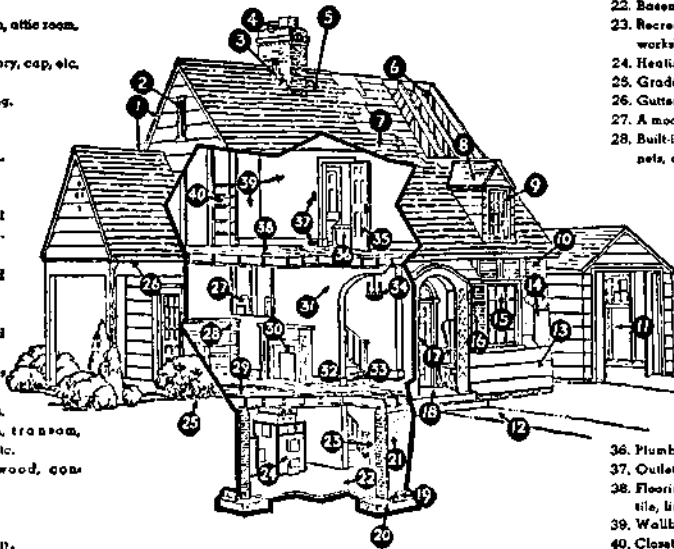
Should you plan to build your own house or buy land with a house on it? This question you can decide for yourself. If you find a suitable piece of land—I mean suitable because of size, condition, levelness, closeness to work—and it has a good substantial house on it that you like then buy it. But if you can't find on one place both a satisfactory house and satisfactory land—take the place where the land is right. You can always build a house—but some land is almost impossible to make fertile.

## How Much Money Do You Need?

If you plan to rent a place before you buy—then you can find a house and

### Points to check in buying a house (From F. H. A.)

1. Exterior trim.
2. Attic ventilation, attic room.
3. Flashings.
4. Chimney masonry, cap, etc.
5. Roof.
6. Rafters, studding.
7. Roof sheathing.
8. Dormers.
9. Weather-stripping.
10. Lath.
11. Garage—tool space, workshop, etc.
12. Walks and drives.
13. Exterior walls.
14. Sheathing and insulation.
15. Window frames and sash.
16. Blinds, shutters.
17. Porch—beach, transom, door columns, etc.
18. Steps—brick, wood, concrete, tile, etc.
19. Drain tile.
20. Footing.
21. Foundation walls.



22. Basement floor.
23. Recreation room, laundry, workshop, etc.
24. Heating plant.
25. Grading and landscaping.
26. Gutters, downspouts.
27. A modern kitchen.
28. Built-in bookshelves, cabinets, cupboards, etc.
29. Joists and sub-flooring.
30. Fireplace, mantel, flue.
31. Paint, wall-paper, interior decoration.
32. Interior trim.
33. Stairways—treads, rails, balusters, etc.
34. Electric fixtures.
35. Doors, hardware.
36. Plumbing and fixtures.
37. Outlets and wiring.
38. Flooring—finished lumber, tile, linoleum, etc.
39. Wallboard, plaster, etc.
40. Closet space, shelves, etc.

land for what you are now paying. Specifically, you can rent a satisfactory place for \$15 a month or go as high as \$100, depending on section of country.

If you plan to buy you will find the price of suitable land ranges from \$100 to \$1500 an acre. The larger the piece—the less cost per acre. If you want to buy the land only, this is all right if you are now living close enough to go to it regularly and start getting it in shape.

You can buy land by putting up a cash payment of as little as 30%. Even if your land has no house you perhaps are living close enough to have a garden. The money you don't have to spend on vegetables can then help you pay for the land. Or go get a bank to pay the owner outright and take a mortgage for the balance. If a bank won't give you a mortgage on the land, be careful. There might be something wrong with the land, its location or price.

Perhaps you can buy land with a house on it. You can then put your rent money into paying for the property. Also, a house on the land means you can start immediately making the land pay for itself because if you live there you will be able to put more time into getting your "Have-More" Plan under way.

You may be surprised at this, but 44% of all Americans own their own homes. This the government encourages by sponsoring the Federal Housing Authority (F.H.A.).

F.H.A. makes it possible to buy or build a beautiful modern home and pay for it out of a moderate income.

#### For example—a small home:

Suppose land and buildings are worth	\$2650.00
Of which the value of land is	150.00
Your down payment would be	150.00
Your F.H.A. loan would be	2500.00
Your monthly payment including principal and financing charges (taxes and fire insurance a couple of dollars extra)	\$ 20.90
At the end of 180 months your F.H.A. loan is completely off . . . you own your home and land.	

#### For a more expensive home:

Appraised value of property	\$7500.00
Total down payment	900.00
F.H.A. mortgage	6600.00
Average monthly payment over 20-year period (including principal, interest, mortgage insurance)	\$ 43.38

The purchase, or building, of your house will probably be the biggest single financial transaction you will ever undertake. Only if you have a super-abundance of funds can you afford to experiment. Few people have the technical knowledge to tell the difference between a well-built house and a poorly built structure. As the F.H.A. points out:

*The very elements which make the proposed loan a 'good risk' to the lender and to F.H.A. are the same elements which assure the borrower of a sound investment, good construction, livability, and comfort in his new home.*

## A Little House Can Grow Into A Homestead



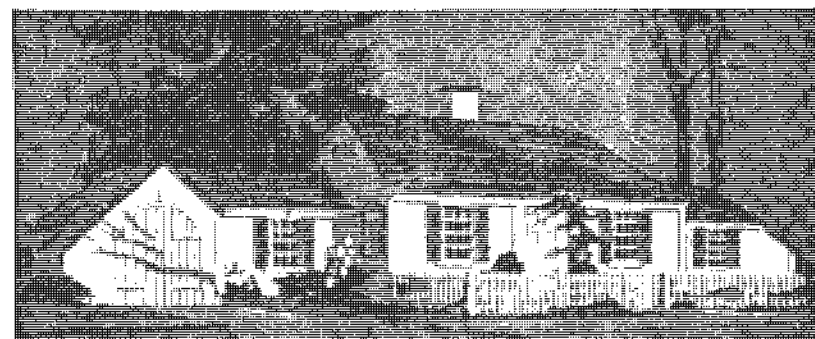
1. Here's a pay-as-you-go house that starts small and can grow step-by-step. In fact, maybe you can pay for additions out of savings made by raising your family's food.



2. Added to the main section is a nice garage and root cellar . . . garage should be deep enough to provide space for a workbench in rear and garden tools.



3. A dining room, or better yet, a "Harvest Kitchen," has been added. The house now becomes a real homestead.



4. Finally, another bedroom (at right) is built. The so-called Cape Cod style lends itself particularly well to growth.

# "Score-Card" of What To Look For In a "Have-More" Homestead

## I. LOCATION

Owner's or Broker's Name and Address: .....

.....

Distance to your job ... Commutation Expense .....

Time ..... Condition of Roads in winter .....

In spring ..... Distance to: schools ..... (school bus .....) to church ..... to town ..... Telephone Available ... Electricity ... Mail Del. ... Express ...

## II. WATER SUPPLY

Town water..Artesian well..Shallow well..Spring..

If other than town water have tested by State Health Dept. (free). Be sure you have a minimum of 2-3 gallon flow per minute *even in dry season.*

## III. SEWAGE DISPOSAL

Municipal ..... septic tank ..... cess pool .....

## IV. LAND

Total Land Available .....

Should be at least ¼ acre of good, level land. Total of 2 to 5 acres to include orchard, pasture, hay field, and land to grow some stock feed.

Size of Garden .....Depth of Soil .....

For family of five should eventually be 100 x 150. Dig holes several places. Top soil should be 7" deep; 12" is better. Important: if top soil only 6" or 7" subsoil should then not be hardpan or deep gravel.

Pasture .....

½ to 1 acre for goats; 1 to 2 acres for cow.

Hayfield .....

Not necessary—but will save you buying hay. 1 to 2 acres for 2 sheep; 2 acres for steer. ¼ to ½ acre for goats; 2 acres for cow.

Land for grain crops .....

Part time farmer probably won't have time for grain. Additional 4-12 acres necessary to grow all livestock grain.

Woodlot .....

Enough for fireplace—fenceposts, etc.

Lay of land .....

At least ¼ acre level; also hayfield level—pasture, woodland need not be level.

Natural Fertility .....

Observe present garden, vegetation, etc. Watch out for poor drainage, too sandy or too much clay, too many large stones.

## V. OUT BUILDINGS

Garage .... Tool House .... Workroom .... Barn ....

Poultry House and/or Barn .....

Barn for dairy, rabbits and poultry ideally should contain a minimum of 500 sq. ft. floor area.

## VI. HOUSE (see diagram page 11).

## VII. ORCHARD

Apple ..... Peach ..... Cherry .....

Plum ..... Grape ..... Raspberries .....

Strawberries ..... Blackberries ..... Blueberries .....

Currants ..... Asparagus ..... Rhubarb .....

An established orchard in good condition is worth money. For a family of 5 this should contain: 5 apple, 3 pear, 5 peach, 3 cherry, 2 plum trees, 10 grape vines. . . Small fruits: 50 raspberries, 100 strawberries, etc. (See pages 26-29).

## VIII. OTHER

Shade trees .....

Fencing .....

(Good fencing is worth considerable)

Length of growing season .....

(Should be 120 days from frost to frost)

Neighborhood ... Land values going up or down ...

Kind of Neighbors .....

Possibility of disposal .... Selling ..... Renting .....

Extra land available .....

Desirable place to retire to .....

Other people in neighborhood raising family food.....

Note tax rate ..... Delinquencies in town .....

Is title sound ..... Have lawyer search title .....

Any zoning restrictions against raising livestock, etc....

Asking price .....

How long property owned by seller .....

Assessed value .....

Insured value .....

What price did owner pay .....

(Sometimes you can get an idea by inquiring at the town recorder's office)

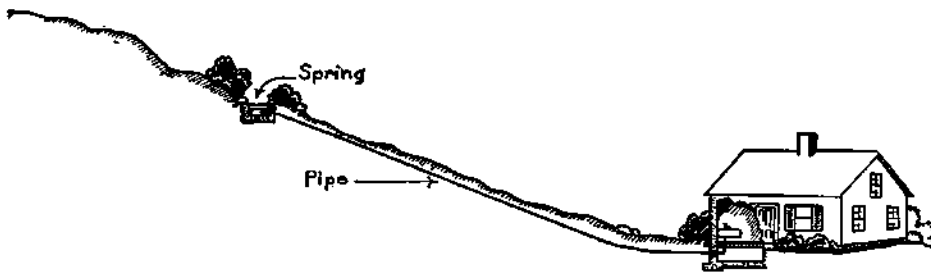
Why does he want to sell .....

Is there a mortgage .....\$.....

Down payment needed .....\$.....

Estimated cost to repair .....\$.....

# WATER . . . SANITATION . . . ELECTRICITY . . . ROADS



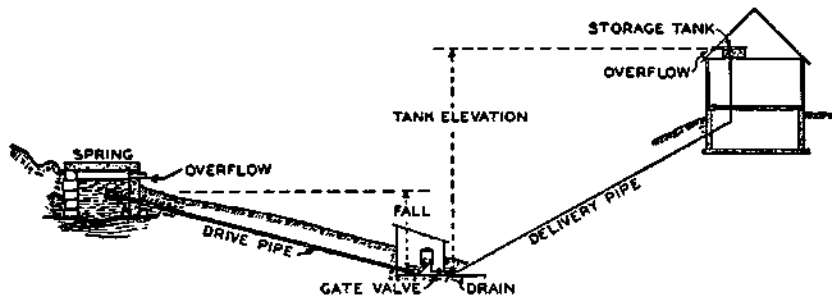
A **SPRING** is simply an opening where water flows out of the ground. It may be located at the bottom of a pond or lake. If you have a good spring near your house you may be saved the expense of digging a well. And if the spring is located on a high enough level you may be able to use a gravity system instead of a pump.

**W**HEN we bought our house in the country the water, sewage, electricity, and driveway were supposedly all finished. They looked all right to us. But we've had to spend additional money on all four.

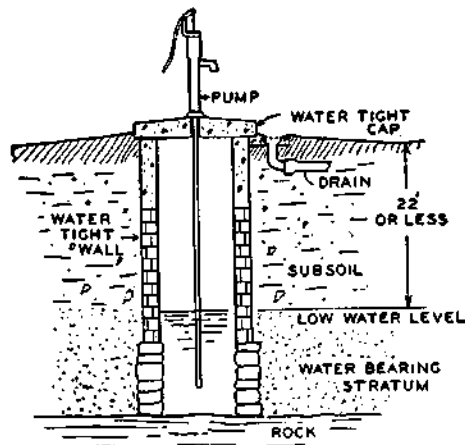
Our main expense was the need to rebuild our sewage system—the builder had installed a minimum amount of drainage pipe and no siphon discharge system. We've also piped water to our barn and to our concrete pig pen. It was an easy job to wire our barn with electricity.

We've had to add more fill and build an edging to our driveway. In short, we've found that knowing a little about country water supply, sewage, electricity, and road building is most worthwhile.

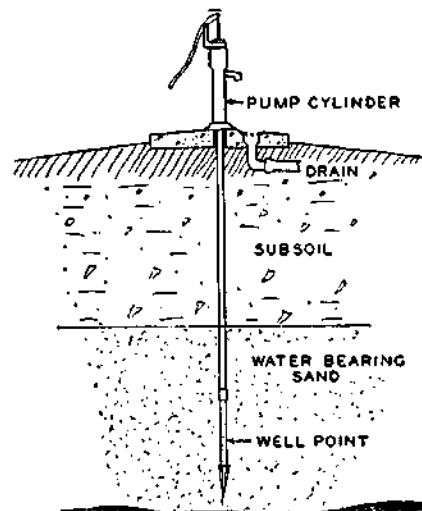
If you are used to city water service, you probably think it means an awful lot of expense and trouble to have your own rural water supply. The expense of digging a well is uncertain because you can't be absolutely sure how deep you will have to go. Still there are a lot of people living within 100 feet of a town water main who find it is less expensive to dig their own wells than to buy water from the city. One man I know, who is now building a house in town, has discovered that installing city water will cost him about \$300. On top of this he will have to pay a water bill of about \$25.00 a year. He figured up this bill for a period of ten



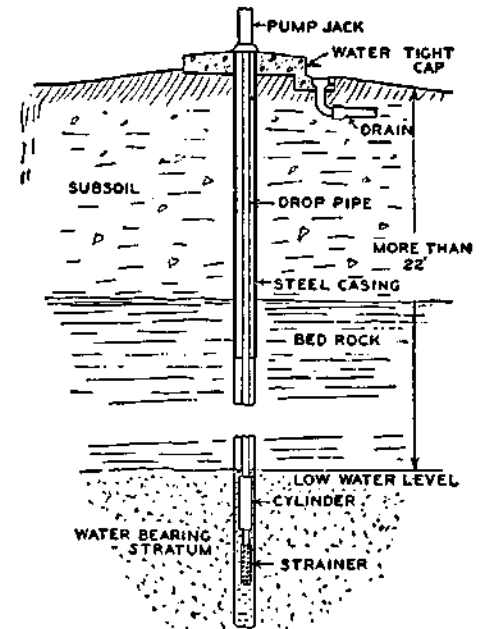
A **RAM** is really a sort of pump but it requires no electricity or gasoline and has no moving parts and is completely automatic. The water virtually pumps itself. There must be at least a 20 inch fall of water between the source and the ram. Under these conditions the ram will pump water to a much higher level, as high as 20 feet.



A **DUG WELL** is the kind that is actually dug with hand digging tools. This is the old fashioned type of well you see on many farms today. Wells are not dug by hand so often nowadays as they used to be because it is frequently easier to get a well driven or drilled. Another reason is that the dug well is more easily contaminated by seepage through the walls or from above. On the other hand, this type of well if properly constructed can be kept entirely pure and provide plentiful quantities of water for generations. If you're thinking of digging a well yourself, you'll want to learn more about this kind of well.

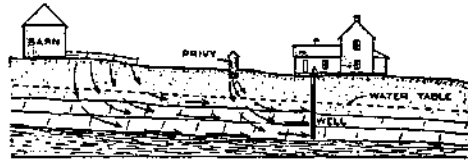


A **DRIVEN WELL** is made by driving into the ground a simple pipe fitted with a well point. It may be either a deep or shallow well, depending on how deep you go to get a satisfactory flow of water. If your soil is suitable for this type of well it is something worth investigating for it usually costs less than drilling a well or digging one. It is not generally considered as reliable as an Artesian well (which produces a steady flow of water), but in some sections it is quite satisfactory. You need a good sized storage tank and you should know what to do if the well points become clogged.

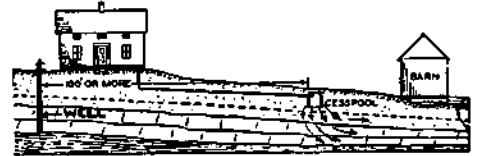


A **DRILLED WELL** is made by drilling a hole into the ground 4 to 8 inches in diameter with special well-drilling equipment. The upper part of this well is lined with a steel casing which protects it from contamination. If you think you will have to go down deep to get water, you should learn more about drilled wells. Also you will need to investigate deep and shallow well pumps. The cost of a shallow well pump is much less and can be used with a good Artesian well when you don't have to pump water up from over 22 feet.

## LOCATING THE RURAL WATER SUPPLY



**BAD**—This well is located too near the barn and sewage disposal system. Sewage seeps into the well or drains directly into ground water the well uses.



**GOOD**—This well is located where it is not likely to be polluted by the sewage disposal system or livestock in the barn. Cesspool is over 100 feet from the well.

years (\$250) and added it to the \$300 he would pay for installing the city water, getting a total of \$550. When he compared this cost with that of drilling a good Artesian well 100 feet deep and putting in his own electric shallow well pumping system, he found that the city water over a 10 year period would cost him \$50 more . . . And in 20 years this city water would cost \$260 more. In 30 years he could install an entire new pump and tank and still beat the cost of city water for this period by \$400!

Here is a comparison of costs:

### YOUR OWN WATER SYSTEM

#### Low Estimate

Drilling 50 ft. well (@ \$3.50 per foot)	\$175
120 gallon tank	40
Labor	25
Shallow Water Pump	45
Upkeep for 10 years	30
	<hr/>
	\$315

#### High Estimate

Drilling 300 ft. well	\$1,050
150 gallon tank	50
Labor	50
Deep Water Pump	150
Upkeep for 10 years	50
	<hr/>
	\$1,350

### CITY WATER SYSTEM

Installation	\$300
Water bill for 10 yrs.	250
	<hr/>
	\$550

As you can see, your well may cost you anywhere between \$175 and \$1,050. About the only way to predict this cost is to find out how deep your neighbors had to dig their wells. Unless there is something unusual about your situation, you will probably have to go to the same depth. Be sure to have your well water tested for purity. The Health Department will make this test free in most states.

We've discussed a few of the many ways you can obtain water in the country. There's probably one combination just right for your circumstances.

## Sewage Disposal

If you don't have city sewage disposal there are three practical solutions to your sewage problem: a cesspool, a septic tank, or a septic tank with a siphon discharge system.

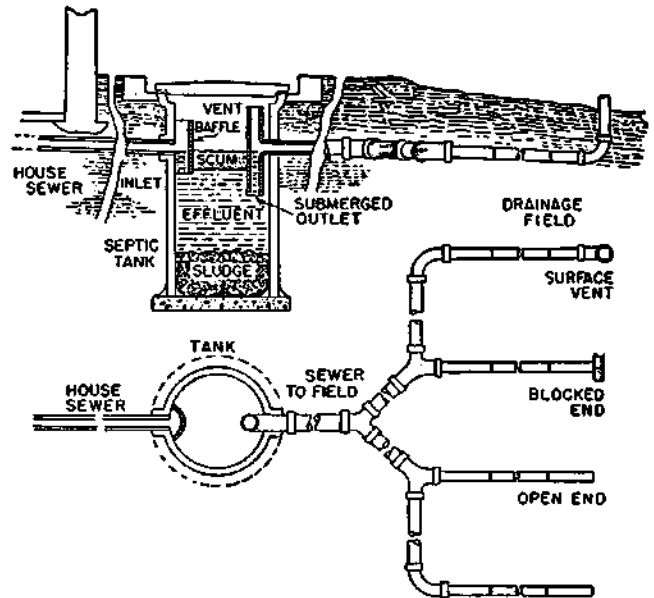
Maybe you can use a cesspool, but on a long term basis you should consider spending a little more money and getting a septic tank.

After we bought our place, we discovered that our septic tank didn't have a siphon discharge system. This caused fouling of the ground near the tank. We had to dig up the whole system and found a siphon discharge tank was needed. The siphon discharge method distributes the sewage more forcefully so it spreads over a much wider ground area. Sometimes you can get by without the siphon discharge feature in a vacation home.

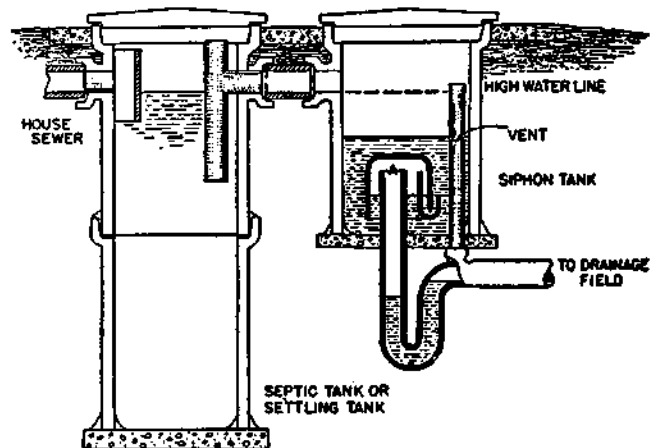
## Electricity

If your house has never been sup-

Here is a simple septic system with only one tank and a tile drainage field. Inside the septic tank are anaerobic bacteria which decompose a part of the solids into liquids and gasses. Incidentally these bacteria are killed by pouring strong disinfectants and mouth washes down the drain in your house.



Here is a septic tank with a separate siphon discharge system. Another workable combination is a single septic tank like the one shown above which drains into a cesspool instead of a tile drainage field. The whole problem of proper sewage disposal is so important to health that it will pay you to go into the subject pretty thoroughly before you decide which system to use.



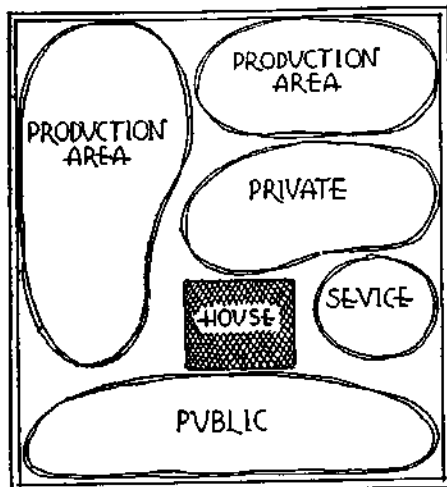
plied with electric power, measure the distance to the nearest power line. In our area the cost of getting this power to the house is about 25¢ a ft. You can reduce this cost by getting neighbors to come in with you. The more people on the line, the less each has to pay. Also, your contract with the power company should entitle you to a rebate when other people come in later. In wiring a house it's important not to underestimate the size of the wire needed. Some day you may want an electric stove, a freezer, electric power tools, or electricity in your barn and hen house so it's safer to use a no. 12 wire rather than a no. 14, the legal minimum.

## Roads

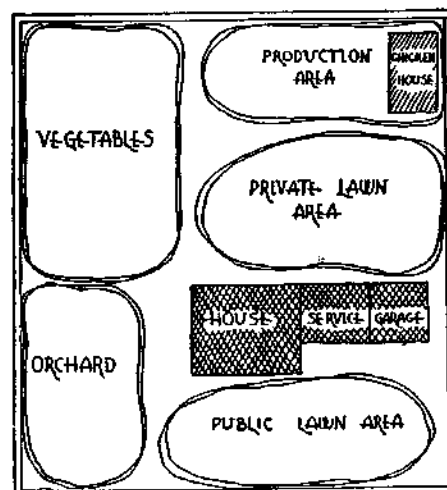
Particularly today when land values are high you may save hundreds of dollars by buying land off the road and building your own road to it. Land not touched by a road may be a far more desirable site and usually sells at 30% or 50% less. If you build a road acceptable to your town or county, you can get it declared a public highway and have it kept up by the town.

# Landscape Your Place—Increase the Value 20%

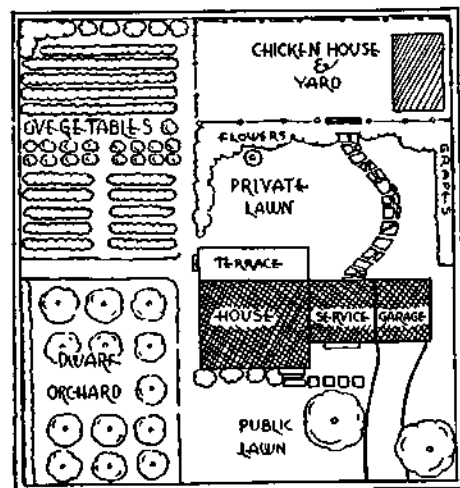
## Developing a Plan



FIRST—Divide your place into four separate areas: public, private, service and production.



SECOND—In each area lay out the buildings, gardens, lawns as desired.



THIRD—Decide how each area should be planted to make boundaries for privacy, beauty and productivity.

**A**LTHOUGH our homestead is not for sale, in January of this year I was offered more than twice the amount we originally paid for it.

Part of this increase is due to inflation and the housing shortage. But even a few years from now when the housing shortage is over and inflation has levelled off—and maybe real estate prices will take a big drop—even then I feel confident that our homestead will be worth considerably more than we originally paid and will be far more desirable and easier to sell than it was when we bought it.

One big reason for this extra value is the simple combination of a few little things that improve its appearance and its outdoor livability. I don't want to call it landscaping because you may think that means we have a large estate or have spent a lot of money on fancy things whereas what we've actually done is to plant a few inexpensive trees, shrubs and flowers in the most natural places. The amazing fact is with \$25 worth of seeds and plants you can add literally hundreds of dollars to the value of a small place. More important, the place becomes lovelier and more livable. Your aim needn't be to make your yard showy—but just the kind of place people want to be in—a place that feels right outdoors.

If you'll look at the two top pictures of our place on page 10, you can see a couple of smaller changes that made a big difference. See how much better the small evergreens look compared with the tree at the corner. Also note the big improvement in the front entrance. Although it doesn't show too much in the snapshot, the picket fence (at left) gives the house a longer look.

Next time you are driving in the country look at the difference in various houses. Some seem bleak and undesirable. Others seem friendly and inviting. Often you see a new expensive place equipped with many modern improvements that you just wouldn't want to have for yourself. Then you'll notice a less expensive, less modern place, perhaps with a nice orchard and an informal hedge of berry bushes and several nice shade trees. This sort of place, though less modern, is the one that says "home".

Just what is it you do to a country place to make this difference? Here are a few suggestions—a five year plan that can greatly increase the value of a small homestead:

## A 5-Year Landscape Plan

### 1st Year

Become familiar with basic landscaping methods so you can work out a good plan for the entire place. Make a pencil layout of your land showing the

house, road, driveway, nearest neighbors, barn, vegetable garden, etc. On this drawing show where you want to plant shade trees, fruit trees (dwarf), hedges and vines. Then mark desirable spots for flower beds, climbing roses, etc. You may need a screen of privet hedge or hemlock for privacy or to conceal the laundry yard or compost heap or close neighbors. If you want tall trees in a hurry, consider the fast-growing poplars—also privet hedge will grow high in one season. You can plant beds of perennials the first year too, but plant only as many as you can manage. Plant the trees, vines and shrubs first because they will take several years to grow and develop. If you don't like cutting the grass, you needn't have a large lawn. You can make it small by setting a hedge of brambles or berries, for instance, at the desired limits and beyond plant a beautiful field of alfalfa or clover.

### 2nd Year

Finish planting the flowers and any shrubs still desired. Be sure to have some good perennials (peonies, chrysanthemums, iris, hollyhocks). Study up on outdoor furnishings—maybe a terrace near the house or a trellis for climbing roses or grapes. Decide where you'd like to have a garden seat beneath a good shade tree or possibly an arbor with a love seat, swing or hammock.

### 3rd Year

Develop your present plantings a little more as needed. By now you may be ready to add the trellis you've been planning and some simple garden furniture. A brick walk set in sand can be very attractive and is easy to do. Consider adding a combination fish pond and garden pool using it partly as a fence with a border of blueberries. Any steep slopes or terraces will make a good place for a rock garden.

### 4th Year

By now you have finished all the foundation plantings. You are getting fruit from your dwarf fruit trees and berries from your "hedges" of raspberries, blackberries etc. A few finishing touches will probably be needed in the flower bed. Try to have enough flowers so they will bloom continuously from Spring to late Fall. Plant borders along the front walk from the house to the road.

### 5th Year

The plan should now be about complete, but you will see obvious improvements. For instance, you may want a little more variety now in your flowers and fruits. See if you can't find a few interesting and different varieties in your reference library. Consider ways to blend your animals into the general



scheme—especially ducks and geese in the pond, goats in the more wooded section, sheep on the more distant slopes. By now your experience, plus a little study, will tell you what is needed.

Be sure to take a picture of your homestead before you start this plan and another after it is completed. I'll bet there will be such a difference in the two photographs that you will hardly recognize the old place.

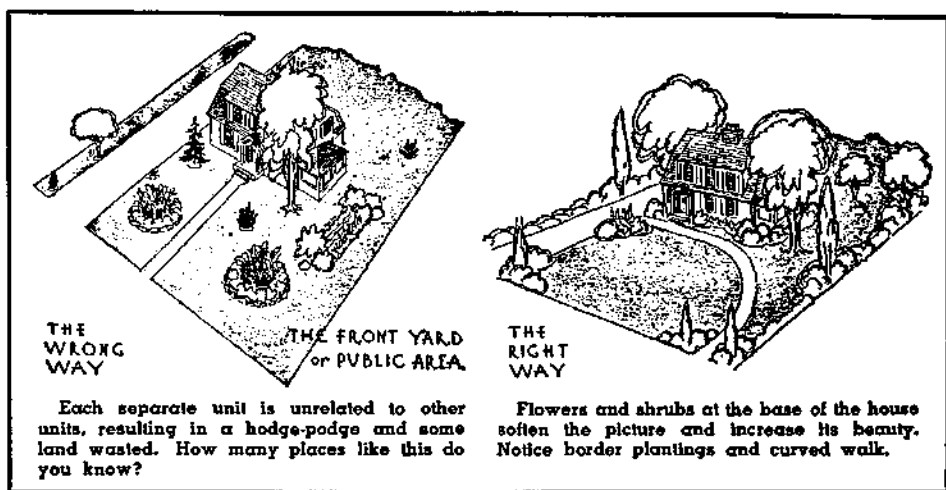
Now finally, to save you needless expense on plants and seedlings and flowers, here are a few practical tips:

- 1.) Always have your holes dug before you get the plants for transplanting.
- 2.) Transplant immediately—don't give the plants time to dry out or they will die.
- 3.) Plan to get "bare root" plants in early Spring or late Fall. At this time it is not usually necessary for plants to be balled and burlapped (as it is in the Summer) so you will save money.
- 4.) Don't buy more plants than you can plant in a day.
- 5.) Most big nurseries have a surplus list of trees and bushes which have grown so large that they must be transplanted. These are often reduced in price "for clearance". They will be perfectly healthy plants if you are dealing with a reliable nursery.
- 6.) If you learn enough about trees and plants and flowers you can master the trick of getting them from the woods and having a "wild garden" on your own grounds. Many varieties cannot be obtained in any other way.

At the right you'll find two aids to landscaping which can be a lot of help. First of all at the top are the two little diagrams showing the "wrong way" and the "right way" to arrange plantings and driveway of a small area. It shows pretty clearly what a mistake it is to just plant anywhere, how you can spoil the looks of your place by bad planning even though you may spend a lot of money for pretty flowers and beautiful trees. Of course you can avoid this by having a landscape architect, but we don't think that is necessary for a small place.

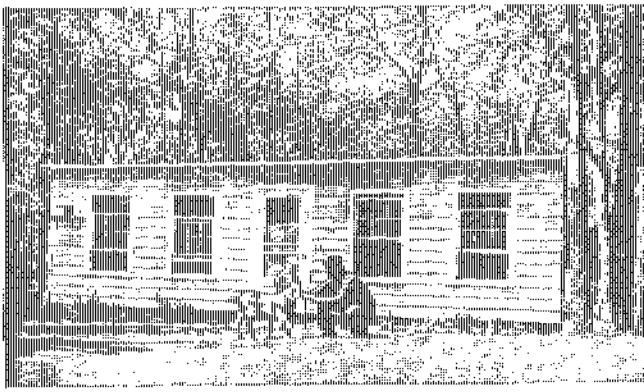
If you will do a little reading on the subject you'll find landscaping is simple and it's easy to learn the don'ts.

Below the "right-wrong" diagram is a landscaping score card which we've adapted from a farmstead score card put out by the Agricultural Extension Service at Ohio State University. You may not agree with all of the things listed here—some points are largely a matter of personal taste and a great deal depends on your locality. But we think you'll find this score card very useful just the same, for checking over your own place and finding ways to improve it.



## Score Your Own Homestead

	Value points	1st scoring	2nd scoring
<b>I. — CONDITION OF GROUNDS:</b>			
1. Arrangement—well separated areas for lawn, service, storage, stable yards, etc.	8		
2. Livestock and poultry in pens away from house and opposite direction of prevailing winds.	6		
3. Drainage of ground — good natural drainage or by grading and tiling, if necessary.	4		
4. Convenient system of walks and an attractive driveway, hard surfaced.	3		
5. Freedom from rubbish and scattered machinery.	3		
<b>II. — LAWN:</b>			
1. Well graded. Surface should sag rather than bulge. Should slope away from the house in all directions.	5		
2. Should have a smooth dense turf free from weeds.	5		
3. Should have no flower beds, trellis, or benches except around edges. Center should be open.	3		
<b>III. — BUILDINGS:</b>			
1. Dwelling			
a. Good design. Simple, seems to belong to setting.	7		
b. Well painted and in good repair.	4		
c. Appears as the most important building of the homestead as seen from the approach.	3		
2. Outbuildings and barns			
a. Properly placed — not too close to the dwelling.	5		
b. In good repair and painted.	4		
<b>IV. — PLANTING:</b>			
1. Good shade trees in rear of dwelling to form background, and in the front to frame building and to give shade on dwelling where needed.	6		
2. Screen planting of shrubs and trees to hide unsightly objects from dwelling and road.	6		
3. Good taste and restraint in use of vines on walls and fences; and in shrubbery at base of house and along margin of lawn.	5		
4. Some large hardwood trees in barnyard well protected from livestock. Protective frames on all young trees in this area.	3		
5. Some space devoted to the growing of annuals and perennials. Materials well cared for.	5		
<b>V. — SOME PROVISIONS FOR FAMILY RECREATION:</b> (Tennis court, outdoor fireplace, picnic area, etc., well placed.)			
	8		
<b>VI. — ATTENTION TO BEAUTY OF ROADSIDE:</b> (Adjacent to farmstead.) Absence of billboards. Native trees and shrubs preserved. No weeds.			
	7		
<b>TOTALS</b>	<b>100</b>		



## Plans for a Small Barn

**T**HE idea for this "Have-More" Plan came to us at a party—our own "barn warming" party.

When our small "concentrated barn" was finished, we thought it deserved a celebration. And so we invited all the neighbors and our friends to come and see it. We had planned and built our small barn to house not only our milk goats and their kids, but a couple of sheep, 25-30 laying hens, a battery brooder that would produce 30 broilers a month, a six compartment rabbit hutch, a squab loft, plus storage space for grain, straw and bailed hay. Yet the size of the barn was only 16 x 30 feet, as large as a fair-sized living-room.

Of course, Carolyn and I—and Jackie—thought our small barn a thrilling place, but when we discovered how interested our guests were in all the animals and the compact, efficient layouts we had worked out for them, we saw that perhaps many people would be interested in the idea of a family producing a large part of its food in spare time on a small amount of land. Eventually, with the prodding of two friends at the party who are in the publishing business, we got this "Have-More" Plan written.

Now after producing about 75% of our family's food for four years, we realize there are three main fundamentals which set a *productive* country home apart from the ordinary "house in the country." First, the layout of the grounds should be planned for efficient working of the land. Second, a "Harvest Room"—or a large kitchen—carefully planned for the *processing* of food, as well as the preparation, is needed to make the wife's part enjoyable. Third, an efficient small barn is a necessity—a homesteader's livestock can account for 40% to 50% of a family's food.

### "Slightly Crazy!"

When we planned our barn we had almost nothing to go by. We wrote to all the barn equipment people, the lumber companies, the state and federal departments of agriculture, asking if they had small barn plans to house goats or a cow, laying chickens, rabbits, sheep, ducks, a pig, pigeons, and geese. Some of the answers indicated that the specialists thought we were slightly crazy. Some wrote of small commercial barns that we might adapt.

Well, we finally ended up with somewhere around \$15 worth of miscellaneous plans. None of them suitable for what we had in mind, however. So we set about designing our own barn. It was quite a job. We got the most efficient layout for poultry from one place, the best arrangement and style of goat stalls came from study and visits to a number of goat keepers and goat dairies. The broiler battery we bought for around \$30 and the rabbit hutch for \$20; both are of wire, sanitary, and efficient.

I was determined that our barn would be easy to operate with the best practices adapted from commercial barns and not cost us a fortune either. We moved to our country house in the fall and didn't start our barn building until the following spring. During the "long winter evenings", which actually flew by as time does at our place, we worked out scale models of goat stalls, brooder, hutch, feed storage, etc.

I was also able to locate not far away, a dilapidated horse barn and bought it "as is" for \$35. It had a lot of good siding and some usable timber in it.

### Wrecking Is Fun

Wrecking the old barn was fun. A couple of teen age boys in the neighborhood got interested in my barn project and they turned out to be a big help in tearing down the old barn. In fact, if you can locate an old building to use and get it cheap enough, then I highly recommend rounding up a couple of teen age boys, buying them each a fifty cent wrecking bar, and turning them loose on the barn you want to demolish. Of course, you'd better be around to see that they don't pull the barn down on their heads.

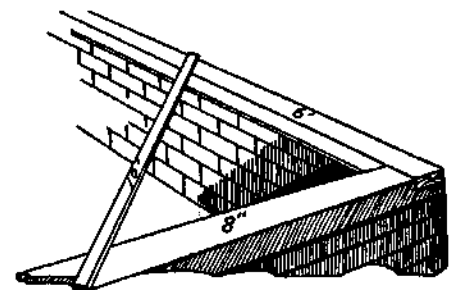
Anyway, a Saturday afternoon and Sunday was enough time for us to get the sizable horse barn down flat. The following half-dozen winter weekends we spent in what is known as "cleaning up the lumber." This is the tedious process of going over every piece of timber and board and pulling out the old nails. Incidentally, this job is what makes it costly to hire a carpenter to take down an old building and re-use the lumber in a new structure. Usually, unless you are given an old building outright, it doesn't pay to have a carpenter pull it down, clean up the lum-

ber, and build with it. A carpenter dislikes old boards because he's apt to run his good saw into a nail and then its an hour's job to resharpen and reset it. Incidentally, an old barn is worth more than an old house—a house doesn't usually supply any more usable lumber and the wrecking job is much greater.

As we cleaned up a pile of lumber, we stowed it in our Crosley, with one of the front seats removed and the top down, and trucked it down the long hill to our place. Naturally, we piled it well so the air could circulate through it until spring.

When the ground thawed, we started building. I believe it was around the first of April when we could actually begin the trenching for the foundation. Before we started, Carolyn and I had a long heated discussion as to exactly where the barn was going to be located. She wanted it six feet closer to the house than I did. Her desire was based on aesthetic reasoning—mine on the practical point that if it were six feet closer, then I would have to dig and chop my way through a tremendous root. Finally, after we delayed the digging a weekend while we argued, we agreed to compromise because the goat we'd bought was due to kid the last week in May and we had to get the barn done so she could freshen in it—a goat is supposed to "take to" a place after she has had her kids there. We compromised by splitting the difference—only I still dug through the root.

In laying out the barn, which was to be 16 x 30 feet, I measured 16 feet one way, then 30 feet along the South side, 16 along the West end, and 30 feet along



How to make a building square: measure 6 feet on the end sill and 8 feet on the side—if a cross piece then measures 10 feet (from outer edges) the building is square. This is often called "the rule of 5, 8, and 10."

the back. I connected the stakes with string and started to dig. That, it turned out later, was where I made my first mistake. I forgot, or rather didn't know, one important thing. I should have measured diagonally across corners to see if the measurements were the same. By not doing so, I wound up with a parallelogram instead of a rectangle. Not a noticeable one, but I was off about eight inches.

The foot-wide ditch I dug through stone and roots—there was very little soil as I well remember—to a depth of about two feet which is below frost level in our part of the country.

The next step was building the wooden forms into which concrete for the footing and the foundation wall was poured.

### Cement—Ready-Mixed!

We ducked the laborious job of mixing gravel and cement and water to make the concrete; we simply ordered the cement ready-mixed just as a professional builder does. Ready-mixed cement delivered to the job costs little more than the materials and this is the best way to buy it when you are using a yard or more—this is the minimum amount usually delivered.

Before the cement stiffened in the forms we sunk about a dozen half-inch, foot-long iron bolts upright to use later to anchor the 4 x 4 sill to the foundation. If you have the bolts on hand it is a simple matter for the man who brings your cement to place these for you.

In two days the cement had hardened so we could take off the forms, but inasmuch as we couldn't do any more cement pouring until the next Saturday, we spent evenings tossing in stones to bring the ground inside the foundation up to within 6 inches of where the top of the floor was to be. Three of the six inches were filled with cinders.

On Saturday we were ready for the floor. The cinders were raked level and the sloping form for the dairy gutter was braced in place. The concrete floor was poured in three sections. The fellow who brought the concrete showed us how to lay two 12 foot 2 x 4's just inside the concrete foundation but three inches down from the top. Concrete was poured and the top of these 2 x 4's used as a guide for another 15 foot 2 x 4 which we sawed back and forth leveling the cement. This is not nearly as complicated as it sounds. We used wooden trowels to smooth off the top surface because we didn't want it as slick as you can make cement with a steel trowel.

The next step, according to the good book on carpentry we were reading, was to "lay the sills." This highly technical sounding procedure simply meant to take a piece of timber, in this case we used 4 x 4's from the old barn, and lay them lengthwise along the top of the concrete foundation. Where necessary, holes were bored in this sill to let the anchor bolts come through; the

washers and nuts were not screwed on for a few more days just to be absolutely certain that the bolts had hardened into the cement. The sills were set all around the foundation except where the doors were to go.

Next, at the four corners, 4 x 4 uprights (7½ feet at front, 4½ feet at back) were set in place, leveled so they would stand absolutely perpendicular by tacking a pair of braces from about half-way up each post down to the sill at either side. Then the corner posts were spiked to the sills. The 7½ foot 2 x 4's were cut and nailed up. The 2 x 4 plate, the piece that goes across the top of the studs, was leveled and nailed. Next the two end rafters were notched and fitted. The end studs cut and fitted under the end rafters . . . then all the rest of the rafters were put in place, we started boarding the sides and roof.

None of this was complicated, but it did take a good deal of time because we had to figure each step out as we went along. In fact, I would like to say right here, that there is nothing complicated about building a chicken house, a barn, or even the traditional country house. And now that the prefabricators are offering complete heating, plumbing, cooking, freezing, and laundry facilities built in one compact unit, building your own house has become about as easy as building a log cabin.

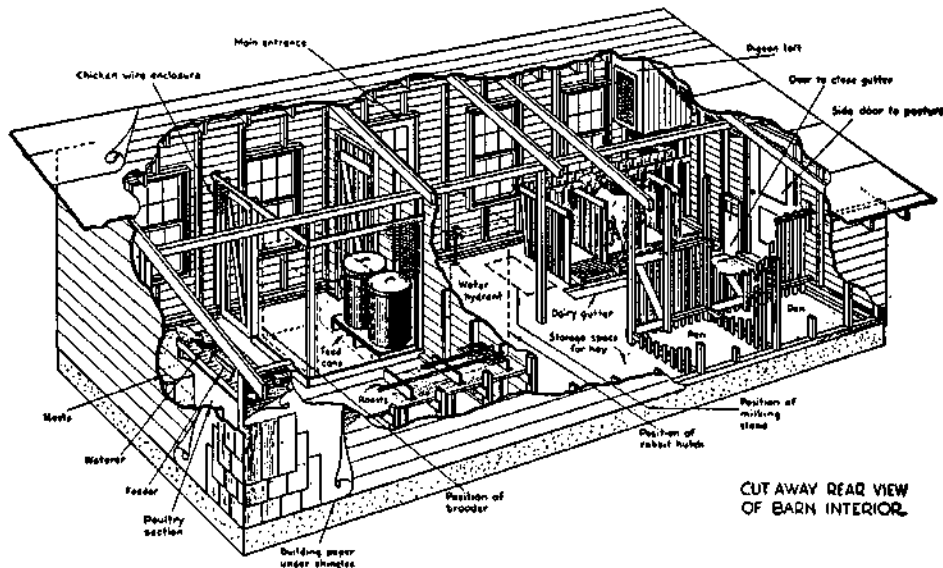
If a person has just a little manual dexterity, say the ability to drive a car, then he will have no difficulty in doing practically all the building that has to be done on a homestead. Carpenters, masons, plumbers, electricians love to make a great mystery of things—and the building codes, the building supply people, the utilities and appliance manufacturers do their best to keep the average householder from doing any building on his own. But the truth of the matter is that most of the skills of

the average mechanic are pretty simple to master. Naturally, their speed and accuracy is based on years of practice. But just as anybody who can read music can play all the notes in a difficult piano piece, anybody can build a barn or a house if he'll get some good manuals on building and good plans for what he wants to build—the difference is that in the case of the amateur at the piano, the piece won't sound right played so slowly, whereas when the building is finished, no one will ever know whether it took a day or a year to build.

### Race Against Time

To return to our barn, a couple of rainy weekends, a garden waiting to be planted, plus the inescapable fact that Cassandra, the goat we'd bought but hadn't brought home yet, was due to kid in two weeks, made us call a carpenter to help finish our barn. I am not going to take time to describe in detail just how the interior of our barn was finished—you can get a good idea of that from the sketch shown below. If you want to build a small barn, we've had a draftsman work out complete details with a number of variations.

In the years that we've used our barn, we've found little that we've wanted to change. The only addition we are planning is to extend the barn another 10 feet in length to the West; this will give us more storage space which we will need when we begin harvesting our own hay. Of course, we could change the shed-roof to a gable or gambrel roof and store the hay there, but it is just as cheap to extend the length and eliminate hoisting hay into the loft and climbing up to throw it down.



This "breakaway" drawing shows interior of our small barn. We found that this 16 x 30 foot barn efficiently houses 30 hens, 60 broilers, 20 or more rabbits, 4 goats or a cow and calf, 3 or 4 sheep, and a dozen squab. Barn cost \$200 to \$400. Bill of materials, plus complete building plans including 10 large detail drawings of front, ends, interior layout, goat stalls and milking stand, cow stalls, chicken section, squab loft also a turkey sunporch are available.

# The Importance of Raising Part of Your Food

**W**HY do we put so much emphasis on home food production? In the first place, the health of millions of Americans would be far better if every family raised part of the food it eats.

And when we say every family, we really mean every family. No man, no matter who he is, can break the rules of health and escape suffering the consequences. Even the Presidents of the United States, we honestly believe, would be healthier individuals if they tended their own gardens and milked a family cow. Let us explain.

There are two basic reasons for raising part of your own food. First, only by so doing can you be perfectly fed. Secondly, physical contact with the good earth and livestock are the best known antidotes to the mad, hustle and bustle of our present work-a-day world.

There are many lesser reasons for owning your own home and raising part of your own food. There is the basic security of this way of life, an opportunity for the productive use of your spare time, cooperation of the family and the greater enjoyment of family life, the benefits of fresh air, sunshine, outdoor exercise, an opportunity to be creative, the independence and responsibility of land ownership, all in addition to the direct economic benefits.

## 3 Square Meals and Starve!

A doctor friend who read our Plan said, "Ed, you don't make clear in your Plan how important living-in-the-country and raising-your-food is from the health standpoint."

"Well, we meant to—we sure believe that country living can be healthier. . ."

I replied.

"What I mean," he explained, "is the

belief of so many physicians today that too much time is being spent diagnosing illness and patching up the sick without doing much about the cause. We're finding that basically much disease is caused by the food we didn't eat—and because the food we did eat lacked vital elements."

He spoke of how a millionaire in Manhattan could suffer from hunger as much as a share cropper. This hunger he talked about he called a "hidden hunger"—a lack of minerals and vitamins in food. Of course, he went on, we all know how a lack of iron causes anemia, a lack of calcium causes rickets, goiter is caused by insufficient iodine, night blindness by insufficient Vitamin A, tooth decay by a lack of fluorine, calcium and phosphorus. The thing, he said, doctors now worried about was how many more diseases of civilization were caused by year-in-year-out deficiencies in the food we eat. The unfortunate aspect of all this is the fact that vitamin and mineral deficient spinach looks about the same as spinach right out of a good garden!

## Are You Growing Old Too Fast?

My doctor friend stimulated our interest. He opened our eyes to the vast amount of evidence appearing day-by-day on the subject of being healthy by eating properly.

For example, Army doctors found in their young patients symptoms that looked like those of old age. In the early New Guinea campaign young soldiers suffered from dejected appetites, physical and mental fatigue, reduced resistance to infection. Analyses of tinned food showed only slight deficiencies, but when supply ships came with fresh vegetables, fruit and meat,

these minor symptoms of old age disappeared.

And what about the major degenerative diseases of old age? Of middle age, rather—high blood pressure, hardening of the arteries, wearing out the heart, the kidneys, the brain?

Dr. N. Philip Norman, in a Friends of the Land Food Conference in Ohio, pointed out the harm that has been done and is being done to the health of our people by commercial food processing and by our food habits.

He told how all this stuff about vitamin pills had grown as a parasite on the nutrition-for-war-and-defense program—from a little over a million dollars in advertising to two hundred fifty million dollars a year in just four years shows what modern advertising can do with part of the truth. How much good has been done by this? Dr. Norman believes that had we eaten whole-grain cereals in our bread and breakfast food, unprocessed, untouched by the kiln drying, unexploded and not devitalized grain, forage fresh from the vine, tree, and garden—and if we had eaten the meat of animals that had been fed on whole cereals, forage rich with nutrients, especially the internal organs of these animals, and if we had drunk plenty of milk that has been not too badly abused, we would avoid most of these degenerative diseases. There is much evidence to back up Dr. Norman.

## 3 Ways Food Goes Wrong

Evidence is beginning to appear showing that soil and freshness all effect the mineral and vitamin content of the food we eat. Carrots raised in a mineral-rich soil are more healthful than those raised in poor soil. Hot-house tomatoes, the kind you buy in the store, have but half the Vitamin C content of tomatoes fresh from the garden. Steam-table restaurant fare has a fraction of the value of properly home-cooked foods.

Many of the so-called "fresh" vegetables you buy in the store haven't nearly the value of these same foods out of your garden. Out at Ohio State experiments show that about 43% of the "fresh" vegetables sold in stores have lost the biggest part of their vitamin content. Oranges and grapefruit lose around 30% of their Vitamin C 30 days after picking I've heard.

Now, if you will get yourself a productive home in the country, if you will take a real interest in the fertility of your soil, if you eat plenty of your own home-raised fresh vegetables and fruits, your own fresh eggs, fresh meat, use honey instead of sugar, drink lots of raw whole milk and eat whole grain bread, all the evidence says you and your family will be far healthier and live longer, more active lives as well!

## Protective Foods You Should Eat Daily

FOODS	BABY 1 YR.	CHILDREN			ADULTS
		Preschool	Early School	Adolescent	
MILK, whole	1 qt	1 qt	1 qt	½ qt	½-1 qt
VEGETABLES and FRUITS					
Green, leafy, or yellow	¾ Tb	½-¾ c	¾-1 c	1 c	1 c
Tomatoes*	6-7 Tb	¾ c	¾ c	1 c	¾ c
Other vegetables	¾ Tb	½-¾ c	1-1½ c	1½-2 c	1½-2 c
Other fruits	¾ Tb	½-¾ c	¾-1 c	1-1½ c	1-1½ c
MEATS	½ Tb	1 small serving	1 serving	2 servings	1 large serving
EGGS	1	1	1	1	1

\*Half as much orange as tomato. Tb = tablespoon; c = cup.

MILK, VEGETABLES (particularly FRESH green leafy ones), MEAT, EGGS and FRUIT are called the "protective" foods because they safeguard the body from a variety of diseases.

These foods are needed at all ages—not only by children and adults, but elderly people.

If you raise them on your homestead, you can eat them generously. Most of us need more calories—potatoes, wholegrain bread and cereals, butter, sorghum, and dried beans are good suppliers of calories. Eat sparingly of sugar and other refined foods!

# A Good Garden With a Lot Less Work

**E**VEN before the victory garden boom there were so many books, articles, pamphlets on gardening that garden writers seemed to be having quite a time of it trying to be original. For example, I have in front of me a cute article in one of the "garden and home" magazines explaining how you can have cucumbers climb a fence, use carrots for borders, and make a tepee for the children by planting pole beans.

Well, maybe garden articles like that appeal to some folks, but what we wanted at our place was somebody to tell us how to raise a lot of vegetables with as little work as possible.

We weren't interested in gardening as a hobby. We wanted to make it pay and believed we could. We knew that out of every dollar's worth of vegetables my wife bought at the store 60 cents went for marketing and handling.

Our first garden was small—about 30 by 40 feet. We simply dug up the ground, mixed in a little all-purpose commercial fertilizer, bought some seeds at "the corner drug store"—and, needless to say, our garden was pretty much of a flop. Some vegetables grew fairly well, but most didn't. And the insects got more out of it than we did.

We were discouraged. Like many city people we thought a garden was "duck soup". But we've found out that

our garden is our most exacting and complex project. Producing eggs, or chickens, or milk, or honey, or pork requires less knowledge than having a good garden. The one especially attractive point about a garden is that even though it is complicated and considerable work, it does not have to be tended every day or twice a day as do livestock. At any rate I wanted to say, don't let your gardening difficulties discourage you from considering livestock projects—it's easier to produce a dozen eggs than a bunch of carrots.

Before we planted our second garden we made up our minds to find out how to do it. I guess maybe we studied a hundred books and pamphlets. Or rather, after reading the first dozen, we skimmed through the rest. We found ourselves reading and rereading the same basic facts.

After our reading, we went ahead with a much larger garden. We planted according to plan and beginning in May had all the fresh vegetables we could eat. In addition, we canned and froze about 275 quarts for winter use. According to Carolyn's figures, our garden saved about \$200—that's \$200 over the \$22.50 we spent for plowing, seeds, fertilizer, and spray.

Looking back over our experience, we have singled out certain fundamentals and ideas we would like to pass along because we believe they will be helpful to anyone interested in having a good garden with less work.

First, we are living in an exciting, revolutionary era—not the least important is the revolution that is taking place in agriculture—particularly in soil conservation. Louis Bromfield summarizes it thus: "The American farmer has largely worked against Nature. Our new agriculture will be based on the principle of working with Nature".

Probably you've read reviews of Edward Faulkner's startling book *Plowman's Folly*. If you haven't read it, do by all means. Briefly, from the Homesteader's standpoint, the implications of Faulkner's theory mean that by more natural care of garden soil—the incorporation of humus and manure into the top soil instead of plowing it ten inches underground—phenomenally more productive crops can be grown. Moreover, these healthy crops need less cultivating, watering (and stand up against attack by disease and insects.) In short, better gardens with a lot less work!

Of course, Mr. Faulkner's theories are not entirely proven as yet nor are they entirely new. Many government, state and independent agriculturists have been experimenting along the same lines for a long time. However, his ideas are stimulating and we think you'll profit by reading about them.

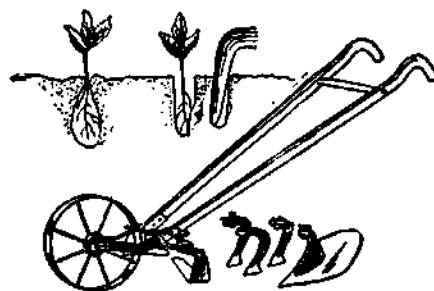
Then, too, the new plant hormones

and insecticides are evidently going to make gardening more scientific.

## SEVEN FUNDAMENTALS

### 1. Get Your Soil in Shape

Almost any soil can be made to produce lavishly. But poor soil takes money and time—perhaps hundreds of dollars and years—to put in first-rate shape. For this reason before you buy a place it's a good plan to have



Plant at upper left improperly set out. Soil should have been pressed tightly about roots. Use dibble as shown. WHEEL HOE and attachments make planting and cultivating a lot easier.

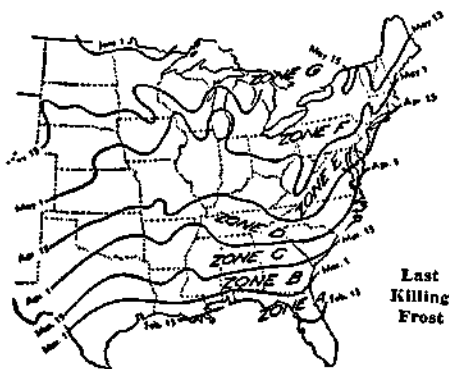
soil analyzed; check for hardpan, excessive sand or clay condition.

Even if your soil looks good—have it analyzed. You may buy a soil test kit—they sell for as little as \$2.00. Or you can send it to your State Agricultural Experiment Station for a free analysis. For the address, ask your local paper or seed store.

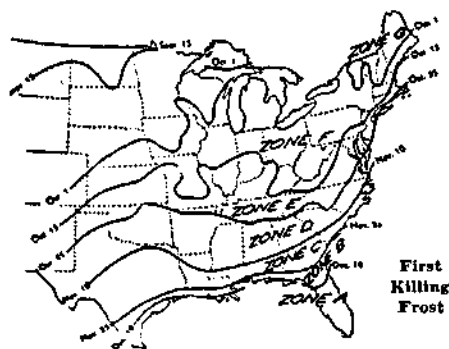
Organic substance is the primary means of building good soil. The best source for this substance is barnyard manure. Goat manure is excellent. So, too, is cow manure. Poultry manure is extremely rich in nitrogen. Barnyard manure is usually difficult to obtain—but you will have plenty if you carry out the well-rounded livestock operation suggested in this Plan.

Barnyard manure increases the ability of the soil to hold moisture, keeps the soil loose and promotes root development. The best way to handle manure so it won't lose its value is to compost it as shown in the accompanying diagram. Ideally each year a plot 30 x 60 feet should receive a ton of stable manure.

In the summer when the garden is planted, manure can be used mixed with straw or bedding, etc., as a mulch. But take care not to let it come in direct contact with plants. Leaves, straw, hay, garbage—anything that will decompose should be dumped onto the compost heap and after ripening worked into the top soil. Don't bury this humus material by too deep plowing. If you are making a garden in sod land and must plow deep—then plow twice—once in the fall, then in the

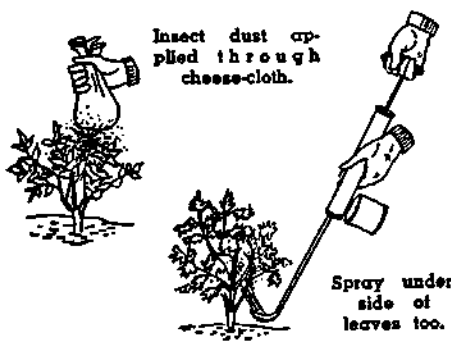


Last Killing Frost



First Killing Frost

Frost dates for western states vary according to elevation as well as latitude. Accurate dates can be had by writing your State College of Agriculture or Weather Bureau.



Insect dust applied through cheese-cloth.

Spray under side of leaves too.

spring plow again and bring your valuable top soil back to the surface.

Your soil test will undoubtedly show a deficiency in one of the three basic fertilizers—nitrogen, phosphoric acid, potash. The relationship of these has been worked out for the requirements of various types of vegetables. You can buy various combinations of these three elements—called commercial fertilizers—and work into your ground as you plant. A small application of commercial fertilizer usually brings a greater percentage gain in your harvests than a large application. Remember, commercial fertilizer is only a supplement to barnyard manure. Your soil test will supply you with directions as to the amount of commercial fertilizer you should use. Oftentimes, only super-phosphate is needed when you use barnyard manure. Incidentally, hardwood ashes contain potash; up to 50 pounds per 30 x 60 plot should be mixed into soil annually.

On richly fertilized land plants grow faster and are superior; incredible as it sounds, production of a given amount of vegetables may then take 1/5 as much land—likewise the time required may be cut to 1/5. Insects, too, find it more difficult to ruin healthy plants grown in rich soil.

## 2. Buy Suitable Varieties of Seeds and Plant According to Specifications

This needs no further explanation. Get seed catalogues in the winter—plan exactly what you want. (See chart on page 24). You can start some seeds, requiring an early start, growing in February or March, either indoors, or in a hot frame. Originally, we found spring so busy with our baby chickens, kids, geese, and young pigs arriving, that we bought tomato, cabbage, peppers, etc., from our local nurseryman as plants. Plants, of course, cost more than seeds. Now we are growing our own plants in our "Harvest Kitchen" greenhouse window.

Most vegetables require warm weather to grow. Don't be in too much of a hurry to plant early; once a seedling is stunted it will never attain normal growth.

Mark rows with a string to get them straight. Make a shallow trench—depth according to seeds—with a hoe. Scatter seeds evenly, cover with fine soil, pat down firmly with back of hoe.

When plants are up to a height of 2 or 3 inches, thin according to seed

man's directions. Even if this seems to leave too few in a row—do it, don't crowd plants. Beets, carrots, greens can be grown large enough so plants pulled in thinning can be eaten.

## 3. Cultivate, Weed, Mulch

Cultivate between rows with a hoe or wheelhoe often—after every rain—at least once a week during early growing season. Hand-weed along the row as necessary. Be careful not to cultivate so deep you disturb roots. As soon as plants are large enough we find a mulch of bedding from the barn laid between the rows keeps down weeds and holds moisture. This is a real labor-saver.

## 4. Spray or Dust on Schedule

Garden insects need not cause undue damage if you are ready for them with an insecticide and your garden sprays. Walk through the garden daily to inspect for insects. Read up on insects before they hit you.

One of the most discouraging things to the novice reading about garden insects is their great variety. But classi-



Mexican Bean Beetle



Green Cabbage Worm and Looper



Aphids



Flea Beetle and Injured Leaf

fied according to method of control, the whole question of what to do about garden pests becomes simple.

By far the greatest majority of insects and fungus diseases fall into four classifications according to their method of control:

**Type 1. Sucking insects**, such as aphids (plant lice), thrip, leaf hopper, and scale. This class of insects feeds by inserting their sharp slender beaks into the leaf stem or blossom, drawing forth the sap which is the vitality of the plant. Contact insecticides applied to this class of insect enter the body by penetrating the skin or pores, causing death by corrosion of the tissues or suffocation. Thorough spraying giving complete coverage on both upper and lower surfaces of the leaves, important.

**Type 2. Leaf-eating insects**, such as beetles, slugs, worms, caterpillars that eat holes in leaves, are effectively controlled by a stomach poison. Insect eats spray or dust that is on the leaf, the poison becoming effective when mixed with the digestive juices in the stomach.

**Type 3. Certain blight and fungus diseases**, including leaf-spot, rust, mildew, and anthracnose are satisfactorily controlled by a preventive with copper or sulphur the active ingredient. The tiny disease seeds (spores) ever present in the air are prevented from gaining a foothold on vegetation where a copper or sulphur fungicide has previously been applied. Even after fungus has gained a start, spraying with fungicides will retard and, in some cases, eliminate the disease.

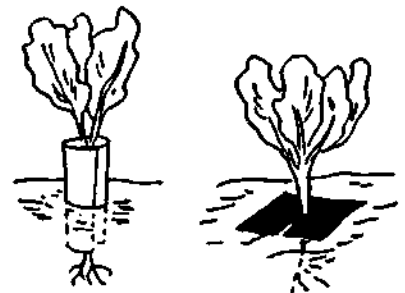
**Type 4. Migratory insects (leaf chewers)** such as grasshoppers, ants, cutworms, sow bugs, also slugs or snails, don't live on plants but crawl along the ground, generally at night, destroying much vegetation. These crawling types of insects can be controlled by the use of poison baits, poison syrups, or under certain conditions, a sticky substance easily applied which will act like fly paper. (See chart page 24).

## 5. Irrigation

Probably more harm than good is done by water applied to home gardens. In arid and semi-arid localities watering is, of course, not only necessary, but a whole subject in itself. However, in most sections of the country, except for occasional droughts, a good rain every ten days is all any garden needs. Light sprinkling is bad. If rain does not come, one of the best and easiest ways to water is a rotary sprinkler attached to end of your garden hose and held in one spot for at least an hour. The ground thus soaked needs no more water for ten days to two weeks of dry weather. Cultivate soil after rain but not until surface dries out.

## 6. Harvest When Tender

Vegetables don't grow evenly from day to day—a warm day following a good rain may push vegetables ahead as much as a number of days not suited to growth. You must inspect the garden every day as vegetables begin to ripen. Pick most on the tender side—they'll taste even better if they're not quite as large as the longer, older, heavy type you are accustomed to buying in the store. Particularly when canning, choose the tender. Never pick ahead of time—wait until just before



Cardboard or stiff paper wrapped around plants protects them from cutworms. Silt tarpaper (about 4 inches square) protects against maggots.



Succession planting

you're going to use them before bringing fresh vegetables from the garden. Try putting the water on to boil before you pick sweet corn—and cook it only 7-8 minutes for one of nature's most tasty feasts!

### 7. Keep Your Ground Planted in Green

As soon as your last vegetables are out of the ground in the fall, roughen up the soil and plant rye. This will get a good start before winter and grow again in early spring. When you are ready to plant in spring, incorporate this green manure into the top surface of the soil by disc harrow, or by fork and hoe. This green manure will decay fast when left in top soil and provide natural plant food for your seeds.

### Hints for Easier Gardening

New land almost always requires lime to alkalyze the acid content resulting from leaf decay, etc. Your soil test will show whether or not your soil is acid or alkaline and tell you specifically how much lime or possibly its opposite, aluminum sulphate it needs.

An easy way to see that plants get proper amounts of lime is to divide the garden into four sections and lime one section heavily for vegetables in the first group, lime second section moderately, etc.

#### These require heavy Liming

(3-5 lbs. on 22 foot row every 3-4 yrs.)

Alfalfa	Cabbage	Lettuce
Asparagus	Carrots	Onions
Barley	Cauliflower	Parsley
Beets	Celery	Wheat
Blue Grass	Clover	

#### These need moderate Liming

(2½-3 lbs. on 22 ft. row every 3-4 yrs.)

Broccoli	Endive	Radish
Chicory	Kale	Raspberries
Corn	Leek	Red Clover
Cucumber	Melons	Rhubarb
Eggplant	Peas	Spinach

#### These need small amount Lime

(1-2 lbs. on 22 foot row every 3-4 yrs.)

Beans	Pepper	Turnip
Cowpeas	Rye	Rutabaga
Gooseberries	Squash	
Oats	Tomato	

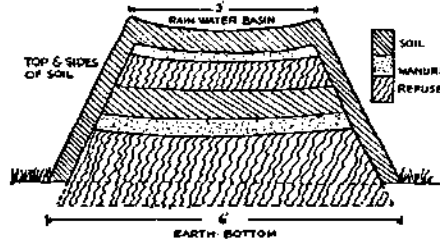
#### No Lime for these— injury will result from Lime

Blueberries	Grapes	Pumpkin
Cranberries	Plums	
Parsnips	Potatoes	

**Natural or Artificial Manure?** There is, as probably many of you know, practically a pitched battle going on

amongst two groups of Agricultural Experts as to whether or not fertility is best kept up by use of artificial (chemical) fertilizers or organic substances. The "organic" group ask, "Are Chemical Fertilizers Ruining our Health?" They believe that only properly composted organic matter and barnyard manure should be used to preserve the soil's fertility. On the other hand, certain advocates of chemical fertilizers advocate "soil-less culture"—or growing vegetables solely in chemical solutions. The extreme in either method is costly. Generally, as far as we can judge, soil-less culture certainly seems a passing fad; and more and more attention seems to be given to methods of keeping the soil fertile by putting back manure and humus.

The poor "backyard gardener" is, however, in a tough spot if he is not willing to keep some animals. Right now, he has a hard enough time to gather leaves, garbage, etc., etc., to make his compost and with the new "electric garbage disposal sinks" which chew up garbage and send it down the drain, he's still harder pressed.



How to make a compost heap

Almost all garden books go into great detail explaining how to build a compost heap—a method of turning waste foods, leaves, inedible garden produce, kitchen parings into humus. Building a compost heap takes a lot of time. First, you choose a shady place for the compost pile. . . build pile in 6 inch layers, keep level, wet it down if necessary every week for 8 to 12 weeks, and then cut through the pile with a sharp spade . . . build it up again, keep watering for 8 to 12 weeks more, then it should be ready to use. . . but it's better after two years. Even then, when you're all done, you have an inferior substitute for barnyard manure. At our place, we don't bother much with a compost heap in the sense that we gather leaves, etc., etc. We feed surplus kitchen parings, vegetable husks, lawn clippings, etc., to the goats, chickens and geese, and in about 24 hours we have excellent manure.

However, to keep manure from losing its value as it will do if exposed to sun and rain, we pile alternate layers of manure and bedding, as shown, and cover with dirt. If this is turned once or twice during a good solid rain it will make excellent humus in six months, winter excepted.

**Stake Tomatoes? Peas?** In the garden books, you'll find all sorts of flossy ways to stake up tomatoes, Commer-

cial growers rarely bother with staking. And at our place we save a lot of effort by cultivating tomatoes only once, then *mulching* with 3 inches of poultry litter. Tomatoes then grow beautifully, don't require weeding, cultivating or watering. A few will rot on the ground, but simply plant a few extra.

**Intercropping?** This is the practice of growing 2, 3, even 4 crops on the same area at one time. Quick maturing crops like radishes, lettuce, beans, spinach may be between rows, or in rows of eggplant, tomatoes, melon, okra, or other crops which utilize ground for a complete season. This is all right where your garden is small—but it's lots easier planting, fertilizing, cultivating, spraying, not to do this.

**All Purpose Sprays.** There are on the market a number of "all purpose" sprays which attack many types of chewing as well as sucking insects. Obviously, these save effort.

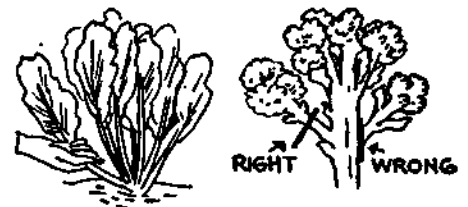
**Perennials.** Asparagus, rhubarb, Jerusalem artichoke and horse-radish may be left in the garden all-year and are practically self-perpetuating.

**Leave Ground Rough.** Some gardeners are forever worrying their soil: trenching, raking, plowing. Faulkner shows that land apparently produces much better when supplied with plenty of humus which is worked into the top of the soil by disc harrow and left rough. In fact, he points out that the ideal is to make your whole garden a sort of compost heap.

**Plant Late.** Usually garden writers say take a chance on losing some seed—plant as early as possible. We find it easier to plant a little late. We don't waste effort and seed this way. Anyway, with our well supplied freezer, plus Jerusalem artichoke, parsnip, and asparagus as early vegetables what do we gain by chancing early planting?

**Transplanting.** Transplant only when you must. Most transplanted plants get a set-back from which they take time to recover and resume growth. And, of course, unnecessary transplanting is wasted effort.

**Easy to Grow Vegetables.** Beans, beets, broccoli, cabbage, Chinese cabbage, carrots, celtuce, chard, corn, endive, kale, lettuce, okra, onions, parsley, parsnips, peas, potatoes, radishes, rhubarb, spinach, squash, tomato, turnips, Jerusalem artichokes.



Harvesting swiss chard and broccoli

# Vegetable Planting Chart

VEGETABLE	Rows apart feet	Plants apart in row, inches	Planting depth, inches	Seed for 50 feet	Days to germination	Days to yield	Buy plants or seeds	Possible yield per 50 feet of row	For a family of five, Summer and Winter Supplies		Common Insect Pests and Suggested Control
									Row Length	No. of Plantings	
<b>Artichoke, Jerusalem</b>	3	20	3	½ peck	8-12	120-140	P	1½ bu.	100	1	Seldom bothered.
<b>Asparagus</b>	2½	20	6	30 plants	8-10	2 yrs.	P	25 bunches of 1 dz. each	100	...	Asparagus beetle. Rotenone.
<b>Parsnip</b>	1½	4	½	1 pkt.	15-20	80-100	S P	150 roots	50	1	Seldom bothered.
<b>Rhubarb</b>	4	48	¼	10 plants	...	2-3 Yrs.	S P	180 stalks	50	...	Seldom bothered.
<b>Beet</b>	1½-2	3-4	¼	½ oz.	7-10	60-75	S S	150 roots	100	3	Seldom bothered.
<b>Chard, Swiss</b>	2	15	¼	½ oz.	7-10	50-60	S S	15 plants	20	1	Blister beetle. Rotenone or hand pick.
<b>Broccoli</b>	2	18	¼	1 pkt.	6-9	70-80	S P	30 heads	50	1	Same as cabbage.
<b>Brussels Sprouts</b>	2	18	¼	1 pkt.	6-9	70-80	S P	30 qts.	30	1	(Green Cabbage Worm. Rotenone.
<b>Cabbage, early</b>	2	12	¼	1 pkt.	6-9	65-75	S P	35 heads	50	1	Aphis. Nicotine dust or spray.
<b>Cabbage, late</b>	2	18	¼	1 pkt.	6-9	80-100	S P	35 heads	50	1	Same as cabbage.
<b>Chinese Cabbage</b>	2	12	¼	1 pkt.	6-9	75-85	S S	50 heads	50	2	Same as cabbage.
<b>Carrot</b>	1½	3	¼	1 pkt.	12-18	60-75	S S	200 roots	100	3	Seldom bothered.
<b>Cauliflower</b>	2	18	¼	1 pkt.	5-10	55-65	S P	35 heads	50	2	Same as cabbage.
<b>Celery</b>	2	4	¼	1 pkt.	15-20	90-120	S S	150 bulbs	25	2	Same as celery.
<b>Celery</b>	2-3	5	¼	1 pkt.	15-20	120-150	S S	120 plants	50	2	Aphis. Nicotine dust or spray. Celery Leaf Flyer-Pyrethrum.
<b>Chicory, Witloof</b>	2	10	¼	1 pkt.	3-12	for winter	S S	60 roots	50	1	Green Caterpillar. Pyrethrum or hand pick.
<b>Callard</b>	2½	24	¼	1 pkt.	6-9	90 & on	S S	25 plants	50	2	Same as cabbage.
<b>Endive</b>	1½	9	¼	1 pkt.	10-14	70-80	S S	60 plants	30	1	Seldom bothered.
<b>Kale</b>	2½	24	¼	1 pkt.	6-9	70-80	S S	25 plants	25	1	Same as cabbage.
<b>Kohlrabi</b>	2	8	¼	1 pkt.	6-9	55-65	S S	70 bulbs	50	2	Same as cabbage.
<b>Leek</b>	1½	6	¼	1 pkt.	7-10	120-150	S S	100 stems	30	1	Onion Thrip. Nicotine sulphate and soap solution or tartar emetic.
<b>Lettuce, leaf</b>	2	12	¼	1 pkt.	6-8	45-50	S S	50 heads	50	1	Cut Worm. Poison bait on ground.
<b>Lettuce, head</b>	2	12	¼	1 pkt.	6-8	50-75	S P	50 heads	50	1	Aphis. Nicotine dust or spray.
<b>Mustard</b>	1	9	¼	1 pkt. or 1 pint sets	5-8	60-75	S S	50 plants	20	2	Birds. Cover with screen or open-meshed cloth.
<b>Onion</b>	1½	3-4	½	1 pkt. or 1 pint sets	7-10	90-110	S or P	150-200 bulbs	50	1	Same as cabbage.
<b>Parsley</b>	1½	4	¼	1 pkt.	15-20	85-100	S S	150 bunches	30	1	Onion Thrip. Nicotine sulphate and soap solution or tartar emetic.
<b>Peas</b>	2-3	1-2	1	½ lb.	7-10	60-80	S S	25-50 quarts	100	3	Seldom bothered.
<b>Potato, white</b>	3	12	4	3 lbs.	8-12	80-120	P	60-80 lbs.	100	2	Aphis. Rotenone, pyrethrum, or nicotine dust or spray.
<b>Radish</b>	1	1-2	½	1 pkt.	3-6	25-60	S S	300-600	25	4	Same as tomato.
<b>Spinach</b>	1½	6	¼	1 pkt.	7-12	40-50	S S	100 plants	50	2	Cabbage Maggot. Avoid by quick root growth.
<b>Turnip</b>	1½	4-6	¼	1 pkt.	5-10	50-80	S S	100-150 roots	50	2	Aphis. Nicotine dust or spray.
<b>Turnip, Rutabaga</b>	2	6	¼	1 pkt.	5-10	80-90	S S	100 roots	50	1	Seldom bothered.
<b>Beans, bush</b>	2-2½	3-4	1½	4 oz.	5-8	50-70	S S	20 qts.	100	4	Mexican Bean Beetle. Rotenone.
<b>Beans, pole</b>	3-4	9, or hills	1½	4 oz.	5-8	65-80	S S	30 qts.	50	4	pyrethrum, or cryolite. Flea beetle, red spiders or corn borer. Apply rotenone dust just before ear forms, then 4 times more 5 days apart.
<b>Corn, early</b>	2½	9	1	1 oz.	5-8	70-80	S S	50 ears	80	1	Corn Ear Worm. Snip off tips of ears after silk dries or apply mineral oil to ear tips.
<b>Corn, main crop</b>	3	12	1	1 oz.	5-8	80-95	S S	50 ears	100	1	Striped Cucumber Beetle. Rotenone.
<b>Cucumber</b>	4	24	¾	1 pkt.	7-10	60-70	S S	150-200 pickles	50	1	Aphis. Nicotine dust or spray.
<b>Pumpkin</b>	8	60	1	¼ oz.	7-12	110-130	S S	25-30 fruits	25	1	Squash Bug. Rotenone or hand pick.
<b>Squash, bush</b>	4	36	1	1 pkt.	7-10	55-65	S S	75-100 fruits	50	1	Same as pumpkin.
<b>Squash, vining</b>	6	60	1	1 pkt.	7-10	65-120	S S	40-80 fruits	25	1	Cut Worm. Paper collar around each plant when set out.
<b>Tomato</b>	3-4	36	½	1 pkt.	7-12	75-90	P	175-200 lbs.	75	2	Green Tomato Worm. Dust with rotenone or hand pick. Aphis. Nicotine dust or spray.
<b>Lima beans, bush</b>	2-2½	3-4	1½	4 oz.	5-8	65-75	S S	15 qts.	100	2	See beans above.
<b>Lima beans, pole</b>	3-4	9, or hills	1½	4 oz.	5-8	80-90	S S	20 qts.	50	1	See beans above.
<b>Egg plant</b>	3	30	½	1 pkt.	12-15	70-85	S P	50-75 fruits	50	1	Colorado Potato Beetle. Arsenate of lead or Paris green.
<b>Muskmelon</b>	5	48	1	1 pkt.	7-12	80-100	S S	75 fruits	50	1	Flea Beetle. Dust with arsenate of lead.
<b>Okra</b>	3	15	1	½ oz.	8-12	50-60	S S	250 pods	50	1	Seldom bothered.
<b>Pepper</b>	2½	24	...	1 pkt.	10-14	65-80	P	200 fruits	50	1	Cut Worm. Paper collar around each one when set out. Aphis. Nicotine dust or spray.

Very hardy. Not injured by winter freezing.

Hardy. Withstand light frost but not freezing. Plant when ground is easily tilled.

Very tender. Plants late, may be injured by cool weather. Don't plant until all danger of late frost is over.

Very tender. Plants late, may be injured by cool weather.



# Herbs



MARJORAM ROSEMARY BALM CHIVES RUE SAGE BURNET BORAGE

**E**D used to be a little sarcastic about my herbs—referring to my herb garden as “the weed patch.” He claimed he couldn’t tell seedlings from weeds.

But since he’s seen to what good use I put my few herbs and how little trouble they are, he has a new appreciation of them. Herbs really fall into the woman’s department. For although herbs offer a fascinating and learned hobby and can be grown as flowers for beauty, for fragrance, for dyes, vinegars, tea and incense-making, the main use on a homestead is in cooking.

Although I’ve heard a number of women say their husbands didn’t like herbs in cooking, I’m inclined to think that this is one of those preconceived notions that men have about food and ought not to be taken too seriously—especially when they say it after a dinner they’ve relished where herbs have perhaps been used without their knowledge in poultry stuffing, soup, tomato cocktail, iced tea, and fruit cup!

I think the reason more of us don’t use herbs regularly is because there is so much mumbo-jumbo mixed up in most herb literature just as there used to be about serving wines. Once people discover, as they have about wine, that you can use any herb you like in cooking, then a lot more of us will use herbs. Of course, certain herbs seem to be “just right” with certain foods.

Any cookbook worth owning, even conservative Fannie Farmer, has something on herb cooking. Usually for the beginner it’s too much to take in all at once. So, unless you’re an accomplished herb-cook, I suggest you start your herb cooking from the angle of what’s easy to grow in a small herb garden.

Herbs take practically no space, and, because most herbs don’t need any complicated soil preparation, you can grow them without even bothering your husband by asking him to prepare the ground. Because you need only about a dozen plants altogether; you can probably plan your herb garden and dig it up yourself. Herbs shouldn’t be planted in a wet place. A good mix for the soil for herbs is equal parts of compost and loam and double parts of sand—all sifted.

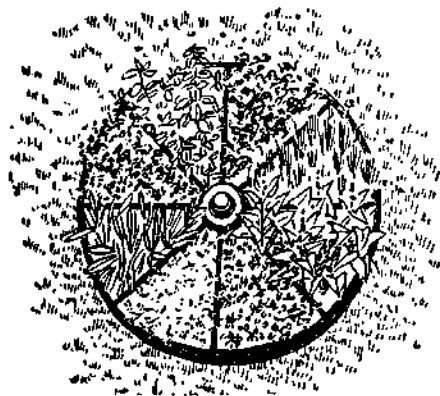
There is little reason for starting herbs indoors. After all, herbs are dried, and when drying is done carefully and the herbs put in screw top jars, they will keep easily from one season to the next. So there’s no special need for an early start.

Herbs are propagated from seed, by cuttings or “layering,” and by root divi-

sion. All annual herbs are best grown from seed . . . many perennials too.

Herbs are best in their own garden. The closer you can locate this to the kitchen the better—when you want a sprig of mint or couple of herbs for a “rainy day stew,” you’ll find you just won’t want to bother getting in the herbs if they’re located too far away.

The wheel garden is made with a heavy wagon wheel. The herbs planted in it should not be too tall growing or the effect of the division by the spokes will be lost. After obtaining a suitable



wheel, select a sunny spot on level ground or a gentle slope. Mark around wheel, then dig out the center for hub—the rim should set on the ground. Fill spaces between herbs with sandy loam. If any of the spaces are to be filled with mints, stick plates of metal—old license plates or sheet iron—around the boundary of the mint to prevent it creeping into adjacent beds. Although you can plant most any herbs in this wheel bed, the lower growing varieties make an especially pleasant pattern: parsley, chives, garden thyme, orange or apple mints, lungwort, dietary of crete, thrift, dead nettle—and such annuals as dwarf basil, sweet marjoram, chervil, summer savory, coriander.

## Some Easy-to-Grow Herbs

**ANISE:** 75 days. Annual. 8 inches. Always grow from seed, don’t transplant. Uses: fresh leaves in salad and as a garnish. Good with fish. Seeds: in bread, cake, stew, soups, candy. Medicinal: tea.

**BASIL:** Sweet: 85 days. Annual 1 to 1½ feet. Germinates easily in 4 or 5 days—if tops are pinched off plants will bush. Spacing: 15 inches for regular—6 inches dwarf varieties. In harvesting, when buds appear use both leaves and buds, cut part way to ground for a second crop. Uses: in soups, meat, some salads. Tie in bunches, dry in sun, store.

**BORAGE:** 80 days. Annual (self-sowing).

1½ feet. Blue flowers attract bees. Should not be transplanted. Uses: tender leaves are used in salads and to flavor lemonade and other cool drinks, cooked, in pickles. Flower is candied for confection.

**CARAWAY:** 70 days. 1½ to 2 feet. Biennial seed; planted one year for harvest the next. Plants to stand 8 inches apart. Cultivate first year. When seed clusters ripen second year, snip plants a foot above ground, dry on old cloth a few days, then thresh seeds by slapping with a small stick. Blow off chaff and store in a tight jar. Early ripening seeds may be planted to give a crop the next year. Uses: in breads, cakes, candies—cabbage, soup and salads, in sauerkraut, goulash, baked apple.

**CHIVES:** Perennial. 6 inches. Seeds germinate slowly. Clumps may be divided in Spring. Uses: leaves give mild, onion-like flavor to soft cheese, vegetable cocktail, soup. Bulbs are chopped and added to sausage to give delicate onion flavor.

**CORIANDER:** 75 days. Annual 1 to 2 feet. Hardy, slow germination, but easy-culture. Can be grown with caraway. Plants should be thinned to stand 6 to 8 inches. Odor and flavor of growing foliage is unpleasant. As soon as seed tops are ripe, they’re cut off (heavy seeds easily fall to ground if this isn’t done), spread to dry, threshed, and stored in tight glass containers. Uses: in bread, cookies, baked apple, stuffing, sausage.

**DILL:** 70 days. Annual. 2 to 2½ feet. Easy germination and self-sowing. 10 inches between plants. Don’t transplant. Stake. Uses: for flavoring pickles; also in soups, stews, cream sauce, potato salad.

**FENNEL:** 60 days. Annual. 1 to 2 feet. Sow in moderately rich soil. Don’t transplant. 8 inches between plants. Uses: Stalks can be eaten like celery. Nutmeg-like seeds used on bread, cakes, sauces, in wine.

**MINT:** Perennial. 2 feet. Spearmint is ordinary garden variety. Best grown from a few plants. Spreads rapidly in medium rich soil. Uses: in lamb and fish sauces, iced-beverages, fruit cup, in currant and mint jelly, in French dressing for salads. Orange and apple mint not as strong as spearmint.

**SAGE:** 75 days. Perennial. 1 to 2 feet. 8 inch spacing. Plant seeds; choose “Garden” variety. Uses: as sage tea, in poultry dressing, sausage, soft cheese. Leaves can be smoked as tobacco.

**SUMMER SAVORY:** 60 days. Annual 1 foot. Seed germinates easily. Spacing 6 inches. Uses: for flavoring gravies, salads, dressings, stews, scrambled eggs and sausage.

**SWEET MARJORAM:** 70 days. Annual. Slow germination. Spacing 10 inches (requires shade until well started). Many uses either fresh or dried: in sausage, meat pies, roast lamb, cheese and egg dishes, peas, beans, and tomatoes, in vegetable cocktails.

**THYME:** 85 days. Perennial. 6 to 12 inches. Plant seeds—thin to about 4 inches. Plants may be divided and reset second Spring. When in full bloom, cut, dry, powder by rubbing and store in glass. Uses: green or dried in soups, stews, sausage, gravies, stuffings, with pork, veal, chipped beef, and especially good on lamb or chevon and chicken.

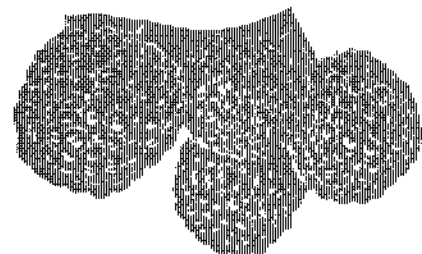


HYSSOP ANISE MINT CHERVIL THYME TARRAGON PEPPERMINT SPEARMINT CHAMOMILE CATNIP LAVENDER COTTON SUMMER SAVORY SAFFLOWER

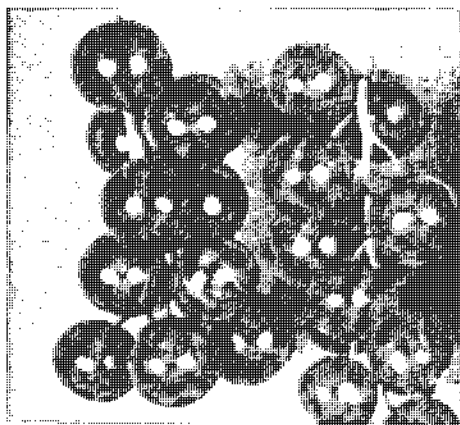
# The Kind of Berries and Grapes Money Can't Buy...



**Strawberries**



**Black Raspberries**



**Currants**

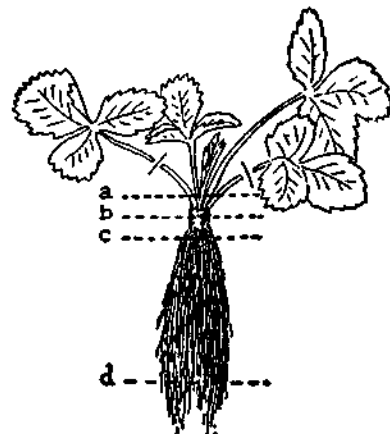


**Gooseberries**

**B**ERRIES and grapes are one of the best investments you can make. Here it is early December and this morning for breakfast we had some of our own delicious raspberries and cream. When some friends came to dinner a few days ago we had strawberry shortcake made with our own strawberries. Soon we hope to have currant jelly and our own grapes and lots of delicious fruit juices—perhaps some home-made wine.

Even the smallest place can provide an abundance of mouth-watering small fruits and berries with only a few hours work a year. Home-grown fruits, especially blackberries, gooseberries and currants (all of which are almost too fragile to be handled commercially) offer a family delicacies they'd never otherwise have. Few people, according to government studies, get enough of the so-called "protective" fruits rich in vitamins needed for good health. And most city people never have the chance to indulge in all the fun of growing these fruits on a place of their own.

You can plan your garden so you'll have a succession of fresh fruits ripening from June to October. And all winter you can eat berries you've canned or frozen. Strawberries, raspberries, currants, and grapes are the best known favorites. If you prefer something a little different, you can choose gooseberries, dewberries, or mulberries. (Edible mulberries are delicious fresh, canned or for wine. They grow on a bushy tree.) If space is limited, the bushes make fine hedges and shrubbery. Probably nothing you do will give you more for less cost. By all means choose the better varieties that are too tender and delicate to be found in prime condition in the store. Your local nurseryman can advise you on this and supply plants best adapted to your climate. Before you decide on your planting of grapes and berries, you should learn when each has to be sprayed, pruned and mulched and figure out a schedule for doing this. It's worthwhile to read up on this. Meanwhile, here are some things we learned about growing these fruits that may help you.



Strawberry plant showing trimming and depths of planting: (a) planted too deep. (b) planted correct depth. (c) not deep enough. (d) pruning of roots.

## Strawberries

There's a big difference between strawberries you buy in the stores and those you pick sweet and fully ripe on your own place. Growing them is not difficult. You have a choice of planting them in hills, in matted rows or in spaced-rows. We used the spaced-row system and we think it's easier because it requires less pruning and makes weeding and picking the berries simpler. We planted 100 plants in the Spring and got 55 quarts the next year. Plants usually bear for two or three years, after which they need replacing.

## Raspberries

We like raspberries so much we planted 100 bushes—cost \$8.00. This planting should bear for at least 7 years. Perhaps we made a mistake when we chose the *Latham* for our garden because this is really a commercial berry, but it is hardy and we did get wonderful berries. We also planted some *Indian Summer* because this is an everbearing type which means you get berries in the early Summer and another crop in the Fall. The raspberries planted in the Spring gave berries the following year. We learned

### Small Fruit Planting Table

	Distance between rows (feet)	Distance between plants (feet)	Estimated Yield per plant	Age of Bearing (in years)
Raspberries	6-8	2-3	1 quart	2
Strawberries	3½	2	¾ pint	2
Blackberries	6-8	2-3	1¼ quart	2
Dewberries	6	6	1 quart	2
Gooseberries	8	3	2¼ quarts	3
Currants	8	3	2 quarts	3
Grapes	8	8	6 pounds	3-4
Blueberries	5'	5'	5-6 pounds	1-2

you shouldn't mulch raspberries with poultry litter in the Spring because it makes the shoots grow too fast. When this happens too many become "Winter killed." Raspberries are pruned early in the Spring, and sprayed 3 or 4 times. Any diseased canes should be removed immediately after crop is over. And that's all we've had to do to get 75 or more quarts of raspberries a year!

### Currants

You can't beat currants for jelly. They are hardy, easy to grow. A half-dozen bushes are well worth considering. Some states ban currants and gooseberries because certain varieties supposedly carry white pine blister rust, a disease that destroys white pine trees. Cool moist climates are ideal for currants.

### Gooseberries

I hope some of you people who are already living in a "Have-More" home-stead will want to try gooseberries. They make good pies, tarts and jams and the fresh ripe fruit makes a delicious dessert. Even in Canada they can be grown; in cool, moist climates they flourish. (In England they grow so well that the berries are often as large as eggs!) Experts say this fruit has been pretty much neglected in this country—it ought to make an interesting experiment.

### Grapes

We planted 10 vines—4 Concord, old-standard, for jelly and jam . . . 2 Caco, a red grape ripening in early September . . . 2 Niagara, white grape which ripens in mid season . . . and 2 Portland, another white grape, which ripens early. Grapes really don't bear heavily until the fourth season, so we haven't actually had any from our vines as yet. All 10 grape vines cost only \$5.00.

### Blueberries

Blueberries are rather expensive—\$1.00 per plant, we paid. But four to six are supposed to be enough for an average family. One interesting thing about blueberries—they often fruit the first year and will keep bearing for fifty years. Unhappily, out of our six bushes we lost four last year—the goats ate one and a bulldozer we had ripping

out stumps in our back yard chewed three more.

### Blackberries

This fruit makes wonderful jam and jelly. We put in about 15 bushes as a hedge. Blackberries have a reputation for being sour. This is because often times the berries you buy are picked as soon as they turn black—actually they are best when left on the bush until dead ripe. As in the case of other berries, it is important to mulch blackberries. The best time to do this seems to be directly after the berries have been picked. Blackberries don't need commercial fertilizer, but the soil should be kept moist and provided with humus. Thus the mulch.

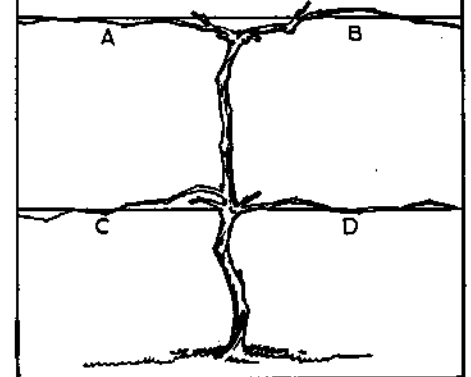
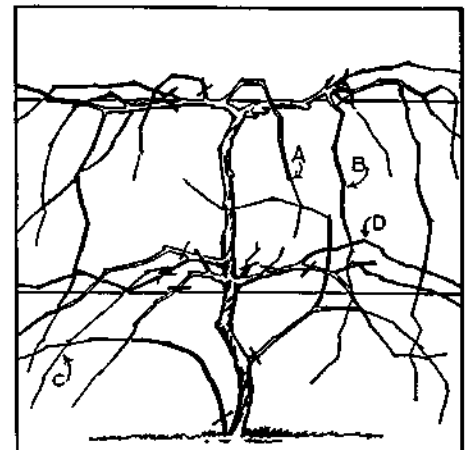
### Dewberries

This is really a blackberry. It is often called "creeping blackberry," the main difference being that it grows on a vine instead of a bramble. The dewberry is sensitive to frost and will not bear good yields unless you plant several varieties to insure cross pollination.

### Home Wine-Making

Although the wines we've tried to make have been pretty terrible so far, there's no reason you can't make excellent wines at home. In fact Fortune Magazine says 30 million gallons of wine are made in American homes every year.

Our mistake was in trying to make wine on the basis of "heresy" instead of getting good, clear, authoritative information. If you'd like to make wine from grapes, the main point is to get the right grapes. This isn't difficult because every state produces wine grapes. (See Farmers' Bulletin No. 1689). Or you can make delicious "wines" from blackberries, raspberries, elderberries, currants, gooseberries, dandelions, rhubarb, almonds, apples, apricots, barley, cherries, pears, oranges, pea pods, potatoes, tomatoes, rice—recipes for all of these and many more are in "Home-Made Wine Secrets".



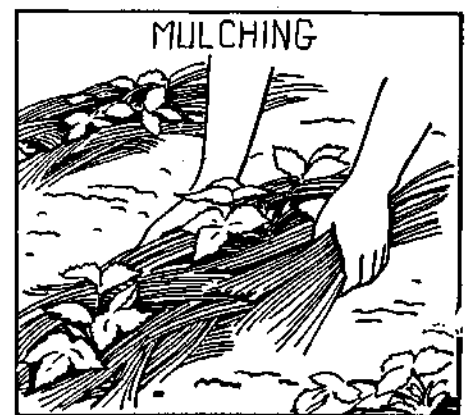
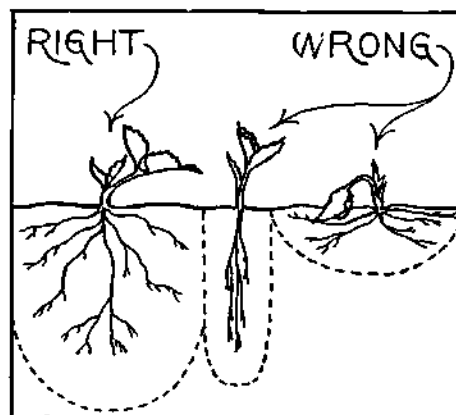
**PRUNING—THE SECRET OF SUCCESS:** Pruning can become a complicated subject. The main point is that all grapes are borne on branches (called canes) developed from previous year's growth. A little study of grape care and pruning pays high dividends.



(Above) After a raspberry cane has borne fruit it should be cut near the ground. Pruning is simple if you learn what to prune and when.

(Below) If strawberries are mulched as shown less cultivating is needed and you obtain better fruit.

In the Spring red raspberry canes should be cut back to a height of 4 to 5 feet as shown by dotted line. Remove weak canes completely. Leave 3 or 6 canes per plant.



# Two Ways to Have Tree Fruits on a Small Place

**I**f the Ed Robinsons of five years ago could have talked with the Ed Robinsons of today about home orchards, the Ed Robinsons of five years ago would have been saved a lot of trouble. Now perhaps we can save you that trouble!

Soon after we first moved to our place we became excited about dwarf fruit trees—pigmy trees that produce delicious, normal size fruit in only 2 or 3 years. But when we went to order some our local nurseryman didn't have the right kind of dwarfs and he advised us to buy standard trees instead.

"But we haven't enough space in our back lot for many big trees," we protested.

"Then why don't you plant your orchard in front of the house?" he suggested.

"Well, we planned to landscape the front with pretty trees."

"Haven't you ever seen an apple tree in blossom?" he asked. Of course we had—so we planted our 18 fruit trees around the house and front lawn. We landscaped with fruit trees instead of shade trees. (Later we discovered that the back of our acre was too swampy for fruit trees anyway. If the roots of young trees stand in water they don't do well.) So we've never regretted our decision to plant fruit trees in front of the house.

We feel that the very first thing people should do when they buy a piece of land—even before the house is built, when possible—is plant a small orchard. The sooner planted, the sooner you will get fruit. The length of time you have to wait before your fruit trees bear seems to discourage a lot of people. But even if you should move before your fruit trees do bear, they'll increase the value of your place many times beyond their cost.

As for the care of fruit trees, our

nurseryman gave us a lecture before he would take our order. He said, "Now remember, you can't simply plant fruit trees and forget about them. You have to spray them—just as you do garden plants—and prune them once a year in addition." It wasn't until after we assured him we would do this, that he would take our order.

More likely than not your own local nurseryman will take a real interest in your fruit growing project. It is a good idea to buy from him rather than a far away nursery selling by mail because not only will you get some good advice from your local nurseryman from time to time, but he knows which varieties do best in your particular locality. Many local nurserymen today buy their young stock from famous nurseries all over the country, so if you want something special he'll get it for you.

We had a lot of fun considering what and how many trees to plant. Before we decided which variety of apples, we visited a commercial apple orchard, bought four or five varieties, tasted them and cooked them.

We learned that commercial growers give the appearance of an apple—or any fruit—undue importance. With them looks seem to rate as high as taste. Probably because appearance sells the apple at the fruit stand. Obviously, the first thing we were interested in was taste . . . next came keeping qualities . . . looks was last on our list.

In selecting the varieties we kept in mind the fact that certain apples ripen in July, others in August, September and October. By planting five apple trees, we would have apples summer and fall—and also a late apple which would keep over the winter.

After considerable reading and a lot of talks with our local nurseryman, the following is a list of the standard fruit

trees we believe sufficient to furnish a large family with enough produce for eating, canning and storage: 3 apple; 4 peach; 3 pear; 2 sour cherry; 1 sweet cherry; 2 plum. In Southern latitudes you can have citrus, apricot, nectarines, fig. Be sure not to plant your young trees too close to the house or to other trees. (See chart.)

The following table will give you an idea about yields and age of bearing:

Kind	Yield, When Full		Age When You May Get Fruit*
	Bushels	per plant	
Apple	6		6-8
Pear	1		5-7
Peach	1		3
Plum	1		4-5
Cherry (sour)	1		4
Cherry (sweet)	1		6-7
Quince	1/2		5-6

\*Based on planting 1 or 2 year-old standard trees—older trees usually don't fruit any sooner.

Even though all the fruit catalogues tell you that you can plant in either spring or fall, spring is preferred in most sections. Planting should be done as early as the ground can be worked and before growth has started in the plants. Don't use fertilizer when planting. Use fine earth and tramp earth solidly about the roots with your feet, shovel by shovel. Set trees about an inch deeper than they were in the nursery.

Keep a three foot circle cultivated around the tree trunk. In the fall mulch them with poultry house litter. From the second year on, cultivate regularly and fertilize at end of June by using a barnyard manure mulch. This serves to keep in moisture during hot dry spells in July and August and provides additional food. You will be surprised at how much faster this will bring your trees to bearing.

Some state agriculture departments will send you postcards throughout the year telling you with what and when to spray your fruit trees. Needless to say, this is an invaluable service and you should get your name on your state's list of fruit growers so you can more easily take care of spraying. Ask your County Agricultural Agent about this service.

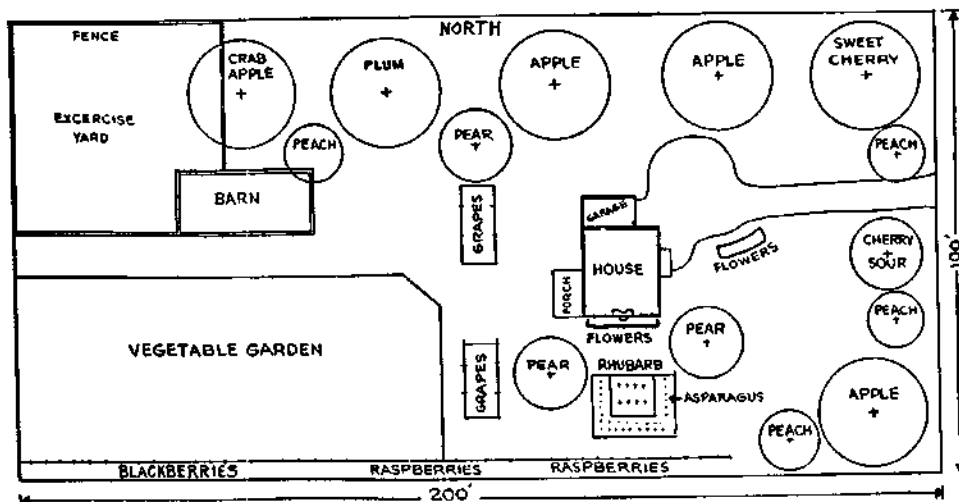
## Dwarf Fruit Trees

Now, after many years of experimental work really good dwarf fruit trees are available. The two exciting things about dwarf fruit trees is that they take very little space and they bear fruit a year or two after you plant them whereas with standard trees you have to wait four to eight years!

Take a look at the comparison chart on the next page. It will help you decide which type of trees to plant.

Dwarf trees have many advantages, and a few disadvantages, when a detailed comparison is made with standard trees. Let's look at the advantages:

*Dwarf trees take less space. In the*



FRUIT FOR FAMILY OF FOUR  
SCALE 1"=40'

Here is one plan for less than a half-acre homestead showing how you can attractively landscape your grounds with fruit trees. Note that tall trees are generally planted on North boundary. In this plan trees are planted as close as is practical and size (spread) at maturity indicated—scale 1" equals 40'.

space required by 4 standard apple trees, 80 x 80 feet, you can plant as many as 64 dwarf apple trees! Even the ordinary suburban "house and lot" has space for a few dwarfs.

*Dwarf trees are easier to spray or dust.* All fruit trees must be sprayed or dusted. Dwarf trees, particularly the "little" dwarf or "semi-dwarf" can be sprayed or dusted with an efficient garden sprayer or duster. This is most desirable because the expensive, bulky spraying equipment for standard trees is not needed. Spraying is much easier, and consequently it gets done.

*Dwarf trees bear fruit sooner.* A "standard" apple tree usually does not produce fruit for 5-10 years after it has been planted. A dwarf tree will often bear fruit in two years!

*Dwarf trees are easier to prune.* Obviously a tree 5 to 10 feet tall is much easier to prune than a tree 25 to 30 feet tall.

*Dwarf trees grow large fruit.* Fruit buds, like turnips for instance, need to be thinned if the biggest fruit is to be grown. Dwarf trees, where the tiny fruit can be thinned easily, often produce bigger fruit.

*Dwarf trees make possible more variety.* Naturally if you can plant 10 to 15 dwarfs in the space required by a single standard tree, you can have 10 or more various kinds or varieties of fruit, instead of one. This has another advantage: you can have early, mid-season and late fruit by selecting varieties that ripen at different times.

*Dwarf trees are easier to harvest.* Fruit from the smaller dwarfs may be picked from the ground without the bother and danger of climbing a ladder.

*Dwarf trees mean less damaged fruit.* Fruit dropping from the small dwarfs, particularly when the ground under the trees is mulched with straw, hay or sawdust, is often undamaged.

*Dwarf trees produce top-quality fruit.* Fruit produced on a dwarf tree not only tastes as good as fruit from a standard tree, but because it is easier to give dwarfs better care, the fruit often surpasses that from large, and particularly old commercial trees.

As for the disadvantages, here are several you should know about:

*Dwarf trees are more expensive.* Of course prices vary in different localities, but a New York State nurseryman lists

2 year dwarfs at \$3.50 and his standard trees at \$1.75. When the supply catches up with the demand, this difference won't be as great.

*Dwarf trees are shorter lived.* However, this is not too serious a drawback. A dwarf apple tree will bear for 25 to 30 years compared to say 40 years for a standard tree.

The fruit you get from dwarf trees is full-sized. All standard varieties of fruit are available on dwarf trees; that is you can buy dwarf McIntosh, Baldwin, Northern Spy apples . . . Bartlett, Clapp's Favorite, Duchess, Seckel pears . . . Elberta, Hale-Haven peaches, and so on.

The fact that dwarf trees are easier to care for doesn't mean you can grow them without knowing a few of their peculiarities, however. Certain things about dwarf management are different. They must be planted correctly or they may grow into large trees. Pruning and thinning, though more simplified, is different. You'll find it really fascinating to read up on dwarf trees—also this will insure you against buying the older kind of dwarfs which nurseries used to carry and which weren't always reliable. We recommend you seriously consider planting dwarf apple, pear and possibly sweet cherry trees as these three have been developed the most successfully. Dwarf fruit trees, one of the biggest horticultural advances in years, mean a lot for the small place.

### \$50 From a Single Nut Tree!

One day Carolyn and I received this letter:

Dear Ed & Carolyn:

"Here in Georgia a great many pecans are raised commercially and many farmers have a side line grove of the nuts which add considerably to their income. The trees make beautiful ornaments as shade trees besides the crop they bear. One suburban home I know of has two trees that brought in a total of \$84 cash this year. Another single tree I know of bore over \$50 worth of nuts."

Sgt. Herbert P. Keene

This was only one of the letters friends have written us to say that we should include mention of nut trees in our "Have-More" Plan. They pointed out that nut trees are unbelievably



The little girl is four years old—but the dwarf fruit tree has been planted only two years. And just look at the apples!

easy-to-grow, make beautiful shade trees, require less spraying and pruning than fruit trees, and supply the table with a nutritious, easy-to-keep food.

Well, I will say truthfully that about all that I know about nut trees is what I've read about them. We do have on our place one big, old butternut tree that has born huge crops; the nuts have a heavy husk and thick shell, but are mild and good-tasting after you get them cracked.

But Carroll D. Bush, in the *Nut Grower's Handbook* points out that here in America in the past thirty years, more has been accomplished with nut trees than millions of people in the old world accomplished in centuries. Better varieties of both European-Asiatic, and American nuts have been selected and bred for improvement and hardiness.

Today there are nut trees suitable for growing in every state. Of course, nearly everyone is familiar with the great almond and English walnut groves on the Pacific Coast and the pecans in the south. But do you realize the many varieties that have proven successful in the north and eastern states? Here are some of them: Im- great almond and English walnut pecan, hickory, hican (a cross between a hickory and pecan), filbert, almond, Chinese and Japanese chestnuts, heart-nut, and many varieties of hazel nuts.

Although nut growing is by no stretch of the imagination a "get rich quick idea," it does have a definite commercial side. For the homesteader, nut trees do have a good deal to offer.

## Fruit Tree Comparison Chart

	Years After Planting To First Fruiting		Orchard Spacing	
	Standard	Dwarf	Standard	Dwarf
Apple	6-8	2-4	40' x 40'	8' x 10'
Pear	5-7	2	20' x 20'	10' x 10'
Sweet Cherry	6-7	4-5	25' x 25'	12' x 12'
Sour Cherry	4	3	20' x 20'	12' x 12'
Plum (Japanese)	4-5	3	20' x 20'	12' x 12'
Plum (European)	4-5	4	20' x 20'	12' x 12'
Quince	5-6	4	15' x 15'	10' x 10'
Neclarine	3	2	20' x 20'	12' x 12'
Apricot	3	3	20' x 20'	12' x 12'
Peach	3	2	20' x 20'	12' x 12'

# Fresh Eggs From Your Own Hens

**P**ERHAPS this sounds fantastic but we find that it's not much more work producing our own eggs than it is to make a weekly trip to a poultry farm to be sure we actually do have strictly fresh eggs. Our laying flock of 20 R.O.P. New Hampshires requires about 7 minutes care a day—and gives us on the average 11 eggs daily, year around.

Twenty hens require an 8 x 10 foot house which costs new about \$75. But if your family uses only four eggs a day a house for eight hens can be bought or made for as little as \$30.

Eggs were the first project we attempted when we moved out of the city. We estimated how many eggs we'd like to eat. With three in the family we thought we wouldn't need more than two dozen a week—3½ a day.

In estimating year around egg production, figure a hen will lay an egg every other day—if you can use six eggs a day, then plan on having a dozen hens. So, we bought a ready-made poultry house for \$28., 7 pullets for \$11.00; plus a water pan for 50 cents, a feeder, 69 cents.

If you can drive a nail and cut a straight line with a saw, you can build your own poultry house. If you want to, you can buy a "knock-down" poultry house and assemble it. You'll find them advertised in poultry magazines—be sure to write for catalogues and compare prices—they vary quite widely.

For the first week our 7 pullets (young hens beginning to lay for the first time) didn't lay an egg. One evening when I came from work, I found my wife all excited—our flock had produced an egg! That egg, counting the feed we had on hand cost us \$45.89.

But during the next eight fall and winter months those 7 hens laid 646 eggs—nearly 54 dozen—6½ dozen a month.

During that time we spent \$14.30 on feed—an average of 26 cents per dozen eggs. In our locality eggs sold for 60 cents a dozen. In short, we had saved \$32.40 on eggs and at any time could have sold our hens as fowl for 25 cents a pound or \$11.20.

But with our eggs only costing us 26 cents a dozen instead of 60, we began using more. That's why we have increased our flock. The next spring we raised 25 of the finest R.O.P. (Record of Performance) New Hampshire pullets (cost: 50 cents apiece as day old chicks), culled them down to 20, and began getting more eggs than we could use. With these better laying birds our eggs cost only 16-18 cents a dozen for feed costs. We sell the surplus at 60 or 65 cents a dozen—and right where I work I have more customers than we can supply.

## How to Start

When we began studying up on chickens we found that there were many books on how to make a success of poultry commercially, but little information on raising a barnyard flock efficiently. Now, however, there are a number of good books—for example, G. T. Klein's "Starting Right With Poultry."

Many writers tell you any old building is suitable for poultry. But any old building and any old kind of equipment often result in a damp, drafty henhouse—probably ending up with your flock not laying and possibly getting sick.

A separate henhouse, or space in your small all-purpose barn, or a re-

modelled shed which gives 4-5 square feet of floor area per bird is needed. For a dozen hens a house 7' x 8' or thereabouts is satisfactory. The building should face south and permit plenty of sun deep into the building during winter. The house should be well-ventilated, but not drafty. Recent experiments show that it is better to give hens almost no air at all than have them exposed to a draft. Twenty hens give off a gallon of water per day—draft-free ventilation will keep this moisture from being absorbed in litter, doing away with frequent removal of same. With proper draft-free ventilation, you can put litter down in the fall, add more as needed during the winter, fork over weekly, and you should not have to change litter until spring. Then, old litter is used on the garden. But if litter becomes damp, change it right away.

Crushed sugar cane is excellent litter, deep straw or peanut shells are also good—all make good garden mulches. To obtain draft-free ventilation have windows in south only, and have them open in from the top, or hang regular double-window sash that can be regulated top and bottom.

The foundation of the house can be of concrete, which is best, or double-wooden floor with building paper and rat-proof wire between floors.

## Interior

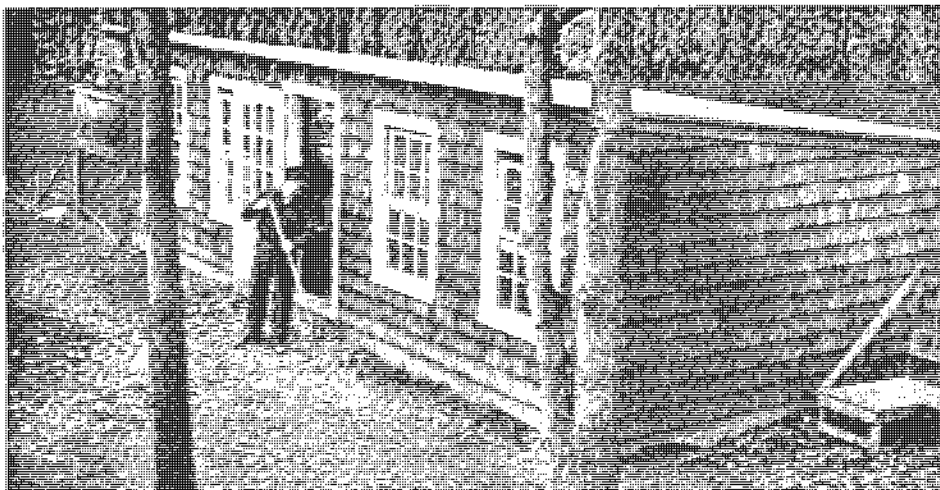
As for the interior of the chicken house, at the rear provide a dropping board 3 to 4 feet off the floor perhaps across the width of the house. Six to eight inches above the dropping board on supports, run a one-inch mesh wire. Provide roosts above wire, a foot apart. Allow 10 inches of roost per bird. The wire between roost and dropping board keeps hens clean and saves the eggs laid from the roost.

Nests—while they can be orange crates set a foot or so off the floor at the side of the house—should have a piece of ordinary corrugated carton cut to cover the bottom, then straw or excelsior for nesting material. The corrugated cardboard saves many an egg from breaking, and if an egg should become broken or the nest become messy cleaning is simply a matter of removing the cardboard. Provide a nest for each 5 hens.

Also buy a good waterer—preferably one that has a kerosene or electric heater to keep water from freezing in winter. Get one large enough—our 20 hens drink about two gallons of water a day.

Your State Agricultural College will send you free building plans for a backyard laying house. You can get plans to build a mash and feed hopper from your local lumber man. But it's practically as

See next page

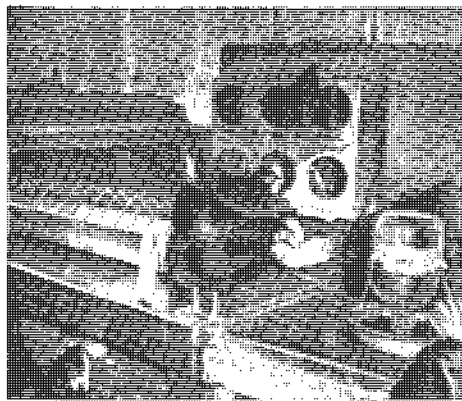


Our small all-purpose barn is 18 x 30 feet. Run at capacity this efficient little building houses up to 30 laying hens and a battery broiler in one section; in the other, 4 milk goats and in two pens up to 6 kids or lambs, plus a six compartment metal rabbit hutch, squab loft, milking stand, also feed and hay.

No-draft ventilation with plenty of sunlight is provided by four windows facing south. A second door at the far end (not visible) opens from the goat dairy section into the fenced pasture. Small hen door on the north side lets hens out into the yard.

Floor is concrete, building is regular frame and sheathing construction with cedar shingles—roof of heavy green mineral surface roofing. Water is piped from the house.

Cost including equipment: materials \$285, labor \$240.



One-third of our barn is a laying pen. Simple and cheap feed and water equipment on a sturdy home-made stand keeps feed and water clean. Also, although it doesn't show up in this snapshot, wire is stretched between roosts and dropping board for sanitation.

cheap to buy a hopper from Sears Roebuck or Montgomery Ward or one of the poultry supply companies. The hopper should be well off the floor with a feeding platform that keeps feed clean and saves waste. Set the hopper and the water in the middle of the floor so that the birds can get the feed easily. (See diagram).

### How to Feed

There are more different theories on feeding hens than feeding babies. Here is a simple, satisfactory way. In one large mash hopper (one foot long for each six hens) place a good egg mash in one half—and in the other scratch feed. Keep plenty of mash and scratch before the hens at all times. At first your hens will eat more scratch than mash, then gradually eat half mash, half scratch, which is what they should be eating for best results. (Hang an automatic feeder for oyster shells and grit from a side-wall).

Buy your feed from a hay and feed dealer with a good reputation. Keep a supply of feed on hand—don't let your feed get too low because feed deliveries are unpredictable. You can keep laying hens inside the poultry house all year around—they will lay as well as hens that have a yard. In winter an electric light with an inexpensive automatic switch which turns it on at 4 a.m. will increase your production—not because you're fooling the hens into thinking it's daylight, but because they can see to eat more egg-producing mash.

Mash means eggs—as they say. So keep your birds eating mash. If they drop off, moisten mash (in winter use hot water) and you'll be surprised how your hens will gobble it up.

### Culling

"Cull" simply means to eliminate birds that seem sick, weak, or non-layers. Time was when characteristics showing good layers were not widely known, but today almost anyone can

cull their flock by checking these characteristics:

### Judging Production

	Laying Hen	Non-Laying Hen
Vent	White, large oblong, moist	Small, round yellow, dry
Comb	Large, red, full, silky	Small, pale, scaly
Pelvic bones	Wide apart, pliable	Close together, rigid
Wattles & Earlobes	Prominent soft	Shrunk rough, dry
Eyes	Prominent sparkling	Listless, sunken, dull

Cull birds after dark. Take out of pen for table use those showing non-laying characteristics. Probably, at first, you won't trust your ability to cull. We were afraid we might "liquidate" a couple of valuable layers—so we kept the "cullers" in a small chicken house for two weeks to see if they were layers. They weren't.

If over 50% appear to be non-layers, probably, the trouble is with you. Exert every effort—feed hot mash, check for lice, mites—for four to six weeks to bring them back into production.

### What Breed?

There is no best breed. All fall into three general classifications: egg machines (Leghorns), meat birds (Jersey Giants), all purpose birds (New Hampshire, Plymouth Rocks, R. I. Reds, Wyandottes.) By all means choose one of the all purpose birds—preferably the one your wife likes the looks of best. She'll be collecting the eggs and keeping an eye on the flock while you're away.

You can raise your own laying hens from chicks, particularly if you buy the battery brooder described in the section on broilers. Buy "straight-run" baby chicks using poultrymen's rule of three chicks for every pullet wanted in the fall. When they are six weeks old take out pullets (they'll be smaller, have less comb development) and raise them on range during warm months. (See page 33). Never put young growing chicks with older chickens or hens.



Almost one-half of daily chore time is taken up by watering stock. Running water in barn is easiest single way to save work.

Secondly, if you don't have a brooder, then buy 6 to 14 week pullets from a good breeder. These will begin laying at 20 to 24 weeks. Here you must be careful to buy from a poultry man

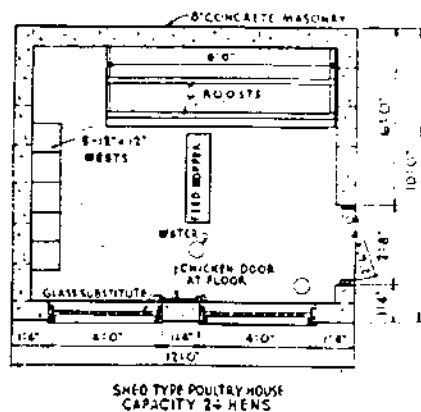


Diagram of interior of a laying house. Feed and water are placed prominently in the middle of pen to get hens to eat often — "the handier the mash . . . the more eggs."

who is in the business of raising pullets to sell. Be wary of buying from a poultry man who is primarily producing eggs—he usually keeps his best pullets, sells his culls. Only buy 6 week old pullet in the spring or summer when there's plenty of grass range for you to raise them into strong birds.

Thirdly, you can buy 20 week old pullets which are about ready to lay. These will cost \$1.50 to \$2.50 apiece. Buy only pullets—birds less than six month old. And remember, you don't need a rooster to produce eggs.

### Prevention of Disease

It has been said that something like 300,000 people go into the poultry business each year to make their fortune—and about 289,000 give up because they couldn't make a go of it commercially. One reason for this bad showing is loss from disease. A backyard poultry raiser should have little trouble on this score if he has disease free birds to begin with and keeps sanitary conditions in the house. We know of any number of people who have been keeping poultry for years without serious loss from disease.

#### Main points to bear in mind:

1. Keep poultry house clean.
2. Avoid drafts.
3. Don't overcrowd birds.
4. Paint roost once a year or oftener with Carbolinum to get rid of mites. Disinfect water and feed equipment—do this monthly anyway.
5. Isolate any sick bird immediately.
6. If any contagious disease occurs, kill affected birds and bury them immediately.
7. Dust with lice powder if birds are lousy.
8. Feed properly, watch for mouldy feed.

# New, Easy Way to Raise Tender Chicken

ONE of the most successful projects we've undertaken is raising chickens to eat—broilers and fryers, in what is called a "broiler battery". This efficient new way of raising eating chickens has become increasingly popular among the large commercial poultrymen during the past few years, but only recently have small broiler batteries been made for family use.

Directly below is a picture of our "home-size" broiler battery. Here is the way it works: In the top deck we place "30 day-old" chicks, dipping their beaks in the water tray (and the mash) as we take them out of the shipping carton. Dipping their beaks once or twice teaches them where to drink and eat. At the rear of the top deck is a heated chamber with a drape at the front. This is the brooder. It's heated automatically by an electric heat-unit. When the brooder drops below a certain temperature, the heat automatically goes on together with a small light. The light attracts the chicks and they duck under the drape into the warm brooder.

As they get hungry they come out to eat and drink from the feed and water trays. Once or twice a day—and it doesn't have to be done at a definite time—we change the water and add feed, a specially prepared battery-broiler mash (be sure to get a vitamin fortified battery feed). The chickens live on wire and are kept sanitary at all times. A few sheets of newspaper spread out in the dropping tray makes

the daily cleaning easy—simply pull out tray and roll up newspaper.

At the end of 4 weeks, the baby chicks are divided into two equal groups—half go into the second deck, half into the lower deck. At the same time, another batch of 30 baby chicks may be added to the top deck.

In another 4 weeks, and each succeeding 4-week period, if you keep your battery running at capacity, you have 30 two-pound broilers.

## Feed Cost — 16¢ a Pound

Even with today's expensive feed, our chicken costs us only 16¢ a pound. What's more, our battery takes less than 10 minutes a day to operate and it is truly "so simple a child can run it". Moreover, you can set it up in the basement, garage or shed—provided that, if you run the brooder during the winter, you have enough heat in any of these places to keep room temperature at 50° or above.

If you want to keep for your own use 15 broilers a month, then the other 15 can be sold to friends. By selling them at market prices you ought to earn enough to pay all your feed costs thereby having all the chicken you can eat at no cost.

The brooder is about 4½ feet high, 3 feet wide, and 3½ feet long. This size is made by a number of companies. They range in price from \$23-\$30. Names and addresses of Manufacturers are given at the end of this chapter.

One of the great things about these batteries is that they eliminate practically all chance of your losing your chicks by disease. At this writing I should say we've put over 800 baby chicks through our brooder. The hatchery from which we order our baby chicks—incidentally, we buy all males (cockerels) for they are cheaper and grow faster—sends us 32 chicks but charges for only 30. We have never lost more than these two extra chicks in any batch we've raised. And that isn't because we've been especially lucky, because four different friends of ours have bought broiler batteries—3 of them didn't know enough to tell a hen from a rooster—and all have done well.

## Mind These A B C's

If you will remember the following points, I'm sure you will have no trouble in raising chicks in a battery:

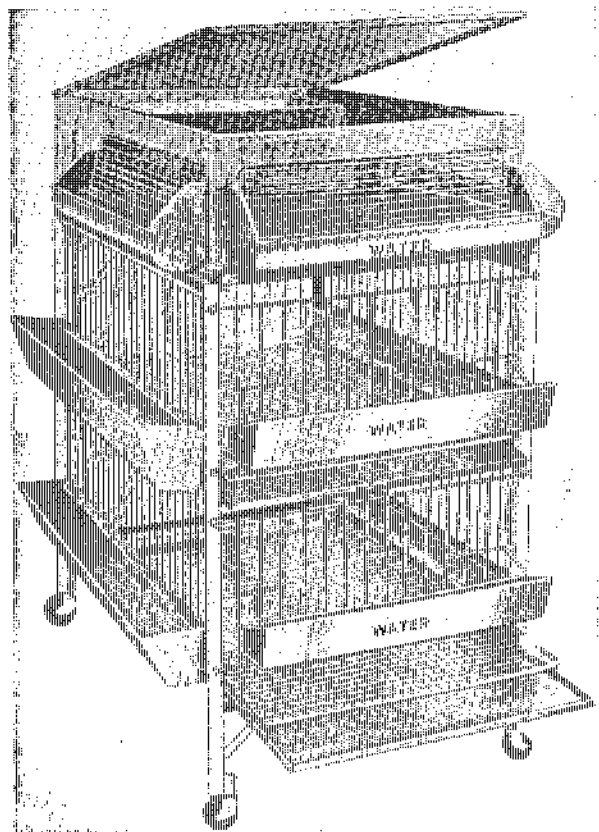
- A) Buy good baby chicks—the best cockerels cost only 7 to 13¢ each, depending on the season. You can run the brooder any time of year. Buy chicks of heavy breeds—Hampshires, R. I. Reds, Barred Rocks, White Wyandottes and White Rocks (easiest to dress), or any of these cross bred. Don't buy Leghorns—they are a poor meat bird.
- B) Make sure your feed dealer supplies you with *broiler-battery feed*. This feed is fortified with minerals and vitamins necessary because your chicks won't get sunshine.
- C) Brooder should be started a day before chicks arrive. The room temperature kept at 65°-75°, if possible. Set your brooder so that a thermometer 1" above wire floor inside registers 85°-90°. Fill water troughs with warm water. Let chicks feed upon arrival—unless they're under 36 hours old. Daily feeding period should be 12 to 14 hours. Temperature in brooder is gradually reduced each week until at end of 4 weeks it is down to 70°.
- D) Wash water pans in hot water every other day—see that chicks always have mash, and water and chick grit.
- E) Let chicks have plenty of fresh air—no drafts and don't let temperature in room drop below 50°.

## A Few Tips on Dressing Chicken

The first chickens we dressed took about an hour a bird—the other day we did seven in about an hour.

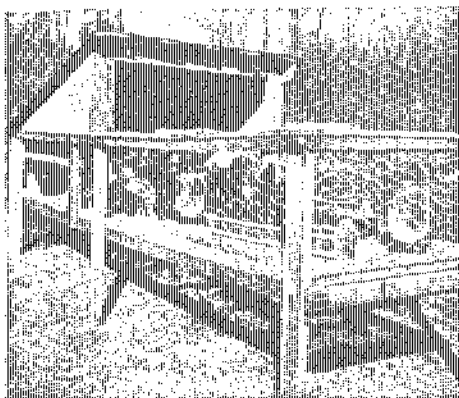
We never particularly liked this phase of our farm activities and have spent a lot of time making it as efficient and simple as possible.

First, instead of using a chopping



A complete chicken raising plant. With this broiler battery in your basement, garage or shed, and with no other equipment, you can raise baby chicks to 2 or 2½ pound broilers in 8 to 10 weeks. Not more than 10 minutes a day care will give you 30 broilers a month at a feed cost of 16 cents a pound or less, depending on feed prices.





This outside sun porch is a convenient place to transfer 8 to 10 week old broilers and raise them to 3 to 7 pound fryers or roasters. Raising in confinement makes for tenderness and rapid weight gains. Sanitary floor is  $\frac{1}{8}$ " wire mesh. Allow one square foot of floor space per bird at 10 weeks — two square feet at 20 weeks.

block and axe or the more expert commercial poultryman's method of sticking through the roof of the mouth, we use a gadget which looks like a miniature guillotine. This extremely humane device makes killing easy, sure and not messy.

Secondly, after dipping the chicken into hot water—not hot enough to burn chicken's skin—for about 30 seconds and plucking the feathers clean, we split the broiler down the back. This makes the intestines easy to remove in a mass. The bird can then be cut completely in half, washed, quartered, and it's done in much less time.

### Tenderest Chicken

Battery broilers, fryers, or even roasters—and we've raised and eaten all three—are more tender than chicken grown on range. The reason for this is



One of the simplest most humane ways to kill poultry. A light blow of the hand and blade, held steady in the slot, punctures spinal cord leaving outlet for blood. Blade springs back, chicken is dropped into barrel.

immediately apparent—broilers raised in confinement do not toughen their muscles as do birds grown on range. Battery broilers and fryers, in fact, are usually so tender that the wholesale buyer of live poultry often will not buy them to dress and market, because battery broilers picked up alive at the farm and trucked even 10 to 20 miles, often lose up to 25% of their weight they are so tender. However, this commercial disadvantage is a distinct plus when you are raising chicken for your own use.

## Home Made Brooder

If you do not have or buy the battery brooder pictured on the opposite page, you can easily set up a simple brooding outfit as shown. (Or you can buy a simple brooder like this at very small expense.) You can vary size of light bulb, get approximately right temperature under brooder—about 90 degrees one inch from floor, reducing gradually to room temperature in about 4 weeks. Then remove brooder.

Floor space required for each bird is about 7 to 10 square inches under brooder and about  $\frac{1}{2}$  square foot outside brooder. Fine meshed wire or tar paper 12" high should be used to confine chicks close to brooder for first week.

Room or building used must be clean, fairly warm (70 degrees desirable—must not be less than 50), well ventilated, preferably with windows facing south for maximum sunlight. Your feed and grain dealer will have litter for floor, inexpensive feeding and watering pamphlets; perhaps free, detailed pamphlets on this phase of poultry raising.

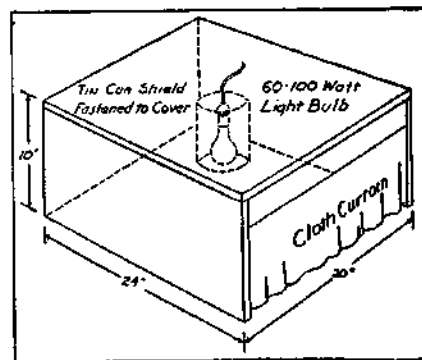
Get your day-old chicks, either from

## Summer Range Shelter

Putting pullets "on range" at 6 to 8 weeks old, with simple, shelter-type housing, as illustrated, is probably the best way to get healthy, sturdy birds. You can also raise broilers, fryers and roasters this way, but we think the battery-confinement method described and illustrated elsewhere on these two pages is preferable. You get better eating chicken in shorter time that way.

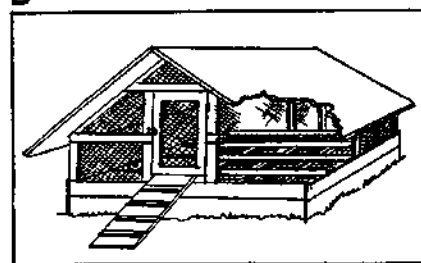
The shelters can be used in the North from May through October. Allowing the correct amount of floor space per bird—one square foot or more—a shelter 6 feet square would be large enough for 20 to 25 birds. (One of the most important things to remember about keeping any kind of livestock is never overcrowd).

Shelter design can be varied, but is based on these elements: a weather-tight roof; a wire mesh floor eight or more inches off the ground; roosts above this (one-by-two strips nailed flat on top of wire are suitable—allow 10" of roost space per bird); boards or wire all around bottom to keep birds



From Washington State College

feed dealer or by mail late in March or April. When six or seven weeks old, along in May (neck and head should be well feathered), birds can be transferred to summer range shelter unless house where started is designed for and has outside yards suitable for their growth to maturity. Cockerels and pullets should be separated at about 8 to 10 weeks of age, depending on the breed—in some breeds they are easier to tell apart than in others.



from droppings under floor; wire around sides from floor to roof to allow good ventilation; a door to shut chickens in at night and to keep rodents out.

Range can be any grassy piece of land, clover being particularly good. Allow 100 square feet per bird—the more range and the better the grass, the less boughten feed the birds will need, and the healthier they will be. Fence in to keep chickens away from garden and to keep dogs out. Covered feed trough and water fountain are placed near shelter and should be moved every week or so to assure clean footing for the birds.

# Geese Grow on Grass

**I**N raising poultry, Ed and I believe chickens are fundamental—they furnish both meat and eggs. But after you are producing broilers in your battery and have a flock of laying hens, you ought to consider raising at least one other kind of poultry for variety's sake.

It is up to you to choose geese, ducks, turkeys, squabs—or something fancy like guinea hens or pheasants. You can easily handle one or maybe two of these in addition to your garden, fruits, chickens, goats and bees. You've probably eaten duck and turkey recently, maybe goose and squab. If you haven't eaten these latter two recently, do so—and then plan on raising what ever you like the best.

We Robinsons believe the goose is tops—best-tasting. Yet it seems to be the forgotten fowl in America. The most common objection we hear is that goose is too greasy. But you don't have to eat all the grease any more than you eat all the excess fat on the best cuts of beef. The first Christmas we were married I roasted a goose (at Ed's in-

sistence!) even though I had never tasted it. I used a prune and apple stuffing to offset the richness and pricked the skin to release fat which could then be poured out of the pan. I have been an ardent goose fan ever since. If you like dark meat, which we think more succulent and tasty than white, you should like goose.

Geese are the cheapest and easiest of all poultry to raise. Extremely hardy, they are rarely affected by any disease or insect pests. After they are two weeks old all they need is plenty of water and grass and they will gain a pound a week until they are about 12 weeks old. They may be eaten at this age and are called "green geese". Geese have no use for fancy housing—a simple 3 sided shed where they can keep dry in the severest winter weather is all they want for they prefer to stay in the open even at night. As for fencing, any low wall or fence 36 inches high holds them. At breeding time geese make their own nests, hatch their own eggs.

In Europe and Asia geese have been

highly valued for centuries. As far back as 4000 years ago the Egyptians used goose liver to cure night blindness—and they were right, for scientists now know goose liver is exceptionally rich in Vitamin A because geese eat such large quantities of green grass. Before the war Europeans raised more than 100 million geese a year.

If you live in a closely populated section you will not find geese desirable as their call is a noisy one and they are easily disturbed. In fact, they make good "watch dogs". If you want to keep feed at a minimum, ½ acre of good grass will support 8 to 10 large geese. Of course, you can keep them in smaller areas and supplement their grass with waste greens, vegetables or fruit and a little grain. Oats make a good grain. Geese need sand, grit and oyster shell for egg laying and digestion's sake. But from early spring till winter, it is grass and water than they prefer. If you supply those two things, your geese will virtually raise themselves.

You can start having geese by buying fertile eggs, day-old goslings, "started" goslings, or a matured pair or trio at least two years old. We could find no geese true-to-breed in our section so we bought eggs (35¢ to \$1.00 each) and hatched them under setting hens. It was one of the biggest thrills we have ever had—to see those little goslings hatch out. Here are the rules we would suggest after our experience:

1. Don't pay too much attention to all the free advice you'll get unless it comes from someone who has successfully handled geese for several years or from the Department of Agriculture or State Experiment Station.
2. Order your eggs from a reputable dealer suggested by your county farm agent or one who advertises in a good farm magazine.
3. Get your broody hens promised to you ahead of time by a large poultry keeper if you don't have any of your own. You may buy or borrow them. One hen covers 4 to 5 goose eggs. Move and place the hens on their new nests at night and keep the nest darkened.
4. When you make up the nests, dust them thoroughly with insect powder. Also dust the hens well a day or two before the eggs hatch. (You may use an orange crate on its side for 2 nests if you place a narrow board across the front to keep the eggs from rolling out).
5. Goose eggs, contrary to the usual practice, may be washed before setting. Turn the eggs once a day (when the hen is off her nest) as they are too large for hens to manage.
6. Take good care of your hen and her eggs. It takes from 28 to 35 days for eggs to hatch—a long setting for a hen. Take her off her nest once a day and give her grain and water. Be sure food and water is close so she won't wander off and forget her nest. A hen on goose eggs should not be off nest long enough for eggs to chill.

During the last week sprinkle the eggs with lukewarm water each day. The day before hatching place the eggs in a pan of warm water to cover eggs well and watch your live goslings bob. After a few bobs replace eggs in nest



Carolyn and Jackie get a close-up of a new member of the "family" — a day-old gosling. He came out of the shell yesterday. Today he is able to shift for himself quite well. A setting hen hatched him. Four or five goose eggs can be hatched (in 28-35 days) under a hen while your goose goes on laying more eggs.

and nature does the rest. (You furnish water to duplicate what occurs when a goose returns to her nest with her feathers a little wet.) If the egg should show the first crack of hatching, don't submerge the broken part. It can take a gosling as long as 24 hours to hatch after the first tiny crack in the shell, so don't be worried. Even if a gosling's head has emerged, the European custom is to push the head back into the shell so the gosling can obtain leverage to extricate himself. Take goslings from nest as soon as they hatch; place in a box and keep in a warm place until the hen completes her hatch. It is best to remove goslings because the hen is apt to get ex-cited at the first hatch, leave the rest of the eggs unhatched.

After you have hatched the goslings or if you buy them, keep them in a box with a few cloths in it in the house or some other warm place. A few hours after they are born feed them some chopped green feed—grass, lettuce, etc.—natural food for geese. Stale bread soaked in milk and sprinkled with a little sand, or a warm mash or chick starter may be fed. After the first day or so when they learn to manage their legs, put them out on the grass during the day—provided the weather is warm. But be sure to keep them in a warm dry shelter at night and don't let them out until the dew is off the ground. It is wise to let them have their box or shelter at night until they are well-feathered—at least 3 weeks old.

### Care of Mature Geese

Buying matured geese ready for breeding is the most expensive way to start your flock, a good trio costing \$25-\$35. However, if you decide to do this, it's best to mate just a pair, even though it is common to have a trio of 1 gander and 2 geese. Geese prefer to live a monogamous life, in contrast to other birds. After they once mate, they are faithful to each other for years so don't break up their happy union. Buy your geese and pair them in the fall so they will be settled and ready to lay in February (the usual time in mild climates.) Your goose and gander should both be 2 years old to be fully matured and to produce fertile eggs.

The difficult aspects of raising geese are to get fertile eggs and proceed properly with the hatching. Your success or failure begins with the gander. He prefers living with but one female—although sometimes he'll take up with two. But the gander and goose usually must live together some months before they will mate. Although water isn't absolutely necessary, some kind of a little pool (see Chapter on Ducks for making pool) or stream is good because geese breed more easily in water. Once you have fertile eggs, be sure that the hen or goose you set them under is really broody. Start her setting on some hen eggs for a couple of days to make sure she's really serious about hatching

The young geese are 8 weeks old — half-grown and weigh about 9 pounds. The pair of breeders (at left) are two years old. Geese are extremely healthy, eat grass, and practically raise themselves.



a family before trusting your geese eggs to her.

All the laying goose needs is a barrel or box on its side or some simple shelter and the goose will fashion her nest out of straw, twigs and her own goose down. The average goose of the heavy breeds can lay about 20 eggs, but is able to cover only 12 to 15, so remove the first eggs if you want her to continue laying more than she can set on. After she stops laying and becomes really broody see that she has as many eggs as she can cover well. Then, provided she has water (say, a large pond) so eggs will receive proper moisture, you can relax and let her hatch her own eggs. She'll turn them and do everything necessary.

We find geese are friendly and like to follow us around the yard, except during the mating and hatching season when it's best to stay away from the gander. Geese are fearless and will attack anything—you needn't worry about a rat, cat or dog bothering them.

### Choosing a Breed

Every small flock we have seen seemed to be some kind of mixture stemming mostly from the gray and white Toulouse goose. We chose the Embden because my wife wanted all white Toulouse goose. The other two best known breeds in this country are the African and Chinese. Both have distinctive knobs on their heads. The African is brown, apt to be noisy. Chinese geese may be white or fawn, weigh from 10 to 12 lbs., are apt to be noisy. They belong to the exhibition breeds.

Though we don't expect you to go into the business of raising geese we thought you might like to know that the commercial by-products of the

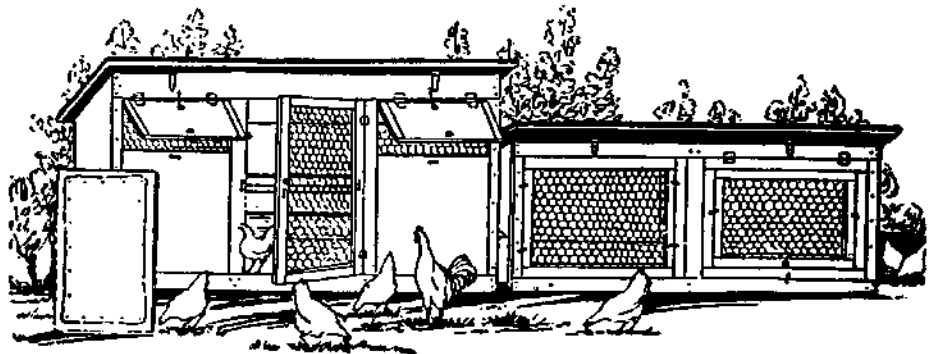
goose are exceptional. When geese are specially fattened they develop large livers which can be made into the famous "pâté de foie gras" which means "patty of fattened goose liver".

You know how goose feathers are valued in pillows and upholstery, but did you know they are widely used in artificial flowers, Christmas tree decorations, fish lures, powder puffs, and many other things? And goose skins are also used in one kind of powder puff besides their more familiar use as cracklings. And that "awful goose fat" we hear about so much is known to many people as "schmaltz"—is exquisite in taste and highly regarded by knowing cooks for pastry shortening, bread spread and other cooking.

Some people like "schmaltz" plain as a bread spread—or if that is too fat, you can make a Swedish bread spread. Cover bottom of skillet with goose fat, add finely chopped onion (1 large) and unpeeled apple (about 3 medium), brown slightly. Add ½ cup goose fat and simmer over very low flame until onion and apple are soft. Then place in container and in refrigerator where it will keep a long time. Use cool.

To make plucking easier dissolve 2 cakes of paraffin (poultry plucking wax obtainable from a poultry supply house is better than ordinary paraffin) in a large kettle of boiling water. Dunk the goose thoroughly in this mixture immediately after it is killed and bled. Then start plucking right away. The paraffin ruins the feathers for future use, but if you really want the down you can dry pick.

Despite the difficulty of picking, we think the goose is a wonderful bird!



We bought this little poultry house and the scratch shed (at right) for our original backyard flock of 7 laying hens. It cost \$28.00. Since then we've used it as a coop to fatten broilers and as a shelter for our geese.

# Turkeys

## Can Be a Profitable Sideline

**W**HEN you start producing food for your family, money will begin to lose its importance. You won't be digging into your pockets every time you turn around. First, you yourself will be producing a good part of your food and secondly, you'll be trading your surplus with your neighbors.

For example, we trade geese for turkeys with one of our neighbors, Tyler Long. Ty and his father have always had a hankering to raise turkeys. For a long time they just talked about it, then a couple of years ago they started in doing it.

Unlike a lot of people, including a few farmers I've met, they were frank with themselves in admitting to begin with that they didn't really know much about turkey raising. They determined to find out all about the newest and best ways of going ahead, start on a small scale. So they talked to any number of commercial turkey men, our county agent, and read everything they could get their hands on about turkeys.

Just to give you an idea of how well they've done, in 1942 the national turkey mortality rate from all causes was reported to be 28%. In 1943, when feed conditions were at their worst in 20 years, Ty kept his mortality rate down to 15%.

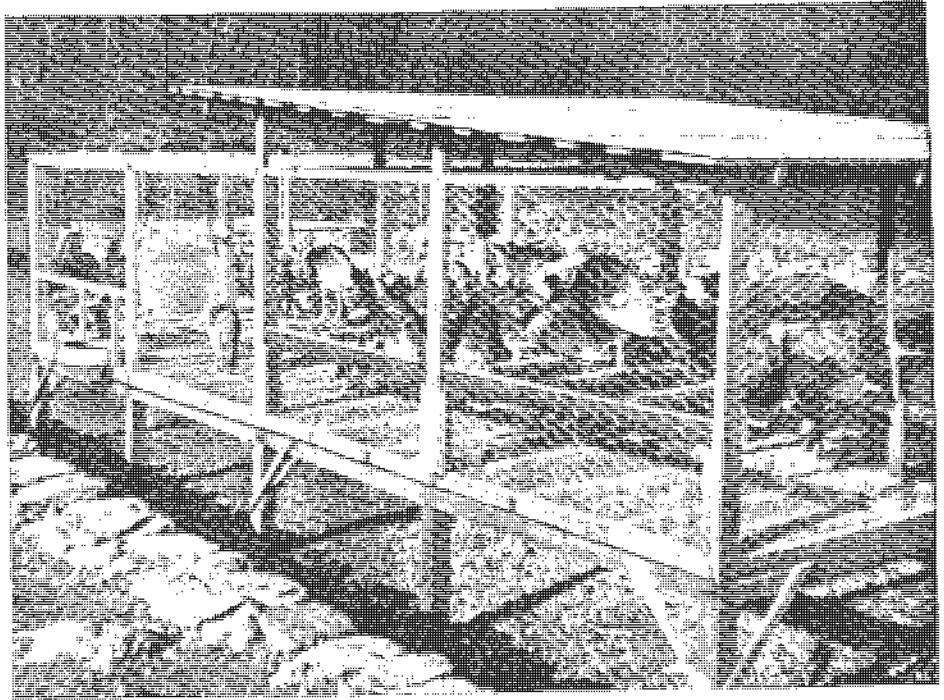
While it's true that scientific turkey raising requires certain precautions not always necessary in chicken raising, if a few general principles are followed with care, turkeys can be a surprisingly easy, inexpensive and interesting way of increasing your food supply. Turkeys, incidentally, produce more meat per pound of feed than almost any other kind of poultry.

We say this after observing Ty Long's experience raising turkeys. In fact, we have gotten him to give detailed, week by week, instructions, explaining exactly how a family can scientifically raise a dozen or so turkeys.

### What Breed?

By no means try to hatch out turkeys from eggs—buy day-old chicks or poults as they are actually called. Place your order early, sometime between December and March. The importance of good breeding in the day-old poults cannot be stressed too much.

Ty recommends buying them from a well-recommended breeder rather than from a hatchery. You can get names from the magazine, *Turkey World*, (Mount Morris, Ill., 15c a copy) or consult your county agent. Don't decide on a breeder farther away than



Twelve or thirteen turkeys should have a cage at least 10' by 12' with 12' of feed hoppers running along the outside. Roosts should be built in the sheltered end of the cage, using 2-by-4's with wide side as the roosting surface and allowing 14" space per bird. Top of roosts should be 20" from the wire floor and a space of 24" should separate one roost from another. Allow the birds complete access to the floor under the roosts, otherwise you cut their exercise area to the bone. A slanting roof of very heavy roofing paper and three sides of the same material (removed in above photo) should protect the roosting section.

300 miles, preferably closer. Specify shipment by Railway Express.

Most breeders specialize in Broad Breasted Bronzes—they give more meat per pound of frame. This is a good breed to start with, unless you want one of the smaller breeds. If, for your family use, you'd like to wind up with eight or ten fully grown turkeys, you'd best order 15 poults. Poults sell for from \$.50 to \$.75 apiece. These 15 will probably narrow down to twelve for the cage and eight or ten for your family and friends. You may, of course, do much better than this, in which case you can easily sell your surplus at a nice little profit.

Poor sanitation and dampness, huddling caused by improper heat control, and failure to start eating are the greatest causes of death in young poults. Because a battery brooder provides a maximum of sanitation and dryness, practically eliminates huddling, and its confined quarters are a big help in starting poults eating, we believe a battery is the easiest and safest way to raise your turkeys for the first four weeks. Equally important, a battery brooder reduces labor to a minimum. (See article on broiler battery, page 32).

Here are Tyler Long's week-by-week instructions. Don't let their seemingly lengthy detail discourage you. It's really easier than it sounds, and, besides, Ty is more of a "perfectionist" than most of us are likely to be.

### Week-By-Week Instructions

These instructions are not intended to be absolute. We feel that reasonable appli-

cation of them plus common sense circumstances not discussed in this short article will result in your successfully raising your turkeys.

### From First Day To Fourth Week

At least 2 days before the poults come, completely scrub battery, inside and out, feeders and waterers with hot soapy water. Rinse with hot water. Spray with a warm 4% solution of any reliable coal-tar disinfectant. Only then will your poults be reasonably safe from germs left by the battery's former inmates. Be sure all surfaces are thoroughly dry before the poults come in contact with them. Cover dropping board with newspaper to facilitate daily removal of droppings.

At least 4 hours before poults' arrival regulate temperature under hover (using brooder thermometer or thermostat) to between 95° and 105°. Reduce to 90° the third day. Thereafter a drop of 5° per week is usually advisable. However, behaviour of birds themselves is best barometer of their comfort. Cold poults usually huddle (their most dangerous habit), peep loudly and protestingly. Overheated poults act drugged and listless. Comfortable poults either sleep quietly or peep in a low, contented voice. Above all guard against huddling. More poults die in the first four weeks from smothering caused by huddling than from any other single cause.

On the other hand, it's just as important to remember that over-heating the birds at any stage of the game tends to produce a delicate, over-sensitive turkey. It is usually best for the first two or three nights to wake up at 1 or 2 a.m. to see that turkeys are comfortable. This is a chore, but a necessary one, since as many as 50% of your poults can be killed in one night by huddling.

Before placing your poults in their new quarters, fill the hoppers almost to overflowing with a turkey starter mash from a reputable feed concern. (If the mash is not Vitamin D fortified, add and mix thoroughly 1% Cod Liver oil until the birds are out in the sun.) Sprinkle about one teaspoonful

of fine hard chick grit to each three poult on top of the mash, so that they will get their "teeth" with their first meal. Continue giving this grit twice weekly until the tenth week. Fill the waterers with water the temperature of your hand. Continue for two weeks, then change to tap water. Keep both feeders and waterers filled to this level until poult can reach down into them.

Some of your poult may refuse to eat when you first get them. Put down a newspaper and scatter on it some chick scratch. Usually they will peck at this. Next day put chick scratch on top of mash in feeders.

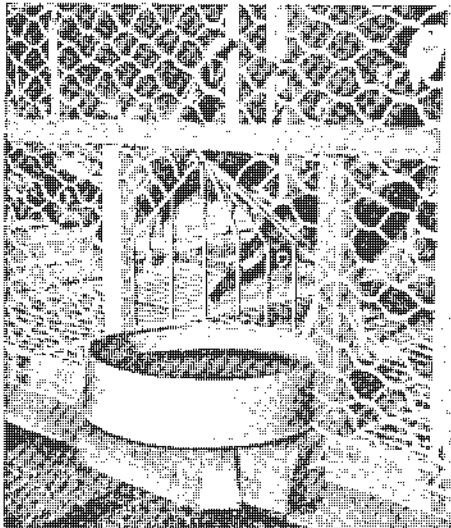
Wash the waterer every day in hot soapy water. Keep it filled with fresh, clean water. Wash feeders every ten days. Stir old feed in with new to prevent any becoming stale.

Inspect your poult upon arrival, culling out any malformed, injured, or dying ones. The simplest, most humane method is to snap the neck with a quick, strong twist of the hand. The same treatment should always be accorded any deathly sick or badly injured birds as a protective measure for the rest of your flock. However, like chickens, no disease or injury to which a turkey is susceptible can in any way render the flesh unfit for human consumption. But any birds that are to be eaten should be killed so that they will bleed.

### Disease Control

Baby turkeys are subject to a number of diseases, the most prevalent of which are coccidiosis and brooder pneumonia. The former is usually recognizable by bloody droppings and a general washed-out look to the bird. Pneumonia can sometimes be detected by the presence of phlegm in the nasal passage and some shivering. In each case the poult must be segregated from the others, kept warm and dry and fed warm milk, with an eye-dropper, if necessary. Nothing more can be done in the case of brooder pneumonia. The development of coccidiosis is sometimes arrested by administering a 1% solution of Epsom salts. This must be followed in six hours by dried skim milk mixed with the mash or water. Commercial anti-coccidiosis agents are sometimes found helpful. Never return the sick bird to its regular quarters until you are fairly certain a cure has been effected—you must not risk infecting the others. (Lederle's Sulfaguanidine, a new "sulfa" drug, has frequently halted rampages of coccidiosis when other measures failed.)

Keep a weather eye out for the condition known as "pasting-up", when the poult's droppings remain stuck to his backside. This is serious, as a poult (or chick) can die very quickly from the poisons caused



Detail of waterer: pan is protected by a wire guard. Construction prevents birds from contaminating water and enables you to water birds from outside.

by a clogged-up intestinal tract. Treatment we found safest: With a medicine dropper apply several drops of inexpensive mineral oil on and around the drooping, which will soon be worked off. Do not try to remove it; the poult's sensitive skin is easily injured.

### From Fifth To Tenth Week

The advantages of raising turkeys in battery brooders will turn into serious disadvantages if the birds are kept in them after the four week period. Many growers leave poult in batteries only 16 days. The fact that the birds are allowed to develop neither immunity to disease-bearing bacteria nor resistance to less favorable climatic conditions in its protecting confines is responsible for this. Therefore, at least at the start of the fifth week the poult should be moved to a clean, dry, thoroughly disinfected floor covered with at least an inch of good quality shredded litter, preferably sugar cane shavings. The average temperature, at the floor, of their new quarters (section of garage, barn, enclosed porch, small brooder house, etc), should be somewhere between a minimum of 65° and a maximum of 75°. If it is not possible to use the top-section of your battery as their hover (in which case you would remove the dropping board, floor grid, removable sides, feeders and waterer, using it only as a source of heat and shelter on top of the litter), build or buy a small auxiliary hover. (See Chapter on Broilers).

Such a hover, which can be quite simply constructed of insulation board with either 2 or 3 25-watt bulbs or a commercial heating element installed in the roof, must be large enough and adjustable in height so as to accommodate all the birds when they are ten weeks old, at which time they should be more than twice the size they were at four. The temperature should be gradually reduced (if necessary, vary the number and size of the bulbs) so that the birds get little artificial heat for the next to the last two weeks and none whatever during the last two weeks. Important considerations in selecting the poult's new quarters are adequate ventilation facilities and a good supply of sunlight, at times directly on the birds, if possible. Be careful about direct drafts on the birds for the first 3 weeks in new quarters. It would be much to your advantage if you could provide the turkeys with direct access to the air and sun in a small, fine gravel-covered yard or wire-covered cage connected with their new quarters. To accustom the poult to outside temperatures and breezes, be sure to leave all ventilation facilities wide open for the last ten days and nights.

Litter should be thoroughly stirred every other day and completely changed weekly. This is necessary both to combat germs and to keep their walking surface dry, a point of great importance. It is also important to keep the waterers on three-inch high wire platforms to prevent contamination.

Mash should now be fed in a regular chick hopper, water in a one or two quart glass or metal chick waterer. Finely chopped tender green-stuff (lettuce, spinach, orange, cabbage, grass, clover, etc.) can now be fed the poult to great advantage. Scatter moderate amounts each day on top of their mash. Otherwise, feed, grit and water conditions remain as before. (8th week—start to mix growing mash with starter. Gradually increase to all growing, 10th week)

From the sixth week on, a careful watch must be kept for the most dread of all turkey illness, "blackhead." (For identification and treatment of this and other turkey diseases get the Dept. of Agriculture's Bulletin 1652 *Diseases and Parasites of Poultry*.) Sanitation and segregation of infected birds is your best weapon in fighting both blackhead and coccidiosis. Lederle's Phenothiazine has arrested many epidemics of blackheads, but cannot be guaranteed as a positive cure. If any signs of lice are detected a very light sprinkling of drops of "Black Leaf 40" wherever the birds bed down, be

it litter or roost, will rid them of the torments and dangers of lice.

### From Tenth Week To Maturity

By the tenth week, under normal conditions, your poult should move to their permanent outside quarters. However, if poor feed or other circumstances prevent normal development or if the weather is unfavorable, it would be best to delay the transfer for a short time. These permanent quarters should consist of a solidly built wire-floored four foot high cage, with its base thirty inches off the ground and supported by pine or fir 4 x 4's whose bases have been dipped in creosote.



Ty Long feeding his turkeys. He says feeding time takes only a few minutes when hoppers are conveniently placed outside cage and adequate to hold a week's supply of feed. Good size for hoppers—8" deep, 8" wide, covered by 12" slanting roof.

If possible, open face of roost enclosure should face south. Sides and top of the cage may be constructed with lath or 2" poultry netting. Great caution should be exercised in eliminating all possible surfaces on the floor where droppings can collect. Bevel 2" x 3" (on the top) so that they will just hold staples 18" apart for the 1" by 2" flooring. A door should be placed on any side of the cage not taken up by the feed hoppers. Eliminate all sharp points or surfaces where the turkeys might injure themselves.

By this time a complete change from starting to growing mash should take place. Continue feeding chopped greens whenever possible. The grit, still lightly sprinkled on top of the mash twice weekly, should now be changed to broiler size. Starting with the 12th week broiler scratch, consisting preferably, of cracked corn, oats and wheat, should be fed in approximately one-quarter of the hopper space, boxed off from the rest. By the 20th week this should have been gradually increased to half the hopper space. Also near the 20th week the grit should be changed to full-sized and the scratch, consisting of the same ingredients, to full-size. Gradually increase the percentage of grain to mash until by the 20th week the birds are eating 50% of each. At this time it would make for a better finished turkey if you can make the scratch mixture 70% to 80% corn. It is possible, the last few weeks, to increase the consumption of feed by feeding a moist mash, made by mixing hot water on top of the dry mash in hoppers. However, care should be taken that none of the dry feed becomes sour. Remember the principle of finishing turkeys is to stuff them with as much feed of high caloric value as is possible.

An ailment known as perosis or "slipped tendon" is more prevalent in turkeys from the tenth week on, but it sometimes occurs earlier. Usually hereditary or nutritional in origin, perosis is sometimes introduced through infection. The trouble is easily recognized by the severe lameness and crookedness of one or both of the victim's legs. For treatment see the Farmer's Bulletin of poultry disease, No. 1652.

(Continued on next page)

## Turkeys (Continued)

Your turkeys are ready to kill when they have a fine layer of fat covering the entire body (shown by a white or yellowish appearance of the skin, rather than the purple tint of the muscle tissue) and when at least 95% of the pinfeathers have disappeared. This usually takes from 24 to 28 weeks, but any number of circumstances can delay the finishing. If you want your turkeys to be the best you ever tasted, you'll just have to be patient. A well finished Broad Breasted Bronze tom should weigh a minimum of 18 pounds and often as high as 26 and 28. The hen (whose flesh is not of a quality superior to the tom's) should weigh from 12 to 16 or 17 pounds. A smaller breed will weigh proportionately less.

During starving time, 18 hours before killing, provide plenty of fresh water.

### Killing and Picking

For a turkey slaughterer or amateur standing, decapitation with a sharp axe or machete is quickest, easiest. Immediately after the head has been severed, the bird should be elevated so blood is allowed to drip for about ten minutes. The plucking should take place immediately after the blood has stopped dripping. Again, the simplest method of plucking for amateurs is the semi-scald dip. Using a large vessel similar to a wash tub and a cooking thermometer to assure a temperature about 175°, the entire body of the turkey should be immersed for about 40-50 seconds. The feathers should come out with great ease; if not, dip again. It may be necessary to use gloves or pliers on certain of the wing and tail feathers. After the bird has been completely plucked, it should be hung by feet in a room with a temperature from 30° to 40°, and preferably, a relatively high humidity. If there is any food in the crop, the entire crop should be removed through a neat 3" incision in the front of the neck. Sew this up to prevent drying out and squeeze the vent to remove any droppings that may be there.

The turkey may be cleaned and roasted at any time after two days of chilling have passed; if the temperature and humidity are correct he may be kept up to 10 days. We recommend that you take your first bird to be cleaned to the butcher in order that you may learn the tricks of the trade directly from him.

### Points To Remember

In conclusion, here is a digest of the cardinal principles of scientific turkey raising. 1) Sanitation and dryness are your most efficient weapons against disease. 2) Never overcrowd your birds at any stage of their development. Always provide more space rather than less. 3) Never allow your turkeys to come in contact with chickens or any other poultry. Keep them as far from other fowl as possible. If the turkeys are to live in any shelter formerly used by other poultry always thoroughly disinfect those quarters. If there has been any disease there, always fumigate with formaldehyde and potassium permanganate. 4) Always allow adequate space at the feeders and waterers. This means that every bird should be able to eat at the same time and four birds should be able to drink at the same time. 5) Remember that turkeys are but recently descended from their parental wild stock—avoid all unnecessary loud noises, sudden movements and other disquieting influences, since they are much more timid and easily frightened than other poultry. 6) Always slip on rubbers or different shoes when going into the turkey shelter, so as to reduce the possibilities of infection from your chickens. Do not allow any visitors into area where turkeys walk.

# Ducks are Easy to Raise

**P** EOPLE are always giving us something. We got our trio of Muscovy ducks one day when a lady who lives near our Country Bookstore in Noroton, Connecticut, moved. They were breeders and she didn't want to have them killed. Knowing that we had a small farm, she thought we might like them.

There is a good deal to be said for making ducks your second poultry project, particularly if you have any kind of small stream or pond on your place, although neither is necessary. One of the unusual things about ducks is that they are well adapted to either a small place or to large-scale commercial production.

Don't start a duck project unless your family is fond of duck. If you're anywhere near as successful as we've been, you'll have a lot of duck. The trio that was given to us has produced over 25 ducklings in the first six months. Incidentally, Muscovy ducks are better eating, we think, than the ordinary Pekin variety that you get in the market.

Anyway, ducks do furnish delicious variety for the table. Many people like duck eggs, too, especially for cooking. Ducks require relatively little care and are practically free of disease problems. They are efficient and economical meat producers, gaining weight rapidly even when allowed to forage for much of their food.

You have three choices as to how to plan your duck raising program. You can keep a small flock of breeders the year around. You can buy day-old ducklings and brood them like baby chicks, but with less heat and care. Or you can buy duck eggs and hatch them out under hens.

### Keeping A Small Flock Of Breeders

If you just plain like ducks and like having them around; if you would like having some duck eggs for eating or

cooking in addition to having duck meat; if you have some grass forage land; if you have a stream or pond—then keep a small flock of breeders.

You don't have to qualify on all these points to keep a flock of breeders, but if you do, then your flock will practically keep themselves, providing you with plenty of tasty meals from spring until late fall.

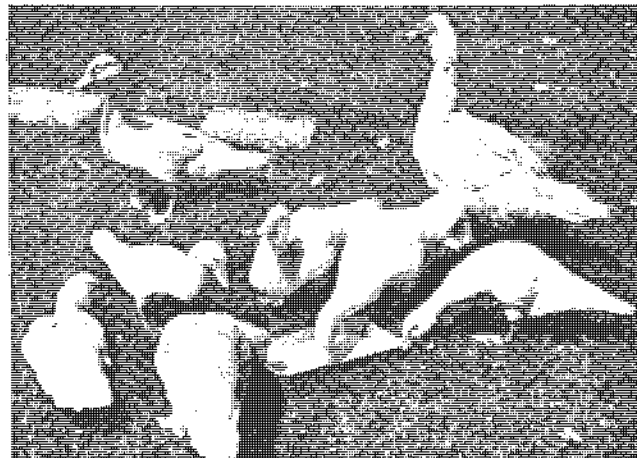
If you don't have forage, ducks can be fenced in, but will require more feed. If you don't have the stream or pond, you can provide a sunken trough, half-barrel or pan. You can raise ducks successfully without any water, but they like water to wash themselves in and it is said to be best if the eggs are moistened regularly during the setting. This moistening occurs naturally whenever the ducks return to the nest with wet feathers from bathing.

For housing almost any kind of shelter will do. A small coop with a door like that on page 39 would be ideal, because if you want to gather eggs it is a good idea to keep ducks shut in until 9 or 10 a. m. Supply litter on floor for warmth and dryness.

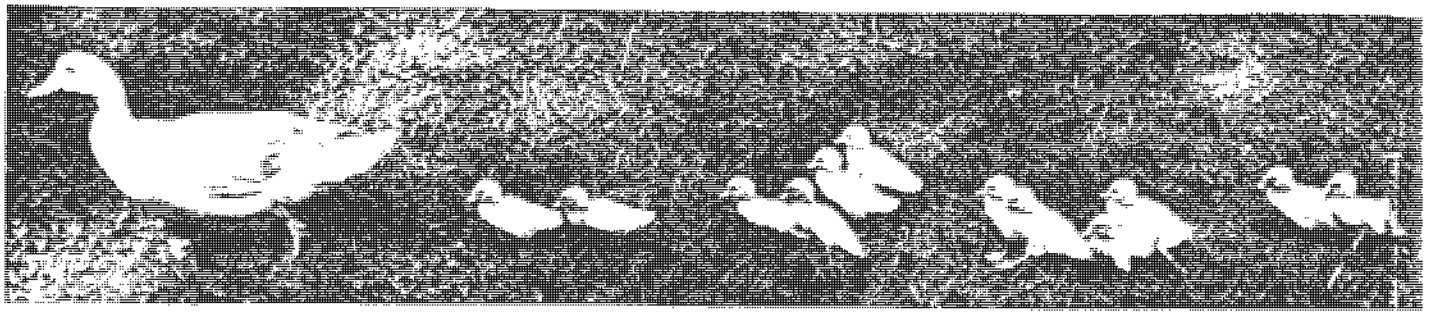
Your ducks will build their own nests in the shelter or around the place and will each hatch twelve to fifteen or even more ducklings at a sitting, and they will probably do it at least twice a year. They may produce eggs the year around, heavily from early spring through July. The number of ducklings you let them hatch will be determined by how many eggs they lay and how many you take to eat.

One drake for up to five or six ducks is a workable arrangement, but you will probably want to start with a "trio" of one drake and two ducks. A small flock will give you all the ducks that you want.

Ducks of most breeds are ready to eat from the age of about 10 weeks on. The commercial raisers force their flocks to a peak of growth and fatness at about nine weeks and then market the whole flock at one time. After that



Here are our quackless Muscovy ducks. We chose this breed because they aren't noisy; they have a better flavor, we think; they're very hardy and free from disease. Our trio of drake and two ducks produced 18 young ducks on their first hatchings. These ducklings are about 6 weeks old.



age the ducks will go into a moult and gain weight very slowly no matter how much they are fed. This is no great disadvantage in the small home-size flock which is foraging for much of its food anyway, and the usual practice is simply to start eating the ducks when they are big enough, and to go on eating them as needed until they are all gone, saving only the breeders chosen to be carried over to the next year.

Your original trio of breeders may be kept for two or three years or even longer, but more probably you will select from your whole flock a new drake and new ducks for breeders every year or two. You will probably want to buy or "swap" in new blood occasionally. There are many breeds of ducks, but the three breeds most suitable for the home flock are probably the Pekin, the Muscovy and the Indian Runner. The Muscovy is the largest, the Pekin next. The Runner lays the most eggs. Neither the Pekin nor the Runner is a good "sitter," and you would probably have to hatch their eggs under hens.

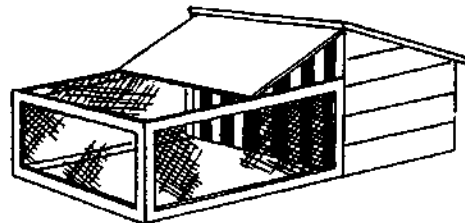
The Muscovy is a good big duck, the mature drake weighing 10 pounds and the duck 7 pounds, and they are a very hardy, self-reliant breed. The Indian Runners weigh only 4 to 4½ pounds at maturity. One important advantage of the Muscovy is that it is quackless and won't bother your neighbors. Muscovies are fliers, though, and if your fencing isn't pretty high, you may have to clip the outermost feathers from one wing.

A trio of one or two year old Muscovy ducks, of good healthy stock, will cost you about \$10.00, and you can obtain them by mail from breeders who advertise or perhaps you know some

one who raises them near you. Day-old Muscovies will probably cost from 40¢ to 60¢ apiece.

If you can't get the duck pellets, the simplest thing to do is to feed the same mash and grains you feed your chickens. A wet mash is sometimes fed, but this is an extra "wrinkle." When growing ducks are not able to forage, keep feed before them most of the time as you would for chickens.

If your ducks have a stream, pond or fairly large, clean bathing trough, you don't need to provide other drinking facilities. If they don't, you should



Coop and wire run suitable for hatching and brooding of ducklings with a hen. The bars keep hen confined, but let ducklings get sunlight and fresh air safe from dogs, cats, rats, etc. Top lifts up to allow cleaning, feeding, watering.

provide a reasonably deep (4 inches anyway and at least 12 to 15 inches across) supply of water. This is because of the peculiar nasal construction of ducks. They need to be able to get most of their bill in water when drinking.

#### Buying Day-Old Ducklings

You can get day-old ducklings through your feed dealer, from a neighbor who raises ducks, or by mail from people who advertise in farm journals.

The season when they are easiest to get runs from April through July.

By starting a dozen ducklings two or three times during the season, the first batch early in April, you can have a steady supply of eating ducks coming along from mid-June until late fall. And again, of course, if you have a quick freezer, you can have roast duck any day of the year you choose.

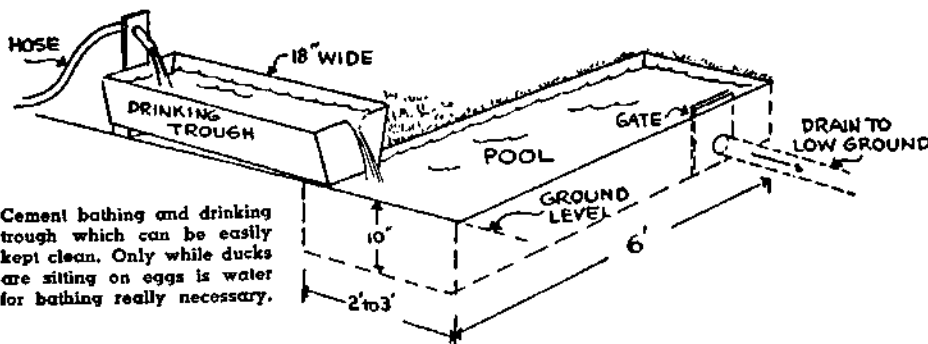
You can brood your ducklings in the same way you brood chicks, except that they require artificial heat for only three weeks—a shorter time than chicks do.

#### Setting Duck Eggs Under A Broody Hen

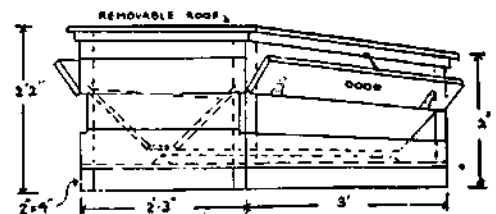
There are points to watch carefully in this method. One is that you obtain the broody hen at just the right time. She should be in the first week of her broodiness because duck eggs take about 4 weeks (a week longer than chicken eggs) to hatch, and she may tire of the job unless you get her when she has just gone broody. (Muscovies take 5 weeks to hatch.)

You should also care for the hen faithfully during the period of incubation. Take hen off nest daily, feed and water her. Usually she will stay off only five minutes to eat and drink, then get back on eggs herself. If she doesn't, put her back before eggs cool. Dust her well with insect powder at the beginning. You must also be sure the eggs are moistened (sprinkled with water) the last few days of the period.

A hen can usually hatch only seven to nine duck eggs, because they are so much bigger than chicken eggs. A rat-proof coop with wire run, as illustrated, is advisable for the hatching period of about 4 weeks and also for the brooding period of about 3 weeks.



Cement bathing and drinking trough which can be easily kept clean. Only while ducks are sitting on eggs is water for bathing really necessary.



Ducks are messy feeders and will waste less if pellets instead of mash are used. Here is cross section of pellet hopper used by commercial duck raisers. It can be made any size to hold from one to several hundred pounds of pellets, thus saving much labor. "Flaps" can be closed to cut down time pellets are available to the ducks, thus forcing them to forage.

# Squabs . . .

**A**S we've said we chose geese as our secondary poultry project, and we don't go in seriously for squabs. We thought we should include squab raising in the Plan, however, for those people who would want to raise them, particularly folks who live in the more crowded areas where there are city zoning regulations against chickens and other poultry. There are very few cities or towns that have strict ordinances against keeping pigeons.

In preparing this section about squabs we've visited a number of squab raisers and we've done a good deal of studying and reading. What we tell here is what we'd want to know before we started a new project.

Squab is one of those dishes that are usually thought of as being expensive, delicious and reserved for epicures. You can't even buy squab at most meat markets. Many people haven't so much as tasted this mouth-watering treat.

And yet, if you decide to have another poultry project in addition to chickens, you'll find squabs to be both interesting and delicious. Also, pigeons are among the easiest kinds of poultry to raise, among the surest of success.

They are not really cheap, though, even when you raise your own. They will cost you about half as much to raise as to buy, which means they will cost you about 35¢ to 50¢ apiece, depending on the price of feed at the time and other factors. Still, when you consider that one squab is about all one person can eat at a sitting, and that they are such a treat, the cost isn't so high at that.

Another point to remember is that it is just about as easy to raise twice the number of squab you will want for your own family, as it is to raise barely

enough. You can then easily sell the surplus to cover all your costs (first class hotels and restaurants are always in the market for squabs), or you can swap the surplus with neighbors for things they raise and you don't or you can make presents of squabs to friends.

## What Size Flock?

First, taking into account the size of your family, decide how many squabs you will probably want in the course of a year. (Squab, incidentally, is defined by the U. S. Dept. of Agriculture as "a young pigeon which is marketed just before it is ready to leave the nest, usually at from 25 to 28 days of age, when it weighs from 12 to 24 ounces.")

One good pair of breeder pigeons should raise 12 to 14 squabs in the course of one year. They may do this at a more or less even production rate throughout the year, but more probably production will be greater in spring and summer than in fall or winter. If you have a quick freezer you can, of course, "even out" production by freezing when there is a surplus.

If you don't have a freezer, then you will probably want to plan to have enough breeders to produce all the squabs you'll need even during the poorer months.

Figuring in this way it will be found that a "loft" of 12 pairs of breeders will probably produce an abundance of squabs for your family.

## Housing

Pictured on this page is the type of housing we would suggest. For 12 pairs of breeders the dimensions of the house should be about 6 feet wide and 8 feet deep (48 square feet to allow the 4 square feet of floor space per pair that is needed). It is important that the house should be as rat proof as possible, and, as in the case of chicken housing,

that it be dry, well ventilated and facing south for maximum sunlight. Open or semi-closed front may be used, but, as you would expect, the warmer the house in winter the better. A maximum temperature of 40 degrees F. in winter will tend to increase squab production, but you can get along fine without artificial heat.

There should be a double nest for each pair of breeders. Orange crates, with three inch board nailed across front at bottom and a six inch hinged landing board, piled one on top of another will serve for this purpose. Twelve such crates would be needed for a 12 pair house. If you build your own nests, each one should be about 12 inches square and 15 inches high.

Long leaf pine needles, straw, hay and tobacco stems are all used for nesting material. If nest bowls (which can be purchased from supply houses) are used, nesting material is not so necessary but some material is generally provided. The nesting material may be kept in a crate or rack in one corner of the pen to prevent waste. The pigeons will carry the material to build their own nests.

On the south side of the house there should be a wire-covered yard or "fly" as it is called. It can be approximately the same size and shape as the house. One-inch-mesh wire is good to use as it keeps out sparrows and rats. This wire should extend 12 inches into the ground, making a right angle bend at the bottom and extending 12" to 18" away from the pen to keep rats out.

Three to four inches of sand or gravel makes an ideal floor as this drains freely and is cleaned easily. A cement yard sloped to drain well and with one inch of sand is even better. "Running boards" about 8 inches wide should be placed on sides of pen, as illustrated.

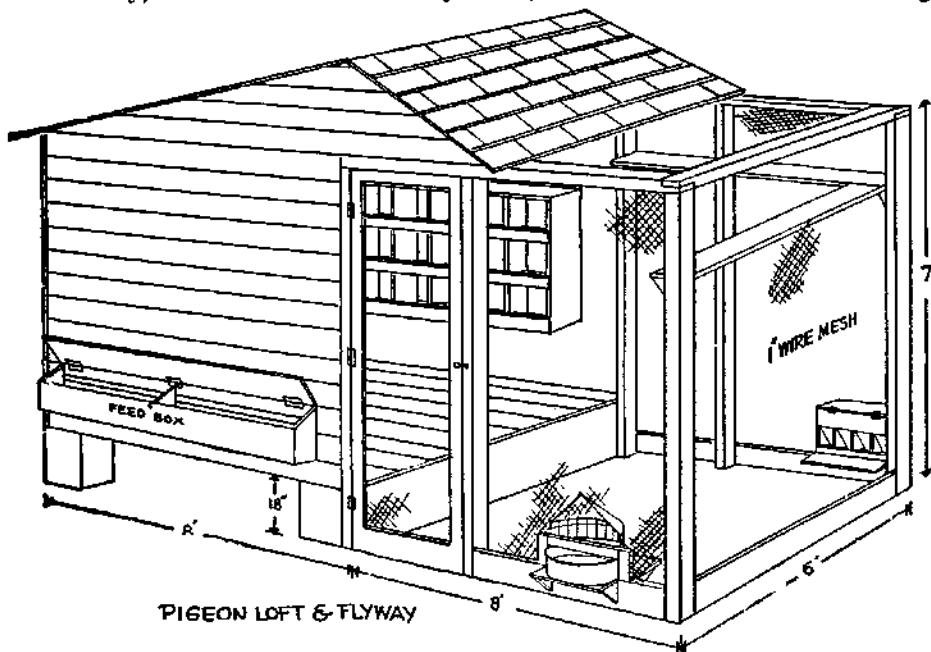
## Water, Feed and Health

Bathing in addition to drinking water must be provided for pigeons. An ordinary dishpan will serve for bathing and should be filled with water and left in the yard (except on cold winter days) for not over one hour or two a day. Then empty the pan and turn over so that pigeons cannot soil it.

For drinking water, use a regular chicken fountain. The water should be changed daily and the fountain kept clean. Obviously, running water handy to pen is a desirable convenience.

The young squabs are fed by the parents. The pigeons themselves should be fed a ration of whole grains—no mash or green feed. Minerals are fed in a separate mixture. Ordinary chicken feed will not do.

The simplest procedure is to buy a prepared pigeon ration from your grain dealer—and be willing to pay considerably more per pound for it than for chicken feed. It usually pays to buy the better grades offered, because they contain more of the ingredients the pigeons



House is shown with open front. Wood or cardboard partition can be used to close two thirds of opening for winter months. Note that feed trough, water fountain and grit hopper can all be "serviced" without entering pen.



like and which are particularly good for them, such as peas.

A good pigeon feed will contain from 13 to 15 percent protein, 60 to 70 percent carbohydrates, 2 to 5 percent fat, and not over 5 percent fiber. You will find an analysis of the feed you buy tagged to the bag. One pair of breeders will probably eat about 90 to 100 pounds of grain per year.

Use a self-feeder hopper of type illustrated—one that holds feed waste to a minimum. Since pigeons will pick out certain favorite grains it is advisable to put only about one day's supply of grain in the hopper at one time.

At your feed dealer's you can also obtain a prepared pigeon grit, mineral mixture. This should be fed in an open pan or hopper, slightly moist, and kept before the pigeons at all times.

Pigeons are subject to many of the diseases which affect other poultry. However, in a small flock founded on healthy stock and with reasonably careful management, you should have little trouble. The floor of the house should have one inch of sand or gravel, droppings should be raked from house and yard once a week.

Nests and nest bowls should be cleaned whenever squabs are "harvested"—and nests containing eggs or squabs should not be disturbed. Twice a year house and pen should be thoroughly cleaned and disinfected.

## Getting Started

You can purchase foundation stock from a pigeon breeder in your community, or order by mail from anywhere in the country. The magazine *American Pigeon Journal* (15¢ a copy, \$1.50 a year, address: Warrenton, Mo.) carries ads of breeders, or consult your county agent or grain dealer.

There are many breeds of pigeons, but the following are the best suited to squab production: *King*, *Carneaux*, *Swiss Mondaine*, *Homer*, *Runt* (the largest of all breeds). You can't go wrong by choosing *King* or *Carneaux*, because they are both among the most popular breeds and you will probably find it easier to connect with a good breeder, possibly one near you.

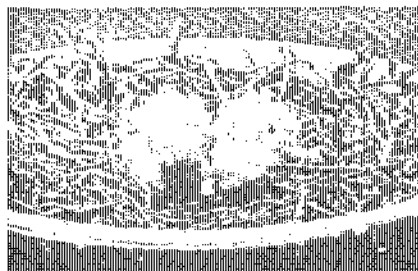
It is as important to get good pigeon stock as it is to get good stock for all your other poultry and animal projects. Get your pigeons from a careful breeder who keeps accurate records of the production and weight of his squabs and who guarantees both age and sex.

You will want mated pairs, at least 6 to 8 months old, and yet not too old—not more than two years old. As a rule, it rarely pays to keep breeders more than 5 years. (You can eat your old pigeons, but they aren't as good as the squabs. An old pigeon is worth about 25¢ and can be eaten in pigeon pie.)

After you get your flock established you can raise your own breeders. During April, May and June you will perhaps have more squabs than you need

for the table. You can raise some of these and when they are 6 to 8 months old they can be mated. One advantage in raising your own breeders is that they produce better at home where hatched.

But to begin with, you can expect to pay about \$3.00 to \$5.00 per pair of good breeders. Your best plan for getting good stock at a fair price is



Squabs 24 hours old.



2 weeks old.



3 weeks old.



3½ weeks old—will be ready to eat when fully feathered underwing in another week. (Courtesy U. S. Dept. Agr.)

to deal with the most reliable breeder you can find. The wise procedure is probably to start with two or three or four pairs of breeders, and then to increase your flock as you go along.

Pigeons usually remain with the same mate for life. Together they rear and feed the squabs. The hen pigeon will lay one egg, skip a day, and lay again. If more than two eggs are laid, remove the extra ones, because a pair of breeders can tend no more than two squabs properly at one time. The incubation period of the eggs is 17 days. Both parents build the nest and take turns sitting on the eggs.

The hen often lays another setting of eggs when the squabs are two or three weeks old and leaves the feeding of the first pair of squabs largely to the male. This is the principal reason why double nests are provided for each pair of breeders.

The parent birds feed the squabs on a thick, creamy mixture called pigeon milk, produced in their crops. Care should always be taken not to frighten pigeons, especially while feeding their young, and squabs should not ever be disturbed more than is necessary.

In case a squab dies during the first week or ten days, another single squab may be placed in the nest, provided the two are about the same size. This gives the pigeons without squabs the opportunity to begin producing again sooner than they would otherwise.

If the parent birds become sick or die, the young birds may be fed by hand if they are at least a week old. They should be fed at least 2 and preferably 3 times a day on grain that has been soaked for about 8 hours. Drop into the squab's mouth—feed enough to fill but not stuff crop.

## Harvesting

Squabs grow rapidly and are ready to eat about 26 days old or when fully feathered under the wings. Don't delay in eating them when ready because they will soon lose their baby fat and the flesh will begin to get hard.

To kill, hang squabs by the feet on a hook or nail and cut jugular vein in neck. (The professional way is to cut the vein, with a long, slender-bladed knife, inside the mouth just below base of skull). Lock the wings to keep from flapping, twist one behind the other.

Dry - pick the squabs immediately after killing because the feathers are very hard to pull out if the birds get cold. Pick the squabs on a bench or in your lap—do not hang on a wire. Pick clean and remove pin feathers. Skin is very tender, tears and bruises easily.

As soon as picked, cool for an hour or so in ice water, but not more than three hours. Clean as you would a young chicken. Cooking the squabs may sound like a problem but it isn't. All cook books give recipes.

# Rabbit—8 to 14 Cents a Pound

ONE of the first projects I wanted when we moved to our place in the country was rabbits. I had read many times that they produced excellent tasting meat at little cost. Carolyn, however, was sort of skeptical of the project because she thought that she she might not be able to eat the rabbits—they looked so cute.

One pay-day when I happened to read an advertisement offering a six compartment, all-metal wire hutch for sale for less than \$20 I couldn't resist this good buy. The hutch eventually came, but Carolyn was still skeptical and, anyway, we were up to our necks getting our barn finished up, learning to milk, running our broiler battery, our bees, goats, and setting the geese. It wasn't hard to put off getting the rabbits for a while.

Then, a friend of mine, Wally Boren noticed I hadn't done anything with my rabbit hutch and he asked if he couldn't use it until I got ready. That was all right with me. He borrowed the hutch, set it up in his garage and began reading up on the subject of rabbits.

## Choosing a Breed

Wally picked a variety called the Chinchilla. You can take your pick of several good meat breeds. Wally favored the medium sized breeds—weighing around 8 to 10 pounds grown. You could go in for the Flemish Giants, for instance, that sometimes weigh 20 pounds. They eat a lot more, of course, and their fryers, at 7 to 9 weeks, weigh not too much more than do those of

the medium breeds at the same age. The New Zealand Whites are another popular medium weight breed—their white fur is worth more than the Chinchilla...and there are a number of other good medium weight breeds.

Of course, there are Angoras (with their beautiful, white, long fur) and other "fancy" breeds. But these are not meat rabbits. In ordinary times many of the small rabbit raisers don't bother to save the skins, but they do have some value. Right now, for example, buyers are offering from 30 cents a pound to 90 cents apiece. You can obtain names of buyers from one of the rabbit magazines.

Wally started with a "trio"—a young buck nine months old and two does of the same age. He bred the does shortly after he got them. The following month he had 17 bunnies. Seven is a big enough litter, according to the experts, for one doe to raise. So Wally destroyed four from one litter of 12 and gave the other doe an extra to bring her litter of 6 up to 7. Wally rubbed a little Mentholatum on her nose so she couldn't smell the difference between her own and the young one from the other litter.

At seven weeks all 14 of the young rabbits were alive and frisky. At this age they weighed 44 pounds. The two does were bred again.

## 8c to 14c A Pound

Wally kept some careful records. Here's what he learned from them. A Chinchilla weighing 3 pounds, live weight will cost you from 25c to 35c or a little more to raise. You'd pay a dollar, at least, in the market for him.

Wally figured out how much time it took him to raise one 3 pound fryer. It took one hour flat. That is, he explained, "I spent 14 hours actual chore time—as a dub beginner—raising 14 meat-meals for the family. I could cut that in half, but I like pattering around them."

Wally had such good luck with the rabbits that, of course, I wanted to see what I could do. Wally, who is a most generous-minded fellow, kept us supplied with rabbit—he kept saying that after all he had to pay "rent" in some form or other for the hutch. Carolyn and I both liked rabbit very much; it tastes something like chicken but has a "firmness" that chicken doesn't have. I guess it was a year before I got my hutch back and got to keeping rabbits myself.

Incidentally, after we did get the rabbits we didn't mind the idea of raising them to eat—I guess after eating some rabbits raised by somebody else it's easier to go into rabbit raising strictly from the standpoint of raising



U. S. Rabbit Exp. Sec.

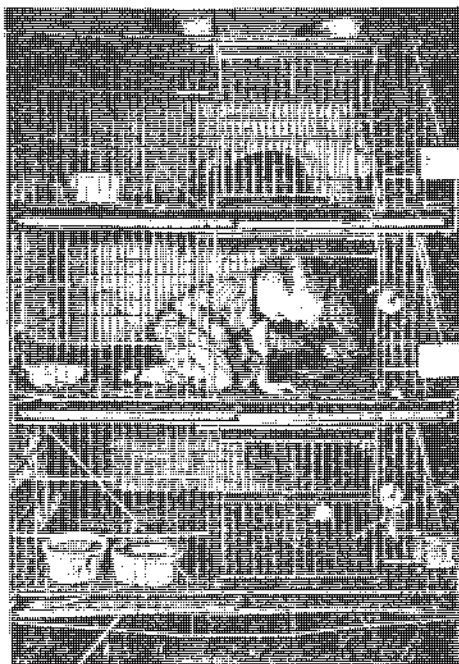
Here is how to cut up a rabbit. He makes six generous pieces, plus the liver — as good as chicken liver.

them for meat and not let yourself make pets of them. Of course, when you can put rabbits or chicken or anything else in a freezer and leave them there for a few weeks or months you'll find that you think of them as "meat" —not "cute animals."

## What To Feed Rabbits

You'll see in the diagram on Page 43 a hayrack indicated for each hutch. This you keep full of hay—the rabbit experts, because the industry is located in California where Alfalfa is easily obtainable, recommend Alfalfa. But a good, leafy clover hay is all right. Timothy isn't as high in protein as clover, but if it's properly cured it's better than a poorly cured clover or Alfalfa. The rabbits can manage the hay better if it is cut up in 3 or 4 inch lengths. (Take a handful, squeeze it into a bundle and saw it off into a box with an ordinary hand saw.) You can also feed vetch, cow peas, and other rich hays. You can give your rabbits dried scraps of bread and crusts; also any kind of vegetable parings and tops they'll eat. You can feed them lawn trimmings and weeds. But don't leave what they fail to eat in the pen. Take it out next day and pretty soon you'll find what they like best and how much to feed. Rabbits relish carrots and other root vegetables. Feed green feeds sparingly at first if your rabbits aren't used to them. Sometimes they over-eat and bloat or get diarrhea.

You also feed them one of the prepared rabbit pellet foods or whole grain—they don't seem to like any grain that's ground up too fine. You can ask the man you buy your rabbits from for directions as to what he's found the best methods of feeding.



When Jacks, three years old in this picture disappears we look in the rabbit hutch. Country raised, he's independent and fearless.

## How Fast Do Rabbits Multiply?

Everybody has a story about how fast rabbits multiply. I remember a friend of mine who had a small family and worried about this when getting his rabbits. In fact, he decided that he'd start with the minimum a single doe and a single buck. He was a salesman and everytime I'd see him I'd ask, "Well, how many rabbits have you now." The first month it was just two. The second month it was two. The third month it was still two. About this time my friend began to worry about his rabbits *not* multiplying. And when, at the end of the fourth month, he still had only two, I began to get a little suspicious. Sure enough, he didn't have a doe and a buck—he had two bucks!

Determining the sex of a rabbit is easy. Get the man you buy your rabbits from to show you.

I find that two does and a buck produce 40 or 50 rabbits a year to eat. At three pounds or more that is all our family needs.

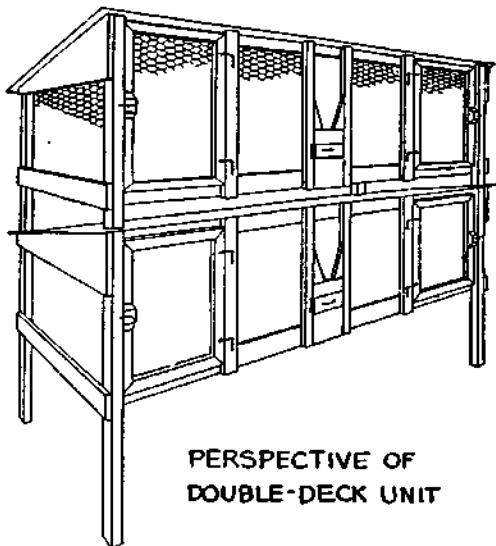
You breed about every 90 days. Gestation only takes 30 to 32 days. The young nurse for five or six weeks, learning to eat as they go along. At six or seven weeks you put the young fryers in another hutch or two and eat them between then and ten or twelve weeks. Or you process the whole tender crop at 8 or 9 weeks and quick-freeze all except the one you want for dinner then.

You can eat them as fryers until they're seven or eight months old—full grown. But by that time they've eaten a great deal of fairly high priced food and therefore aren't so much of a bargain, cost-wise. Better separate the young bucks from the does at 3 months.

You can kill off old rabbits at the end of a couple or even three years and make a stew out of them. The skin from a mature rabbit is worth considerably more than from "fryers."

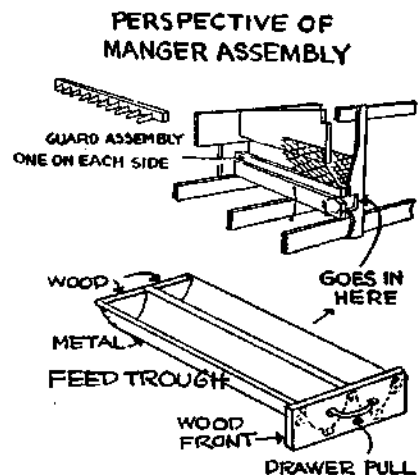
You can "inbreed" with no harm. Just keep a young doe or two out of a litter and breed her to your same buck when she's about 7 to 9 months' old. You can stagger your breeding times, having one fresh litter coming in every 6 weeks from one doe or the other. But if you adopt this system, you can't exchange the young between the does. Every 3 or 4 years buy or trade for a new buck.

And while we're on the subject of buying, try to get good, healthy and strong animals. You don't care about a "show" rabbit but do get good blood. They may even cost you from \$10 to \$25 a trio; you aren't likely to save money by starting out with \$3 worth of scrubs. However, don't worry about pedigree or perfect markings or blue ribbon winners.



PERSPECTIVE OF  
DOUBLE-DECK UNIT

Here is a good wood-and-wire type of hutch.



PERSPECTIVE OF  
MANGER ASSEMBLY

## Building the Hutch

Rabbits are very hardy animals, easy to raise and extremely clean. They can stand a lot of cold weather. They can't stand very much of a *wetting* and *hot weather* gets 'em down. They wear fur coats in *summer* remember. They have to have clean feed trays and clean water. They need a cool, shady summer place with lots of ventilation, *some* sunshine occasionally and a good roof. We keep our metal hutch in the barn. We clean it out once a week, keep plenty of straw on the floor and in the nest box (a nail keg with a strip across it—see illustration) and, in winter we water the rabbits night and morning, taking the water out before it freezes. In summer we keep the water trays always full. They drink a lot.

## Hasenpfeffer

Here is a recipe for the famous German way of preparing rabbit. Cut up your rabbit meat and put it into a jar. Cover with vinegar or wine and water, equal parts. Add one sliced onion, salt, peppers, few cloves, bay leaves.

Let this soak in a cool place for two days. Then remove and wipe the meat dry and brown it *thoroughly* in a frying pan, in hot butter, turning it often. Gradually add the sauce or juice you pickled it in, and let simmer about half an hour, until tender. Before serving stir in one cupful of thick sour cream.

There's a lot more you ought to know about raising rabbits before you go ahead. But I've tried to give you an idea of what's involved. There are one or two good books on rabbits that you'll find worth while reading. You ought to have more detailed information about hutch building, about dressing a rabbit, about keeping records, etc. "See Country Bookstore Catalog."

All in all the impression I'd like to leave is that rabbits are one of the first projects any one interested in home food production should investigate.

The space required by my rabbits is only 3 x 10 feet—and rabbits can be started any time of year.

Easterners are behind the times in discovering how delicious rabbit tastes. In California, where rabbit is king, many prefer it to chicken which it resembles.

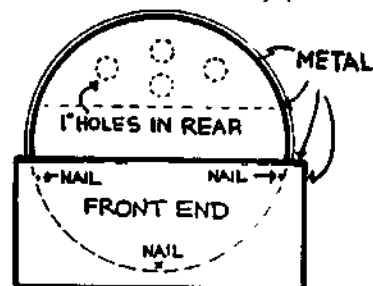
No other meat is easier, quicker, as inexpensive for the homesteader to produce as rabbit ... and it's easier to dress than chicken.

Two good does and a buck will give a family easily 180 pounds of good-tasting meat per year.

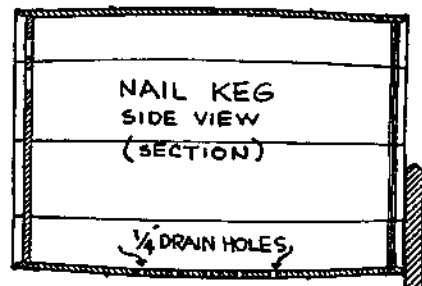
A modern, self-cleaning hutch fitted with the new automatic watering, requires less than 5 minutes attention a day.

## Suggested Reading:

*Rabbits For Food and Fur*, \$3.00.



NEST BOX



Here's a dandy nest box, made from a nail keg. The doe pulls hair and makes a warm fur-lined nest for the young before their birth. You keep the nest box in the doe's hutch from a couple of days before the young arrive until they are ready to leave the nest.

# Ham, Bacon, Pork, Lard

*"You can breed the pigs and buy the corn and get on;  
You can raise the corn and buy the pigs and get on;  
If you buy the corn and buy the pigs to feed, you haven't got a chance;  
But if you breed the pigs and raise the corn you'll make money."*

—Louis Bromfield

**E**VEN though this pessimistic little poem's about raising pigs commercially, it has a point that the backyard farmer shouldn't forget. The really profitable way to raise your own pork is to raise and fatten your pigs chiefly with surplus garden products, table scraps, home-grown corn.

The first year we started our plan, we raised two pigs. Because we didn't have many surplus vegetables, we bought about \$35 worth of grain per pig. We paid \$12.50 for inoculated 7 week-old pigs in April, had them slaughtered in December when they weighed 285 pounds. The dressed weight (per pig) was 230 pounds. In short, our pork cost 22¢ a pound. Last year it cost around 18¢.

From this experience we learned a few important points: For a family of three or four one pig will give quite a bit of meat. Even a 200 pound pig (live

With only 3 in the family, the amount of table scraps and surplus garden vegetables we had was discouragingly small when fed to two pigs. Incidentally, a pig will do well even if it doesn't get much grain. To keep feed bills down, you should plant a patch of corn or supply extra food scraps or garden or orchard produce. In fact, good pasture, fenced into three lots for rotating will supply 10 to 15 percent of the total food for a couple of pigs.

A single pig, unlike a single goat, doesn't get lonely.

From weaning time (6 to 8 weeks) a pig should put on about a pound a day. If fed grain entirely it will eat nearly ½ ton from April to December. But with pasture and surplus produce—vegetables, corn stalks, fruit, skim milk, acorns, and table scraps, even 200 pounds of grain will produce a good sized pig.

The backyard farmer shouldn't try to keep a sow, breed her, and produce young pigs. This requires a lot of time, trouble, experience and feed.

A young pig (or two) should be bought in the Spring—a March or April born pig is best. Such an animal costs at 6 to 8 weeks of age \$5 to \$12. Buy either a young sow pig or a barrow (castrated male). Be sure the pig is inoculated against cholera. This usually costs 50 cents. The young pig should also be wormed before you buy it.

It has often been pointed out that the day you buy your pig is the day you'll make or lose the most money. In short, buy from a good breeder or farmer with clean, disease-free stock. Be careful you don't get a runt. Choose a young pig that's long—a chunky one will make too much lard. The breed is not important—all breeds have been developed to produce meat.

## Easiest Way to Feed

The simplest way to feed a pig is to provide grain, (corn-on-cob, wheat or barley), a protein supplement (alfalfa leaf left from the hay fed goats for example), and a mineral mixture or a complete hog ration in separate compartments of an automatic hog feeder. This feeder plus an automatic waterer cuts chore time to the bone. Automatic feeders, which let animals eat as much and whenever they like, work best of all with pigs. No matter how much food you put before a pig it will eat only until full—never overeat.

Feeders and waterers are sold by Sears and Montgomery Ward.

Feed garbage, surplus garden produce etc. in a trough. This you can easily make, especially if you buy iron trough

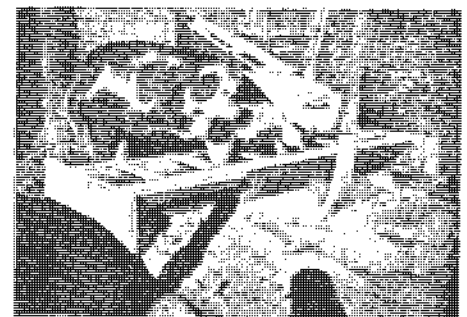


Six-week old pigs, already weaned, can be bought by mail. By feeding surplus garden vegetables, table scraps, and some grain they'll grow to 175—200 pounds in 20 weeks.

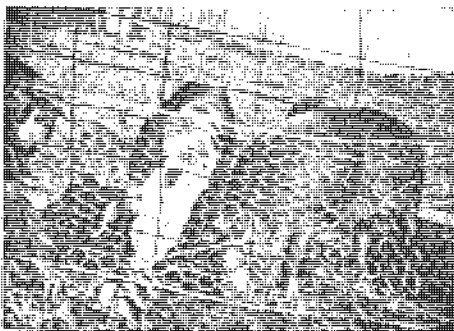
ends. Save garbage in separate can and keep free from paper, soap, glass, dish-water, etc. Don't feed garbage older than 3 days.

## Housing

Housing for a pig or two from April to December can be of the simplest. The standard portable A-type hog house is satisfactory and can be bought knock-down for around \$35. However, the backyard farmer probably hasn't enough land to require a portable house. A simple shed structure, 8 x 6 feet, 5 feet high in front, 3 in the rear, is most satisfactory. The front is open and the sun, which is the best disinfectant of all, can penetrate to the rear of the house. The roof is tar-paper, the rest of the shed is made of wood, including the floor which is set well off



Simple hog feed trough for garbage. Note braces which give each pig a chance to eat. Wide end boards keep pigs from upsetting trough.



Our ¼ ton of pork! When we bought young pigs the chicken-wire netting was necessary to keep pigs in. Incidentally, have you heard the old farmer's definition of a good fence: "Hog tight at the bottom—goat high—and sturdy enough to hold a bull".

weight) will give about 55 pounds of hams and shoulder, 40 pounds of bacon and loin, plus lard, sausage, pigs feet, etc. Two pigs are sufficient for a family of 6 to 8.

With only three in our family we made a mistake keeping our pigs until they weighed 300 pounds. After pigs go over 225 pounds their ratio of weight gained to food consumed drops.

We found that if you buy a 7 to 10 weeks old pig, innoculated, properly weaned, fed and cared for, you shouldn't have any trouble raising it.

# Building A Sanitary Pig Pen

the ground to keep the pigs dry. In the fall we keep the floor bedded with straw.

## New Method of Raising Pigs

Of special interest to the backyard farmer are the experiments sponsored by the Portland Cement Association, Chicago, Illinois. These experiments have to do with the confinement system of raising pigs on concrete. Like the battery-broiler system, instead of permitting animals to range, all food is brought to the pigs. Less than 15 square feet of pen is allowed per pig, obviously a system which requires so little land is of interest to the backyard farmer.

Inasmuch as pigs spend their whole life on concrete this makes possible maximum sanitation. Concrete floors are swept or flushed with a garden hose daily. A pit provides a sanitary, easy method of holding manure until it can be spread over the garden.

Confinement on cement eliminates "rooting" and racing about. This results in unbelievably fast growth. John Hendricks, who is given credit for developing this method of growing hogs, reports average growth of a hog to be:

Age	Weight
67 days	82 lbs.
132 days	195 lbs.
260 days	325 lbs.

The photos at right are our adaptation of the commercial hog raisers' confinement-on-concrete system which we have scaled down to a size suitable for 1 to 4 pigs. The confinement pen has worked out fine.

Watering is done automatically by attaching a Montgomery Ward double-drinking cup to the bottom of a barrel. This barrel can be filled once or twice weekly with a garden hose.

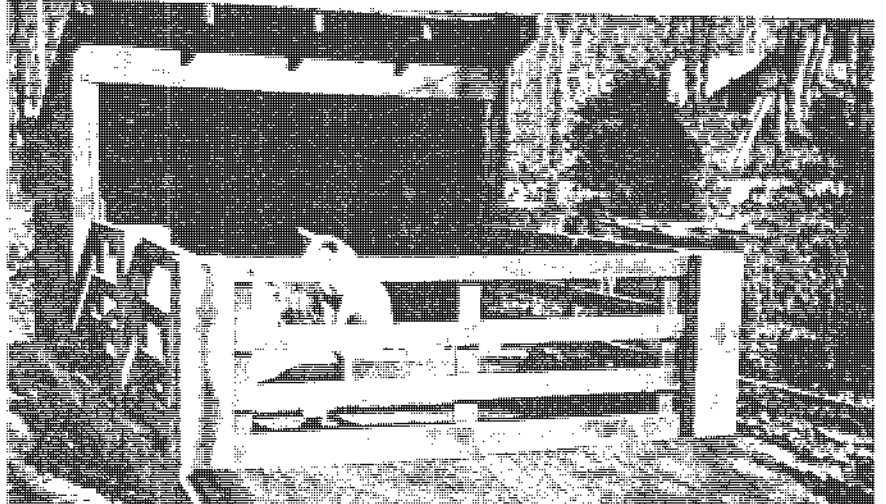
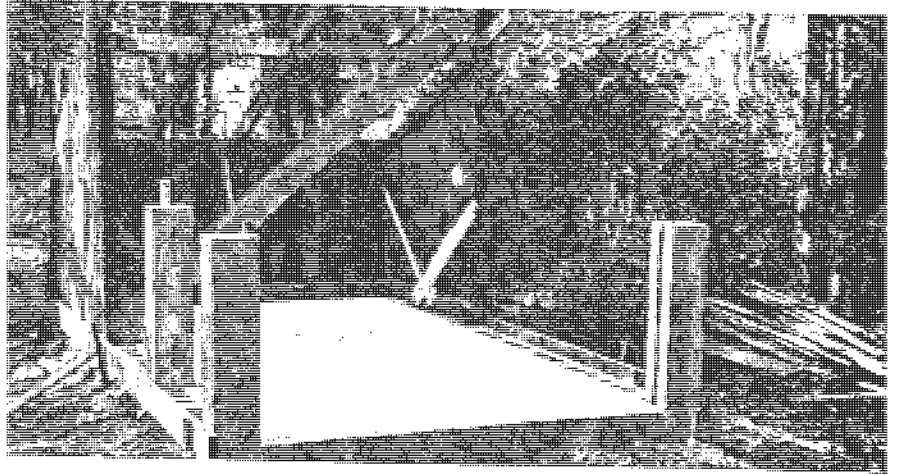
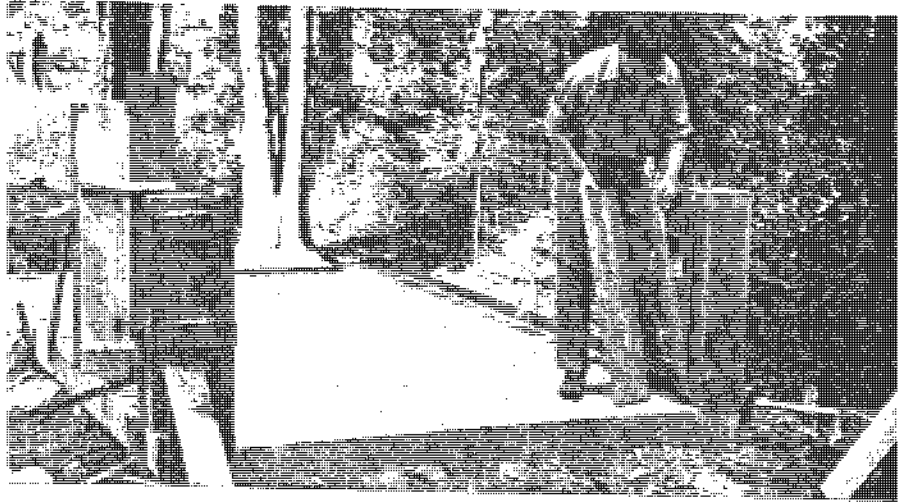
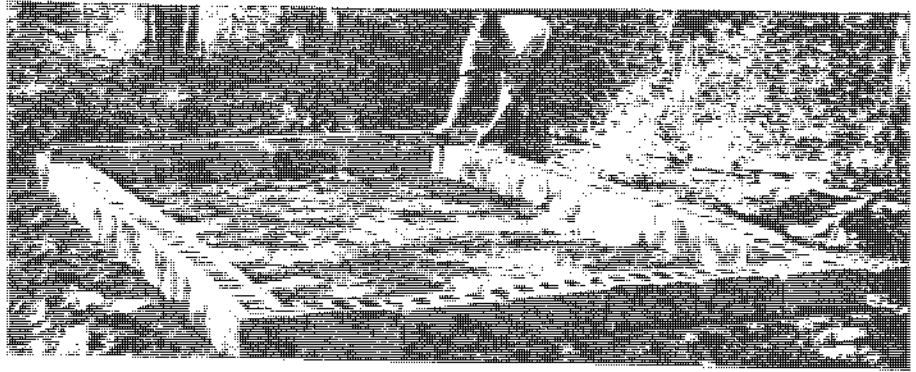
## Slaughtering

There is no need for the novice to do his own slaughtering. Your feed dealer will put you in touch with a man who will dress your pigs, smoke the hams, bacon, make sausage, hog's head cheese, liverwurst.

Or you can have your pigs slaughtered and dressed and do your own curing and smoking.

And boy—wait until you taste your own bacon and ham smoked country style—and that wonderful, honest-to-goodness all pork sausage—and fresh roast pork! If yours is as good as ours turned out you'll say you've never tasted any so delicious ever before.

With a proper set-up, fattening a pig will return more for the time spent than most any other project.



# The Miniature Dairy

"A small, well balanced collection of livestock can contribute forty to forty-five per cent of the average family food budget. Contrast this to the fifteen to twenty per cent that the home garden and orchard can supply. . ." *HOW TO LIVE IN THE COUNTRY WITHOUT FARMING.*

**S**URPRISING as it seems there are in this country about 5 million families keeping a family cow or goats. Yet I don't believe there is \$100 a year spent by anybody promoting the idea of keeping a cow or goats for the family's own milk supply.

Obviously, if over 5 million families in this country are producing their own milk (this figure does not include any commercial dairy with more than three cows) it must be a sound practice.

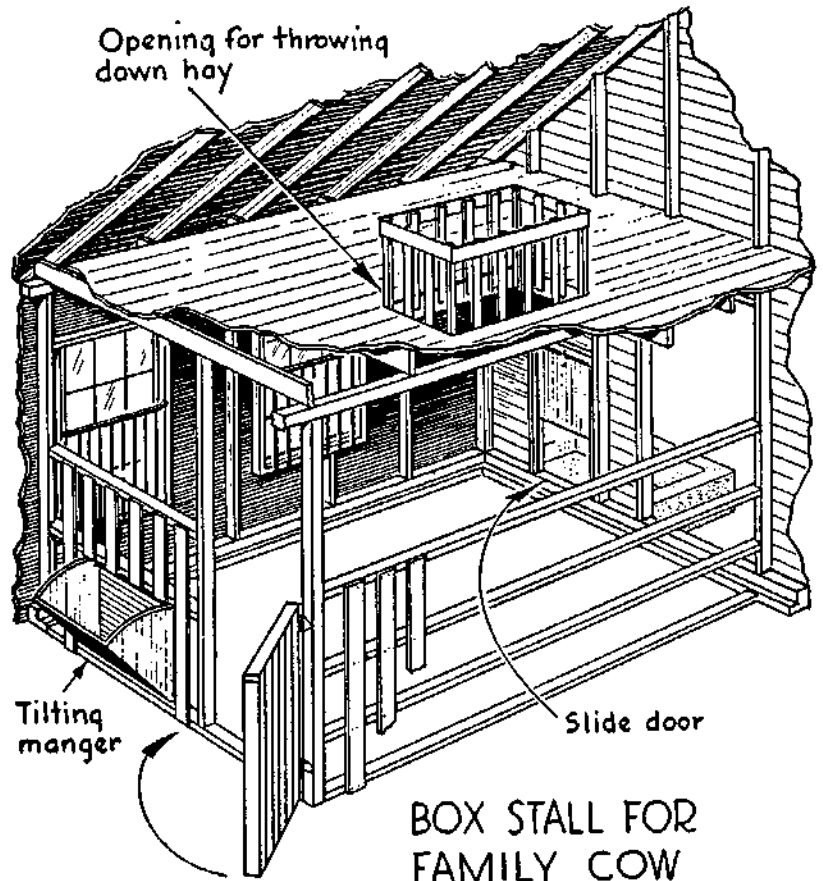
As a matter of fact producing your own milk is actually so economically sound, so basic in good times or bad, so widespread a practice across the width and breath of our country, and so simple to do that until recently there has been no book available to tell a city man moving to the country the few things he ought to know to supply his family with milk and dairy produce successfully.

There are in the United States a total of over 27 million milking cows and goats—approximately one per family. Your family, if "well-nourished", is already using the complete milk supply of at least one cow. One of the first things a family should decide when it moves to the country is whether it is going to take over the care of a cow or goats or continue to go on paying somebody else to do this.

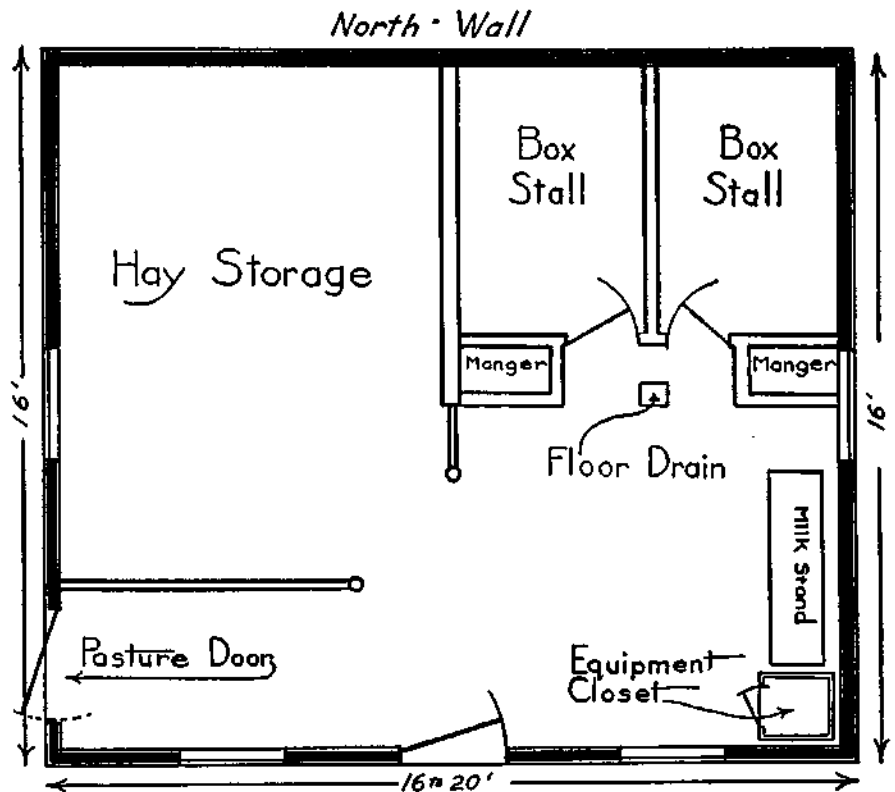
Cow and goat milk differ in many minor respects but in only this one important aspect: goat milk is naturally homogenized—the cream does not rise. But the cream can be extracted with a separator. A minor difference is in color; goat milk is whiter than cow milk. Butter and cheese can be produced from goat milk just as from cow milk.

Whether you choose to keep a cow or a couple of goats should be decided on the basis of how much milk your family can use, how much time your family can make available for milking, feeding, caring for your dairy—that includes butter, cheese, and ice-cream making if you keep a cow—and how much and what type of land you have available.

The following two chapters on goats and a family cow will, we hope, help you decide whether or not you'd like to produce the dairy products your own family needs.



BOX STALL FOR FAMILY COW



Two-Goat Barn

# The Modern Dairy Goat

Of all our farm animals the least appreciated by city friends who visit us are our goats. "Goats! You don't actually keep goats, My goodness, why?"

"Have you ever tasted goat milk?" we ask.

"No—and I don't want to!" is the answer more often than not. But, possibly at lunch time, we serve them two half-filled glasses of milk. "One is goat milk—one is cow milk . . . Just for fun, tell us which is which," we say.

Almost invariably our city guests can't tell them apart. Sometimes, if they've read that goat milk is whiter they can guess. But they always are amazed that our goat milk has no "strong" taste.

In the face of the public's misunderstanding of the dairy goat it takes courage to decide to keep them. Here's how we happened to do so.

One day when we sat down and figured what our milk, butter and cheese cost we found we were spending about 25% of our food budget in the dairy department. This was in line with what nutritional experts recommended. It was obvious then that production of our own milk ranked with raising our own fruits and vegetables from an economic as well as a nutritional standpoint. We figured on a garden and fruit trees plus a cow or goat to supply milk, cream, butter and cheese and we'd have one-half of all our family's food requirements.

Of course, either a cow or a goat can be stall fed and be given only a small exercise yard. But, ideally, a cow requires 1 to 2 acres of good pasture, an hour a day of care, and supplies 10 to 20 quarts of milk a day. Ideally two

goats require less than an acre of pasture (brush, fern and shrubbery are their favorites), 30 minutes a day, and provide 3 to 7 quarts of milk daily, the year round. A goat eats only 1/16 of what a cow needs. Goats are freer from disease so that both animal and milk are safer.

For the small place everything is in favor of the goat except a goat's reputation. Believe it or not, the modern dairy goat is almost the exact opposite of what the American public believes she is. As we have already said, the prejudice against goat milk is unfounded as far as our experience is concerned

## What the Goat Gives You

Let's make a list of all the products the dairy goat can furnish you:

1. *Milk*, not just ordinary stuff, but a rich, full-bodied milk. Goat's milk is naturally homogenized, small fat globules make it easier to digest. Frequently, it's used for invalids and children allergic to cow's milk. It's fine in coffee and makes a delicious, smooth ice cream. Also, goats are easier to milk.

2. *Cream*. Goat's milk has lots of cream, but it rises very slowly. Consequently, it is best to have a small cream separator. The cream may be whipped or used in any of your customary ways.

3. *Butter*, unusually smooth in texture, pure white, easily colored just as cow butter is colored.

4. *Cheese*. You have probably already enjoyed goat's cheese as millions of pounds are imported from Europe besides the domestic supply.

5. *Meat*, or chevon, as goat's meat is correctly named. Young buck kids 4 or 5 months old provide 35-45 pounds of dressed meat. Chevon makes many succulent dishes, and in the South particularly is considered a great delicacy.

Most likely you have eaten chevon without knowing it—thousands of pounds are sold each year as lamb. We think it is tastier than lamb, but Mrs. R. found it should be cooked a little longer.

6. *Furs and Skins*. Furs from newborn kids are beautiful and may be made into coats, jackets. A tannery or furrier can prepare the hides for you.

7. *Fertilizer*. Goat manure is one of the richest, most valuable manures—excellent enough to be in demand by greenhouses and fruit growers. You, however, will want to use it liberally yourself, for it will help you "have more" vegetables, fruits and flowers. Of all manures, it's the most inoffensive. You can see why from children's name for it, "nanny goat berries."

Considering all the products, the modern dairy goat is a valuable asset. Because of a goat's size a small barn is satisfactory. Also when it comes time each year to breed a goat you can hoist her into your car easily and get her to a buck. Goats are so easily handled that women frequently run large dairies.

Perhaps we seem unduly enamoured of our goats so we include this letter sent to the "Dairy Goat Journal," a magazine, (October, 1943). We quote: *I purchased a grade doe for \$15 which is giving me 3½ quarts a day of excellent quality milk. Two quarts of cow milk had been costing me \$8 per month. A grade cow would cost me \$75 to \$125 so I am somewhat amazed when people speak of milk being expensive and hard to obtain. I had a laugh when the editor of a farm magazine said that something should be done about it when an old stinky goat beat an honest dairyman out of \$7 or \$8 a month.*

*My goat is giving \$13.65 worth of milk a month and her feed costs about 10 cents a day. She doesn't stink either!*

This checks with our own experience—except our goats cost more than \$15.

## Cost of a Goat

A good goat now costs considerable since their value is being recognized rapidly. Our first goat, a grade Nubian doe, with her two kids cost us \$40. Our second goat (a young doe) was given to us by a friend who has a 20-goat dairy. Our third which was shipped to us 2,000 miles from one of America's best goat breeders cost us \$49, including shipping.

We now have two milking does. When they first freshen they produce



Milking a goat is far easier than milking a cow. Notice 4-quart milk pail partially covered to help keep milk clean.

a total of eight quarts a day. Eight or nine months later, before we dry them up, they are producing 1½ to 2 quarts a day. A goat generally gives more milk on her second and subsequent freshenings than on her first. Five to seven quarts of milk are easily used by a family of three. It takes about 8 or 9 quarts to make a quart of cream or a pound of butter.

Goats are sensitive to changes of ownership and home. It takes them several months to adjust themselves completely. In fact, they become so closely attached to individuals that they give more milk to the person who stands by them at kidding time and handles their new-born young.

We believe the perfect solution to the family milk supply is two milk goats. Two grade goats are better than one purebred for several reasons. You can arrange to have milk all year round by breeding one goat in September, the other in January. Two "three-quart" grade does cost less than one fancy six-quart doe as six-quart does are rare and cost \$100 to \$200. Goats also love companionship and will give better results when they have company instead of being kept in solitary confinement.

There are three ways of starting your miniature goat dairy economically:

1. You may buy four month old kids for about \$15 or \$20 and raise them to breeding age (about 15 to 18 months). They'll cost \$10-\$15 a year to keep.
2. You may buy a purebred goat past her prime, breed her to give you good young stock. Goats reach their peak at about 6 years, but live to be about 12 years old.
3. Or you may buy a good common doe, breed her to a purebred buck and improve your stock while getting milk at the same time.

We are working on the third plan ourselves and think it's the best. Kids from a good doe pay for her upkeep. The only drawback to raising your new kids (the doelings for future milk stock and bucks for slaughter) is their need for part of your milk supply. A kid should have a quart of milk daily for at least 2 months but we find we can substitute skim milk we have left after separating the cream, or substitute cheaper evaporated or powdered cow's milk after kids are a few weeks old.

## Goat Breeds

If you decide to buy a dairy goat you will find there are three popular breeds—Nubian, Saanen and Toggenburg. Keep away from the ordinary, short-haired American goat, commonly known as the old "alley goat." Goat breeders as a whole will not recommend one breed above another.

We chose the Nubian because it gives the richest milk rather than large quantity and because of the popularity of the breed in our section (an important consideration when breeding

time comes). It is not profitable for the small goat owner to keep a buck—a registered purebred buck is expensive, must be housed separately from the does as he is responsible for the unpleasant odor. Nubians range from cream to black in color, have long drooping ears and distinctive Roman shaped noses.

The Saanens are white or light cream and are the heaviest milk producers. The two goat dairies we know best have both Saanen and Nubian goats—thus combining the highest in quality with quantity.

Toggenburgs are brown with two white stripes down the face and white hocks. Toggenburgs are a popular breed. French Alpines and Rock Alpines are two other breeds relatively new in the United States.



Wilhelmina at 1 month.



Wilhelmina at 22 months.

## Guides to Buying

1. Visit several goat dairies. To locate dairies subscribe to one of the four dairy goat magazines, (\$1 per year) and look at ads. Or contact your County Agricultural Agent.
2. See the goat that interests you milked. Ask for her milk record if the dairy keeps records. Milk is measured in pounds. One pint equals one pound. A good goat gives 3 to 6 pounds a day.
3. Look for a goat with depth of body

and well-sprung ribs—points which indicate good food capacity.

The udder should be large and even, carried well under the body and with good-sized teats for easy milking.

5. Get a hornless doe or one disbudded. Horns are dangerous to other goats, children and the milker.

6. If the goat is registered get her papers at the time you buy—proof of registered stock means the doe's value and her kids will be higher if you wish to sell.

## Housing

A home for your dairy goats may be as simple or expensive as you wish as long as it keeps goats, feed and living quarters clean and dry. Whatever housing you do provide, plan the arrangements well. Place your pens, stalls and feed so that you take as few steps as necessary. Each minute saved on twice-a-day chores means 12 hours less work a year.

If you are just starting the "Have-More" Plan and cannot afford to build a miniature barn you may use any small, draft-free building you have or can buy secondhand. A shed 6' x 10' can accommodate two does. At kidding time, divide the pen into two smaller pens by use of a hurdle. A wire floor of ¾" heavy gauge mesh, held off the pen floor by a lumber frame keeps bedding dry and goats clean. A feed rack of wood slats will keep goats from wasting hay. (The grain ration should be fed in heavy, hard to tip-over, individual pans which can be bought for about 50c each.)

If you can build or develop part of your barn especially for the goats, you will find a miniature dairy attractive and easy to keep clean. We built our small barn to house laying chickens and our broiler battery in one part, goats, rabbits, sheep, and pigeons in the other. The floor is of cement which is easy to wash, especially with its small dairy gutter, running behind goat stalls. The 18" wide gutter is on a slight slope toward the wall with its own small opening to the outside. Thus dirt, manure and other trash may be swept into the gutter and outside into an iron wheelbarrow.

Our goat stalls are built of wood, on a wooden platform 8 inches off the floor. Each stall is 24" wide and 35" long and divided from the next by a partition 32" high. In front of all the stalls runs a long feed manger. Stalls are separated from the feed rack by slats or solid walling with keyhole opening for goats' heads—this keeps them from wasting hay. A feature we developed to keep a milking goat clean is a removable individual stall floor, the front solid, the rear slatted. Manure falls through the slats into the gutter and also doesn't get tramped down so it's hard to remove. Each stall's floor can be lifted out, cleaned easily and dried in the sun.



The goat barn should open directly to the pasture enclosed by a sturdy wire fence 4' high—goats are agile jumpers. Goats may be tethered on chains or ropes with swivels at both ends to prevent tangling—but tethering takes too much time.

### Feed and Health

It costs about 10¢ a day to feed a producing doe when you buy all the feed. Goats relish stale bread and other kitchen scraps providing these are clean and free from mold. Contrary to popular opinion, we found goats meti-



Two pens for kids or maternity ward. A ¼" wire mesh floor tacked to 1" x 2" wooden frame and laid over cement floor keeps bedding in kid pens fresh longer.

culous in their food habits—they won't touch food dropped on the floor or contaminated in any way. And they dote on variety—my wife says they take after me (or vice versa).

During the winter a milking doe should have about 2 lbs. of alfalfa or clover hay (750 pounds yearly which you can raise on ¼ of an acre), 1½ lbs., when possible, of corn 'silage or roots (turnips, carrots, etc.) and 1 to 2 lbs. of grain ration. When on pasture, we feed less grain, only a little hay, no 'silage. The mixing of grains is too complicated for us—it's best to buy a prepared ration sold by a reputable hay and feed dealer. Clean warm water should be supplied at least in the morning and night and goats encouraged to drink (a few drops of molasses in the water makes it appealing.) Salt bricks should be accessible at all times.

Goats are naturally healthy, hardy animals and if they are well cared for you should have no trouble. They rarely get tuberculosis (as cows do) or Bang's disease, one cause of undulant fever in humans. We are following the rule required of dairies—having a veterinarian test the goats twice a year.

As a final precaution, you can pasteurize your milk by heating it to 142° F and holding it at this temperature or slightly higher for 30 minutes—or raise to 160° F for 15 seconds. In either case milk should be cooled rapidly by putting container in ice water. Also, we suggest you have a vet the first time

your goat kids—just for your peace of mind, as goats seldom have any trouble giving birth. You can expect 2 kids at the second kidding and you may get 3.

### How to Milk

"How did you learn to milk?" is one of the most frequent questions our city friends ask. We truthfully answer, "by reading how." So can you. Here's how:

Sit with your right side next to the doe's right side, your shoulder close to her shoulder. Hold the teats, thumbs outside fingers. Close your grasp, beginning at the top (thumb and index finger) and successively close the other fingers, thus forcing the milk down the teat and out. Milk firmly but gently until milk stops flowing. Then strip the teats by running the thumb and first finger from the top of each teat to the bottom until the last drop is out. Gently nudging the bag encourages the milk flow. You will be slow and awkward at first as you will have to think about each step but it won't be long until you'll be doing it so casually you'll be surprised at people asking you where you learned.

We warn you that the first few milkings may seem like desperate events in your life—we laugh and laugh now when we look back at our struggles. Don't try to learn with just one hand. Use both hands from the beginning and keep a firm hold even if the doe tries to move around. She will test you out a time or two but you can keep her right front leg in place with your right shoulder and her right rear foot in place with your left wrist. Once you show her you won't let her go she will be quite patient with your efforts.

You will want a small milk stand which you can easily build yourself. It is simply a small stand about 1½' off the floor—40" long and 22" wide. At the front end you place posts 55" high and slats 4½" apart with one slat movable so that the goat's head can go through before you straighten the slat up to hold her in place. A rail on the side opposite the milker keeps the goat from moving too freely. See picture of our homemade milking stand.

When it comes to handling your milk I think you'd better do what my wife tries to do—follow dairy rules as well as you can. She insists on using a disinfectant (planned for milking equipment) on the milk pail, milk jars (we use canning jars because of their wide mouths) and in water used to wash the udder. The teats and the milker's hands must be dried thoroughly before milking, the first stream of milk from each teat thrown away. We strain the milk through filters, discarded after use, then set the jars of milk in ice water as rapid cooling creates a healthier, better-tasting milk.

Pasteurization with a tested goat is up to you. Raw milk certainly tastes

better and some experts say it has more food value.

When it comes to feeding milk to your kids, by all means pan feed them. If you let them nurse, you lose control of your milk supply. Bottle feeding is a messy affair. After the kids are born place them in a box or basket so they cannot get out to their mother. After you pan feed them a few days they will not try to nurse and can run with the mother. Dip your finger in the milk, let them lick it and get them to follow your finger into the pan. After a time or two your only trouble will be keeping the milk from being spilled as the kids dash for it. Feeding the kids is fun even though commonly called a "chore."

### Time Savers

1. Try to have running water in the barn or as close as possible.
2. Store feed close to feed racks to save time and mess.
3. If you build, plan a dairy gutter sloping to an outside opening of its own.
4. In the pens build racks of slats or heavy wire mesh to stand an inch or so off the floor to keep bedding cleaner and drier.
5. In the stalls place removable wooden racks for ease in cleaning.
6. Fence in a pasture if possible—the initial work is easier than continuous tethering.



Even a Crosley is big enough to carry your goat. Mimi is on her way to visit Ptolemy, a prize Nubian buck.

# A Family Cow

**K**EEPING a cow, like marriage, is a confining and responsible relationship not to be entered into lightly. Flirtation, study, an engagement, even trial marriage are advocated, for dairymen, like fond parents, are unduly enamoured of their heifers.

Like marriage, too, keeping a family cow is a great institution. In fact, American agricultural writers often refer to the cow as "The Foster Mother of the Human Race." This is undoubtedly a little over-enthusiastic for in many parts of Europe 80% of the milk is goat milk.

The first time you squat on your brand-new, insignificant three-legged milk stool and your new cow towers above you, a thousand pounds of the Lord-Only-Knows-What combination of unknown evil, wickedness, and danger and you see her big, horned head turn at the fumbling indignities you are attempting under her hind-quarters, you're bound to experience a sinking in the pit of your stomach and an intense feeling that a cow is too gigantic an undertaking for you. Anyway, if this feeling doesn't come over you at the beginning of your first milking, then it will unquestionably at the end when it dawns on you that all that milk, that big pail of milk, is going to be duplicated night and morning every day for the next ten months.

Actually, a cow isn't large or dangerous. In fact, compared with your car she's less than one-third the weight—and when you realize that the auto is responsible for some 30,000 deaths a year, not including some hundreds of thousand injuries, then you'll have to agree that a cow isn't dangerous. A family cow, particularly a Jersey, becomes the gentlest of pets.

As for the superabundance of milk—it's none too much when translated into terms of milk for the family, cream, skim-milk for chickens, pigs, and a calf, and particularly if you want to make ice cream, butter and cheese. If yours is an average, decently fed family, you are already using one cow's entire milk supply. There are in the United States, according to the census, something like 26,000,000 producing cows. That is at least one cow for each American family enjoying a sufficient amount of milk and milk products. In short, the point is: Are you going to keep a cow or go on paying somebody else to do it for you?

I know it's hard to believe that a family accustomed to buying one or a couple of quarts of milk a day can easily use 10 or 12 quarts. It was that way with us when we started getting 6 or 7 quarts of milk from our two milking goats. Honest, though, if you're going to have a productive homestead, you'll find it simple to use the milk effectively without setting up a milk

route. For example, you'll be able to have plenty of real, heavy cream—for coffee, for cereal, for berries, for ice-cream, for cooking, for butter-making. Remember, it takes 10 quarts of milk to produce one quart of cream. And a quart of cream makes only a pound of butter . . . or a quart-and-a-half of ice cream . . . and just ask your wife how much butter and cream she'd like to



Isn't she lovely . . .

use in cooking if she could use all she wanted!

For every quart of cream you produce, you'll have about 9 quarts of skim milk. This is the finest food you can feed pigs, chickens and other poultry. If you still think you'll have too much milk, there's the annual calf that your cow will produce. If you raise the calf to veal size, about 180 pounds, the calf will consume daily a pint of milk for each ten pounds it weighs.

Another thing to bear in mind is that although a cow isn't by any means something you can turn on or shut off like a faucet, you can to a certain extent control the amount of milk she produces; she can be just as efficient producing less milk, strange as this might seem. The efficiency of a cow is simply a comparison between what she costs to keep and how much she produces. During the course of a year a commercial dairy cow will consume about 2 tons of hay, require one to two acres of good pasture, and eat 2,000 pounds of grain or other concentrates. A homesteader interested in self-sufficiency usually has the pasture land and can make the hay, but has to buy the grain. A cow, however, doesn't need grain. Professor Carl Bender, of Rutgers, explained to me how a cow could be kept in perfectly good health on a diet of good hay, good pasture and in winter succulents such as beet pulp or the sugar beets themselves. Obviously, a cow that isn't fed grain won't give as much milk—probably it'll give only 70% of what it would give when fed grain to supplement pasture and hay. But to the homesteader considering what to do with a cow's full production of milk, a cow that will give 7

quarts of milk a day instead of 10 quarts might be preferable, particularly when she can also eliminate a grain bill.

Less than an eighth of an acre will provide the 25 pounds of sugar beets a day necessary to feed your cow during the months when pasture is not good. Beets or mangels can be stored in a root-cellar. They are simply washed and sliced before feeding.

The more the countryman looks into the business of keeping a cow, the more practical it seems. Your first cost, buying the cow and fixing up to keep her, is figuratively speaking your last cost. For if you have some suitable pasture and raise your own hay and succulents, then the only other regular cash outlay should be about \$15 dollars a year breeding and veterinary fees. On the credit side you should get at least 5,000 pounds of milk (about 2,500 quarts), a calf which will give you 90 pounds of veal, and 12 tons of good manure. If you've had to buy manure, then you'll appreciate how valuable 12 tons is.

All this sounds pretty rosy. But there is the other side, too. Although neither an elaborate nor expensive building is required, you'll need a barn of some sort. It should be draft-free, have a decent sized window to let in plenty of sun and fresh air.

Also, you'll need a place to store two tons of hay. Hay can be stacked outside the barn and covered with canvas, but this should be considered only an emergency measure. Of course, if you're going to buy your hay, you can buy it by the bale and then you'll need very little space. Eventually, you'll want to make your own hay, and you'll need storage space of at least 10 x 10 x 10, or the equivalent, to store two tons of loose hay. Incidentally, the rule for finding the number of tons in a mow is: Multiply length x width x height (in feet) and divide by 400 to 500 depending on the length of time the hay has been in—there's also a slight variation depending on the type hay.

Another thing you'll want is between one and two acres of good pasture. The pasture should be fenced into three small pastures to let you rotate the cow. Although many people stake out their cows, this is needless trouble compared to fencing a pasture so the cow can simply be turned loose into the pasture from the barn.

You'll need some equipment: milk pail, water pail, milking stool, square manure shovel, 6 prong manure fork with tines not over 1 3/4" apart—wider tines allow droppings to fall through—cow halter and rope, curry comb and brush, barn thermometer, udder wash cloths, milk scale, milk production record chart, insect spray gun, hay forks—one in loft, one in barn level—and a metal wheelbarrow. Total cost—about \$30.

You should also run water to the barn. And you'll want to work out a manure pit or compost system for easy handling of manure.

Then there are certain items needed to handle the milk efficiently. Milk setting cans . . . milk strainer and filter discs . . . an inexpensive butter churn and, if you can afford it, a small separator.

That'll be most everything—except for the cow.

### What Breed To Select?

There is no best breed. Oftentimes a Jersey is the first choice for a family cow because its milk is richer and it is a smaller cow. A few people find a Jersey's milk too rich. (See table.)

One thing to determine before selecting a particular breed is how you're going to get your cow bred each year. Find out from your County Agent about the availability of artificial insemination. If this isn't possible, then you'll be better off by getting a cow of the same breed as the most convenient bull, if you intend to raise any heifers.

### Buying a Cow

When you set out to buy a cow the most important thing to do is to be sure that you buy a healthy one. Have her tested for both tuberculosis and Bang's disease, and see that her udder is free of mastitis. Your veterinarian will check up on these.

If the seller hasn't kept accurate milking records, and only about one in ten dairymen do, then be present at two—or better three—successive milkings. Or ask for a written guarantee of the cow's milk production.

Buy from a reliable man. Remember, in spite of all the to-do about judging cattle at the shows by external appearance nobody can honestly tell how good a milker a cow is by looking at her. If that were possible there wouldn't be the thousands of dollars spent on record-keeping by the big milk producers.

A young cow is worth more than an old cow. Although, if you get an especially good buy in an old cow with an outstanding milk record, you might consider buying her and replacing her as soon as possible with her heifer. Naturally, this is something of a gamble. She may have a couple of bull calves before a female—and when she

does have a heifer, it'll be almost 2½ years before the heifer will be milking. A cow reaches its prime at about 7 years of age; if healthy and well-cared for she will produce well to 10 or more years.

### How Much Time Does a Cow Take?

For 10 months of the year the family cow must be milked twice a day. Milking should be regular, but can be done at any two periods 12 hours apart. There is absolutely no reason to milk a cow at such an ungodly hour as 5 or 6 A. M.—that is, not a family cow. A cow will do as well milked at noon and again at midnight. Or a cow can be milked on a 10-14 hour schedule—say 8 in the morning and 6 in the evening. But milk her regularly—at least within ½ an hour of her scheduled time.

Feeding will take about 10 minutes and needs to be done morning and night.

Pasturing shouldn't take but a minute or two if you have wired runs from barn down to pastures. (See "Layout for a Productive Homestead.")

Caring for milk—straining, cooling, washing utensils 5 to 10 minutes.

Separating, every other day, about 10-15 minutes to run through 25 quarts or so; about 8-10 minutes to clean separator.

Butter making from cream takes about 30 minutes.

A small cheese takes about 3 hours to make, spread over about 6 weeks time.

In addition, a certain amount of time will be needed to make a couple of tons of hay a year and produce the sugar beets or other ensilage.

This sounds like quite an undertaking when you add it all up. But compare keeping a cow with a family garden. The dairy products consumed will exceed in retail value the total possible saving from the operation of a well-run vegetable garden including canned and stored vegetables.

Milking will take about 20 minutes—morning and night. Cleaning barn and removal of manure about 15 minutes. Grooming cow—about 5 minutes.

Watering should be made automatic. If by hand it will take 5 to 10 minutes.

Raising a calf calls for teaching the calf to drink and then pan feeding three times a day for 4 to 6 weeks.

### Specific Costs and Returns

Too often the benefits of productive country living have been interpreted solely in economic terms. How much more valuable is fresh milk with a 5% fat content as compared with the two or three day old store milk of only about 3% butter fat? To some people milk is milk—but to others fresh, rich milk and heavy cream from a Jersey cow is worth twice what ordinary milk costs.

Anyway, here are two sets of returns on keeping a cow. Neither take into account that fresh milk is usually preferable.

The first figures are from a state bulletin and are averages:

"Actual costs, on the average, for first year if pasture, housing, and bedding are available without monetary expenses are shown in the paragraph that follows:

Cow purchase price \$100 to \$200 (average usefulness of young cow five years) . . .	\$150
10 pounds grain (mixed ration) daily multiplied by 200 (days) equals 2000 pounds @ \$30 to \$50 per ton . . . . .	40
15 to 20 pounds hay (alfalfa, clover, or mixed clover and timothy) multiplied by 200 (days) equals 2 tons @ \$20-540 . . . . .	60
(Amount depends on size of cow and her appetite. Plenty of hay is absolutely essential.)	
Breeding and Veterinary fees . . . . .	15

\$265

Returns from a good cow per year are: 3,000 to 5,000 quarts of milk @ 10¢ equal to \$300 to \$500."

Now for some specific figures from the book, *The Family Cow*.

"Jeanne is an ordinary crossbred Jersey-Guernsey purchased for \$85. Her record of 1943 may be of interest even if the costs and prices may not apply elsewhere or at other times. She freshened in May and was milked for 318 days. She produced 8337 pounds of milk, ranging from a peak of 42 lbs. to a minimum of 12 lbs. This amounted to 3877 quarts of milk, an average of 12.2 qts. per day. Butterfat ranged up to 5.35% so she probably produced around 420 pounds of fat. This is equivalent to 462 pounds of 90% butter or an average of 1.45 lbs. of butter a day if all the milk had been thus used.

"Dairy products were consumed and sold as follows:

	Consumed	Saved	Sold	Cash Income
Milk	1200 qts. @ 15¢	\$180.00	250 qts.	\$35.46
Cream	80 pts. @ 35	31.50	70 pts.	27.26
Butter	90 lbs. @ 50	45.00	135 lbs.	67.31
Cheese	50 lbs. @ 12	6.25	32 lbs.	4.00
Skim	300 gal. @ 15	45.00	236 gal.	39.42
Buttermilk	70 qts. @ 9	6.30	30 qts.	2.70
		\$314.05		\$176.15

There are several bookkeeping approaches to these figures but they all show one thing clearly—that the family cow is a pretty good investment!

### Cows Have Character

	Ayrshire	Brown Swiss	Guernsey	Holstein	Jersey
Average size at maturity (pounds)	1200	1350	1100	1300	1000
Color	Red and White	Dark Brown	Yellow	Black and White	Fawn
Butter test (per cent)	4	4	5	3.45	5.3
Disposition	Nervous	Docile	Active	Docile	Nervous
Maturity (months)	28	34	27	29	25
Adaptability for beef	High	High	Low	High	Low

From "A Practical Guide to Successful Farming."

# A Few Sheep For The Small Place



**C**ITY people who take up country living are generally amazed at the bounty of the land and are always giving something to friends. I guess that's why Carolyn's aunt, who'd recently bought a farm in Alabama, sent us one of her home-grown lambs. And that's how we learned a little about sheep.

A single lamb, like a single goat, is a lonesome creature. We tried using him as a "lawn-mower" on the front lawn but he bleated half the time. Finally, although we knew it wasn't the best practice we turned him out to pasture with our goats.

The goats had never before seen a lamb—and I guess the lamb had never seen goats. Goats and lamb eyed each other suspiciously. The ridges of the goats' backs bristled. Then the lonesome lamb, in a friendly fashion, ran toward the goats. Frightened, the goats scampered away and it was a couple of hours before they would let the lamb get near them. Finally, they sniffed him over and philosophically accepted this "ugly duckling". Our lamb was no longer lonesome.

This lamb proved so little trouble that the following year we bought two, fattened them, and had them butchered just as with our first. In many parts of the country I'm told the sheep's skin pays the cost of the butchering, but our butcher didn't seem to want the skin. For \$3.50 we had it made into a rug—they sell for \$7.50 to \$20.00. Buying one or two lambs, fattening them for 30 to 60 days, and then having them slaughtered is *not* the most economical way to produce your own lamb, however.

Often times, a weaned lamb when moved will lose weight for awhile and consequently require more grass and grain before they "make" 90 to 100 pounds, the customary weight at which

they are slaughtered. Then again a young lamb is apt to cost \$7.00 to \$20.00. The one point in favor of buying and fattening a lamb is that this is an easy way to gain experience.

Before we discuss a better way to get started, lets take a look at what is necessary in the way of pasture, grain, equipment, time, and money to economically produce your own lamb.

## Good Pasture Essential

The first thing you should be able to supply is good grass. You don't need much grass pasture—it takes about a quarter-acre of grass, 750 pounds of hay, and 100 pounds of grain yearly to support one sheep. Remember, though, you should have at least two sheep.

As for the hay, alfalfa is best. In fact, you can raise and fatten your lambs solely on good grass and good alfalfa. Clover and soybean are good hays also.

Many different grain combinations are suitable for feeding sheep. The easiest plan for the homesteader with goats is to buy "sheep and goat" ration. In *Starting Right With Sheep* a mixture of two parts oats to one part bran is recommended as the best all-around sheep feed. For fattening use five parts wheat, two parts corn, two parts oats, one part linseed-oil meal. Sheep must have plenty of water.

Now the most economical way of getting started with sheep is to buy a couple of bred ewes in the winter. Ewes should be vigorous and in good flesh, but never fat. Also make sure they are free of external and internal parasites (notice droppings) otherwise the new born lambs will become infested. Bred ewes sell from \$10.00 to \$50.00 depending on whether they are scrubs, grades or registered purebreds, the reputation of the seller, age and merit of the animals. Fleece, conforma-

tion, age and udders should receive close inspection.

## Housing and Equipment

Housing for sheep can be simple, a three-sided shed with roof and a dry dirt floor is satisfactory. Two sheep need an 8 by 10 foot pen or building. A wood or wire rack is necessary for feeding hay and a trough or manger for grain. Salt and phenothiazine mixed according to directions you get with the phenothiazine, plus water are kept available at all times.

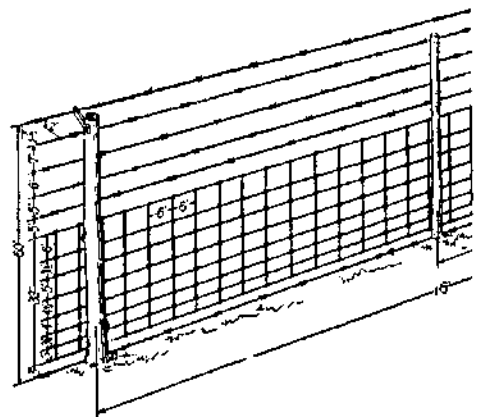
## Fencing

While it is true that sheep may be tethered by a chain and swivel, this is not practical. Sheep are not good lawn-mowers—they'll eat the grass too close. Tethered sheep cannot be left out all night, and they are easy prey for dogs. *Dogs are sheep's worst enemy! In fact, the primary purpose of fencing for sheep is to keep a stray sheep-killing dog out rather than the sheep in.*

## Choosing A Breed

In general there are two types of sheep—the wool and the meat variety. The homesteader should choose a meat variety. The breeds differ a great deal according to various sections and systems of management, but the part-time farmer should choose from the meat or so-called medium wool class—Southdowns, Shropshires, Hampshires, Ox-fords, Dorsets, Cheviots. Unless you're going to keep a ram, it's a good idea to find out which breed of ram is available in your neighborhood. When your first lambing time comes (about 145 days after breeding) you might have to have a veterinary present. The simplicity of the whole thing will give you confidence to handle subsequent lambings yourself.

All in all, sheep are easier to handle than cows, goats, horses, or poultry.



A Good Fence For Keeping Your Sheep Safe From Dogs

# Veal and Beef on the Homestead

**A** FRIEND of mine who likes to eat once chose to spend his vacation at a Western Dude Ranch. He figured that for once he'd get all the tender juicy steaks and roast beef he could eat.

When he came back I asked, "How were the steaks?"

"Oh, good . . . good," he answered—but I detected an odd note in his voice.

He explained. "Funny thing about that ranch—even though they had a couple of hundred steers on the place they got their beef from Chicago. . ."

If a Western Ranch specializing in the production of beef cattle doesn't even raise beef for its own use then what right has a homesteader to think that he can profitably do so?

On one or two acres you probably won't go very deeply into beef production. But even on two acres if you are keeping a cow you'll find yourself raising beef in the shape of veal. Veal, as you know, is calf meat.

Once a year your family cow, like all dairy cows, has a calf. In the ordinary dairy, bull calves and heifer calves from low producing cows generally are slaughtered as veal at an early age. Often, before they are two weeks old because the dairyman does not want to bother feeding them or providing the milk they need. This early butchering is one reason why more people don't like veal. Early butchered veal hasn't anywhere near the quality of eight week veal. The best veal is from milk fed calves about eight weeks old. And this top-quality veal is the kind that the part-time farmer can easily produce because when the family cow freshens and starts producing 12, 14 or 16 quarts of milk a day a few quarts can be fed to the calf and the family still will have enough for drinking, cream, butter—and enough for cheese and chickens too.

## Feeding The Calf For Veal

The calf should either stay with the cow for the first three or four days to suckle the first milk, the *colostrum*, or the cow should be milked and the milk given to the calf. If the latter procedure is followed, I think you will find that the calf will learn to drink from a pail more easily. We find it very difficult, for instance, to let a young goat kid nurse and then attempt to teach it to drink from a pan.

The weight of the calf will determine how much he should be fed. If allowed to stay with his dam, he will consume small amounts frequently. This is ideal, but you cannot favor him in this way if he is separated from the cow. On the average, feed eight to ten pounds (4 to 5 qts.) of milk per day, generally one-half in the morning, one-half in the evening. Milk should be at body temperature, and pails kept very clean. Give the calf a dry pen, free from

drafts. If he is not hungry, miss a feed rather try to make him eat. As age increases, gradually increase the amount.

If some skim milk is to be used, decrease the amount of whole milk gradually (one pint or less at a feed) and add equal amounts of skim. Warm the skim milk. Do not boil.

## Raising A Steer

During the meat shortage there was a great revival of interest among small farmers, estate owners, and homesteaders in beef for home use.

If your place has enough good pasture (1 acre per steer) and enough good quality hay (2 acres of clover or alfalfa would be ideal), then you might consider raising a steer. Shelter can be simply a three sided shed; if you don't have to carry water, then a steer won't take much time.

A fellow down the road from me who has just about two acres has a steer project underway with a minimum of trouble and investment. He simply went to a dairy with a herd of Holsteins (Brown Swiss and Ayrshires make good beef too; Jersey and Guernsey not so good), bought himself a young male calf, weaned him, and tethered him out in the orchard. He kept the calf on grass all spring, summer, and fall. In October he started feeding some corn he'd grown and at the end of November he had the fatted calf slaughtered. Naturally, if he were going to sell this young steer (he had the vet castrate it) he'd have had to hold the animal for another 9 months or even a year. But for home use this baby steer provided some excellent eating.

## What Is "Baby Beef?"

A number of people with small country places have an idea that because their place is small "baby" beef would be just the thing. "Baby" beef are young, well-bred, good quality cattle, often Angus, which are slaughtered at the tender weights of 700 to 1,200 pounds. BUT they are fed grain just as soon as they will take it—the idea being to keep them from losing their baby fat. The part-time farmer who probably doesn't grow much grain, won't find them economical, but of course they do make delicious beef.

## How To Put On Fat

Is it practical for the part-time farmer or small farmer to raise an honest-to-goodness beef steer?

From what I've seen in the Northern part of our county I say yes—but he would go at it quite differently than the usual commercial operator.

The whole object in fattening a steer is to make it put on weight. Well-larded beef is the kind that has fine flavor, tenderness, and is good and

juicy. Incidentally, the next time a butcher shows you a steak look to see if it has streaks of white running through the red beef. This is fat—and the steak should be good and tasty.

Ordinarily, beef cattle are shipped off the ranches in the West to the Corn Belt where they are put in feeding lots and fed corn and other grains until they are fat enough to slaughter.

A Mid-west farmer buys beef cattle to fatten for market. You can do the same. Usually, for example, a couple of car-loads of Western steers are brought into our County Seat each spring to be sold to local farmers and estate owners. These "feeder" steers are usually from 6 to 12 months old and ordinarily sell for \$8 to \$12 a hundred pounds. Obviously, they're not a cheap investment and you'd do well to fatten a few pigs or some sheep before you try a steer.

In place of the intensive grain feeding program of the Midwest, there is another method that is probably more suitable for the small or part-time farmer. This is the "pasture method." It can be undertaken in two ways:

- 1.) *High-quality pasture may furnish the sole feed.*
- 2.) *Pasture during the grass season and then hay and grain for 6 or 8 weeks to finish off.*

Pasture doesn't make as finished a steer nor is it as fast as dry-lot grain feeding, but it is much cheaper and oftentimes more profitable even though the final beef doesn't bring so high a price. In addition the steer should have plenty of fresh water and a salt lick.

A new device that has made fattening a steer or two more interesting to the small farmer is the electric fence. A single strand of electric fencing is adequate to hold a steer and it is, of course, easy and inexpensive to put up.

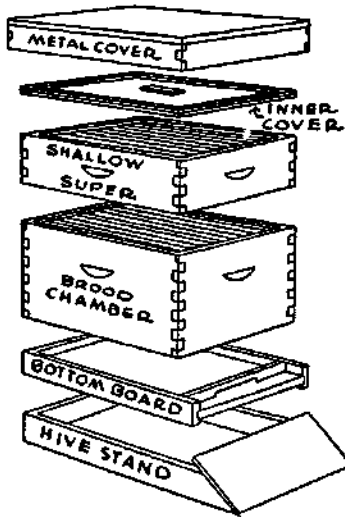
Perhaps, however, the quick-freezer is doing still more to stimulate interest in home production of beef. The home freezer and freezer lockers mean that it is entirely possible for a single family to utilize the 500 pounds of dressed meat obtained from a good-sized steer. Five hundred pounds is not nearly as much as it sounds when you remember that the average annual consumption of beef is 65 pounds per person. If freezer space is limited remember that some cuts can be hung for weeks before cooking. Also you can make some corned beef, smoked beef, dried beef, or use the chuck in delicious canned stews. Another good plan is to divide your beef 50-50 with a neighbor slaughtering his steer one year and yours the next.

# Our Little Sugar Factory

**W**E didn't decide to have bees until we had laying hens, chickens to eat, goats, pigs, and, of course, our garden all producing.

As I look back I believe it was my father who got us interested in the idea of keeping bees. Actually, he didn't know anything about bee-keeping, but every time he visited us he brought along a jar of honey. He liked

## Parts of a Modern Beehive



honey so much and believed it so much more healthful than sugar, he got us interested in producing our own.

We've found out that doctors do recognize that honey is the perfect sweet—it's easier to digest, furnishes a quick source of energy, and, unlike sugar, contains minerals.

Also about this time we were reading a book called *The Farm Primer* in which the author says that a hive or two of bees will increase the fruit yield by 30 percent and even make the fruit taste better. Moreover, he pointed out that a hive of bees requires only 8 hours of care per year and gives about 75 pounds of honey. Seventy-five pounds per hive seemed a lot but I've since heard of single hives producing as high as 500 pounds. Of course, it's unlikely a novice will get as much as that.

One lunch hour in New York, I went down to a bee equipment place. All I meant to do was buy a booklet called "Starting Right with Bees" I was going to read first—and get the bees later. I asked them how much the equipment necessary to have one bee hive would cost. They said, "About \$20—including a queen and three pounds of bees—but right now we have only one complete amateur outfit left."

It seems they were having trouble getting zinc to make bee smokers. This is no longer true. Obviously, if I were

going to have bees, then I'd best sign up for them right then and there. So I made out a check for the works.

Incidentally, somewhat later on in talking to Mr. C. C. Whitehead, one of the best amateur bee-keepers in Connecticut, I found it was his opinion that the only way to learn about bees is to get up your courage and order a complete beginner's outfit as I did and then you'll just have to learn or else—

One of the nice things about bees is that if you sign up for a beginner's outfit in January to March, you'll learn a good deal before the bees arrive.

That's because your outfit arrives in two shipments. The first shipment is equipment—later, sometime in April, depending on the weather, the queen and three pounds of bees—about 15,000 of them—arrive.

In the first shipment, you get a smoker, bee feeder, hive tool, bee veil, a booklet of directions, a year's subscription to a bee magazine, wax foundation; plus a hive, a deep super and two shallow supers, knockdown.

We spent about three evenings assembling the bee hive and supers—unassembled, 200 odd pieces look like a jig-saw puzzle. Each piece is so perfectly cut, it's fun putting them together.

The hive is simply a box-like structure. At the bottom is a stand with an alighting platform. Set on top of this is the bottom of the hive—3 or 4 boards cleated together to make a floor. Upon this rests a large oblong box without top or bottom. This is called the hive body or brood chamber. In it are hung ten wooden frames each one holding a patterned sheet of wax. The bees draw these sheets of wax into cells. In the cells the young bees are hatched.

On top of this large box you eventually place a shallow box, maybe two or three. These are called supers and like the hive body each hold ten frames. The honey stored by the bees in the hive body must be left with the bees for winter food. But the honey stored in the supers can be taken away and extracted. A queen excluder is placed between the hive body and the supers to keep the queen from laying eggs in the supers. On top of the super—or supers—for they may be piled one on top of the other—is an inside cover. Then over all is the tin-topped wooden cover which telescopes down over inner cover and top super to make the hive waterproof.

All the above—hive, supers, bottom, inner cover, frames and sheets of wax are sent you in pieces—and you put them together. Very complete directions (printed in about seven languages for a bee hive is standard throughout the world) are provided. We had a little difficulty putting the hive to-

gether because our playful kitten chewed up the directions, but we still made out all right.

By the time you get the hive together and painted, you'll understand a little something about the art of bee-keeping. You'll also have a chance to study up on what to do when the bees arrive.

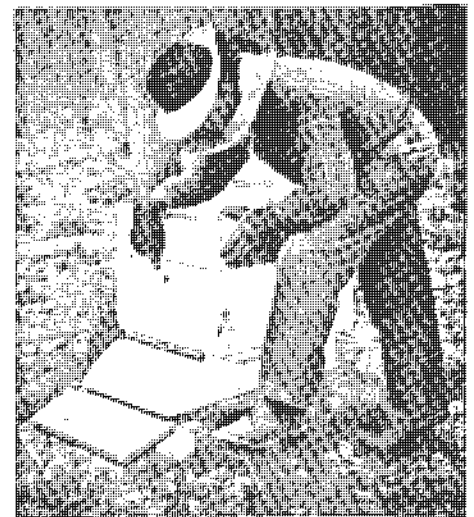
Let me tell you, you'll get a real thrill when you come home some day and find the second part of your order—a screened box about a foot square crammed full of 15,000 buzzing bees.

I'd read that anyone can handle bees—if they do it properly—and not get stung. But I'll admit I had my doubts the evening Carolyn took me into the garage, pointed to the cage of buzzing bees the expressman had brought and said, "Well, do you want to put the bees in the hive now or after supper—remember, that's your department!"

I confess I postponed putting the bees into the hives until after supper. I also sneaked upstairs for a last reading of the chapter "How to Install Bees in a Hive".

Well, after supper I set up the hive and carried the caged bees out to the uncovered hive. I wore the bee-veil, but no gloves. It wasn't that I was being brave, I just couldn't find a pair of leather ones.

In opening the cage, I spilled the syrup can that goes along with the bees—spilled it all over my hand and about 3,000 bees tumbled out after it. Before I knew it my hand was covered with crawling bees. For about ten seconds I stood perfectly still. Then, suddenly I realized I was not being stung!



Pointing to the top entrance. In late years this second entrance, especially in the north, has demonstrated its advantages. It saves the bees from death in case bottom entrance gets clogged with snow or dead leaves. Also provides better ventilation.



At first Carolyn would have no part of the bees. Later, she learned you can handle bees without getting stung. Note "frame" of honey.

The bees were happily lapping the sugar syrup off my hand—that is, the two or three thousand that could get a lick in. I began to think again and remembered to put the opened cage inside the hive. Then, somehow, I brushed the bees off my hand into the hive, released the queen, put the cover over the hive, and went to the house.

Mrs. R. had been watching me from the kitchen window. I came in, undid my veil and tossed it onto a chair.

"Didn't you get stung?" she asked.

"Of course not—why should I?" I replied, shrugging my shoulders.

Right then and there I *did* get stung. It seems that one lone bee had crawled from my hand, up my arm, and when I shrugged my shoulders, I pinched her—and she let me have it.

I've dwelt at some length on the way I felt handling bees for the first time because so many people are missing the very real benefits they can have keeping bees because they are afraid of being stung.

All the rest of the year I was stung only twice. Both stings were due to my own carelessness. For example, one day I had been working hard in the garden in the hot sun. In fact, it was so hot that I wore only dungarees. Suddenly, I remembered I should feed the bees some sugar water. I carried it over to the hive, not stopping to put my veil on—or even a shirt. I opened the hive, flipped off the cover, bent over to pick up the Boardman bee feeder and had no sooner straightened up when I was stung by three bees. That was my fault for being so brisk and blowing my hot breath on the bees.

One other time I pinched a bee and she stung me. But by then I'd learned to rub, *not pull* the stinger out. And by getting the stinger out *fast* the sting was hardly more than a mosquito bite. With my veil, and gloves and handling the bees properly, I don't get stung.

For quite some time—from the middle of April when the bees arrived until the first honey flow in June—I fed the bees a mixture of sugar and water. This is fed by the bee feeder which

holds an inverted Mason jar with its zinc top perforated.

After the clover blossoms, the first real honey flow is on and the bees make their own honey. You'd think it might be smart not to get your bees until the honey flow started so you wouldn't need to feed them sugar-water. But the reverse is true. Although 15,000 bees sound like a lot of bees, they're just the nucleus of the hive. A strong hive builds up to three or four times this size. A few days after your bees arrive, the queen should begin producing eggs—at the rate of 2,000-3,000 a day. These eggs are attended by the 15,000 bees and the eggs begin to hatch 16 to 18 days later. So if you get your bees in April your colony should be built up to a fair size when the first honey flow starts in June.

For the first two or three months after our bees arrived the only help we had was from our books. I well remember one line in a book that proved comforting again and again—"The amateur is apt to err by giving the bees too much attention." So whenever I was in doubt about doing this or that I didn't do it.

This system worked fine until one evening when I arrived on the 6:42, Mrs. R. said, "Well, a phenomenon of nature took place today—"

I didn't like the way she said it. "What do you mean?"

"You guess," she replied.

"Jackie has started to talk."

"No."

"One of the geese laid a golden egg."

"No—your bees have swarmed."

Sure enough, in our back yard way at the top of the highest tree was a huge swarm of bees. My wife said she'd heard them come out of the hive around noon—they sounded like a squadron of high-flying airplanes, and after flying around a bit they'd clustered at the top of the tree.

It so happened that very morning a fellow commuter had told me about a neighbor of his, a Mr. Whitehead, who was an expert bee-keeper. All I knew about swarming was that bees don't usually stay around long after they swarm—sometimes only a half-hour. So I telephoned Mr. Whitehead.

Mr. Whitehead calmed me down—told me he'd lend me another hive. Then said that I should take a ladder, climb the tree, cut the branch on which the bees clustered, take it down and hang the bees on a clothes-line overnight. All this I did—incidentally without getting stung. The cluster was a foot in diameter and three feet long.

The next morning I got up at 5:30 A.M., spread a sheet on the ground in front of the newly set up hive, shook the bees off the branch and watched them stream into the new hive. Two hours later the last of them were marching into the hive—and I now had two hives of bees, for there was quite

a colony still left in my original hive.

Right here I'd like to say that Mr. Whitehead has since taught me a lot about bees. Incidentally, one of the real pleasures of bee-keeping is getting acquainted with other folks who keep bees—they are a fine bunch of people.

If you're really interested in starting in with bees, visit a beekeeper in your locality—tell him you're thinking of getting a hive of bees and see if he won't invite you over to his place to watch him open his hives. If you can, spend a few hours with a beekeeper and if you will read *First Lessons in Beekeeping* you should get along fine.

It wasn't until some time after we got our bees that we found out that we could not expect much honey from them the first year particularly because we let them swarm. The reason for this is simply that the bees have all they can do to draw the wax foundation into cells plus raising the young bees and storing enough honey for themselves. Our bees had stored up over 60 pounds of honey their first year which we left them to eat over the winter. We took only four or five pounds for our own use. The second year we had about 60 pounds of honey for our own use.

Bees are one of the most fascinating things you can have. They require only a few feet of space, gather their own food, and need only 8 hours care per hive a year. You can have bees even if you live in the city. I know of a beekeeper who lives in Brooklyn.



A honey "extractor" is used to whirl the honey out of the comb. Jackie and his friend were glad to sample each batch.

# Have More In Winter, Too!

**N**OW we come to a part of the "Have-More" Plan that probably gives Ed and me the most satisfaction of all—preserving food in various ways so that we "live off the fat of the land" all year round.

Food preservation also has very practical compensations. Vegetables cleaned and prepared in the summer or fall save hours of shopping and of preparation in the kitchen during months to come. Furthermore, home preserved food costs less. For example, our home preserved tomatoes cost us about 5¢ per quart.

Folks today are lucky to have two wonderful modern ways of conserving food: quick freezing and pressure canning—besides that dependable old stand-by, the root cellar. One obvious rule applies to them all: use only the best of your fruits and vegetables, those just ripe and free from blemishes. If you take tough old string beans and freeze or can them, you're still going to have tough old beans. At first it hurts to throw away even one bean you've raised. But it isn't long before you realize you have plenty of the best and you can afford to give the few tough ones to the pigs or chickens.

If you want to keep your preserving to a minimum, enjoy your food to the fullest extent while it is at the height of its season instead of trying to have something different every day of the week. We certainly do not get tired of eating sweet corn nearly every day for weeks when it comes fresh from our own garden.

To show you how we have a lot of variety in our home-grown food with the least effort, here is a list of foods we emphasized, each in season. We

don't claim we ate only these items at these times, but we used them primarily—we supplement our home-grown list with things we don't grow, for instance, seafood, beef, etc.)

## SUMMER (July-September)

Fresh garden vegetables—tomatoes, peas, string beans, lima beans, beets, corn, cucumbers, lettuce, summer squash, egg-plant, new potatoes, etc. Fresh fruits, raspberries, strawberries, blackberries, etc. Broilers, roasters, rabbit. All kinds of frozen meat (from winter killing). Milk, butter, cottage cheese, eggs.

## FALL (October-December)

Root cellar vegetables—cabbage, beets, carrots, turnips, Hubbard and acorn squash, potatoes, Jerusalem artichokes (leave in ground). Greens still in garden: kale, broccoli, chinese cabbage, collards. Stored fruits—apples and pears. Baked beans and stews. Chicken, fricassee or pies (culled hens), broilers and roasters. Other fowl—(geese, turkeys, ducks). Lamb, chevon, rabbit. Milk, eggs, cheese.

## WINTER (January-March)

Vegetables and fruits—rest of those stored in the root cellar—some canned and frozen vegetables, fruits. Fresh pork or chevon, smoked hams and shoulders, sausage, bacon. Frozen or fresh chicken. Other fowl (as you cull). Rabbit.

## SPRING (April-June)

Vegetables and fruits—canned or

frozen. Spring garden greens, such as dandelions, beet tops, asparagus. Fresh rhubarb. Jerusalem artichokes, and parsnips left in garden over winter. Radishes, lettuce. Hams and bacon (cured in winter). Baked beans. Broilers, frozen or fresh. Other meats from freezer. Milk and eggs.

While we're making lists, here's one you'll find helpful in deciding whether to store, can, freeze or dehydrate the various vegetables from your garden.

*Easy Storage:* potatoes, carrots, beets, onions, winter squash, turnips.

*Best for Freezing:* all meats and poultry, snap beans, shell beans, lima beans, asparagus, peas, corn, all greens and berries.

*Best to Can:* tomatoes, snap beans, shell beans, soy beans, peas, corn and some fruits depending on your own likes.

*Most Successfully Dried:* soy beans, lima beans, kidney beans, peas, corn, onions, some fruits.

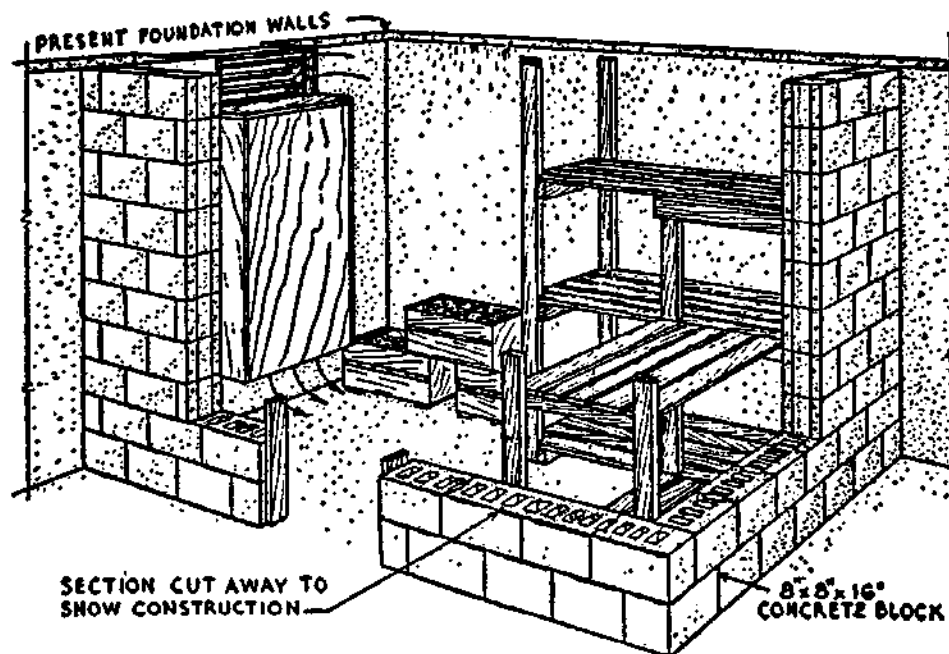
## Cold Storage or Root Cellar

It so happens that the old trick of putting away root vegetables and some fruits in a cool, moist place is both easy and cheap and for certain things the best way to store.

The necessary conditions are a cool, moist atmosphere (temperature 35° up to 45°), darkness, and protection from rats and mice.

We are unfortunate in having a very small basement. What we would have liked is a cellar storage section about 10' x 6' and at least 6' high, for standing room and plenty of shelf space. A section of the basement can be walled off with economical concrete blocks or insulating board. Good insulation and a close-fitted insulated door are most important, especially if you have a furnace in the basement. A small window is also necessary in order to control the temperature within the storage unit. An earthen floor is best—it gives your storage the proper humidity. If you have a cement floor you must sprinkle it with water every day or two, or keep a bucket of water in the room. In basement storage it is also best to pack carrots, beets, and other root vegetables (except potatoes) in a barrel or crock with damp leaves or sand.

But don't hurry your harvesting to put the vegetables in storage. It is the early part of the storage period that is most dangerous. It's hard to get the temperature down to 40° or less when the weather is still warm so leave root crops in the soil until the ground is almost ready to freeze. Tomatoes, onions,



A Good Storage Cellar for Vegetables and Fruit.



squash and pumpkins, of course, have to come in before the first killing frost.

Squash, pumpkins and dry beans keep best in the attic, if you're lucky enough to have one that's warm and dry. Onions should be kept cool and dry.

Lettuce, spinach, broccoli, cauliflower, brussel sprouts, collards, kale and Chinese cabbage are hardy enough to survive light frosts and can even be left in the garden long after frosts if they are given protection with straw. We have been surprised how long you can eat right out of your garden, even in our cold New England climate. At times we have had some of these hardy vegetables in the garden until December. We've found, too, you can save your full-sized green tomatoes — just pull up the whole vine before the first frost and hang, or store the tomatoes in small baskets. They will gradually ripen if kept in a warm (not hot!) place.

But don't make one mistake we did! We didn't weed out the poor specimens at first and we lost a lot of our precious vegetables.

Bank storage space—if you have a hill handy—can be made with concrete or heavy lumber walls and ceiling. It should be at least 6' x 5' x 5' high and covered with 3 feet of dirt. No extra moisture or damp packing is necessary. In fact, getting plenty of drainage is the main problem along with keeping out vermin.

There are other methods of storage: sinking a barrel upright in the ground which is not too satisfactory because it holds so little. Another is the trench method which is simply digging a trench below frost and lining with straw; vegetables are then added, and all is covered. Obviously, it's not easy digging vegetables out and you can't check up on them easily.

For people with small cellars like us or for those of you who are planning new houses with radiant heating (which doesn't require expensive cellar space), it might be possible to have shed-type storage space attached to the garage. Of course, the walls would have to be insulated, as with the other methods, and the thickness would have to be determined by the material you used. We have not tested out this idea but it would seem to be a workable plan.

Obviously, cold storage is such an easy way to conserve food that it is probably the first method you will want to take advantage of.

## Hub of The Homestead THE FREEZER

If you could take a peek in our freezer today, or any day, you would see an amazing, wonderful assortment of delicious foods. For on our miniature farm, nearly all activities lead to the freezer. Into it goes almost any-

thing and everything we can raise, plus items we buy. And the food comes out fresh whenever we want it—summer or winter. No other method of preserving food has ever made such a happy situation possible.

From the standpoint of abundance, we have eaten better on our homestead than we ever have before — and that includes the war years of scarcity and rationing. The chicken we take out of our freezer is tender, delicious. Yes, we have corn-on-the-cob and lush raspberries in January, and goodtasting greens as well as lots of other things from our past year's garden . . . and it tastes as good as it did fresh out of the garden.

Ed and I both believe the quick-freezer is one answer to man's long search for a way to harness the bounty



of nature. At any rate, we know it's a way ordinary people like us can have more security and independence than we ever thought possible.

The freezer was one of the first big capital investments we made and after using it, it would still be the first if we were starting over again. Ed loves to say that if you want to get your wife interested in homesteading, just get her a freezer. I must admit it helped intrigue me with country living and now I'm glad it did, for I would never go back to the city.

A freezing cabinet cuts your cost of living and at the same time raises your standard of living. Even if you did not raise any of your own food you could buy fresh vegetables, fruits or meat in quantities at wholesale or seasonal prices and store them away. The cabinet should eventually pay for itself from your savings in such buying. It costs

very little to run a freezer—about the same as an electric refrigerator.

Of course, if you raise your own food the savings are even greater. If you hunt or fish, you can put away some of your favorite wild duck or fresh trout for the time you couldn't otherwise enjoy such delicacies. Or you can even make some good trades with your friends—we have swapped some of our home grown fowl and meat for such tasty things as newly dug clams, fresh fish and that rare treat, venison.

You already know that in comparison with canned foods, many frozen foods taste better, look better and have more food value. We have even found that vegetables and fruits frozen immediately after picking are better than the so-called "fresh" stuff you buy in the market. When you stop to think how many hundreds or thousands of miles an out-of-season tomato or cauliflower travels to meet you you realize that the word "fresh" may mean a variety of things.

As a home-maker I have found there are many, many pleasures connected with our freezer besides its unequalled service in preserving foods. A freezer saves a tremendous amount of shopping time because you have your own little storehouse of vegetables, fruits and meats, ready to use. If you find you need a lot of fresh bread and don't make your own, you simply buy a large quantity and freeze it. What's more, you can freeze stale bread and when it defrosts, it's fresh again. Practically a miracle, isn't it?

A freezer has fascinating possibilities. Every fall we freeze lots of sweet apple cider at a cost of 2¢ a quart for morning fruit juice, or it's elegant for hot, mulled cider on a winter's evening. Also when I make stews, soups or home-baked beans, it's just about as easy to cook double or triple the amount needed and freeze some for future use. You can also freeze cakes and pies—or the dough to be used for pies and cookies. There seems to be no limit as to what a freezer can do.

If you are preserving your own foods, you'll find that freezing is far easier than canning. To show you how simple it is, here are the steps involved in freezing green peas:

1. Pick the peas from your garden.
2. Shell and wash the peas, discarding old or imperfect ones.
3. Blanch peas. That simply means placing peas in a colander or wire basket and immersing them in rapidly boiling water (at least a gallon to a pound of peas) for one minute.
4. Then immediately immerse peas in cold running water.
5. Drain and pour peas in to a moisture-vapor-proof bag or container and seal.
6. Place package in freezer.

Quick freezing fruits is absurdly simple. Take strawberries for instance. Remove stems, wash, cover with sugar-



When guests come in unexpectedly for meals, Mrs. R. can serve a wonderful dinner on short order, complete with half-a-dozen meat choices, corn-on-the-cob, and fresh strawberry shortcake. If you want to interest your wife in home food production, plan to get her a quick freezer.

ers widely distributed will make as phenomenal a change in this country as did low priced cars. With a good freezer and a little piece of land you can be just about as independent and as secure as you wish. The freezer can be the secret of one goal all we Americans constantly work for—freedom from want. Anyhow, that's what our freezer means to us.

## Home Canning

There was a time when practically every article written on canning started out with the old saw—"Eat what you can—and can what you can't."

Today, that's so far from reality it isn't even funny. Of course, you eat all you want during July, August, September and October directly from the garden. Then, as we've pointed out, it's easiest to utilize a root cellar. Next is preservation by freezing—if you're lucky enough to be able to use this wonderful new method. Then comes canning.

In all frankness, it is best to preserve certain things in glass jars—tomatoes, sauerkraut, pickles, stewed fruits, preserves and jelly. But canning, even with a pressure cooker, is more difficult than freezing and the results, minus the exceptions noted, are, we think, inferior to freezing.

I will say that the savings in canning your own fruits and vegetables instead of buying them is tremendous. I know that's contrary to what we've been told, but it's true because you do it all on your own place—you don't pay for all the traveling raw vegetables do to get to a factory and back in cans to grocery shelves. Take the popular tomato as an example—here is the cost of our 75 quarts of home canned tomatoes the best we can figure it:

Plants .....	\$1.00
Spray .....	.25
Jar tops .....	.75
Jars (amortized on 10 yr. basis)...	.45
Cooking (coal stove) estimated ....	.25
Spices .....	.05
	<hr/>
	\$3.25

75 quart commercially sell at 22¢ each—\$16.50  
Our Savings: 80%.

And we do not blush at saying our tomatoes are superior to what you can buy in taste, color and texture!

Prejudice had been built up against home canning by making it appear to be a back-breaking complicated chore. But we have found it fun by doing only a few jars each day in the summer instead of trying to do it all in a few days. It is pretty simple, especially with the help of the booklets put out by the canning jar companies. We happen to have a Kerr booklet (Kerr Glass Manufacturing Co., Huntington, W. Va.) which cost 10¢ and which led us successfully through all our canning, though neither Ed nor I had ever canned before.

Canning is not complicated but it

syrup, package, freeze. When it comes to meats, it's nothing at all once the meat is cleaned and cut, ready for cooking. Just wrap and freeze.

There is a wide assortment of containers made especially for freezing—that is, vapor and moisture proof. I won't describe these here, for you will have to get a bulletin or book with complete directions if you are going to freeze foods.

We bought our freezer shortly before Pearl Harbor and paid \$440 for it. It is a 13 cubic foot cabinet and holds approximately 700 pounds of food. The price we paid was high, but few freezers had been made at the time we bought ours. Now, many large companies are building them, with mass production the price is lower; \$230 for one similar to ours.

Many people have been using frozen food lockers which have rented for \$6-\$15 a year. If the locker plant is situated conveniently to your home, you may prefer this method of having a frozen food supply. A locker plant usually offers the convenience of packaging and cutting meat for you and also provides a place to hang and cool meat before freezing.

However, I personally prefer a quick-freezer at home where I can tuck away a few boxes of fruits or vegetables or a small quantity of meat as I find time to prepare them. When you are raising large quantities of your own food, it

may become practical to use both a home freezer and a locker, as you would then have the convenience of both arrangements. Or another plan would be to build (or have built) your own freezer room and cool room.

From our own experience we have learned several things about buying and running a freezer. We made a serious mistake in placing our freezing cabinet in our garage where the temperature drops below freezing in the winter. We discovered that such low temperatures prevent the motor from operating properly, so we now have it in our "Harvest Room." After having our freezer break down once and losing some of our hard-earned foods, we know now that there should be some signal to warn you when the temperature rises above the danger point. There should also be instructions fastened on the freezer to tell you when and where to oil the motor. These things we learned from our one bitter lesson and we wanted to pass them along. It pays to buy a good cabinet from a reputable dealer and with so many new designs developed during the war years it will be wise to look over a number of freezers before choosing yours. Whatever your intentions are on using a freezer, we would certainly recommend getting one with a special compartment for quick-freezing your own food.

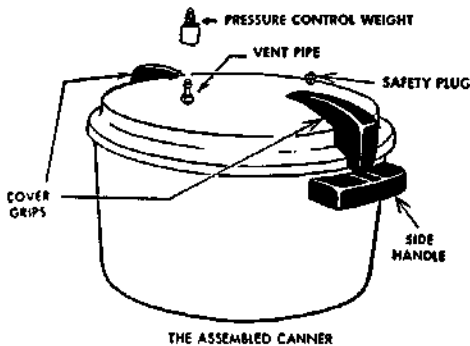
We certainly believe that food freez-

does require accuracy. To make the work easier, get all your equipment ready to use before you actually prepare the food. And by all means do your preparatory work in a pleasant place. At first we did ours on our back terrace, but now we have our delightful "Harvest Room."

It is usually suggested that you plan 100 quarts of fruit and vegetables for each member of your family, but if you are seriously trying to be self-sufficient and are preserving food only by canning we believe you would want somewhat more. However, the first year aim for the 100 and the next year you'll be able to adjust the amount to your own needs. The 100 quarts should be approximately divided into one-third fruits, one-third vegetables and one-third tomatoes or tomato juice.

That figure sounds rather forbidding doesn't it, from the standpoint of quantity and time to preserve? Let's take up the question of quantity. In the case of apples, one bushel produces about 20 quarts; cherries, 24 quarts; peaches, 25 quarts, plums, 30 quarts; berries, 24 quarts. That is a good deal more of each fruit than any one person will eat during the non-productive season. So

### Pressure Canner.



to achieve your goal you would only have to can a few quarts of each fruit as it came in season. The same principle applies to vegetables.

As for canning equipment, by all means try to get a pressure canner. It is recommended by all authorities as the safest way to can your vegetables properly and it saves time, fuel and work.

Still unknown to thousands of families the pressure canner is also a miraculous cooker. It will cook a complete meal in 10 to 15 minutes, including soup, roast and vegetables! Using little water, it saves valuable vitamins and minerals. It tenderizes cheaper cuts of meat. It can preserve surplus meat, poultry or fish, although we believe that the quick-frozen method is best.

As for pressure cooker size you will want an 18 quart canner (holds 5 quart jars) or a 25 quart size (7 jars). With the canner you will receive a booklet giving you a time table for processing and general directions for canning.

Even if you don't go in for all the "Have-More" Plan, we believe in "canning all you can" anyway—and that goes for peace time as well as during a war or a depression. Believe me, it will give you a tremendous feeling of satisfaction and security when you begin to line up the jars on your shelves. Ed is just as proud as I am to point to the canning shelf and say, "I canned those bread and butter pickles." Such bragging is good for the soul—it's one of those intangible satisfactions you get from homesteading.

### Salt Some Away

Another easy way to keep certain vegetables is to salt them down. The one big fault with this method is that it destroys a lot of the vitamins and minerals. For this reason we have not done any brining (except to make sauerkraut, ham and salt pork).

Everybody knows about salting cabbage to make sauerkraut. I put mine up in jars as I have found this even easier than the crock method. It is also possible to salt away corn, beans, cauliflower, turnips and peppers.

Alternate layers of washed vegetables and salt are packed into earthen crocks and weighted down. If enough brine to cover vegetables completely is not formed, a concentrated brine made with boiling water may be added. Use  $3\frac{1}{4}$  cups of salt (common or coarse salt is better than fine table salt) to 6 quarts of water. Keep in a cool place—the vegetables are ready to use at any time.

To desalt for use, put salted vegetables in a big pan, cover with cold water, heat to luke warm, stir and pour off water. Repeat until vegetables are only slightly salty. Then you can cook in regular manner.

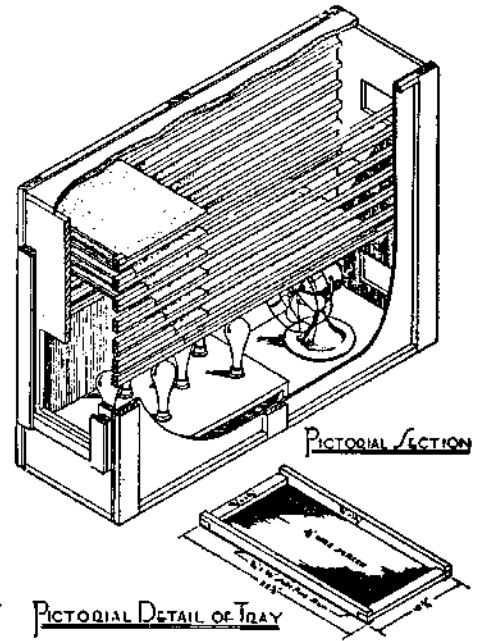
### Dehydration

During the early part of the war I read a lot of articles telling how wonderfully easy it was to dry your vegetables and fruits at home. Well—in our attempt to carry out miniature farming in the easiest, most modern way, we borrowed one of the very best home model dehydrators which set back one of our neighbors about \$40.

We soon found that proper dehydration is not so terribly simple after all. It takes as much preparatory work as canning and it is more difficult than freezing foods. We think its worst feature is the long drawn out drying process. It takes 10 hours just to dry the food thoroughly; you can scarcely complete the project in one day.

In our section of the country where there is much moisture in the air, dehydrated food should be packed in tightly sealed jars so it won't absorb water again until you use it. And when you do, dried food takes pre-soaking to return it to its normal state.

We do not believe home dehydra-



One Type of Dehydrator.

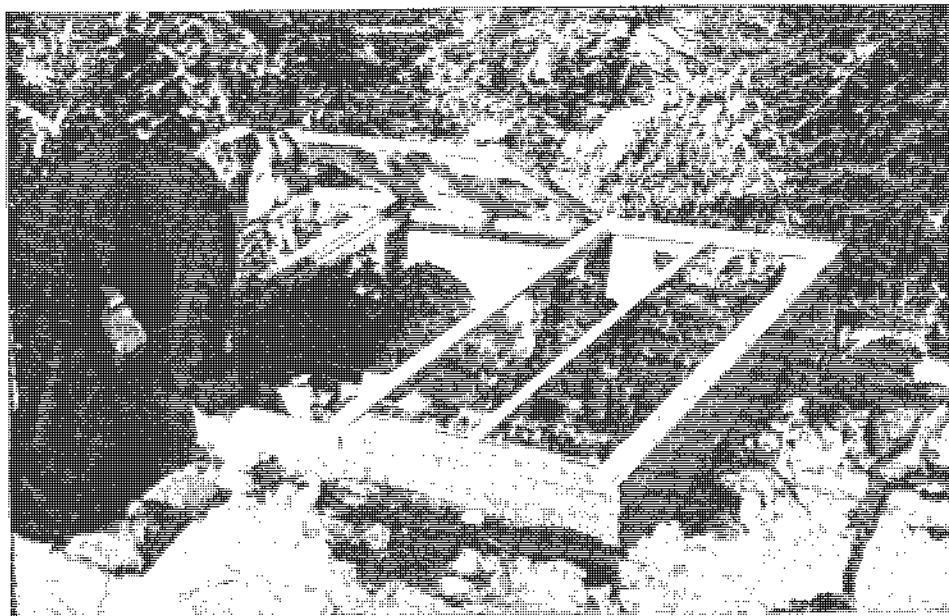
tion will ever be widely used in America except where it is specifically desirable for reasons of taste, geography or space. Frankly, we couldn't stand the taste of the three things we tried—snap beans, spinach and broccoli. But if your family is extremely fond of dried beans and peas then it would be worthwhile to dry them. Also, we all know that certain fruits are splendid dried.

If you are interested in drying foods, we suggest you try it out in your cooking oven first and see if you like the idea. You'll get about the same results you'd get with a special machine. Place oven door open and set the temperature at 165°. You'll have to get the length of time for drying your specific vegetable or fruit from an instruction booklet. Then freshen up the dried samples, cook them and see if you like them. If you do approve, you can either buy or build a dehydrator.

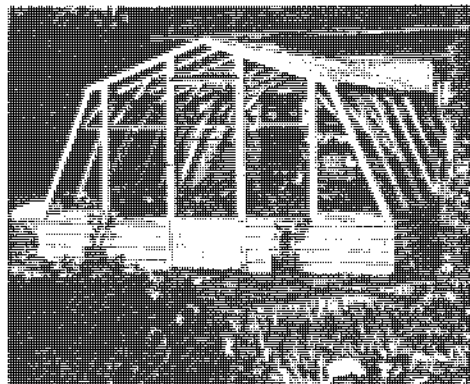
You can build a dehydrator using a small electric fan and a bathroom heater but the thermostat is quite important. It is probably just as well to buy the whole dehydrator or else use your oven. Detailed building plans may be obtained from your County Farm Agent.

We'd suggest you read a little booklet called "Dehydrating Fruits and Vegetables," put out by General Electric Company, Schenectady, N. Y. It costs 10¢ but it is well worth reading before you decide to go in for dehydration.

# WINTER GARDEN—Cold Frame, Hot Bed, Small Greenhouse



Hot bed made with new-type, small-size, putty-less sash. A hotbed is simply a cold frame heated by a bottom layer of manure or an electric heating unit.



(Left) A small greenhouse may be attached to the house and heated by the house furnace.

(Below) Interior of a small greenhouse that can be bought for \$300. This new Lord & Burnham greenhouse has automatic temperature control and automatic watering.



**W**HEN we first produced our own vegetables, we looked into starting plants under glass. Because this seemed complicated and because we had only about an hour or so of spare time a day to devote to our food-raising activities, we decided we'd buy our plants from a good local greenhouse.

The main reason for growing plants under glass in all of the U. S. (except for the extreme Northern States with their exceptionally short growing season) is to spread the products of your garden over as long a period as possible. Once you have a freezer, glass gardening isn't nearly as vital.

Probably you've read about the new small greenhouses with automatic watering and temperature control that sell in the neighborhood of \$300. We talked to the manufacturer, the Lord & Burnham people at Irvington-on-Hudson, N. Y., to find out if these were economical and practical. Here's their answer:

"Frankly, from a straight economic point of view we cannot justify a greenhouse in a 'Have-More' project—we would not attempt to, any more than you can justify the purchase of any luxury on straight economic grounds.

"For an ardent amateur gardener, a greenhouse has a different appeal. It permits him to keep his hands in the soil all winter; it permits him to have the satisfaction and pleasure of growing plants and flowers. The best satisfaction comes to those specializing in bringing in unusually fine quality of some particular specie or variety. Then the greenhouse owner can raise plants for setting out in the spring and do it easier and more satisfactorily than in a hotbed or cold frame."

I do think it was pretty fine of these people who sell greenhouses to give us such an honest estimate. They just don't believe a small greenhouse will "pay for itself" on the average homestead. It seems that the value of a greenhouse depends largely on how far north you live. If you live where the grocery stores carry most summer vegetables all winter it probably won't pay you to grow vegetables in a greenhouse.

Commercial growers north of New Haven and especially up past Springfield, Massachusetts into Vermont and New Hampshire can make a greenhouse pay on just one tomato crop. Further north, in Ontario, Canada, it is easier for a commercial grower to make a sure success with winter vegetables.

If you think you'd like to have a greenhouse you might consider attaching it to your house. This lowers the heating cost considerably. I know that Fred Rockwell, editor of *Home Garden*, has a greenhouse hitched to the southeast corner of his house. The greenhouse is heated by the same furnace that heats the house. This is an economical arrangement because on sunny winter days the greenhouse absorbs a lot of heat and contributes this extra heat to the house. Fred says this system works so well his fuel bills are no higher than before he had his greenhouse.

# Grow Your Own Fish

**H**AVING a fish pond in your back yard seems almost too good to be true. But Government experts say you can easily build a pond for as little as \$100, and that a one-acre fertilized pond will normally yield by hook and line "something like 40 or 50 one-pound bass and about 600 to 800 quarter-pound sunfish each year".

We were surprised to learn that you don't need a stream or brook to have a fish pond. In fact, experts say it's better not to build your pond by damming a brook because the pond is too easily destroyed by floods. They recommend excavating a naturally low area using the run-off from the surrounding terrain as the source of water. Or you can use a spring or well. The pond should be 6 to 12 feet deep to protect the fish from freezing and possible drought.

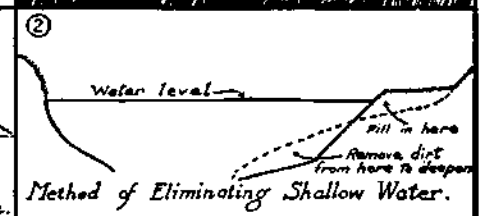
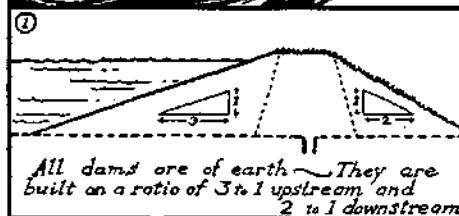
Over 7,000 farmers grow fish in their own ponds. You stock a fertilized pond in Spring or Fall with fingerlings of bluegill sunfish and large-mouth bass and you can fish them out after 4 to 12 months. The fingerlings are obtained free or at a small cost from State Hatcheries or from the U. S. Fish and Wildlife Service. Some states, Ohio for one, will practically build the pond for you.

To keep plenty of fish growing in the pond the experts have worked out a fascinating "food chain". First you distribute about 100 pounds of regular 8-8-4 crop fertilizer in the water. After a few days the water will take on a brown or greenish tinge which means the fertilizer has caused the growth of microscopic plants called algae on which young sunfish thrive. Then (in Spring or Fall) stock a one-acre pond with about 800 fingerlings of sunfish and 100 of bass. The sunfish live on the algae and the bass live on young sunfish. This food chain will continue producing fish year after year so long as you keep the pond sufficiently fertilized and do plenty of fishing! It's impossible to catch too many fish by hook and line. In fact not fishing out enough sunfish may result in too many for the amount of algae and the sunfish won't grow to eating size. The same will happen if there aren't enough bass to eat the young sunfish. For more variety you can also grow bullheads, pickerel, and other fish, but stocking must not be done indiscriminately or it may upset the whole balance in the food chain.

A permanent drainpipe in the dam facilitates draining; if pipe is large enough fish pass through so you can catch them the "easy way." Young trees, shrubs and grass planted around the pond make cover for wild life.

P. S. from Carolyn R.

Personally I don't want to go swimming in any old brown water full of algae, but as a fish pond it sounds wonderful and I hope we can build one!



# The Woodlot

ORIGINALLY our house was located in the midst of two acres of woods. As we've cleared our land, we've had plenty of firewood.

It's a good idea to have an acre or so of woods. Just the dead and fallen timber will give you about a cord of wood per acre each year for your fireplace—and some fence posts too. Maybe you can harvest some lumber—it's much cheaper to haul it to a local sawmill than it is to buy lumber these days. About 6 months of exposure to sun and air is necessary to dry green lumber.

A woodlot is little trouble. Here is a simple program that will help you keep your woods in good condition and at the same time provide you with firewood and some lumber:

- 1.) Fence out livestock. They eat saplings, injure young roots, cause erosion, and in time can ruin a woodlot.
- 2.) Take all diseased or down trees for firewood.
- 3.) Practice *thinning*. This simply means cutting out the weed trees and "crowders" so the good lumber trees will grow faster. It should be done about every two years. Save what you cut out for fenceposts, bean poles, etc.
- 4.) Prune off excess branches on lumber trees to prevent knots. Save these branches for firewood. Learn to recognize your valuable lumber trees, and mark them with a band of white paint.
- 5.) Harvest every lumber tree before it becomes over-age. You should learn the proper size tree to cut. Government studies show a 9 inch maple will bring only 1/36 of the price paid for a 26 inch maple. The profitable way to sell is to make the cutting yourself and haul the logs to the mill.
- 6.) Plant seedlings in any bare patches you find in your woodlot. Trees will grow in the poorest possible soil where no crops can be grown.
- 7.) If your trees are attacked by blight, disease, or insects, ask advice from your State Forester, or County Agricultural Agent.
- 8.) Protect your woods from fire!

For construction on your place you can hire (or borrow) a portable sawmill to come to your woodlot and saw up lumber trees there. This will be a lot cheaper than buying lumber. Whatever you do, never cut an entire stand of trees. Leave at least 5 large seed-producing trees per acre, and plenty of saplings and younger trees.

## Fence Posts

Soft woods such as willow, soft maple, beech, and box elder will last only 3 to 5 years in the ground as fence posts. But you can make them last 20 to 25 years by boiling the lower ends in a steel drum of creosote. Let them cool in a second drum of creosote for best results.

## How Much Is A "Cord"?

A standard cord is a stack of 4-foot lengths 4 feet high and 8 feet long. However, firewood is usually cut in shorter lengths so a "cord" of firewood

may not be a standard cord. If you have occasion to compare different prices for a "cord" of firewood, it's a good idea to get the measurements, so there is no misunderstanding.

## Clearing

By all means don't try to save money by buying wooded land and clearing it to make your garden or pasture. Clearing is really tough work and it's expensive no matter what method you use. You have a choice of four methods of removing stumps (after you've cut down the trees) and you'll probably have to use *all four* ways on some of the big stumps before getting them out! The most primitive is to dig and grub the stump out with a pickaxe and axe. It's a long tough job. Allow at least 1/2 a day to dig out a 6 inch stump this way. A quicker way is to burn them out, using a portable burner which you may be able to borrow from a neighbor. We burn out small stumps this way in less than 2 hours. The burner has a strong forced draught which produces intense heat. However, it doesn't burn all the roots—you have to chop them out. Blasting is another way. Small stumps can be blasted entirely out of the ground and large stumps can be loosened up this way and then pulled out with a block and tackle or a patented pulling device hitched to a team or tractor. For details and safety precautions on blasting write to the Superintendent of Documents, Washington, D. C. for U.S.D.A. Bul. #191.

All in all, I really believe the best method of clearing is to hire a bulldozer. It's amazing how much damage a bulldozer can do in a short time. In just eight hours the bulldozer we hired (at \$5.00 an hour) cleared about 20 stumps, 2 big boulders, and did all the grading and filling necessary to give us a good level half-acre garden plot.

## Erosion Control

If you have waste land where the soil is too poor for crops, you can grow trees there. They'll take many years to grow to maturity but meanwhile they prevent erosion, add beauty to your homestead, and increase its value. (In some localities you will be assessed slightly higher taxes for the acres you plant to forest, but they're worth it.) Your State Forestry Department may provide free seedling trees.

## HEATING VALUE TABLE

GOOD	FAIR	POOR
Hickory	Chestnut	White Pine
Beech	Hemlock	Cottonwood
Locust	Catalpa	Aspen
White Oak	Box Elder	White Spruce
Ash	Butternut	White Fir
Birch	Soft Maple	
Sugar Maple		
Elm		
Black Walnut		
Apple		



The spirit is willing...

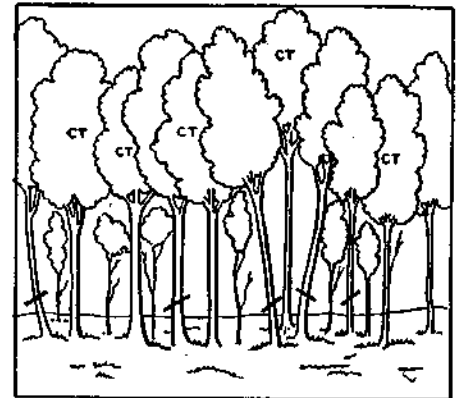
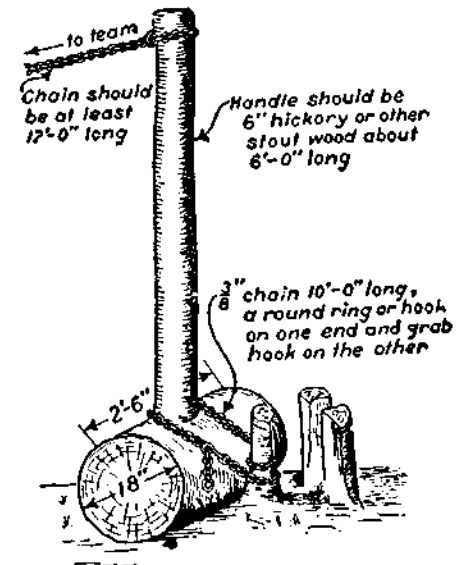


Diagram of a typical group of trees showing which trees to cut and which to save. Trees marked CT are the crop trees you are saving till ready for harvest. Notice you cut some large trees to allow younger trees to grow.



A simple stump puller like this can easily be made. It increases the pulling power of a team, car, or tractor about 6 times.

# Transportation and Power

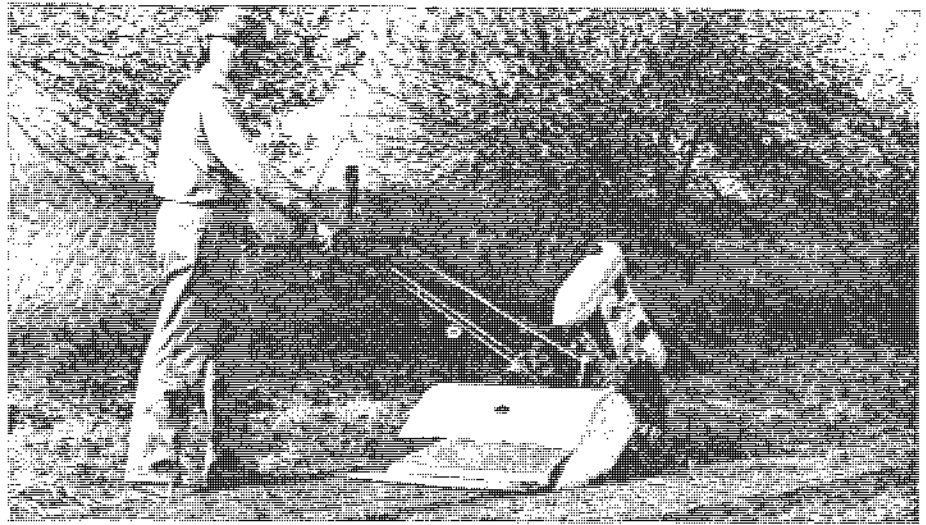
**S**OME kind of car is almost a necessity in the country. Even so, present day cars are not very satisfactory for productive country living.

Today cars are made primarily for city dwellers. That is they are made to transport people—and only people. In the country on a small farm there's a lot of other things in addition to people that you want to move. To name a few: lumber, hay, grain, livestock, poultry, firewood, gravel, cement, earth, produce. On a large farm a truck is probably a worthwhile investment but on a small place there is not enough work for a truck and there's many a need that a truck won't solve.

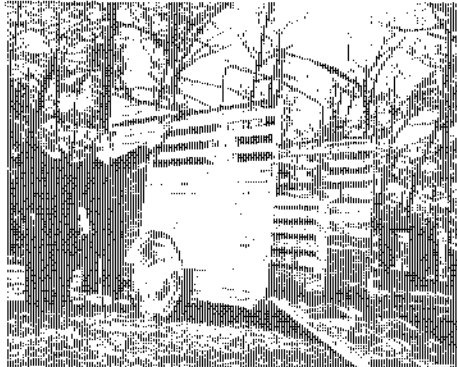
There are countless jobs around a small place that you can get done a lot easier with some power equipment. Until recently, the manufacturers more or less turned their backs on the small farmer. Now they realize the terrific potentiality in supplying the small land-owner and a number of power units for the small place are coming on the market.

In trying to decide how best to solve our Transportation and Power needs we made up the table below. Perhaps this will help you solve your problems. All prices are estimated for new equipment; obviously good second-hand equipment may be bought cheaper.

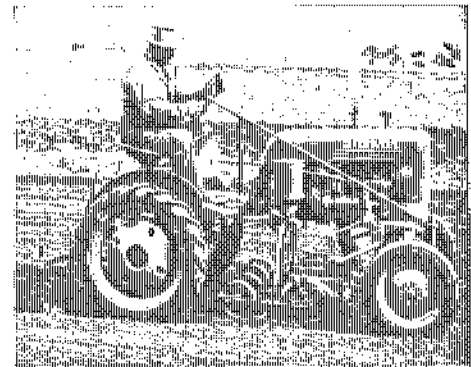
For example, in place of the 9,000 "garden type tractors" manufactured yearly before the war, over 100,000 are expected to be sold post-war. The "garden tractor" people are trying to put out better and more powerful machines. At the same time the manufacturers of large-scale tractors are developing smaller models for use on farms of 40 acres or less. All this can only result in better and cheaper power equipment for the small land-owner.



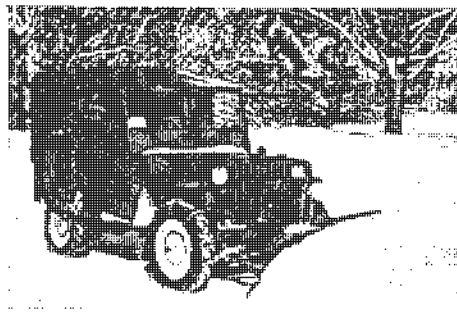
A Walking Tractor that plows, disks, and harrows in one combined operation—a "new" principle of cultivation ideal for some small areas.



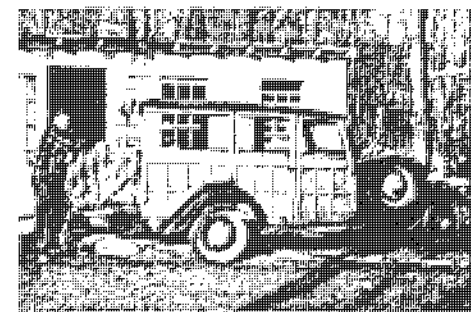
A Utility Trailer plus the family car is worth consideration. This home-made trailer is built low to facilitate loading . . . carries 2 animals . . . has many other uses.



A Baby Tractor with the full complement of attachments offers the small-acreage farmer low cost power for all field and garden operations.

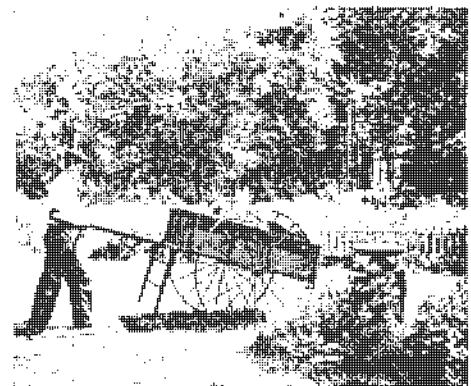


A Civilian Jeep works as tractor, passenger car or small truck and as auxiliary power plant for running all sorts of machinery from saws to your freezer in an emergency.



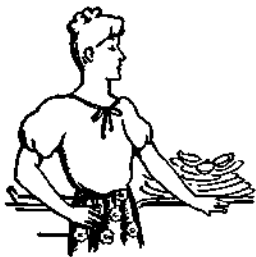
A Station Wagon is an all-purpose car for country homes. Unfortunately its cost is high and the wood construction needs yearly paint or varnish.

The Needs	Possible Solutions			
	Civilian Jeep	Car & Trailer	Station Wagon	Walking Tractor
Getting to work	Yes	Yes	Yes	No
Shopping	Yes	Yes	Yes	No
Social Life	?	Yes	Yes	No
Long Trips	?	Yes	Yes	No
Heavy Loads	Yes	Yes	Yes	(short distances (with trailer))
Moving Livestock	(with trailer)	Yes	(not large animals)	No
Snow Plowing	(with attachment)	(with attachment)	(with attachment)	(with attachment)
Power "take-off" for Sawing Wood, etc.	Yes	No	No	Yes
Cutting Lawn	?	No	No	Yes
Cutting Hay	Yes	No	No	Yes
Cultivating & Plowing	Yes	No	No	Yes
Cost (New)	\$1,500	\$1,150	\$1,350	\$500.



An Army Cart holds about four times the load of an ordinary wheelbarrow and is still easy to manage.

# Housekeeping on a Homestead



**H**OUSE-keeping should be a challenging subject to us American women. Instead, many of us consider it with boredom, or

with resentment that we have to do it at all—and if our husbands try to talk over our methods, we are likely to fly off the handle and wind up with the old come-back, “Well, I’d just like to see you take care of the house for a while!” I’m afraid I have to admit to just such arguments with Ed in the past, and to be honest, there is something to be said on both sides.

I do believe that there have been several things outstandingly wrong with modern housekeeping and that homesteading can answer some of our problems. The more important drawbacks I’ve found are:

(1) *Our own attitude toward housekeeping* is probably the key. I’m afraid that many of us look down our noses at it—we consider most any other job but homemaking glamorous. What we forget is that every job, whether it’s a man’s job or a career woman’s job in office or factory, has its own monotonous routines, too.

(2) *Lack of creative work in modern housekeeping.* Women really can’t be blamed for considering “housekeeping” a routine bore—that’s about all that’s left of homemaking in the city or suburbs. I don’t know how you classify your jobs, but, outside of raising children, I consider cooking about the only creative work left in most city and suburban homes today. The current trend seems to be for more and more of the family work, recreation and even child raising to be handled outside the home. All that will be left is vacuuming, washing dishes, and dusting—all negative and unstimulating.

(3) *Lack of economic satisfaction.* Since today’s woman has been brought up to be independent, it’s no wonder she’s not satisfied with the eternal routine left in the home. She’s not increasing her family’s security unless it’s in the negative way of cutting down expenses. Since the urban custom is to buy everything eaten, worn or used, it’s no wonder urban women have begun to feel their best contribution to their families would be jobs outside the home.

(4) *Lack of housekeeping efficiency.* Manufacturers have done much to make housekeeping efficient and easy,

but keeping house still needs a thorough engineering job done on it. The amount of your daily work is determined the minute you choose your house, the type of furnishings you put in it, the way you arrange your storage space and the type of clothes you buy. If we women want to contribute more to our families we will have to make routine work as efficient as possible.

## What Does A Homestead Do To Housekeeping?

It makes a big difference in your housekeeping when you have a homestead. When I lived in the city I had no interest whatsoever in housework except for learning to cook elegant meals. I became so bored with apartment housekeeping I found a job in a large New York City department store. And did I add anything to Ed’s and my security? I did not—for it took practically all my salary to provide adequate clothes for my job, lunches, bus fares, a part-time maid and other incidentals. Now that I am a partner on a homestead, housekeeping is just the routine part of a bigger job—not the be-all, end-all of my existence.

Of course you have much more to do on a country place than in the city. But these new jobs are stimulating, creative and varied. Think of the satisfaction of having a freezer stuffed with luscious food you helped raise yourself. Imagine your canning shelves laden with full, glistening jars—your handiwork.

And you can do all sorts of other things: separate milk to get heavy cream, make scrapple, make cheese, extract honey from the combs, (this is a 3-ring circus of fun!) and serve dinners of “home-raised” products that guests really appreciate!

There are also many pleasurable activities outdoors. The pigeons, geese and ducks, and all the new born goats can be your special projects. You’ll help with the garden, have herbs and all the beautiful flowers you want. Someone has said, “He who lives with the land has innumerable professions.” He is, for example veterinarian, farmer, gardener, animal husbandman, chemist, accountant, manager, weatherman, machinist and so on. That is equally true for the wife who shares homesteading activities.

Once you get started doing and making things for yourself you’ll probably want to do even more—do more sewing for your house—make your own Christmas presents (we’re raising popcorn this year for little remembrances)—maybe even make some rugs or do weaving. You can also raise or make

things for sale. Life will become a question of how can you do all that you want to do.

Because a homestead offers a woman an unlimited field of creative activities, it removes the complaints against housekeeping.

First, your own attitude is brighter and more interested.

Second, your work gives you pleasure and satisfaction because it is creative.

Third, you have that fine independent feeling of holding your security in your own hands, and you’ll take great pleasure in knowing your children are being well-fed and growing up in the most wholesome of surroundings.

Fourth, you are more of an executive and have more interest in increasing your efficiency.

In the book “Zero Storage” Mr. Sparkes, the author, describes the Fylers, a family of seven who have been homesteading and he sums up the economic point with this sentence. “For Mr. Fyler, one fact must be crystal-clear: by reason of the land and the freezer, instead of one Fyler, seven are now helping to make the family living.”

When Jackie gets a little older, there will be three Robinsons instead of two “bringing home the bacon.” Before we started homesteading it was just *Father!*

## Now For The Housekeeping Itself

It has taken me three years of “homesteading” to realize how ridiculous it is to judge a woman’s housekeeping ability by whether or not her country house is spotless, with dishes and beds attended to by 10 a. m. Instead of ironing or dusting, you will want to pick strawberries that are just ripe, wrap a chilled lamb for the freezer or go



fishing with your children. But your very annoyance with the routine tasks will give you the incentive to cut down the time they take. And when you tackle them with this sort of outlook, they

immediately become more interesting!

It seems to me, proficiency in housekeeping falls into three main divisions:

- (1) Layout and furnishing of your house.
- (2) Equipment.
- (3) Management and organization.

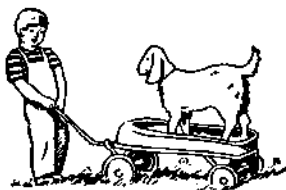


## The House And What You Put In It

Architects are now beginning to realize that a woman's working areas should be laid out in an orderly, convenient way. I have begun to see more plans recently where washing, ironing, sewing, cooking and children's play areas are correlated instead of being scattered all over the house from attic to basement. Also on a homestead you will want to consider whether the bathroom is handy to the outdoors, whether there is plenty of space for outdoor clothes where you usually enter and whether there is sufficient place for country tools and equipment. The amount of your routine work is somewhat determined the minute you choose a house. If you should build a new house, there will be many new designs and ideas to choose from. For instance, new radiant heating (hot water pipes under the floor) not only provides a healthier heating plan, but it will mean less work for Mama—no dusting and no painting those unsightly dust catchers called radiators. Also floors over the heating pipes may well be tile—warmer in winter, cooler in summer. And if the floors are pretty and warm—why, fewer rugs to pay for or to clean.

If you already have a conventional house there are still plenty of things you can do to make housekeeping easier. On your floor you can use patterned or neutral colored rugs which don't show dirt quickly, or scatter rugs which can be picked up and washed. The floor itself is easier to clean if it's waxed and a vacuum cleaner can often be used on it to more advantage than a dust mop. Or if you have an old unsightly floor, spatter painting might be the answer to simple care. Wooden furniture collects less dust if it's waxed instead of polished with oil.

When it comes to upholstered furniture most of us know how much simpler it is to have slipcovers which can be removed and washed easily. And if you buy or make slipcovers, bedspreads and draperies out of material that doesn't have to be ironed, (say seersucker, monkscloth—rubber or aluminum cloth that can be washed with a hose) then you've saved yourself even more work. These are just a few samples of what you can do if you look at your work with a mental question mark.



## Equipment

I remember a city husband saying, "I don't want my wife to have any more gadgets to make her apartment keeping easier—she'll just spend more money shopping!" I guess it's true in the city that the more spare time you have the more money you spend. There's not much else to do.



On a homestead, however, spare time is time to use productively. Of course you can run into town but you don't want to go when you've got a garden to plant or the bees are getting ready to swarm or a new lamb is expected.

So machinery for housekeeping and homesteading jobs is a good investment, for you use this equipment to create more for your family. One homestead husband told me he would rather have an electric mixer with all its extra parts in his home than an automobile (granting that a car wasn't a vital necessity to his job).

Here are some specific ways to use equipment on a homestead like ours:

a) *Cooking.* The freezer is one of the greatest aids to cooking. While its primary function is to preserve raw food, it is a boon to better cooking management. While you're cooking stews, soups, beans, creamed foods, cakes, cookies or breads, it is easy to make double or triple batches and put part of them in the freezer for another meal. You can assemble a variety of dinners from soup to dessert, place each dinner in one bag or box and freeze it for future quick delivery. Lunches too can be prepared for the week and frozen each complete in a separate lunch box. I should mention that "a grocery store in your home" also saves a surprising amount of shopping time.

The electric mixer with all its parts is another wonderful aid to better and speedier cooking. Besides whipping up cakes, milk shakes, cream and meringues, the mixer can be used to squeeze oranges, grind coffee, peel potatoes and shell peas and beans.

The pressure cooker is a splendid contrivance. Ed discovered ours at the N. Y. World's Fair and considered it the most wonderful thing at the whole fair. The actual cooking time for a stew is just 15 minutes!

b) *Dishwashing.* The electric dish-

washer not only saves labor but also time because you store the dishes in the washer and run the machine once a day. But if you don't have a dishwasher, you can approach this chore somewhat as if you did have the appliance. In other words, washing the dishes after each meal is another one of those silly standards we have set up for ourselves. If you rinse the dishes, stack them, wash them once or twice a day, rinse with boiling water and towel-dry only the silver, you will save yourself almost as much time as the machine can save.

c) *House cleaning.* The vacuum cleaner can often be used to good advantage on the floors themselves and for more of the dusting jobs. However, cleaning can chiefly be simplified by the furnishings you choose and your own good management.

d) *Washing And Ironing Clothes.* Of course, we all know that washing is being reduced to the minimum by certain types of machines which wash, rinse, and even dry for you. As for ironing if you hang flat things like sheets and towels very smooth and straight, there's really no reason for ironing them at all. I have heard any number of men and women say they loved to sleep between sheets fresh from the country-scented breezes. Such clothing as seersucker dresses and cotton knit shirts also need no ironing (or the very slightest touch) if they are hung carefully on the line. Those fabrics which insist on being ironed (and how many we can do without!) should be taken down while damp to save the sprinkling job. Notice how your ironing depends on your washing routine and both depend even more on how you shop. As one clever homesteader wife in Ohio wrote, "I begin my ironing when I do my shopping"



All in all I've found that housekeeping in the country can be run a little more like a business. Each housewife, as an executive (when the Boss is away) will want to do her own planning, adapting the schedule to the weather vane—whether there are raspberries just ready to pick or whether it's high time for a relaxing swim.

The women I've met who are interested in homesteading in the modern way are smart—they know that they will have a big job to do.

But they also know the rewards are tremendous.

# Homestead Mechanics



**W**HEN we lived in a city apartment we didn't even want to know how to fix a dripping faucet or repair a sagging door or paint our storm windows.

It's different when you have a place in the country of your own—you want to learn how to maintain your homestead. You also want to utilize all the labor-saving equipment that is practical. It doesn't seem right not to understand the workings of machines and devices we have to depend on every single day. And what a difference between the resentment you sometimes feel when you have to pay big repair bills and the feeling of real satisfaction you get from making repairs yourself. Even if you've never done more than stand by and watch a carpenter or a painter or a plumber at work there are a few simple repair jobs you can learn to do that will mean a big cash saving and a very pleasant form of recreation. Of course some jobs are frankly annoying, but I do think many are relaxing and fun to do. On days when other things don't go just right you come home from work mentally tired. Then your workshop can be a welcome refuge and little constructive jobs you do will reward you with a sense of accomplishment.

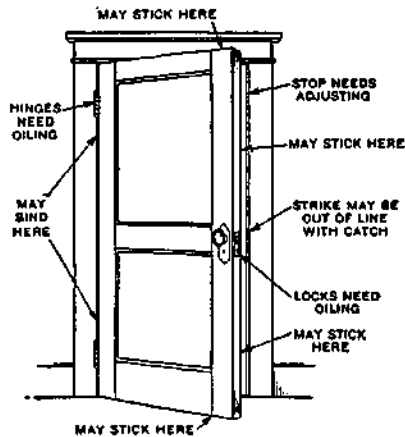
One morning last February the sink in our kitchen refused to drain properly and when I tried to clear it with the rubber plunger the water only backed up more. Finally, I sent for the plumber and after looking over the situation he dug to our septic tank and removed the lid. By this time I felt pretty helpless because I knew so little about plumbing and hadn't properly understood the trouble at first. This sense of helplessness is something that repair people are quick to notice. It is their cue to be mysterious about whatever repairs are needed and to encourage you to feel more helpless and more completely dependent on their superior knowledge. But I asked the plumber a few questions and he finally broke down and told me that the trouble was simply a blockage of the pipe and that I could

have saved about \$25 if I had known enough to prevent it!

Insurance underwriters say the majority of all accidents occur at home—accidents that can often be prevented just by replacing a loose board or repairing an electric fixture, or attending to the furnace properly. For this reason alone it's more than worthwhile to learn a few practical fundamentals of painting, carpentry, masonry, plumbing, electricity and last, but not least, simple auto maintenance.

## Painting

The outside of a building is best painted at least once every four years. This is because wood deteriorates rapidly when there is no paint to protect it from moisture. The hardest work in painting usually is scraping off the old



9 ways a door can go wrong

paint. Correct use of paint remover, wire brush, steel wool, or a scraper can often save you hours of needless work. You should learn how to store brushes properly and also the best method of storing paint for safety from fire. The difference between flat paint, enamel, varnish, wall sizing, and water paints is basic knowledge for every homesteader. For your kitchen there is a new 25% DDT water-based paint which can be sprayed or brushed on. It is said to kill flies and insects that walk or alight on it. An application remains effective 2 to 3 months inside and 2 to 3 weeks outside.

## Carpentry

If you like making things out of wood the first thing to make is a good workshop for your homestead. So many workshops I've seen are located in attics or cellars or barns where it's nearly always too cold or too hot or too damp or too dark to work. The workshop is worth the same consideration and planning as your kitchen. If it must be in the attic or cellar it should be properly heated, insulated and lighted. Once you have a good workshop you can make it pay for itself many times just

by doing simple repairing or building. I never did any building until we put up our small barn. Since then I've watched a neighbor put up an entire two-story house single-handed. He says the amount of knowledge needed to build a small house is surprisingly little if you have a good set of plans. A carpenter earns about \$15 a day, and by doing your own carpentry you can save that much while you yourself learn to master the fundamentals. Here is a check list of ten fundamentals in carpentry. See how many you know already:

1. How to lay shingles.
2. How to use the steel square.
3. How to file and set saws.
4. How to use the chalk line.
5. How to use a mitre box.
6. How to set girders and sills.
7. How to make joints.
8. How to hang doors.
9. How to lath.
10. How to lay floors.

## Masonry

One of the "trickiest" masonry jobs is supposed to be building a fireplace and chimney. But two high school boys I know apparently never heard how tricky it is because they built a fireplace out of fieldstone in a little house on Owasco Lake near Auburn, N. Y. and put up a 20-foot brick chimney. They dug and laid the concrete foundations, installed the damper, the flue, and put in fireproof bricks where required for proper fire protection. I admit they had some help — they had a ten minute conversation with a mason and read about three books! I haven't ever built a fireplace myself—about all the masonry I've done so far is to put in a cement floor in our small barn and pig pen. It's really worthwhile learning how to mix and pour concrete and lay foundations — you'll use it again



Why not paint your own house? Anyone can do a good job who is willing to read up on all the little tricks of the trade. Paint prolongs the life, increases value. If you do your own you can save up to 90%.

and again. If your cellar is damp, look into the new damp-proofing paint. It's a white powder you mix with water and scrub into the concrete or brick. The tiny particles penetrate and then expand which is said to work wonders in waterproofing masonry. It was developed by the French for waterproofing the Maginot line and is now being manufactured in this country for general use under the name, *Aquella*.

### Plumbing

Once you've learned how to repack a dripping faucet and replace a washer and clean out a trap below the sink or basin you know the three most common plumbing repairs a house needs. From there you can easily go on and learn how to install running water in your barn, or put in a modern hot water system, or an extra shower. Even if you don't want to do any plumbing work yourself I do think it is necessary to understand the operation of plumbing systems just for your own self-protection. Some people actually believe that pouring coffee grounds down the sink drain helps keep it cleaned out! You probably know others who think nothing of pouring hot grease down the sink or piling the drain full of lye indiscriminately. These people would never have a quarter of the plumbing repairs they have now if they had a better understanding of preventive maintenance.

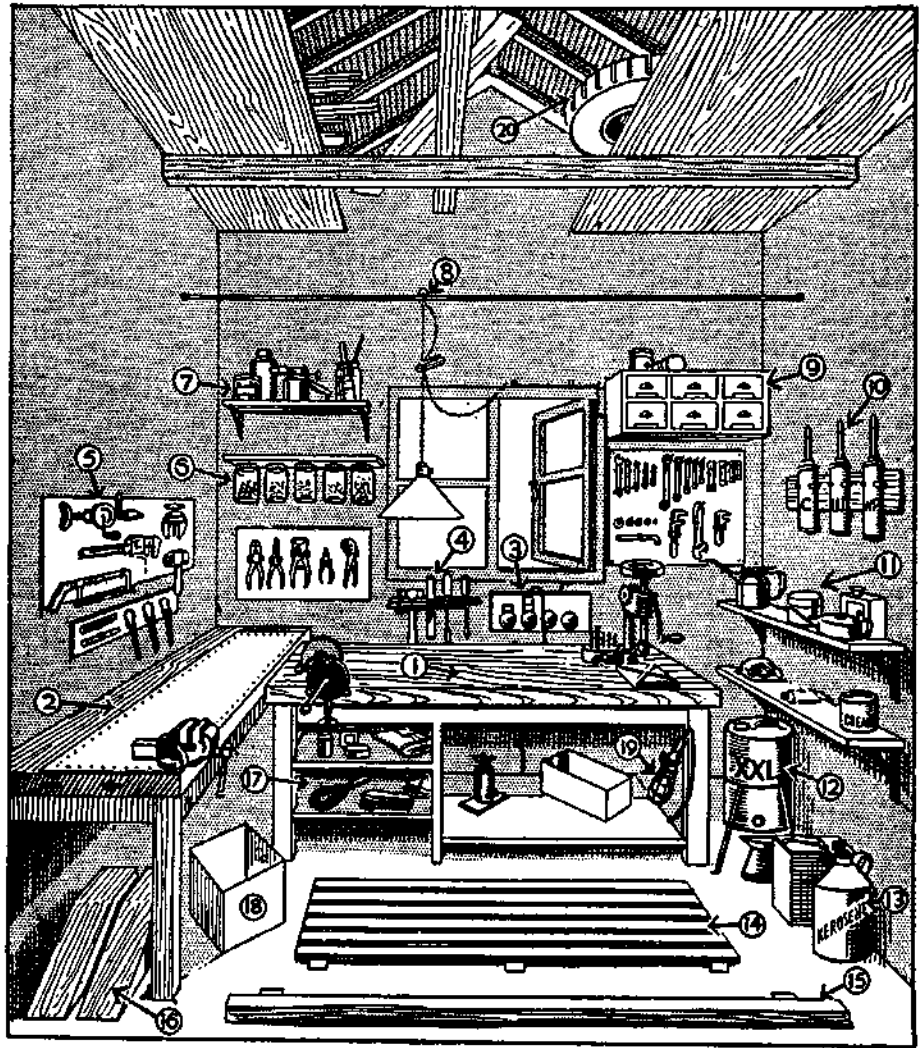
### Electricity

Maybe you already know enough about electricity but what about your wife? So many fires are started by wives who don't understand the electrical appliances they use quite well enough for their own safety! Here is a little quiz in electrical safety facts every wife should know:

1. What is the difference between a volt, an ampere, and a watt?
2. What causes a fuse to blow?
3. Is it safe practice to replace a 20 amp. fuse with a 15 amp. fuse?
4. Is it safe practice to replace a 20 amp. fuse with a penny?
5. It doesn't matter if the insulation on a lamp cord is worn bare so long as the lamp is kept turned off?
6. Why is it dangerous to turn on any electrical appliance while you are touching a water pipe or have wet hands?
7. Is it dangerous to replace fuses while the floor beneath the fuse box is wet?
8. About how much current does a washing machine use compared to a toaster?
9. Why is it inadvisable to use a toaster, an electric heater, and a curling iron all at once?
10. Is it possible to get a fatal shock from a 110 volt socket?

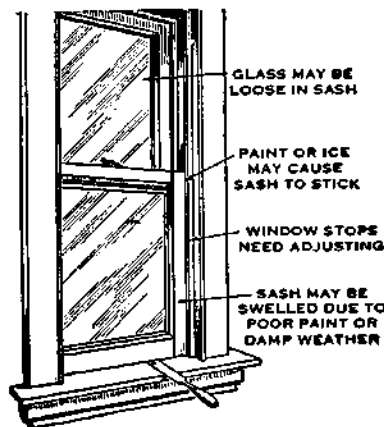
Any woman who can answer all the above questions satisfactorily is pretty

## A Good Layout for a Home Workshop

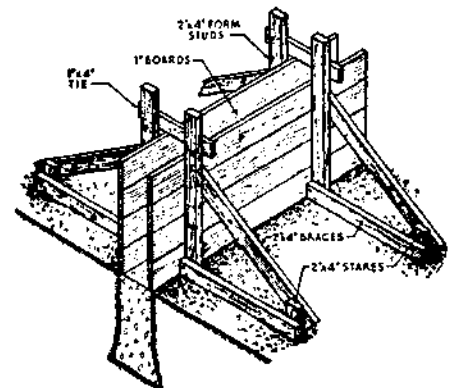


- 1.) Bench for light work.
- 2.) Bench for heavy work—sheet iron protects top.
- 3.) Electric outlets and switches.
- 4.) Small tool rack made from two converging laths, spaced  $1\frac{1}{2}$  in. apart at one end and  $\frac{1}{2}$  in. at the other.
- 5.) Rack for heavy tools.
- 6.) Screw-topped jars for nuts and bolts.
- 7.) Shell for painting materials.
- 8.) Trolley for light—clothespin adjusts cord length.
- 9.) Drawer for small parts.
- 10.) Three grease pumps; one for Universal joints, one for water pump, one for

- chassis bearings.
- 11.) Lubrication equipment.
- 12.) Five or ten-gallon oil drum on stand.
- 13.) Gasoline and kerosene, kept in different shaped cans to prevent error.
- 14.) Wooden platform protects feet from cold.
- 15.) Stop for front wheels of car.
- 16.) Ramps on which front or rear wheels can be run to facilitate greasing, etc.
- 17.) Shelf for washing and cleaning materials.
- 18.) Rubbish box.
- 19.) Inspection lamps.
- 20.) Storage in rafters for timber, tires, etc.



Common window troubles.



Foundation walls above grade may be formed in this manner where earth walls of the trench stand straight and true, and where a wide footing is not required.

well informed on electricity. After your wife has taken this quiz she ought to have the privilege of giving you one, so here are a few additional questions for men:

1. Explain how to read the electric meter.
2. Show how to make 3 different wire splices and explain the proper use for each.
3. If you make changes in the wiring does your fire insurance policy still cover you?
4. What gauge wire is usually the legal minimum for house wiring?
5. What is the amperage of the ordinary house circuit?

Some people may not agree, but Carolyn and I feel we ought to understand the buildings and machines and devices we have to depend on . . . understand at least enough about them so we can take care of them properly and not be too easily intimidated when something goes wrong. We think this knowledge is insurance on our way of living. This is part of the security we are seeking. It is also part of the fun we are having.

### Build Your Own House?

Perhaps the ultimate achievement in the field of "homestead mechanics" is to build your own house.

No doubt this may seem to you to be such a terrific undertaking that it is a laughable idea, but in the immediate neighborhood of our Homestead we know of six people who have built their own houses. They range from a G. I. who is just completing a three room bungalow, to an artist friend who has, over a period of four or five years, built a house worth over \$20,000.

Of course, in pioneer days almost everyone, with some community help, built his own house. At the turn of the century when plumbing, electricity and central heating became common, house building became more complicated and too much of a job for all but the most ambitious. Today, however, with the development of the factory-made utility unit which concentrates on the difficult-to-build bathroom, furnace room and kitchen, building your own house becomes something a handy man with sufficient spare time might consider doing.

This factory-made utility unit includes all the major mechanical components of a house. At one stroke, and for a predetermined price, the utility unit solves most of the costly and complicated installation problems involved in a conventional house. Additional factors which make house building simpler are radiant heating, which means a much simpler foundation, and new "panel type" exterior and interior walls which are simpler to erect.

Of course, a man doesn't have to build all his house—he can build as much as he wants to. But if he were

to build every bit of his house he would be able to save nearly 50% of the cost. Perhaps the most practical reason of all for building your own house is the obvious fact that today it is almost impossible to get anybody to build one for you.

### What About Power Tools?

There are so many different power tools available now that it's pretty hard to decide which ones are just fascinating gadgets and which can be useful enough to justify their cost.

Maybe you'd like to have a lathe, a power saw or an electric drill in your work shop but you don't want to spend a lot of money for any one of these things unless it will more or less pay for itself.




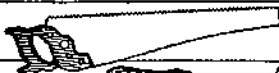





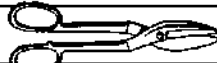
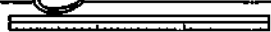



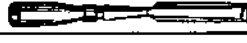





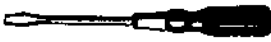

One way to figure this out is by using

a simple rule of thumb that says: "Don't buy any power equipment or machine unless the number of hours you will use it in one year equal at least ¼ the number of dollars you pay for it." This rule is based on the assumption that almost everyone's time is worth \$1.00 an hour and that the time the machine saves you will be used productively. Obviously, if this time were just wasted it couldn't contribute anything to the cost of the machine. We think you can safely apply this rule to any power tool you are thinking of buying and get a fair idea of just how much you really need it.

### Suggested Reading:

<i>Plans For Ideal Homestead Workshop</i> .....	35¢
<i>Carpentry Craft Problems</i> .....	\$2.50
<i>Plumbing Installation and Repair</i> .....	\$2.00
<i>House Wiring Made Easy</i> .....	\$1.65

### Bare Necessities Tool Kit

	PAINT BRUSHES								✓
	TRY SQUARE							✓	✓
	JACK PLANE								✓
	CROSSCUT HAND SAW							✓	✓
	SOLDERING COPPER								✓
	HAND GRINDER								✓
	OILSTONE								✓
	FILE								✓
	SMALL TROWEL							✓	
	TIN SNIPS							✓	✓
	YARD STICK							✓	✓
	PUTTY KNIFE							✓	✓
	HAND DRILL						✓	✓	✓
	SMALL DRILLS 1/16" TO 1/2"						✓	✓	✓
	1" WOOD CHISEL						✓	✓	✓
	16 OZ. CLAW HAMMER						✓	✓	✓
	KNIFE						✓	✓	✓
	SIDE CUTTING PLIERS						✓		✓
	LONG NOSE PLIERS						✓		
	SMALL SIZE SCREWDRIVER						✓		✓
	MEDIUM SIZE SCREWDRIVER						✓	✓	✓
	10" MONKEY WRENCH						✓		
		PLUMBING	ELECTRIC	DOORS	WINDOWS	CEMENT	SHARPENING	GENERAL	

# Earning Money In The Country

**M**AYBE you'd like to move your job to the country? Maybe, as it happened to us and as has happened to many others, you'll find you enjoy living in the country so much you'll come to realize you'd like to *work* in the country as well as *live* there.

Perhaps if you now live or work in a big city you'll say to yourself, "But *how* can I earn a living in the country—I'm no farmer!"



Don't let that bother you. You may not have realized it, but *most of the people who live in the country aren't farmers any more.* Look at the figures:

1. According to the latest census, the farm population is 30 million.
2. The non-farm population in towns or small cities under 25,000 is 49 million.
3. In towns as small as 2,500 or less there live over 27 million non-farmers.

What's perhaps even more significant, the Census shows that while the farm population stayed at 30 million between 1930 and 1940, the non-farm population in towns of 25,000 or less increased by 5,329,432—an increase of 12%, a percentage increase nearly double that of the country as a whole!

Never before in our nation's history has there been such wonderful opportunity to earn a good living in the country as there is today. Two momentous events are taking place: cities are spreading out . . . small towns are growing. In this trend to decentralization lies the new American frontier of opportunity.

## Take Your City Skill To The Country

The great movement away from the cities has been going on steadily ever since the automobiles became cheap enough for millions to own. This move is easy to see. Look at your own city or town. Aren't the better class new homes being built further away from the center of the city? Even 10 or more miles outside the city proper? Notice what this is doing to business. See the new community shopping centers . . . the so-called "service" industries are following the people.

More people are engaged in the "ser-

vice" industries than in manufacturing or farming. If you now are working in a "service" industry, you'll find—if you'll look into the matter—that there is untold opportunity in the *rural* service field. Remember, one advantage the city man moving to the country has over the country man is his more developed skill at earning a cash income.

If you're in one of the many "service" industries in the city, is there a need for your particular service in the country? Listed below is a group of services already being supplied by people in a town of 13,188 people. These are not *imagined* businesses—they're taken right out of the classified phone book for the town of Emporia, Kansas.

Abstracters  
Accountants -  
Adding Machines  
Advertising  
Airports  
Ambulance Service  
Architects  
Attorneys  
Auditors  
Automobile Agencies  
Automobile Repairing  
Automobile Equipment  
Automobile Graveyards  
Awnings  
Bakers -  
Barbers  
Batteries  
Beauty Culture Schools  
Beauty Shops  
Beverages -  
Bonds  
Books -  
Bottlers -  
Bowling Alleys  
Broadcasting Stations  
Brokers, Investment  
Building & Loan Assn.  
Building Materials  
Butane Gas  
Butchers -  
Cafes  
Carpenters  
Carpet Cleaning  
Cemeteries  
Chairs, Renting  
Cheese  
Chinaware  
Chiropractors  
City Offices  
Cleaners  
Clothing  
Clubs, Country  
Clubs, Night  
Clubs, Social  
Coal  
Concrete Products  
Confectioners -  
Contractors  
Credit Reporting Bu-  
reaus  
Dairies -  
Dairy Products -  
Dead Animal Removers  
Dentists  
Department Stores  
Doctors  
Draperies  
Drayage  
Druggists  
Dry Goods  
Electric Appliances,  
Household  
Electric Appliances, Ru-  
pairing -  
Electricians  
Elevators, Grain  
Exterminators, Termite  
Farm Implements  
Feed  
Filling Stations -  
Film Developing  
Films  
Fire Insurance  
Five & Ten Cent Stores -  
Floor Machines, Renting  
Florists  
Freight Truck Lines  
Fruits Retail -  
Funeral Directors  
Furnaces  
Furniture -  
Furniture Repairing -  
Garages -  
General Merchandise  
Gift Shops  
Glass, Plate  
Grain  
Greenhouses -  
Hardware  
Hatcheries, Poultry -  
Hats, Cleaning  
Heating Contractors  
Hemstitching  
Hotels  
Ice Cream -  
Ice Cream Manufac-  
turers -  
Implements  
Insulation Applicators  
Insulation Materials  
Insurance  
Investments  
Jewelers  
Junk  
Laboratories, Medical  
Ladies Ready-to-Wear  
Laundries  
Linoleum  
Live Stock Commission  
Companies  
Loans  
Lumber -  
Lunch Rooms -  
Machine Shops  
Machinery Contractors  
Mens Furnishings  
Millinery  
Monuments

Motor Trucks  
Motor Repairing  
Movers  
Newspapers  
Oil Marketers  
Optometrists  
Osteopathic Physicians  
Packing Houses  
Paint  
Pharmaceutical  
Photo Finishers  
Photographers  
Physical Therapy  
Technicians  
Physicians & Surgeons  
Pies -  
Pipe  
Plumbers  
Pop Corn -  
Poultry -  
Printers  
Produce -  
Publishers  
Radio Broadcasting  
Stations  
Radio Service  
Radios  
Ranges, Gas  
Real Estate  
Refrigeration Equip-  
ment  
Refrigerators, Serviced  
Rendering Plants  
Restaurants  
Roofers  
Rug Cleaning -  
Rugs  
Salvage, Automobile  
Seeds -  
Service Stations  
Sewing Machines  
Sheet Metal Work  
Shoe Repairers  
Skating Rinks  
Storage -  
Tailors  
Taxicabs  
Tea Rooms  
Tents  
Termite Control  
Theatres, Open Air  
Tourist Courts  
Towing, Automobile  
Tractors  
Transfer, Baggage  
Truck Lines  
Trucks, Motor  
Undertakers  
Upholstering  
Venetian Blinds  
Veterinarians  
Vulcanizing  
Wall Paper  
Wall Paper Removing  
Warehouses, Merchan-  
dise  
Washing Machines  
Washing Machines,  
Repairing  
Watches, Repairing  
Welding  
Wrecker Service, Auto-  
mobile

If you want to live in a smaller town and you find that the population is so small that the region can't support a full-time taxi service, for example, maybe you can combine your taxi service with an ambulance service, undertaking service, a car rental service and a delivery service.

Or you might combine a bookstore, newsstand, stationery store, mimeograph service, photostat service, local employment service, house rental service and travel information. Just a country store often supplies everything from shoes to meat—you can add up services until you're making the cash income you need.

## Big Business Discovers The Country

You don't necessarily have to have a business of your own to work and live in the country. Big business is on the move—and you'll find new country job opportunities increasing all the time.



The largest aluminum producer in the world, at Alcoa, Tennessee, is in a town of 5,000

—and it isn't a suburb of a city either. The Sylvania Electric Company, one

of the largest manufacturers of lamps has found that the location of its factories in smaller towns has resulted in increased efficiency.

Ford-Ferguson and John Deere, both makers of farm equipment, have found that by locating plants in the midst of farm country instead of the heart of a big city many advantages accrue.

General Motors and General Electric both have planned programs for decentralizing. So too has International Business Machines. In fact, the atomic bomb has given decentralization such impetus that there's no telling what's going to happen.

The war showed that big business could profitably sub-contract to the small manufacturer. For example, Pratt & Whitney are said to have issued over 18,000 separate sub-contracts.

Homer Hoyt, Director of Economic Studies of the New York Regional Plan Ass'n. has pointed out some of the disabilities of the large city industry. He writes in *Civil Engineering* for August 1945:

"It is now a question not of how fast our cities will grow, but of whether they will grow at all . . . The very great advantages of New York's site have led to a higher standard of living than obtained in the Nation as a whole, and the highest cost of municipal services, which have tended to increase overhead costs of doing business and also labor rates. The congestion of a large population has likewise increased costs by the friction of traffic congestion in central areas, by the cost of subways and express highways to transport so great a population from places of work to residences, and by the extra expense of going great distances to secure an adequate water supply. In addition, in a city which has long enjoyed such great natural advantages, it was possible to succeed, even with some relatively inefficient methods on the part of labor and capital. In so rich a market, high charges could be levied for certain services, make-work policies could be adopted, and still the market would bear the burden.

for human beings. Gardens and small farms may give the security and the health which are lacking within the city walls. Fresh air and sunshine come once more within reach. In the future, large cities with high population density will no longer be needed. As production methods advance, it will be increasingly possible for production plants to divide into small units and be dispersed over a wide area, perhaps the entire country. Production would then become not only less expensive but also more efficient, for manufacture in the large city has come to be increasingly uneconomical and wasteful of energy and time."



Summing up these trends, Arthur E. Morgan in the excellent book "A Business Of My Own" says:

"For a long time the railroad and steam power favored centralization. Today the big city with its congestion, inefficiency, insecurity, and high cost, is a less favorable environment, while good highways, electric power, small unit machinery, and other conveniences, have greatly improved the status of the small community. In the eastern part of our country many industrial units are leaving the cities for small town locations, sometimes hundreds of miles distant."

## If You Decide to Move Your Job

From the many letters we receive from folks who say, "I want a homestead like yours—and I want to work nearby so I don't have to waste any more time than necessary getting back and forth to work," we know that there is great interest in *working* as well as *living* in the country.

The fact that moving your job and setting up a homestead are both major tasks doesn't in the least effect the validity of either. But unless you're well fixed for an income to tide you over the transition period, it would be smart not to move your job and start a homestead at the same time. I don't believe it makes any difference which you do first. If you keep your present job and get your homestead all set up and running and perhaps paid for, then you'll have learned a good deal about business opportunities in your section. If on the other hand, you don't like your present job and want to find another in the country, then in getting your country job under control, you'll have

learned enough about the country to find a good site for a homestead.

And while you're riding through the country keep your eyes open for all the road signs put up by people operating little businesses of their own.

Of course, you're aware of lots of tourist camps, wayside markets, filling stations, and real estate agents. But also notice the less conspicuous signs,—the country lawyer, country doctor, country sign painter, the country tailor, the country radio repair man, the country beauty shop, the plumber, the upholsterer, the photographer. The small manufacturing plant, the craftsmen—and so on.

Often these people operate right from their own homes—and their places have enough land so they can really live. Enough so they can have a garden, fruits, berries, chickens—maybe a family cow.

There are just millions of folks in the country who've found out how to combine making a cash income with the home production of food.



A reference library can be most useful and important.

We have heard it said that "you can't learn to do this and that out of a book." However, judging from our own experience, we don't think this is strictly true. Here at our place we've got what you might call a reference library, with books and pamphlets on all sorts of subjects, and hardly a week goes by but what we "look up" how to do quite a lot of things.

We believe that every family who has a homestead should have a reference library—just the way all good cooks have cook books. You don't need a whole room full of books. You can get along with relatively few, if you choose them wisely.



"As cities grow older, traditional and customary practices which tend to impair efficiency become embedded in their economic structure."

Another expression of the trend toward decentralization is that of L. Hilberseimer in his book *The New City* (1944):

"Resettlement in the country as the exodus from the city gather momentum has obvious and far-reaching benefits





# LET'S REBUILD AMERICA . . .

**F**ROM the day the automobile was invented there has been an ever increasing movement of families to the countryside surrounding the cities. In these post-war years this trend may become almost a stampede.

*We Robinsons are only one family out of hundreds of thousands who have discovered how practical it is to hold a job in town and to go daily to it from a home and an acre or so of land.*

The only thing different about us is that we wrote the "Have-More" Plan about this way of living which has meant so much to us in security, health and happiness. We wanted to tell other families about our experiences so that they could profit by what we'd learned and thus succeed more quickly at setting up homesteads of their own.

The response we've had to our "Have-More" Plan has made us very happy but it has almost snowed us under at times. Not only have we had thousands of letters from other families telling us of their plans and asking advice—but we've heard from scores of manufacturers, real estate people, insurance companies, magazine and newspaper editors, and so on.

Here are just a few examples:

Soon after the "Have-More" Plan was published, *Better Homes and Gardens Magazine* asked us to write an article for them, with pictures, about our place. *The Reader's Digest* reprinted it. Then many other magazines and newspapers ran stories about the "Have-More" Plan. We were interviewed on the radio a number of times.

Real estate firms from all over the country write to us continually about their plans for dividing land into acreage plots instead of 50 foot lots as they might have done a few years ago.

Architects and builders have told us they are going to offer homes especially designed for country living.

One of the biggest insurance companies has asked our advice in developing a special low-cost, long-term

mortgage financing plan for families who want to have homesteads.

The Macmillan Company of New York has asked us to edit a whole series of books on the subjects people need to know about to succeed at homesteading.

The men in the services showed so much interest in the "Have-More" Plan that the Army bought a special printing of 55,000 copies for libraries.

We have talked to dozens of business men and have read about scores of others, including some of the biggest in the country, who are planning to move their offices and factories out of the cities so that their employees can enjoy the advantages that go with the ownership of a home and a little land.

In other words, it has sometimes looked to us as though just about everybody in the cities of America wants to move out to the countryside to live and to work!

*And why not? Why wouldn't that be a good idea? Why shouldn't we set ourselves that goal—to rebuild our country in the next twenty or thirty years so that every family that wants to can own its home and a little land?*

It is entirely practical for us to do so. We certainly have the productive capacity to build a whole new highway system, to move many factories away from the crowded cities, to build the millions of new homes, the equipment and furnishings that would go in them!

There was a time when a factory had to be located near water or rail transportation. Nearness to raw materials, nearness to markets, nearness to what was called a "labor supply" were the important considerations. Hardly anybody thought about whether the location chosen would be one where the workers in the factory would enjoy living.

Today, only four out of ten families in this country own their homes. In the big cities only one out of four families owns its home. Move factories away from the big cities, give people access to lower priced land, give them half a chance to own their homes, and the ratio may be reversed. How much sounder—how much better governed—would this country be if six instead of four families out of ten owned their homes—if the sense of responsibility, the interest in public affairs, the pride and independence that go with the ownership of property were theirs?

America needs a goal. It needs something tangible to work toward. Look what this nation has accomplished when it had a clear-cut job to do—like winning a war or opening the West.

*For the sake of national security itself, remembering the atom bomb; for the welfare and happiness of every family; for the sake of having a big, worthwhile job to do—so that we can unite in doing it instead of quarrelling with each other—let's rebuild America so every family that wants to can own a home and a little land!*



# Basic Seed Saving

## from Seeds of Diversity Canada

Seed saving is the simple act of helping plants to do what they do naturally: grow seeds and reproduce. When you grow your own seeds, you can grow your favourite varieties every year without buying them. You can maintain your own supply of unusual, or hard-to-find seeds. You can even try your hand at breeding your own new varieties! It's fun and it's easy. **The plants do all the work.**

People have been saving seeds for about 10,000 years. Long before there were any seed companies, long before professional seed-growers existed, ordinary people grew seeds for their own vegetables, grains, fruit, and flowers. There are many people alive today who can remember when most Canadian farmers and gardeners saved their own seeds as an ordinary part of their fall routine. They weren't experts in genetics, or university graduates in biology, but they knew a few simple things about plants. You can learn them here, and grow your own seeds too.

There are four main aspects of good seed saving:

- 1) Choosing varieties to meet your expectations
- 2) Controlling pollination
- 3) Selecting the most desirable seeds at harvest
- 4) Cleaning and storage

## Choosing Varieties

Seed catalogues usually distinguish two general types of plants: **hybrid** and **open-pollinated**.

In typical garden vegetables, an **open-pollinated** plant variety is a "true" or "purebred" variety. Both of its parents were the same variety, and all of its offspring will be the same too. Since every generation is identical to the generation before it, you can collect and replant their seeds over and over for many years and still have the same variety.

In some crop species, notably ornamentals and grains such as corn or rye, **open-pollinated** often means that the variety is a mixture of many slightly different plants. For instance, open-pollinated annual flowers can simply be a mixture of colours. Open-pollinated corn varieties such as Golden Bantam frequently have some variation from one plant to the next. Even though the plants are not exactly uniform, they are considered to be all part of the same variety.

A **hybrid** variety is a crossbreed. Its parents were different varieties and it is a combination of the two. A combination of two different open-pollinated varieties is called an **F1 hybrid**. A combination of two hybrids is called an **F2 hybrid**. F1 hybrids are known for being very uniform (each plant is exactly like the others), partly because of the pollination control that is needed to create them. Some hybrids show greater vigour than open-pollinated varieties of the same species. This "hybrid vigour" is especially evident in grasses and cross-pollinating species, but less strong in species such as beans and tomatoes that normally self-pollinate.

There is a problem with saving seeds from hybrid plants. Since their genes are a combination of their parents' genes, their offspring will receive a mixture of an already mixed bag. A seed collected from a hybrid plant might produce a plant similar to the hybrid, or it might resemble one of the hybrid's original parents, or it might be an altogether new combination. To make matters even more unpredictable, two seeds from the same hybrid fruit will not necessarily contain the same combination of genes, so will not necessarily grow up the same.

## **Controlling Pollination**

If two non-identical plants cross-pollinate (one is fertilized by pollen from the other), the seeds will be hybrids. They will consist of some combination of the two parent plants. Sometimes this is alright. For example, if you have a bed of mixed annual flowers and you plan to save some of the seeds to plant another mixed bed next year, it doesn't matter if the flowers cross-pollinate. The colours are already mixed anyway.

There are times when you want to prevent cross-pollination. Say you have two favourite varieties of tomato, one orange and one red. You want to replant the same two every year, so you want to keep each variety pure. Another example might be an heirloom bean variety that you want to keep pure, since you can't buy it from any seed company.

Cross-pollination can be prevented by:

- 1) Separating different varieties by enough distance so that pollen, or insects carrying pollen, can't travel between them.
- 2) Making a physical barrier to prevent insects from carrying pollen from one plant to another.

First you have to look at the anatomy of the flowers. There are three basic types of flowers:

- 1) Complete, self-pollinating
  - e.g. tomato, bean, pea, lettuce, wheat, barley
  - each flower has both male and female parts close together. Petals are tightly closed to keep insects out. These flowers almost always pollinate themselves, automatically preventing cross-pollination. In some cases (about 1 out of 20) a determined insect can crawl inside and cross-pollinate the flower, so a short isolation distance is still recommended.
- 2) Complete, cross-pollinating
  - e.g. petunias, onions, hollyhocks, rye
  - each flower has both male and female parts, but they are far apart and the flower is open, allowing insects in easily. These flowers are generally able to self-pollinate, and sometimes do, but they are cross-pollinated by insects just as often. Large isolation distances or insect barriers are required to prevent cross-pollination.
- 3) Incomplete, cross-pollinating
  - e.g. melons, cucumbers, corn
  - each flower is either male or female. Pollen must be carried from a male flower to a female flower for fruit and seeds to be produced. Large isolation distances or insect barriers are required to ensure that pollen comes from plants of the same variety as the female flowers.

**Self-pollinating** flowers are tightly closed, so insects and wind-blown pollen can't get in easily. They are also **complete** with both male and female parts in every flower. They (almost) always pollinate themselves, making it easy to keep varieties pure. In fact, it's fairly difficult to make hybrids of self-pollinating species.

In some rare cases, these plants can cross-pollinate over short distances. Pollen can drift for a few feet from any plant, further if the pollen is light and dusty, or an insect can sometimes push its way into a tightly-closed flower. We recommend that different varieties of self-pollinating plants should be separated by at least 10-15 feet in the garden, but the further the better to ensure that they remain pure.

Note that if two identical plants cross-pollinate, it has the same result as self-pollination.

**Cross-pollinating** flowers are open, allowing wind and insects to transfer pollen to any plant within several hundred feet. Most cross-pollinating garden plants have heavy, sticky pollen so they need insects such as bees to carry it. Since bees can travel up to a quarter of a mile from their hive, it is usually recommended to keep different varieties of these plants separated by a quarter of a mile to prevent them from crossing. Other plants have fine, dusty pollen which is carried by wind. Spinach, beet and grains such as corn and rye are among these. They must be separated by a greater distance of a mile or more.

**Incomplete** flowers are always the cross-pollinating kind. The name means that each flower is either male or female, but never both. Squash, cucumber, melon, corn, and spinach are examples. Pollen is not only able to move freely, by wind or insects, the plant requires something to move pollen from the males to the females. Without insects, no fruit would set on these flowers and no seeds would be produced. The best way to control pollination of these varieties is to learn the difference between the flowers and to hand-pollinate them.

**Insect barriers** are easy to make with spun-polyester row cover material, old nylons, paper or fine cloth. Cover a few flowers or entire plants, preventing insects from reaching the flowers. Don't use plastic film to cover plants, since it will trap heat from the sun and fry them! If the flowers are self-pollinating, they will pollinate inside the bag and the seeds will be purebred. If the flowers are incomplete, they will need help to transfer their pollen.

Usually, plants will only cross with other plants of the same species. For instance, different kinds of squash can cross with each other, but they cannot cross with cucumbers. However, some species are related closely enough that they can pollinate each other. For example, broccoli and certain kinds of wild mustard can cross-pollinate, producing an inedible hybrid. Lettuce can cross with its wild cousin, so learn to identify wild lettuce if you want to grow lettuce seed. Radishes can cross with mustard and chinese cabbage. If in doubt, consult a seed-saving book. These relationships are well-known and documented.

## **Selecting Seeds**

Seeds must be allowed to ripen fully on the plant or they will not germinate. It's important to know at what stage the seeds are ripe. Flower seed heads are usually only ripe when they turn brown and dry. Fleshy fruit such as tomatoes and cucumbers should generally be very ripe, or even over-ripe before they are picked for seed-saving.

Although green tomatoes turn red and soft after they are picked, they do not continue to grow and develop. Immature seeds cannot mature unless the fruit is fed from the vine. Shelf-ripened tomatoes don't have true vine-ripened flavour, nutrition and may not have viable seeds.

If you aren't sure what your mature seeds will look like, keep a few seeds back in the spring. Then you can compare them to the ripening seeds. Compare size, colour and especially plumpness.

Collect seeds from the plants that are most like the plants that you want to have in future years. If you are trying to preserve an heirloom variety, choose seeds from many plants to maintain the natural diversity of characteristics. For example, some varieties of beans have natural variations in colour within their population. Some of each colour must be saved to preserve the variety completely.

If you want to try to create your own new variety, collect seeds from the plants that are closest to your ideal. For example, you might collect seed from the first tomato to ripen each year. Theoretically, you should be able to select early-ripening genes this way and eventually all of the resulting tomato plants should bear fruit a little earlier. Another example is to collect seeds from your favourite colours of a mixed planting of annual flowers. Cross-pollination may make this difficult, but every year that you repeat this you should get a higher proportion of that colour in your own special mix.

Choose seeds from plants that are free from disease since some disease organisms can survive on the seed surface and re-infect the whole planting next year. Seeds that are lumpy, mouldy or discoloured should not be kept for seed, unless absolutely necessary.

## **Cleaning**

Seeds that are dry when collected (such as most flower seeds) should be freed from chaff and bits of the flower, which can harbour fungus spores, and should be stored in paper envelopes. Seeds from fleshy fruit such as tomatoes and cucumbers need to be cleaned well. These seeds are surrounded by a jelly-like substance that should be removed before storage. This seed jelly is meant to inhibit germination so that the seed does not sprout in the fall when the fruit drops. In nature, the jelly would rot during the late fall, and by the time the seed had been exposed, it would be too cold for it to sprout until spring.

To remove the seed jelly, simply scrub the seeds with your fingers or a towel. If you are saving a large number of seeds, you can use a method called "fermentation". Seed companies which grow and package many thousands of seeds cannot scrub them all with towels, so they use this simple, though disgusting, method. Place the seed pulp in a closed container and keep it in a warm place for 3 or 4 days. Don't let it dry out, but don't add water unless you have to. Soon, mould will cover the surface of the pulp and the jelly will rot, creating a delightful aroma. Holding your nose with one hand, strain the pulp through a sieve with lots of water and the seeds should come out clean. While the seeds are being rinsed, see if any of them float. Especially with tomato, cucumber and melon seeds, if they sink they're good; if they float, they're duds.

## **Storage**

The best conditions for storing seed are, not surprisingly, the opposite of the conditions required for germination. Seeds germinate best in warm, moist conditions and store best in cold, dry conditions. Most seeds can remain viable for a few years in paper envelopes in dry air at room temperature. You can extend their lifetime considerably by keeping them cold in a refrigerator.

Inside every seed is a tiny plant embryo that lives by "eating" a stored quantity of starch. When the food runs out, the embryo dies and the seed will not germinate. The way to keep a seed alive for a long time is to slow down its metabolism. The lower the temperature and humidity, the slower the seed consumes its food.

A simple rule of thumb is that the sum of the temperature in degrees Fahrenheit and the percent relative humidity should be less than 100.

### **Temperature (degrees F) + Relative Humidity (%) < 100**

More or less, for every 10 degrees that the temperature is reduced, seeds will live for twice as long. Humidity is very bad for seeds. If they absorb moisture, even from the air, they start to prepare for germination, and use up a lot of their stored food. **Never** store seeds in a humid greenhouse, a damp basement or garage, a laundry room, or a growing area where there are plants evaporating water into the air.

Seeds should be well-dried before they are put into storage. Open air drying is easiest. There are a few simple methods for testing seed dryness.

- \* The hammer test: hit one of your seeds with a hammer. If it shatters, it's well-dried. If it just mashes, it needs to be dried further. (or rather, the others do)
- \* The al dente test: a well-dried bean or pea should feel hard when you bite on it. If you can easily make tooth marks, it needs to be dried further.

If air-drying doesn't work, for instance if the air is too wet in your area, you can dry seeds in a food dehydrator or a slightly-warm oven, but avoid temperatures over 95F, since the seeds can be damaged by too much heat. Seeds do need a little moisture to stay alive, so don't try to make them dryer than they would naturally become in the open air.

Paper envelopes allow moisture to escape, preventing deadly condensation. Seeds can also be stored in jars, but it is a good idea to put a little silica gel in the jar too, to absorb excess moisture. Silica gel can be purchased at most craft

stores (it's used for drying flowers) for about \$10/kg. Most brands contain a few indicator crystals which turn blue when the gel has absorbed a certain amount of moisture. Heating the gel in an oven at about 200F dries it out again

A good system is to store your year-to-year seeds in paper envelopes in a cool, and especially dry place. Keep long-term backups in tightly-sealed glass jars in a consistently cool or cold place (humidity in your basement doesn't matter if the jars are well sealed). Note that plastic allows more moisture through than you might think – use glass jars. If you really want to keep seeds for a long time, you can jar them as above, and store them in a freezer. As long as they are well-dried, they will keep for many years. Frozen seeds should be kept in well-sealed jars, since the freezer can over-dry them, similar to freezer-burn, and fatally dehydrate the seed.

## **Isolation Distances and Seed Viability**

The statistics on the following page are typical of those found in seed-saving books. They are provided as a guideline only, since there can be a lot of variation from garden to garden. Your own experience is the best teacher.

Isolation distance for bee-pollinated plants really means "how far will a bee travel while collecting pollen and nectar?" The actual distance depends a lot on the geography of the area, the types and quantities of flowers available and the distance from the hive. A guideline of 1/4 mile is usually given for these plants, but the actual required distance can be anywhere from 100 feet to 1/2 mile.

Isolation distance for wind-pollinated plants really means "how far do the plants have to be separated so that there is an 'acceptably small' chance of pollen being blown from one to the other?" Again, the actual distance depends on the usual direction of the wind, nearby wind blocks such as trees and fences, the weight of the pollen, humidity, and the amount of pollen being produced in your planting. One or two miles is often recommended, but as little as 1000 feet is sometimes enough, especially for large plantings.

Seed viability, or "shelf life" varies greatly with temperature and humidity. The figures given below are typical for seeds stored in a dry, cool place such as a dry cellar (or a humid cellar with the seeds in dry jars). Seeds stored at room temperature, but still dry, will usually last about half as long. Seeds stored in a humid location can lose their viability within a few months to a year.

A germination test can be helpful if you want to know how good your seeds are. Sprout 10 or 20 seeds in a small pot of potting soil or vermiculite, or wrap them in a paper towel and keep them moist in a warm place (wrapped in plastic on top of the fridge is good). In a week or two, some of the seeds should sprout. If less than ¼ of them do, you should consider regrowing them. If fewer than half of the seeds sprout, the rest of the batch is probably close to dying; time to plant them and collect fresh seeds.

The isolation requirements below are taken from How to Save Your Own Vegetable Seeds, by Seeds of Diversity Canada.

The seed storage statistics are typical for seeds stored in a dry, cool place.

	distance	shelf life(yrs)			distance	shelf life(yrs)	
		avg	max			avg	max
Angelica		1	3	Marjoram		3	7
Asparagus		5	8	Melon, Musk	1/4 mile	5	10+
Basil		8	10+	" , Water	1/4 mile	6	10+
Bean	15-20 ft	6	10+	Mustard	1/4 mile		
" , Kidney	15-20 ft	3	8	Nasturtium		5	8
" , Lima	1 mile			Okra	1 mile	5	10+
" , Runner	1/2 mile			Onion	1/4 mile	2	7
" , Soy	10 ft	2	6	Parsnip	1/4 mile	2	4
Beet	1/4 mile	6	10+	Parsley		3	9
Borage		8	10+	Peas	15-50 ft	3	8
Broccoli	1/4 mile	5	10	Peanut		1	1
Brussels Sprouts				Pepper	500 ft	4	7
	1/4 mile			Pumpkin	1/4 mile		
Cabbage	1/4 mile	5	10	Radish	1/4 mile	5	10+
" , Chinese	1/4 mile			Rhubarb		3	8
Calendula		3	7	Rosemary		4	?
Carrot	1/4 mile	4	10+	Rutabaga	1/4 mile		
Catnip		5	6	Sage		3	7
Cauliflower	1/4 mile			Salad Burnet		3	9
Celeriac	1/4 mile			Salsify	1/4 mile	2	8
Celery	1/4 mile	8	10+	Savory		3	7
Collard	1/4 mile			Sorrel		4	7
Corn	1/4-1 mile	2	4	Spinach,	1 mile+	5	7
Cucumber	1/4 mile	10	?	" , New Zealand		5	8
Cress, Garden		5	9	Squash	1/4 mile		
Dill		3	5	Strawberry		3	6
Eggplant	50 ft	6	10	Sunflower	1/4 mile		
Gourd		6	10+	Sweet Cicely		1	1
Horehound		3	6	Swiss Chard	1/4 mile		
Hyssop		3	5	Tansy		2	4
Kale	1/4 mile			Thyme		3	7
Kohlrabi		5	10	Tomato	15-20 ft	4	9
Lavender		5	6	Turnip	1/4 mile	5	10+
Leek	1/4 mile	3	9				
Lentil	10 ft	4	9				
Lettuce	15-20 ft	5	9				
Lovage		3	4				

**MENU:** [HOME](#) » [Reconstruction](#) » [Recovery](#) » [Renewal](#) » [Survival](#) » [Humanure Content](#)

---

---

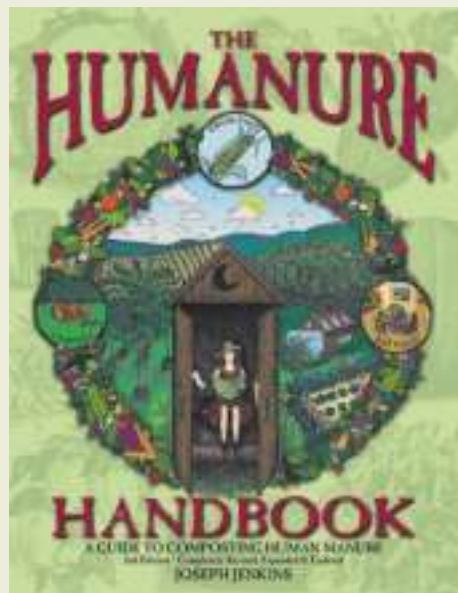
# The Humanure Handbook

[Front Cover](#) - [Back Cover](#)

## Table Of Contents:

[Show Full Contents](#) - [Awards](#)

[Reader Feedback From The First Edition](#)



0 - [The Beginning](#)

1 - [Crap Happens](#)

2 - [Waste Not Want Not](#)

3 - [Microhusbandry](#)

4 - [Deep Sh\\*t](#)

5 - [A Day In The Life Of A Turd](#)

6 - [Composting Toilets And Systems](#)

[Worldwide Sources of Composting Toilets](#)

7 - [Worms And Disease](#)

8 - [The Tao Of Compost](#) (\*how to do it!)

9 - [Alternative Grey Water Systems](#)

10 - [The End Is Near](#)

[References](#)

APPENDICES

- Appendix 1: Temperature Conversions
- Appendix 2: Sources of Wetland Plants
- [Appendix 3: US State Regulations](#)

[Glossary](#)

**Other Goodies:**

[Join a discussion](#) with your fellow humanure composters!

PalmOS file in DOC format: [Chapter 8: Tao of Compost](#)

Copyright 1999, Joseph C. Jenkins

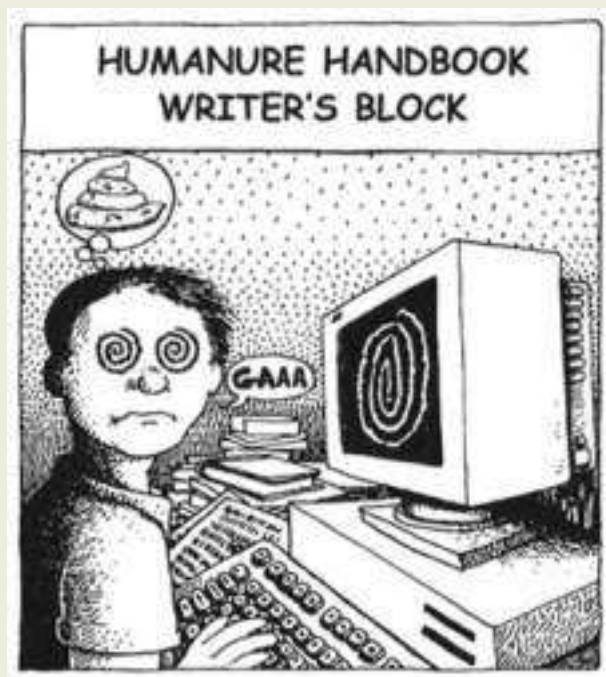
The following information may be reproduced subject to the following three conditions:

- 1) The information must not be changed or altered
- 2) The following information must accompany all copies:

*Source: The Humanure Handbook. Jenkins Publishing, PO Box 607, Grove City, PA 16127. To order, phone: 1-800-639-4099.*

<http://www.jenkinspublishing.com/>

- 3) The reproduction is not done for profit. Persons wanting to use excerpts or artwork from this book for a profit venture must contact the publisher for permission.

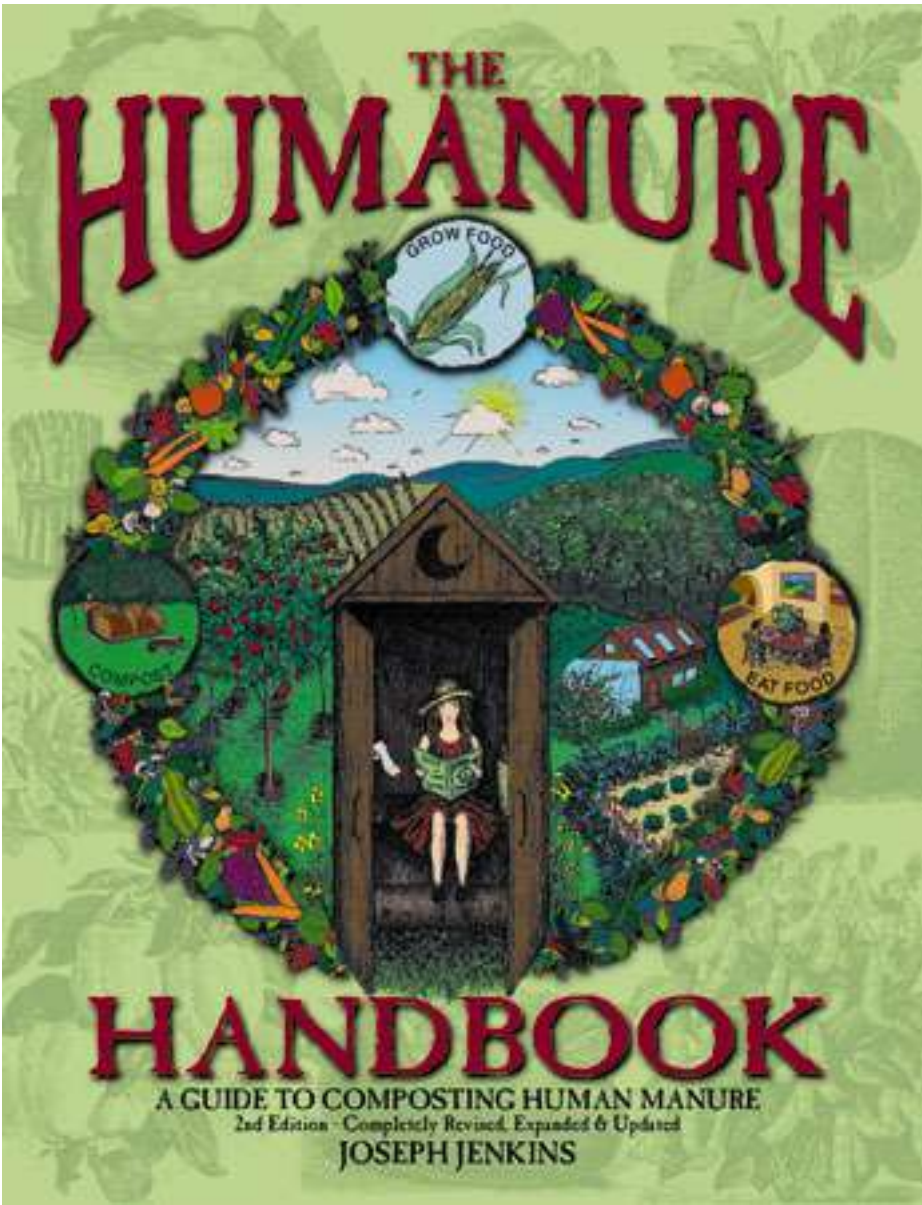




**MENU:** [HOME](#) » [Reconstruction](#) » [Recovery](#) » [Renewal](#) » [Survival](#) » [Humanure Content](#)

---

---



**2nd EDITION**  
**COMPLETELY REVISED**  
**EXPANDED AND UPDATED**

A book of great environmental importance.  
302 Pages, 29 Photographs, Over 100 Tables and Figures,  
Index, Glossary, Appendices, and a few bad jokes.

# The Humanure Handbook

Now in dozens of countries worldwide • Amazon.com category #1 best seller

### COMMENTS FROM READERS AND REVIEWERS:

- "World-shaking."
- "The perfect self-published book."
- "One book that could save the world."
- "Almost certain to become a classic in its field."
- "One of the most important books ever written."
- "Should be required reading for everyone on the planet."
- "You have answered questions I have held open since childhood."
- "After reading this book, you will never flush a toilet with indifference again."
- "Answers every question anyone could have about managing a compost toilet and compost pile."

Humanure: waste or resource? Joseph Jenkins boldly steps where no author has gone before. Considered by many a "moving" book, *The Humanure Handbook* will surprise you with its timely relevance, delight you with its humor, and impress you with its thorough research. Brilliantly simple, profoundly mundane, this is one book you will never forget. Full of "eye-candy" illustrations, practical information, history, philosophy, and science, it addresses an issue relevant to each and every human being on Planet Earth.



ISBN 0-9644258-9-0



9 780964 425897

\$19.00 US

Distributed by Chelsea Green

# The Humanure Handbook

**A Guide to Composting Human Manure**

[Front Cover](#) - [Back Cover](#)

## Table Of Contents:

[Show Chapters Only](#) - [Awards](#)

[Reader Feedback From The First Edition](#)

0 - [The Beginning](#)

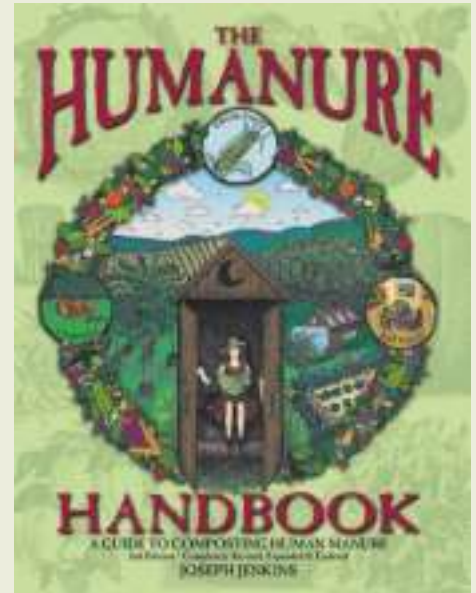
1 - [Crap Happens](#)

2 - [Waste Not Want Not](#)

- [Human Nutrient Cycle](#)
- [Soiled Water](#)
- [Waste Vs. Manure](#)
- [Recycling Humanure](#)

3 - [Microhusbandry](#)

- [Vintage Compost](#)
- [Compost Defined](#)
- [Naturalchemy](#)
- [Solar Power in a Bananna Peel](#)
- [Gomer The Pile](#)
- [Four Necessities for Good Compost](#)



- [The Carbon / Nitrogen Ratio](#)
- [Thermophilic Microorganisms](#)
- [Four Stages of Compost](#)
- [Compost Biodiversity](#)
- [Compost Myths](#)
- [Compost Miracles](#)
- [Vermicomposting](#)
- [Practice Makes Compost](#)

#### 4 - [Deep Sh\\*t](#)

- [The Ego Vs. The Eco](#)
- [Asian Recycling](#)
- [The Advances of Science](#)
- [When the Crap Hit the Fan](#)
- [Asian Update](#)

#### 5 - [A Day In The Life Of A Turd](#)

#### 6 - [Composting Toilets And Systems](#)

- [Composting Toilets Must Be Managed](#)
- [Fecophobia and the Pathogen Issue](#)
- [Owner Built Composting Toilets](#)
- [Asian Composting](#)
- [Commercial Composting Toilets](#)
- [Worldwide Sources of Composting Toilets](#)

#### 7 - [Worms And Disease](#)

#### 8 - [The Tao Of Compost](#) (\*how to do it!)

- [Primal Compost](#)
- [The Sawdust Toilet](#)
- [The Compost Bins](#)
- [Normal Composting Bin Sequence](#)
- [Normal Composting Bin Sequence \(Continued 1\)](#)
- [Normal Composting Bin Sequence \(Continued 2 - Not Available\)](#)

- [Pathogenic Populations and a Two Year Retention Time](#)
- [Analyses](#)
- [Monitoring Compost Temperature](#)
- [Fecofrigginfobia](#)
- [Legalities](#)
- [Environmental Potty Training 101](#)

9 - [Alternative Grey Water Systems](#)

10 - [The End Is Near](#)

## [References](#)

## APPENDICES

Appendix 1: Temperature Conversions (Not Available)

Appendix 2: Sources of Wetland Plants (Not Available)

[Appendix 3: US State Regulations](#)

## [Glossary](#)

## **Other Goodies:**

[Join a discussion](#) with your fellow humanure composters!

PalmOS file in DOC format: [Chapter 8: Tao of Compost](#)

---

Copyright 1999, Joseph C. Jenkins

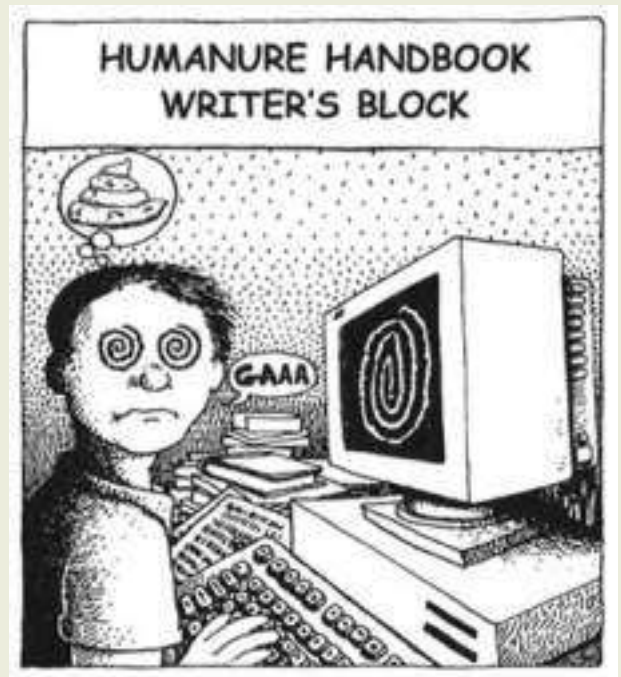
The following information may be reproduced subject to the following three conditions:

- 1) The information must not be changed or altered
- 2) The following information must accompany all copies:

*Source: The Humanure Handbook. Jenkins Publishing, PO Box 607, Grove City, PA 16127. To order, phone: 1-800-639-4099.*

<http://www.jenkinspublishing.com/>

- 3) The reproduction is not done for profit. Persons wanting to use excerpts or artwork from this book for a profit venture must contact the publisher for permission.



---

**MENU: [HOME](#) » [Reconstruction](#) » [Recovery](#) » [Renewal](#) » [Survival](#) » [Humanure Content](#)**

---

**MENU:** [HOME](#) » [Reconstruction](#) » [Recovery](#) » [Renewal](#) » [Survival](#) » [Humanure Content](#)

## REAPING THE REWARDS OF RECYCLING

*'Humanure' an Amazon.com #1 Category Bestseller Two Years Running, ForeWord Magazine Book of the Year finalist; Finalist in the Ben Franklin Awards for Excellence in Publishing*





**UPDATE!** May 22, 2000: The Independent Publisher Book Awards 2000 has selected its winners, which include:

THE TEN OUTSTANDING BOOKS OF THE YEAR:

Most Likely To Save the Planet: *The Humanure Handbook (2nd Edition)*, by Joseph Jenkins; [Jenkins Publishing](#)

These results [have been posted](#) on the [Independent Publisher](#) website in time for the start of BookExpo. Award plaques and certificates were delivered on Friday morning, June 2, at BookExpo, or mailed to those who didn't attend. Specific title judging reports were sent to all publishers. Thanks to all 550 publishers that entered, and congratulations to you all for your excellent work.

Who would have ever thought that a book about composting --especially one proposing how to safely recycle human excrement -- would run to the top of Amazon.com's bestseller lists two years in a row? Or become a finalist in ForeWord Magazine's 1999 Book of the Year competition and in the Ben Franklin Awards for Excellence in Publishing?

Certainly not Joseph Jenkins, author and tradesperson, whose success with *The Humanure Handbook: A Guide to Composting Humanure* has earned him some dubious titles such as "King of Compost" and other unmentionables, and placed him on the receiving end of some pretty off-color jokes, but has also gained him some recognition as both an author and publisher.

"I never expected it [*Humanure*] to go anywhere," Jenkins said. "I didn't know how anybody would react, so I expected the worst. I estimated that maybe one person in a million would be interested."

However, since 1994, when the book was first published, *Humanure* has sold out four printings and is now in its fifth printing and second edition, having over thirteen thousand copies in circulation. In fact, Jenkins quickly sold out his first print run of 660 books, which, he thought, would "last him a lifetime;" he now sells approximately 500 of his books every month.

He has been contacted by hundreds of people all over the United States, and has sold his Humanure books in over 31 different countries around the world. The book has been written up by many media, including the *Associated Press*, *Mother Earth News*, *Natural Health* magazine, and *Whole Earth Review* and has been talked about on Canadian Broadcast radio, British Broadcast radio, Radio America, and even the Howard Stern show.

Using a biological, low-technology system of thermophilic composting, Jenkins has successfully recycled his own family's organic material for over twenty years. The end product: hygienic, nutrient-rich humus, is used to amend the soils in his food garden. Humanure was the inevitable result of Jenkins' two decades of practical experience with composting and organic gardening paired with extensive research

gleaned from scientific journals and texts.

But this is much more than a book on composting. In it, Jenkins exposes many environmental problems that have resulted from our view of organic materials as "wastes," and reveals what he feels are the underlying reasons why our relationship with the Earth is so dysfunctional. A review in *HortIdeas* (September 1999) touted *Humanure* as "one of the most important environmental exposés of all time," ranking right up there with Rachel Carson's *Silent Spring*.

Most recently, however, *Humanure* has received accolades through Amazon.com, an on-line bookstore that is, without argue, probably the largest on-line bookseller in the world, offering 4.7 million books for sale. For two years running, *Humanure* has achieved Amazon.com #1 bestseller status in the category of Soil Science (1998), and this year, in the Nature and Ecology: Recycling category. Jenkins' other self-published book, *The Slate Roof Bible*, was an Amazon.com #1 bestseller in 1998, in the Roofing category, and ranked #2 in 1999.

*Humanure* was one of seven finalists in ForeWord Magazine's Book of the Year Award program. More than 1,000 titles were entered in the 1999 competition, and award-winners were selected in twenty-three categories. ForeWord Magazine established this award in 1998 to recognize the vital books published by small, independent and university presses.

The *Handbook* is also one of three finalists in the Gardening/Agriculture category for the 2000 Benjamin Franklin Awards for Excellence in Publishing, a prestigious national award sponsored by the Publisher's Marketing Association, a non-profit trade association of 3,400 publishers. This year, over 1,600 entries were submitted, of which 165 were chosen as finalists. Award winners will be announced in June at the Book Expo America, the largest publishing trade fair in the world, which will be hosted in Chicago at the McCormick Place.

Source: Jenkins Publishing, PO Box 607, Grove City, PA 16127. To order, phone: 1-800-639-4099.  
<http://www.jenkinspublishing.com/>

---

**MENU: [HOME](#) » [Reconstruction](#) » [Recovery](#) » [Renewal](#) » [Survival](#) » [Humanure](#)  
[Content](#)**

---

## Pot Luck Literary Appetizers

### Reader Feedback from the First Edition

The first edition of this book was self-published on a meager budget and was expected, by the author, to require a total lifetime print run of about 250 copies. It was assumed that there was little, if any, interest in the topic of composting human manure, but the degree and nature of feedback that resulted from this unlikely book was surprising. The first edition of Humanure eventually amounted to over 10,000 copies in circulation. Excerpts from a sampling of the letters sent to the author are presented below. Some of the writers offer insight about their own composting experiences, which you, the reader, may find useful or interesting. At the very least, the following testimonials are inspiring, and they indicate that more than a few people care about our planet, and how we live on it.

“Thank you so much for your book. I believe that it is one of the most important books ever written. (I also enjoyed your web site very much.) I finished reading your book less than a month ago and have already participated in building two compost bins and am currently in the process of building the toilets to go with them.” S.U. in ME

“The potential of the ideas in Humanure is so great in problems such as hollow food, landfill capacities, population densities . . . that I feel rather evangelical about the book and hope that others will also.” R.S. in OH

“If this short sentence, ‘We are defecating in our drinking water,’ was put in front of our eyes frequently enough, more and more people would realize that this absurd behavior can’t go on much longer.” S.A. at BioLet International “You have done the world a great service, and I thank you from the bottom of my (heart)!!” B.F. in NV

“I’m so glad you wrote this book - one lady told us it should be required reading for everyone on the planet!” D.W. in PA

“My husband and I own a small sawmill with plenty of leftover sawdust needing to be put to use. Also, my 74-year old father thinks human waste should not be used in a garden, and I want to prove him wrong.” A.M. in WA

“Your book is pure gold, just what I needed to give to my County Health Department head who is willing to go along with my desire for alternative systems.” M.T.

“Your discovery of the proper small scale of the operation is world-shaking, together with the exemplary continuous-by-small-increments rate of production.” F.A. in DE

“I enjoyed your book immensely. It clarified several technical and practical points. My mother is appalled that we would put one of ‘those things’ in the new house we’re building, certain it can’t be legal. Now that you’ve put the point in print we’ve been reduced from lawbreakers to just crazy. Pleasing me and irritating my mother, you score big in my two favorite categories.” K.L.

“This wonderful book fits right into my COMPOST=REDEMPTION religious philosophy. You have answered questions I have held open since childhood.” R. in MA

“May I join the chorus, too? The most exciting book I’ve read in a long, long time is yours. What a gem! Fun! A bumper sticker ad for the book should read, ‘The Humanure Handbook Proves It: People Are Smarter than Shit!’ Some people, anyway. ‘Fecophobia’: A new word for me and one that speaks volumes. As E.O. Wilson discovered ‘biophilia,’ so there is such a thing in humans as ‘biophobia,’ and you’ve discovered and named very appropriately one of its roots: fecophobia. It’s a real problem, and its solution, I think, is biophilia, fecophilia. Your discovery of appropriate shit technology, including an appropriate ‘throne,’ makes the billions we spend so we can shit in drinking water appear finally and totally absurd.” V.L. in FL

“I should have written this letter sooner. I would like to say that it is relatively rare to read a book of the calibre of the Humanure Handbook. A book that is enjoyable to read, empowering, hilarious, and has eye-candy pictures throughout. It’s an unbeatable combination.” J.D. in CA

“My budget is limited, so I don’t buy many books. This one, however, I really had to have for my personal library. I borrowed your book via interlibrary loan and have already read it twice, but I wanted one to keep! Please send the Humanure Handbook!” L.M.

“I really celebrate your book and your willingness to step forward and break the crystallizations of fear around composting human manure. I know for a fact I would not be taking the steps toward taking responsibility for managing the feces and urine within our community without this book.” L.F.

“After having finished your book, the Humanure Handbook, I’m more convinced than ever that those in charge of our society have no idea what the hell they’re doing.” J.R. in ME

“I knew nothing about this topic and by chance I purchased your book. Before reading I felt a little reluctance. However, once I started reading, I couldn’t stop. As English is not my mother language, it took a lot of time (all the words I didn’t understand I looked up in

my dictionary). You are doing a great service to humanity by having the courage to publish your book. It is said that example is the best teacher.” B.E. in Belgium

“Your book proved to be not only entertaining but also an invaluable source of information and reference. Thank you! At the hostel, your book has made it to the ‘shelf of recommended literature.’ On this shelf we display books we recommend our guests to read. Your book is placed between Thoreau’s *Walden* and *The Encyclopedia of Organic Gardening*.” J.N. in GA

“I just wanted to thank you for your valuable research you have done on the sawdust toilets. I enjoyed your book very much and have loaned it to many friends who seemed too embarrassed (or cheap) to buy it themselves. There must be quite a few readers of your book out there because I am seeing quite a few sawdust toilet and human manure discussions going on in the various straw bale and homesteaders news groups.” D.K. in IL

“I’m just reading the *Humanure Handbook* and kicking myself for a fool! I’ve been composting for a long time. I’ve been buying everything I can on composting — old and new — especially on composting toilets and have been banging on about it for years, but have never managed (apart from the mouldering *Clivus*) to use one. Now the solution is so simple I shall simply remove our existing W.C. under the stairs and replace it with a sawdust toilet and everything else is in place! At the moment, I’ve been saving all my urine, which I add to the woodchip piles and that steams along merrily enough. Thanks for your book and providing the missing link! Yours steamingly,” N.S. in UK

“My wife and I found a copy of your *Humanure* book last year, and have been living well with a sawdust toilet since then. (A blessing, after having spent gobs of time and money putting together a 150 gallon fly-breeding solar toilet — nothing like feeling little crawlies on your bum!)” P.U. in NM

“One thing you’ll get a perplexing kick out of regarding *Humanure* and Papua New Guinea is a problem. Shit is part of you, goes local tradition. There it is, wasn’t there before, dropped out of you. Therefore, it is you. Now with witchcraft being a major player here, all one has to do is pick up some of your shit and do nasty things with it (incantations or who knows what) and voila! you’re done for. When I asked one very devout Seventh Day Adventist lady how her father died, she said, ‘The traditional way. Someone didn’t like him and made magic against him.’ Joe, I don’t think *Humanure* stands a ghost of a chance here, although I’ve mentioned it several times to the living. Go figure on this one.” D.B. in New Guinea

“I am working as a development advisor to the Minister for Agriculture and Livestock here in Papua New Guinea, and [am] working on ways of encouraging people to shifting agriculture practices to site stable agriculture, which will require the input of more organic

material as Papua New Guineans generally have insufficient finance to purchase chemical inputs. Some time ago I purchased . . . a copy of the Humanure Handbook, and I found it quite fascinating. Thanks for the information you put together in the Humanure Handbook.” P.H. in Papua New Guinea

“I’m wracking my brain, trying to find a compelling way to tell you how great I think your book is. Here are some stabs: By the time I got to page 61, I had a mud bucket and a bag of sawdust set up in my bathroom.” K.W. in WI

“Just finished reading your book, and I’m glad. Seeing Mr. Turdly dancing around the compost pile wasn’t my ideal dream. Overall, I think your simple, low-cost and safe thermophilic system is a fantastic solution I’ve been looking for. I’ve been composting and using my own waste the past 20 years. Most of my friends think it odd. I counter that not even barbarians piss and shit in their drinking water.” E.S. in WA

“Please send me two copies of your beautiful book. I live and work at an International Youth Hostel . . . and we’re using your sawdust toilets.” B.S. in GA

“For 22 years, I have used scarab beetle larvae . . . they eat my shit in 5 minutes flat.” C.M. in SC

“I really appreciate the fact that someone finally did their research and put it together in a pleasant, readable form. I have felt strongly about our absence in the food nutrient cycle for a long time, but lack the talent of articulation that you have shown. We have been recycling our humanure since 1979.” S.C. in WI

“Great book! Thanks so much for writing it! I had to call my dear heart long distance immediately to read her what may be the most hopeful environmental news I’ve heard in my 35 years, that something can transmute horrible toxins. Why aren’t all the environmentalists raving about this and demanding major research on the applications?” C. in VT

“Your recently published book, the Humanure Handbook, is one of the most serious and humorous, well-researched yet humble, and motivating works I have read in a while. My personal research for some time now has focused on how to maintain soil fertility with minimal or no reliance on synthetic fertilizers. While I have focused on soil attributes that provide native fertility, I have known all along that a chunk of the cycle was absent. If you could claim credit for engineering the thermophilic decomposers, you would probably win the Nobel Peace Prize.” T.C. in AZ

“From the squatting position, I request a copy of the Humanure Handbook.” E.P. in RI

“I already knew that composting human waste made sense, and I had been looking for more practical information. Your book was exactly the information I was looking for, and it inspired me to put the ideas into action.” B.C. in NYC, NY

“Thank you for putting the time, energy, [and] money into creating this unique, needed book. Your wit, wisdom, factual references and above all, your personal experience, make it a great and encouraging work.” C.L. in NY

“Thank you for providing the information on dealing with shit in a responsible manner. As you know, the simple logic and responsible actions outlined in your book are rare in our society.” J. in AK

“I recently read and thoroughly enjoyed your Humanure Handbook. I am an engineer who currently designs services, including sewers, for new developments. In recent years, however, I have become convinced that the way we deal with humanure, as you call it, is not far short of ridiculous. So, I have begun to educate myself about alternative ways of treatment and reuse.” D.C. in Canada

“Thank you for your wonderful book about an environmental threat most people are unwilling to discuss, yet contribute to daily.” P.K. in NH

“I have taken three dumps since finishing the Humanure Handbook, and all of them have been in plastic buckets and have been covered with sawdust.” M.W. in WA

“You’re right, it is the shittiest book I’ve ever read — but it’s great! Have been a composter for a long time, but you showed me some new tricks.” R.H. in WY

“I want to thank you all so much for the ‘pioneering’ work you have done with humanure and writing the Humanure Handbook . . . with the information you have provided I can complete the cycle.” R.B. in FL

“I . . . spied an ad for your book, the Humanure Handbook . . . up until that point, it had only been a dream to somehow use my waste for fueling something that is necessary for my way of life. Now I have hope for a better future for myself, my family, and for the generations that will live on in this world after me.” O.M. in CA

“A little over a year ago . . . I was in Guatemala . . . when I came upon a certain Humanure Handbook being carried around. I only had access to the book for less than one day, but . . . I devoured it, became a proselytizing devotee of the composting method and thermophilic bacteria and I am forever grateful to you for your amazingly thorough research and easily readable and digestible book.” R.T. in CT

“Thank you for putting out such an important book . . . it feels good to know that there are fellow humans out there that realize that there is a way, a healthy way, to our actions that is good for all.” D.D. in Canada

“Really enjoyed your book! As a public health person and 25 years as an organic gardener, the content was great.” J.P.

“I am stupefied after reading your turdly book! What a masterpiece of modern literature. A real wake-up call for human types. In the future, I intend to follow all of your sensible suggestions and have a sawdust toilet.” W.K. in AZ

“Your book was extremely well-written and answered all the questions I had been having for several years. I knew that somehow there was some missing info about what to do with all the ‘do-do’.” R.L. in FL

“I just picked up the Humanure Handbook. It is full of humor, pluck, good advice and spirit. Someone I know locally has been championing your system for the past year. I’ll have to try it myself.” M.Z. in CA

“I’m almost done reading your book. Terrific. It definitely goes on a shelf next to How to Keep Your Volkswagon Alive and a few other ‘anybody-can-do-this’ type treasures. You’ve got me convinced. I’m partway through building a new house, and I’ve penciled in where the bucket will go.” D.B. in MN

“For many years, I have wondered why we can use cow and horse and pig manure for our gardens, but not human manure. I showed this article to my father who was raised on a farm and he almost gagged. He couldn’t even finish reading the article. I guess you’d call him a fecophobic. Could you mail the handbook in a wrapper that has no mention of ‘humanure’? I live with my parents.” M.C. in CO (future composter)

“I recently purchased your Humanure Handbook. It is fabulous. I want to give it to EVERYONE. Please send me four more.” L.F. in CA

“I have just finished your book . . . and I’m still wiping the tears off my face from laughing so hard. I never thought a book about human excretion could be so humorous, as well as very informative!” A.R. in OH

“I heard so many good things about the book while in the United States for summer holiday . . . that I combed all the bookstores for a copy of it. I am happy to report I have suffered no buyer’s remorse since the purchase. The book is extremely moving, in all sorts of ways. When I leave the urban desert, I plan to practice what you preach in the book. Even more exciting is the prospect that your book has darn near sold my wife on the idea,



too. When she sees the system you describe in action, I know she'll make the final step onto the bandwagon." D.G. in Abu Dhabi (United Arab Emirates)

"We had been looking for some info about safely composting our do-do for some time. Your book was a blessing and please know that it was an easy, fun read. Got the toilet installed day before yesterday and built a bin yesterday. Thank you for all of your hard work in doing the research and letting us all know that we are not alone in our way of living a more civilized way than the present barbaric generation we find ourselves among. What you have given us is the info we have been seeking, which empowers us to make an almost perfect circle with our resources." R.L. in FL

"Two things you might be interested in: a more natural way to eliminate is in the squatting position (supports the colon and all that shit). Maybe you might show (or offer the thought to future readers) of raising the knees higher — a step (simple block of wood, or big rock might be one solution). Also, more (food?) for thought. Urine is not a waste product. It is from the blood in our body. The excess nutrients and minerals that the body does not need at that moment has been filtered out (how marvelous). Taking urine internally has been going on for some time (1000s of years) and by many is considered a wonderful medicine. (Reading: 'Your Own Perfect Medicine') I take my first urine daily. Also, urine is used today in Murine's Ear Wax Removal, hand creams and other [products]. Now is that full of crap . . . or is it?" W.E. in OH

"Your book saved my butt at a town council meeting yesterday. Thank you for writing it." D.W. in CO

"With raised beds and numerous compost piles, it was only natural to be loaned a copy of the Humanure Handbook (carefully handed to me in a plain brown paper bag at church last spring). Great research, clear writing and terrific humor! I really should return that copy, so please send me one." L.U. in WV

"For over 40 years we have lived a more 'natural' way of life. Now the 'Authorities' are making it known we must conform to more (according to their beliefs) appropriate ways. He is 88 and I'm 77 — we need this help now! Please send us a copy of the Humanure Handbook." E.P. in NH

"As parasites attached to the Earth, it would seem that the only conscious thing we do that isn't killing the host, is manuring in the woods, fields or [in] a composting toilet." D.G. in MN

"In the past month I've made two humanure converts, both single women (living separately), both organic gardeners, both professional cooks. The biggest lure for them was the quality of my garden, and the opportunity to avoid purchasing fertilizer and soil

amendments. Now they're hooked, preaching to their friends. Could be the start of a Big Movement." L.W. in WA

"I have just finished your book, which I found in somebody's house near Plettenberg Bay in South Africa. It took me four hours, cover to cover, and it's 3 a.m." A. M-J. in South Africa

"I just got your Humanure book and want more! We are trying to educate the Commissioners and public regarding doing the right thing and your book is timely!" T.P. in NJ

"Could you send me a copy all the way to Guatemala? Communities are ready to start a composting toilet project . . . send it as soon as you can." T.B. in Guatemala

"I liked your book. Putting back nutrients after taking them away makes sense as well as the image of dropping a turd in a five gallon toilet filled with pure drinking water seems crazy." T.O. in NH

"I work in a number of ways with state agencies that 'regulate' compost and land applications of biosolids. I will read your book with an eye toward putting copies in numerous hands — from bureaucrats to legislators to environmentalists — and more." D.R. in TX

"We are just beginning on the adventure of 'recycling' all of our human waste, including manure. And there is so little written that is available — I'm really glad that you took the time to write about your experience." D.P. in CA

"We're a couple of kids (late 60s-early 70s) pursuing composting. It's the only sensible and logical way to go." C. K-L. in OR

"I found your book entertaining, informative, and a great motivating force compelling us to start recycling our 'humanure' immediately. Having grown up with outhouses . . . I always thought there had to be a better way." B.W. in TX

"I'm the graduate student you just sent a copy of your handbook to. The book and resource list have both been just what I needed. I'm trying to get my parents thinking about composting their 'reusable' body materials (they already compost kitchen scraps, as I do). They are in the country with a very shallow well. They are already short of water and their troughs used to catch rain are dry. Dad is a Parasitologist, so you know he'll want to make sure the stuff heats up right. I would like to buy them one of your books. That'll make a good birthday present for Pops." S.M.

“We have a cabin in the mountains of North Central Washington that is off the grid, off the road and off just about everything. My wife and I spent Thanksgiving there and at this time of the year the outhouse is very uncomfortable. I believe your book will allow us to move it to more comfortable quarters.” L.V. in WA

“I’ve spent my whole life recycling, reducing and reusing everything but my own shit and I [am] ecstatically grateful to have your directions reach my lap.” W.

“Thank you for your work in the Humanure Handbook. Your ideas have been a real encouragement to me to give composting a try in my sustainable home project. I was impressed by your research, the depth and scope of your study.” J.D.

“The reason I’m writing is because I believe worm-egg phobia is overblown. I’ve been a pig farmer for decades, had probably literally tons of pig manure dumped on me over the years, have had pig manure get inside open bleeding wounds, have had it ‘splash’ into my mouth, and I can say that I’ve never gotten ill from it nor have I had any intestinal problems except when I got my divorce (ulcer). But I can say quite accurately that I’ve gotten ill a few times from eating in restaurants. I ask you, which is more dangerous, restaurant food or hog manure?” R.T. in WI

“Our son’s Pa . . . was the one who tracked down your book . . . got our head librarian to order one for the Islands library and then created his own techniques. He feeds his bucket to several worm bins. They keep up with it . . . and it smells just fine. He also lines his bucket with a brown paper bag. It keeps clean-up easier — and is a great use for a bag that’s had several uses but isn’t fire starter yet. He found an antique porcelain receptacle with a toilet seat half buried in a vacant lot next to us and gifted me with it. A four gallon square bucket fits nicely and gives me over two weeks of use. When its full, I strap the plastic bucket onto my custom-made bike cart and off I go to our neighboring 10 acres where we are moving to this spring. I’ve got a bin set up using pallets on four sides — three narrow pieces of plywood overlapping on top with rubber tires to hold them down (all recycled, naturally). We’ve got huge piles of straw, manure, sawdust matter from the fairgrounds, bales of hay, bags of leaves and then I’ll occasionally bring some kitchen scraps over. My serious winter sprouting gives me root mats after harvesting buckwheat lettuce, wheatgrass, and sunflowers. They are a great layering agent in our worm bins. I must say — this is very exciting to us — and I can’t wait to dip my probe down into my pile in say, two years. I had to chuckle last week when I came around the corner on my bike with cart and bucket in tow. There was my neighbor directing this huge septic tank down into an excavated hole right next to his house. Everything about his ‘new’ home says toxic to me!” B.L. in WA

“Ah hah!! There is an intelligent lifeform out there. My husband and I have seen your book advertised in Countryside magazine for a good while. I finally came across it at the

local library, checked it out and will eventually add it to our library. Great reading, common sense information, very well researched. We started your sawdust toilet idea at once. We are old dogs, but not too old to know a logical thing when we read it. Thanks, and bless you and yours.” E. & J.C. in OH

“Thank you so much for your book, humorous and well written. We are enjoying it. We have just received it yesterday. We will be posting you the pictures of our composting toilet on the beach this week. And again many thanks.” G.F. in Indonesia

“Humanure and the potential for large-scale . . . even a city size composting collection (apartment building toilets into a central collection dumpster), along with the crimes of the so-called ‘septic system,’ has become one of my most favored topics of conversation and promotion. Often through direct exposition at our farm. Many thanks for your noble work of art and contribution to this stinky species of ape.” R.T. in CT

“I couldn’t resist writing you to say how much I enjoyed your book. Normally I can’t absorb the written word very easily, but I soaked yours up, which I guess is rather appropriate. I’ve been composting for several years now. Robotically and indifferently at first, but gradually developing to a level which I can only describe as obsessive. I bore everyone silly talking about it — except my fellow composters, that is, and there are several around here. As I got more into it, I found myself thinking about the possibility of composting bodily harvests, until it got so every time I sat on the loo and performed, I was begrudging every turd! Becoming more and more conscious of the waste and stupidity of the whole system with every plop, the idea slowly formed in my mind that perhaps I could do something about it. Reading your book clinched it. I have resolved to pull out of the mainstream sewage system, hence the ordering of the most capacious compost bin I could find. As the rest of my family find the idea abhorrent (ha, ha — in their lifetime it will most likely become law!), I’m forced to go it alone.” J.M. in England

“As a small publisher and writer, I don’t often take the time to write fan letters and testimonials, but this is both. We’ve lived on a small island in the Pacific coastal rainforest for 20 years and have been composting/mouldering our shit since we moved here. We’re glad to have some new arguments to use from your book as, over the years, a few guests weren’t too enthusiastic about our system.” C.H. in Canada

“We’ve read your book from cover to cover and are planning to implement it this summer when we move to our paid-for place in the country. Thanks for the great information. I publish a Christian Homesteading magazine. We will [also] be publishing a special newsletter devoted to Y2K problems . . . deal[ing] with the nitty-gritty, how-to preparedness topics and Humanure compost toilets will fit right in.” J.E.

“We live in Mexico in the high desert of San Miguel de Allende where the water is

precious and the soil is lousy. You've solved two of our biggest problems . . . My husband is so FECOPHOBIC, that he swears he neither shits nor farts. Getting him sold on the idea will be a problem. Any suggestions? I, of course, will be the one to empty the bucket." L. in Mexico

"Recently a friend of mine lent me a copy of your book *The Humanure Handbook*. To say that I enjoyed and found useful the contents and message of the book would be a considerable understatement. And in short i would very much like to purchase a copy of my own. Thank you for all your time and effort in making this information available." Rev. H.G. in CA

"Great book! I really loved it. We are soon to move to a new house. I can't wait to start composting humanure. Thank you for all the information in the book. It will sit on a special shelf in the bathroom — reading material for those occupied in communing with nature!" B.C.

"Twelve years ago, I designed and built a solar powered home, and have been repeatedly told (so I now believe) that I am a very creative person. So, as I was reading your incredibly inspiring, well-written, humorous, and innovative book, I kept asking myself . . . Why didn't I think of this? You are truly a gift from — and to — Mother Earth. Thank you, thank you." O.B. in ID

"I continue to be moved to hilarity by your writing, and the cartoons are pretty good too. Best of all is that your method of killing pathogens and parasite eggs and returning nutrients to the soil is virtually free. We are an environmental education center as well as a land trust community. So far we focus mainly on sustainable building, biointensive gardening, and wildlife management. I have a particular interest in a very simple lifestyle — sort of a radical eco-luddite anarchist type myself. Thanks again for the book!" M.M. in TX

"Your book came up in a search on Amazon.com and here I am, having just finished it, feeling like a man whose universe, at least one little corner of it, has condensed and collapsed, fallen into effortlessness, into rightness like a neutron star, like a compost pile. eureka! refinement! My shit makes sense! at last! Thank you." R.P. (fellow common-senser) in MA

*Source: The Humanure Handbook. Jenkins Publishing, PO Box 607, Grove City, PA 16127. To order, phone: 1-800-639-4099.*

<http://www.jenkinspublishing.com/>

**MENU:** [HOME](#) » [Reconstruction](#) » [Recovery](#) » [Renewal](#) » [Survival](#) » [Humanure Content](#)

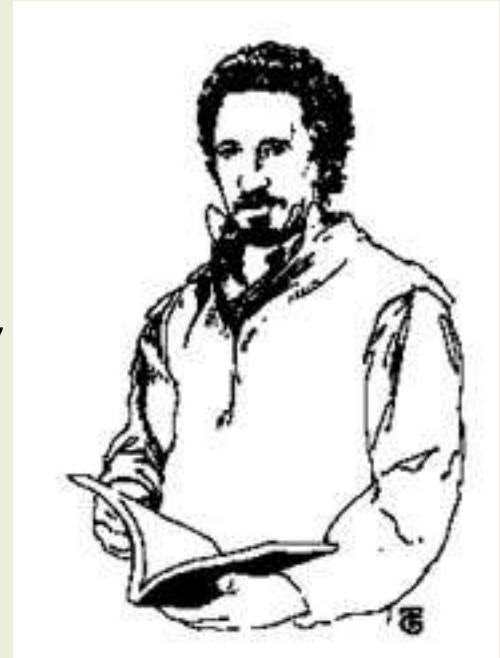
---

---

### A word with the Author

*"The balance of nature is . . . a complex, precise, and highly integrated system of relationships between living things which cannot be safely ignored any more than the law of gravity can be defied with impunity by a man perched on the edge of a cliff."*

Rachel Carson - *Silent Spring*



As I was writing this second edition of *Humanure*, I got a phone call from a fellow who was working on a national Community Disaster Preparedness Manual, a project with a federal mandate and federal funding. This project was precipitated by the concerns surrounding the “Y2K” (Year 2000) scenario, which was supposed to be fraught with the wholesale collapse of civilization due to pervasive computer design flaws. Computers would not be able to recognize the beginning of the new century and would just crash. This could result in wide-ranging and possibly prolonged disruptions of electrical, water, food, and fuel supplies, among other things. Or so we were warned.

The authors of this manual had to assume these disruptions could occur for two days, two weeks, or even two months, and the manual had to include instructions for all three of these contingencies.

The people working on this problem seemed to be able to come up with stop-gap solutions for every potential obstacle: food shortages (food can be stored), fuel shortages (wood or kerosene stoves can be used as backup heaters), or no lights (candles would work). There was one problem, however, for which no solution could be found. In fact, the fellow on the phone confided that they were considering abandoning the project altogether, because, in the words of many experts in the field, “it can’t be done.”

What exactly was this impossible problem, you may wonder? In a word — sewage. What do you do when the toilets won’t flush? What happens when the water doesn’t pump and the drains don’t drain? Conveniences like flush toilets are totally dependent upon the electrical grid and completely reliant on a constant water supply. When the electricity is out and water is unavailable, how do you flush a toilet? Answer — you don’t.

When this question was posed to the professionals in the field — wastewater treatment managers, waste management people, and sewage experts, they all drew a blank. One suggested that gravity drains would still work; sewage could be dumped down those drains, eventually reaching a wastewater treatment plant. It could then be heavily chlorinated before being discharged directly into the environment. He admitted this would only work for about two weeks until the chlorine supply ran out, after which the sewage would be released directly into surface waters, totally untreated. He also admitted that wastewater treatment plants only keep about a two week supply of chlorine because it is such a dangerous chemical. After two weeks, in a disaster scenario, raw sewage would be dumped into the environment — a situation that usually precedes the spread of deadly epidemic diseases.

Two things came to mind when I talked to the disaster-manual fellow. First, people need to realize that life as we know it won't continue forever. The environmental repercussions of our consumptive, throw-away lifestyles may catch up to us sooner than we think. Computers crashing may look like a Girl Scout picnic compared to global climate changes, cancer, new epidemics, and other calamities that can now be directly linked to our excesses. People also need to realize how fragile their lifestyles are, hanging by a thinner thread than they can imagine. Some power outages and food/fuel shortages could be a wake-up call for many.

Second, I never cease to be amazed at how thoroughly our society has ignored any constructive alternatives to sewage. We've put all our eggs in the flush toilet basket, and when the toilets won't flush, we're clueless. Ironically, it's this squeamish refusal to look at our own excrement that makes it such a threat to our health and safety. If we can't flush it, since we've developed few alternatives, we just dump it. This is a big mistake, not only because we're discarding valuable organic resource materials, but also because we're polluting our environment in the process, perhaps dangerously so.

So I told the disaster-manual fellow that two five gallon buckets and a large bag of peat moss or sawdust will make an emergency toilet for one person for two weeks. If a compost bin and a steady supply of sawdust or peat is available, that toilet could last indefinitely. With proper oversight and management, that person could be in a Chicago high-rise or in a Boston suburb. But I'm getting ahead of myself.

The point is that we don't know how to deal with human excrement because we don't see it for what it is. It's not a waste material, it's a resource material. When we see it as a resource, we can understand how to recycle it. When we adamantly insist upon seeing it only as a waste material, we're painting ourselves into a corner. By believing we have to *dispose* of that waste, we burden ourselves with an increasingly impossible challenge.

The first edition of *Humanure* went through four printings and around the world to at least 31 countries. It was discussed on British, Canadian, and US airwaves, and on US network TV. It was written up by the Associated Press, and in various national magazines. These are small accomplishments in the publishing world, but significant for a self-published author's first book. Yes, I did say *self-published*. That means I, the author, and I alone, take full responsibility for creating this book, designing it, getting it into print,



marketing it, and making sure it is distributed. I am not a person with deep pockets or an inheritance. I'm a person who writes during the winter months in a small office off my bedroom, at home, in Pennsylvania.

I first published *Humanure* with some degree of hesitancy. After all, composting humanure in America can be as bizarre a concept to some people as the sacrificing of small animals for religious purposes. I wondered how wise it was to publicly admit that I had shat in a bucket for decades. I knew I risked being considered some kind of crank. I imagined Merle at the local hardware store no longer wanting to shake my hand, or making haste to the washroom to scrub his hands immediately thereafter. I wasn't sure I even wanted anyone to *read* the book, and although I knew some people would be fascinated, I just didn't know who or where they were. I estimated that maybe there were 250 people in the US interested in the topic of humanure composting (one in a million), so I printed a small number of books the first time around and assumed they would sit in my garage for the rest of my life until I discovered, one by one, those 250 potential readers.

Was I ever wrong! No sooner had I printed the first batch of books than a friend wanted one. He showed it to his girlfriend, a newspaper reporter, and she showed up at my door — with a camera. In a matter of days, the story of a man composting his family's you-know-what in his backyard was out on the Associated Press, with a huge photo of me poking around in a compost pile with a pitchfork. The TV stations thought this story was newsworthy enough to broadcast, and a friend called to say he saw the book mentioned on the TV morning news. He laughed out loud as he told me of the lady news anchor stuttering when she had to say the word “turd” on TV. Someone should have warned her one of *Humanure's* chapters was titled, “*A Day in the Life of a Turd.*”

Next I got a call from a group of nuns wanting me to do a presentation about humanure at their convent. I never would have expected anything like this, but I obliged them, and they taught me something about spirituality and humility, which is mentioned in Chapter Four. As more time passed, I learned more and more new things from others. In the meantime, I kept selling out of books and doing larger and larger reprints. More speaking engagements popped up. Then the Pennsylvania Department of Environmental Protection told me *Humanure* was nominated for an environmental award. Even the BBC called from London and wanted to do an interview. I seemed to be getting a lot of publicity for a guy who didn't want anyone to read his book.

Then I started to get reader feedback. I suppose people won't write to you if they *don't* like your book, because all of the feedback has been positive. And a lot of it was intriguing enough that I have included “*Reader Feedback*” excerpts throughout this second edition.

Why *did* I write this book, anyway? Probably because I have personally recycled all of my family's humanure since 1979 (twenty continuous years at the time of this writing) using very simple methods. The resulting compost has always been used in our food garden. We have never produced any sewage from our home. Instead, all of our organic residues are carefully recycled by composting and are then returned to the soil, humanure included, thereby maintaining the fertility of our food gardens and

eliminating organic waste altogether.

As I wrote this second edition, I was interviewed by yet another newspaper reporter about my books. The young lady came to my home for the interview and asked, innocently enough, after we were well into the interview, “What do you do with your sewage?”

“We don’t have any sewage,” I replied, matter-of-factly. “I’ve lived here twenty years and we’ve never had any sewage.” The blank look of utter incomprehension on the young lady’s face was worth photographing. She didn’t have a clue, and I don’t blame her. I briefly explained to her that sewage results from the disposal of waste into water, and that when organic materials are instead collected without water and composted, there simply is no sewage. She vowed to cultivate her fledgling understanding of this new concept by actually reading my book. And that, it seems to me, is a good reason for me to have written it.

The more research I did on this topic, the more I realized there was precious little information about humanure recycling in print. It’s no wonder people’s faces go blank when confronted with the concept. Although bits and pieces of information were available, they were scattered about in hard-to-find, obscure references. I knew that where there is ignorance, there is misunderstanding. So I have compiled this information and written this book to try to shed a small ray of light onto what is otherwise a dearth of information. I do not claim, by any means, to have all the answers, but I do hope to be able to provide at least a *starting point* for those who seek information about the topic.

I do not consider myself an “expert.” I make no pretense along those lines. But with 24 years of organic gardening and composting experience, I’ve learned a thing or two which may be of interest to the average reader. I’m sharing those things with you now, and you can digest what you want, and, well, you know what to do with the rest.

By the way, Merle at the hardware store still shakes my hand. And I’m even getting used to his rubber gloves.

JCJ, Winter 1999

*Source: The Humanure Handbook. Jenkins Publishing, PO Box 607, Grove City, PA 16127. To order, phone: 1-800-639-4099.*

<http://www.jenkinspublishing.com/>

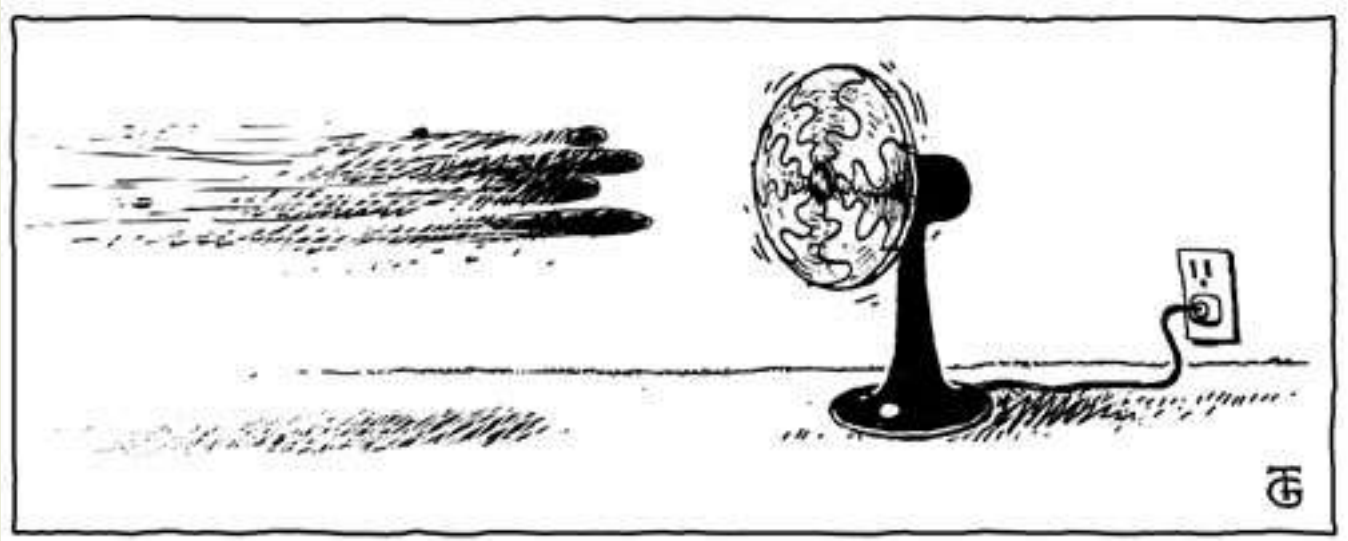
---

**MENU: [HOME](#) » [Reconstruction](#) » [Recovery](#) » [Renewal](#) » [Survival](#) » [Humanure Content](#)**

---

# CRAP HAPPENS

Something's About to Hit the Fan



*“Human beings and the natural world are on a collision course . . . No more than one or a few decades remain before the chance to avert the threats we now confront will be lost and the prospects for humanity immeasurably diminished.”*

1600 Senior Scientists from 71 countries, including half of all Nobel Prize winners, November 18, 1992  
World Scientists Warning to Humanity

There is a disturbing theory about the human species that has begun to take on an alarming level of reality. It seems that the behavior of the human race is displaying uncanny parallels to the behavior of pathogenic, or disease-causing, organisms.

When viewed at the next quantum level of perspective, from which the Earth is seen as an organism and humans are seen as microorganisms, the human species looks like a menace to the planet. In fact, the human race is looking a lot like a disease-causing pathogen, which is an organism excessively multiplying, consuming, and producing harmful waste, with no regard for the health and well-being of its host — in this case, planet Earth.

Pathogenic organisms are a nasty quirk of nature, it seems, although they do have their constructive

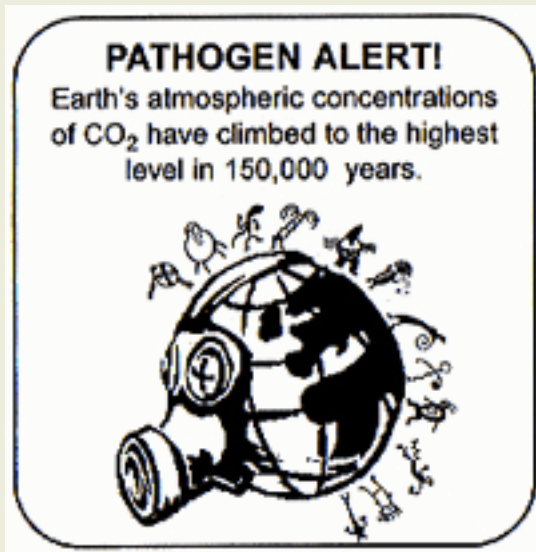
purposes, namely killing off the weak and infirm and ensuring the survival of only the fittest. They do this by overwhelming their hosts, by essentially sucking the vitality out of them and leaving poisonous wastes in their wake. Pathogens do not give a damn about their host organisms, and they often kill them outright.

This may seem a silly way for a species to maintain its own existence — after all, if you kill the host upon which you feed and upon which your life depends, then you must also die. But pathogens have evolved a special survival tactic that allows them to carry on the existence of their own species even after their host has died. They simply travel to another host, sending out envoys to seek out and infect other organisms even as their main pathogenic population succumbs along with their original host. A man dying of tuberculosis coughs on his deathbed, an act instigated by the infecting pathogen, ensuring that the disease has a chance to spread to others. A child defecates on the dirt outside her home, unwittingly satisfying the needs of the parasites inhabiting her intestines, which require time in the soil as part of their life cycle. A person stricken with cholera defecates in an outhouse which leaches tainted water into the ground, contaminating the village well-water and allowing the disease to spread to other unsuspecting villagers.

In the case of pathogenic organisms that kill their host, the behavior is predictable: multiply without regard for any limits to growth, consume as if there were no tomorrow, and excrete waste products that grievously harm the host. When this is translated into human terms, it rings with a disquieting familiarity, especially as we relentlessly equate human success with growth, consumption, material wealth, and profit.

Suppose we humans are, in fact, exhibiting disease behavior: we're multiplying without regard for limits, consuming natural resources as if there were no tomorrow, and producing waste products that are distressing the planet upon which our very existence depends. Well, there are two factors which we, as a species, are not taking into consideration. First is the survival tactic of pathogens, which requires additional hosts to infect. We do not have the luxury of that option, at least not yet. If we succeed at continuing our dangerous behavior, we also succeed in marching straight toward our own demise. In the process, we can also drag many other species down with us, a dreadful syndrome that is already underway. This is evident by the threat of extinction that hangs, like the sword of Damocles, over an alarming number of the Earth's species.

Second, however, there is one remaining consideration: infected host organisms fight back. As humans become an increasing menace, can the Earth try to defend itself? Absolutely, and in several ways. Number one is climate change, also known as global warming. When a disease organism infects a human



being, for example, one of the defense mechanisms our body deploys is the elevation of its own temperature. This rise in temperature not only inhibits the growth of the infecting pathogen, but also greatly enhances the disease fighting capability within the body. Global warming may be the Earth's way of inducing a fever — as a reaction to human pollution of the atmosphere and human over-consumption of fossil fuels. Sound ludicrous? Don't laugh — read on.

When the internal human body temperature rises, the microclimate of the body changes, allowing for the sudden and rapid proliferation of antibodies, T-cells, white blood cells, and other defenders against disease. As the *global* climate changes, and as the natural environment chokes with pollution, we humans do

have an idea of what sort of organisms nature can and will suddenly unleash to confront us. They're already beginning to show themselves as insect pest population booms, as well as new strains of deadly bacteria, viruses, and algae particularly toxic to humans.

So Earth's temperature slowly and inexorably rises, and, despite the potentially perilous consequences, humans try to ignore it. Global carbon emissions from fossil fuels are expected to reach nine billion tons per year by 2010,<sup>1</sup> and are expected to raise the Earth's temperature by two to six degrees Fahrenheit in the next century.<sup>2</sup> The Earth's temperature in 1998 was the highest ever recorded and exhibited the largest annual increase, setting “*a new record by a wide margin,*” according to NASA scientists.<sup>3</sup> The 15 warmest years on record have occurred since 1980.<sup>4</sup> The highest ever sea temperature in the North Atlantic was recorded in 1995, the same year that twice the normal number of tropical storms occurred. Today, ecologists are shocked to see large portions of Antarctica melting, breaking off, and falling into the Southern Sea.<sup>5</sup> All the while, spokespersons for the fossil fuels industry, the largest economic enterprise in human history, dismiss the frightening evidence as merely environmentalist scare tactics, unsubstantiated by valid scientific proof.

As the planet's temperature rises, it gains a momentum that cannot be stopped, no matter how desperate or repentant we humans may eventually become. The Earth's “fever,” like a spinning flywheel, will only subside in *its* own time. With global warming and climate change, we may have created a Frankenstein's monster of astronomical proportions. Unless, of course, we are pathogenic organisms. If so, then we really don't care, do we?

*“A great change in our stewardship of the Earth and life on it is required, if vast human misery is to be avoided and our global home on this planet is not to be irretrievably mutilated.”*

World Scientists Warning to Humanity

Pathogens can often dwell for quite some time within the host organism without causing disease symptoms. Then something happens to spark their growth — they gain a sudden foothold and begin proliferating rapidly. It is at this point that disease effects begin to undeniably show themselves.

Humans began to *strongly* show their pathogenic potential toward the planet during the 1950s, ravenously devouring natural resources and discarding waste into the environment with utter carelessness. Since then, for example, our fish catch has increased by a factor of five, paper consumption by a factor of six, grain consumption tripled, fossil fuel burning quadrupled and atmospheric concentrations of CO<sub>2</sub> have reached the highest level in 150,000 years.<sup>6</sup>

Human consumption can be roughly measured by our output of material goods. Since 1950, the global output of human goods and services grew sixfold. Between 1990 to 1997, human global output grew as much as it did from the beginning of civilization until 1950. In fact, the global economy grew more in 1997 alone than during the entire 17th century.<sup>7</sup>

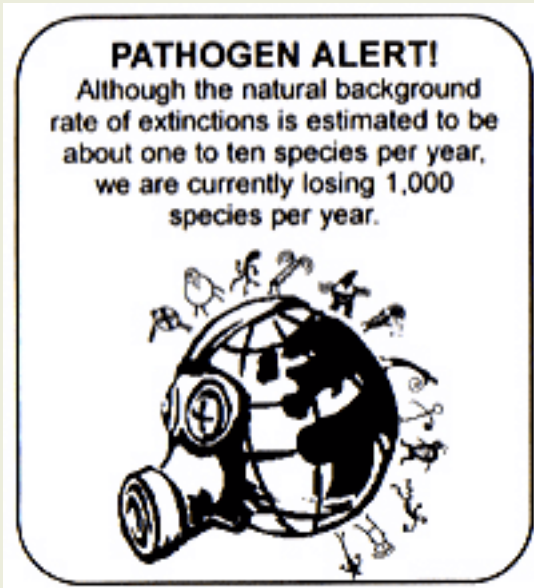
Now, at the end of the 20th century, our consumptive and wasteful lifestyles have painted a critical global picture. Almost half of the world's forests are gone. Between 1980 and 1995, we lost areas of forestland larger than the area of Mexico, and we are still losing forests at a rate of 16 million hectares a year.<sup>8</sup> Water tables are falling on every continent from one to three meters per year. Fisheries are collapsing, farmland is eroding, rivers are drying, wetlands are disappearing, and species are becoming extinct.<sup>9</sup> Furthermore, the human population is now increasing by 80 million people each year (roughly the population of ten Swedens). Such population growth virtually guarantees increased consumption as well as increased waste with each passing year.<sup>10</sup>

The damage of human over-consumption shows itself in other ways. Today, half of the coastlines and nearly 60% of the coral reefs on the planet are threatened with overdevelopment, pollution, and overfishing. Although almost no species of ocean fish was overexploited in 1950, now nearly 70% of fish species are either fully exploited or overexploited by humans.<sup>11</sup> Oceans and other bodies of water have long been used as dumps by the human species. For example, since 1950, mercury contamination has increased by a factor of five in the Baltic Sea. In the Black Sea, 85% of the marine species have disappeared.<sup>12</sup>

What about extinctions? The natural background rate of extinctions is estimated to be about one to ten species per year. Currently, it's estimated that we're instead losing *1,000 species per year*. More than 10% of all bird species, 25% of all mammals, and 50% of all primates are threatened with extinction. Freshwater fish now face a 37% extinction rate in America, 42% in Europe, and 67% in South Africa.<sup>13</sup>

Plant life is not immune to the forces of destruction that are threatening so many species either. Of 242,000 plant species surveyed by the World Conservation Union in 1997, one out of every eight (33,000

species) was threatened with extinction.<sup>14</sup>



What would drive a species to damage its life support system in this way? Why would we humans disregard our host organism, the Earth, as if we were nothing more than pathogens intent upon its destruction? One answer, as we have seen, is consumption. Somewhere along the line we learned to embrace the idea that more is better, measuring success with the yardstick of material wealth. Some startling statistics bear this out: the 225 richest people in the world (0.000003% of the world's population) have as much acquired wealth as the poorest *half* of the entire human race, while the wealth of the world's three richest people is equivalent to the total output of the poorest 48 countries. We in the United States certainly can raise our hands and be counted when it comes to consumption — our intake of energy, grain, and

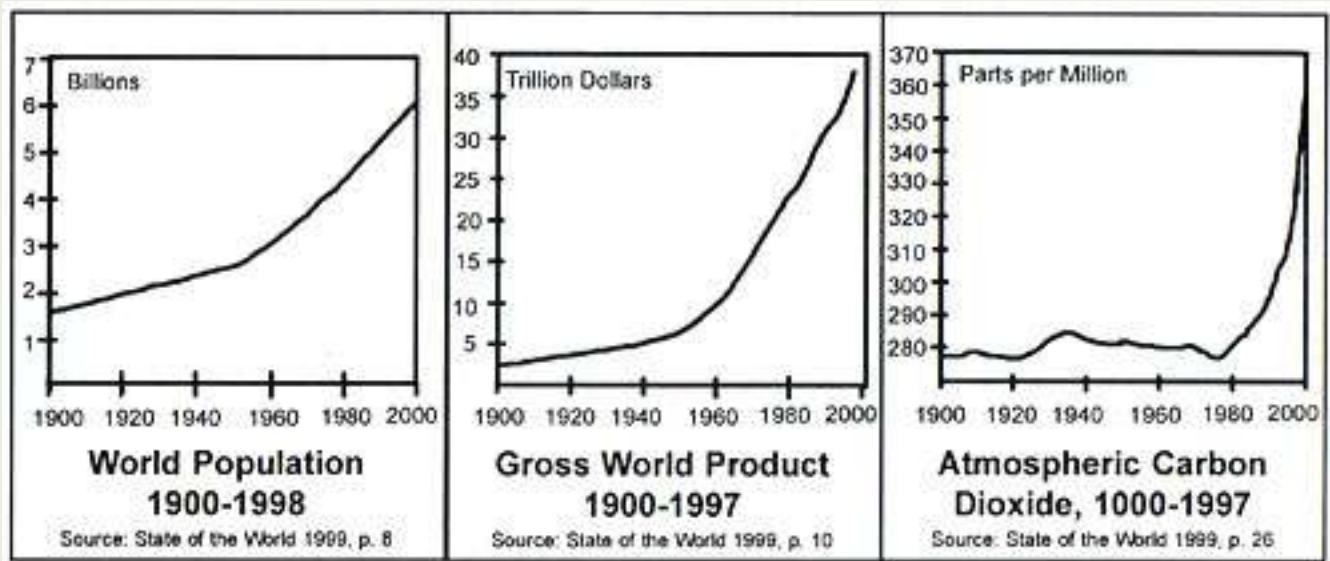
materials is the highest on the planet. We Americans can admit to using three tons of materials per month, each of us, and that's not counting food and fuel. Despite the fact that we are only 1/20 of the globe's population, we use 1/3 of the globe's resources. To sustain the entire world at this level of consumption would require no less than three planet Earths.<sup>15</sup>

*“There is an exceptional degree of agreement within the scientific community that natural systems can no longer absorb the burden of current human practices.”*

World Scientists Warning to Humanity

Wanton consumption breeds wanton wastefulness. Since the 1950s, more than 750 million tons of toxic chemical wastes have been dumped into the environment.<sup>16</sup> By the end of the 1980s, production of human-made synthetic organic chemicals linked to cancer had exceeded 200 billion pounds per year, *a hundred-fold increase in only two generations.*<sup>17</sup> By 1992, in the US alone, over 435 billion pounds of carbon-based synthetic chemicals were being produced. In 1994, well over a million tons of toxic chemicals were released into the <sup>18</sup> environment. Of these, 177 million pounds were known or suspected carcinogens.<sup>19</sup>

There are now about 75,000 chemicals in commercial use, and 3,750 to 7,500 are estimated to be carcinogenic (cancer-causing) to humans. That means that one out of every ten commercial chemicals may be cancer-causing — chemicals dispensed into your home via such common household items as aerosols, air fresheners, deodorizers, furniture polish, or the lumber used in the construction of your picnic table.



Toxic chemicals have been carelessly dumped into the environment since their creation. Forty thousand of the most notorious dump sites and hazardous waste landfills have been termed Superfund sites. Of these, there are 1,231 “priority” sites, with 40 million people (one in every six Americans) living within four miles of one.<sup>20</sup>

Today, as a result, 40% of Americans can expect to contract cancer in their lifetimes. I can think of quite a few people, personal friends, who have contracted cancer in the past few years. Marcia, an artist in her mid-forties, got breast cancer a couple years ago and had to have part of one breast removed. Kristin, a school teacher in her mid-forties, and a lifetime organic gardener, also contracted breast cancer last year. Nina (mid-forties) got breast cancer a few years ago and now she has no breasts at all. Kaye (mid-forties), a healthy, Bach Flower Remedy practitioner and natural food advocate, suddenly came down with breast cancer and died. She left several beautiful daughters behind. Sandy, another apparently healthy, slender school teacher in her forties, got cancer of the uterus and had it removed. She never had any children. My mother had lung cancer. Two of my aunts died of cancer. Several of my friend’s fathers have died of cancer, as well as several of my father’s friends. Other friends or their parents have had bouts with cancer, but survived. Some of these were people who lived healthy lifestyles, ate nutritious food, and were active. They still developed cancer. But then, so do animals in the wild, so do fish and sea mammals. Lifestyle seems to have little effect on whether one comes down with the disease. Why? Because there is no escape from the cancer-causing chemicals that now pervade our environment and enter our bodies through the food we eat, the air we breathe, and the water we drink. Even household pets are not immune.

The World Health Organization has concluded that at least 80% of all cancer is attributed to environmental influences. One glaring example of this lies in the fact that industrialized countries have a lot more cancers than countries with little or no industry. Breast cancer rates are thirty times higher in the United States than in parts of Africa, for example. Childhood cancers have risen by one third since 1950, and now one in every four hundred Americans can expect to develop cancer before the age of fifteen. Between 1950 and 1991, incidences of all types of cancer combined have risen 49.3% in the United



States. Cancer is now the second leading cause of death overall, and the leading cause of death among Americans between the ages of 35 to 64. Furthermore, the US EPA projects that tens of thousands of additional fatal skin cancers will result from the ozone depletion that has already occurred over North America.<sup>21</sup>

Cancer is not the only issue associated with the synthetic organic chemicals that we humans have created and have carelessly allowed to pollute the environment. Disturbing new evidence indicates that some of these pollutants mimic natural hormones and can wreak havoc with the endocrine (hormone) systems of many animals, including humans. Male fish are being found with female egg sacs, male alligators with shriveled penises, and *human* male sperm counts are plummeting. Some of these common organic chemical pollutants mimic estrogen, a powerful natural hormone governing the female reproductive system, an excess of which has been linked to cancer. Other chemical pollutants interfere with testosterone, the male sex hormone, or with thyroid metabolism. These chemical pollutants lodge in animal fat cells, traveling up the food chain to concentrate in higher animals — like us. They are becoming increasingly concentrated in human mother's milk, and they cross the placental barrier to enter developing fetuses. It's a well-documented fact that synthetic organic chemical pollutants have traveled far enough to pervade every corner of the world — you may have heard some of their names: dioxin, PCBs, DDT, 2,4-D. *The average person can now expect to find at least 250 of these chemical contaminants in his or her body fat.*<sup>22</sup>

Are cancer and endocrine disruption two of Mother Nature's defense mechanisms against organisms that have rudely gone awry? Are they not-so-subtle ways nature tells us that we're doing something wrong? Perhaps, and unfortunately the victims are often the innocent ones who bear no responsibility for the diseased state of the environment.

Our environmental misdeeds may be sowing the seeds of our own destruction in other ways as well. Damaging environmental changes seem to be contributing to the emergence of new toxic organisms, as well as the proliferation of old menaces such as malaria. Fifty new diseases have emerged since 1950, including Ebola, Lyme's Disease, Hantavirus, and HIV.<sup>23</sup> The World Health Organization reports that AIDS (HIV virus) is approaching epidemic proportions in several countries in Africa, and is spreading to India and China.<sup>24</sup> Researchers warn of the epidemic potential of the malarial mosquito population should global warming continue.<sup>25</sup> Others report epidemic levels of coastal algal blooms, some of which are highly toxic to humans as well as fish, and are directly linked to excessive human pollution.<sup>26</sup> Are these disease organisms some of nature's defense mechanisms, emerging in order to attack the human race? Although this is a chilling thought, it's not so chilling as the theory that this is just the beginning of the appearance of new diseases targeting the human race, and that future viruses may be as deadly as the plague and transmitted as easily as is the common cold.

*“In effect, we are behaving as if we have no children, as though there will not be a next generation.”*

Lester R. Brown

Some would say that it looks like our environment is going to hell in a handbasket. Others would

postulate that the human race is going along with it. Yet there are still those who would scoff at the idea that a tiny organism such as humanity could affect such an ancient and immense being as Mother Earth. This is a ludicrous concept, they argue; the very idea that the human species can be powerful enough to inflict illness on a planetary being is nothing more than egotism. Perhaps. After all, where is there any evidence that a planet can get sick and die? Where could we ever witness a planet that had once possibly teemed with life, where rivers flowed on its surface but long since dried up? Well, how about Mars?

What did happen to Mars, anyway? Our next door neighbor, the Red Planet, apparently was once covered with flowing rivers. What happened to them? Rivers suggest an atmosphere. Where is it? Was Mars once a vital, thriving planet? If so, why does it now appear dead? Could a lifeform on its surface have proliferated so abundantly, so profligately, and so recklessly that it deleteriously altered the planet's atmosphere, thereby knocking it off-kilter, and, in time, killing it? Is that what's happening to our own planet? Is it our legacy in this solar system to leave behind another dead rock to revolve around the sun? Or will we simply destroy ourselves while the Earth, stronger than her Martian brother, overcomes our infection and survives to flourish another billion years?

The answer, if I may wildly speculate, is neither — we will destroy neither the Earth nor ourselves. Instead, we will learn to live in a symbiotic relationship with our planet. To put it simply, the human species has reached a fork in the road of its evolution. We can continue to follow the way of disease-causing pathogens, or we can chart a new course as dependent and respectful inhabitants. The former requires only an egocentric lack of concern for anything but ourselves, living as if there were no tomorrow, as if there will be no future human generations. The latter, on the other hand, requires an awareness of ourselves as a *dependent* part of a Greater Being. This may require a hefty dose of humility, which we can either muster up ourselves, or wait until it's meted out to us, however tragically, by the greater world around us. Either way, we have to collectively make a decision, and the time is running out.

Fortunately, many competent people are already aware of and working on the problems touched upon in this chapter. Each of these problems is a piece to a puzzle, and each of them, when addressed individually, adds up to an overall solution. Like ants, we each work away at our particular areas of concern, doing our tiny bit to be a part of the solution to these problems, whether they be toxic waste, water pollution, global warming, cancer, or species extinctions.

It is ironic, however, that we humans have consistently ignored one problem that is very near to each of us — one waste issue that all of us contribute to each and every day — an environmental problem that has stalked our species from our genesis, and which will accompany us to our extinction. Perhaps one reason we have taken such a head-in-the-sand approach to the recycling of human *excrement* is because we can't even talk about it. If there is one thing that the human consumer culture refuses to deal with constructively, it's body excretions. This is the taboo topic, the unthinkable issue. It's also the one we are about to dive headlong into. For *waste* is not found in nature — it's strictly a human concept, a result of our own ignorance. It's up to us humans to unlock the secret to its elimination. Nature herself provides us with the key, and she has held it out to us for many thousands of years.

*Source: The Humanure Handbook. Jenkins Publishing, PO Box 607, Grove City, PA 16127. To order, phone: 1-800-639-4099.*

<http://www.jenkinspublishing.com/>

---

**MENU: [HOME](#) » [Reconstruction](#) » [Recovery](#) » [Renewal](#) » [Survival](#) » [Humanure Content](#)**

---

---

## WASTE NOT WANT NOT



*“WASTE: . . . Spoil or destruction, done or permitted, to lands, houses, gardens, trees, or other corporeal hereditaments, by the tenant thereof, to the prejudice of the heir, or of him in reversion or remainder . . . Any unlawful act or omission of duty on the part of the tenant which results in permanent injury to the inheritance . . .”*

Black’s Law Dictionary

America is not only a land of industry and commerce, it’s also a land of consumption and waste, producing between 12 and 14 *billion* tons of waste annually. Approximately 210 million tons of that total constitutes our annual production of Municipal Solid Waste (MSW), which is the trash each of us personally throws “out” every day.<sup>1</sup>

Much of our waste consists of *organic* material including food residues, municipal leaves, yard materials, agricultural residues, and human and livestock manures, all of which should be returned to the soil from which they originated. These organic materials are very valuable agriculturally, a fact well known among organic gardeners and farmers.

What does “organic” mean? The answer is interesting, as there are two opposing sides to this issue. Organic farmers and gardeners contend the word “organic” means that synthetic chemicals are not used

in farming or gardening processes. Chemists chuckle at this interpretation of the word, because in chemistry, “organic” is defined simply as any molecule containing carbon atoms. Many synthetic chemicals are therefore considered “organic” by the chemists of the world, simply because they contain carbon. When a chemist really wants to irk an organic gardener, he simply argues that his synthetic organic compounds (pesticides, for example) are “organic” by definition, and that his chemical garden therefore qualifies as “organic” as well. Technically, both sides are correct, although there is a huge distinction that must be taken into consideration.

Carbon is the basic building block of life. When the plant life of millions of years ago became extinct and settled into the earth, it was transformed into “fossil fuels” such as coal, oil, and gas, leaving plenty of carbon embedded in these fuels. These ancient resources have become the basic stock for the petrochemical industry, which manufactures many synthetic “organic” (i.e., carbon-bearing) chemicals, including the 2.23 billion pounds of synthetic organic pesticides Americans use each year.<sup>2</sup> Technically, these chemicals *are* “organic” because they’re derived from what was once plant life.

The ancient chemical stocks are altered and synthesized in laboratories to be *similar* to the physiological chemicals of today, which is why they work so well at killing insects and plants — they can enter their living systems and wreak havoc. Many synthetic organic chemicals make their way into human bodies as well, accumulating in the fat cells and fooling the body into thinking they belong there. They don’t.

Unfortunately, synthetic organic chemicals can mimic natural human hormones, thereby dangerously interfering with the body’s normal functioning. They can also damage human chromosomes, and cause cancer and numerous other diseases. Although technically “organic” because they contain carbon and are derived from ancient life, synthetic organic chemicals have become an environmental disaster due to their persistence (they hang around a long time in the environment), their pervasiveness (they have spread all over the world), and their ability to interfere with the normal functioning of the bodies of many animals (not just humans). For example, human mother’s milk has consistently shown contamination from synthetic organic chemicals since 1951,<sup>3</sup> and the incidence of human breast cancer has risen dramatically since then.

In a nutshell, that is why organic gardeners and farmers won’t touch synthetic organic chemicals with a ten foot tomato stake. Instead, they use only organic materials agriculturally that are from the *current* era (i.e., from things that were recently alive, such as trees, lawns, and animals, although peat may be an exception). Therein lies the difference in definitions of the word “organic.” To a chemist, any molecule that contains carbon is organic, no matter how altered it is from its natural state, but to an organic agriculturist, organic material must be benign and beneficial, not toxic and cancer-causing.

WASTE desperdicios مہملات ゴミ袋 垃圾袋 कृड़ा - कम्कट

## ELIMINATING WASTE

*“It is difficult to overstate the urgency of reversing the trends of environmental deterioration.”*

Feces and urine are examples of natural, beneficial, organic materials excreted by the bodies of animals after completing their digestive processes. They are only “waste” when we discard them. When recycled they are resources, and are often referred to as manures, but never as waste, by the people who do the recycling.

*We do not recycle waste.* It’s a common misuse of semantics to say that waste is, can be, or should be recycled. Resource materials are recycled, but waste is never recycled. That’s why it’s called “waste.” Waste is any material with no inherent value that is discarded and has no further use. We humans have been so wasteful for so long that the concept of waste *elimination* is new to us. Yet, it is an important concept that must become imbued into human consciousness.

When a potato is peeled, the peels aren’t kitchen waste — they’re still potato peels. When they’re collected for recycling as a resource, no waste is produced. Those of you who separate your organic material for recycling are creating no organic waste — a small but highly satisfying achievement.

Many people, especially compost, municipal, and academic professionals, nevertheless adamantly insist upon referring to these recycled materials as “waste.” This is called the “waste mentality.” Many of the people who are developing municipal composting programs came from the waste management field, a field in which refuse has always been waste. Today, however, refuse is increasingly becoming recognized as the resource it always was. Those of us who recycle are eliminating waste, and the term “waste” should not be associated with us. The use of the term “waste” to describe recycled materials is an unpleasant semantic habit that must be abandoned. If we’re eliminating waste, we should talk like it, and be proud of it.

## FUN FACTS

### Waste Not — Want Not

America is a land of waste. Of the top fifty municipal solid waste producers in the world, America is fifth in line, being outranked only by Australia, New Zealand, France, and Canada. Although the US population increased by 18% between 1970 and 1986, its trash output increased by 25% during that time period, indicating that as time passes, we become more wasteful as a nation. Today, every individual in America produces about four pounds of trash daily, which will add up to 216 million tons per year by the year 2000, almost ten percent more than in 1988. If this sounds like a lot, sit down for a minute: municipal solid waste (the 210 million tons per year just mentioned) makes up only one percent of the total solid waste created annually in the US. The rest

comes from industry, mining, utilities, and other sources.

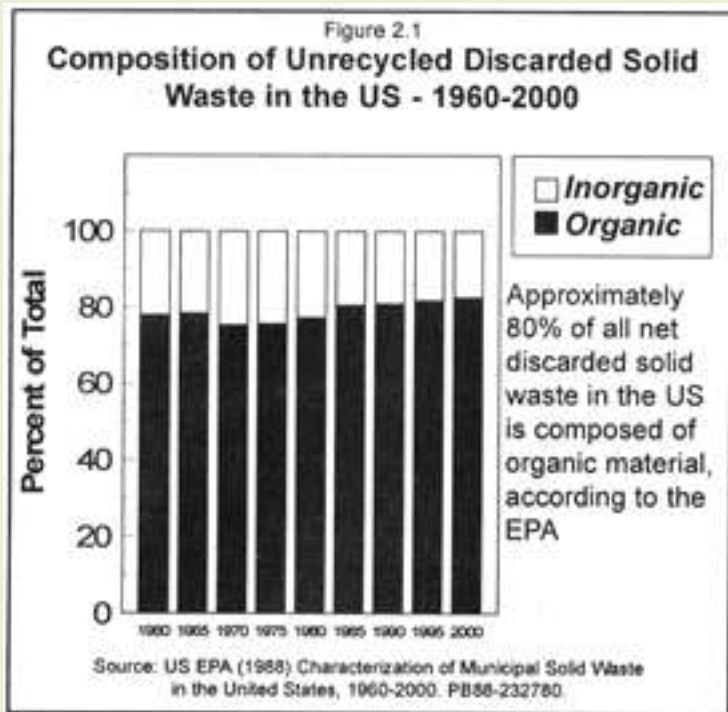


Source: Hammond, A., et al. (Eds.) (1993). 1993 Information Please Environmental Almanac.

Compiled by World Resources Institute.  
Houghton Mifflin Co. New York. (pp.50-51 and 339).

Following the semantics of the waste mentality, one would refer to leaves in the autumn as “tree waste,” because they are no longer needed by the tree and are discarded. Yet, when one walks into the forest, where does one see waste? The answer is “nowhere,” because the organic material is recycled naturally, and no waste is created. Ironically, leaves and grass clippings are referred to as “yard waste” by some compost professionals, another example of the persistent waste mentality plaguing our culture. Many of

us humans are trying to mimic nature by eliminating waste *as well* as the mentality that accompanies it, and many of us are succeeding. Hopefully the composting professionals who are stuck in the waste mindset will eventually jump on the “resource recycling” bandwagon. They should, after all, because compost professionals are the front line of an emerging army of people intent upon eliminating waste. Our species has created the concept of waste. It is up to us to avoid it altogether.



For many years in the United States, when people mowed their lawns, they raked the cut grass, stuffed it into large plastic garbage bags, and set it out on the curbside to be picked up by a garbage truck. The grass was then hauled away and buried in landfills along with the deodorant cans, disposable diapers,

magazines, and the host of other objects of

America’s throw-away obsession. Having lived in the country for many years and having had a compost pile since I was first able to dig the earth, I was not aware of this cult-like fanaticism among American suburbanites.

Then one day I visited some friends in the small town near where I live. They were a young couple; he had a Ph.D. and was a professor at the local university and his wife was just finishing her Ph.D.

dissertation. They had just mowed their lawn and had the green bags of grass clippings sitting out along the curb, open, with the contents plainly visible. I looked at the bags, but the sight of *grass clippings* being thrown out as if they were trash was so incongruous to me that, at first, it didn't register, until I did a double-take. "Why are you throwing out these grass clippings?" I asked incredulously.

"We've always done that."

"Why would you do that?"

"That's what you're supposed to do."

"Don't you have a compost pile, for heaven's sake?"

"What's a compost pile? Oh, you mean those big smelly heaps that rats get into? We don't have room for that."

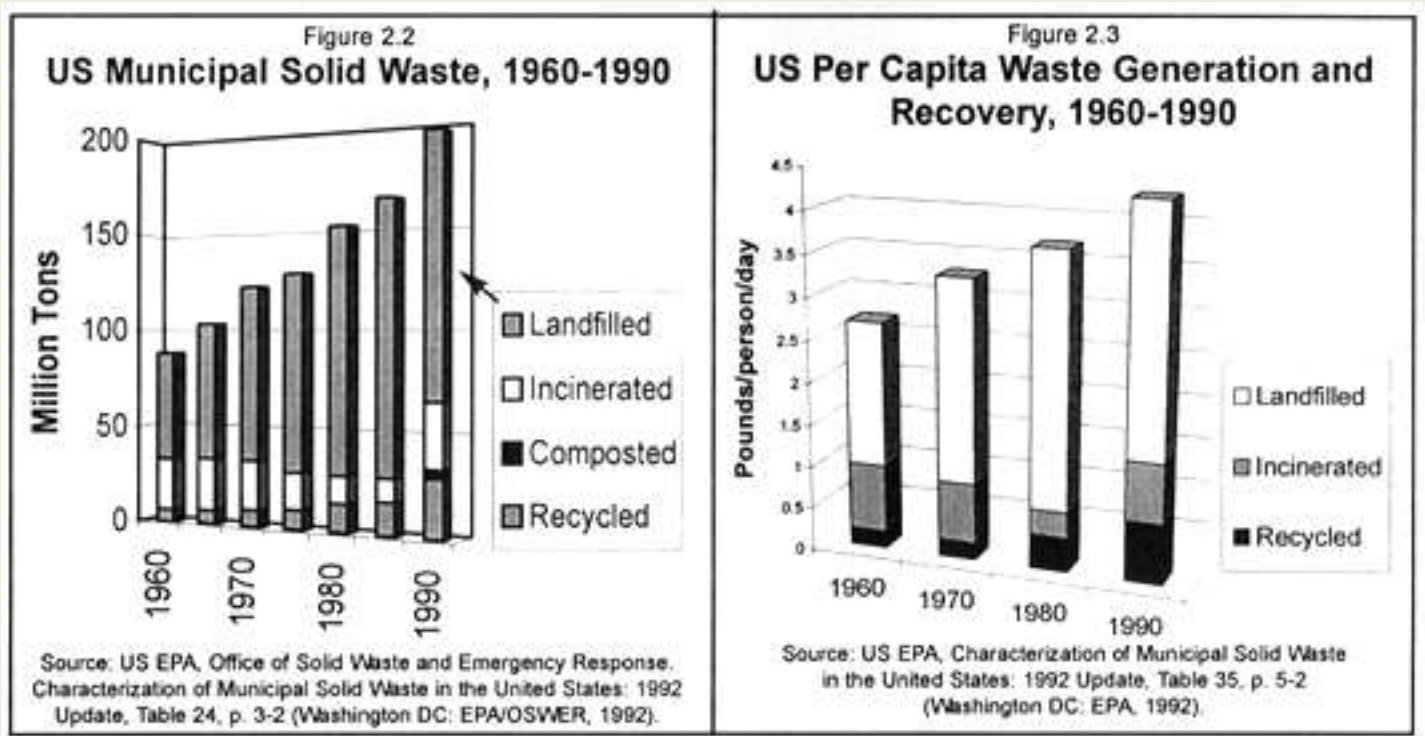
"You can use the grass clippings for mulch," I suggested, as I glanced around their roomy garden, seeing lots of places for compost bins. "Look, see those roses over there? They would love these grass clippings spread around them."

"Nah, we'll just let the municipality take care of our yard waste (emphasis mine)."

At that moment, I realized my poor friends had been working so hard at becoming experts, that they didn't have time to learn about the value of grass clippings. I also suspected that our educational system has been rather remiss in its responsibilities by ignoring fundamental basics of life, such as the need for organic material recycling. After some gentle persuasion, I took the bags and spread the grass around the roses, creating a lovely green carpet, while explaining the benefits of mulch and the powerful soil nutrients resident in grass clippings. My friends watched nervously, but soon relaxed after they realized no one was going to get hurt and no rats were going to jump out at them. I think maybe they learned something valuable that day, but would certainly get no credit for it at their university.

I must give credit where credit is due, however. Many people have realized that the disposal of organic yard and garden material in landfills is unwise, and now, in the US, many states have completely banned the dumping of these materials into landfills. Some of the people who've been responsible for these policies were highly educated, yet they *still* managed to figure it out.





Regardless of the benefits or the hindrances of one's education, we still find no waste in nature. One organism's excrement is another's food — it's that simple. Everything is recycled through natural systems so waste doesn't exist. Humans create waste because we insist on ignoring the natural systems that we are dependent upon. We are so adept at doing so that we take waste for granted and have given the word a prominent place in our vocabulary. We have kitchen "waste," garden "waste," agricultural "waste," human "waste," municipal "waste," "biowaste," and on and on. Yet, our long-term survival as a species requires us to learn to live in harmony with our host planet. This also requires that we understand natural cycles and incorporate them into our day to day lives. In essence, this means that we humans must eliminate waste altogether. As we progressively eliminate waste from our living habits, we can also progressively eliminate the word "waste" from our vocabulary. We can start with the term "human waste."

"Human waste" is a term that has traditionally been used to refer only to human excrements, namely fecal material and urine, which are by-products of the human digestive system. When *discarded*, these materials are colloquially known as human *waste*. When *recycled* for agricultural purposes, however, they're known by various names, including night soil (when applied raw to fields in Asia) and human manure or *humanure*. Humanure is not waste — it is a valuable organic resource material rich in soil nutrients, in contrast to human *waste*, which is a dangerous discarded pollutant. Humanure originated from the soil and can be quite readily returned to the soil, especially if converted to humus through the composting process. Admittedly, humanure is not as benign and easy to work with as grass clippings, but when properly recycled, it makes a wonderful soil additive.

Human *waste* (*discarded* feces and urine), on the other hand, creates significant environmental problems, provides a route of transmission for disease, and deprives humanity of valuable soil fertility. It's also one of the primary ingredients in sewage, and is largely responsible for much of the world's water pollution.

A clear distinction must be drawn between humanure and sewage. Sewage can include waste from many sources (industries, hospitals, and garages, for example) as well as the host of contaminants that seep from these sources (industrial chemicals, heavy metals, oil, and grease, for example). Humanure is strictly human fecal material and urine.

What, in truth, *is* human waste? Human waste is cigarette butts, plastic six-pack rings, styrofoam clamshell burger boxes, deodorant cans, disposable diapers, worn out appliances, unrecycled pop bottles, wasted newspapers, junk car tires, spent batteries, most junk mail, nuclear contamination, food packaging, shrink wrap, toxic chemical dumps, exhaust emissions, the five billion gallons of drinking water we flush down our toilets every day, and the millions of tons of organic material discarded into the environment year after year after year.

*Source: The Humanure Handbook. Jenkins Publishing, PO Box 607, Grove City, PA 16127. To order, phone: 1-800-639-4099.*

<http://www.jenkinspublishing.com/>

---

**MENU: [HOME](#) » [Reconstruction](#) » [Recovery](#) » [Renewal](#) » [Survival](#) » [Humanure Content](#)**

---

## THE HUMAN NUTRIENT CYCLE

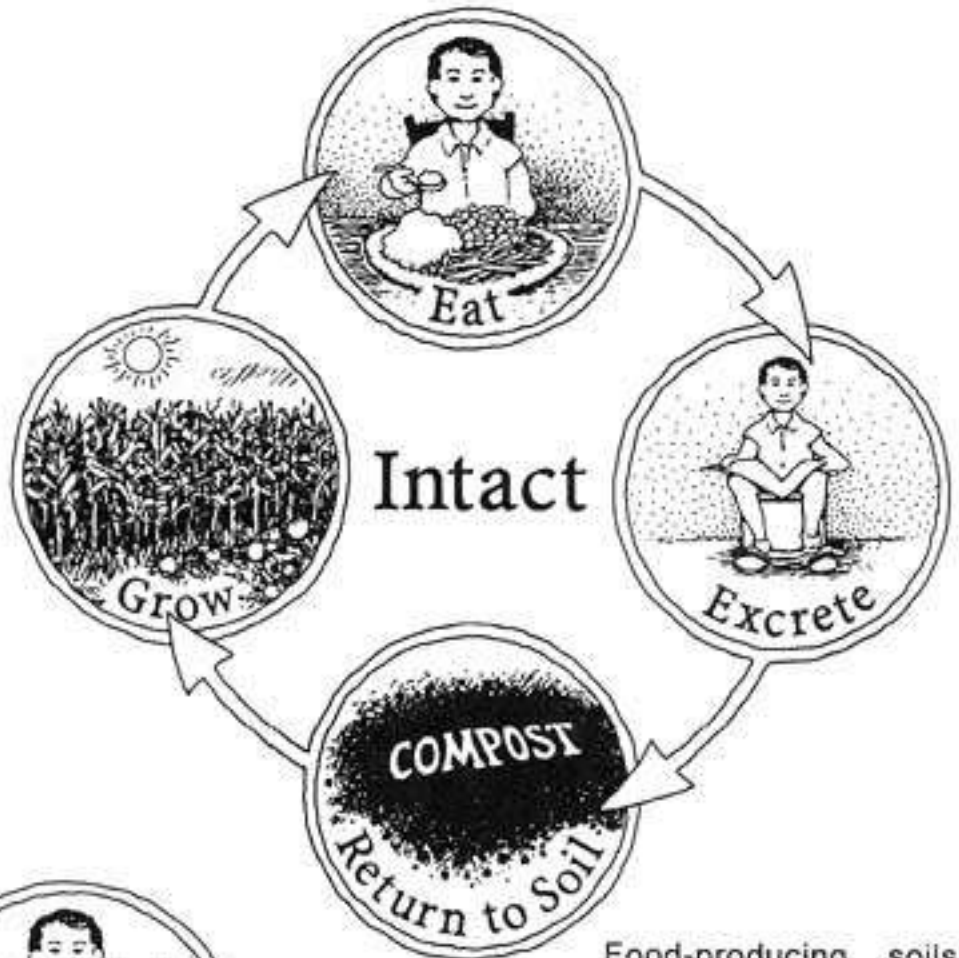
*“For the living, three things are inevitable: death, taxes, and shit.”*

Dan Sabbath and Mandel Hall in End Product

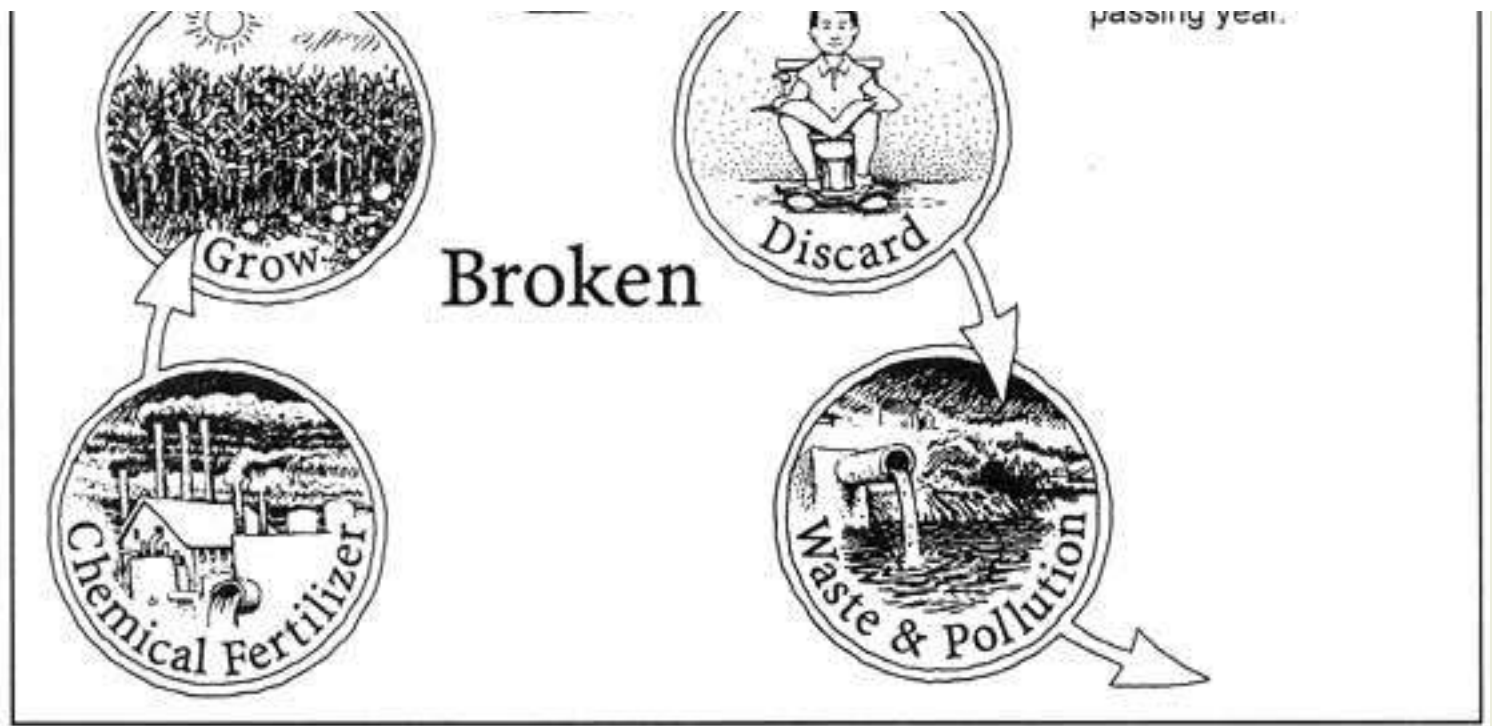
Figure 2.4

### THE HUMAN NUTRIENT CYCLE *INTACT* and *BROKEN*

The Human Nutrient Cycle is an endless natural cycle. In order to keep the cycle intact, food for humans must be grown on soil that is enriched by the continuous addition of organic materials recycled by humans, such as humanure, food scraps, and agricultural residues. By respecting this cycle of nature, humans can maintain the fertility of their agricultural soils indefinitely, instead of depleting them of nutrients, as is common today.



Food-producing soils must be left more fertile after each harvest due to the ever-increasing human population and the need to produce more food with each passing year.



When crops are produced from soil, it is imperative that the organic residues resulting from those crops, including animal excrements, are returned to the soil from which the crops originated. This recycling of all organic residues for agricultural purposes should be axiomatic to sustainable agriculture. Yet, spokespersons for sustainable agriculture movements remain silent about using humanure for agricultural purposes. Why?

Perhaps because there is currently a profound lack of knowledge and understanding about what is referred to as the “human nutrient cycle” and the need to keep the cycle intact. The human nutrient cycle goes like this: a) grow food, b) eat it, c) collect and process the organic residues (feces, urine, food scraps, and agricultural materials), and d) return the processed organic material back to the soil, thereby enriching the soil and enabling more food to be grown. The cycle is repeated, endlessly. This is a sustainable process that mimics the natural cycles of nature and enhances our ability to survive on this planet. When our food refuse is instead discarded as waste, the natural human nutrient cycle is broken, creating problems such as *pollution, loss of soil fertility, and abuse of our water resources.*

We in the United States each waste about a thousand pounds of humanure every year, which is discarded into sewers and septic systems throughout the land. Much of the discarded humanure finds its final resting place in a landfill, along with the other solid waste we Americans discard, which, coincidentally, also amounts to about a thousand pounds per person per year. For a population of 250 million people, that adds up to nearly *250 million tons of solid waste personally discarded by us every year, at least half of which is valuable as an agricultural resource.*

The practice we humans have frequently employed for waste disposal has been quite primitive — we dump our garbage into holes in the ground, then bury it. That’s called a landfill, and for many years they were that simple. Today’s new “sanitary” landfills are lined with waterproof synthetic materials to

prevent the leaching of garbage juice into groundwater supplies. Yet, only about one third of the active dumps in the US have these liners.<sup>4</sup> Interestingly, the lined landfills bear an uncanny resemblance to gigantic disposable diapers. They are gargantuan plastic lined receptacles where we lay our crap to rest, the layers being carefully folded over and the end products of our wasteful lifestyles buried as if they were in garbage mausoleums intended to preserve our sludge and kitchen trash for posterity. We conveniently flush our toilets and the resultant sewage sludge is transported to these landfills, tucked into these huge disposable diapers, and buried.

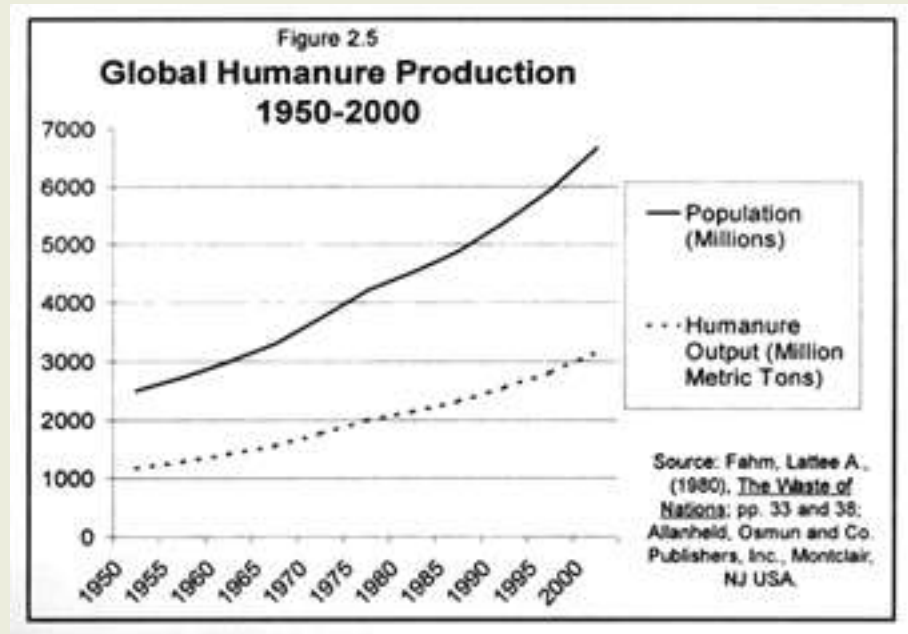
This is not to suggest that sewage should instead be used to produce food crops. In my opinion, it should not. Sewage

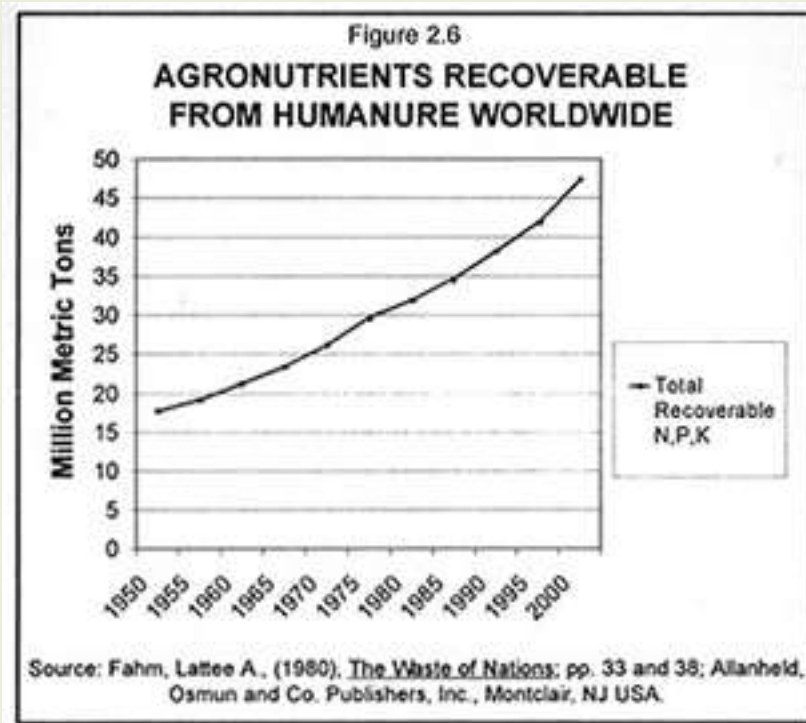
consists of humanure collected with hazardous materials such as industrial, medical, and chemical wastes, all carried in a common waterborne waste stream. Or in the words of Gary Gardner (State of the World 1998), “*Tens of thousands of toxic substances and chemical compounds used in industrial economies, including PCBs, pesticides, dioxins, heavy metals, asbestos, petroleum products, and industrial solvents, are potentially part of sewage flows.*” Not to mention pathogenic organisms. When raw sewage was used in Berlin in 1949, for example, it was blamed for the spread of worm-related diseases. In the 1980s, it was said to be the cause of typhoid fever in Santiago, and in 1970 and 1991, it was blamed for cholera outbreaks in Jerusalem and South America, respectively.<sup>5</sup>

Humanure, on the other hand, when kept out of the sewers, collected as a resource material, and properly processed (composted), makes a fine agricultural resource suitable for food crops. When we combine our manure with other organic materials such as our food discards, we can achieve a blend that is irresistible to certain very beneficial microorganisms.

The US EPA estimates that nearly 22 million tons of food waste are produced in American cities every year. Throughout the United States, food losses at the retail, consumer, and food services levels are estimated to have been 48 million tons in 1995.<sup>6</sup> That would make great organic material for composting with humanure. Instead, only 2.4% of our discarded food was being composted in the US in 1994; the remaining 97.6% was apparently incinerated or buried in landfills.<sup>7</sup>

In 1998, industrial countries were only reusing 11% of their organic garbage.<sup>8</sup> The Organization for Economic Cooperation and Development, a group made up primarily of western industrial countries, estimates that 36% of the waste in their member states is organic food and garden materials. If paper is also considered, the organic share of the waste stream is boosted to nearly an incredible two thirds! In





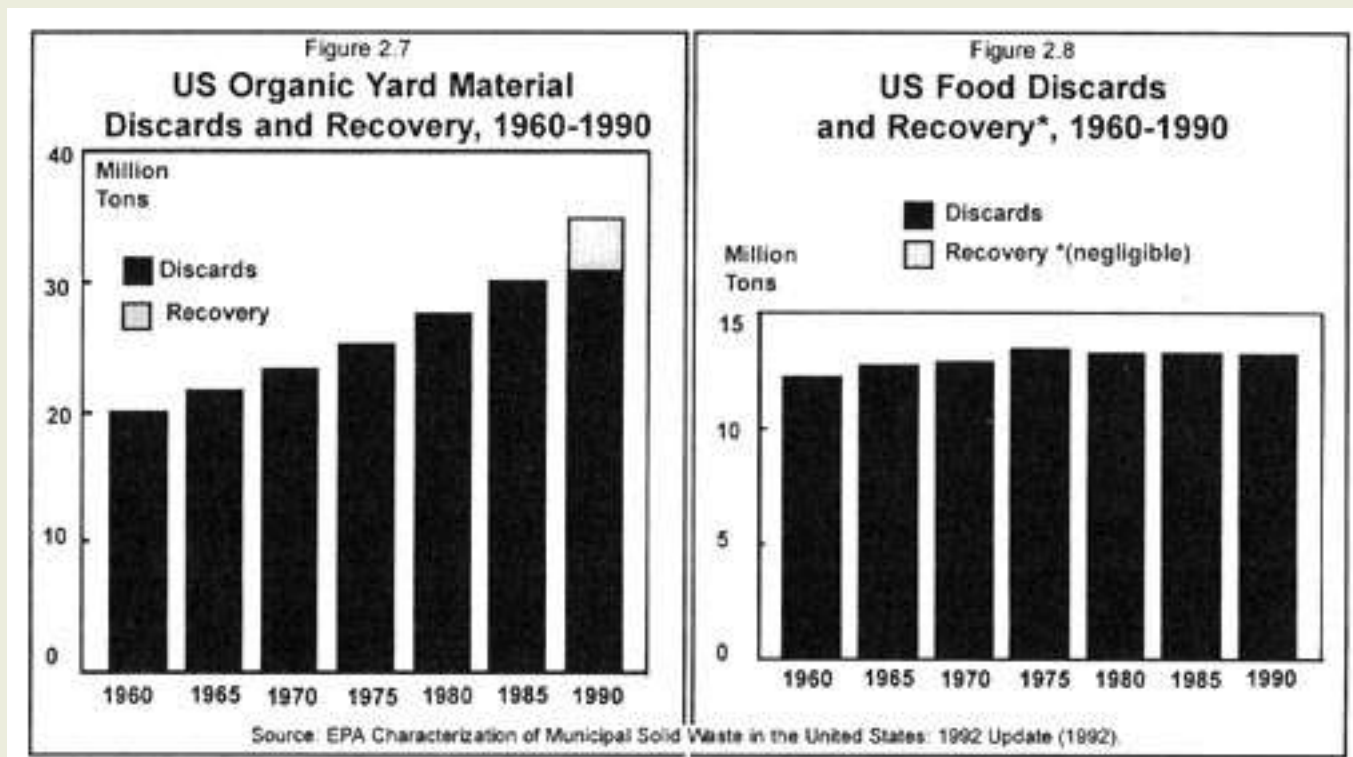
developing countries, organic material typically makes up one-half to two-thirds of the waste stream.<sup>9</sup> According to the EPA, almost 80% of the net discarded solid waste in the US is composed of organic material (see Figure 2.1).

It is becoming more and more obvious that it is unwise to rely on landfills to dispose of recyclable materials. Landfills fill up, and new ones need to be built to replace them. The estimated cost of building and maintaining an EPA approved landfill is now nearly \$125 million and rising. The 8,000 operating landfills we had in the United States in 1988 had dwindled to 5,812 by the end of 1991. By 1996, only 3,091 remained.<sup>10</sup>

In fact, we may be lucky that landfills are closing so rapidly. They are notorious polluters of water, soil, and air. Of the ten thousand landfills that have closed since 1982, 20% are now listed as hazardously contaminated Superfund sites. A 1996 report from the state of Florida revealed that groundwater contamination plumes from older, unlined landfills can be longer than 3.4 miles, and that 523 public water supplies in Florida are located within one mile of these closed landfills, while 2,700 lie within three miles of one.<sup>11</sup> No doubt similar situations exist throughout the United States.

Organic material disposed of in landfills also creates large quantities of methane, a major global-warming gas. US landfills are “*among the single greatest contributors of global methane emissions,*” according to the Natural Resources Defense Council. According to the EPA, methane is 20 to 30 times more potent than CO<sub>2</sub> as a greenhouse (global warming) gas on a molecule to molecule basis.<sup>12</sup>

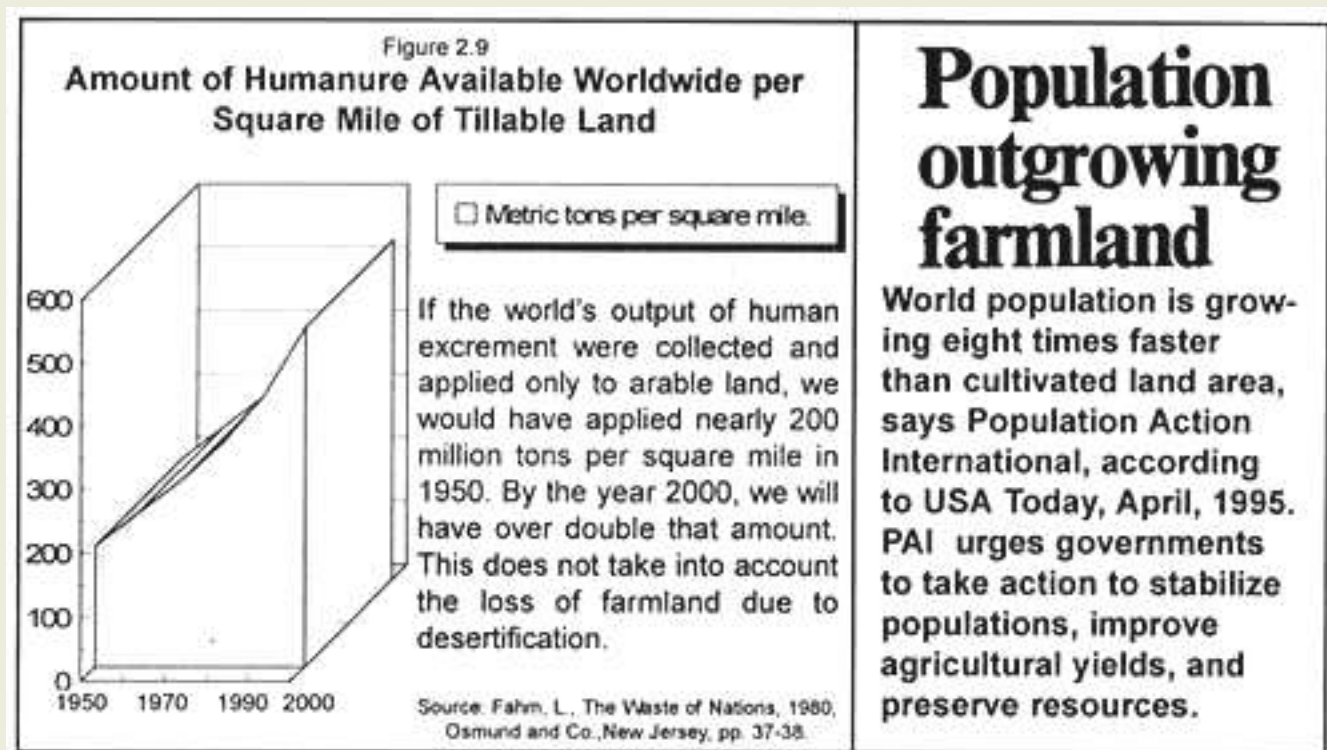
Tipping fees (the fee one pays to dump waste) at landfills in every region of the US have been increasing at more than twice the rate of inflation since 1986. In fact, since then, they have increased 300% and are expected to continue rising at this rate.<sup>13</sup>



In developing countries, the landfill picture is also bleak. In Brazil, for example, virtually all (99%) of the solid waste is dumped into landfills, and three-fourths of the 90,000 tons per day ends up in open dumps.<sup>14</sup> Slowly we're catching on to the fact that this throw-away trend has to be turned around. We can't continue to throw "away" usable resources in a wasteful fashion by burying them in disappearing, polluting, increasingly expensive, landfills.

As a result, recycling is now becoming more widespread in the US. Between 1989 and 1992, recycling increased from 9 to 14%, and the amount of US municipal solid waste sent to landfills decreased by 8%.<sup>15</sup> The national average for the recycling of all materials in US cities had jumped to 27% by 1998.<sup>16</sup> Composting is also beginning to catch on in a big way in some areas of the world. In the United States, the 700 composting facilities in 1989 grew to more than 3,200 by 1996. Although this is a welcomed trend, it doesn't adequately address a subject still sorely in need of attention: what to do with humanure, which is rarely being recycled anywhere in the western world.

If we had scraped up all the human excrement in the world and piled it on the world's tillable land in 1950, we'd have applied nearly 200 metric tons per square mile at that time (roughly 690 pounds per acre). In the year 2000, we'll be collecting significantly more than *double* that amount because the global population is increasing, but the global land mass isn't. In fact, the global area of agricultural land is steadily *decreasing* as the world loses, for farming and grazing, an area the size of Kansas each year.<sup>17</sup> The world's burgeoning human population is producing a ballooning amount of organic refuse which will eventually have to be dealt with responsibly and constructively. It's not too soon to begin to understand human organic refuse materials as valuable resource materials begging to be recycled.



In 1950, the dollar value of the agricultural nutrients in the world's gargantuan pile of humanure was 6.93 billion dollars. In 2000, it will be worth 18.67 billion dollars (calculated in 1975 prices).<sup>18</sup> This is money currently being flushed out somewhere into the environment where it shows up as pollution and landfill material. Every pipeline has an outlet somewhere; everything thrown "away" just moves from one place to another. Humanure and other organic refuse materials are no exception. Not only are we flushing "money" away, we're paying through the nose to do so. The cost is not only economic, it's environmental.

Source: *The Humanure Handbook*. Jenkins Publishing, PO Box 607, Grove City, PA 16127. To order, phone: 1-800-639-4099.

<http://www.jenkinspublishing.com/>

**MENU:** [HOME](#) » [Reconstruction](#) » [Recovery](#) » [Renewal](#) » [Survival](#) » [Humanure Content](#)



## SOILED WATER

*“The practice of injecting ‘waste’ products and toxic materials into the arterial waterways of Earth is comparable to the idea of using our own bloodstream as a disposal site for hazardous compounds.”*

Keith Helmuth

The world is divided into two categories of people: those who shit in drinking water and those who don’t. We in the western world are in the former class. We defecate in water, usually purified drinking water. After polluting the water with our body’s excrements, we flush the once pure but now polluted water “away,” meaning we probably don’t know where it goes, nor do we care.

### Water may cause wars as growth hits cities

The United Nations warned that water shortages created by the world's skyrocketing population and extravagant use could spark wars in the 21st century, according to Reuters News Service in 1996.

This ritual of defecating in water may be useful for maintaining a good standing within western culture. If you don’t deposit your feces into a bowl of drinking water on a regular basis, you may be considered a miscreant of sorts, perhaps uncivilized or dirty or poverty stricken. You may be seen as a non-conformist or a radical.

Yet, the discarding of human organic waste into water supplies obviously affects water quality. By defecating directly into water, we pollute it. Every time we flush a toilet, we launch five or six gallons of polluted water out into the world.<sup>19</sup> That would be like defecating into a five gallon office water jug and then dumping it out before anyone could drink any of it. Then doing the same thing when urinating. Then doing it every day, numerous times. Then multiplying that by about 250 million people in the United States alone.

Even after the contaminated water is treated in wastewater treatment plants, it may still be polluted with excessive levels of nitrates, chlorine, pharmaceutical drugs, industrial chemicals, detergents, and other pollutants. This “treated” water is discharged directly into the environment.

A visit to the local library for a cursory review of sewage pollution incidents in the United States yielded the following:

- In the mid 1980s, the 2,207 publicly owned coastal sewage treatment works were discharging

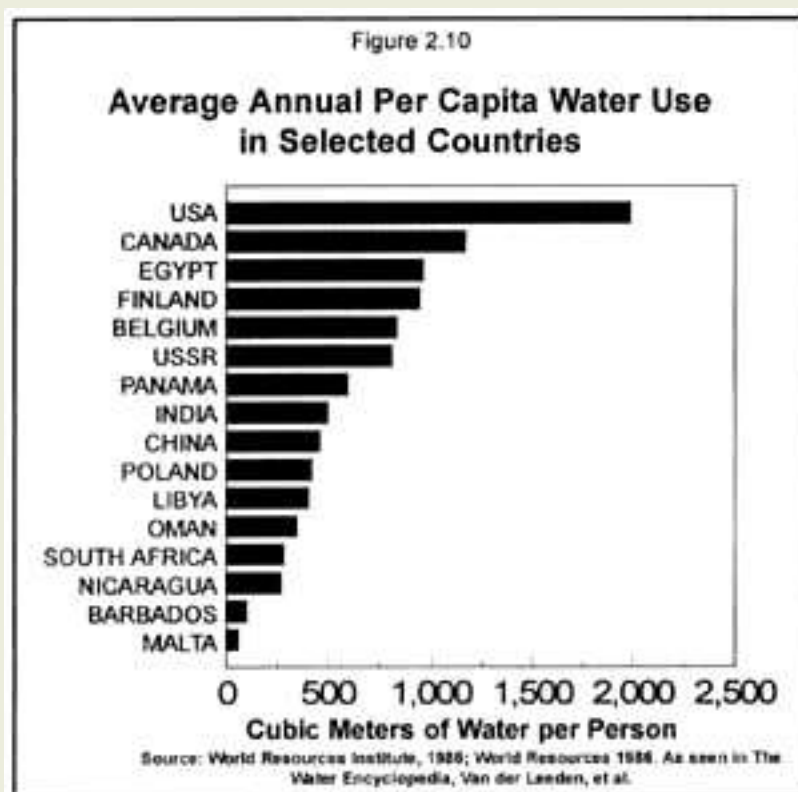
3.619 *trillion* gallons per year of treated wastewater into the coastal environment.<sup>20</sup>

- More than 2,000 beaches and bays in twelve states were closed in 1991 because of bacterial levels deemed excessive by health authorities.
- In 1991, the city of Honolulu faced penalties of about \$150 million for some 9,000 alleged sewage discharge violations that were recorded since 1985.<sup>21</sup>
- In 1991, Ohio Environmental Protection Agency fined Cincinnati's Metropolitan Sewer District \$170,000, the largest fine ever levied against an Ohio municipality, for failure to enforce its wastewater treatment program.<sup>22</sup>
- In 1991, California was required to spend \$10 million to repair a leaking sewer pipeline that had forced the closure of twenty miles of southern California beaches. The broken pipeline was spilling up to 180 million gallons of sewage per day into the Pacific Ocean less than one mile offshore, resulting in a state of emergency in San Diego County. This situation was compounded by the fact that a recent heavy storm had caused millions of gallons of raw sewage from Mexico to enter the ocean from the Tijuana River.<sup>23</sup>
- Environmental advocates sued the city of Portland, Oregon in 1991 for allegedly discharging untreated sewage as often as 3,800 times per year into the Willamette River and the Columbia Slough.<sup>24</sup>
- In 1992, the US EPA sued the Los Angeles County Sanitation Districts for failing to install secondary sewage treatment at a plant which discharges wastewater into the Pacific Ocean, and for fourteen years of raw sewage spills and other discharges.<sup>25</sup>
- In April of 1992, national environmental groups announced that billions of gallons of raw waste pour into lakes, rivers, and coastal areas each year from combined sewers. Such sewers carry storm water *and* sewage in the same pipe and tend to overflow during heavy rains, causing many cities to suffer from discharges of completely untreated sewage.<sup>26</sup> Combined sewers are found in about 900 US cities.<sup>27</sup>
- In 1997, pollution caused at least 4,153 beach closings and advisories, 69% of which were caused by elevated bacterial pollution in the water. The elevated bacteria levels were primarily caused by storm-water runoff, raw sewage, and animal wastes entering the oceans. The sources of the pollution included inadequate and overloaded sewage treatment plants, sewage overflows from sanitary sewers and combined sewers, faulty septic systems, boating wastes, and polluted storm water from city streets and agricultural areas.<sup>28</sup>

It is estimated that by 2010, at least half of the people in the US will live in coastal cities and towns, further exacerbating water pollution problems caused by sewage. The degree of beach pollution becomes a bit more personal when one realizes that current EPA recreational water cleanliness standards still allow 19 illnesses per 1,000 saltwater swimmers, and 8 per 1,000 freshwater swimmers.<sup>29</sup> Some of the diseases associated with swimming in wastewater-contaminated recreational waters include typhoid fever, salmonellosis, shigellosis, hepatitis, gastroenteritis, pneumonia, and skin infections.<sup>30</sup>

If you don't want to get sick from the water you swim in, you can always follow another standard recommendation: don't submerge your head. Otherwise, you may end up like the swimmers in Santa Monica Bay. People who swam in the ocean there within 400 yards (four football fields) of a storm sewer drain had a 66% greater chance of developing a "significant respiratory disease" within the

following 9 to 14 days after swimming.<sup>31</sup> This should come as no surprise when one takes into consideration the emergence of antibiotic-resistant bacteria. The use of antibiotics is so widespread that many people are now breeding antibiotic resistant bacteria in their intestinal systems. These bacteria are excreted into toilets and make their way to wastewater treatment plants where *the antibiotic resistance can be transferred to other bacteria*. Wastewater plants can then become breeding grounds for resistant bacteria, which are discharged into the environment through effluent drains. Why not just chlorinate the water before discharging it? It usually is chlorinated beforehand, but research has shown that chlorine seems to *increase* bacterial resistance to some antibiotics.<sup>32</sup>



## Report: Water bodies remain too polluted

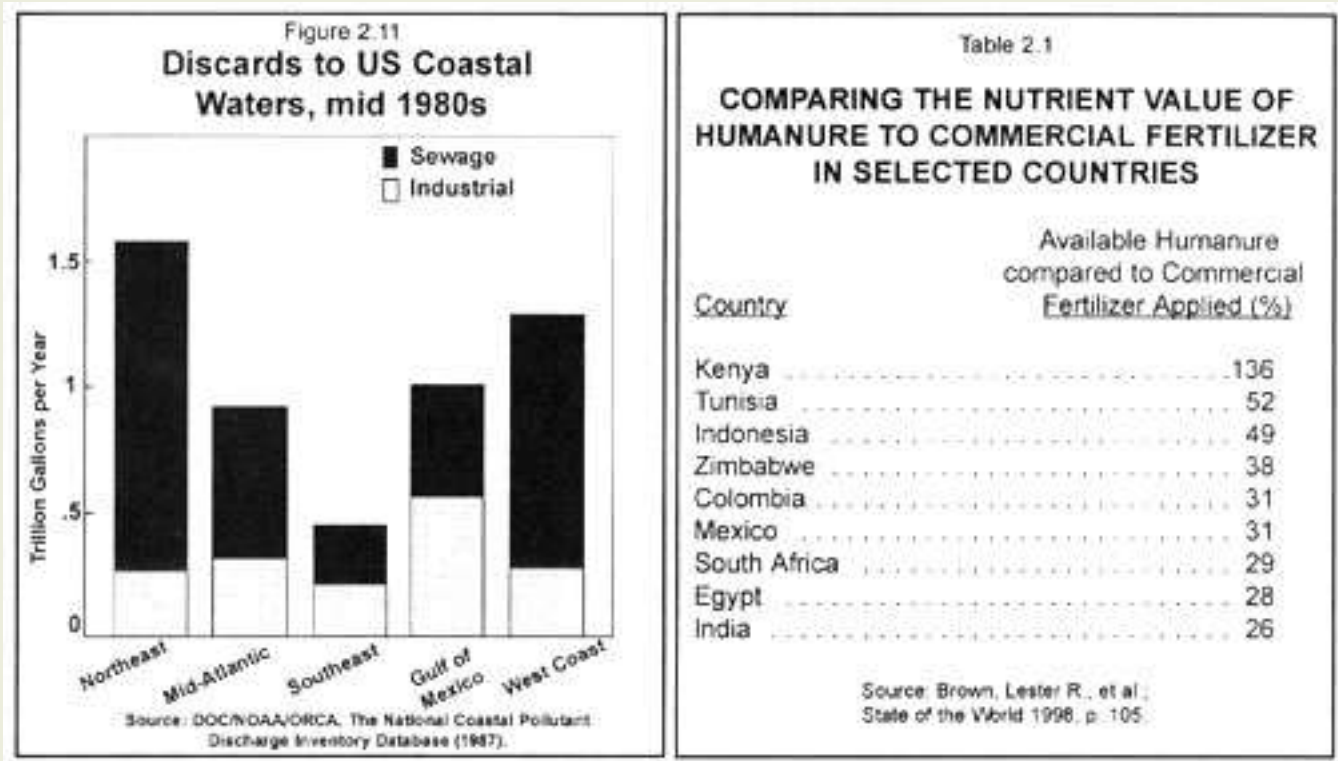
Nearly four out of every ten lakes, rivers, and estuaries remain too polluted to allow fishing, swimming or other aquatic uses at any time of the year, the United States Environmental Protection Agency reported in December of 1995. Sewage, disease-causing bacteria, fertilizer, toxic metals, oil, and grease are among the most frequent pollutants. (Associated Press, 12/15/95)

Not worried about antibiotic resistant bacteria in your swimming area? Here's something else to chew on: 50 to 90% of the pharmaceutical drugs people take can be excreted down the toilet and out into the waterways *in their original or biologically active forms*. Furthermore, drugs that have been partially degraded before excretion can be converted to their original active form by environmental chemical reactions. Pharmaceutical drugs such as chemotherapy drugs, antibiotics, antiseptics, beta-blocker heart drugs, hormones, analgesics, cholesterol-lowering drugs, and drugs for regulating blood lipids have turned up in such places as tap water, groundwater beneath sewage treatment plants, lake water, rivers, and in drinking water aquifers. Think about *that* the next time you fill your glass with water.<sup>33</sup>

Long Island Sound receives over a billion gallons of treated sewage every day, the waste of eight million people. So much nitrogen was being discharged into the Sound from the *treated* wastewater that it caused the aquatic oxygen to disappear, rendering the marine environment unsuitable for the fish that normally live there. The twelve treatment plants that were to be completed along the Sound by 1996 were expected to remove 5,000 pounds of nitrogen daily. Nitrogen is normally a soil nutrient and agricultural resource,

but instead, when flushed, it becomes a dangerous pollutant.<sup>34</sup>

Previous to December 31, 1991, when disposing of US sewage sludge into the ocean was banned, much of the sewage sludge along coastal cities in the United States was simply dumped out at sea. Nevertheless, the city of New York was unable to meet that deadline and was forced to pay \$600 per dry ton to dump its sludge at the Deepwater Municipal Sludge Dump Site, 106 miles off the coast of New Jersey. Illegal dumping of sewage into the sea also continues to be a problem.<sup>35</sup> A bigger problem is what to do with sewage sludge now that landfill space is diminishing and sludge can no longer be dumped into the ocean.



The dumping of sludge, sewage, or wastewater into nature's waterways invariably creates pollution. The impacts of polluted water are far-ranging, causing the deaths of 25 million people each year, three-fifths of them children.<sup>36</sup> Half of all people in developing countries suffer from diseases associated with poor water supply and sanitation.<sup>37</sup> Diarrhea, a disease associated with polluted water, kills six million children each year in developing countries, and it contributes to the death of up to 18 million people.<sup>38</sup> At the beginning of the 21st century, one out of four people in developing countries still lacked clean water, and two out of three lacked adequate sanitation.<sup>39</sup>

Proper sanitation is defined by the World Health Organization as any excreta disposal facility that interrupts the transmission of fecal contaminants to humans.<sup>40</sup> This definition should be refined to include excreta *recycling* facilities, as excreta are valuable organic resources which should not be discarded. Compost toilet systems are now becoming internationally recognized as constituting "proper sanitation," and are becoming more and more attractive throughout the world due to their relatively low cost when

compared to waterborne waste systems and centralized sewers. In fact, compost toilet systems yield a dividend — *humus*, which allows such a sanitation system to yield a net profit, rather than being a constant financial drain (no pun intended).

## FUN FACTS

### *about water*



- If all the world's drinking water were put in one cubical tank, the tank would measure only 95 miles on each side.
- Number of people currently lacking access to clean drinking water: 1.2 billion.
- Percent of the world's households that must fetch water from outside their homes: 67
- Percent increase in the world's population by the middle of the 21st century: 100
- Percent increase in the world's drinking water supplies by the middle of the 21st century: 0
- Amount of water Americans use every day: 340 billion gallons.
- Number of gallons of water needed to produce a car: 100,000
- Number of cars produced every year: 50 million.
- Amount of water required by a nuclear reactor every year: 1.9 cubic miles.
- Amount of water used by nuclear reactors every year: the equivalent of one and a third Lake Eries.

Sources: Der Spiegel, May 25, 1992; and Annals of Earth, Vol. 8, Number 2, 1990; Ocean Arks International, One Locust Street, Falmouth, MA 02540.

The almost obsessive focus on flush toilets throughout the world is causing the problems of international sanitation to remain unresolved. Many parts of the world cannot afford expensive and water consumptive waste disposal systems. Or, in the words of Gary Gardner (Vital Signs 1998), “*The high costs leave developing countries spending less than a third of what they should in order to provide adequate sanitation, according to WHO. . . Prospects for providing universal access to sanitation are dismal in the near to medium term. . . Despite the attention focused on sanitation, governments have not demonstrated the will to meet this growing challenge.*” [41](#)

Illness related to polluted water afflicted 111,228 Americans from 1971-85. Forty-nine percent of these were caused by untreated or inadequately disinfected groundwater.<sup>42</sup> Approximately 155 million people in the US obtain their drinking water from surface water sources.<sup>43</sup> Several American cities have suffered from

outbreaks of cryptosporidia (protozoa which cause severe diarrhea) since 1984. These protozoa are transmitted when people drink water contaminated by infected human and other animal feces. Outbreaks occurred in Braun Station, Texas, in 1984; in Carrollton, Georgia, in 1987; in Medford and Talent, Oregon, in 1992; and in Milwaukee, Wisconsin, in 1993. The outbreak in Carrollton, Georgia, afflicted 13,000 people, and was caused by contaminated water from a water treatment plant. Hundreds of thousands of people have been afflicted by this bug, for which there is no treatment. The illness runs its course in about fourteen days in healthy people, but can be deadly to people who have weak immune systems.<sup>44</sup>

## Modern toilets tax water

291 cities and towns in Japan face water shortages due to the spread of flush toilets, reported the Construction Ministry in April of 1998. Some cities have had to build dams to provide enough water to flush the increasingly popular toilets.

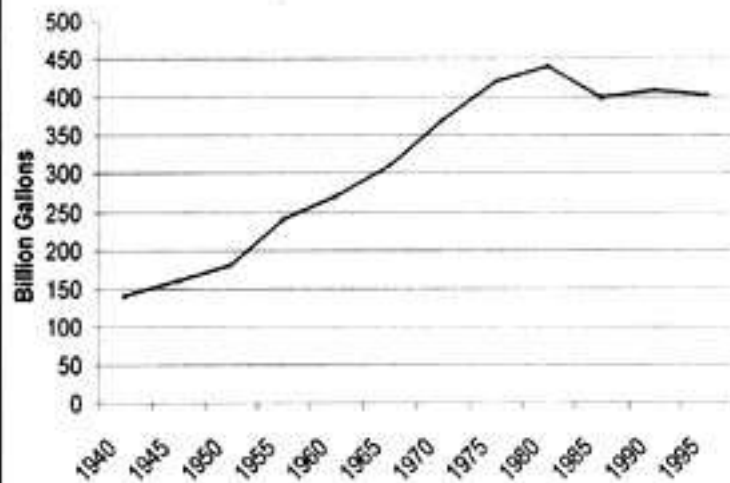
### Paris

#### More than 1 billion people lack access to clean water

The U.N. International Conference on Water and Sustainable Development in 1998 reported that five to ten million people die each year as a result of drinking polluted water, while about 1.2 billion people lack access to clean water. "Fresh water needed for human needs is rapidly getting scarce . . . .," they reported.

Figure 2.12

### US Water Withdrawals 1940-1995



Source: Statistical Abstracts of the United States 1998, p. 240.

In 1995, there were still nearly 10 million people in the US connected to public drinking water supplies from surface sources that were not in compliance with federal standards for the removal of microorganisms. Furthermore, scientists estimate that up to seven million Americans still get sick annually from contaminated drinking water.<sup>45</sup>



Sanitation problems could be avoided by composting, instead of discarding, humanure. Keeping fecal material out of the environment and out of streams, rivers, wells, and underground water sources eliminates the transmission of various diseases. Composting effectively converts fecal material into a hygienically safe humus, yet composting the humanure of municipal populations is not even being considered as an option in most of the western world.

Not only are we polluting our water, we're using it up, and flushing toilets is one way it's being wasted. Of 143 countries ranked for per capita water usage by the World Resources Institute, America came in at #2 using *188 gallons per person per day* (Bahrain was #1).<sup>46</sup>

Water use in the US increased by a factor of 10 between 1900 and 1990, increasing from 40 billion gallons per day to 409 billion gallons per day.<sup>47</sup> The amount of water we Americans require overall (used in the finished products each of us consumes, plus washing and drinking water) amounts to a staggering 1,565 gallons per person per day, which is three times the rate in Germany or France.<sup>48</sup> This amount of water is equivalent to flushing our toilets 313 times every day, about once every minute and a half for eight hours straight. By some estimates, it takes one to two thousand tons of water to flush one ton of human waste.<sup>49</sup> Or, in the words of Carol Stoner, "*For one person, the typical five gallon flush contaminates each year about 13,000 gallons of fresh water to move a mere 165 gallons of body waste.*"<sup>50</sup> Not surprisingly, the use of groundwater in the United States exceeds replacement rates by 21 billion gallons a day.<sup>51</sup>

Source: *The Humanure Handbook*. Jenkins Publishing, PO Box 607, Grove City, PA 16127. To order, phone: 1-800-639-4099.

<http://www.jenkinspublishing.com/>

---

**MENU: [HOME](#) » [Reconstruction](#) » [Recovery](#) » [Renewal](#) » [Survival](#) » [Humanure Content](#)**

---

## WASTE VS. MANURE

*“Science now knows that the most fertilizing and effective manure is the human manure . . . Do you know what these piles of ordure are . . . All this is a flowering field, it is green grass, it is the mint and thyme and sage . . . it is the guilded wheat, it is the bread on your table, it is the warm blood in your veins.”*

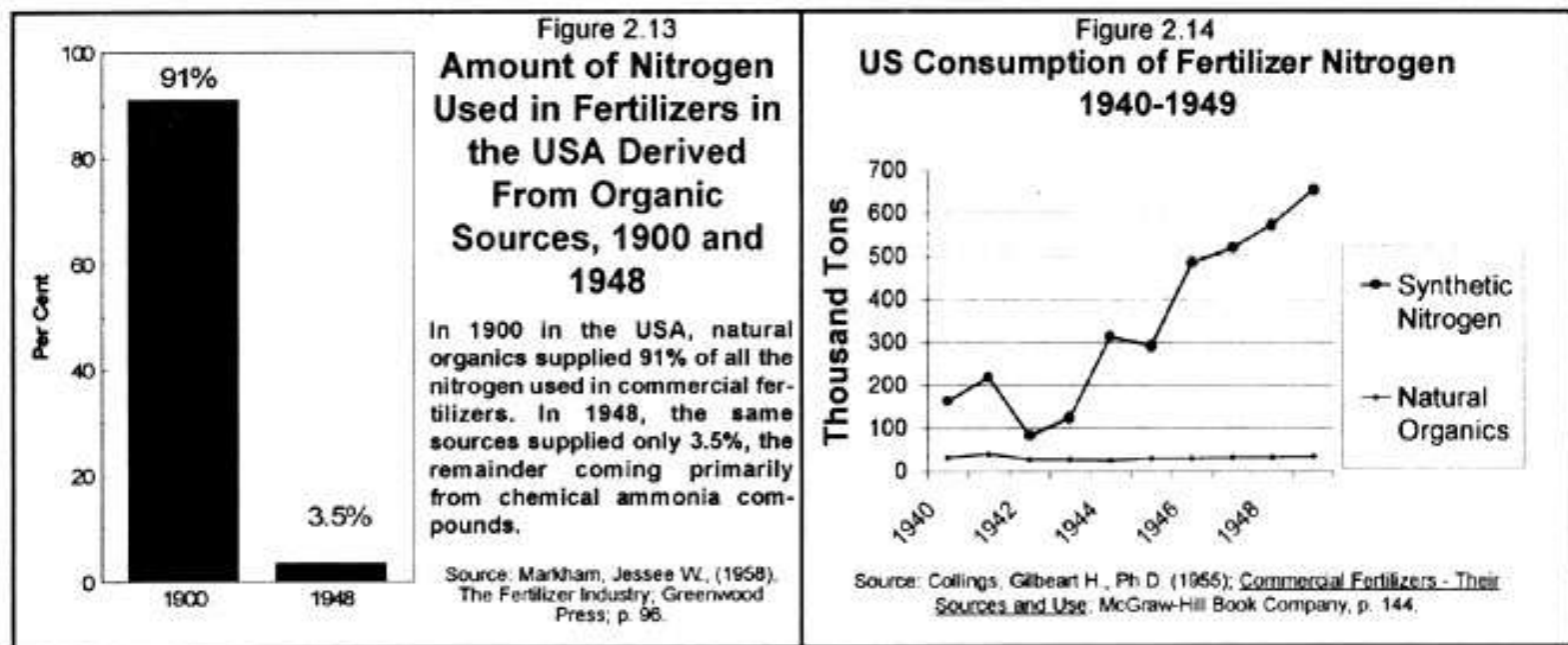
Victor Hugo

By dumping soil nutrients down the toilet, we increase our need for synthetic chemical fertilizers. Today, pollution from agriculture, caused from siltation (erosion) and nutrient runoff due to excessive or incorrect use of fertilizers,<sup>52</sup> is now the “*largest diffuse source of water pollution*” in our rivers, lakes, and streams.<sup>53</sup> Chemical fertilizers provide a quick fix of nitrogen, phosphorous, and potassium for impoverished soils. However, it’s estimated that 25-85% of chemical nitrogen applied to soil and 15-20% of the phosphorous and potassium are lost to leaching, much of which can pollute groundwater.<sup>54</sup> This pollution shows up in small ponds which become choked with algae as a result of the unnatural influx of nutrients. In 1992, for example, the state of Florida was required to build some 35,000 acres of marshlands to filter farm-related runoff that was polluting the Everglades.<sup>55</sup> From 1950 to 1990, the global consumption of artificial fertilizers rose by 1000%, from 14 million tons to 140 million tons.<sup>56</sup> In 1997, US farmers used 20 million tons of synthetic fertilizers,<sup>57</sup> and half of all manufactured fertilizer ever made has been used just since 1982.<sup>58</sup> All the while, hundreds of millions of tons of compostable organic materials are generated in the US each year, and either buried in landfills, incinerated, or discharged into the environment as waste.

Nitrate pollution from excessive artificial fertilizer use is now one of the most serious water pollution problems in Europe and North America. Such pollution can cause cancer, and even brain damage or death in infants.<sup>59</sup> Most cases of infant poisoning occur when infant *formula* is made with nitrate polluted water.<sup>60</sup> A 1984 US EPA survey indicated that out of 124,000 water wells sampled, 24,000 had elevated levels of nitrates and 8,000 were polluted above health limits (10 mg/liter).<sup>61</sup> In fact, a 1990 EPA survey indicated that 4.5 million Americans were potentially exposed to elevated levels of nitrates from drinking water wells alone.<sup>62</sup>

*The squandering of our water resources, and pollution from sewage and synthetic fertilizers results in part from the belief that humanure and food scraps are waste materials rather than recyclable natural resources.* There is, however, an alternative. Humanure and food refuse can be composted and thereby rendered hygienically safe for agricultural or garden use. Much of the eastern world recycles humanure. Those parts of the world have known for millennia that humanure is a valuable resource which should be returned to the land, as any animal manure should.





Farmers know that animal manure is valuable. They know that animal manures are digested crops, and that crops are soil, water, air, and sunshine converted into food, and the best way to use that manure is to put it back into the fields from where it originated. So the farmer loads up the manure spreader and flings the manure back onto the fields, thereby cleaning up his barn, saving himself lots of money on fertilizers, and keeping his soil healthy. Sounds reasonable enough. But what about human manure?

Humanure is a little bit different. It shouldn't simply be flung around in a fresh and repulsive state. It should undergo a process of bacterial digestion first, usually known as composting, in order to destroy possible pathogens. This is the missing link in the human nutrient recycling process. The process is similar to any animal's: a human grows food for herself on a field, or in a garden. The food is consumed and passes into the digestive system where the body extracts what it needs, rejects what it doesn't need at the time, or what it can't use, then excretes the rejected material.

At that moment, the digestive system is no longer responsible for the excretion. It's now time for the brain to go to work. The human mind has basically two choices — consider the excretion to be waste and try to get rid of it, or consider the excretion to be a resource which must be recycled. Either way, the body's excretion must be collected. As waste, the material must be dispensed with in a manner that is safe to human health and to the environment; as a resource, the humanure should be naturally recycled.

In some areas of the world, such as Asia, humanure may be applied raw to fields without being composted beforehand. Containers of human excrement are set outside residences in Asia to be picked up during the night and taken to the fields. The content of these containers is called, appropriately enough, "night soil." *That is NOT what this book is about.*

Raw humanure carries with it a significant potential for danger in the form of disease pathogens. These diseases, such as intestinal parasites, hepatitis, cholera, and typhoid are destroyed by composting, either when the retention time is adequate in a low temperature compost pile (usually



**Properly composted humanure yields a rich, loamy, pleasant-smelling, hygienically safe soil-building material, here being applied to spring garden beds.**

Shanghai, China, a city with an expected population of 14.2 million people in 2000,<sup>63</sup> produces an exportable surplus of vegetables in this manner.

considered to be two years) or when the composting process generates internal, biological heat (which can kill pathogens in a matter of minutes). Raw applications of humanure to fields, on the other hand, are not hygienically safe and can assist in the spread of various diseases which may be endemic to areas of Asia. Americans who have traveled to Asia tell of the “horrible stench” of night soil that wafts through the air when it is applied to fields. For these reasons, it is imperative that humanure always be composted before agricultural applications. Proper thermophilic (heat-producing) composting destroys possible pathogens and results in a pleasant-smelling material. Low temperature composting, given adequate time, will yield a compost also suitable for agricultural purposes.

At the very least, raw night soil applications to fields in Asia do return humanure to the land, thereby recovering a valuable resource which is then used to produce food for humans. *Composted* humanure is used in Asia as well. Cities in China, South Korea, and Japan recycle night soil around their perimeters in greenbelts where vegetables are grown.

**In some areas of the world, such as Asia, humanure may be applied raw to fields without being composted beforehand. Containers of human excrement are set outside residences in Asia to be picked up during the night and taken to the fields. The content of these containers is called, appropriately enough, “night soil.” *That is NOT what this book is about.***

Humanure can also be used to feed algae which can, in turn, feed fish for aquacultural enterprises. In Calcutta, such an aquaculture system produces 20,000 kilograms of fresh fish daily.<sup>64</sup> The city of Tainan, Taiwan, is well known for its fish, which are farmed in over 6,000 hectares of fish farms fertilized by humanure. Here, humanure is so valuable that it’s sold on the black market.<sup>65</sup>

*Source: The Humanure Handbook. Jenkins Publishing, PO Box 607, Grove City, PA 16127. To order, phone: 1-800-639-4099.  
<http://www.jenkinspublishing.com/>*

---

**MENU: [HOME](#) » [Reconstruction](#) » [Recovery](#) » [Renewal](#) » [Survival](#) » [Humanure Content](#)**

---

## RECYCLING HUMANURE

*“We stand now where two roads diverge . . .the one ‘less traveled by’ offers our last, our only chance to reach a destination that assures the preservation of our Earth.”*

Rachael Carson - *Silent Spring*

Humanure can be naturally recycled by feeding it to the organisms that crave it as food. These voracious creatures have been around for millions, and theoretically *billions* of years, and they’ve patiently waited for us humans to discover them. Mother Nature has seeded our excrements, as well as our garbage, with these “friends in small places,” who will convert our organic discards into a soil-building material right before our eyes. Invisible helpers, these creatures are too small to be seen by the human eye and are therefore called *microorganisms*. The process of feeding organic material to these microorganisms is called *composting*, and proper composting ensures the destruction of potential human pathogens (disease-causing microorganisms) in humanure. Composting also completely converts the humanure into a new, benign, pleasant-smelling, and beneficial substance called *humus*, which is then returned to the soil to enrich it and enhance plant growth.

Incidentally, *all* animal manures benefit from composting, as today’s farmers are now discovering. Compost doesn’t leach like raw manures do. Instead, it helps hold nutrients in soil systems. Composted manures also reduce plant disease and insect damage and allow for better nutrient management on farms. In fact, two tons of compost will yield far more benefits than five tons of manure.<sup>66</sup>

*Human* manure can be mixed with other organic materials from human activity such as kitchen and food scraps, grass clippings, leaves, garden refuse, paper products, and sawdust. This mix of materials is necessary for proper composting to take place, and it will yield a soil additive suitable for food gardens as well as for agriculture.

One reason we humans have not “fed” our excrement to the appropriate organisms is because we didn’t know they existed. We’ve only learned to see and understand microscopic creatures in our recent past. We also haven’t had such a rapidly growing human population in the past, nor have we been faced with the dire environmental problems that threaten our species today, like buzzards circling an endangered animal.

It all adds up to the fact that the human species must inevitably evolve. Evolution means change, or as Rachel Carson stated almost four decades ago, we must realize that we are now standing at a fork in the

road. Change is often resisted, as old habits die hard, and flush toilets and bulging garbage cans represent well entrenched but non-sustainable habits that must be rethought and reinvented. You will not find profligate, wasteful, and polluting behavior taken for granted on “the road less traveled.”

Consumer cultures of today must evolve toward sustainability. This is a shift that will likely be fought tooth and nail by those powerful, non-sustainable industries that stand to lose profits, and by their paid spokespersons in the newspapers, radio, television, congresses, and senates of the world. Nevertheless, if we humans are half as intelligent as we think we are, we’ll join together cooperatively and eventually get our act together. In the meantime, there are those of you who are doing your share, shifting as you can, incrementally, but surely toward sustainable lifestyle choices. You are also further educating yourselves, as the reading of this book indicates, and perhaps realizing that nature holds many of the keys we need to unlock the door to a sustainable, harmonious existence on this planet. Composting is one of the keys that has been relatively recently discovered by the human race. Its utilization is now beginning to mushroom worldwide.

*Source: The Humanure Handbook. Jenkins Publishing, PO Box 607, Grove City, PA 16127. To order, phone: 1-800-639-4099.*

<http://www.jenkinspublishing.com/>

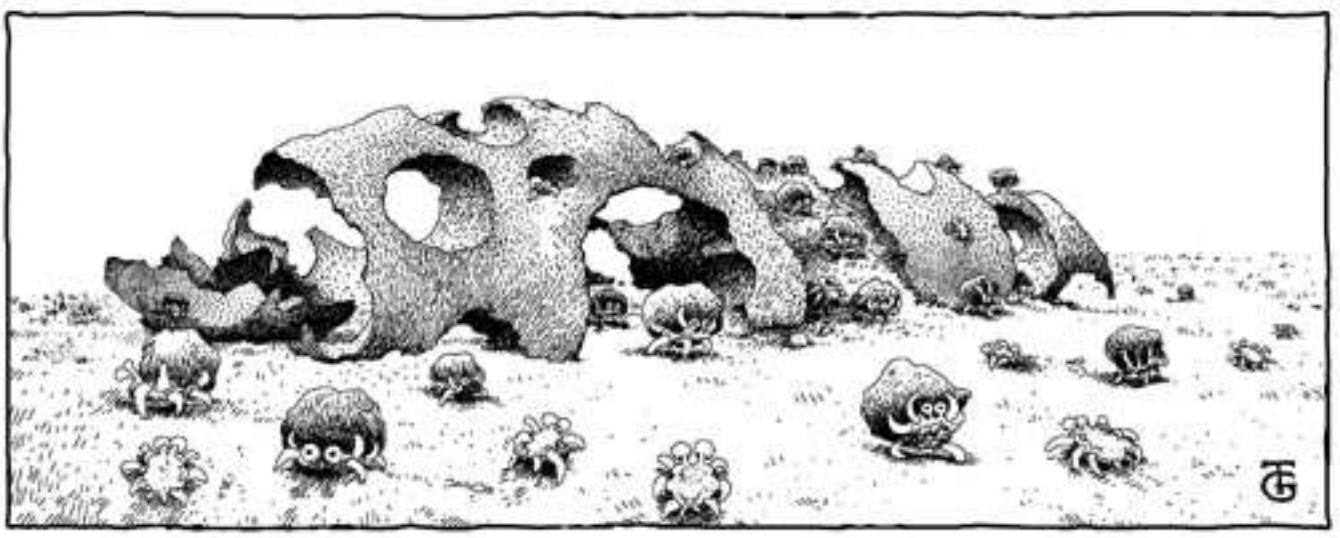
---

**MENU: [HOME](#) » [Reconstruction](#) » [Recovery](#) » [Renewal](#) » [Survival](#) » [Humanure Content](#)**

---

# MICROHUSBANDRY

Harnessing the Power of Microscopic Organisms



*“Anyone starting out from scratch to plan a civilization would hardly have designed such a monster as our collective sewage system. Its existence gives additional point to the sometimes asked question, Is there any evidence of intelligent life on the planet Earth?”*

G. R. Stewart

There are four general ways to deal with human excrement. The first is to *dispose of it* as a waste material. People do this by defecating in drinking water supplies, or in outhouses or latrines. Most of this waste ends up dumped, incinerated, buried in the ground, or discharged into waterways.

The second way to deal with human excrement is to *apply it raw to agricultural land*. This is popular in Asia where “night soil,” or raw human excrement, is spread on fields. Although this keeps the soil enriched, it also acts as a vector, or route of transmission, for disease organisms. In the words of Dr. J. W. Scharff, former chief health officer in Singapore, *“Though the vegetables thrive, the practice of putting human [manure] directly on the soil is dangerous to health. The heavy toll of sickness and death from various enteric diseases in China is well-known.”* The World Health Organization adds, *“Night soil is sometimes used as a fertilizer, in which case it presents great hazards by promoting the transmission of food-borne enteric [intestinal] disease, and hookworm.”* <sup>1</sup> (It is interesting, incidentally, to note Dr. Scharff’s only alternative to the use of raw night soil: *“We have been inclined to regard the installation*

of a water-carried system as one of the final aims of civilization.”)<sup>2</sup> This book, therefore, is *not* about recycling night soil by raw applications to land, which is a practice that should be discouraged when sanitary alternatives, such as composting, are available.

The third way to deal with human excrement is to *slowly compost it over an extended period of time*. This is the way of most commercial composting toilets. Slow composting generally takes place at temperatures below that of the human body, which is 37°C or 98.6°F. This type of composting eliminates most disease organisms in a matter of months, and should eliminate all human pathogens eventually. Low temperature composting creates a useful soil additive that is at least safe for ornamental gardens, horticultural, or orchard use.

*Thermophilic* composting is the fourth way to deal with human excrement. This type of composting involves the cultivation of heat-loving (thermophilic) microorganisms in the composting process. Thermophilic microorganisms, such as bacteria and fungi, can create an environment in the compost which destroys disease organisms that can exist in humanure, converting humanure into a friendly, pleasant-smelling, humus safe for food gardens. Thermophilically composted humanure is *entirely different* from night soil. Perhaps it is better stated by the experts in the field: “*From a survey of the literature of night soil treatment, it can be clearly concluded that the only fail-safe night soil method which will assure effective and essentially total pathogen inactivation, including the most resistant helminths [intestinal worms] such as Ascaris [roundworm] eggs and all other bacterial and viral pathogens, is heat treatment to a temperature of 55° to 60°C for several hours.*”<sup>3</sup> The experts are specifically referring to the heat of the *compost pile*.

Source: *The Humanure Handbook*. Jenkins Publishing, PO Box 607, Grove City, PA 16127. To order, phone: 1-800-639-4099.

<http://www.jenkinspublishing.com/>

---

**MENU: [HOME](#) » [Reconstruction](#) » [Recovery](#) » [Renewal](#) » [Survival](#) » [Humanure Content](#)**

---

## VINTAGE COMPOST

*“One of the most fascinating aspects of composting is that it still retains elements of art . . . Producing good compost requires the same level of knowledge, engineering, skill, and art required for producing good wine.”*

Roger Haug - The Practical Handbook of Compost Engineering

I first moved out to the country and started living off the land at the age of 22. Being fresh out of college, I knew little of practical value. One word that was a mystery to me was “compost”; another was “mulch.” Although I didn’t know what either of these were, I knew they had something to do with organic gardening, and that’s what I wanted to learn about. Of course, it didn’t take me long to understand mulch. Anyone who can throw a layer of straw on the ground can mulch. But compost took a bit longer.

My compost-learning experiences paralleled my winemaking experiences. Back then, having just graduated from the university, I had been conditioned to believe that the best way to learn was by using books. I had little awareness that instinct or intuition were powerful teachers. Furthermore, simple, natural processes had to be complicated with charts, graphs, measurements, devices, and all the wonderful tools of science, otherwise the processes had no validity. It was with this attitude that I set out to learn how to make wine.

The first thing I did was obtain a scientific book replete with charts, graphs, tables, and detailed step-by-step procedures. The book was titled something like “Foolproof Winemaking,” and the trick, or so the author said, was simply to follow his procedures *to the letter*. This was no simple feat. The most difficult part of the process was acquiring the list of chemicals which the author insisted must be used in the winemaking process. After much searching and travel, I managed to get the required materials. Then I followed his instructions *to the letter*. This lengthy process involved boiling sugar, mixing chemicals, and following laborious procedures. To make a long story short, I succeeded in making two kinds of wine. Both tasted like crap; one was bad and the other worse, and both had to be thrown out. I was very discouraged.

Soon thereafter, a friend of mine, Bob, decided he would try *his* hand at winemaking. Bob asked a vineyard worker to bring him five gallons of grape juice in a five gallon glass winemaking carboy. When the grape juice arrived, Bob took one look at the heavy carboy of juice and said, “*Buddy, would you mind carrying that into the basement for me?*” Which the worker obligingly did.

That was it. That utterance of eleven words constituted Bob’s entire effort at winemaking. Two seconds

of flapping jaws was the only work he did toward making that wine. He added no sugar, no yeast, did no racking, and certainly used no chemicals. He didn't do a damn thing to that five gallons of grape juice except abandon it in his basement with an airlock on top of it. Yet, a year later that carboy yielded the best homemade wine I had ever drank. It tasted good and had a heck of a kick to it.

I admit, there was an element of luck there, but I learned an important lesson about winemaking: the basic process is very simple — start with good quality juice and keep the air out of it. That simple, natural process can be easily ruined by too many complicated procedures, and heck, all those charts and graphs took the *fun* out of it. Making compost, I soon learned, was the same sort of phenomenon.

*Source: The Humanure Handbook. Jenkins Publishing, PO Box 607, Grove City, PA 16127. To order, phone: 1-800-639-4099.*

<http://www.jenkinspublishing.com/>

---

**MENU: [HOME](#) » [Reconstruction](#) » [Recovery](#) » [Renewal](#) » [Survival](#) » [Humanure Content](#)**

---



## COMPOST DEFINED

### BENEFITS OF COMPOST

#### ENRICHES SOIL

- Adds organic material
- Improves fertility and productivity
- Suppresses plant diseases
- Discourages insects
- Increases water retention
- Inoculates soil with beneficial microorganisms
- Reduces or eliminates fertilizer needs
- Moderates soil temperature

#### PREVENTS POLLUTION

- Reduces methane production in landfills
- Reduces or eliminates organic garbage
- Reduces or eliminates sewage

#### FIGHTS EXISTING POLLUTION

- Degrades toxic chemicals
- Binds heavy metals
- Cleans contaminated air
- Cleans stormwater runoff

#### RESTORES LAND

- Aids in reforestation
- Helps restore wildlife habitats
- Helps reclaim mined lands
- Helps restore damaged wetlands
- Helps prevent erosion on flood plains

#### DESTROYS PATHOGENS

- Can destroy human disease organisms
- Can destroy plant pathogens
- Can destroy livestock pathogens

According to the dictionary, compost is “*a mixture of decomposing vegetable refuse, manure, etc. for fertilizing and conditioning the soil.*” The Practical Handbook of Compost Engineering defines composting with a mouthful: “*The biological decomposition and stabilization of organic substrates, under conditions that allow development of thermophilic temperatures as a result of biologically produced heat, to produce a final product that is stable, free of pathogens and plant seeds, and can be beneficially applied to land.*”

The On-Farm Composting Handbook says that compost is “*a group of organic residues or a mixture of organic residues and soil that have been piled, moistened, and allowed to undergo aerobic biological decomposition.*” The Compost Council adds their two cents worth in defining compost: “*Compost is the stabilized and sanitized product of composting; compost is largely decomposed material and is in the process of humification (curing). Compost has little resemblance in physical form to the original material from which it is made.*” That last sentence should be particularly reassuring to the humanure composter.

J. I. Rodale states it a bit more eloquently: “*Compost is more than a fertilizer or a healing agent for the soil’s wounds. It is a symbol of continuing life . . . The compost heap is to the organic gardener what the typewriter is to the writer, what the shovel is to the laborer, and what the truck is to the truckdriver.*” <sup>4</sup>

- Can destroy livestock pathogens

### SAVES MONEY

- Can be used to produce food
- Can eliminate waste disposal costs
- Reduces the need for water, fertilizers, and pesticides
- Can be sold at a profit
- Extends landfill life by diverting materials
- Is a less costly bioremediation technique

Source: US EPA (October 1997). *Compost-New Applications for an Age-Old Technology*. EPA530-F-97-047. And author's experience.

In general, composting is a process managed by humans involving the cultivation of microorganisms that degrade organic matter in the presence of oxygen. When properly managed, the compost becomes so heavily populated with thermophilic microorganisms that it generates quite a bit of heat. Compost microorganisms can be so efficient at converting organic material into humus that the phenomenon is nothing short of miraculous.

Source: *The Humanure Handbook*. Jenkins Publishing, PO Box 607, Grove City, PA 16127. To order, phone: 1-800-639-4099.

<http://www.jenkinspublishing.com/>

---

**MENU: [HOME](#) » [Reconstruction](#) » [Recovery](#) » [Renewal](#) » [Survival](#) » [Humanure Content](#)**

---

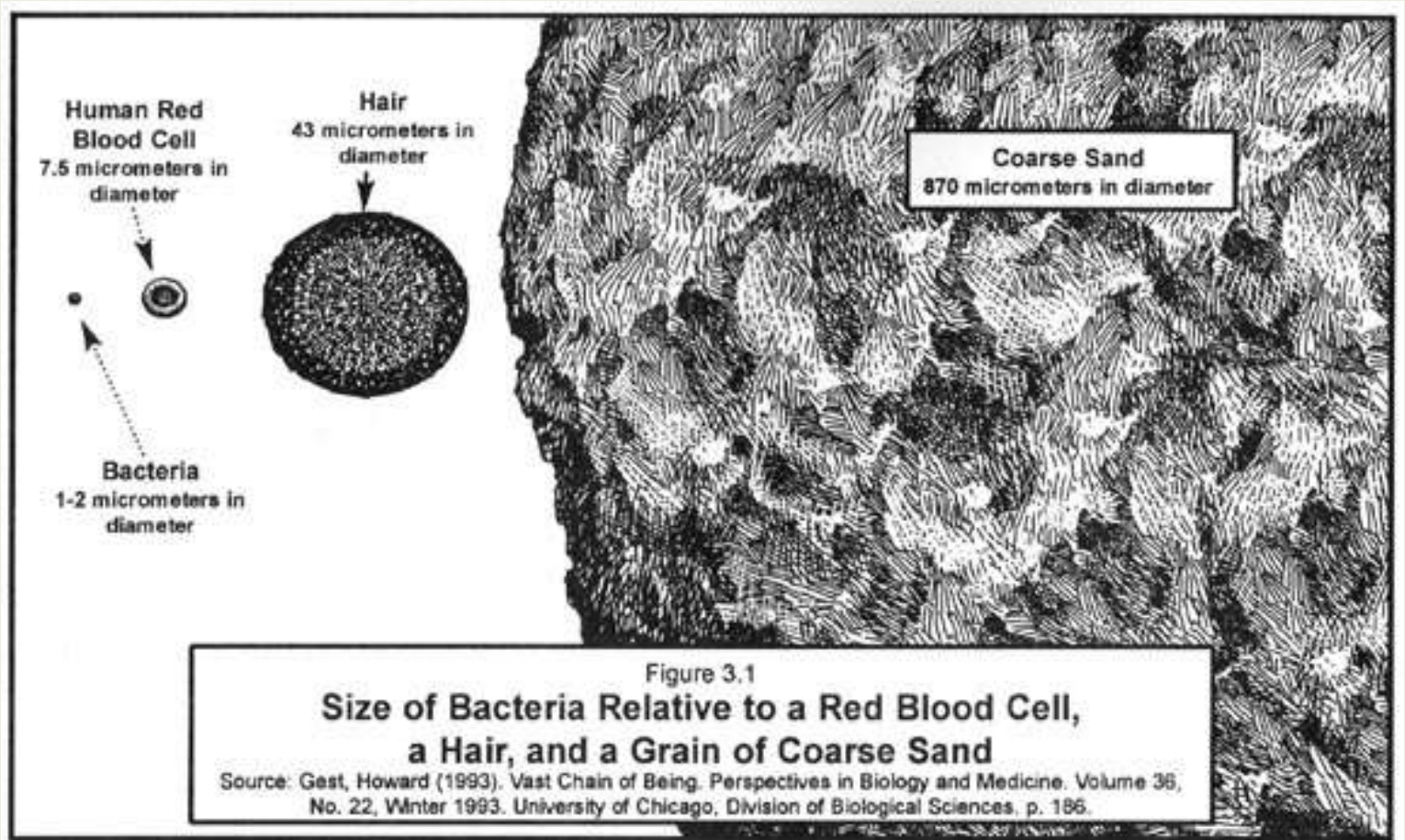
## NATURALCHEMY

In the Middle Ages, alchemists sought to change base metals, such as lead, into gold. Old German folklore tells of a tale in which a dwarf named Rumpelstiltskin had the power to spin flax straw into precious metal. Somewhere in the psyche of the western mind was a belief that a substance of little or no worth could be transmuted by a miraculous process into something of priceless value. Our ancestors were right, but they were barking up the wrong tree. The miraculous process of *composting* will transmute humanure into humus. In this way, potentially dangerous waste materials become soil additives vital for human life.

Our ancestors didn't understand that the key to this alchemy was right at their fingertips. Had they better known and understood natural processes they could have provided themselves with a wealth of soil fertility and saved themselves the tremendous suffering caused by diseases originating from fecal contamination of the environment. For some reason, they believed that gold embodied value, and in pursuit of glittering riches they neglected the things of real value: health, vitality, self-sufficiency, and sustainability.

Our ancestors had little understanding of a vast, invisible world which surrounded them, a world of countless creatures so small as to be quite beyond the range of human sight. And yet, some of those microscopic creatures were already doing work for humanity in the production of foods such as beer, wine, cheese, or bread. Although *yeasts* have been used by people for centuries, *bacteria* have only become harnessed by western humanity in recent times. Composting is one means by which the power of microorganisms can be utilized in a big way for the betterment of humankind. Unfortunately, our ancestors didn't understand the role of microorganisms in the decomposition of organic matter, nor the efficacy of microscopic life in converting humanure, food scraps, and plant residues into soil. They didn't understand compost.

The composting of organic materials requires armies of bacteria. This microscopic force works so vigorously that it heats the material to temperatures hotter than are normally found in nature. Other micro and macro organisms such as fungi and insects help in the composting process, too. When the compost cools down, earthworms often move in and eat their fill of delicacies, their excreta becoming a further refinement of the compost.



Successful composting requires the maintenance of an environment in which bacteria and fungi can thrive. This is also true for wine, except the microorganisms are yeast, not bacteria. Same for bread (yeast), beer (yeast), yogurt (bacteria), sauerkraut (bacteria), and cheese (bacteria); all of these things require the cultivation of microorganisms which will do the desired work. All of these things involve simple processes which, once you know the basic principles, are easy to carry out successfully. Sometimes bread doesn't rise, sometimes yogurt turns out watery, sometimes compost doesn't seem to turn out right. When this happens, a simple change of procedure will rectify the matter. Once you get the hang of it, you'd think even a chimpanzee could be trained to make compost.

Often, in our household, we have yogurt being made by billions of hard-working bacteria in a few quart mason jars beside the cookstove. At the same time, millions of yeast cells are cheerfully brewing beer in carboys in the back pantry, while millions more yeasts are happily brewing wine beside the beer. Sauerkraut is blithely fermenting in a crock behind the stove; bread is rising on the kitchen counter; and fungi are tirelessly forcing their fruits from oak logs on the sunporch. And then there's the compost pile. At times like these, I feel like a slave driver. But the workers never complain. Those little fellas work day and night, and they do a real nice job.

Source: *The Humanure Handbook*. Jenkins Publishing, PO Box 607, Grove City, PA 16127. To order, phone: 1-800-639-

**MENU: [HOME](#) » [Reconstruction](#) » [Recovery](#) » [Renewal](#) » [Survival](#) » [Humanure Content](#)**

---

---

## SOLAR POWER IN A BANANNA PEEL

Organic refuse is stored solar energy. Every apple core or potato peel holds a tiny amount of stored energy, just like a piece of firewood, which is converted into useable plant food by the compost pile. Perhaps S. Sides of the *Mother Earth News* states it more succinctly: “*Plants convert solar energy into food for animals (ourselves included). Then the [refuse] from these animals along with dead plant and animal bodies, ‘lie down in the dung heap,’ are composted, and ‘rise again in the corn.’ This cycle of light is the central reason why composting is such an important link in organic food production. It returns solar energy to the soil. In this context such common compost ingredients as onion skins, hair trimmings, eggshells, vegetable parings, and even burnt toast are no longer seen as garbage, but as sunlight on the move from one form to another.*” <sup>5</sup>

The organic material used to make compost could be considered anything on the Earth’s surface that had been alive, or from a living thing, such as manure, plants, leaves, sawdust, peat, straw, grass clippings, food scraps, and urine. A rule of thumb is that anything that will rot will compost, including such things as cotton clothing, wool rugs, rags, paper, animal carcasses, junk mail, and cardboard.

To compost means to convert organic material ultimately into soil or, more accurately, *humus*. Humus is a brown or black substance resulting from the decay of organic animal or vegetable refuse. It is a stable material that does not attract insects or nuisance animals. It can be handled and stored if necessary with no problem, and it is beneficial to the growth of plants. Humus holds moisture, and therefore increases the soil’s capacity to absorb and hold water. Compost is said to hold nine times its weight in water (900%), as compared to sand which only holds 2%, and clay 20%.<sup>6</sup>

Compost also adds slow-release nutrients essential for plant growth, creates air spaces in soil, helps balance the soil pH, darkens the soil (thereby helping it absorb heat), and supports microbial populations that add life to the soil. Nutrients such as nitrogen in compost are slowly released throughout the growing season, making them less susceptible to loss by leaching than the more soluble chemical fertilizers.<sup>7</sup> Organic matter from compost enables the soil to immobilize and degrade pesticides, nitrates, phosphorous, and other things that can become pollutants. Compost binds pollutants in soil systems, reducing their leachability and absorption by plants.<sup>8</sup>

The building of topsoil by Mother Nature is a centuries long process. Adding compost to soil will help to quickly restore fertility that might otherwise take nature hundreds of years to replace. We humans deplete our soils in relatively short periods of time. By composting our organic refuse and returning it to the land, we can restore that fertility also in relatively short periods of time.

Fertile soil yields food that promotes good health. One group of people, the Hunzas of northern India, has been studied to a great extent. One man who studied them extensively, Sir Albert Howard, stated, “*When the health and physique of the various northern Indian races were studied in detail the best were those of the Hunzas, a hardy, agile, and vigorous people, living in one of the high mountain valleys of the Gilgit Agency . . . There is little or no difference between the kinds of food eaten by these hillmen and by the rest of northern India. There is, however, a great difference in the way these foods are grown . . . [T]he very greatest care is taken to return to the soil all human, animal and vegetable [refuse] after being first composted together. Land is limited: upon the way it is looked after, life depends.*” <sup>9</sup>

Source: *The Humanure Handbook*. Jenkins Publishing, PO Box 607, Grove City, PA 16127. To order, phone: 1-800-639-4099.

<http://www.jenkinspublishing.com/>

---

**MENU: [HOME](#) » [Reconstruction](#) » [Recovery](#) » [Renewal](#) » [Survival](#) » [Humanure Content](#)**

---

---

**MENU:** [HOME](#) » [Reconstruction](#) » [Recovery](#) » [Renewal](#) » [Survival](#) » [Humanure Content](#)

---

## GOMER THE PILE

There are several reasons for piling the composting material. A pile keeps the material from drying out or cooling down prematurely. A level of moisture (50-60%) is necessary for the microorganisms to work happily.<sup>10</sup> A vertical stack prevents leaching and waterlogging, and holds heat in the pile. Vertical walls around a pile, especially if they're made of wood, or bales of straw, keep the wind off and will prevent one side of the pile (the windward side) from cooling down prematurely.

A neat, contained pile looks better. It looks like you know what you're doing, instead of looking like a garbage dump. A constructed compost bin also helps to keep out nuisance animals such as dogs.

A pile makes it easier to layer or cover the compost. When a smelly deposit is added to the top, it's a good idea to cover the raw refuse with clean organic material in order to eliminate unpleasant odors and to trap necessary oxygen in the pile. Therefore, if you're going to make compost, don't just fling it out in your yard in a heap. Construct a nice bin and do it right. That bin doesn't have to cost money; it can be made from recycled wood or cement blocks. Wood (not pressure-treated) may be preferable as it will insulate the pile and prevent heat loss and frost penetration. A compost bin doesn't have to be complicated in any way. It doesn't require electricity, technology, gimmicks, or doodads. You don't need shredders, choppers, grinders, or any machines whatsoever.

Compost *pits* are more likely to be used in dry, arid, or cool climates where conservation of moisture and temperature is imperative. The main disadvantage of pits is that they can become waterlogged in the event of an unexpected cloudburst, and excessive water will rob the pile of oxygen, a critical element in the process of decomposition by aerobic microorganisms. Therefore, when pits are used, a roof over them may be an advantage, and air channels may be necessary to allow oxygen to enter the compost.

*Source: The Humanure Handbook. Jenkins Publishing, PO Box 607, Grove City, PA 16127. To order, phone: 1-800-639-4099.*

<http://www.jenkinspublishing.com/>

---

**MENU:** [HOME](#) » [Reconstruction](#) » [Recovery](#) » [Renewal](#) » [Survival](#) » [Humanure Content](#)

---



## FOUR NECESSITIES FOR GOOD COMPOST

### MOISTURE

Compost must be kept moist. A dry pile will not work. When people who don't understand compost try to picture a humanure compost pile in someone's backyard, they imagine a giant heap of crap, draining all manner of noxious, smelly liquids out the bottom of the compost bin, and leaching into the groundwater. However, a compost pile is not a pile of garbage or waste. It's a living, breathing mass, a biological sponge which requires quite a bit of moisture. It's not likely to create a leaching problem unless subjected to very heavy rains while uncovered.

Why does compost require moisture? For one thing, composted materials shrink incredibly (40-80%),<sup>11</sup> mostly because of water loss. Compost can undergo considerable drying when wet materials are composted.<sup>12</sup> An initial moisture content of 65% can dwindle down to 20 to 30% in only a week, according to some researchers.<sup>13</sup> It is more likely that one will have to *add* moisture to their compost than have to deal with excess moisture leaching from it.

The amount of moisture a compost pile receives or needs depends on the materials put into the pile and on the location of the pile. In Pennsylvania, there are about 36 inches (about one meter) of rainfall per year, and compost only needs watering during an unusual drought. According to Sir Albert Howard, watering a compost pile in England (where the annual rainfall is 24 inches) is also unnecessary. Nevertheless, the water required for compost-making may be around 200 to 300 gallons for each cubic yard of finished compost.<sup>14</sup> This moisture requirement will be met when human urine is used in humanure compost and the top of the pile is open and receiving adequate rainfall. Additional water comes from moist organic materials such as food scraps. If adequate rainfall is not available and the contents of the pile are not moist, watering will be necessary to produce a moisture content equivalent to a squeezed-out sponge. Graywater from household drains or collected rainwater would suffice for this purpose.

### OXYGEN

We want to cultivate *aerobic* bacteria in the compost pile to ensure thermophilic decomposition. This is done by adding bulky materials to the compost pile in order to trap interstitial air spaces. Aerobic bacteria will suffer from a lack of oxygen if drowned in liquid, which is a common problem with commercial and home made composting toilets when improperly managed.

Bacterial decomposition can also take place anaerobically, but this is a slower, cooler process, which can, quite frankly, stink. Anaerobic odors can smell like rotten eggs (caused by hydrogen sulfide), sour milk (caused by butyric acids), vinegar (acetic acids), vomit (valeric acids), and putrefaction (alcohols and phenolic compounds).<sup>15</sup> Obviously, we want to avoid such odors by maintaining an aerobic compost pile.



Figure 3.2: The author probing a humanure compost pile in late winter.

This compost had not yet become thermophilically active.

Of the two thermometers, one has a long probe and the other a short one.

PHOTO BY JEANINE JENKINS

Good, healthy, aerobic compost need not offend one's sense of smell. However, in order for this to be true, a simple rule must be followed: *anything added to the compost that smells bad must be covered with a clean, organic material*. This means you must cover the deposits in your compost toilet and on your compost pile. When you defecate or urinate in your toilet, cover it. Use sawdust, use peat, use clean soil, use leaves, but keep it covered. Then there will be no odor. When you deposit smelly manure on your compost pile, cover it. Use weeds, use straw, use hay, whatever you can get your hands on (especially bulky material which will trap oxygen in the compost), but keep it covered. That's the simple secret to the odor issue.

## TEMPERATURE

Dehydration will cause the compost microorganisms to stop working. So will freezing. Compost piles will not work if frozen, which often occurs during the cold winters of the north. However, don't despair, the microorganisms will wait until the temperature rises and then they'll thaw out and, once again, work feverishly. You can continue to add to an outdoor compost pile all winter, even when the pile is frozen solid as a rock. The freezing stage helps to destroy some potential pathogens and, after the thaw, the pile works up a steam as if nothing happened.

## BALANCED DIET

A good carbon-nitrogen balance (a good blend of materials) is required for a nice, hot compost pile. Since most of the materials commonly added to a compost pile are very high in carbon, this means that a source of nitrogen must be incorporated into the blend of composting ingredients. This isn't as difficult as it may seem. You can carry bundles of weeds to your compost pile, add hay, straw, leaves, and garbage, but you'll still need one thing: nitrogen. Of course the solution is simple — add manure. Where can you get manure? From an animal. Where can you find an animal? *Look in a mirror.*

Table 3.1  
**NITROGEN LOSS AND CARBON/NITROGEN RATIO**

Initial C/N Ratio	Nitrogen Loss (%)
20.0	38.8
20.5	48.1
22.0	14.8
30.0	0.5
35.0	0.5
76.0	-8.0

Source: Gotaas, *Composting*, 1956, p. 92

Rodale states in *The Complete Book of Composting* that the average gardener may have difficulty in obtaining manure for the compost heap, but with “a little ingenuity and a thorough search,” it can be found. A gardener in the book testifies that when he gets “all steamed up to build myself a good compost pile, there has always been one big question that sits and thumbs its nose at me: *Where am I going to find the manure? I am willing to bet, too, that the lack of manure is one of the reasons why your compost pile is not the thriving humus factory that it might be.*”

Hmmm. WHERE can a large animal like a human being find manure? Gee, that's a tough one. Let's think real hard about that one. Perhaps with a little “ingenuity and a thorough search” we can come up with a source. Where IS that mirror, anyway?

Might be a clue there.

Source: *The Humanure Handbook*. Jenkins Publishing, PO Box 607, Grove City, PA 16127. To order, phone: 1-800-639-4099.

<http://www.jenkinspublishing.com/>

**MENU: [HOME](#) » [Reconstruction](#) » [Recovery](#) » [Renewal](#) » [Survival](#) » [Humanure Content](#)**

## THE CARBON/NITROGEN RATIO

Table 3.2

### CARBON / NITROGEN RATIOS

<u>Material</u>	<u>%N</u>	<u>C/N Ratio</u>
Activated Sludge	5-6	6
Amaranth	3.6	11
Apple Pomace	1.1	13
Blood	10-14	3
Bread	2.10	---
Cabbage	3.6	12
Cardboard	0.10	400-563
Coffee Grounds	---	20
Cow Manure	2.4	19
Corn Cobs	0.6	56-123
Corn Stalks	0.6-0.8	60-73
Cottonseed Meal	7.7	7
Cranberry Plant	0.9	61
Farmyard Manure	2.25	14
Fern	1.15	43
Fish Scrap	10.6	3.6
Fruit	1.4	40
Garbage (Raw)	2.15	15-25
Grass Clippings	2.4	12-19
Hardwood Bark	0.241	223
Hardwoods (Avg.)	0.09	560
Hay (General)	2.10	---

One way to understand the blend of ingredients in your compost pile is by using the C/N ratio (carbon/nitrogen ratio). Quite frankly, the chance of the average person measuring and monitoring the carbon and nitrogen quantities of their organic material is almost nil. This is like making wine the “foolproof” way. If composting requires this sort of drudgery, no one would do it.

However, I’ve found that by using all of the organic refuse my family produces, including humanure, urine, food refuse, weeds from our garden, rotting sawdust (which is hauled in), grass clippings, and maybe a little straw or hay now and then, we get the right mix of carbon and nitrogen for successful thermophilic composting. We do not compost newspapers or other burnable materials, we recycle them or burn them in our woodstove.

Nevertheless, no discussion of composting is complete without a review of the subject of the carbon/nitrogen ratio. A good C/N ratio for a compost pile is between 20/1 and 35/1.<sup>16</sup> That’s 20 parts of carbon to one part of nitrogen, up to 35 parts of carbon to one part of nitrogen. Or, for simplicity, you can figure on shooting for an optimum 30/1 ratio.

Hay (legume)	2.5	16
Hen Manure	8	6-15
Horse Manure	1.6	25-30
Humanure	5-7	5-10
Leaves	0.9	54
Lettuce	3.7	---
Meat Scraps	5.1	---
Mussel Residues	3.6	2.2
Mustard	1.5	26
Newsprint	0.06-0.14	398-852
Oat Straw	1.05	48
Olive Husks	1.2-1.5	30-35
Onion	2.65	15
Paper	---	100-800
Pepper	2.6	15
Pig Manure	3.1	14
Potato Tops	1.5	25
Poultry Carcasses	2.4	5
Purslane	4.5	8
Raw Sawdust	0.11	511
Red Clover	1.8	27
Rice Hulls	0.3	121
Rotted Sawdust	0.25	200-500
Seaweed	1.9	19
Sewage Sludge	2-6.9	5-16
Sheep Manure	2.7	16
Shrimp Residues	9.5	3.4
Slaughter Waste	7-10	2-4
Softwood Bark	0.14	496
Softwoods (Average)	0.09	641
Soybean Meal	7.2-7.6	4-6
Straw (General)	0.7	80

For microorganisms, carbon is the basic building block of life and is a source of energy, but nitrogen is also necessary for such things as proteins, genetic material, and cell structure. Microorganisms that digest compost need about 30 parts of carbon for every part of nitrogen they consume. That's a balanced diet for them. If there's too much nitrogen, the microorganisms can't use it all and the excess is lost in the form of smelly ammonia gas. Nitrogen loss due to excess nitrogen in the pile (a low C/N ratio) can be over 60%. At a C/N ratio of 30 or 35 to 1, only one half of one percent of the nitrogen will be lost (see Table 3.1). That's why you don't want too much nitrogen (manure, for example) in your compost: the nitrogen will be lost in the air in the form of ammonia gas, and nitrogen is too valuable for plants to allow it to escape into the atmosphere.<sup>17</sup>

That's also why humanure and urine alone *will not* compost. They contain too much nitrogen and not enough carbon, and microorganisms, like humans, gag at the thought of eating it. Since there's nothing worse than several billion gagging microorganisms, a carbon-based material must be added to the humanure in order to make it appealing. Plant cellulose is a carbon-based material, and therefore plant by-products such as hay, straw, weeds, or even paper products if ground to the proper consistency, will provide the needed carbon. Kitchen food scraps are generally C/N balanced, and they can readily be added to humanure compost. Sawdust (preferably *not* kiln-dried) is a good carbon material for balancing the nitrogen of humanure. Sawmill sawdust has a moisture content of 40-65%, which is good for compost.<sup>18</sup> Lumber yard sawdust, on the other hand, is kiln-dried and is biologically inert due to the dehydration. Therefore, it is not as desirable in compost unless rehydrated with water (or urine) before

Straw (Oat)	0.9	60
Straw (Wheat)	0.4	80-127
Telephone Books	0.7	772
Timothy Hay	0.85	58
Tomato	3.3	12
Turkey Litter	2.6	16
Turnip Tops	2.3	19
Urine	15-18	0.8
Vegetable Produce	2.7	19
Water Hyacinth	---	20-30
Wheat Straw	0.3	128-150
Whole Carrot	1.6	27
Whole Turnip	1.0	44



Sources: Gotaas, Harold B. (1956). *Composting - Sanitary Disposal and Reclamation of Organic Wastes* (p.44). World Health Organization, Monograph Series Number 31. Geneva. and Rynk, Robert, ed. (1992). *On-Farm Composting Handbook*. Northeast Regional Agricultural Engineering Service. Ph: (607) 255-7654. pp. 106-113. Some data from Biocycle, *Journal of Composting and Recycling*, July 1998, p.18, 61, 62; and January 1998, p.20.

being added to the compost pile. Also, lumber yard sawdust nowadays can often be contaminated with wood preservatives such as chromated copper arsenate (from “pressure treated lumber”). Both chromium and arsenic are human carcinogens, so it would be wise to avoid such materials.

The C/N ratio of humanure is between five and ten, averaging eight parts of carbon to one part of nitrogen. Therefore, you need to add a fair amount of carbon to humanure to get a 30/1 ratio (see Tables 3.2 and 3.3). I’ve found that the proper balance is obtained by putting all the organic refuse of my household (excluding printed material and burnable paper packaging) in the same compost pile, layered with weeds, straw, hay, leaves, or whatever organic material happens to be within reach. The humanure, when collected in the toilet, is covered with clean, partially rotted, hardwood or softwood sawdust, or another carbon-based material such as peat moss or rice hulls. This carbonaceous “cover material” not only balances the nitrogen, but also prevents odors remarkably well.

It has recently become popular for backyard composters to refer to organic materials as “browns” and “greens.” The browns (such as dried leaves) supply carbon, and the greens (such as fresh grass clippings) supply nitrogen. It’s recommended that two to three volumes of

browns be mixed with one volume of greens in order to produce a mix with the correct C/N ratio for composting.<sup>19</sup> However, since most backyard composters are not humanure composters, many backyard composters have a pile of material sitting in their compost bin showing very little activity. What is usually missing is nitrogen as well as moisture, two critical ingredients to any compost pile. Both of these are provided by humanure when collected with urine and a carbon cover material. The humanure mix can be quite brown, but is also quite high in nitrogen. So the “brown/green” approach doesn’t really work, nor is it necessary, when composting humanure along with other household organic material. Let’s face it, humanure composters are in a class by themselves.

Table 3.3 COMPOSITION OF HUMANURE		Table 3.4 DECOMPOSITION RATES OF SELECTED SAWDUSTS	
<b>Fecal Material:</b> 0.3-0.6 pounds per person per day (135-270 grams), wet weight.		<b>SAWDUST</b>	<b>RELATIVE DECOMPOSITION RATE</b>
Organic Matter (dry weight) .....	88-97%	Red Cedar .....	3.9
Moisture Content .....	66-80%	Douglas Fir .....	8.4
Nitrogen .....	5-7%	White Pine .....	9.5
Phosphorous .....	3-5.4%	Western White Pine .....	22.2
Potassium .....	1-2.5%	Average of all softwoods .....	12.0
Carbon .....	40-55%	Chestnut .....	33.5
Calcium .....	4-5%	Yellow Poplar .....	44.3
C/N Ratio .....	5-10	Black Walnut .....	44.7
<b>Urine:</b> 1.75-2.25 pints per person per day (1.0-1.3 liters)		White Oak .....	49.1
Moisture .....	93-96%	Average of all hardwoods .....	45.1
Nitrogen .....	15-19%	Wheat straw .....	54.6
Phosphorous .....	2.5-5%	The lower the number, the slower the decomposition rate. According to this data, hardwood sawdust decomposes faster than softwood sawdust.	
Potassium .....	3-4.5%	Source: Haug, Roger T. (1993). <i>The Practical Handbook of Compost Engineering</i> . CRC Press, Inc., 2000 Corporate Blvd. N.W., Boca Raton, FL 33431 USA, as reported in <i>Biocycle - Journal of Composting and Recycling</i> , December, 1998, p. 19.	
Carbon .....	11-17%		
Calcium .....	4.5-6%		
Source: Gotaas, Composting, (1956), p. 35			

Source: *The Humanure Handbook*. Jenkins Publishing, PO Box 607, Grove City, PA 16127. To order, phone: 1-800-639-4099.

<http://www.jenkinspublishing.com/>

**MENU: [HOME](#) » [Reconstruction](#) » [Recovery](#) » [Renewal](#) » [Survival](#) » [Humanure Content](#)**

## THERMOPHILIC MICROORGANISMS

A wide array of microorganisms live in a compost pile. Bacteria are especially abundant and are usually divided into several classes based upon the temperatures at which they grow best. The low temperature bacteria are the *psychrophiles*, which can grow at temperatures down to  $-10^{\circ}\text{C}$ , but whose optimum temperature is  $15^{\circ}\text{C}$  ( $59^{\circ}\text{F}$ ) or lower. The *mesophiles* live at medium temperatures,  $20\text{-}45^{\circ}\text{C}$  ( $68\text{-}113^{\circ}\text{F}$ ), and include human pathogens. *Thermophiles* thrive above  $45^{\circ}\text{C}$  ( $113^{\circ}\text{F}$ ), and some live at or even above the boiling point of water.

Strains of thermophilic bacteria have been identified with optimum temperatures ranging from  $55^{\circ}\text{C}$  to an incredible  $105^{\circ}\text{C}$  (above the boiling point of water), and many temperatures in between.<sup>20</sup> The strains that survive at extremely high temperatures are called, appropriately enough, extreme thermophiles, or hyperthermophiles, and have a temperature optimum of  $80^{\circ}\text{C}$  ( $176^{\circ}\text{F}$ ) or higher. Thermophilic bacteria occur naturally in hot springs, tropical soils, compost heaps, in your excrement, in hot water heaters (both domestic and industrial), and in your garbage, to name a few places.<sup>21</sup>

Thermophilic bacteria were first isolated in 1879 by Miquel, who found bacteria capable of developing at  $72^{\circ}\text{C}$  ( $162^{\circ}\text{F}$ ). He found these bacteria in soil, dust, *excrement*, sewage, and river mud. It wasn't long afterward that a variety of thermophilic bacteria were discovered in soil — bacteria that readily thrived at high temperatures, but not at room temperature. These bacteria are said to be found in the sands of the Sahara Desert, but not in the soil of cool forests. Composted or manured garden soils may contain 1-10 percent thermophilic types of bacteria, while field soils may have only 0.25% or less. Uncultivated soils may be entirely free of thermophilic bacteria.<sup>22</sup>

Table 3.5  
**COMPARISONS OF DIFFERENT TYPES OF MANURES**

<u>Manure</u>	<u>% Moisture</u>	<u>% Nitrogen</u>	<u>% Phosphorous</u>	<u>% Potassium</u>
Human	66-80	5-7	3-5.4	1.0-2.5
Cattle	80	1.67	1.11	0.56
Horse	75	2.29	1.25	1.38
Sheep	68	3.75	1.87	1.25
Pig	82	3.75	1.87	1.25
Hen	56	6.27	5.92	3.27
Pigeon	52	5.68	5.74	3.23
Sewage	---	5-10	2.5-4.5	3.0-4.5

Source: Gotaas, Harold B. (1956). *Composting - Sanitary Disposal and Reclamation of Organic Wastes*. pp. 35, 37, 40.  
World Health Organization, Monograph Series Number 31, Geneva.



Thermophiles are responsible for the spontaneous heating of hay stacks which can cause them to burst into flame. Compost itself can sometimes spontaneously combust. This occurs in larger piles (usually over 12 feet high) that become too dry (between 25% and 45% moisture) and overheat.<sup>23</sup> Spontaneous fires have started at two American composting plants (Schenectady and Cape May) due to excessively dry compost. According to the EPA, fires can start at surprisingly low temperatures (194°F) in too-dry compost, although this is not a problem for the back yard composter. When growing on bread, thermophiles can raise the temperature of the bread to 74°C (165°F). Heat from bacteria also warms germinating seeds, as seeds in a sterile environment are found to remain cool while germinating.<sup>24</sup>

Both mesophilic and thermophilic microorganisms are found widely distributed in nature, and are commonly resident on food material, garbage, and manures. This is not so surprising when considering mesophiles, because the temperatures they find to be optimum for their reproduction are commonly found in nature. These temperatures include those of warm-blooded animals, which excrete mesophiles in their stools in huge numbers.

A mystery presents itself, on the other hand, when we consider *thermophilic* microorganisms, since they prefer living at temperatures not commonly found in nature, but in hot springs, water heaters, and compost piles. Their preferences for hot temperatures has given rise to some speculation about their evolution. One theory suggests that the thermophiles were among the first living things on this planet, developing and evolving during the primordial birthing days of Earth, when surface temperatures were quite hot. They have thus been called the “Universal Ancestor.” Estimated at 3.6 billion years old, they are said to be so abundant as to “*comprise as much as half of all living things on the planet.*”<sup>25</sup> This is a rather startling concept, as it would mean that thermophilic organisms are perhaps more ancient than anything else alive. Their age would make dinosaurs look like new born babes, still wet behind the ears (however extinct). Of course, we humans, in comparison, have just shown up on the Earth. Thermophiles could, therefore, be the common ancestral organism of all life forms on our planet.

Just as startling is the concept that thermophiles, despite their need for a hot environment, are found everywhere. They’re lingering in your garbage, and in your stool, and have been since we humans first began to crawl on this planet. They have quietly waited since the beginning of time, and we haven’t been aware of them until recently. Researchers insist that thermophiles do not grow at ambient or room temperatures.<sup>26</sup> Yet, like a miracle, when we collect our organic refuse in a tidy pile, the thermophiles seem to be sparked out of their dormant slumber to work furiously toward creating the primordial heat they so long for. And they succeed — if we help them by creating compost piles. They reward us for our help by converting our garbage and other organic discards into life-sustaining earth.

The knowledge of living creatures incomprehensibly ancient, so small as to be entirely invisible, thriving at temperatures hotter than those normally found in nature, and yet found alive everywhere, is remarkable enough. The fact that they are so willing to work for our benefit, however, is rather humbling.

By some estimates, humanure contains up to 1,000,000,000,000 (a trillion) bacteria per gram.<sup>27</sup> These

are, of course, mixed species, and not by any means all thermophiles. A trillion bacteria is equivalent to the entire human population of the Earth multiplied by 166, and all squeezed into a gram of organic material. These microbiological concepts of size and number are difficult for us humans to grasp. Ten people crammed into an elevator we can understand. A trillion living organisms in a teaspoonful of crap is a bit mind-boggling.

Has anyone identified the species of microorganism that heats up compost? Actually, a large variety of species, a *biodiversity*, is critical to the success of compost. However, the thermophilic stage of the process is dominated by thermophilic bacteria. One examination of compost microorganisms at two compost plants showed that most of the bacteria (87%) were of the genus *Bacillus*, which are bacteria that form spores,<sup>28</sup> while another researcher found that above 65°C, the organisms in the compost were almost purely *Bacillus stearothermophilus*.<sup>29</sup>

Source: *The Humanure Handbook*. Jenkins Publishing, PO Box 607, Grove City, PA 16127. To order, phone: 1-800-639-4099.

<http://www.jenkinspublishing.com/>

---

**MENU: [HOME](#) » [Reconstruction](#) » [Recovery](#) » [Renewal](#) » [Survival](#) » [Humanure Content](#)**

---

## FOUR STAGES OF COMPOST

There is a huge difference between a backyard humanure composter and a municipal composter. Municipal composters handle large batches of organic materials all at once, while backyard composters continuously produce a small amount of organic material every day. Municipal composters, therefore, are “batch” composters, while backyard composters tend to be “continuous” composters. When organic material is composted in a batch, four stages of the composting process are apparent. Although the same phases occur during continuous composting, they are not as apparent as they are in a batch, and, in fact, they may be occurring concurrently rather than sequentially.

The four phases include: 1) the mesophilic phase; 2) the thermophilic phase; 3) the cooling phase; and 4) the curing phase.

Compost bacteria combine carbon with oxygen to produce carbon dioxide and energy. Some of the energy is used by the microorganisms for reproduction and growth, the rest is given off as heat. When a pile of organic refuse begins to undergo the composting process, mesophilic bacteria proliferate, raising the temperature of the composting mass up to 44°C (111°F). This is the first stage of the composting process. These mesophilic bacteria can include *E. coli* and other bacteria from the human intestinal tract, but these soon become increasingly inhibited by the temperature, as the thermophilic bacteria take over in the transition range of 44°C-52°C (111°F-125.6°F).

This begins the second stage of the process, when thermophilic microorganisms are very active and produce a lot of heat. This stage can then continue up to about 70°C (158°F),<sup>30</sup> although such high temperatures are neither common nor desirable in backyard compost. This heating stage takes place rather quickly and may last only a few days, weeks, or months. It tends to remain localized in the upper portion of a backyard compost bin where the fresh material is being added, whereas in batch compost, the entire composting mass may be thermophilic all at once.

After the thermophilic heating period, the humanure will appear to have been digested, but the coarser organic material will not. This is when the third stage of composting, the cooling phase, takes place. During this phase, the microorganisms that were chased away by the thermophiles migrate back into the compost and get back to work digesting the more resistant organic materials. Fungi and macroorganisms such as earthworms and sowbugs that break the coarser elements down into humus also move back in.

After the thermophilic stage has been completed, only the readily available nutrients in the organic material have been digested. There's still a lot of food in the pile, and a lot of work to be done by the

creatures in the compost. It takes many months to break down some of the more resistant organic material in compost such as “lignin” which comes from wood materials. Like humans, trees have evolved with a skin that is resistant to bacterial attack, and in a compost pile those lignins resist breakdown by thermophiles. However, other organisms, such as fungi, can break down lignin, given enough time; since they don’t like the heat of thermophilic compost, they simply wait for things to cool down before beginning their job.

The final stage of the composting process is called the curing, aging, or maturing stage, and it is a long and important one. Commercial composting professionals often want to make their compost as quickly as possible, usually sacrificing the compost’s curing time. One municipal compost operator remarked that if he could shorten his compost time to four months, he could make three batches of compost a year instead of only the two he was then making, thereby increasing his output by 50%. Municipal composters see truckloads of compost coming in to their facilities daily, and they want to make sure they don’t get inundated with organic material waiting to be composted. Therefore, they feel a need to move their material through the composting process as quickly as possible to make room for the new stuff coming in. Household composters don’t have that problem, although there seem to be plenty of backyard composters who are obsessed with making compost as quickly as possible. However, the curing, aging, or maturing of the compost is a critically important stage of the compost-making process. And, as in wine-making, an important element to figure into the equation is *patience*.

A long curing period (e.g., a year after the thermophilic stage) adds a safety net for pathogen destruction. Many human pathogens only have a limited period of viability in the soil, and the longer they are subjected to the microbiological competition of the compost pile, the more likely they will die a swift death.

Immature compost can be harmful to plants. Uncured compost can produce phytotoxins (substances toxic to plants), can rob the soil of oxygen and nitrogen, and can contain high levels of organic acids. So relax, sit back, put your feet up, and let your compost reach full maturity *before* you even think about using it.

*Source: The Humanure Handbook. Jenkins Publishing, PO Box 607, Grove City, PA 16127. To order, phone: 1-800-639-4099.*

<http://www.jenkinspublishing.com/>

---

**MENU: [HOME](#) » [Reconstruction](#) » [Recovery](#) » [Renewal](#) » [Survival](#) » [Humanure Content](#)**

---

## COMPOST BIODIVERSITY

Compost is normally populated by three general categories of microorganisms: bacteria, actinomycetes, and fungi (see Figure 3.3 and Table 3.6). It is the bacteria, and specifically the thermophilic bacteria, that create the heat of the compost pile.

Although considered bacteria, actinomycetes are effectively intermediate between bacteria and fungi because they look similar to fungi and have similar nutritional preferences and growth habits. They tend to be more commonly found in the later stages of the compost, and are generally thought to follow the thermophilic bacteria in succession. They, in turn, are followed predominantly by fungi during the last stages of the composting process.

There are at least 100,000 species of fungi known, the overwhelming majority of them being microscopic.<sup>31</sup> Most fungi cannot grow at 50°C (it's too hot) although some are heat tolerant (thermophilic fungi). Fungi tend to be absent in compost above 60°C, and actinomycetes tend to be absent above 70°C. Above 82°C biological activity effectively stops (extreme thermophiles are not found in compost).<sup>32</sup>

To get an idea of the microbial diversity normally found in nature, consider this: a teaspoon of native grassland soil contains 600-800 million bacteria comprising 10,000 species, plus perhaps 5,000 species of fungi, the mycelia of which could be stretched out for several miles. In the same teaspoon, there may be 10,000 individual protozoa of perhaps 1,000 species, plus 20-30 different nematodes from as many as 100 species. Sounds crowded to me. Obviously, good compost will reinoculate depleted, sanitized, chemicalized soils with a wide variety of beneficial microorganisms (see Figures 3.4 and 3.5).<sup>33</sup>

### COMPOST MICROORGANISMS "SANITIZE" COMPOST

One of the most frequent questions asked of me is, "How do you know that ALL parts of your compost have been subjected to high enough temperatures to kill ALL potential pathogens?" The answer should be obvious: you don't. You never will. Unless, of course, you examine every cubic centimeter of your compost for pathogens in a laboratory. This would probably cost many thousands of dollars, which would make your compost the most expensive in history.

It's not *only* the heat of the compost that causes the destruction of human, animal, and plant pathogens, it's a combination of factors including:

- competition for food from compost microorganisms;
- 
- inhibition and antagonism by compost microorganisms;
- 
- consumption by compost organisms;
- 
- biological heat generated by compost microorganisms; and
- 
- antibiotics produced by compost microorganisms.

For example, when bacteria were grown both in an incubator and separately in compost at 50°C, they died in the compost after only seven days, but lived in the incubator for seventeen days. This indicated that it is more than just temperature that determines the fate of pathogenic bacteria. The other factors listed above undoubtedly affect the viability of non-indigenous microorganisms (such as human pathogens) in a compost pile. Those factors require as large and diverse a microbial population as possible, which is best achieved by temperatures below 60°C (140°F). One researcher states that, “*Significant reductions in pathogen numbers have been observed in compost piles which have not exceeded 40°C [104°F].*” <sup>34</sup>

There is no doubt that the heat produced by thermophilic bacteria kills pathogenic microorganisms, viruses, bacteria, protozoa, worms and eggs that may inhabit humanure. A temperature of 50°C (122° F), if maintained for twenty-four hours, is sufficient to kill all of the pathogens, according to some sources (see Chapter Seven). A lower temperature will take longer to kill pathogens. A temperature of 46°C (115°F) may take nearly a week to kill pathogens completely, a higher temperature may only take minutes. What we have yet to determine is how low those temperatures can be and still achieve satisfactory pathogen elimination. Some researchers insist that all pathogens will die at ambient temperatures (normal air temperature) given enough time.

When Westerberg and Wiley composted sewage sludge which had been inoculated with polio virus, *Salmonella*, roundworm eggs, and *Candida albicans*, they found that a compost temperature of 47-55°C (116-130°F) maintained for three days killed all of these pathogens.<sup>35</sup> This phenomenon has been confirmed by many other researchers, including Gotaas, who indicates that pathogenic organisms are unable to survive compost temperatures of 55-60°C (131-140°F) for more than thirty minutes to one hour.<sup>36</sup> The first goal in composting humanure, therefore, should be to create a compost pile that will heat sufficiently to kill all potential human pathogens that may be found in the manure.

Nevertheless, the heat of the compost pile is a highly lauded characteristic of compost that is a bit overblown at times. People think that it’s only the heat of the compost that destroys pathogens, so they want their compost to become as hot as possible. This is a mistake. In fact, compost can become too hot, and when it does, it destroys the biodiversity of the microbial community. As one scientist states, “*Research has indicated that temperature is not the only mechanism involved in pathogen suppression, and that the employment of higher than necessary temperatures may actually constitute a barrier to effective sanitization under certain circumstances.*” <sup>37</sup> Perhaps only one species (e.g., *Bacillus*

*stearotherophilus*) may dominate the compost pile during periods of excessive heat, thereby driving out or just outright killing the other inhabitants of the compost, which include fungi and actinomycetes, as well as the bigger organisms that you can actually see.

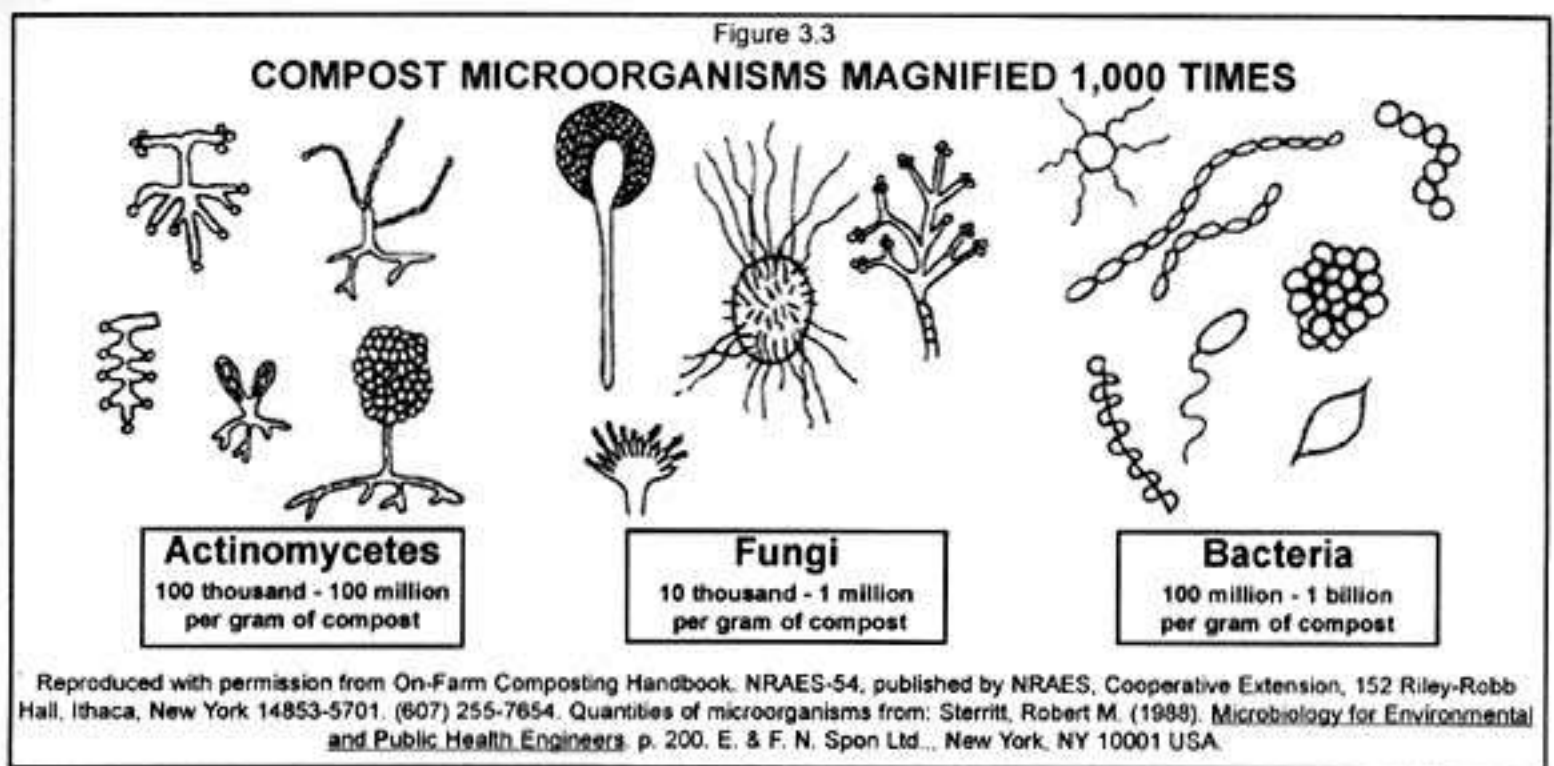


Table 3.6  
**MICROORGANISMS IN COMPOST**

<u>Actinomycetes</u>	<u>Fungi</u>	<u>Bacteria</u>
<i>Actinobifida chromogena</i>	<i>Aspergillus fumigatus</i>	<i>Alcaligenes faecalis</i>
<i>Microbispora bispora</i>	<i>Humicola grisea</i>	<i>Bacillus brevis</i>
<i>Micropolyspora faeni</i>	<i>H. insolens</i>	<i>B. circulans</i> complex
<i>Nocardia</i> sp.	<i>H. lanuginosa</i>	<i>B. coagulans</i> type A
<i>Pseudocardia thermophila</i>	<i>Malbranchea pulchella</i>	<i>B. coagulans</i> type B
<i>Streptomyces rectus</i>	<i>Myriococcum thermophilum</i>	<i>B. licheniformis</i>
<i>S. thermofuscus</i>	<i>Paecilomyces variotti</i>	<i>B. megaterium</i>
<i>S. thermoviolaceus</i>	<i>Papulaspora thermophila</i>	<i>B. pumilus</i>
<i>S. thermovulgaris</i>	<i>Scytalidium thermophilum</i>	<i>B. sphaericus</i>
<i>S. violaceus-ruber</i>	<i>Sporotrichum thermophile</i>	<i>B. stearotherophilus</i>
<i>Thermoactinomyces sacchari</i>		<i>B. subtilis</i>
<i>T. vulgaris</i>		<i>Clostridium thermocellum</i>
<i>Thermomonospora curvata</i>		<i>Escherichia coli</i>
<i>T. viridis</i>		<i>Flavobacterium</i> sp.
		<i>Pseudomonas</i> sp.
		<i>Serratia</i> sp.
		<i>Thermus</i> sp.

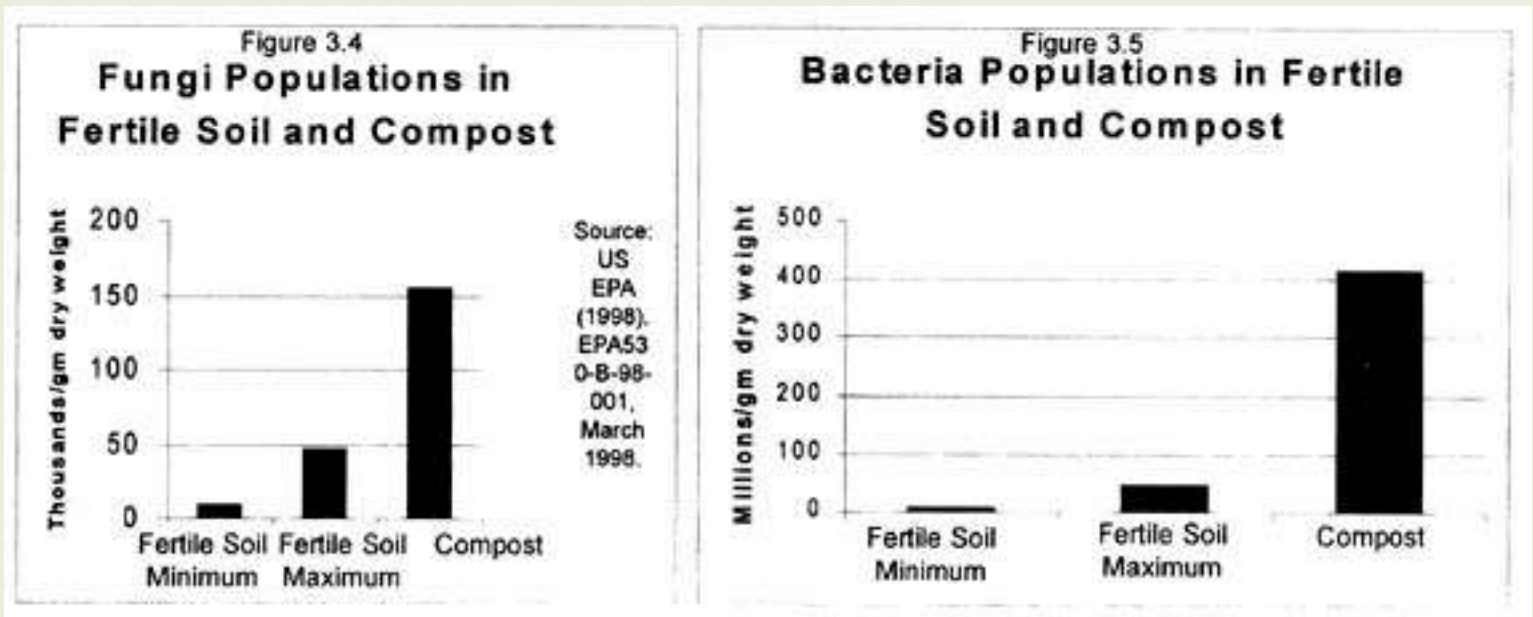
Source: Palmisano, Anna C. and Barlaz, Morton A. (Eds.) (1996). *Microbiology of Solid Waste*. Pp. 125-127. CRC Press, Inc., 2000 Corporate Blvd., N.W. Boca Raton, FL 33431 USA.

A compost pile that is too hot can destroy its own biological community and leave a mass of organic material that must be re-populated in order to continue the necessary conversion of organic matter to humus. Such sterilized compost is more likely to be colonized by unwanted microorganisms, such as *Salmonella*. Researchers have shown that the biodiversity of compost acts as a barrier to colonization by such unwanted microorganisms as *Salmonella*. In the absence of a biodiverse “indigenous flora,” such as happens through sterilization, *Salmonella* were able to regrow.<sup>38</sup>

The microbial biodiversity of compost is also important because it aids in the breakdown of the organic material. For example, in high-temperature compost (80°C), only about 10% of sewage sludge solids could be decomposed in three weeks, whereas at 50-60°C, 40% of the sludge solids were decomposed in only seven days. The lower temperatures apparently allowed for a richer diversity of living things which in turn had a greater effect on the degradation of the organic matter. One researcher indicates that optimal decomposition rates occur in the 55-59°C (131-139°F) temperature range, and optimal thermophilic activity occurs at 55°C (131°F), which are both adequate temperatures for pathogen destruction.<sup>39</sup> A study conducted in 1955 at Michigan State University, however, indicated that optimal decomposition occurs at an even lower temperature of 45°C (113°F).<sup>40</sup> Another researcher asserts that maximum biodegradation occurs at 45-55°C (113-131°F), while maximum microbial diversity requires a temperature range of 35-45°C (95-113°F).<sup>41</sup> Apparently, there is still some degree of flexibility in these estimates, as the science of “compost microhusbandry” is not an utterly precise one at this time. Control of excessive heat is rarely a concern for the backyard composter.

Some thermophilic actinomycetes, as well as mesophilic bacteria, produce antibiotics that display considerable potency toward other bacteria, and yet exhibit low toxicity when tested on mice. Up to one half of thermophilic strains can produce antimicrobial compounds, some of which have been shown to be effective against *E. coli* and *Salmonella*. One thermophilic strain with an optimum growth temperature of 50°C produces a substance that “*significantly aided the healing of infected surface wounds in clinical tests on human subjects. The product(s) also stimulated growth of a variety of cell types, including various animal and plant tissue cultures and unicellular algae.*”<sup>42</sup> The production of antibiotics by compost microorganisms theoretically assists in the destruction of human pathogens that may have existed in the organic material before composting.





Even if every speck of the composting material is not subjected to the high internal temperatures of the compost pile, the process of thermophilic composting nevertheless contributes immensely toward the creation of a sanitary organic material. Or, in the words of one group of composting professionals, “*The high temperatures achieved during composting, assisted by the competition and antagonism among the microorganisms [i.e., biodiversity], considerably reduce the number of plant and animal pathogens. While some resistant pathogenic organisms may survive and others may persist in cooler sections of the pile, the disease risk is, nevertheless, greatly reduced.*” <sup>43</sup>

If a backyard composter has any doubt or concern about the existence of pathogenic organisms in his or her humanure compost, s/he can use the compost for horticultural purposes rather than for food purposes. Humanure compost can grow an amazing batch of berries, flowers, bushes, or trees. Furthermore, lingering pathogens continue to die after the compost has been applied to the soil, which is not surprising as human pathogens prefer the warm and moist environment of the human body. As the World Bank researchers put it, “*even pathogens remaining in compost seem to disappear rapidly in the soil.*” [Night Soil Composting, 1981] Finally, compost can be tested for pathogens by compost testing labs.

Some say that a few pathogens in soil or compost are ok. “*Another point most folks don’t realize is that no compost and no soil are completely pathogen free. You really don’t want it to be completely pathogen free, because you always want the defense mechanism to have something to practice on. So a small number of disease-causing organisms is desirable. But that’s it.*” <sup>44</sup> Pathogens are said to have “minimum infective doses,” which vary widely from one type of pathogen to another, meaning that a number of pathogens are necessary in order to initiate an infection. The idea, therefore, that compost must be sterile is incorrect. It must be sanitary, which means it must have a greatly weakened, reduced, or destroyed pathogen population.

In reality, the average backyard composter knows whether his or her family is healthy or not. Healthy families have little to be concerned about, and can feel pretty confident that their thermophilic compost will be safe for their garden, provided the simple instructions in this book are followed regarding

compost temperatures and retention times, as discussed in Chapter Seven. On the other hand, there will always be those people who are fecophobic, and who will never be convinced that humanure compost is safe. These people are not likely to compost their humanure anyway, so who cares?

*Source: The Humanure Handbook. Jenkins Publishing, PO Box 607, Grove City, PA 16127. To order, phone: 1-800-639-4099.*

<http://www.jenkinspublishing.com/>

---

**MENU: [HOME](#) » [Reconstruction](#) » [Recovery](#) » [Renewal](#) » [Survival](#) » [Humanure Content](#)**

---

---

## COMPOST MYTHS

### TO TURN OR NOT TO TURN: THAT IS THE QUESTION

What is one of the first things to come to mind when one thinks of compost? Turning the pile. *Turn, turn, turn*, has become the mantra of composters worldwide. Early researchers who wrote seminal works in the composting field, such as Gotaas, Rodale, and many others, emphasize turning compost piles, almost obsessively so.

Much of compost's current popularity in the West can be attributed to the work of Sir Albert Howard, who wrote *An Agricultural Testament* (1943) and several other works on aspects of what has now become known as *organic* agriculture. Sir Howard's discussions of composting techniques focus on the Indore process of composting, a process developed in Indore, India, between the years of 1924 and 1931. The Indore process was first described in detail in Sir Howard's work (co-authored with Y. D. Wad), *The Waste Products of Agriculture*, in 1931. The two main principles underlying the Indore composting process include: 1) mixing animal and vegetable refuse with a neutralizing base, such as agricultural lime; and 2) managing the compost pile by physically turning it. The Indore process subsequently became adopted and espoused by composting enthusiasts in the West, and today one still commonly sees people turning and liming compost piles. For example, Robert Rodale wrote in the February, 1972 issue of *Organic Gardening* concerning composting humanure, "*We recommend turning the pile at least three times in the first few months, and then once every three months thereafter for a year.*"

A large industry has emerged from this philosophy, one which manufactures expensive compost turning equipment, and a lot of money, energy, and expense goes into making sure compost is turned regularly. To some compost professionals, the suggestion that compost doesn't need to be turned at all is utter blasphemy. Of course you have to turn it — it's a compost pile, for heaven's sake.

Or do you? Well, in fact, NO, you don't, especially if you're a backyard composter, and not even if you're a large scale composter. The perceived need to turn compost is one of the myths of composting.

Turning compost potentially serves four basic purposes. First, turning is supposed to add oxygen to the compost pile, which is supposed to be good for the aerobic microorganisms. We are warned that if we do not turn our compost, it will become anaerobic and smell bad, attract rats and flies, and make us into social pariahs in our neighborhoods. Second, turning the compost ensures that all parts of the pile are subjected to the high internal heat, thereby ensuring total pathogen death, and yielding a hygienically safe, finished compost. Third, the more we turn the compost, the more it becomes chopped and mixed,

and the better it looks when finished, rendering it more marketable. Fourth, frequent turning can speed up the composting process. Since backyard composters don't actually market their compost, usually don't care if it's finely granulated or somewhat coarse, and usually have no good reason to be in a hurry, we can eliminate the last two reasons for turning compost right off the bat. Let's look at the first two.

Aeration is necessary for aerobic compost, which is what we want. There are numerous ways to aerate a compost pile. One is to force air into or through the pile using fans, which is common at large-scale composting operations, where air is sucked from under the compost piles and out through a biofilter. The suction causes air to seep into the organic mass through the top, thereby keeping it aerated. However, this air flow is more often than not a method for trying to reduce the temperature of the compost, because the exhaust air draws quite a bit of heat away from the compost pile. Mechanical aeration is never a need of the backyard composter, and is limited to large scale composting operations where the piles are so big they can smother themselves if not subjected to forced aeration.

Aeration can also be achieved by poking holes in the compost, driving pipes into it, and generally impaling it. This seems to be popular among some backyard composters. A third way is to physically turn the pile. A fourth, largely ignored way, however, is to build the pile so that tiny interstitial air spaces are trapped in the compost. This is done by using coarse materials in the compost, such as hay, straw, weeds, and the like. When a compost pile is properly constructed, no additional aeration will be needed. Even the organic gardening pros admit that, *“good compost can be made without turning by hand if the materials are carefully layered in the heap which is well-ventilated and has the right moisture content.”*

[45](#)

This is especially true for “continuous compost,” which is different from “batch compost.” Batch compost is made from a batch of material that is composted all at once. This is what commercial composters do — they get a dumptruck load of garbage or sewage sludge from the municipality and compost it in one big pile. Backyard composters, especially humanure composters, produce organic residues daily, a little at a time, and rarely, if ever, in big batches. Therefore, continuous composters add material continuously to a compost pile, usually by putting the fresh material on the top. This causes the thermophilic activity to be in the upper part of the pile, while the thermophilically “spent” part of the compost sinks lower and lower to be worked on by fungi, actinomycetes, earthworms, and lots of other things. Turning continuous compost dilutes the thermophilic layer with the spent layers and can quite abruptly stop all thermophilic activity.

Researchers have measured oxygen levels in large-scale windrow composting operations (a windrow is a long, narrow pile of compost). One reported, *“Oxygen concentration measurements taken within the windrows during the most active stage of the composting process, showed that within fifteen minutes after turning the windrow — supposedly aerating it — the oxygen content was already depleted.”* [46](#) Other researchers compared the oxygen levels of large, turned and unturned batch compost piles, and have come to the conclusion that compost piles are largely self-aerated. *“The effect of pile turning was to refresh oxygen content, on average for [only] 1.5 hours (above the 10% level), after which it dropped to less than 5% and in most cases to 2% during the active phase of composting . . . Even with no turning, all piles eventually resolve their oxygen tension as maturity approaches, indicating that self-aeration alone*

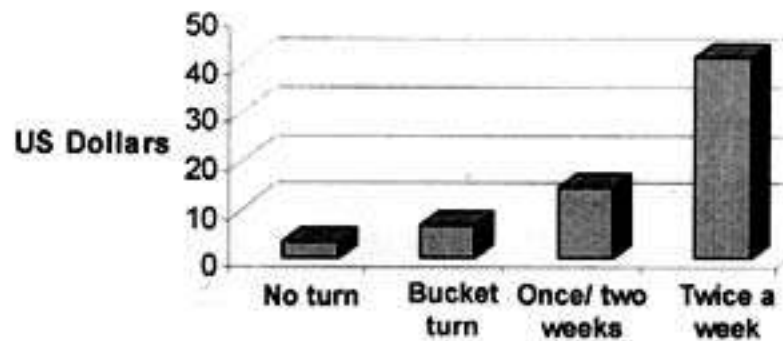
can adequately furnish the composting process . . . In other words, turning the piles has a temporal but little sustained influence on oxygen levels.” These trials compared compost that was not turned, bucket turned, turned once every two weeks, and turned twice a week.<sup>47</sup>

Interestingly enough, the same trials indicated that bacterial pathogens were destroyed whether the piles were turned or unturned, stating that there was no evidence that bacterial populations were influenced by turning schemes. There were no surviving *E. coli* or *Salmonella* strains, indicating that there were “no statistically significant effects attributable to turning.” Unturned piles can benefit by the addition of extra coarse materials such as hay or straw, which trap extra air in the organic material and make additional aeration unnecessary. Furthermore, unturned compost piles can be covered with a thick insulating layer of organic material, such as hay, straw, or even finished compost, which will allow the temperatures on the outer edges of the pile to warm enough for pathogen destruction.

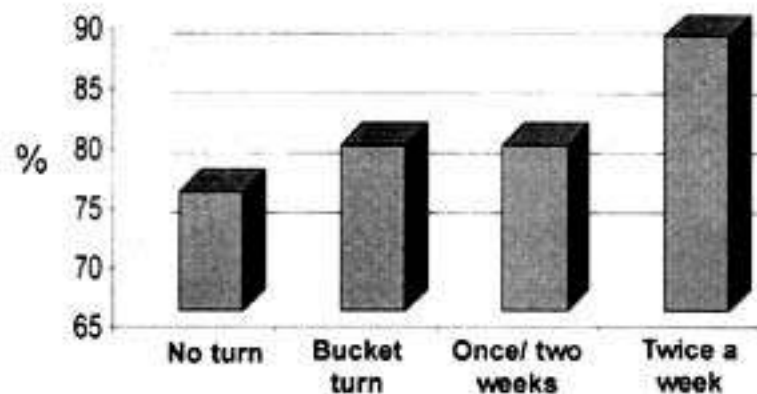
Not only can turning compost piles be an unnecessary expenditure of energy, but the above trials also showed that when batch compost piles are turned frequently, some other disadvantageous effects can result (see Figure 3.6). The more frequently compost piles are turned, the more they lose agricultural nutrients. When the finished compost was analyzed for organic matter and nitrogen loss, the unturned compost showed the least loss. The more frequently the compost was turned, the greater was the loss of both nitrogen and organic matter. Also, the more the compost was turned, the more it cost. The unturned compost cost \$3.05 per wet ton, while the compost turned twice a week cost \$41.23 per wet ton, a 1,351% increase. The researchers concluded that

Figure 3.6

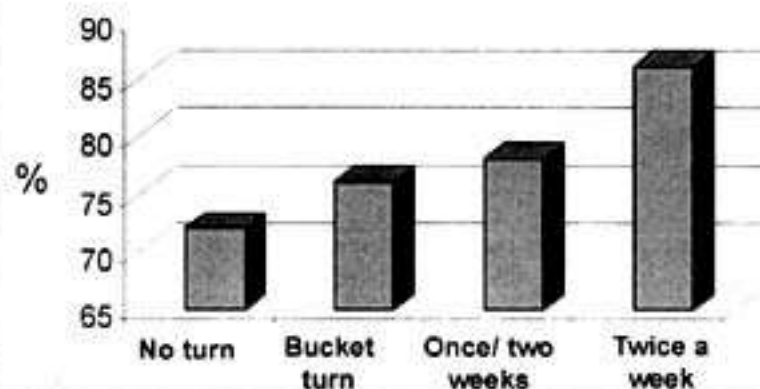
### Compost Turning Costs



### Organic Matter Loss Due to Turning (%)



### Nitrogen Loss Due To Turning (%)



“Composting methods that require intensification [frequent turning] are a curious result of modern popularity and technological development of composting as particularly evidenced in popular trade journals. They do not appear to be scientifically supportable based on these studies . . . By carefully managing composting to achieve proper mixes and limited turning, the ideal of a quality product at low economic burden can be achieved.” <sup>48</sup> Backyard composters like the “low economic burden” part of that statement.

no turn	once a turn	once two weeks	twice a week
Source: Brinton, William F. Jr. (date unknown). Sustainability of Modern Composting - Intensification Versus Cost and Quality. Woods End Institute, PO Box 297, Mt. Vernon, Maine 04352 USA.			

When large piles of compost are turned, they give off emissions of such things as *Aspergillus fumigatus* fungi, which can cause health problems in people. Aerosol concentrations from static (unturned) piles are relatively small when compared to mechanically turned compost. Measurements thirty meters downwind from static piles showed that aerosol concentrations of *A. fumigatus* were not significantly above background levels, and were “33 to 1800 times less” than those from piles that were being moved.<sup>49</sup>

Finally, turning compost piles in cold climates can cause them to lose too much heat. It is recommended that cold climate composters turn less frequently, if at all.<sup>50</sup>

### DO YOU NEED TO INOCULATE YOUR COMPOST PILE?

No. This is perhaps one of the most astonishing aspects of composting. In October of 1998, I took a trip to Nova Scotia, Canada, to observe the municipal composting operations there. The Province had legislated that as of November 30, 1998, no organic materials could be disposed of in landfills. By the end of October, with the “ban date” approaching, virtually all municipal organic garbage was being collected and transported instead to composting facilities, where it was effectively being recycled and converted into humus. The municipal garbage trucks would simply back into the compost facility building (the composting was done indoors), and then dump the garbage on the floor. The material consisted of the normal household and restaurant food materials such as banana peels, coffee grounds, bones, meat, spoiled milk, and paper products such as cereal boxes. The occasional clueless person would contribute a toaster oven, but these were sorted out. The organic material was then checked for other contaminants such as bottles and cans, run through a grinder, and finally shoved into a concrete compost bin. Within 24-48 hours, the temperature of the material would climb to 70°C (158°F). No inoculants were required. Incredibly, the thermophilic bacteria were already there, waiting in the garbage for this moment to arrive.

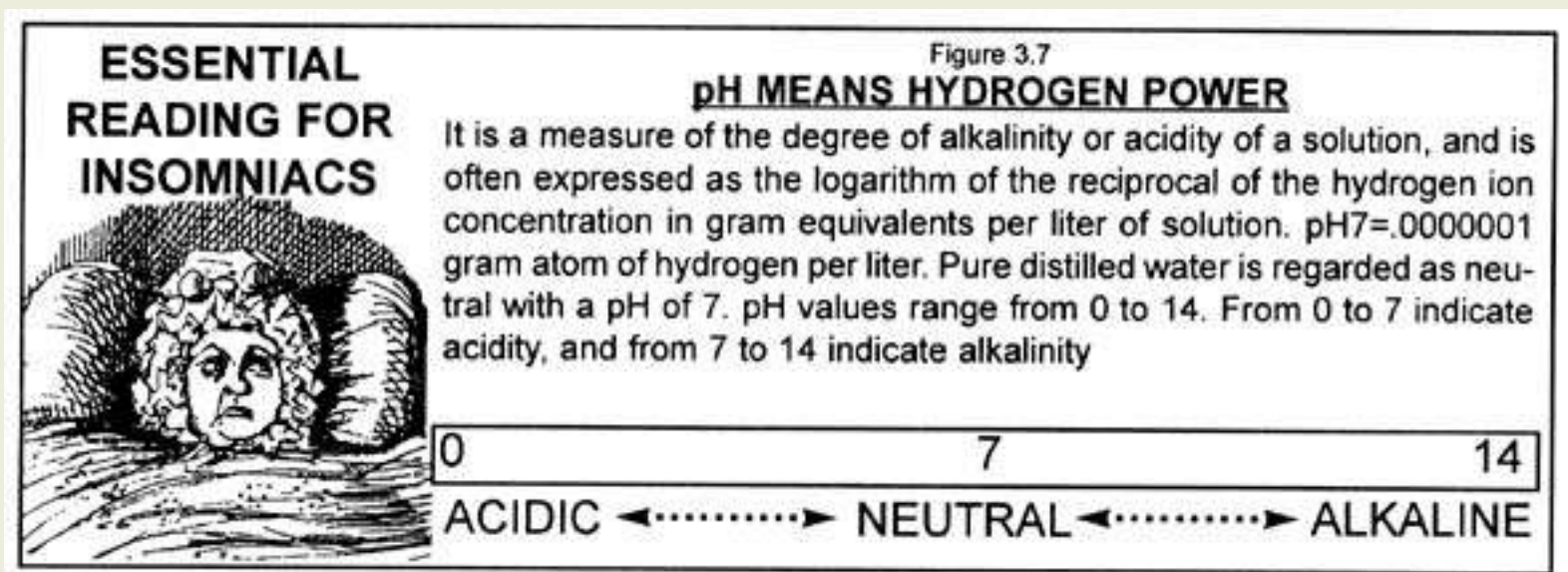
Researchers have composted materials with and without inocula and found that, “*although rich in bacteria, none of the inocula accelerated the composting process or improved the final product . . . The failure of the inocula to alter the composting cycle is due to the adequacy of the indigenous microbial population already present and to the nature of the process itself . . . The success of composting operations without the use of special inocula in the Netherlands, New Zealand, South Africa, India, China, the USA, and a great many other places, is convincing evidence that inocula and other additives*

are not essential in the composting of [organic] materials.”<sup>51</sup> Others state, “No data in the literature indicate that the addition of inoculants, microbes, or enzymes accelerate the compost process.”<sup>52</sup>

## LIME

It is not necessary to put lime (ground agricultural limestone) on your compost pile. The belief that compost piles should be limed is a common misconception. Nor are other mineral additives needed on your compost. If your soil needs lime, put the lime on your soil, not your compost. Bacteria don't digest limestone; in fact lime is used to kill microorganisms in sewage sludge (lime-stabilized sludge).

Aged compost is not acidic, even with the use of sawdust. The pH of finished compost should slightly exceed 7 (neutral). What is pH? It's a measure of acidity and alkalinity which ranges from 1-14. Neutral is 7. Below seven is acidic, above seven is basic or alkaline (see Figure 3.7). If the pH is too acidic or too alkaline, bacterial activity will be hindered or stopped completely. Lime and wood ashes raise the pH, but wood ashes should also go straight on the soil. The compost pile doesn't need them. It may seem logical that one should put into one's compost pile whatever one also wants to put into one's garden soil, as the compost will end up in the garden eventually, but that's not the reality of the situation. *What one should put into one's compost is what the microorganisms in the compost want or need, not what the garden soil wants or needs.*



Sir Albert Howard, one of the most well-known proponents of composting, as well as J. I. Rodale, another prominent organic agriculturist, have recommended adding lime to compost piles.<sup>53</sup> They seemed to base their reasoning on the belief that the compost will become acidic during the composting process, and therefore the acidity must be neutralized by adding lime to the pile while it's composting. It may well be the case that some compost becomes acidic during the process of decomposition, however, it seems to neutralize itself if left alone, yielding a neutral, or slightly alkaline end product. Therefore, it is recommended that you test your *finished* compost for pH before deciding that you need to neutralize any acids.

I find it perplexing that the author who recommended liming compost piles in one book, states in another, “*The control of pH in composting is seldom a problem requiring attention if the material is kept aerobic. . . the addition of alkaline material is rarely necessary in aerobic decomposition and, in fact, may do more harm than good because the loss of nitrogen by the evolution of ammonia as a gas will be greater at the higher pH.*”<sup>54</sup> In other words, don’t assume that you should lime your compost. Only do so if your finished compost is consistently acidic, which would be highly unlikely. Get a soil pH test kit and check it out. Researchers have indicated that maximum thermophilic composting occurs at a pH range between 7.5 to 8.5, which is slightly alkaline.<sup>55</sup> But don’t be surprised if your compost is slightly acidic at the start of the process. It should turn neutral or slightly alkaline and remain so when completely cured.

According to a 1991 report, scientists who were studying various commercial fertilizers found that agricultural plots to which composted sewage sludge had been added made better use of lime than plots without composted sludge. The lime in the composted plots changed the pH deeper in the soil, indicating that organic matter assists calcium movement through the soil “*better than anything else,*” according to Cecil Tester, Ph.D., research chemist at USDA’s Microbial Systems Lab in Beltsville, MD.<sup>56</sup> The implications are that compost should be added to the soil when lime is added to the soil.

Perhaps Gotaas sums it up best, “*Some compost operators have suggested the addition of lime to improve composting. This should be done only under rare circumstances such as when the raw material to be composted has a high acidity due to acid industrial wastes or contains materials that give rise to highly acid conditions during composting.*”<sup>57</sup>

## WHAT NOT TO COMPOST? YOU CAN COMPOST ALMOST ANYTHING

I get a bit perturbed when I see compost educators telling their students that there is a long list of things “NOT to be composted!” This prohibition is always presented in such an authoritative and serious manner that novice composters begin trembling in their boots at the thought of composting any of the banned materials. I can imagine naive composters armed with this misinformation carefully segregating their food scraps so that, god forbid, the wrong materials don’t end up in the compost pile. Those banned materials include meat, fish, dairy products, butter, bones, cheese, lard, mayonnaise, milk, oils, peanut butter, salad dressing, sour cream, weeds with seeds, diseased plants, citrus peels, rhubarb leaves, crab grass, pet manures, and, perhaps worst of all: human manure. Presumably, one must segregate half-eaten peanut butter sandwiches from the compost bucket, or any sandwich with mayonnaise or cheese, or any left-over salad with salad dressing, or spoiled milk, or orange peels, all of which must go to a landfill and be buried under tons of dirt instead of being composted. Luckily, I was never exposed to such instructions, and my family has composted EVERY bit of food scrap it has produced, including meat, bones, butter, oils, fat, lard, citrus peels, mayonnaise, and everything else on the list; we’ve done this in our backyard for almost 25 years with never a problem. Why would it work for me and not for anyone else? The answer, in a word, if I may hazard a guess, is *humanure*, another forbidden compost material.

When compost heats up, much of the organic material is quickly degraded. This holds true for oils and fats, or in the words of scientists, “*Based on evidence on the composting of grease trap wastes, lipids*



*[fats] can be utilized rapidly by bacteria, including actinomycetes, under thermophilic conditions.”* [58](#)

The problem with the materials on the “banned” list, is that they do require thermophilic composting conditions for best results. Otherwise, they can just sit in the compost pile and only very slowly decompose. In the meantime, they can look very attractive to the wandering dog, cat, raccoon, or rat. Ironically, when the forbidden materials, including humanure, are combined with other compost ingredients, thermophilic conditions will prevail. When humanure and the other controversial organic materials are segregated from compost, thermophilic conditions may not occur at all. This is a situation that is probably quite common in most backyard compost piles. The solution is not to segregate materials from the pile, but to add nitrogen and moisture, as is commonly found in manure.

As such, compost educators would provide a better service to their students if they told them the truth: almost any organic material will compost, rather than give them the false impression that some common food materials will not. Granted, some things do not compost very well. Bones are one of them, but they do no harm in a compost pile.

Nevertheless, toxic chemicals *should* be kept out of the backyard compost pile. Such chemicals are found, for example, in “pressure treated” (i.e. poison-soaked) lumber, which is saturated with cancer-causing chemicals (chromated copper arsenate). What not to compost: sawdust from pressure treated lumber, which is, unfortunately, a toxic material that is more and more available to the average gardener.

*Source: The Humanure Handbook. Jenkins Publishing, PO Box 607, Grove City, PA 16127. To order, phone: 1-800-639-4099.*

<http://www.jenkinspublishing.com/>

---

**MENU: [HOME](#) » [Reconstruction](#) » [Recovery](#) » [Renewal](#) » [Survival](#) » [Humanure Content](#)**

---

## COMPOST MIRACLES

### COMPOST CAN DEGRADE TOXIC CHEMICALS

Compost microorganisms not only convert organic material into humus, but they also degrade toxic chemicals into simpler, benign, organic molecules. These chemicals include gasoline, diesel fuel, jet fuel, oil, grease, wood preservatives, PCBs, coal gasification wastes, refinery wastes, insecticides, herbicides, TNT, and other explosives.<sup>59</sup>

In one experiment in which compost piles were laced with insecticides and herbicides, the insecticide (carbofuran) was completely degraded, and the herbicide (triazine) was 98.6% degraded after 50 days of composting. Soil contaminated with diesel fuel and gasoline was composted, and after 70 days in the compost pile, the total petroleum hydrocarbons were reduced approximately 93%.<sup>60</sup> Soil contaminated with Dicamba herbicide at a level of 3,000 parts per million showed no detectable levels of the toxic contaminant after only 50 days of composting. In the absence of composting, this biodegradation process normally takes years.

Compost also seems to bind lead in soils, making it less likely to be absorbed by living things. One researcher fed lead-contaminated soil to rats, either with compost added, or without. The soil to which compost had been added showed no toxic effects, whereas the soil without compost did exhibit some toxic effects.<sup>61</sup> Compost seems to strongly bind metals and prevent their uptake by both plants and animals, thereby preventing transfer of metals from contaminated soil into the food chain.<sup>62</sup> Plants grown in lead contaminated soil with ten percent compost showed a reduction in lead uptake of 82.6%, compared to plants grown in soil with no compost.<sup>63</sup>

Fungi in compost produce a substance that breaks down petroleum, thereby making it available as food for bacteria.<sup>64</sup> One man who composted a batch of sawdust contaminated with diesel oil said, “*We did tests on the compost, and we couldn’t even find the oil!*” The compost had apparently “eaten” it all.<sup>65</sup> Fungi also produce enzymes that can be used to replace chlorine in the paper-making process. Researchers in Ireland have discovered that fungi gathered from compost heaps can provide a cheap and organic alternative to toxic chemicals.<sup>66</sup>

Compost has been used in recent years to degrade other toxic chemicals as well. For example, chlorophenol contaminated soil was composted with peat, sawdust, and other organic matter, and after 25 months, the chlorophenol was reduced in concentration by 98.73%. Freon contamination was reduced by 94%, PCPs by up to

98%, and TCE by 89-99% in other compost trials.<sup>67</sup> Some of this degradation is due to the efforts of fungi at lower (mesophilic) temperatures.<sup>68</sup>

Table 3.7  
**MICROORGANISMS THAT HELP REMOVE METALS FROM WASTEWATER**

MICROORGANISM	METAL
<i>Zooglea ramigera</i> . . . . .	Copper
<i>Saccharomyces cerevisiae</i> . . . . .	Uranium
<i>Trichoderma viride</i> . . . . .	Copper
<i>Penicillium spinulosum</i> . . . . .	Copper, Cadmium, Zinc
<i>Aspergillus Niger</i> . . . . .	Copper, Cadmium, Zinc
<i>Chlorella vulgaris</i> . . . . .	Gold, Zn, Cu, Mercury
<i>Rhizopus arrhizus</i> . . . . .	Uranium

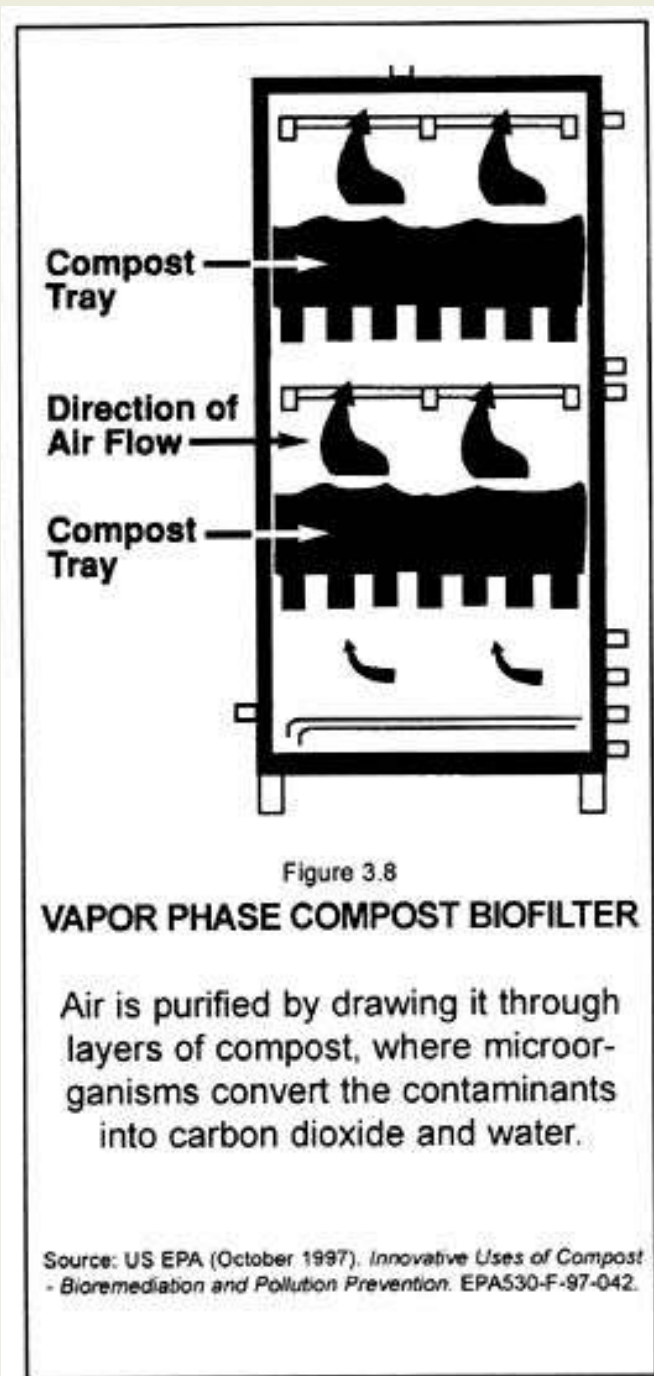
Source: Bitton, Gabriel (1994). *Wastewater Microbiology*, p. 302. Wiley-Liss, Inc. 605 Third Avenue, New York, NY 10518-0012.

Some bacteria even have an appetite for uranium. Derek Lovley, a microbiologist, has been working with a strain of bacteria that normally lives 650 feet under the Earth's surface. These microorganisms will eat, then excrete, uranium. The chemically altered uranium excreta becomes water insoluble as a result of the microbial digestion process, and can consequently be removed from the water it was contaminating (see Table 3.7).<sup>69</sup>

An Austrian farmer claims that the microorganisms he introduces into his fields have prevented his crops from being contaminated by the radiation from Chernobyl, the ill-fated Russian nuclear power plant, which contaminated his neighbor's fields. Sigfried Lubke sprays his green manure crops with compost-type microorganisms just before plowing them under. This practice has produced a soil rich in humus and teeming with microscopic life. After the Chernobyl disaster, crops from fields in Lubke's farming area were banned from sale due to high amounts of radioactive cesium contamination. However, when officials tested Lubke's crops, no trace of cesium could be found. The officials made repeated tests because they couldn't believe that one farm showed no radioactive contamination while the surrounding farms did. Lubke surmises that the humus just "ate up" the cesium.<sup>70</sup>

Compost is also able to decontaminate soil polluted with TNT from munitions plants. The microorganisms in the compost digest the hydrocarbons in TNT and convert them into carbon dioxide, water, and simple organic molecules. The method of choice for eliminating contaminated soil has thus far been incineration. However, composting costs far less, and yields a material that is valuable (compost), as opposed to incineration, which yields an ash that must itself be disposed of as toxic waste. When the Umatilla Army Depot in Hermiston, Oregon, a Superfund site, composted 15,000 tons of contaminated soil instead of incinerating it, it saved approximately \$2.6 million. Although the Umatilla soil was heavily contaminated with TNT and RDX (Royal Demolition Explosives), no explosives could be detected after composting, and the soil was restored to "a better condition than before it was contaminated."<sup>71</sup> Similar results have been obtained at Seymour Johnson Air Force Base in North Carolina, the Louisiana Army Ammunition Plant, the US Naval Submarine Base in Bangor, Washington, Fort Riley in Kansas, and the Hawthorne Army Depot in Nevada.<sup>72</sup>

The US Army Corps of Engineers estimates that we would save \$200 million if composting, instead of incineration, were used to clean up the remaining US munitions sites. The ability of compost to bioremediate toxic chemicals is particularly meaningful when one considers that in the US there are currently 1.5 million underground storage tanks leaking a wide variety of materials into soil, as well as 25,000 Department of Defense sites in need of remediation. In fact, it is estimated that the remediation costs for America's most polluted sites using standard technology may reach \$750 billion, while in Europe the costs could reach \$300 to \$400 billion.



As promising as compost bioremediation appears, however, it cannot heal all wounds. Heavily chlorinated chemicals show considerable resistance to microbiological biodegradability. Apparently, there are even some things a fungus will spit out.<sup>73</sup> On the other hand, some success has been shown in the bioremediation of PCBs (polychlorinated biphenyls) in composting trials conducted by Michigan State University researchers in 1996. In the best case, PCB loss was in the 40% range. Despite the chlorinated nature of the PCBs, researchers still managed to get quite a few microorganisms to choke the stuff down.<sup>74</sup>

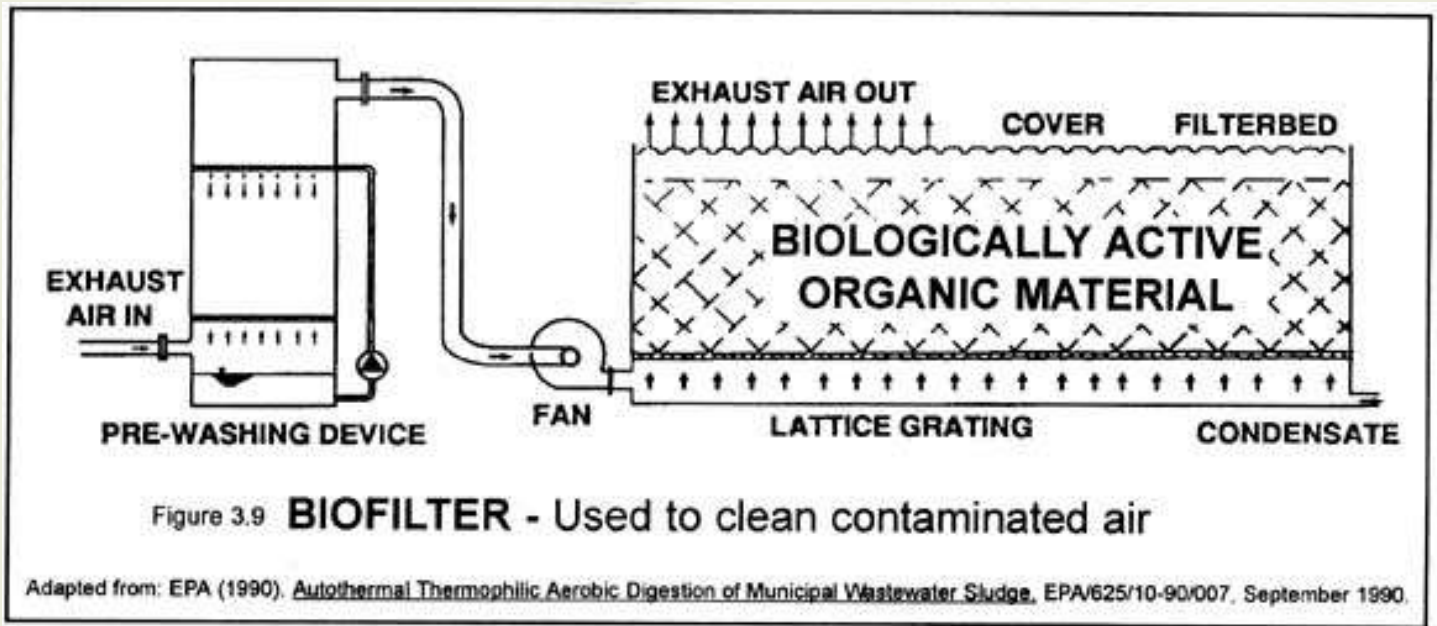
#### COMPOST CAN FILTER POLLUTED AIR AND WATER

Compost can control odors. Biological filtration systems, called “biofilters,” are used at large-scale composting facilities where exhaust gases are filtered for odor control. The biofilters are composed of layers of organic material such as wood chips, peat, soil, and compost through which the air is drawn in order to remove any contaminants. The microorganisms in the organic material eat the contaminants and convert them into carbon dioxide and water (see Figures 3.8 and 3.9).

In Rockland County, New York, one such biofiltration system can process 82,000 cubic feet of air a minute, and guarantee no detectable odor at or beyond the site property line. Another facility in Portland, Oregon, uses biofilters to remediate aerosol cans prior to disposal. After such remediation, the cans are no longer considered hazardous, and can be disposed of more readily. In this case, a \$47,000 savings in hazardous waste disposal costs was realized over a period of 18 months. Vapor Phase Biofilters can maintain a consistent Volatile Organic Compound removal efficiency of 99.6%, which isn’t

bad for a bunch of microorganisms.<sup>75</sup> After a year or two, the biofilter is recharged with new organic material, and the old stuff is simply composted or applied to the land.

Compost is also now used to filter stormwater runoff (see Figure 3.10). Compost Stormwater Filters use compost to filter out heavy metals, oil, grease, pesticides, sediment, and fertilizers from stormwater runoff. Such filters can remove over 90% of all solids, 82% to 98% of heavy metals, and 85% of oil and grease, while filtering up to eight cubic feet per second. These Compost Stormwater Filters prevent stormwater contamination from polluting our natural waterways.<sup>76</sup>



### COMPOST DEFENDS PLANTS FROM DISEASES

The composting process can destroy many plant pathogens. Because of this, diseased plant material should be thermophilically composted rather than returned to the land where reinoculation of the disease could occur. The beneficial microorganisms in thermophilic compost directly compete with, inhibit, or kill organisms that cause diseases in plants. Plant pathogens are also eaten by micro-arthropods, such as mites and springtails, which are found in compost.<sup>77</sup>

Compost microorganisms can produce antibiotics which suppress plant diseases. Compost added to soil can also activate disease resistance genes in plants, preparing them for a better defense against plant pathogens. Systemic Acquired Resistance caused by compost in soils allows plants to resist the effects of diseases such as *Anthraxnose* and *Pythium* root rot in cucumbers. Experiments have shown that when only some of the roots of a plant are in compost amended soil, while the other roots are in diseased soil, the entire plant can still acquire resistance to the disease.<sup>78</sup> Researchers have shown that compost combats chili wilt (*Phytophthora*) in test plots of chili peppers, and suppresses ashy stem blight in beans, *Rhizoctonia* root rot in black-eyed peas,<sup>79</sup> *Fusarium oxysporum* in potted plants, and gummy stem blight and damping off diseases in squash.<sup>80</sup> It is now recognized that the control of root rots with composts can be as effective as synthetic fungicides such as methyl bromide. Only a small percentage of compost microorganisms can, however, induce disease resistance in plants, which again emphasizes the importance of biodiversity in compost.

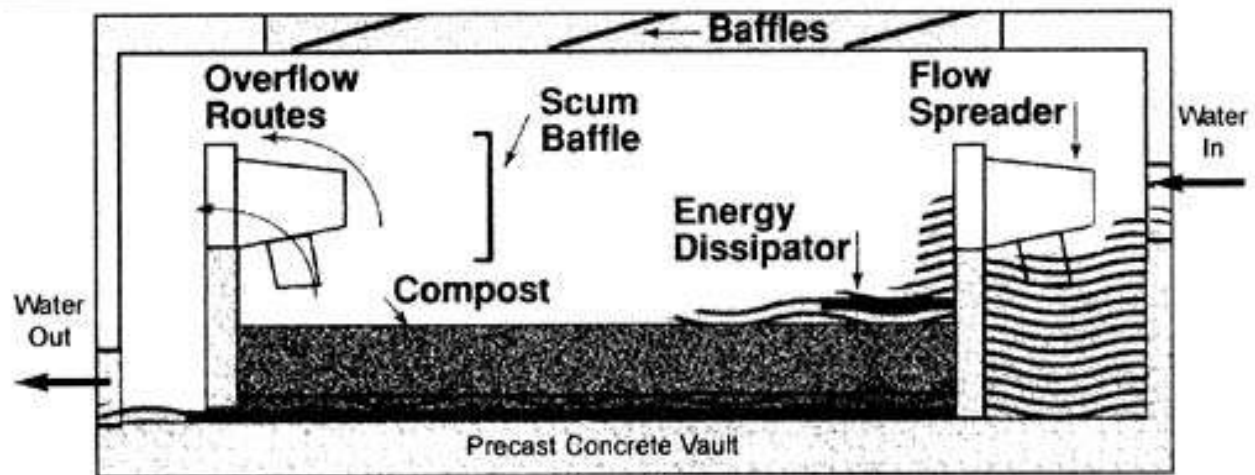


Figure 3.10

### COMPOST STORMWATER FILTER

Contaminants are removed from stormwater when filtered through layers of compost.

Source: US EPA (October 1997). *Innovative Uses of Compost - Bioremediation and Pollution Prevention*. EPA530-F-97-042.

Studies in 1968 by researcher Harry Hoitink indicated that compost inhibited the growth of disease-causing microorganisms in greenhouses by adding beneficial microorganisms to the soil. In 1987, he and a team of scientists took out a patent for compost that could reduce or suppress plant diseases caused by three deadly microorganisms: *Phytophthora*, *Pythium*, and *Fusarium*. Growers who used this compost in their planting soil reduced their crop losses from 25-75% to 1% without applying fungicides. The studies suggested that sterile soils could provide optimum breeding conditions for plant disease microorganisms, while a rich diversity of microorganisms in soil, such as that found in compost, would render the soil unfit for the proliferation of disease organisms.<sup>81</sup>

In fact, compost tea has also been demonstrated to have disease-reducing properties in plants. Compost tea is made by soaking mature (but not overly-mature) compost in water for three to twelve days. The tea is then filtered and sprayed on plants undiluted, thereby coating the leaves with live bacteria colonies. When sprayed on red pine seedlings, for example, blight was significantly reduced in severity.<sup>82</sup> Powdery mildew (*Uncinula necator*) on grapes was very successfully suppressed by compost tea made from cattle manure compost.<sup>83</sup> “Compost teas can be sprayed on crops to coat leaf surfaces and actually occupy the infection sites that could be colonized by disease pathogens,” states one researcher, who adds, “There are a limited number of places on a plant that a disease pathogen can infect, and if those spaces are occupied by beneficial bacteria and fungi, the crop will be resistant to infection.”<sup>84</sup>

Besides helping to control soil diseases, compost attracts earthworms, aids plants in producing growth stimulators, and helps control parasitic nematodes.<sup>85</sup> Compost “biopesticides” are now becoming increasingly effective alternatives to chemical bug killers. These “designer composts” are made by adding certain pest-fighting microorganisms to compost, yielding a compost with a specific pest-killing capacity. Biopesticides must be registered with the US EPA and undergo the same testing as chemical pesticides to determine their effectiveness and degree of public safety.<sup>86</sup>

Finally, composting destroys weed seeds. Researchers observed that after three days in compost at 55°C (131°F),

all of the seeds of the eight weed species studied were dead.<sup>87</sup>

## COMPOST CAN RECYCLE THE DEAD

Dead animals of all species and sizes can be recycled by composting. Of the 7.3 billion chickens, ducks, and turkeys raised in the US each year, about 37 million die from disease and other natural causes before they're marketed.<sup>88</sup> The dead birds can simply be composted. The composting process not only converts the carcasses to humus which can be returned directly to the farmer's fields, but it also destroys the pathogens and parasites that may have killed the birds in the first place. It is preferable to compost diseased animals on the farm where they originated rather than transport them elsewhere and risk spreading the disease. A temperature of 55°C maintained for at least three consecutive days maximizes pathogen control.

Composting is considered a simple, economic, environmentally sound, and effective method of managing animal mortalities. Carcasses are buried in, well, a compost pile. The composting process ranges from several days for small birds to six or more months for mature cattle. Generally, the total time required ranges from two to twelve months depending on the size of the animal and other factors such as ambient air temperature (time of year). The rotting carcasses are never buried in the ground where they may pollute groundwater, as is typical when composting is not used. Animal mortality recycling can be accomplished without odors, flies, or scavenging birds or animals.

Originally developed to recycle dead chickens, the animal carcasses that are now composted include full-grown pigs, cattle, and horses, as well as fish, sheep, calves, and other animals. The biological process of composting dead animals is identical to the process of composting any organic material. The carcasses provide nitrogen and moisture, while materials such as sawdust, straw, corn stalks, and paper provide carbon and bulk for air impregnation. The composting can be done in temporary three-sided bins made of straw or hay bales. A layer of absorbent organic material is used to cover the bottom of the bin, acting as a sponge for excess liquids. Large animals are placed back down in the compost, with their abdominal and thoracic cavities opened, and covered with organic material (sawmill sawdust has been shown to be one of the most effective organic materials with which to compost dead animals). After filling the bin with properly prepared animal mortalities, the top is covered with clean organic material that acts as a biofilter for odor control. Although large bones may remain after the composting process, they are easily broken when applied to the soil.<sup>89</sup>

Backyard composters can also make use of this technique. When a small animal has died and the carcass needs to be recycled, simply dig a hole in the top center of the compost pile, deposit the carcass, bury it over with the compost, and cover it all with a clean layer of organic material such as straw, weeds, or hay. You will never see the carcass again. This is also a good way to deal with fish, meat scraps, milk products, and other organic materials that may otherwise be attractive to nuisance animals. However, one should have thermophilic compost in order to do this, and one can greatly increase the likelihood of his or her backyard compost being thermophilic by adding the nitrogen and moisture that humanure provides.

I keep some ducks and chickens on my homestead, and occasionally one of them dies. A little poking around in the compost pile to create a depression in the top, and a plop of the carcass into the hole, and another creature is on the road to reincarnation. We've also used this technique regularly for recycling other smaller animal carcasses such as mice, baby chicks, and baby rabbits. After I collect earthworms from my compost pile to go fishing at the local pond, I filet the catch and put it in the freezer for winter consumption. The fish remains go straight into the compost, buried in the same manner as any other animal mortality. We have five outdoor cats, and they wouldn't

be caught dead digging around in thermophilic humanure compost looking for a bite to eat. Nor would our dog — and dogs will eat anything, but not when buried in thermophilic compost.

## COMPOST RECYCLES PET MANURES

Can you use dog manure in your compost? I can honestly say that I've never tried it, as I do not have a source of dog manure for experimentation (my dog is a free-roaming outdoor dog, and he leaves his scat somewhere out of sight). Numerous people have written to ask me whether pet manures can go into their household compost pile, and I have responded that I don't know from experience. So I've recommended that pet manures be collected in their own separate little compost bins with cover materials such as hay, grass clippings, leaves, weeds, or straw, and perhaps occasionally watered a bit to provide moisture. A double bin system will allow the manures to be collected for quite some time in one bin, then aged for quite some time while the second bin is being filled. What size bin? About the size of a large garbage can, although a larger mass may be necessary in order to spark a thermophilic reaction.

On the other hand, this may be entirely too much bother for most pet owners who are also composters, and you may just want to put pet and human manures into one compost bin. This would certainly be the simpler method. The idea of composting dog manure has been endorsed by J. I. Rodale in the *Encyclopedia of Organic Gardening*. He states, "*Dog manure can be used in the compost heap; in fact it is the richest in phosphorous if the dogs are fed with proper care and given their share of bones.*" He advises the use of cover materials similar to the ones I mentioned above, and recommends that the compost bin be made dog-proof, which can be done with straw bales, chicken wire, boards, or fencing.

## ONE WAY TO RECYCLE JUNK MAIL

Composting is a solution for junk mail, too. A pilot composting project was started in 1997 in Dallas-Ft. Worth, Texas, where 800 tons of undeliverable bulk mail are generated annually. The mail was ground in a tub grinder, covered with wood chips so it wouldn't blow away, then mixed with zoo manure, sheep entrails, and discarded fruits and vegetables. The entire works was kept moist and thoroughly mixed. The result — a finished compost "*as good as any other compost commercially available.*" It grew a nice bunch of tomatoes, too.<sup>90</sup>

What about newspapers in backyard compost? Yes, newspaper will compost, but there are some concerns about newsprint. For one, the glossy pages are covered with a clay that retards composting. For another, the inks can be petroleum-based solvents or oils with pigments containing toxic substances such as chromium, lead and cadmium in both black and colored inks. Pigment for newspaper ink still comes from benzene, toluene, naphthalene, and other benzene ring hydrocarbons which may be quite harmful to human health if accumulated in the food chain. Fortunately, quite a few newspapers today are using soy-based inks instead of petroleum-based inks. If you really want to know about the type of ink in your newspaper, call your newspaper office and ask them. Otherwise, keep the glossy paper or colored pages in your compost to a minimum. Remember, ideally, compost is being made to use for producing human food. One should try to keep the contaminants out of it, if possible.<sup>91</sup>

Wood's End Laboratory in Maine did some research on composting ground up telephone books and newsprint, which had been used as bedding for dairy cattle. The ink in the paper contained common cancer-causing chemicals, but after composting it with dairy cow manure, the dangerous chemicals were reduced by 98%.<sup>92</sup> So it appears that if you're using shredded newspaper for bedding under livestock, you *should* compost it, if for no other reason than to eliminate some of the toxic elements from the newsprint. It'll probably make acceptable



compost too, especially if layered with garbage, manure, and other organic materials.

What about things like sanitary napkins and disposable diapers? Sure, they'll compost, but they'll leave strips of plastic throughout your finished compost which are quite unsightly. Of course, that's OK if you don't mind picking the strips of plastic out of your compost. Otherwise, use cloth diapers and washable cloth menstrual pads instead.

Toilet paper composts, too. So do the cardboard tubes in the center of the rolls. Unbleached, recycled toilet paper is ideal. Or you can use the old fashioned toilet paper, otherwise known as corncobs. Popcorn cobs work best, they're softer. Corncobs don't compost very readily though, so you have a good excuse not to use them. There are other things that don't compost well: eggshells, bones, hair, and woody stems, to name a few. We throw our eggshells back to our chickens, or into the woodstove. Bones go into the woodstove, or to the cats or dog. Hair goes out to the birds for nests, if not into the compost pile.

Compost professionals have almost fanatically seized upon the idea that wood chips are good for making compost. Nowadays, when novice composters want to begin making compost, the first thing they want to know is where they can get wood chips. In fact, wood chips do NOT compost very well at all, unless ground into fine particles, as in sawdust. Even compost professionals admit that they have to screen out their wood chips *after* the compost is finished because they didn't decompose. They insist on using them anyway, because they break up the compost consistency and maintain air spaces in their large masses of organic material. However, a home composter should avoid wood chips and use other bulking materials that degrade more quickly, such as hay, straw, sawdust, and weeds.

Finally, never put woody stemmed plants, such as tree saplings, on your compost pile. I hired a young lad to clear some brush for me one summer and he innocently put the small saplings on my compost pile without me knowing it. Later, I found them networked through the pile like iron reinforcing rods. I'll bet the lad's ears were itching that day — I sure had some nasty things to say about him. Fortunately, only Gomer, the compost pile, heard me.

*Source: The Humanure Handbook. Jenkins Publishing, PO Box 607, Grove City, PA 16127. To order, phone: 1-800-639-4099.  
<http://www.jenkinspublishing.com/>*

---

**MENU: [HOME](#) » [Reconstruction](#) » [Recovery](#) » [Renewal](#) » [Survival](#) » [Humanure Content](#)**

---

**MENU:** [HOME](#) » [Reconstruction](#) » [Recovery](#) » [Renewal](#) » [Survival](#) » [Humanure Content](#)

---

## VERMICOMPOSTING

Vermicomposting, or worm composting, involves the use of redworms (*Eisenis fetida* or *Lumbricus rubellus*) to consume organic material either in specially designed worm boxes, or in large-scale, outdoor compost piles. Redworms prefer a dark, cool, well-aerated space, and thrive on moist bedding such as shredded newspaper. Kitchen food scraps are placed in worm boxes and are consumed by the worms. Worm castings are left in their place, which can be used like finished compost to grow plants. Vermicomposting is popular among children who like to watch the worms, and among adults who prefer the convenience of being able to make compost under their kitchen counter or in a household closet.

Although vermicomposting involves microorganisms as well as earthworms, it is not the same as thermophilic composting. The hot stage of thermophilic composting will drive away all earthworms from the hot area of the compost pile. However, they will migrate back in after the compost cools down. Earthworms are reported to actually eat root-feeding nematodes, pathogenic bacteria, and fungi, as well as small weed seeds.<sup>93</sup>

When thermophilic compost is piled on the bare earth, a large surface area is available for natural earthworms to migrate in and out of the compost pile. Properly prepared thermophilic compost situated on bare earth should require no addition of earthworms, as they will naturally migrate into the compost when it best suits them. My compost is so full of natural earthworms at certain stages in its development that, when dug into, it looks like spaghetti. These worms are occasionally harvested and transformed into fish. This is a process which converts compost directly into protein, but which requires a fishing rod, a hook, and lots of patience.

*Source: The Humanure Handbook. Jenkins Publishing, PO Box 607, Grove City, PA 16127. To order, phone: 1-800-639-4099.*

<http://www.jenkinspublishing.com/>

---

**MENU:** [HOME](#) » [Reconstruction](#) » [Recovery](#) » [Renewal](#) » [Survival](#) » [Humanure Content](#)

---

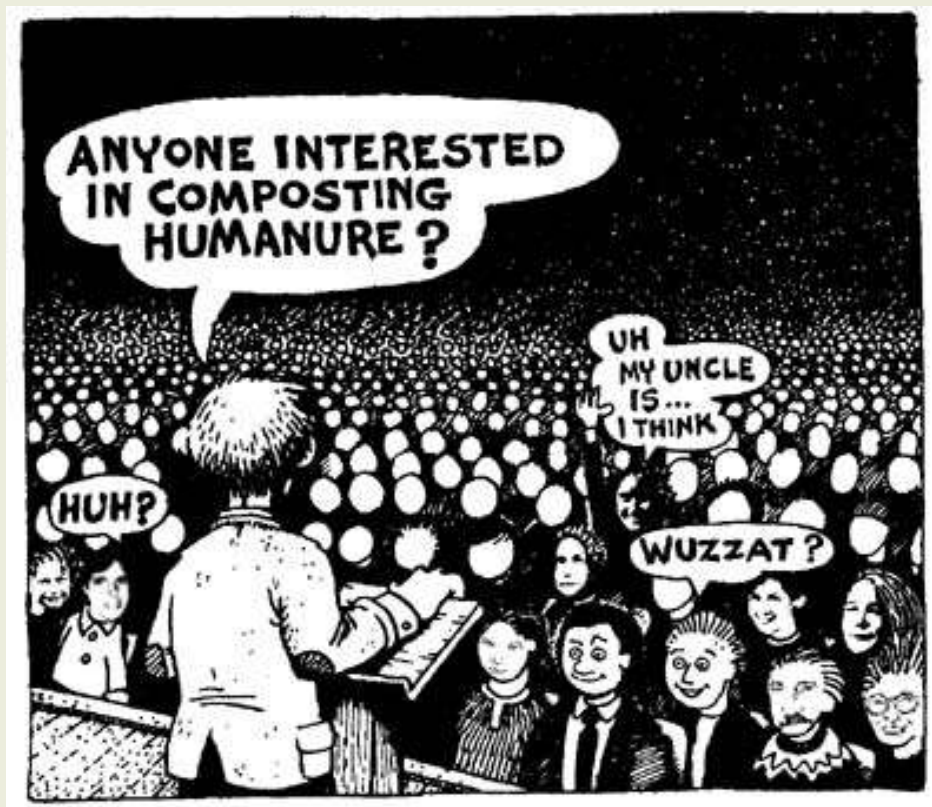
## PRACTICE MAKES COMPOST

*“Composting is easier to do than to describe, and, like lovemaking, magic when you do it well.”*

Sim Van der Ryn

After reading this chapter one may become overwhelmed with all that is involved in composting: bacteria, actinomycetes, fungi, thermophiles, mesophiles, C/N ratios, oxygen, moisture, temperatures, bins, pathogens, curing, and biodiversity. How do you translate this into your own personal situation and locate it all in your own backyard? How does one become an accomplished composter, a master composter? That’s easy — just do it. Then keep doing it. Throw the books away (not this one, of course) and get some good, old-fashioned experience. There’s no better way to learn. Book learning will only get you so far, but not far enough. A book such as this one is for inspiring you, for sparking your interest, and for reference. But you have to get out there and *do it* if you really want to learn.

Work with the compost, get the feel of the process, look at your compost, smell the finished product, buy or borrow a compost thermometer and get an idea of how well your compost is heating up, then use your compost for food production. Rely on your compost. Make it a part of your life. Need it and value it. In no time, without the need for charts or graphs, Ph.D.s, or worry, your compost will be as good as the best of them. Perhaps someday we’ll be like the Chinese who give prizes for the best compost in a county, then have intercounty competitions. Now *that’s* getting your shit together.





---

*Source: The Humanure Handbook. Jenkins Publishing, PO Box 607, Grove City, PA 16127. To order, phone: 1-800-639-4099.  
<http://www.jenkinspublishing.com/>*

---

**MENU: [HOME](#) » [Reconstruction](#) » [Recovery](#) » [Renewal](#) » [Survival](#) » [Humanure Content](#)**

---

# DEEP SH\*T

(\*Philosophy and Speculation)



*“From the Latin word humus for earth, true humility grounds the seeker in truth.”*

Edward Hayes - Prayers for a Planetary Pilgrim  
(Special thanks to Sister Barbara of Villa Maria, PA)

Composting humanure is an act of humility, and the practice of humility is an exercise that strengthens one’s spirit. The Earth provides us with life; it gives us our children, allows us to pursue our dreams. All of the beauty and joy that makes up our lives ultimately springs from her breasts to nurture and strengthen us. We suckle from her — and then we give back feces and urine — usually in the form of surface and water pollutants.

Shortly after the first edition of this book was published, I was invited to speak to a group of nuns at a convent. It was my first speaking invitation, and I still remember the phone call:

“Mr. Jenkins, we recently bought a copy of your book, *Humanure*, and we would like to have you speak at our convent.”

At this time, I was still doubtful that anyone was even interested in the topic of humanure composting, so I responded, “What about?”

“About the topic of your book.”

“Composting?”

“Yes, but specifically, *humanure* composting.” At this point I was somewhat speechless. I couldn’t understand exactly why a group of nuns would be interested in composting their own shit. Somehow I couldn’t imagine standing in front of a room full of nuns in habits, speaking about turds. But I kept the stammering to a minimum and accepted the invitation.

It was Earth Day, 1995. The presentation went well. After I spoke, the group showed slides of their gardens and compost piles, and then we toured the compost area and poked around in the worm compost boxes. A delightful lunch followed, during which time I asked them why they were interested in humanure, of all things.

*“We are the Sisters of Humility,”* they responded. *“The words ‘humble’ and ‘humus’ come from the same semantic root, which means ‘earth.’ We also think these words are related to the word ‘human.’ Therefore, as part of our vow of humility, we work with the earth. We make compost, as you’ve seen. And now we want to learn how to make compost from our toilet material. We’re thinking about buying a commercial composting toilet, but we want to learn more about the overall concepts first. That’s why we asked you to come here.”*

A light bulb went off in my head. Of course, composting is an act of humility. The people who care enough about the earth to recycle their personal by-products do so as an exercise in humility, and not because they’re going to get rich and famous for it. That makes them better people. Some people go to church on Sunday, others make compost. Still others do both. Others go to church on Sunday, then throw all their garbage out into the environment. The exercising of the human spirit can take many forms, and the simple act of cleaning up after oneself is one of them. Carelessly dumping waste out into the world is a self-centered act of arrogance.

Humanure composters can stand under the stars at night gazing at the heavens, and know that, when nature calls, their excretions will not foul the planet. Instead, those excretions are humbly collected, fed to microorganisms, and returned to the Earth as healing medicine for the soil. Although today’s religious leaders may scoff at anyone who does not kowtow to the men at the top of their hierarchy, humble composters can ignore the pressures of religious conformity, and instead hold a grain of pure spiritual truth in the palm of their hand.

*Source: The Humanure Handbook. Jenkins Publishing, PO Box 607, Grove City, PA 16127. To order, phone: 1-800-639-4099.*

<http://www.jenkinspublishing.com/>

**MENU:** [HOME](#) » [Reconstruction](#) » [Recovery](#) » [Renewal](#) » [Survival](#) » [Humanure Content](#)

---

---

## THE EGO VS. THE ECO

There are numerous theoretical reasons why we humans have strayed so far from a benign symbiotic relationship with the planet, and have instead taken on the visage, if not the behavior, of planetary pathogens. One of my favorites is “The Ego vs. The Eco” theory, also sometimes called the “Microcosm vs. the Macrocosm,” or, more simply, “Humans vs. Nature,” which I will attempt to explain in brief.

Human beings, like all living things on this planet, are inextricably intertwined with all of the elements of nature. We are threads in the tapestry of life. We constantly breathe the atmosphere that envelopes the planet; we drink the fluids that flow over the planet’s surface; we eat the organisms that grow from the planet’s skin. From the moment an egg and a sperm unite to spark our existence, each of us grows and develops from the elements provided by the Earth and sun. In essence, the soil, air, sun, and water combine within our mother’s womb to mold another living creature. Nine months later, another human being is born. That person is a separate entity, with an awareness of an individual self, an Ego. That person is also totally a part of, and completely dependent upon, the surrounding natural world, the Eco.

When the ego and the eco are balanced, the creature lives in harmony with the planet. In this theory, such a balance is considered to be the true meaning of *spirituality*, because the individual is a conscious part of, attuned to, and in harmony with a greater level of actual Being. When too much emphasis is placed on the self, the ego, an imbalance occurs and problems result, especially when that imbalance is collectively demonstrated by entire cultures. To suggest that these problems are only environmental, and therefore not of great concern, is incorrect. Environmental problems (damage to the eco) ultimately affect all living things, as all living things derive their existence, livelihood, and well-being from the planet. We cannot damage a thread in the web of life without the risk of fraying the entire tapestry.

When the ego gets blown out of proportion, we get thrown off balance in a variety of ways. Our educational institutions teach us to idolize the intellect, often at the expense of our moral, ethical, and spiritual development. Our economic institutions urge us to be consumers, and those who have gained the most material wealth are glorified. Our religious institutions often amount to little more than systems of human-worship, where divinity is only personified in human form, and only human creations (e.g., books and buildings) are considered sacred.

By emphasizing the intellect at the expense of intuition, creativity, and conscience, our educational systems yield spiritually imbalanced individuals. No discussion of a subject should be considered complete without an examination of its moral, philosophical, and ethical considerations, *as well* as a review of the intellectual and scientific data. When we ignore the ethics behind a particular issue, and



instead focus on intellectual achievements, it's great for our egos. We can pat ourselves on the back and tell ourselves how smart we are. It deflates our egos, on the other hand, to realize that we are actually insignificant creatures on a speck of dust in a corner of the universe, and that we are only one of the millions of life forms on this speck, all of whom must live together.

In recent decades, an entire generation of western scientists, a formidable force of intelligence, focused all its efforts on developing new ways to kill huge numbers of human beings all at once. This was the nuclear arms race of the 1950s through the present — a race that left us with environmental disasters yet to be cleaned up, a huge amount of natural materials gone to total waste (5.5 *trillion* dollars worth),<sup>1</sup> a military death toll consisting of hundreds of thousands of innocent non-combatants, and the threat of nuclear annihilation hanging over all of the peace-loving peoples of the world, even today. Surely this is an example of the collective ego being out of balance with the eco.

Religious movements that worship humans are ego-centered. It is ironic that a tiny, insignificant lifeform on a speck of dust at the edge of a galaxy lost somewhere in a corner of the universe would declare that the universe was created by one of their own kind. This would be a laughing matter if it were not taken so seriously by so many members of the human species, who insist on believing that the source of all life is another human, colloquially referred to as “God.”

We humans have evolved enough to know that the idea of a human-like creator-deity is simply myth. We can't begin to comprehend the full nature of our existence, so we *make up* a story that works until we figure out something better. Unfortunately, human-worship breeds an imbalanced collective ego. When we actually *believe* the myth, that humans are the pinnacle of life and the entire universe was created by one of our own kind, we go off the deep end. We stray too far from truth and wander, lost, with no point of reference to take us back to a balanced spiritual perspective we need for our own long-term survival on this planet. We become like a person knee deep in his own excrement, not knowing how to free himself from his unfortunate position, staring blankly at a road map with a look of utter incomprehension.

Today, new perspectives are emerging regarding the nature of human existence. The Earth itself is becoming recognized as a living entity, a level of Being immensely greater than the human level. The galaxy and universe are seen as even higher levels of Being, with multiverses (multiple universes) theorized as existing at a higher level yet. All of these levels of Being are thought to be imbued with the energy of life, as well as with a form of consciousness which we cannot even begin to comprehend. As we humans expand our knowledge of ourselves and recognize our true place in the vast scheme of things, our egos must defer to reality. We must admit our absolute dependence upon the ecosystem we call Earth, and try to balance our egotistical feelings of self-importance with our need to live in harmony with the greater world around us.

Getting back to compost, organic material, and soil nutrients, I must propose some additional philosophical speculation. Theoretically, the Asians evolved over the millennia with spiritual perspectives that maintained, to some extent, a view of the Earth, and of nature, as sacred. These

perspectives did not single out the human race as the pinnacle of creation, but instead recognized the totality of interconnected existence as divine, and advocated human harmony with that totality.

Contrast this to our western religious heritage which taught us that divinity lies only in human form, and that peoples who revere nature are “pagans,” “heathens,” “witches,” and worse. Admittedly, this is a broad and contentious topic, too broad for the scope of this book. Perhaps a few quotes here, however, will help to illustrate the point.

Hinduism, more common to India, but reaching into the Far East, seems to be sensitive to the sanctity of the natural world:

*“When Svetaketu, at his father’s bidding, had brought a ripe fruit from the banyan tree, his father said to him, Split the fruit in two, dear son.  
Here you are. I have split it in two.  
What do you find there?  
Innumerable tiny seeds.  
Then take one of the seeds and split it.  
I have split the seed.  
And what do you find there?  
Why, nothing, nothing at all.  
Ah, dear son, but this great tree cannot possibly come from nothing. Even if you cannot see with your eyes that subtle something in the seed which produces this mighty form, it is present nonetheless. That is the power, that is the spirit unseen, which pervades everywhere and is all things. Have faith! That is the spirit which lies at the root of all existence, and that also art thou, O Svetaketu.”*

(Chandogya Upanishad)<sup>2</sup>

Buddhism is a dominant influence in vast sections of Asia:

*“May all living things be happy and at their ease! May they be joyous and live in safety! All beings, whether weak or strong — omitting none — in high, middle, or low realms of existence, small or great, visible or invisible, near or far away, born or to be born — may all beings be happy and at their ease! Let none deceive another, or despise any being in any state; let none by anger or ill will wish harm to another! Even as a mother watches over and protects her only child, so with a boundless mind should one cherish all living beings, radiating friendliness over the entire world, above, below and all around without limit; so let him cultivate a boundless good will toward the entire world, uncramped, free from ill will or enmity.”*

The Metta Sutra<sup>3</sup>

Zen is a transliteration of the Sanskrit word “dyhana” meaning meditation, or more fully, “contemplation leading to a higher state of consciousness,” or “union with Reality.” It can be described as a blend of Indian mysticism and Chinese naturalism with a Japanese influence:

*“When the mind rests serene in the oneness of things . . . dualism vanishes by itself.”*

From the Hsis-hsis-ming by Seng-ts’an<sup>4</sup>

*“Zen does not go along with the Judaic-Christian belief in a personal savior or a God — outside the Universe — who has created the cosmos and the human race. To the Zen view, the Universe is one indissoluble substance, one total whole, of which humanity is a part.”*

Nancy Wilson Ross<sup>5</sup>

Confucius, like Buddha, was born in the sixth century B.C. and preached a philosophy of common Chinese virtue:

*“The path of duty lies in what is near and people seek for it in what is remote. The work of duty lies in what is easy and people seek for it in what is difficult.”*

Confucius<sup>6</sup>

The Tao (the way), written by Lao Tsu, a contemporary of Confucius, has provided one of the major underlying influences in Chinese thought and culture for 2,500 years:

*“Those who know do not talk. Those who talk do not know. Keep your mouth closed. Guard your senses. Temper your sharpness. Simplify your problems. Mask your brightness. Be at one with the dust of the earth. This is primal union. He who has achieved this state is unconcerned with friends and enemies, with good and harm, with honor and disgrace. This therefore is the highest state of humanity.”*

Lao Tsu<sup>7</sup>

Christianity, the primary religious influence of the western world, strongly supports the idea that humans are separate from and dominant over the natural world:

*“And God said, Let us make man in our image, after our likeness, and let them have dominion over the fish of the sea, and over the fowl of the air, and over the cattle, and over all the earth, and over every creeping thing that creepeth on the earth. And God blessed them, and God said unto them, Be fruitful and multiply, and replenish the earth, and subdue it: and have dominion over the fish of the sea, and over the fowl of the air, and over every living thing that moveth upon the earth.”*

Far Eastern religion has traditionally been imbued with the concepts of oneness, with the belief that the highest state of human evolution is one of harmony and peace with one's inner self and with the natural world. This would certainly seem to contribute to the development of sustainable agricultural methods. When one accepts the sacredness of life, one can easily understand why one should create compost and soil rather than waste and pollution.

For those of you readers who are devout Christians, this analysis of religious history is not intended to be "Christian-bashing," nor is it intended to offend anyone. Christianity must be singled out to some extent because the writer is writing from, and for, a culture that developed from an overwhelmingly Christian heritage. It is interesting to note that direct translations of Christian teachings from the Aramaic language (which Jesus spoke) as preserved in the Dead Sea Scrolls, indicate that Nature was, at that time, considered sacred by practicing Christians (refer to the translations of Edmund Bordeaux Szekeley). Those early teachings became buried under Biblical translations tailored to suit the European cultures of the late Middle Ages, which were hierarchic and male-dominated. Today, Christians can be among the most vocal defenders of the environment.

Historically, Christianity had periods that modern Christians would like to forget about, periods when the human egos involved grew to outrageous and terribly threatening proportions. During these times, male religious leaders claimed divinity and disbelievers were simply terrorized or destroyed. Those dark ages of Christianity adversely affected our understanding of the origins and nature of disease.

Unfortunately, *most* major religions today have drawn their focus toward human-worship, whether it be the Hindu worship of Krishna, the Buddhist worship of Buddha, the Islamic worship of Mohammed, the Christian worship of Jesus, or the bowing to the various human gurus and religious leaders which takes place all over the world. Patriarchal, hierarchic religious institutions still foster bloated egos the farther up the hierarchy one looks. Eventually, the human race will cast aside limiting, static, religious perspectives like a butterfly casts aside a cocoon. In the meantime, a metamorphosis must, and will, take place. That is what we should be focusing on, regardless of the religious institution to which we may currently belong.

*Source: The Humanure Handbook. Jenkins Publishing, PO Box 607, Grove City, PA 16127. To order, phone: 1-800-639-4099.*

<http://www.jenkinspublishing.com/>

---

**MENU: [HOME](#) » [Reconstruction](#) » [Recovery](#) » [Renewal](#) » [Survival](#) » [Humanure Content](#)**

---



## ASIAN RECYCLING

The Asian people have recycled humanure for thousands of years. The Chinese have used humanure agriculturally since the Shang Dynasty 3-4000 years ago. Why haven't we westerners? The Asian cultures, namely Chinese, Korean, Japanese and others, evolved to understand human excrement to be a natural resource rather than a waste material. Where we have human waste, they have night soil. We produce waste and pollution; they historically have produced soil nutrients and food. It's clear to me that Asians have been more advanced than the western world in this regard. And they should be, since they've been working on developing sustainable agriculture for four thousand years on the same land. For *four thousand years* those people have worked the same land with little or no chemical fertilizers and, in many cases, have produced greater crop yields than western farmers, who are quickly destroying the soils of their own countries through depletion and erosion.

A fact largely ignored by people in western agriculture is that *agricultural land must produce a greater output over time. The human population is constantly increasing; available agricultural land is not. Therefore, our farming practices should leave us with land more fertile with each passing year.* However, we are doing just the opposite.

Back in 1938, the US Department of Agriculture came to the alarming conclusion that *a full 61% of the total area under crops in the US at that time had already been completely or partly destroyed, or had lost most of its fertility.*<sup>9</sup> Nothing to worry about? We have artificial fertilizers, tractors, and oil to keep it all going. True, US agriculture is now heavily dependent upon fossil fuel resources. However, in 1993, we were importing about half our oil from foreign sources, and it's estimated that the US will be out of domestic oil reserves by 2020.<sup>10</sup> A heavy dependence on foreign oil for our food production seems unwise *at best*, and probably just plain foolish, especially when we're producing soil nutrients every day in the form of organic refuse and throwing those nutrients "away" by burying them in landfills or incinerating them.

Why aren't we following the Asian example of agronutrient recycling? It's certainly not for a lack of information. Dr. F. H. King wrote an interesting book, published in 1910 titled Farmers of Forty Centuries.<sup>11</sup> Dr. King (D.Sc.) was a former chief of the Division of Soil Management of the US Department of Agriculture who traveled through Japan, Korea, and China in the early 1900s as an agricultural visitor. He was interested in finding out how people could farm the same fields for millennia without destroying their fertility. He states:

*"One of the most remarkable agricultural practices adopted by any civilized people is the centuries long*

*and well nigh universal conservation and utilization of all human waste [sic] in China, Korea and Japan, turning it to marvelous account in the maintenance of soil fertility and in the production of food. To understand this evolution it must be recognized that mineral fertilizers so extensively employed in modern Western agriculture have been a physical impossibility to all people alike until within very recent years. With this fact must be associated the very long unbroken life of these nations and the vast numbers their farmers have been compelled to feed.*

*When we reflect upon the depleted fertility of our own older farm lands, comparatively few of which have seen a century's service, and upon the enormous quantity of mineral fertilizers which are being applied annually to them in order to secure paying yields, it becomes evident that the time is here when profound consideration should be given to the practices the Mongolian race has maintained through many centuries, which permit it to be said of China that one-sixth of an acre of good land is ample for the maintenance of one person, and which are feeding an average of three people per acre of farm land in the three southernmost islands of Japan.*

*[Western humanity] is the most extravagant accelerator of waste the world has ever endured. His withering blight has fallen upon every living thing within his reach, himself not excepted; and his besom of destruction in the uncontrolled hands of a generation has swept into the sea soil fertility which only centuries of life could accumulate, and yet this fertility is the substratum of all that is living.” <sup>12</sup>*

According to King's research, the average daily excreta of the adult human weighs in at 40 ounces. Multiplied by 250 million, a rough estimate of the current US population, Americans each year produce 1,448,575,000 pounds of nitrogen, 456,250,000 pounds of potassium, and 193,900,000 pounds of phosphorous. Almost all is discarded into the environment as a waste material or a pollutant, or as Dr. King puts it, “*poured into the seas, lakes or rivers and into the underground waters.*”

According to King, “*The International Concession of the city of Shanghai, in 1908, sold to a Chinese contractor the privilege of entering residences and public places early in the morning of each day and removing the night soil, receiving therefor more than \$31,000 gold, for 78,000 tons of waste [sic]. All of this we not only throw away but expend much larger sums in doing so.*”

In case you didn't catch that, the contractor paid \$31,000 gold for the humanure, referred to as “night soil” and incorrectly as “waste” by Dr. King. People don't pay to buy waste, they pay money for things of value.

Furthermore, using Dr. King's figures, the US population today produces approximately 228,125,000,000 pounds of fecal material annually. That's 228 billion pounds. You could call that the *really* Gross National Product.

Admittedly, the spreading of raw human excrement on fields, as is done in Asia, will never become culturally acceptable in the United States, and rightly so. The agricultural use of raw night soil produces an assault to the sense of smell, and provides a route of transmission for various human disease

organisms. Americans who have traveled abroad and witnessed the use of raw human excrement in agricultural applications have largely been repulsed by the experience. That repulsion has instilled in many Americans an intransigent bias against, and even a fear of the use of humanure for soil enrichment. However, few Americans have witnessed the *composting* of humanure as a preliminary step in its recycling. Proper thermophilic composting converts humanure into a pleasant smelling material devoid of human pathogens.

Although the agricultural use of raw human excrement will never become a common practice in the US, the use of composted human refuse, including humanure, food refuse, and other organic municipal refuse such as leaves, can and should become a widespread and culturally encouraged practice in the United States. The act of composting humanure instead of using it raw will set Americans apart from Asians in regard to the recycling of human excrements, *for we too will have to constructively deal with all of our organic by-products eventually*. We can put it off, but not forever. As it stands now, at least many of the Asians are recycling much of their organic discards. We're not.

*Source: The Humanure Handbook. Jenkins Publishing, PO Box 607, Grove City, PA 16127. To order, phone: 1-800-639-4099.*

<http://www.jenkinspublishing.com/>

---

**MENU: [HOME](#) » [Reconstruction](#) » [Recovery](#) » [Renewal](#) » [Survival](#) » [Humanure Content](#)**

---



## THE ADVANCES OF SCIENCE

How is it that Asian peoples developed an understanding of human nutrient recycling and we didn't? After all, we're the advanced, developed, scientific nation, aren't we? Dr. King makes an interesting observation concerning western scientists. He states: *"It was not until 1888, and then after a prolonged war of more than thirty years, generated by the best scientists of all Europe, that it was finally conceded as demonstrated that leguminous plants acting as hosts for lower organisms living on their roots are largely responsible for the maintenance of soil nitrogen, drawing it directly from the air to which it is returned through the processes of decay. But centuries of practice had taught the Far East farmers that the culture and use of these crops are essential to enduring fertility, and so in each of the three countries the growing of legumes in rotation with other crops very extensively, for the express purpose of fertilizing the soil, is one of their old fixed practices."* <sup>13</sup>

In western culture, we wait for the experts to figure things out before we claim any real knowledge. This appears to have put us several centuries behind the Asians. It certainly seems odd that people who gain their knowledge in real life through practice and experience are largely ignored or trivialized by the academic world and associated government agencies. Such agencies only credit learning that has taken place within an institutional framework. As such, it's no wonder that Western humanity's crawl toward a sustainable existence on the planet Earth is so pitifully slow.

*"Strange as it may seem,"* says King, *"there are not today and apparently never have been, even in the largest and oldest cities of Japan, China or Korea, anything corresponding to the hydraulic systems of sewage disposal used now by Western nations. When I asked my interpreter if it was not the custom of the city during the winter months to discharge its night soil into the sea, as a quicker and cheaper mode of disposal [than recycling], his reply came quick and sharp, 'No, that would be waste. We throw nothing away. It is worth too much money.'*" <sup>14</sup> *"The Chinaman,"* says King, *"wastes nothing while the sacred duty of agriculture is uppermost in his mind."* <sup>15</sup>

Perhaps, a few centuries from now, we also will understand.

*Source: The Humanure Handbook. Jenkins Publishing, PO Box 607, Grove City, PA 16127. To order, phone: 1-800-639-4099.*

<http://www.jenkinspublishing.com/>

**MENU:** [HOME](#) » [Reconstruction](#) » [Recovery](#) » [Renewal](#) » [Survival](#) » [Humanure Content](#)

---

---

**MENU:** [HOME](#) » [Reconstruction](#) » [Recovery](#) » [Renewal](#) » [Survival](#) » [Humanure Content](#)

## WHEN THE CRAP HIT THE FAN

While the Asians were practicing sustainable agriculture and recycling their organic resources and doing so over millennia, what were the people of the west doing? What were the Europeans and those of European descent doing? Why weren't our ancestors returning their manures to the soil, too? After all, it does make sense. The Asians who recycled their manures not only recovered a resource and reduced pollution, but by returning their excrement to the soil, they succeeded in reducing threats to their health. There was no putrid sewage collecting and breeding disease germs. Instead, the humanure was, for the most part, undergoing a natural, non-chemical purification process in the soil which required no technology.

Granted, a lot of "night soil" in the Far East today is not composted and is the source of health problems. However, even the returning of humanure raw to the land succeeds in destroying many human pathogens in the manure, and it also returns nutrients to the soil. Let's take a look at what was happening in Europe regarding public hygiene from the 1300s on. Great pestilences swept Europe throughout recorded history. The Black Death killed more than half the population of England in the fourteenth century. In 1552, 67,000 patients died of the Plague in Paris alone. Fleas from infected rats were the carriers of this disease. Did the rats dine on human waste? Other pestilences included the sweating sickness (attributed to uncleanness), cholera (spread by food and water contaminated by the excrement of infected persons), "jail fever" (caused by a lack of sanitation in prisons), typhoid fever (spread by water contaminated with infected feces), and numerous others.

Andrew D. White, cofounder of Cornell University, writes, "*Nearly twenty centuries since the rise of Christianity, and down to a period within living memory, at the appearance of any pestilence the Church authorities, instead of devising sanitary measures, have very generally preached the necessity of immediate atonement for offenses against the Almighty. In the principal towns of Europe, as well as in the country at large, down to a recent period, the most ordinary sanitary precautions were neglected, and pestilences continued to be attributed to the wrath of God or the malice of Satan.*" <sup>16</sup>

It's now known that the main cause of such immense sacrifice of life was a lack of proper hygienic practices. It's argued that certain theological reasoning at that time resisted the evolution of proper hygiene. According to White, "*For century after century the idea prevailed that filthiness was akin to holiness.*" Living in filth was regarded by holy men as evidence of sanctity, according to White, who lists numerous saints who never bathed parts or all of their bodies, such as St. Abraham, who washed neither his hands nor his feet for fifty years, or St. Sylvia, who never washed any part of her body except her fingers.<sup>17</sup>

Interestingly, after the Black Death left its grim wake across Europe, “*an immensely increased proportion of the landed and personal property of every European country was in the hands of the church.*”<sup>18</sup> Apparently, the church was reaping some benefit from the deaths of huge numbers of people. Perhaps the church had a vested interest in maintaining public ignorance about the sources of disease. This insinuation is almost too diabolical for serious consideration. Or is it?

Somehow, the idea developed around the 1400s that Jews and witches were causing the pestilences. Jews were suspected because they didn’t succumb to the pestilences as readily as the Christian population did, presumably because they employed a unique sanitation system more conducive to cleanliness, including the eating of kosher foods. Not understanding this, the Christian population arrived at the conclusion that the Jews’ immunity resulted from protection by Satan. As a result, attempts were made in all parts of Europe to stop the plagues by torturing and murdering the Jews. Twelve thousand Jews were reportedly burned to death in Bavaria alone during the time of the plague, and additionally thousands more were likewise killed throughout Europe.<sup>19</sup>

In 1484, the “infallible” Pope Innocent VIII issued a proclamation supporting the church’s opinion that witches were causes of disease, storms, and a variety of ills affecting humanity. The feeling of the church was summed up in one sentence: “*Thou shalt not suffer a witch to live.*” From the middle of the sixteenth to the middle of the seventeenth centuries, women and men were sent to torture and death by the thousands, by both Protestant and Catholic authorities. It’s estimated that the number of victims sacrificed during that century in Germany alone was over a hundred thousand.

The following case in Milan, Italy, summarizes the ideas of sanitation in Europe during the seventeenth century:

The city was under the control of Spain, and it had received notice from the Spanish government that witches were suspected to be en route to Milan to “anoint the walls” (smear the walls with disease-causing ointments). The church rang the alarm from the pulpit, putting the population on the alert. One morning, in 1630, an old woman looking out of her window saw a man who was walking along the street wipe his fingers on a wall. He was promptly reported to the authorities. He claimed he was simply wiping ink from his fingers which had rubbed off the ink-horn he carried with him. Not satisfied with this explanation, the authorities threw the man into prison and tortured him until he “confessed.” The torture continued until the man gave the names of his “accomplices,” who were subsequently rounded up and tortured. They in turn named *their* “accomplices” and the process continued until members of the foremost families were included in the charges. Finally, a large number of innocent people were sentenced to their deaths, all reportedly a matter of record.<sup>20</sup>

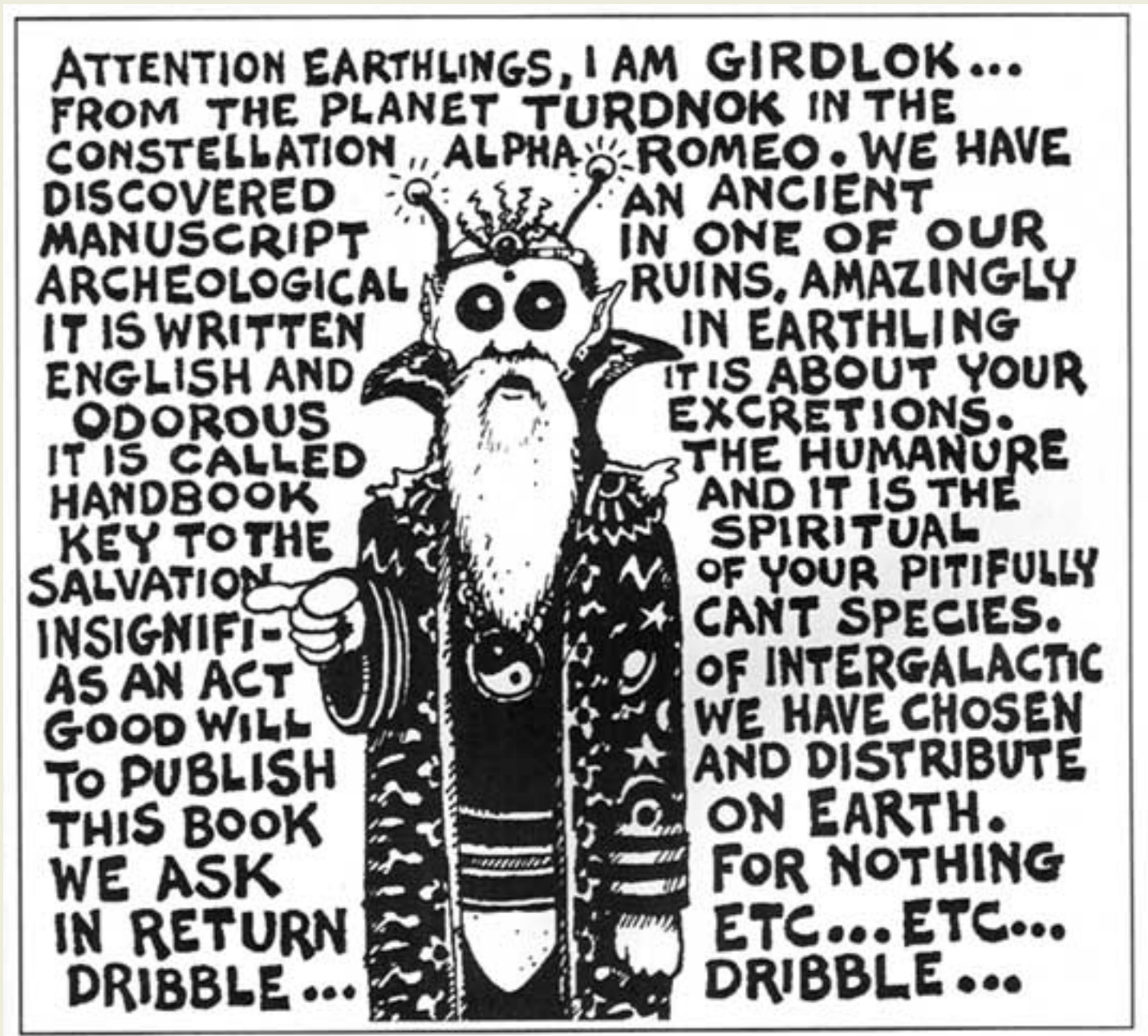
One loathsome disease of the 1500s through the 1700s was the “jail fever.” The prisons of that period were filthy. People were confined in dungeons connected to sewers with little ventilation or drainage. Prisoners incubated the disease and spread it to the public, especially to the police, lawyers and judges. In 1750, for example, the disease killed two judges, the lord mayor, various aldermen, and many others in London, not to mention prisoners.<sup>21</sup>

The pestilences at that time in the Protestant colonies in America were also attributed to divine wrath or satanic malice, but when the pestilences afflicted the Native Americans, they were considered acts of divine mercy. *“The pestilence among the Indians, before the arrival of the Plymouth Colony, was attributed in a notable work of that period to the Divine purpose of clearing New England for the heralds of the gospel.”* [22](#)

Perhaps the reason the Asian countries have such large populations in comparison to Western countries is because they escaped some of the pestilences common to Europe, especially pestilences spread by the failure to responsibly recycle human excrement. They presumably plowed their manure back into the land because their spiritual perspectives supported such behavior. Westerners were too busy burning witches and Jews with the church’s wholehearted assistance to bother thinking about recycling humanure.

Our ancestors did, eventually, come to understand that poor hygiene was a causal factor in epidemic diseases. Nevertheless, it was not until the late 1800s in England that improper sanitation and sewage were suspected as causes of epidemics. At that time, large numbers of people were still dying from pestilences, especially cholera, which killed at least 130,000 people in England in 1848-9 alone. In 1849, an English medical practitioner published the theory that cholera was spread by water contaminated with sewage. Ironically, even where sewage was being piped away from the population, the sewers were still leaking into drinking water supplies.

The English government couldn’t be bothered with the fact that hundreds of thousands of mostly poor citizens were perishing like flies year after year. So it rejected a Public Health Bill in 1847. A Public Health Bill finally became an Act in 1848 in the face of the latest outbreak, but wasn’t terribly effective. However, it did bring poor sanitation to the attention of the public, as the following statement from the General Board of Health (1849) implies: *“Householders of all classes should be warned that their first means of safety lies in the removal of dung heaps and solid and liquid filth of every description from beneath or about their houses and premises.”* This may make one wonder if a compost pile would have been considered a “dung heap” in those days, and therefore banned.



Sanitation in England was so bad in the mid to late eighteenth centuries that, *“In 1858, when the Queen and Prince Albert had attempted a short pleasure cruise on the Thames, its malodorous waters drove them back to land within a few minutes. That summer a prolonged wave of heat and drought exposed its banks, rotten with the sewage of an overgrown, undrained city. Because of the stench, Parliament had to rise early.”* Another story describes Queen Victoria gazing out over the river and asking aloud what the pieces of paper were that so abundantly floated by. Her companion, not wanting to admit that the Queen was looking at pieces of used toilet paper, replied, *“Those, Ma’am, are notices that bathing is forbidden.”* <sup>23</sup>

The wealthy folks, including the Tories or “conservatives” of the English government still thought that spending on social services was a waste of money and an unacceptable infringement by the government on the private sector (sound familiar?). A leading newspaper, “The Times,” maintained that the risk of

cholera was preferable to being bullied by the government into providing sewage services. However, a major Act was finally passed in 1866, the Public Health Act, with only grudging support from the Tories. Once again, cholera was raging through the population, and it's probably for that reason that any act was passed at all. Finally, by the end of the 1860s, a framework of public health policy was established in England. Thankfully, the cholera epidemic of 1866 was the last and the least disastrous.<sup>24</sup>

The powers of the church eventually diminished enough for physicians to have their much delayed say about the origins of disease. Today, the church is no longer an obstacle to the progress of society, and in many cases acts as a force for peace, justice, and environmental awareness in the western world.

Our modern sanitation systems have finally yielded a life safe for most of us, although not without shortcomings. The eventual solution developed by the west was to collect humanure in water and discard it, perhaps chemically treated, incinerated, or dehydrated — into the seas, into the atmosphere, onto the surface of the land, and into landfills.

*Source: The Humanure Handbook. Jenkins Publishing, PO Box 607, Grove City, PA 16127. To order, phone: 1-800-639-4099.*

<http://www.jenkinspublishing.com/>

---

**MENU: [HOME](#) » [Reconstruction](#) » [Recovery](#) » [Renewal](#) » [Survival](#) » [Humanure Content](#)**

---

---

## ASIAN UPDATE

It would be naive to suggest that the Asian societies are perfect by any stretch of the imagination. Asian history is rife with the problems that have plagued humanity since the first person crawled on this planet. Those problems include such things as oppressive rule by the rich, war, famine, natural catastrophes, oppressive rule by heathens, more war, and now overpopulation.

Today, Asians are abandoning the harmonious agricultural techniques that Dr. King observed nearly a century ago. In Kyoto, Japan, for example, “*night soil is collected hygienically to the satisfaction of users of the system, only to be diluted at a central collection point for discharge to the sewer system and treatment at a conventional sewage treatment plant.*” [25](#)

A Humanure Handbook reader wrote an interesting account of Japanese toilets in a letter to the author, which is paraphrased here:

*“I just got through reading your Humanure Handbook. This is the book of the year! Your book really opened my eyes about humanure. I never even thought about using sawdust/leaves/hay as a solution to odors and about thermophilic composting. How brilliant! My only real experience, outside of continuously composting yard refuse/kitchen scraps either in an open pile or directly burying them and then using them on my vegetable garden for over twenty years, comes from living in Japan from 1973-1983. I’ll take this opportunity to tell you all I directly experienced about their humanure recycling. As my experience is dated, things may have changed (probably for the worse as toilets and life were becoming ‘westernized’ even toward the end of my stay in Japan).*”

*My experience comes from living in small, rural towns as well as in metropolitan areas (provincial capitals) from 1973-1983. Homes/businesses had an ‘indoor outhouse.’ The Vault: Nothing but urine/feces were deposited into the large metal vault under the toilet (squat style, slightly recessed in the floor and made of porcelain). No cover material or carbonaceous stuff was used. It stunk !! Not just the bathroom, but the whole house! There were many flies, even though the windows were screened. Maggots were the main problem. They crawled up the sides of the vault onto the toilet and floor and sometimes even made it outside the bathroom into the hall. People constantly poured some kind of toxic chemical into the vaults to control the smell and maggots. (It didn’t help — in fact, the maggots really poured out of the vault to escape the chemicals.) Occasionally a slipper*



*(one put on special ‘bathroom slippers’ as opposed to ‘house slippers’ when entering the bathroom) fell into the disgusting liquid/maggot filled vault. You couldn’t even begin to think about getting it out! You couldn’t let little children use the toilet without an adult suspending them over it. They might fall in! Disposal: When the vault was full (about every three months), you called a private vacuum truck which used a large hose placed in an outside opening to suck out the liquid mass. You paid them for their services. I’m not sure exactly what happened to the humanure next but, in the agricultural areas near the fields were large (10 feet in diameter) round, concrete, raised containers, similar in looks to an above ground swimming pool. In the containers, I was told, was the humanure from the ‘vacuum trucks.’ It was a greenish-brown liquid with algae growing on the surface. I was told this was spread onto agricultural fields.” E.A. in IL*

In 1952, about 70% of Chinese humanure was recycled. This had increased to 90% by 1956, and constituted a third of all fertilizer used in the country.<sup>26</sup> Lately, however, humanure recycling in China seems to be going downhill. The use of synthetic fertilizers has risen over 600% between the mid 1960s to the mid 1980s, and now China’s average annual fertilizer usage per hectare is estimated to be double that of the world’s average. Between 1949 and 1983, agricultural nitrogen and phosphorous inputs increased by a factor of ten, while agricultural yields only tripled.<sup>27</sup>

Water pollution in China began to increase in the 1950s due to the discarding of sewage into water. Now, about 70% of China’s wastewater is said to be dumped into China’s main rivers. By 1992, 45 billion tonnes of wastewater were flowing into China’s rivers and lakes annually, 70% untreated. In urban areas, 80% of the surface water is polluted with nitrogen and ammonia, and most lakes around cities have become dumping grounds for large quantities of sewage. It is estimated that 450,000 tonnes of humanure are dumped into the Huangpu River alone in a year. Half a million cases of hepatitis A, spread by polluted water, occurred in Shanghai in 1988. Soilborne diseases, practically non-existent in China twenty years ago, are now also causing problems. *“Increasingly, Chinese urban authorities are turning to incineration or landfill as the ways of disposing of their solid wastes rather than recycling and composting, which means that China, like the west, is putting the problem onto the shoulders of future generations.”* <sup>28</sup>

For a sense of historical perspective, I’ll leave you with a quote from Dr. Arthur Stanley, health officer of the city of Shanghai, China, in his annual report for 1899, when the population of China amounted to about 500 million people, roughly double that of the US today. At that time, no artificial fertilizers were employed for agricultural purposes — only organic, natural materials such as agricultural residues and humanure were being used:

*“Regarding the bearing on the sanitation of Shanghai of the relationship between Eastern and Western hygiene, it may be said, that if prolonged national life is indicative of sound sanitation, the Chinese are a race worthy of study by all who concern themselves with public health. It is evident that in China the birth rate must very considerably exceed the death rate, and have done so in an average way during the three or four thousand years that the Chinese nation has existed. Chinese hygiene, when compared to medieval English, appears to advantage.”* <sup>29</sup>

Sounds like an understatement to me.

*Source: The Humanure Handbook. Jenkins Publishing, PO Box 607, Grove City, PA 16127. To order, phone: 1-800-639-4099.*

<http://www.jenkinspublishing.com/>

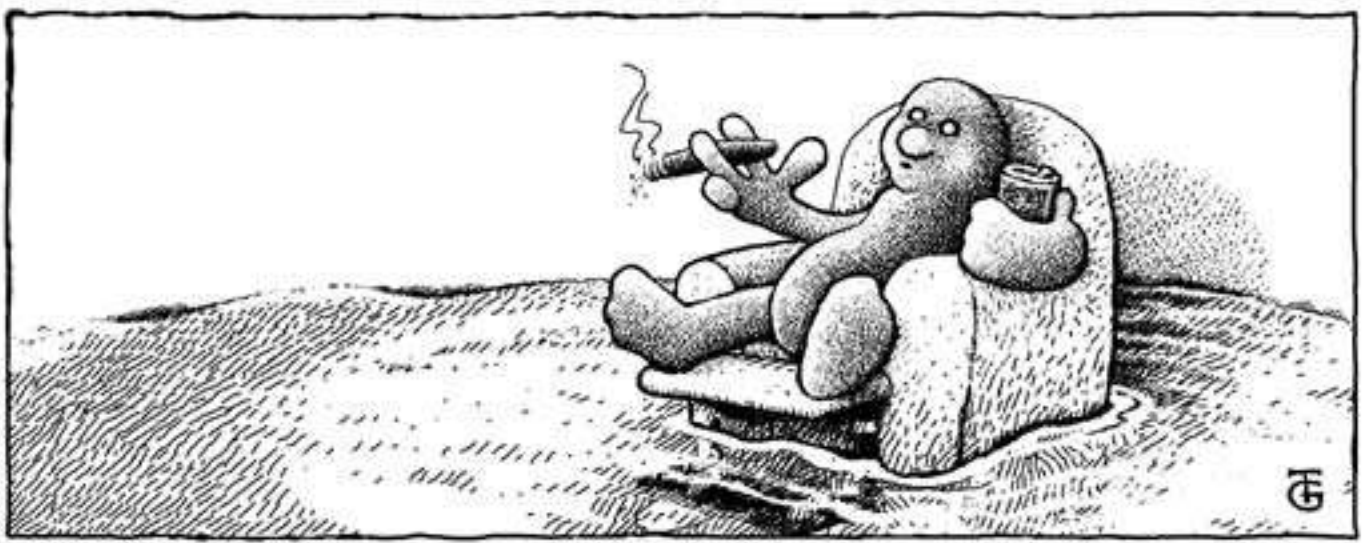
---

**MENU: [HOME](#) » [Reconstruction](#) » [Recovery](#) » [Renewal](#) » [Survival](#) » [Humanure Content](#)**

---

---

## A DAY IN THE LIFE OF A TURD



*“If I urinated into a pitcher of drinking water and then proceeded to quench my thirst from the pitcher, I would undoubtedly be considered crazy. If I invented an expensive technology to put my urine and feces into my drinking water, and then invented another expensive (and undependable) technology to make the same water fit to drink, I might be thought even crazier. It is not inconceivable that some psychiatrist would ask me knowingly why I wanted to mess up my drinking water in the first place.”*

Wendell Berry

When I was a kid, I listened to veterans talking about their stints in the Korean War. Usually after a beer or two, they’d turn their conversation to the “outhouses” used by the Koreans. They were amazed, even mystified about the fact that the Koreans tried to lure passersby to use their outhouses by making the toilets especially attractive. The idea of someone wanting someone else’s crap always brought out a loud guffaw from the vets. Only a groveling, impoverished, backward gink would stoop so low as to beg for a turd. Haw, Haw.

Perhaps this attitude sums up the attitudes of Americans. Humanure is a waste product, plain and simple. We have to get rid of it and that’s all there is to it. Only fools would think otherwise. One of the effects of this sort of attitude is that Americans don’t know and probably don’t care where their humanure goes after it emerges from their backsides, as long as they don’t have to deal with it.

## MEXICAN BIOLOGICAL DIGESTER

Well, where it goes depends on the type of “waste disposal system” used. Let’s start with the simplest: the Mexican biological digester, also known as the stray dog. In India, this may be known as the stray pig (see Figure 5.1). I spent a few months in southern Mexico in the late 1970s in Quintana Roo on the Yucatan peninsula. There, toilets were not available; people simply used the sand dunes along the coast. No problem, though. One of the small, unkempt, and ubiquitous Mexican dogs would wait nearby with watering mouth until you’ve done your thing. Burying your excrement in that situation would have been an act of disrespect to the dog. No one wants sand in their food. A good, healthy, steaming turd at the crack of dawn on the Caribbean coast never lasted more than 60 seconds before it became a hot meal for a human’s best friend. Yum.

## THE OLD-FASHIONED OUTHOUSE

Next up the ladder of sophistication is the old-fashioned outhouse, also known as the pit latrine (see Figures 5.2-5.5). Simply stated, one digs a hole and defecates in it, and then does so again and again until the hole fills up, after which it’s covered with dirt. It’s nice to have a small building (privy) over the hole to provide some privacy and to keep off the elements. However, the concept is simple: dig a hole and bury your excrement. Interestingly, this level of sophistication has not yet been surpassed in America. We still bury our excrement, in the form of sewage sludge, in landfill holes.

The first farmhouse I lived in during the mid-seventies had an outhouse behind it and no plumbing whatsoever. What I remember most about the outhouse is the smell, which could be described as quite undesirable, to say the least. The flies and wasps weren’t very inviting either, and of course the cold weather made the process of “going to the bathroom” uncomfortable. When the hole filled up, I simply dug another hole twenty feet away from the first and dragged the outhouse from one hole to the other. The dirt from the second hole was used to cover the first. The excrement was left in the ground, probably to contaminate groundwater. Of course, I didn’t know I might be contaminating anything because I had just graduated from college and was quite ignorant about practical matters. Therefore, I plead not guilty to environmental pollution on the grounds of a college education.

Outhouses create very real health, environmental, and aesthetic problems. The hole in the ground is accessible to flies and mosquitoes which can transmit disease over a wide area. The pits leak pollutants into the ground even in dry soil. And the smell — *hold your nose*.

## SEPTIC SYSTEMS

Another step up the ladder one finds the septic tank, a common method of human waste disposal in rural and suburban areas of the United States. In this system the turd is deposited into a container of water, usually pure drinking water, and the whole works are flushed away (see Figures 5.6 and 5.7).

After the floating turd travels from the house inside a sewage pipe, it plops into a fairly large

underground storage tank, or septic tank, usually made of concrete and sometimes of fiberglass. In Pennsylvania (US), a 900 gallon tank is the minimum size allowed for a home with three or fewer bedrooms.<sup>1</sup> The heavier solids settle to the bottom of the tank and the liquids drain off into a leach field, which consists of an array of drain pipes situated below the ground surface allowing the liquid to seep out into the soil. The wastewater should be undergoing anaerobic decomposition while in the tank. When septic tanks fill up, they are pumped out and the waste material is supposed to be trucked to a sewage treatment plant (sometimes they're illegally dumped).

## SAND MOUNDS

In the event of poorly drained soil, one with a high clay content or else low-lying, a standard leach field will not work very well, especially when the ground is already saturated with rain water or snow melt. One can't drain wastewater into soil that is saturated with water. That's when the *sand mound* sewage disposal system is employed. When the septic tank isn't draining properly, a pump will kick in and pump the effluent into a pile of sand and gravel above ground (although sometimes a pump isn't necessary and gravity does the job). A perforated pipeline in the pile of sand allows the effluent to drain down through the mound. Sand mounds are usually covered with soil and grass. In Pennsylvania, sand mounds must be at least one hundred feet downslope from a well or spring, fifty feet from a stream, and five feet from a property line.<sup>2</sup> According to local excavating contractors, sand mounds cost \$5,000 to \$12,000 to construct. They must be built to exact government specifications, and aren't usable until they pass an official inspection (see Figure 5.8).

## GROUND WATER POLLUTION FROM SEPTIC SYSTEMS

We civilized humans started out by defecating into a hole in the ground (outhouse), then discovered we could float our turds out to the hole using water and never have to leave the house. However, one of the unfortunate problems with septic systems is, like outhouses, they pollute our groundwater.

There are currently 22 million septic system sites in the United States, serving one fourth to one third of the US population. They are leaching contaminants such as bacteria, viruses, nitrates, phosphates, chlorides, and organic compounds such as trichloroethylene into the environment. An EPA study of chemicals in septic tanks found toluene, methylene chloride, benzene, chloroform, and other volatile synthetic organic compounds related to home chemical use, many of them cancer-causing.<sup>3</sup> Between 820 and 1,460 *billion* gallons of this contaminated water are discharged per year to our shallowest aquifers.<sup>4</sup> In the US, septic tanks are reported as a source of ground water contamination more than any other source. Forty-six states cite septic systems as sources of groundwater pollution; nine of these reported them to be the primary source of groundwater contamination in their state (see Figures 5.9 and 5.10).<sup>5</sup>

The word "septic" comes from the Greek "septikos" which means "to make putrid." Today it still means "causing putrefaction," putrefaction being "the decomposition of organic matter resulting in the formation of foul-smelling products" (see Webster). Septic systems are not designed to destroy human pathogens that may be in the human waste that enters the septic tank. Instead, septic systems are

designed to collect human wastewater, settle out the solids, and anaerobically digest them to some extent, leaching the effluent into the ground. Therefore, septic systems can be highly pathogenic, allowing the transmission of disease-causing bacteria, viruses, protozoa, and intestinal parasites through the system.

One of the main concerns associated with septic systems is the problem of human population density. Too many septic systems in any given area will overload the soil's natural purification systems and allow large amounts of wastewater to contaminate the underlying watertable. A density of more than forty household septic systems per square mile will cause an area to become a likely target for subsurface contamination, according to the EPA.<sup>6</sup>

Toxic synthetic organic chemicals are commonly released into the environment from septic systems because people dump toxic chemicals down their drains. The chemicals are found in pesticides, paint and coating products, toilet cleaners, drain cleaners, disinfectants, laundry solvents, antifreeze, rust proofers, septic tank and cesspool cleaners, and many other cleaning solutions. In fact, over 400,000 gallons of septic tank cleaner liquids containing synthetic organic chemicals were used in one year by the residents of Long Island alone. Furthermore, some synthetic organic chemicals can corrode pipes, thereby causing heavy metals to enter septic systems.<sup>7</sup>

In many cases, people who have septic tanks are forced to connect to sewage lines when the lines are made available to them. A US Supreme Court case in 1992 reviewed a situation whereby town members in New Hampshire had been forced to connect to a sewage line that simply discharged untreated, raw sewage into the Connecticut River, and had done so for 57 years. Despite the crude method of sewage disposal, state law required properties within 100 feet of the town sewer system to connect to it from the time it was built in 1932. This barbaric sewage disposal system apparently continued to operate until 1989, when state and federal sewage treatment laws forced a stop to the dumping of raw sewage into the river.<sup>8</sup>

## WASTEWATER TREATMENT PLANTS

*“Over 90% of all sewage in third world countries is discharged completely untreated; in Latin America the figure is 98%.” Ecological Sanitation, p.2*

There's still another step up the ladder of wastewater treatment sophistication: the wastewater treatment plant, or sewage plant. The wastewater treatment plant is like a huge, very sophisticated septic tank because it collects the waterborne excrement of large numbers of humans. Inevitably, when one defecates or urinates into water, one pollutes the water. In order to avoid environmental pollution, that “wastewater” must somehow be rendered fit to return to the environment. The wastewater entering the treatment plant is 99% liquid because all sink water, bath water and everything else that goes down one's drain ends up at the plant too, which is why it's called a *water* treatment plant. In some cases, storm water runoff also enters wastewater treatment plants via *combined sewers*. Industries, hospitals, gas stations, and any place with a drain add to the contaminant blend in the wastewater stream.

Many modern wastewater plants use a process of activated sludge treatment whereby oxygen is vigorously bubbled through the wastewater in order to activate microbial digestion of the solids. This aeration stage is combined with a settling stage that allows the solids to be removed (see Figures 5.11 and 5.12). The removed solids (sludge) are either used to reinoculate the incoming wastewater, or they're dewatered to the consistency of a dry mud and buried in landfills. Sometimes the sludge is applied to agricultural land, and now, sometimes, it's composted. The microbes that digest the sludge consist of bacteria, fungi, protozoa, rotifers, and nematodes.<sup>9</sup> US sewage treatment plants generated about 7.6 million dry tons of sludge in 1989.<sup>10</sup> New York City alone produces 143,810 dry tons of sludge every year.<sup>11</sup> In 1993, the amount of sewage sludge produced annually in the US was 110-150 million wet metric tons. The water left behind is treated (usually with chlorine) and discharged into a stream, river, or other body of water. Sewage treatment water releases to surface water in the United States in 1985 amounted to nearly *31 billion gallons per day*.<sup>12</sup> Incidentally, the amount of toilet paper used (1991) to send all this waste to the sewers was 2.3 million tons.<sup>13</sup>

## WASTE STABILIZATION PONDS

Perhaps one of the most ancient wastewater treatment methods known to humans are waste stabilization ponds, also known as oxidation ponds or lagoons (see Figure 5.13). They're often found in small rural areas where land is available and cheap. Such ponds tend to be only a meter to a meter and a half deep, but vary in size and depth, and may be three or more meters deep.<sup>14</sup> They utilize natural processes to "treat" waste materials, relying on algae, bacteria, and zooplankton to reduce the organic content of the wastewater. A "healthy" lagoon will appear green in color because of the dense algae population. These lagoons require about one acre for every 200 people served. Mechanically aerated lagoons only need 1/3 to 1/10 the land that unaerated stabilization ponds require. It's a good idea to have several smaller lagoons in series rather than one big one; normally, a minimum of three "cells" are used. Sludge collects in the bottom of the lagoons, and may have to be removed every five or ten years and disposed of in an approved manner.<sup>15</sup>

## CHLORINE

Wastewater leaving wastewater treatment plants is often treated with chlorine before being released into the environment. Therefore, besides contaminating water resources with feces, the act of defecating into water often ultimately contributes to the contamination of water resources with *chlorine*.

Used since the early 1900s, chlorine is one of the most widely produced industrial chemicals. About 10 million metric tons are manufactured in the US each year — \$72 billion worth.<sup>16</sup> Annually, approximately 5%, or 1.2 billion pounds of the chlorine manufactured is used for wastewater treatment and drinking water "purification." The lethal liquid or green gas is mixed with the wastewater from sewage treatment plants in order to kill disease-causing microorganisms before the water is discharged into streams, lakes, rivers, and seas. It is also added to household drinking water via household and municipal water treatment systems. Chlorine kills microorganisms by damaging their cell membranes, which leads to a leakage of their proteins, RNA, and DNA.<sup>17</sup>

Chlorine (Cl<sub>2</sub>) doesn't exist in nature. It's a potent poison which reacts with water to produce a strongly oxidizing solution that can damage the moist tissue lining of the human respiratory tract. Ten to twenty parts per million (ppm) of chlorine gas in air rapidly irritates the respiratory tract; even brief exposure at levels of 1,000 ppm (one part in a thousand) can be fatal.<sup>18</sup> Chlorine also kills fish, and reports of fish kills caused chlorine to come under the scrutiny of scientists in the 1970s.

The fact that harmful compounds are formed as *by-products* of chlorine use also raises concern. In 1976, the US Environmental Protection Agency (EPA) reported that chlorine use not only poisoned fish, but could also cause the formation of cancer-causing compounds such as chloroform. Some known effects of chlorine-based pollutants on animal life include memory problems, stunted growth and cancer in humans; reproductive problems in minks and otters; reproductive problems, hatching problems, and death in lake trout; and embryo abnormalities and death in snapping turtles.<sup>19</sup>

In a national study of 6,400 municipal wastewater treatment plants, the EPA estimated that two thirds of them used too much chlorine, exerting lethal effects at all levels of the aquatic food chain. Chlorine damages the gills of fish, inhibiting their ability to absorb oxygen. It also can cause behavioral changes in fish, thereby affecting migration and reproduction. Chlorine in streams can create chemical "dams" which prevent the free movement of some migratory fish. Fortunately, since 1984, there has been a 98% reduction in the use of chlorine by sewage treatment plants, although chlorine use continues to be a widespread problem because a lot of wastewater plants are still discharging it into small receiving waters.<sup>20</sup>

Another controversy associated with chlorine use involves "dioxin," which is a common term for a large number of chlorinated chemicals that are classified as possible human carcinogens by the EPA. It's known that dioxins cause cancer in laboratory animals, but their effects on humans are still being debated. Dioxins, by-products of the chemical manufacturing industry, are concentrated up through the food chain where they're deposited in human fat tissues. A key ingredient in the formation of dioxin is chlorine, and indications are that an increase in the use of chlorine results in a corresponding increase in the dioxin content of the environment, even in areas where the only dioxin source is the atmosphere.<sup>21</sup>

In the upper atmosphere, chlorine molecules from air pollution gobble up ozone; in the lower atmosphere, they bond with carbon to form organochlorines. Some of the 11,000 commercially used organochlorines include hazardous compounds such as DDT, PCBs, chloroform, and carbon tetrachloride. Organochlorines rarely occur in nature, and living things have little defense against them. They've been linked not only to cancer, but also to neurological damage, immune suppression, and reproductive and developmental effects. When chlorine products are washed down the drain to a septic tank, they're producing organochlorines. Although compost microorganisms can degrade and make harmless many toxic chemicals, highly chlorinated compounds are disturbingly resistant to such biodegradation.<sup>22</sup>

*"Any use of chlorine results in compounds that cause a wide range of ailments,"* says Joe Thornton, a Greenpeace researcher, who adds, *"Chlorine is simply not compatible with life. Once you create it, you*



can't control it." <sup>23</sup>

There's no doubt that our nation's sewage treatment systems are polluting our drinking water sources with pathogens. As a result, chlorine is also being used to disinfect *the water we drink* as well as to disinfect discharges from wastewater treatment facilities. It is estimated that 79% of the US population is exposed to chlorine.<sup>24</sup> According to a 1992 study, *chlorine is added to 75% of the nation's drinking water* and is linked to cancer. The results of the study suggested that at least 4,200 cases of bladder cancer and 6,500 cases of rectal cancer each year in the US are associated with consumption of chlorinated drinking water.<sup>25</sup> This association is strongest in people who have been drinking chlorinated water for more than fifteen years.<sup>26</sup>

In December, 1992, the US Public Health Service reported that pregnant women who routinely drink or bathe in chlorinated tap water are at a greater risk of bearing premature or small babies, or babies with congenital defects.<sup>27</sup>

According to a spokesperson for the chlorine industry, 87% of water systems in the US use free chlorines; 11% use chloramines. Chloramines are a combination of chlorine and ammonia. The chloramine treatment is becoming more widespread due to the health concerns over chlorine.<sup>28</sup> However, EPA scientists admit that we're pretty ignorant about the potential by-products of the chloramine process, which involves ozonation of the water prior to the addition of chloramine.<sup>29</sup>

Of course, we don't have to worry. The government will take care of us, and if the government doesn't, then industry will. Won't they? Well, not exactly. According to a US General Accounting Office report in 1992, consumers are poorly informed about potentially serious violations of drinking water standards. In a review of twenty water systems in six states, out of 157 drinking water quality violations, the public received a timely notice in only 17 of the cases.<sup>30</sup>

## ALTERNATIVE WASTEWATER TREATMENT SYSTEMS

New systems are being developed to purify wastewater. One popular experimental system today is the *constructed, or artificial wetlands system*, which runs wastewater through an aquatic environment consisting of aquatic plants such as water hyacinths, bullrushes, duckweed, lilies, and cattails (see Figure 5.14). The plants act as marsh filters, and the microbes which thrive on their roots do most of the work, breaking down nitrogen and phosphorous compounds, as well as toxic chemicals. Although they don't break down heavy metals, the plants absorb them; they can then be harvested and incinerated or landfilled.<sup>31</sup>

According to EPA officials, the emergence of constructed wetlands technology shows great potential as a cost effective alternative to wastewater treatment. The wetlands method is said to be relatively affordable, energy efficient, practical, and effective. Scientists don't yet have the data to determine with assurance the performance expectations of wetlands systems, or contaminant concentrations released by these systems into the environment. However, the treatment efficiency of properly constructed wetlands

is said to compare well with conventional treatment systems.<sup>32</sup> Unfortunately, wetlands systems don't recover the agricultural resources available in humanure.

Another system uses solar powered greenhouse-like technology to treat wastewater. This system uses hundreds of species of bacteria, fungi, protozoa, snails, plants and fish, among other things, to produce advanced levels of wastewater treatment. These Solar Aquatics systems are also experimental, but appear hopeful.<sup>33</sup> Again, the agricultural resources of humanure are lost when using any disposal method or wastewater treatment technique instead of a humanure recycling method.

When a household humanure recycling method is used, however, and sewage is not being produced, most households will still be producing graywater. Graywater is the water that is used for washing, bathing, and laundry, and it must be dealt with in a responsible manner before draining into the environment. Most households produce sewage (blackwater). Households that produce *only* graywater are rare, and may even be beyond the comprehension of many government authorities who may insist that every household have a sewage system (e.g., septic system) whether they produce sewage or not. Yet, households which compost their humanure may produce no sewage at all; these households are prime candidates for *alternative* graywater systems. Such alternative systems are discussed in [Chapter 9](#).

## AGRICULTURAL USE OF SEWAGE SLUDGE

Now here's where a thoughtful person may ask, "Why not put *sewage sludge* back into the soil for agricultural purposes?"

One reason: government regulation. When I asked the supervisor of my local wastewater treatment plant if the one million gallons of sludge the plant produces each year (for a population of 8,000) was being applied to agricultural land, he said, "*It takes six months and five thousand dollars to get a permit for a land application. Another problem is that due to regulations, the sludge can't lie on the surface after it's applied, so it has to be plowed under shortly after application. When farmers get the right conditions to plow their fields, they plow them. They can't wait around for us, and we can't have sludge ready to go at plowing time.*" It may be just as well.

Problems associated with the agricultural use of sewage sludge include groundwater, soil, and crop contamination with pathogens, heavy metals, nitrate, and toxic and carcinogenic organic compounds.<sup>34</sup> Sewage sludge is a lot more than organic human refuse. It can contain DDT, PCBs, mercury, and other heavy metals.<sup>35</sup> One scientist alleges that more than 20 million gallons of used motor oil are dumped into sewers every year in the United States.<sup>36</sup>

America's largest industrial facilities released over 550 million pounds of toxic pollutants into US sewers in 1989 alone, according to the US Public Interest Research Group. Between 1990 and 1994, an additional 450 million pounds of toxic chemicals were dumped into sewage treatment systems, although the actual levels of toxic discharges are said to be much higher than these.<sup>37</sup>

Of the top ten states responsible for toxic discharges to public sewers in 1991, Michigan took first prize with nearly 80 million pounds, followed in order by New Jersey, Illinois, California, Texas, Virginia, Ohio, Tennessee, Wisconsin and Pennsylvania (around 20 million pounds from PA).<sup>38</sup>

An interesting study on the agricultural use of sludge was done by a Mr. Purves in Scotland. He began applying sewage sludge at the rate of 60 tons per acre to a plot of land in 1971. After fifteen years of treating the soil with the sludge, he tested the vegetation grown on the plot for heavy metals. On finding that the heavy metals (lead, copper, nickel, zinc and cadmium) had been taken up by the plants, he concluded, “*Contamination of soils with a wide range of potentially toxic metals following application of sewage sludge is therefore virtually irreversible.*”<sup>39</sup> In other words, the heavy metals don’t wash out of the soil, they enter the food chain, and may contaminate not only crops, but also grazing animals.<sup>40</sup>

Other studies have shown that heavy metals accumulate in the vegetable tissue of the plant to a much greater extent than in the fruits, roots, or tubers. Therefore, if one must grow food crops on soil fertilized with sewage sludge contaminated with heavy metals, one might be wise to produce carrots or potatoes instead of lettuce.<sup>41</sup> Guinea pigs experimentally fed with swiss chard grown on soil fertilized with sewage sludge showed no observable toxicological effects. However, their adrenals showed elevated levels of antimony, their kidneys had elevated levels of cadmium, there was elevated manganese in the liver and elevated tin in several other tissues.<sup>42</sup>

Estimated to contain 10 billion microorganisms per gram, sludge may contain many human pathogens.<sup>43</sup> “*The fact that sewage sludge contains a large population of fecal coliforms renders it suspect as a potential vector of bacterial pathogens and a possible contaminant of soil, water and air, not to mention crops. Numerous investigations in different parts of the world have confirmed the presence of intestinal pathogenic bacteria and animal parasites in sewage, sludge, and fecal materials.*”<sup>44</sup>

Because of their size and density, parasitic worm eggs settle into and concentrate in sewage sludge at wastewater treatment facilities. One study indicated that roundworm eggs could be recovered from sludge at all stages of the wastewater treatment process, and that two-thirds of the samples examined had viable eggs.<sup>45</sup> Agricultural use of the sludge can therefore infect soil with 6,000-12,000 viable parasitic worm eggs, per square meter, per year. These eggs can persist in some soils for five years or more.<sup>46</sup> Furthermore, *Salmonellae* bacteria in sewage sludge can remain viable on grassland for several weeks, thereby making it necessary to restrict grazing on pastureland for several weeks after a sludge application. Beef tapeworm (*Taenia saginata*), which uses cattle as its intermediate host and humans as its final host, can also infect cattle that graze on pastureland fertilized with sludge. The tapeworm eggs can survive on sludged pasture for a full year.<sup>47</sup>

Another interesting study published in 1989 indicated that bacteria surviving in sewage sludge show a high level of resistance to antibiotics, especially penicillin. Because heavy metals are concentrated in sludge during the treatment process, the bacteria that survive in the sludge can obviously resist heavy metal poisoning. These same bacteria also show an inexplicable resistance to antibiotics, suggesting that somehow the resistance of the two environmental factors are related in the bacterial strains that survive.

The implication is that sewage sludge selectively breeds antibiotic-resistant bacteria, which may enter the food chain if the agricultural use of the sludge becomes widespread. The results of the study indicated that more knowledge of antibiotic-resistant bacteria in sewage sludge should be acquired before sludge is disposed of on land.<sup>48</sup>

This poses somewhat of a problem. Collecting human excrement with wastewater and industrial pollutants seems to render the organic refuse incapable of being adequately sanitized. It becomes contaminated enough to be unfit for agricultural purposes. As a consequence, sewage sludge is not highly sought after as a soil additive. For example, the state of Texas sued the US EPA in July of 1992 for failing to study environmental risks before approving the spreading of sewage sludge in west Texas. Sludge was being spread on 128,000 acres there by an Oklahoma firm, but the judge nevertheless refused to issue an injunction to stop the spreading.<sup>49</sup> Considering that the sludge was from New York City, who can blame the Texans?

Now that ocean dumping of sludge has been stopped, where's it going to go? Researchers at Cornell University have suggested that sewage sludge can be disposed of by surface applications in forests. Their studies suggest that brief and intermittent applications of sludge to forestlands won't adversely affect wildlife, despite the nitrates and heavy metals that are present in the sludge. They point out that the need to find ways to get rid of sludge is compounded by the fact that many landfills are expected to close over the next several years and ocean dumping is now banned. Under the Cornell model, one dry ton of sludge could be applied to an acre of forest each year.<sup>50</sup> New York state alone produces 370,000 tons of dry sludge per year, which would require 370,000 acres of forest each year for their sludge disposal. Consider the fact that forty-nine other states produce 7.6 million dry tons of sludge. Then there's figuring out how to get the sludge into the forests and how to spread it around. With all this in mind, a guy has to stop and wonder — the woods used to be the only place left to get away from it all.

The problem of treating and dumping sludge isn't the only one. The costs of maintenance and upkeep of wastewater treatment plants is another. According to a report issued by the EPA in 1992, US cities and towns need as much as \$110.6 billion over the next twenty years for enlarging, upgrading, and constructing wastewater treatment facilities.<sup>51</sup>

Ironically, when sludge is *composted*, it may help to keep heavy metals *out* of the food chain. According to a 1992 report, composted sludge lowered the uptake of lead in lettuce that had been deliberately planted in lead-contaminated soil. The lettuce grown in the contaminated soil which was amended with composted sludge had a 64% lower uptake of lead than lettuce planted in the same soil but without the compost. The composted soil also lowered lead uptake in spinach, beets, and carrots by more than 50%.<sup>52</sup>

Some scientists claim that the composting process transforms heavy metals into benign materials. One such scientist who designs facilities that compost sewage sludge states, “*At the final product stage, these [heavy] metals actually become beneficial micro-nutrients and trace minerals that add to the productivity of soil. This principle is now finding acceptance in the scientific community of the USA and is known as biological transmutation, or also known as the Kervran-Effect.*” Composted sewage sludge

that is microbiologically active can also be used to detoxify areas contaminated with nuclear radiation or oil spills, according to the same researcher. Clearly, the composting of sewage sludge is a grossly underutilized alternative to landfill application, and it should be strongly promoted.<sup>53</sup>

Other scientists have shown that heavy metals in contaminated compost (such as sludge compost) are *not* biologically transmuted, but are actually *concentrated* in the finished compost. This is most likely due to the fact that the compost mass shrinks considerably during the composting process showing reductions of 70%, while the amount of metals remains the same. Some researchers have shown a decrease in the concentrations of *some* heavy metals and an increase in the concentrations of others, for reasons that are unclear. Others show a considerable decrease in the concentrations of heavy metals between the sludge and the finished compost. Results from various researchers “*are giving a confusing idea about the behavior of heavy metals during composting. No common pattern of behavior can be drawn between similar materials and the same metals . . .*”<sup>54</sup> However, metals concentrations in finished compost seem to be low enough that they are not considered to be a problem, perhaps largely because metal-contaminated sludge is greatly diluted by other clean organic materials when composted.<sup>55</sup>

## GLOBAL SEWERS AND PET TURDS

Let’s assume that the whole world adopted the sewage philosophy we have in the United States: defecate into water and then treat the polluted water. What would that scenario be like? Well, for one thing it wouldn’t work. It takes between 1,000 and 2,000 tons of water at various stages in the process to flush one ton of humanure. In a world of just five billion people producing a conservative estimate of one million metric tons of human excrement daily, the amount of water required to flush it all would not be obtainable.<sup>56</sup> Considering the increasing landfill space that would be needed to dispose of the increasing amounts of sewage sludge, and the tons of toxic chemicals required to “sterilize” the wastewater, one can realize that this system of human waste disposal is far from sustainable and cannot serve the needs of humanity in the long term.

According to Barbara Ward, President of the International Institute for Environment and Development, “*Conventional ‘Western’ methods of waterborne sewerage are simply beyond the reach of most [of the world’s] communities. They are far too expensive. And they often demand a level of water use that local water resources cannot supply. If Western standards were made the norm, some \$200 billion alone [early 1980s] would have to be invested in sewerage to achieve the target of basic sanitation for all. Resources on this scale are simply not in sight.*”

To quote Lattee Fahm, “*In today’s world [1980], some 4.5 billion people produce excretal matters at about 5.5 million metric tons every twenty-four hours, close to two billion metric tons per year. [Humanity] now occupies a time/growth dimension in which the world population doubles in thirty five years or less. In this new universe, there is only one viable and ecologically consistent solution to the body waste problems — the processing and application of [humanure] for its agronutrient content.*”<sup>57</sup> This sentiment is echoed by World Bank researchers, who state, “[I]t can be estimated that the backlog of over one billion people not now provided with water or sanitation service will grow, not decrease. It

*has also been estimated that most developing economies will be unable to finance water carriage waste disposal systems even if loan funds were available.”* [58](#)

In other words, we have to understand that humanure is a natural substance, produced by a process vital to life (human digestion), originating from the earth in the form of food, and valuable as an organic refuse material that can be returned to the earth in order to produce more food for humans. That’s where composting comes in.

But hey, wait, let’s not be rash. We forgot about incinerating our excrements. We can dry our turds out, then truck them to big incinerators and burn the hell out of them. That way, instead of having fecal pollution in our drinking water or forests, we can breathe it in our air. Unfortunately, burning sludge with other municipal waste produces emissions of particulate matter, sulfur dioxide, nitrogen oxides, carbon monoxide, lead, volatile hydrocarbons, acid gases, trace organic compounds, and trace metals. The leftover ash has a high concentration of heavy metals, such as cadmium and lead.[59](#) Doesn’t sound so good if you live downwind, does it?

How about microwaving it? Don’t laugh, someone’s already invented the microwave toilet.[60](#) This just might be a good cure for hemorrhoids, too. But heck, let’s get serious and shoot it into outer space. Why not? It probably wouldn’t cost too much per fecal log after we’ve dried the stuff out. This could add a new meaning to the phrase “the Captain’s log.” Beam up another one, Scotty!

Better yet, we can dry our turds out, chlorinate them, get someone in Taiwan to make little plastic sunglasses for them, and we’ll sell them as pet turds! Now that’s an entrepreneurial solution, isn’t it? Any volunteer investors out there?

*Source: The Humanure Handbook. Jenkins Publishing, PO Box 607, Grove City, PA 16127. To order, phone: 1-800-639-4099.*

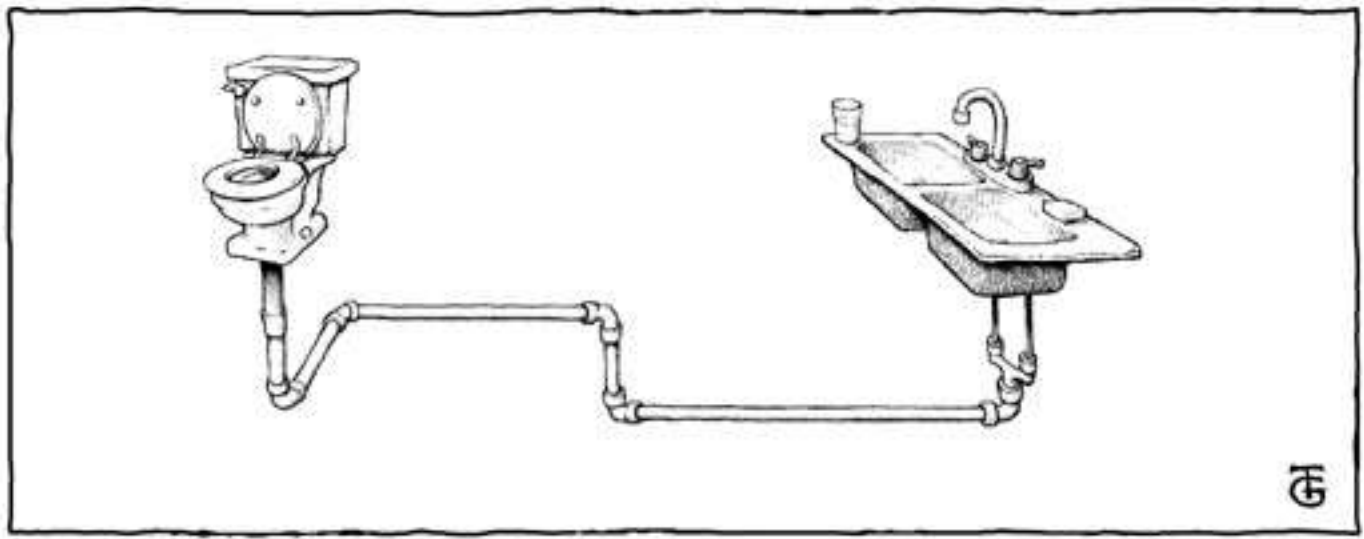
<http://www.jenkinspublishing.com/>

---

**MENU: [HOME](#) » [Reconstruction](#) » [Recovery](#) » [Renewal](#) » [Survival](#) » [Humanure Content](#)**

---

## COMPOSTING TOILETS AND SYSTEMS



*“Simplicity of life, even the barest, is not misery but the very foundation of refinement.”*

William Morris

Technically, a “composting toilet” is a toilet in which composting takes place. Usually, the composting chamber is located under the toilet. Other toilets are simply collection devices in which humanure is deposited, then removed to a separate composting location away from the toilet area. These toilets are components of “composting toilet systems,” rather than composting toilets, *per se*.

Humanure composting toilets and systems can generally be divided into two categories based on the composting temperatures they generate. Some toilet systems produce thermophilic (hot) compost; others produce low-temperature compost. Most commercial and homemade composting toilets are low-temperature composting toilets, sometimes called “mouldering toilets.”

The most basic way to compost humanure is simply to collect it in a toilet receptacle and add it to a compost pile. The toilet acts only as a collection device, while the composting takes place at a separate location. Such a toilet requires little, if any, expense, and can be constructed and operated by people of simple means in a wide range of cultures around the world. It is easy to create thermophilic (hot) compost with such a collection toilet. This type of toilet is discussed in detail in [Chapter 8, “The Tao of](#)

Compost.”

The toilets of the future will also be collection devices rather than waste disposal devices. The collected organic material will be hauled away from homes and composted under the responsibility of municipal authorities, perhaps under contract with a private sector composting facility. Currently, other recyclable materials such as bottles and cans are collected from homes by municipalities; in some areas organic food materials are also collected and composted at centralized composting facilities. The day will come when those collected organic materials will include toilet materials.

In the meantime, homeowners who want to make compost rather than sewage must do so independently by either constructing a composting toilet of their own, buying a commercial composting toilet, or using a simple collection toilet with a separate composting bin. The option one chooses depends upon how much money one wants to spend, where one lives, and how much involvement one wants in the compost-making process.

A simple sawdust toilet (a collection toilet) with a separate compost bin is the least expensive, but tends to be limited to homes where an outdoor compost bin can be utilized. Such a toilet is only attractive to people who don't mind the regular job of emptying containers of compost onto a compost pile, and who are willing to responsibly manage the compost to prevent odor and to ensure thermophilic conditions.

Homemade composting toilets, on the other hand, generally include a compost bin underneath the toilet and do not involve carting humanure to a separate compost pile. They tend to be less expensive than commercial composting toilets, and they can be built to whatever size and capacity the household requires, allowing for some creativity in their design. They are usually permanent structures located under the dwelling in a crawl space or basement, but they can also be free-standing outdoor structures. The walls are typically made of a concrete material, and the toilets are most successful when properly managed. Such management includes the regular addition to the toilet contents of sufficient carbon-based bulking material, such as sawdust, peat moss, straw, hay, or weeds. Homemade composting toilets generally do not require water or electricity. Commercial composting toilets come in all shapes, types, sizes, and price ranges. They are usually made of fiberglass or plastic, and consist of a composting chamber underneath the toilet seat. Some of them use water and some of them require electricity. Some require neither. A list of commercial compost toilet manufacturers follows this chapter.

*Source: The Humanure Handbook. Jenkins Publishing, PO Box 607, Grove City, PA 16127. To order, phone: 1-800-639-4099.*

<http://www.jenkinspublishing.com/>

---

**MENU: [HOME](#) » [Reconstruction](#) » [Recovery](#) » [Renewal](#) » [Survival](#) » [Humanure Content](#)**

---





**MENU:** [HOME](#) » [Reconstruction](#) » [Recovery](#) » [Renewal](#) » [Survival](#) » [Humanure Content](#)

---

## COMPOSTING TOILETS MUST BE MANAGED

We have used flush toilets for so long that after we defecate we expect to simply pull a handle and walk away. Some think that composting toilets should behave in the same manner. However, flush toilets are *disposal* devices that create pollution and waste soil nutrients. Composting toilets are recycling devices that should create no pollution and should recover the soil nutrients in human manure and urine. When you push a handle on a flush toilet, you're paying someone to dispose of your waste for you. Not only are you paying for the water, for the electricity, and for the wastewater treatment costs, but you are also contributing to the environmental problems inherent in waste disposal. When you use a composting toilet, you are getting paid for the small amount of effort you expend in recycling your organic material. Your payment is in the form of compost. Composting toilets, therefore, require some management. You have to *do* something besides just pushing a handle and walking away.

The degree of your involvement will depend on the type of toilet you are using. In most cases, this involves simply adding some clean organic cover material such as peat moss, sawdust, rice hulls, or leaf mould to the toilet after each use. Instead of flushing, you cover. Nevertheless, someone must take responsibility for the overall management of the toilet. This is usually the homeowner, or someone else who has volunteered for the task. Their job is simply to make sure sufficient cover materials are available and being used in the toilet. They must also add bulking materials to the toilet contents when needed, and make sure the toilet is not being used beyond its capacity, not becoming waterlogged, and not breeding flies. Remember that a composting toilet houses an organic mass with a high level of microscopic biodiversity. The contents are alive, and must be watched over and managed to ensure greatest success.

*Source: The Humanure Handbook. Jenkins Publishing, PO Box 607, Grove City, PA 16127. To order, phone: 1-800-639-4099.*

<http://www.jenkinspublishing.com/>

---

**MENU:** [HOME](#) » [Reconstruction](#) » [Recovery](#) » [Renewal](#) » [Survival](#) » [Humanure Content](#)

---

**MENU:** [HOME](#) » [Reconstruction](#) » [Recovery](#) » [Renewal](#) » [Survival](#) » [Humanure Content](#)

---

## FECOPHOBIA AND THE PATHOGEN ISSUE

The belief that humanure is unsafe for agricultural use is called *fecophobia*, a term, I admit, I made up. People who are fecophobic can suffer from severe fecophobia or a relatively mild fecophobia, the mildest form being little more than a healthy concern about personal hygiene. Severe fecophobics do not want to use humanure for food growing, composted or not. They believe that it's dangerous and unwise to use such a material in their garden. Milder fecophobics may, however, compost humanure and use the finished compost in horticultural applications. People who are not fecophobic may compost humanure and utilize it in their food garden. Some may even use it raw, a practice *not* recommended by the author.

It is well known that humanure contains the *potential* to harbor disease-causing microorganisms (pathogens). This potential is directly related to the state of health in the population which is producing the excrement. If a family is composting its own humanure, for example, and it is a healthy family, the danger in the production and use of the compost will be very low. If one is composting the humanure from orphanages in Haiti where intestinal parasites are endemic, then extra precautions must be taken to ensure maximum pathogen death. Compost temperatures must rise significantly above the temperature of the human body (37°C or 98.6°F) in order to begin eliminating disease-causing organisms, as human pathogens thrive at temperatures similar to that of their hosts. On the other hand, most pathogens only have a limited viability outside the human body, and given enough time, will die even in low-temperature compost.

Humanure is best rendered hygienically safe by thermophilic composting. To achieve this, humanure can simply be collected and deposited on an outdoor compost pile like any other compost material. Open-air, outdoor compost piles with good access are easily managed and offer a no-cost, odorless method to achieve the thermophilic composting of humanure. However, such a system does require the regular collection and cartage of the organic material to the compost pile, making it relatively labor intensive when compared to low-temperature, stationary, homemade and commercial composting toilets.

Many people will use a composting toilet only if they do not have to do anything in any way related to the toilet contents. Therefore, most homemade and commercial composting toilets are comprised of large composting chambers under the toilet seat. The organic material is deposited directly into a composting chamber, and the contents are emptied only very occasionally.

Thermophilic conditions do not seem to be common in these toilets, for several reasons. For one, many commercial composting toilets are designed to *dehydrate* the organic material deposited in them. This

dehydration is achieved by electrical fans, which rob the organic mass of moisture and heat. Commercial toilets also often strive to reduce the *quantity* of material collecting in the composting chamber (mostly by dehydration), in order to limit the frequency of emptying for the sake of the convenience of the user. Bulky air-trapping additions to the compost are not encouraged, although these additions will encourage thermophilic composting. Yet, even passive, low-temperature composting will eventually yield a relatively pathogen-free compost after a period of time.

Low-temperature composting toilets include most commercial and many homemade units. According to current scientific evidence, a few months retention time in just about any composting toilet will result in the deaths of nearly all human pathogens ([see Chapter 7](#)). The most persistent pathogen seems to be the roundworm (*Ascaris lumbricoides*) and particularly the egg of the roundworm, which is protected by an outer covering which resists chemicals and adverse environmental conditions. Estimates of the survival time of *Ascaris* eggs in certain soil types under certain conditions are as high as ten years. Although the *Ascaris* eggs are readily destroyed by thermophilic composting, they may survive in conditions generated by a low-temperature toilet. This is why the compost resulting from such toilets is generally not recommended for garden use if it comes in contact with food crops.

People can become rather obsessive about this issue. One man who published a book on this topic wrote to me to say that a two year retention time in a low-temperature composting toilet is generally considered adequate for the destruction of *Ascaris* ova (eggs). He indicated that he would never consider using his own low-temperature compost until it had aged at least two years. I asked him if he was infected with roundworms. He said no. I asked him if anyone else was using his toilet. No. I asked him what he was worried about then. Why would he think there could be roundworm eggs in his compost when he knew he didn't have roundworms in the first place? Sometimes common sense is not so common. The *potential* dangers of humanure can be blown way out of proportion. This is similar to the phobic person who would never go to a movie theater because there may be someone in the theater who has tuberculosis and who may sneeze. Although this is a risk we all take, it's not likely to be a problem.

*Source: The Humanure Handbook. Jenkins Publishing, PO Box 607, Grove City, PA 16127. To order, phone: 1-800-639-4099.*

<http://www.jenkinspublishing.com/>

---

**MENU: [HOME](#) » [Reconstruction](#) » [Recovery](#) » [Renewal](#) » [Survival](#) » [Humanure Content](#)**

---

## OWNER-BUILT COMPOSTING TOILETS

Owner-built composting toilets are in widespread use throughout the world since many people do not have the financial resources required to purchase commercially produced toilets. They tend to be low-temperature composting toilets, although they can conceivably be thermophilic toilet systems if properly managed.

The objectives of any composting toilet should be to achieve safe and sanitary treatment of fecal material, to conserve water, to function with a minimum of maintenance and energy consumption, to operate without unpleasant odors, and to recycle humanure for agricultural use.

The primary advantage of low-temperature toilets is the passive involvement of the user. The toilet collection area need not be entered into very often unless, perhaps, to rake the pile flat. The pile that collects in the chamber must be raked somewhat every few months (which can be done through a floor access door), and the chamber is emptied only after nothing has been deposited in it for at least a year or two, although this time period may vary depending on the individual system used.

In order for this system to work well, each toilet must have two chambers. Fecal material and urine are deposited into the first chamber until it's full, then the second chamber is used while the first ages. By the time the second side is full, the first should be ready to empty. It may take several years to fill a side, depending on its capacity and the number of users. In addition to feces, carbonaceous organic matter such as sawdust, as well as bulky vegetable matter such as straw and weeds, are regularly added to the chamber in use. A clean cover of such material is maintained over the compost at all times for odor prevention (see Figure 6.1).

Some of these composting toilets involve the separation of urine from feces. This is done by urinating into a separate container or into a diversion device which causes the urine to collect separately from the feces. The reason for separating urine from feces is that the urine/feces blend contains too much nitrogen to allow for effective composting and the collected material can get too wet and odorous. Therefore, the urine is collected separately, reducing the nitrogen, the liquid content, and the odor of the collected material (see Figure 6.2).

An alternative method of achieving the same result which does not require the separation of urine from feces does exist. Organic material with too much nitrogen for effective composting (such as a urine/feces mixture) can be balanced by adding more carbon material such as sawdust, rather than by removing the

urine. The added carbon material absorbs the excess liquid and will cover the refuse sufficiently to eliminate odor completely. This also sets the stage for thermophilic composting because of the carbon/nitrogen balancing.

One may also “precharge” the toilet with a “biological sponge,” a thick layer of absorbent cellulose material filling the bottom of the compost chamber to a depth of up to 50% of its capacity. Some suggest that the toilet can be filled to 100% of its capacity before beginning to be used, because if the material is loose (such as loose hay), it will compress under the weight of the added humanure. A bottom sponge may consist of bales of hay or straw buried in sawdust. These materials absorb the excess urine as it is added to the toilet. Fecal material is covered after each use with materials such as sawdust, peat, leaf mould, or rice hulls. A drain into a five gallon bucket (perhaps pre-filled with sawdust) will collect any leachate, which can simply be deposited back on the compost pile. Extra bulking materials such as straw, weeds, hay, and food scraps are regularly added to the compost chamber to help oxygenate and feed the growing organic mass in order to promote thermophilic decomposition. Ventilation can be enhanced by utilizing a vertical pipe installed like a chimney, which will allow air to passively circulate into and out of the compost chamber.

Such systems will need to be custom-managed according to the circumstances of the individuals using them. Someone needs to keep an eye on the toilet chambers to make sure they’re receiving enough bulking material. The deposits need to be flattened regularly so that they remain covered and odorless. Chutes that channel humanure from the toilet seat to the compost chamber must be cleaned regularly in order to prevent odors. When one compost chamber is filled, it must be rested while the other is filled. A close eye on the toilet contents will prevent waterlogging. Any leachate system must be monitored. In short, any composting toilet will require some management. Remember that you are actively recycling organic material, and that means you are *doing* something constructive. When you consider the value of the finished compost, you can also consider this: every time you deposit into a composting toilet, it’s as if you’re putting money in the bank.

Homemade low temperature composting toilets offer a method of composting humanure that is attractive to persons wanting a low-maintenance, low-cost, fairly passive approach to excrement recycling. Any effort which constructively returns organic refuse to the soil without polluting water or the environment certainly demands a high level of commendation.

*Source: The Humanure Handbook. Jenkins Publishing, PO Box 607, Grove City, PA 16127. To order, phone: 1-800-639-4099.*

<http://www.jenkinspublishing.com/>

---

**MENU: [HOME](#) » [Reconstruction](#) » [Recovery](#) » [Renewal](#) » [Survival](#) » [Humanure Content](#)**

---



## ASIAN COMPOSTING

It is well known that Asians have recycled humanure for centuries, possibly millennia. How did *they* do it? Historical information concerning the *composting* of humanure in Asia seems difficult to find. Rybczynski et al. state that composting was only introduced to China in a systematic way in the 1930s and that it wasn't until 1956 that composting toilets were used on a wide scale in Vietnam.<sup>1</sup> On the other hand, Franceys et al. tell us that composting "*has been practiced by farmers and gardeners throughout the world for many centuries.*" They add that, "*In China, the practice of composting [humanure] with crop residues has enabled the soil to support high population densities without loss of fertility for more than 4000 years.*"<sup>2</sup>

However, a book published in 1978 and translated directly from the original Chinese indicates that composting has not been a cultural practice in China until only recently. An agricultural report from the Province of Hopei, for example, states that the standardized management and hygienic disposal (i.e., composting) of excreta and urine was only initiated there in 1964. The composting techniques being developed at that time included the segregation of feces and urine, which were later "*poured into a mixing tank and mixed well to form a dense fecal liquid*" before piling on a compost heap. The compost was made of 25% human feces and urine, 25% livestock manure, 25% miscellaneous organic refuse, and 25% soil.<sup>3</sup>

Two *aerobic* methods of composting were reported to be in widespread use in China, according to the 1978 report. The two methods are described as: 1) surface aerobic continuous composting; and 2) pit aerobic continuous composting. The surface method involves constructing a compost pile around an internal framework of bamboo, approximately nine feet by nine feet by three feet high (3m x 3m x 1m). Compost ingredients include fecal material (both human and non-human), organic refuse, and soil. The bamboo is removed from the constructed pile and the resultant holes allow for the penetration of air into this rather large pile of refuse. The pile is then covered with earth or an earth/horse manure mix, and left to decompose for 20 to 30 days, after which the composted material is used in agriculture.

The pit method involves constructing compost pits five feet wide and four feet deep by various lengths, and digging channels in the floor of the pits. The channels (one lengthwise and two widthwise) are covered with coarse organic material such as millet stalks, and a bamboo pole is placed vertically along the walls of the pit at the end of each channel. The pit is then filled with organic refuse and covered with earth, and the bamboo poles are removed to allow for air circulation.<sup>4</sup>



A report from a hygienic committee of the Province of Shantung provides us with additional information on Chinese composting.<sup>5</sup> The report lists three traditional methods used in that province for the recycling of humanure:

- 1) Drying it — “*Drying has been the most common method of treating human excrement and urine for years.*” It is a method that causes a significant loss of nitrogen;
- 2) Using it raw, a method that is well known for pathogen transmission; and
- 3) “*Connecting the household pit privy to the pigpen . . . a method that has been used for centuries.*” An unsanitary method in which the excrement was simply eaten by a pig.

No mention is made whatsoever of *composting* being a traditional method used by the Chinese for recycling humanure. On the contrary, all indications were that the Chinese government in the 1960s was, *at that time*, attempting to establish composting as preferable to the three traditional recycling methods listed above, mainly because the three methods were hygienically unsafe, while composting, when properly managed, would destroy pathogens in humanure while preserving agriculturally valuable nutrients. This report also indicated that soil was being used as an ingredient in the compost, or, to quote directly, “*Generally, it is adequate to combine 40-50% of excreta and urine with 50-60% of polluted soil and weeds.*”

For further information on Asian composting, I must defer to Rybczynski et al., whose World Bank research on low-cost options for sanitation considered over 20,000 references and reviewed approximately 1200 documents. Their review of Asian composting is brief, but includes the following information, which I have condensed:

There are no reports of composting privys (toilets) being used on a wide scale until the 1950s, when the Democratic Republic of Vietnam initiated a five-year plan of rural hygiene and a large number of *anaerobic* composting toilets were built. These toilets, known as the Vietnamese Double Vault, consisted of two above ground water-tight tanks, or *vaults*, for the collection of humanure (see Figure 6.3). For a family of five to ten people, each vault was required to be 1.2 m wide, 0.7 m high, and 1.7 m long (approximately 4 feet wide by 28 inches high and 5 feet 7 inches long). One tank is used until full and left to decompose while the other tank is used. The use of this sort of composting toilet requires the segregation of urine, which is diverted to a separate receptacle through a groove on the floor of the toilet. Fecal material is collected in the tank and covered with soil, where it anaerobically decomposes. Kitchen ashes are added to the fecal material for the purpose of reducing odor.

Eighty-five percent of intestinal worm eggs, one of the most persistently viable forms of human pathogens, were found to be destroyed after a two month composting period in this system. However, according to Vietnamese health authorities, forty-five days in a sealed vault is adequate for the complete destruction of all bacteria and intestinal parasites (presumably they mean pathogenic bacteria). Compost from such latrines is reported to increase crop yields by 10-25% in comparison to the use of raw

humanure. The success of the Vietnamese Double Vault required “*long and persistent health education programs.*” <sup>6</sup>

When the Vietnamese Double Vault composting toilet system was exported to Mexico and Central America, the result was “*overwhelming positive,*” according to one source, who adds, “*Properly managed there is no smell and no fly breeding in these toilets. They seem to work particularly well in the dry climate of the Mexican highlands. Where the system has failed (wetness in the processing chamber, odours, fly breeding) it was usually due to non-existent, weak, or bungled information, training and follow-up.*” <sup>7</sup> A lack of training and a poor understanding of the composting processes can cause any humanure composting system to become problematic. Conversely, complete information and an educated interest will ensure the success of humanure composting systems.

Another anaerobic double-vault composting toilet used in Vietnam includes using both fecal material *and* urine. In this system, the bottom of the vaults are perforated to allow drainage, and urine is filtered through limestone to neutralize acidity. Other organic refuse is also added to the vaults, and ventilation is provided via a pipe.

In India, the *composting* of organic refuse and humanure is advocated by the government. A study of such compost prepared in pits in the 1950s showed that intestinal worm parasites and pathogenic bacteria were completely eliminated in three months. The destruction of pathogens in the compost was attributed to the maintenance of a temperature of about 40°C (104°F) for a period of 10-15 days. However, it was also concluded that the compost pits had to be properly constructed and managed, and the compost not removed until fully “ripe,” in order to achieve the total destruction of human pathogens. If done properly, it is reported that “*there is very little hygienic risk involved in the use and handling of [humanure] compost for agricultural purposes.*” <sup>8</sup>

In short, it doesn’t look like the Asians have a lot to offer us with regard to composting toilet designs. Perhaps we should instead look to the Scandinavians, who have developed many commercial composting toilets.

*Source: The Humanure Handbook. Jenkins Publishing, PO Box 607, Grove City, PA 16127. To order, phone: 1-800-639-4099.*

<http://www.jenkinspublishing.com/>

---

**MENU: [HOME](#) » [Reconstruction](#) » [Recovery](#) » [Renewal](#) » [Survival](#) » [Humanure Content](#)**

---

**MENU:** [HOME](#) » [Reconstruction](#) » [Recovery](#) » [Renewal](#) » [Survival](#) » [Humanure Content](#)

## COMMERCIAL COMPOSTING TOILETS

Commercial composting toilets have been popular in Scandinavia for some time; at least twenty-one different composting toilets were on the market in Norway alone in 1975.<sup>9</sup> One of the most popular types of commercially available composting toilets in the United States today is the multrum toilet, invented by a Swedish engineer and first put into production in 1964 (see Figure 6.4). Fecal material and urine are deposited together into a single chamber with a double bottom. The decomposition takes place over a period of years, and the finished compost gradually falls down to the very bottom of the toilet chamber where it can be removed. Again, the decomposition temperatures remain cool, not usually climbing above 32°C (90°F). Therefore, it is recommended that the finished compost be buried under one foot of soil or used in an ornamental garden.<sup>10</sup>

Because no water is used or required during the operation of this toilet, human excrement is kept out of water supplies, conserving water. According to one report, a single person using a Clivus (pronounced Clee-vus) Multrum (see Figure 6.5) will produce 40 kg (88 lbs) of compost per year while refraining from polluting 25,000 liters (6,604 gallons) of water annually.<sup>11</sup> The finished compost can be used as a soil additive where the compost will not come in contact with food crops.

A 1977 report issued by Clivus Multrum USA analyzed the nutrient content in finished compost from seven Clivus Multrum toilets which had been in use for 4 to 14 years. The compost averaged 58% organic matter, with 2.4% nitrogen, 3.6% phosphorous, and 3.9% potassium, reportedly higher than composted sewage sludge, municipal compost, or ordinary garden compost. Suitable concentrations of trace nutrients were also found. Toxic metals were found to exist in concentrations far below recommended safe levels.<sup>12</sup>

If a multrum toilet is managed properly, it should easily be odor and worry-free. As always, a good understanding of the basic concepts of composting helps anyone who wishes to use a composting toilet. Nevertheless, the multrum toilets, when used properly, should provide a suitable alternative to flush toilets for people who want to stop defecating in their drinking water. You can probably grow a heck of a rose garden with the compost, too.

Inexpensive versions of multrum toilets were introduced into the Philippines, Argentina, Botswana, and Tanzania, but were not successful. According to one source, “*Compost units I inspected in Africa were the most unpleasant and foul-smelling household latrines I have experienced. The trouble was that the mixture of excreta and vegetable matter was too wet, and insufficient vegetable matter was added, especially during the dry season.*”<sup>13</sup> Poor management and a lack of understanding of how composting

works will create problems with any compost toilet. Too much liquid will create anaerobic conditions with consequent odors. The aerobic nature of the organic mass can be improved by the *regular* addition of carbonaceous bulking materials. Compost toilets are not pit latrines. You cannot just defecate in a hole and walk away. If you do, your nose will let you know that you're doing something wrong.

Besides the Scandinavian multrum toilets, a variety of other composting toilets are available on the market today. One manufacturer claims that over 200,000 of their composting toilets have been sold worldwide. The same manufacturer produces a fiberglass and stainless steel toilet which consists of a drum under the toilet seat or under the bathroom floor into which the feces and urine are deposited. The drum is rotated by hand in order to blend the ingredients, which should include food scraps and a carbon material such as peat moss. The toilet can come equipped with an electric heating system and an electrical fan ventilation system. The compost, produced in small quantities which are removed by pulling out a drawer beneath the drum, is said to be suitable for garden purposes. Some of the models require water as well as electricity (although some require no electricity or water).<sup>14</sup>

Other composting toilets cost upwards of \$10,000 or more, and can be equipped with insulated tanks, conveyers, motor-driven agitators, pumps, sprayers, and exhaust fans.<sup>15</sup> According to a composting toilet manufacturer, waterless composting toilets can reduce household water consumption by 40,000 gallons (151,423 liters) per year.<sup>16</sup> This is significant when one considers that only 3% of the Earth's water is not salt water, and two-thirds of that freshwater is locked up in ice. That means that less than one percent of the Earth's water is available as drinking water. Why shit in it?

*Source: The Humanure Handbook. Jenkins Publishing, PO Box 607, Grove City, PA 16127. To order, phone: 1-800-639-4099.*

<http://www.jenkinspublishing.com/>

---

**MENU: [HOME](#) » [Reconstruction](#) » [Recovery](#) » [Renewal](#) » [Survival](#) » [Humanure Content](#)**

---

**MENU:** [HOME](#) » [Reconstruction](#) » [Recovery](#) » [Renewal](#) » [Survival](#) » [Humanure Content](#)

# COMPOSTING TOILETS AND RELATED PRODUCTS: MANUFACTURERS AND SUPPLIERS

(Special Thanks to the World of Composting Toilets Website at:  
<http://www.compostingtoilet.org/>)

This list is provided for informational purposes only. Inclusion on this list does not constitute an endorsement by the author.

[AUSTRALIA](#) | [BELGIUM](#) | [CANADA](#) | [CHILE](#) | [DENMARK](#) | [FINLAND](#) | [GERMANY](#) | [IRELAND](#) | [ISRAEL](#) | [KOREA](#) | [LATVIA](#) | [NETHERLANDS](#) | [NEW ZEALAND](#) | [NORWAY](#) | [SOUTH AFRICA](#) | [SPAIN](#) | [SWEDEN](#) | [SWITZERLAND](#) | [UK](#) | [USA](#) | [OWNER BUILT](#) | [COMPOST THERMOMETERS](#) | [BACKYARD COMPOST BINS](#) | [COMPOST TESTING LABS](#) | [AUDIO TAPES](#) | [INTERNET LINKS](#)

## AUSTRALIA

### CLIVUS MULTRUM AUSTRALIA

115 Railway Avenue, Strathpine, Qld 4500, Australia

Phone: 61 7 3889 6144

Fax: 61 7 3889 6149

Mobile phone: 0419 657851

Website: <http://www.earthlink.com.au/clivus>

Email: [www.ats.com.au](mailto:www.ats.com.au)

Contact: Tony Rapson

Sells the Clivus Multrum range of toilets and graywater systems as well as toilet buildings for use in National Parks and Public areas. Also acts as agent for Separett and EnviroLet composting toilets.

### CLIVUS MULTRUM TOILET SYSTEMS (Agent)

9 Holland Street, Fremantle 6160, Western Australia, Australia

Phone: (08) 9430 7777

Fax: 61 8 9430 4305

Email: [gaiagnet@cygnus.uwa.edu.au](mailto:gaiagnet@cygnus.uwa.edu.au)

Agent for Clivus Multrum composting toilets in western Australia.

### CLOSET DEPOSIT

3 Redash Place, Cabarita Beach, NSW 2488 Australia;

Contact: Graham Clements;

Supplies own design, inclined base, fibreglass composting chamber. Improved ventilation system for reduced tank size. Also supplies artificial wetlands graywater system in ferro-cement or HDPE plastic with flowform water conditioners.

### DOWMUS

Pty Ltd PO Box 400, Mapleton Qld, 4552, Australia

Phone: 61 7 5499 9828

Fax: 61 7 5499 9688

Email: [dowmus@ozemail.com.au](mailto:dowmus@ozemail.com.au)

Website: <http://www.dowmus.com/>

Supply and install single batch tank system with compost extortion auger. Emphasis on worm and compost fauna treatment. Also incorporating graywater treatment.

### GARRY SCOTT COMPOST TOILET SYSTEMS

Mullumbimby NSW, 2482, Australia

Phone: 61 2 6684 3468

FAX: 61 2 6684 4567

Email: [maito:enquires@composttoilets.com.au](mailto:maito:enquires@composttoilets.com.au)

Website: <http://www.composttoilets.com.au/>

Design, manufacture, supply and service of a wide range of waterless compost toilets. Independent agent for systems manufactured by Clivus Multrum, Natureloo, Envirolet, Separett and selected others. Manufacture of lowcost PBD and Wheelie Batch systems. Ownerbuilder assistance with consultation, components, plans and books. Agent for the Hybrid toilet system, a septic system, with no flush, secondary treatment and excellent performance.

### NATURE-LOO

Savannah Environmental Pty Ltd, 74 Brisbane Street, Bulimba, QLD 4171, Australia

Postal Address: P.O. Box 150, Bulimba, Queensland, Australia 4171

Phone: 61 7 3395 6800

Fax: 61 7 3395 5322

Email: [info@nature-loo.com.au](mailto:info@nature-loo.com.au)

Website: <http://www.nature-loo.com.au/>

Contact: Carla Gregg

Patented market-leader in domestic composting toilets: inexpensive, aerated tank, odour-free, batch system. Classic model easily owner-installed in space under floor. Self-contained Compact model can be installed on slab floor, and is suitable for temporary accommodation, holiday cabins, building sites, camp

grounds, etc. Also markets toilet buildings suitable for golf courses, building sites, etc.

### ROTA-LOO COMPOSTING TOILET

41A Jarrah Drive or PO Box 988, Braeside, Victoria 3195 Australia

Phone: 61 3 9587 2447

Fax: 61 3 9587 5622

Website: <http://www.rotaloo.com/>

E mail: [buzzburrows@rotaloo.com](mailto:buzzburrows@rotaloo.com)

General info: [enquiry@rotaloo.com](mailto:enquiry@rotaloo.com)

Contact: Buzz Burrows (General Manager)

Domestic models, Mini 650, Standard 950 all with removable compost bins. Commercial models, Maxi 1200 (Fiberglass) Maxi 2000, all with removable compost bins. Soltran buildings, remote location Public Toilet Facilities, supplied in kit form in any configuration with combinations of two cubicles either standard or disabled. Graywater systems, plans available for passive systems or electropurification system will clean graywater to potable standard. Other products: Bacterial agents to speed up the decomposition rate. Bacterial agents that terminate odour problems in bad installations. Full range of accessories, fiberglass and ceramic pedestals. Urinals that don't need water for cleaning.

### BELGIUM

ECOSAVE SEPRETT (Agent)

Flierenbos 67, 2370 Arendonk, Belgium Ph/Fax: 32 14 67 20 04; Agent for Septum and Separett urine separating composting toilets.

### CANADA

CLIVUS MULTRUM CANADA LIAISON OFFICE

1911 Lorraine Place, Ann Arbor, MI 48104-3607

Contact: Laurence Scott

Phone: 734-995-4767

Fax: 734-994-1292

Email: [mailto:naylorscott@compuserve.com](mailto:mailto:naylorscott@compuserve.com)

CLIVUS MULTRUM CANADA LTD.

1558 Queen Street, East Toronto, Ontario, M4L 1E8 or P.O.Box 783 - Station A, Windsor, Ontario, N9A 6N8

Phone: 800-645-4767

Fax: 416-466-0635 Attn: L H Scott

Email: [naylorscott@compuserve.com](mailto:naylorscott@compuserve.com)

CANADA-USA LIAISON

Phone : 734-995-4767

Fax: 734-994-1292

### COMPOSTING TOILETS WESTERN (Agent)

1278 Inglewood Avenue, West Vancouver, B.C. B7T 1Y6, Canada

Phone: 1-604-926-3748

Fax: 1-604-926-4854

Contact: Bob Tapp

### COMPOSTING TOILETS WESTERN

23646 16th Avenue, Langley B.C.V2Z 1K9, Canada

Phone/Fax: 1-604-533-5207

Contact: J. Rockandel

Supply and install Clivus Multrum composting toilets and Sum-mar composting toilets.

### SANCOR

140-30 Milner Ave., Toronto, Ontario M1S 3R3 Canada

USA Toll-Free: 1-800-387-5126

CDA Toll-Free: 1-800-387-5245

International: 1-416-299-4818

Fax: 1-416-299-3124

Email: [info@envirolet.com](mailto:info@envirolet.com)

Website: <http://www.envirolet.com/>

Online Store: <http://www.sancor.net/>

Manufacturer of Envirolet Composting Toilet Systems. The systems include Waterless Self-Contained, Waterless Remote and Low Water Remote models. Available in Non-Electric, 12v Battery, Solar and 110v Electric. Available for purchase online.

### SUNERGY SYSTEMS LTD.

Box 70, Cremona, AB T0M 0R0, Canada

Phone: 403-637-3973

Email: [sunergy@telusplanet.net](mailto:sunergy@telusplanet.net)

Website: <http://www.compostingtoilet.com/>

Contact: Michael Kerfoot

Also at: SUNERGY'S B.C. OFFICE

2945 Haliday Crescent, Nanaimo, B.C. V9T 1B2 Canada

Phone: 250-751-0053

Fax: 250-751-0063

Sunergy distributes Phoenix composting toilet systems in Canada for residential and public facility applications. Installations from coast to coast include National Parks, Provincial Parks, roadside rest areas, golf courses, responsible housing, etc. Design integrates solar/energy/resource efficiency with a natural whimsy.



## SUN-MAR CORPORATION

5035 N Service Rd C9, Burlington Ontario L7L 5V2 Canada

Phone: 1-905-332-1314

Fax: 1-905-332-1315

For a Free Catalogue Call: 1-800-461-2461

Email: [compost@sun-mar.com](mailto:compost@sun-mar.com)

Website: <http://www.sun-mar.com/>

Long time successful suppliers of bathroom installed composting toilets. Large range of models available for differing situations; both residential and cottage use toilets available.

## CHILE

### MINIMET

S.A. Av. 11 de Septiembre 1860, Of. 106, Santiago, Chile

Contact: Jaime Arancibia

Phone: 56-2-233-53 69 Fax: 56-2-232-11 95

Email: [ggminimet@entelchile.net](mailto:ggminimet@entelchile.net)

Manufactures and sells Clivus Multrum products under license from Clivus Multrum, USA.

## DENMARK

A & B BACKLUND APS (Agent)

Ordrupvej 101, DK-2920 Charlottenlund, Denmark

Phone: 45 39 63 33 64

Fax: 45 39 63 64 55

Email: [backlund@backlund.dk](mailto:backlund@backlund.dk)

We work with ecological environmental engineering and waste to energy subjects. We sell no-mixing composting toilets in plastic, pine wood, metal or china. Our big composting units are made of stainless steel or glassfiber with geotextile sacks. The toilets are either without flushing, with single flushing for urine, double flushing for both urine and feces (but separate), or with vacuum for feces and gravitation for urine. Agent for Separett, Septum, Mullis, WM-Ekologen.

B & O BYGGEINDUSTRI A/S

Pakhus 12, Sdr. Frihavn, Dampfaergevej 8, 2100 Kobenhaun 0, Denmark

Contact: Dany Vandy

Phone : 45 35 43 01 01

Fax: 45 35 43 25 22

Website: <http://www.bobyg.dk>

Email: [info@bobyg.dk](mailto:info@bobyg.dk)

Sells and markets Clivus Multrum products as agent for Clivus AB, Sweden.

## FINLAND

**EKOLET (Biolett)**

Estetie 3, FIN-00430 Helsinki, Finland

Phone: +358 40 546 4775, Fax: +358 9 563 5056

Email: [ekolet@ekolet.com](mailto:ekolet@ekolet.com)

Website: <http://www.ekolet.com/>

The Ekolet composting toilet is the manufacturer's own design for domestic and cottage use. Good experience and test results for over 10 years. Requires no water, no additives, low or no el. requirements, cleans the liquid biologically so it can be piped along with graywater. Consists of a toilet seat and a 4 chamber rotating composting tank (polyethene, stainless steel) under the floor. The end-product is ready-to-use odorless fertilizer.

**LUONTO-LAITE OY**

Kasiniemenraitti 229, Fin-17740 Kasiniemi, Finland

Phone: +358 (0)3 556 8132

Fax +358 (0)3 556 8133

Email: [luontola@sci.fi](mailto:luontola@sci.fi)

Marketing: NEXET OY

Ravurinkatu 11 FIN-20380 Turku, Finland

Phone: +358 (0)2 276 0250

Fax: +358 (0)2 276 0251

Email: [nexet@nexet.fi](mailto:nexet@nexet.fi)

Website: <http://www.saunalahti.fi/luontola>

The Composting Naturum Toilet. Bathroom installed, urine separating, rotary drum, composting toilet. Stylish design toilet in non-PVC plastic.

**GERMANY**

**BIOTECHNIK (Agent)**

Sigrid Habel, Lessingstr.6, D-04109 Leipzig Germany

Phone: 49 342 234 8657

Fax: 49 341 980 3391

Agent for Biolett (Ekolet) composting toilets.

**PEUSER GMBH (Agent)**

Siloweg 1, D-56479 Neunkirchen/Ww Germany

Phone: 49 6436 35 45

Fax: 49 6436 64 99

Agent for Septum toilets and products.

**PEUSER GMBH (Agent)**

Stollberger Strasse 31 D-09221 Neunkirchen/bei Chemnitz, Germany

Phone: 49 371 281 21 70

Fax: 49 371 281 21 50

Agent for Septum and Separett composting toilets and products.

**SANITÄR U. HEIZUNG (Agent)**

Uwe Reimer, Hallesche Strasse 9, D-04509 Delitzsch, Germany

Phone: 49 342 025 9281

Fax: 49 177 275 0928

Agent for Biolett (Ekolet) composting toilets.

**C. & M. SCHÖNBERGER GBR (Agent)**

Blumenstrasse 11; D-61239 Langenhain

Phone: 49 6002-92990

Fax: 49 6002-92980

Agent for Separett Toilets

**SOLTEC GMBH (Agent)**

Wichmannstrasse 4, Bldg. 10, D-22607 Hamburg, Germany

Phone: +49 40 89 50-25

Fax: +49 40 89 50-28

Email: <mailto:soltec@enbil.de>

Agent for Biolett (Ekolet) composting toilets.

## **IRELAND**

**THE OLD RECTORY ROBERT FORRESTER, EASKEY, CO.**

Sligo Republic of Ireland

Phone/Fax: 353 96 49 181

Email: [adlib@tinet.ie](mailto:adlib@tinet.ie)

Agent for Septum and Separett servicing both UK and Ireland.

## **ISRAEL**

**ECONET ENVIRONMENTAL TECHNOLOGIES & PROJECTS LTD**

Dr. Amram Pruginin, 11 Bialik St, Jerusalem, Israel

Phone/Fax: (972) 2-653 61 71

Email: <mailto:msamram@pluto.mscc.huji.ac.il>

Agent for Clivus Multrum in Israel.

## **KOREA**

**CLIVUS KOREA INC.**

701 Marco Polo Building, 720-20 Yeoksam-Dong, Kangnam-Ku, Seoul, 135-080 Korea  
Phone: 82-2-501-4794/5  
Fax: 82-2-568-4631  
Contact: J.H. Um  
Manufacture and market Clivus Multrum under license from Clivus Multrum USA.

## **LATVIA**

SIA APRITE (Agent)  
Gaujas iela 56, Cesis LV-4101, Latvia  
Phone/Fax: 371 41 25 033  
Agent for Septum toilets and products.

## **NETHERLANDS (HOLLAND)**

CLIVUS MULTRUM ECOSAVE - Mr. Danny Vandy  
Noorderbaan 25, 8256 PP Biddinghuizen, Holland  
Phone: (31)-321-332-038  
Fax: (31)-321-330-975  
Agent for Clivus Multrum composting toilets, Septum and Separett.

## **TECHNISCH BUREAU HAMAR**

Heykampsweg 6, 7642 LP Wierden, Netherlands  
Phone: 31 546 575697

Email: [tbhamar@xs4all.nl](mailto:tbhamar@xs4all.nl)

Website: <http://www.xs4all.nl/~tbhamar>

Contact: Hans Baarslag; Makes and sells composting toilets for camping, temporary dwellings and replacement in normal houses. The designs are simple and utilize common materials in their manufacture. They are designed for economic treatment of toilet deposits and some household organic material.

## **NEW ZEALAND**

ECOTECH (Agent)  
RD 1 Masters Access Rd., Kaitaia, 0500 New Zealand  
Phone/Fax: 64 9 409 4993

Website: <http://www.ecotech.co.nz/>

Email: [ecotech/nzed@xtra.co.nz](mailto:ecotech/nzed@xtra.co.nz)

Contact: J. Douglas Donnell.  
Distributors of Sun-Mar composting toilets.

## **NORWAY**

## **IMPERIAL ENGOS AS**

Langgaten 71 A, Postboks 98 N 4301 Sandnes, Norway

Phone: 47 51 66 44 92

Fax: 47 51 62 36 07

Agent for Separett.

## **VERA VERA MILJO A/S**

Postboks 2036, N-3239 Sandefjord Norway

## **SOUTH AFRICA**

### **DRYLOO**

PO Box 75619, Gardenview 2047, South Africa

Phone/Fax: 2711 615 5328

Mobile: 2782 463 0674

Email: [theboys@netactive.co.za](mailto:theboys@netactive.co.za)

Dryloo waterless collapsible low cost composting toilets. Six catchment bags on rotatable piping carousel. No mechanical parts. Suitable for hot conditions. Prov. Pat. 99/1278. Also solar toilet extraction fans. Available from Michael Mayers and Associates. The specialist in African non-flush toilets.

### **ENVIROLOO ENVIRO OPTIONS (PTY) LTD**

P.O. Box 27356, Benrose, 2011, South Africa

Phone: 27 11 6181350

Fax: 27 11 6181838

Established composting toilet maker/installer.

## **SPAIN**

### **CLIVUS MULTRUM WILLI KNACKSTEDT**

Phone /Fax: (34)-95-266 60 25

Mobile: 989 82 22 30

Email: [carl@websida.com](mailto:carl@websida.com)

## **SWEDEN**

### **AQUATRON INTERNATIONAL BJORNNASVAGEN**

21, S-113 47 Stockholm, Sweden

Phone: 46-8-790 9895

Fax: 46-8-15 7504

Email: [info@aquatron.se](mailto:info@aquatron.se)

Website: <http://www.aquatron.se/>

Contact: Rolf Kornemark or Torgny Sundin.

Systems that use standard flush toilets connected to composting chambers via a centrifugal separator. The composting chamber is either inclined base, single batch or 4 chamber carousel. Graywater is treated with UV prior to drainage to a Graywater infiltration bed..

#### CLIVUS MULTRUM AB

Ålberga Boställe, 61050 Jönåker, Sweden

Phone: (46)-155-72310

Fax: (46)-155-72390

Email: [torb@clivus-multrum.se](mailto:torb@clivus-multrum.se)

Main office in Europe for Clivus Multrum Composting Toilets

#### EKOLOGEN AB

Box 11162 - 10061, Stockholm, Sweden

Phone: 46 8 641 4250

Fax: 46 8 798 5650

Urine separating composting toilet systems.

#### MULLIS - THE BIOLOGICAL TOILET

Luxgatan 1, 119 69 Stockholm, Sweden

Phone: 46 8 656 54 56

Fax (?): +46 8 184 71 8

Email: [mullis@hem3.passagen.se](mailto:mullis@hem3.passagen.se)

Website: <http://hem3.passagen.se/mullis>

Contact: Uno Finnstrom

Supplies an inclined base composting toilet with 4 air tracks, built in rustfree sheet metal. Can be ordered made in desired length for capacity required.

#### SERVATOR SEPRETT AB

Skinnebo, S-330 10 Bredaryd, Sweden

Phone: 46 371 712 20

Fax: 46 371 712 60

Email: [mailto:servator@mbox200.swipnet.se](mailto:mailto:servator@mbox200.swipnet.se)

Website: <http://www.seprett.com/>

Suppliers of Lectrolav and Separett toilets, and now Septum composting toilets.

#### SVEN LINDEN AB

Ludvigsborg, 24394 Hoor, Sweden

Phone: 46-415-51335

Fax: 46-415-51115

Mobile: 070 584 76 52

Contact: Sven Linden

Produce a number of capacity tanks based on the single batch system with or without inclined base. Also a wheeled bin system is available.

## SWEDISH ECOLOGY AB

Klippan 1A, S-414 51 Goteborg, Sweden

Phone: 46 31 42 29 30

Fax: 46 31 42 49 08

Contact: Harry Lejgren

Agent for the MullToa and Separera systems. These are the equivalent Scandinavian names for the Biolet and UFA toilets supplied by Biolet International.

## SWITZERLAND

### BIOLET INTERNATIONAL

Weidstrasse 18a, 6300 Zug, Switzerland

Phone : 41 41 710 4728

Fax: 41 41 710 4683

Website: <http://www.biolet.com/>

E-mail: [info@biolet.com](mailto:info@biolet.com)

Established, world-wide suppliers of 9 models of unit compost toilets for bathroom and under-house installation.

## UK

### BARTON ACCESSORIES

Morleigh Road, Harbertonford, Totnes, Devon TQ9 7TS, England

Phone/Fax: 44 1803 732878

Supplies the WEB toilet, a waterless electronic/biological toilet unit that fits in bathroom. In-built heat treatment in composting cycle. Is able to supply world-wide. New model: 12/24v DC, small enough for recreational vehicles, boats, motor coaches, domestic; can be run from solar cells, batteries, or wind generator.

### EASTWOOD SERVICES

Kitty Mill, Wash Lane, Wenhasston, Halesworth, Suffolk, IP19 9DX, England

Phone/Fax: 44 1502 478165

Contact: Adam East.

UK agent for Sun-Mar composting toilets and low flush systems. Supplier of gray and rain water recycling systems.

### EKOLOGEN/NATRUM/SEPTUM EASTWOOD SERVICES

c/o Kitty Mill, Wash Lane Wenhasston Halesworth, Suffolk IP19 9DX England

Phone: 44 1502 478249

Fax: 44 1502 478165

## ELEMENTAL SOLUTIONS

Oaklands Park, Newnham-on-Severn Gloucestershire, GL14 1EF, UK

Phone: 01594 516063

Fax: 01594 516821

Email <mailto:mark.es@aecb.net>

Contact: Mark Moodie

Incorporates 'Camphill Water' and 'Nick Grant Ecological Engineering'; responsible for over 100 reed bed sites and compost toilet installations. Ceramic composting toilet pedestals. Own design and site specific composting toilet kits. UK and Ireland agents for 'Aquatron' toilet systems. Co writers of "Sewage Solutions; Answering the Call of Nature" and "Septic Tanks." Low water use fittings. Sewage courses, and rainwater harvesting. Genuine enquiries only please.

## KINGSLEY CLIVUS ENVIRONMENTAL PRODUCTS LTD.

Kingsley House, Woodside Road, Boyatt Wood Trading Estate, Eastleigh, Hampshire S050 4ET Great Britain

Phone: 44 01703 615680

Fax: 44 01703 642613

Contact: Viv Murley

Sells and markets Clivus Multrum products as agent for Clivus Multrum USA.

## MAURICE MOORE

26 St Mary's Rd, Long Ditton, Surrey KT6, England

Phone: 44 181 398 7951

Agent for Soltrna/ Rota-loo in United Kingdom.

## WENDAGE POLLUTION CONTROL LTD (Agent)

Rangeways Farm, Conford, Liphook, Hants UK GU30 7QP

Phone: 44 1428 751296

Fax: 44 1428 751541

Contact: Nigel Mansfield.

Agent for Biolet self-contained electrical compost toilets, in several varieties for home, caravans and portacabins. Also consultants in water, sewage and pollution control.

## USA

## ADVANCED COMPOSTING SYSTEMS

195 Meadows Road, Whitefish, MT, 59937, USA

Phone: 1 406 862 3855

Fax: 1 406 862 3855



Email: [phoenix@compostingtoilet.com](mailto:phoenix@compostingtoilet.com)

Website: <http://www.compostingtoilet.com/>

Contacts: Glenn Nelson, James Conner

Manufactures the Phoenix Composting Toilet, a continuous throughput system featuring odorless, waterless operation, and built-in liquid respray of the composting pile. Very low energy requirements (five watts). Options include microflush toilets, auxillary evaporators, and photovoltaic systems for off-grid installations. Residential and public facility models available.

#### ALASCAN CLEARWATER SYSTEM

3498 St. Albans Road, Cleveland Heights, OH 44121 USA

Phone: 1 216 382 4151

Contact: David Kern

Email: [Drewid@star21.com](mailto:Drewid@star21.com)

Originally developed, tested and supplied in Alaska. The system uses either one cup per flush, or foam flush toilets, and a basement system comprised of one composting tank, one graywater treatment tank, & optional recycling system. System effluents are topsoil & potable water. They have a 15 minute video about the system, available for \$15 US including S&H.

#### ALASCAN OF MINNESOTA, INC.

8271 - 90th Lane, Clear Lake, MN 55319 USA

Marketing Manager: Jerry L. Carter

Phone: (320) 743-2909

Fax: (320) 743-3509

Email: [mailto:mail@alascanofmn.com](mailto:mail@mail@alascanofmn.com)

Website: <http://www.alascanofmn.com/>

#### ARCHITERRA ENTERPRISES, INC.

0186 SCR 1400, BRR, Silverthorne, CO 80498 USA

Phone/Fax: 970-262-6727

Email: <mailto:natural@colorado.net>

Website: <http://thenaturalhome.com/>

Catalog: The Natural Home Building Source (24 pages)

We sell and install graywater system packages, and Clivus Multrum and Sun-Mar composting toilet systems.

#### BIOLET U.S.A.

45 Newbury Street, Boston, MA 02116 USA

Phone: (617) 578-0435

Fax: (617) 578-0465

E-mail: [info@biolet.com](mailto:info@biolet.com)

Website: <http://www.biolet.com/>

Established manufacturer (since 1972) and worldwide supplier of BioLet composting toilets. Self

contained, remote and non electric units are available.

#### BIO-RECYCLER CORP.

5308 Emerald Drive, Sykesville, MD 21784 USA

Phone: 1 410 795-2607

Fax: 1 410 549 1445

Contact: Jeremy Criss

Vermiculture based remote processing unit to which toilet deposits are delivered, using minimal water, by vacuum assisted toilet units. The resultant product is high nutrient worm castings used for soil amendment.

#### BIO-SUN SYSTEMS INC.

RR#2 Box 134A, Route 549, Jobs Corners, Millerton, PA 16936, USA

Toll free: (800) 847-8840

Phone: 1-717 537 2200

Fax: 1 717 537 6200

Email: [bio-sun@ix.netcom.com](mailto:bio-sun@ix.netcom.com)

Contact: Becky Heffner, Al White

Composting toilet system based on the use of in-situ built tank and intermittent compressed air blown through composting pile.

#### CENTRE FOR ECOLOGICAL POLLUTION PREVENTION

P.O. Box 1330, Concord, MA 01742-1330 USA

Phone 978-369-9440

Email: [mailto:cepp@hotmail.com](mailto:mailto:cepp@hotmail.com)

The CEPP develops, promotes and demonstrates innovative lower-impact technologies and systems, with an emphasis on utilization and zero-discharge approaches. Their most important successes have been the development of low cost net composting systems that are suitable for developing countries and the development of planted treatment systems for graywater utilization.

#### CLIVUS MULTRUM US

15 Union Street, Lawrence MA, 01840, USA

Phone: 1 978 725 5591;

Toll Free: 1 800 4 CLIVUS

Fax: 1 978 557 9658

Email: [forinfo@clivusmultrum.com](mailto:forinfo@clivusmultrum.com)

Webpage: <http://clivusmultrum.com/>

Contact: Don Mills

Sole manufacturer of the Clivus Multrum, original design of inclined base composting toilet. Residential models as well as commercial systems. Also sell toilet buildings and graywater treatment systems.

#### CLIVUS NEW ENGLAND

P.O. BOX 127, North Andover, MA 01845 USA

Phone: 978-794-9400

Fax: 978-794-9444

CLIVUS MULTRUM GREAT LAKES, INC.

P.O. Box 1025, Ann Arbor, MI 48106 USA

Phone: 734-995-4767

Fax: 734-994-1292

COTUIT DRY TOILET

Conrad Geysler, PO Box 89, Cotuit, Massachusetts 02635 USA

Phone: 508-428-8442

Email: <mailto:conradg@cape.com>

Website: <http://www.cape.com/cdt>

"CTS" TOILET

Composting Toilet Systems, PO Box 1928, Newport, Washington 99156-1928, USA

Phone: 1 509 447 3708;

Toll Free: 888 786 4538

Fax: 1 509 447 3708

Email: <mailto:cts@povn.com>

Contact: Joel Jacobsen

Inclined base composting toilet system built from fiberglass. 5 models offered with NSF International certification. Also offer pre-engineered toilet buildings and agent for Sun-Mar composting toilets.

ECOLOGY SERVICES

PO Box 76, Delafield, WI 53018 USA

Phone/Fax: 262-646-4664

Contact: Mike Mangan

Sell and install composting toilets, graywater systems, and rainwater collection systems. Sunmar and Phoenix toilets.

ECO-TECH/VERA ECOS, INC.

P.O. Box 1313, Concord, MA 01742-1313 USA

Phone: 978-369-3951

Fax: 978-369-2484

Email: [watercon@igc.org](mailto:watercon@igc.org)

Website: <http://www.ecologicalengineering.com/>

"Tools for low-water living since 1972." Sell a range of products: EcoTech Carousel compost ECO-TECH/VERA (cont.) ing toilet system, as well as composting toilet models from Vera Toga, BioLet, CTS and Sun-Mar; plans for site-built composting toilets; the Septic Protector, vacuum and micro-flush toilets; Washwater Garden graywater system; and related low-water products. Catalog \$2.

JADE MOUNTAIN INC (Agent)

P.O. Box 4616, 717 Poplar, Boulder, CO 80306, USA

Phone: 1 800 442 1972 or 303 449 6601

Fax: 1 303 449 8266

Email: <mailto:info@jademountain.com>

Website: <http://www.jademountain.com/>

You can now download the complete catalog and order online. Supplies a wide range of appropriate technology products (over 6000) and information which includes composting toilets and graywater treatment systems.

LEHMANS HARDWARE AND APPLIANCES (Agent)

One Lehman Circle, P.O. Box 41, Kidron, Ohio 44636, USA

Phone: 330 857 5757

Fax: 330 857 5785

Email: [info@lehmans.com](mailto:info@lehmans.com)

Website: <http://www.lehmans.com/>

Agent for Sunmar, Biolet and Alaskan systems. Store and catalogue mail order sales of products for self-sufficiency. "Serving the Amish and others without electricity with products for simple, self sufficient living since 1955."

MOUNTAIN LION TRADING CO. (Agent)

Sales office: 2404 North Columbus Street Spokane, WA 99207-2126, USA

Phone: 1 509-487-0765 (Voice or Fax)

Email: [cj@mtlion.com](mailto:cj@mtlion.com)

Website: <http://www.mtlion.com/sunmar>

Sell a range of products including Sunmar composting toilets.

REAL GOODS TRADING CO. (Agent)

555 Leslie St, Ukiah, CA. 95482, USA

Phone: 1 707 468 9292

Fax: 1 707 468 9394

Email: <mailto:realgoods@realgoods.com>

Website: <http://www.realgoods.com/>

Sun-mar and Biolet composting toilet agents. Stores in Hopland, CA, Eugene, OR and Amherst, WI.

SMARTER WATER COMPANY

Atlanta, GA USA

Email: [email@smarterwater.com](mailto:email@smarterwater.com)

Website: <http://www.smarterwater.com/>

Southeastern U.S. distributor of composting toilet systems. Agents for Sunmar composting toilet

systems.

### SOILTECH (Agent)

607 East Canal St, Newcomerstown, Ohio, 43832-1207, USA

Phone: 1 614 498 5929

Email: <mailto:soiltech@tusco.net>

Website: <http://web.tusco.net/soiltech>

Contact: Kevin Mills; Distributors of Biolet composting toilets. Also have related products including a mulch starter.

### SOLAR COMPOSTING ADVANCED TOILETS (S.C.A.T.)

Larry Warnberg, PO Box 43, Nahcotta, WA 98637, USA

Phone: 360-665-2926

Email: [warnberg@pacifier.com](mailto:warnberg@pacifier.com)

The Solar Composting Advanced Toilet — S.C.A.T. — is a freestanding complete toilet facility designed to recycle human excrement and urine into a relatively dry and deodorized compost which can be safely and easily applied to the immediately surrounding landscape. The S.C.A.T. is suitable for recreational campsites, vacation cabins, construction sites, agricultural and nursery settings.

### SUN-MAR CORPORATION

600 Main St., Tonawanda, NY 14150-0888 USA

For a Free Catalogue Call: 1 800 461 2461

Email: [compost@sun-mar.com](mailto:compost@sun-mar.com)

Website: <http://www.sun-mar.com/>

### SUPER TOILETS USA

John Flaherty, 10 Seaside Place, Norwalk, CT 06855 USA

Phone/Fax: 203-831-9810

### OWNER BUILT

#### APPALACHIA SCIENCE IN THE PUBLIC INTEREST

50 Lair St., Mt. Vernon, KY 40456 USA

Phone: 606 256 0077 (main office)

Fax: 606 256 2779

Email: [aspi@kih.net](mailto:aspi@kih.net)

Website: <http://www.kih.net/aspi>

Contact: Jack Kiefer

ASPI has technical bulletins on composting toilets and constructed wetlands including schematics for a compost toilet which ASPI designed, and for a constructed wetland.

## BIG BATCH COMPOSTING TOILET EKAT (East Kentucky Appropriate Technologies)

Executive Director, 150 Gravel Lick Branch Road Dreyfus, KY 40385, USA

Phone: 606 986-6146

Contact: Robert J. Fairchild

Another owner-build system that utilizes readily available materials. It is designed around a large rolling polyethylene dump cart with air pipes of PVC placed into it. Two are used, one 'resting' while the other is filled. EKAT is a non-profit organization which provides engineering assistance with appropriate technology projects to families and groups in central Appalachia. The 'Big batch composting toilet' plans are \$7.

## ECO-TECH/VERA ECOS, INC.

P.O. Box 1313, Concord, MA 01742-1313 USA

Phone: 978-369-3951

Fax: 978-369-2484

Email: [watercon@igc.org](mailto:watercon@igc.org)

Website: <http://www.ecologicalengineering.com/>

Plans for site-built composting toilets (see previous US listing).

## ELEMENTAL SOLUTIONS

Oaklands Park, Newnham-on-Severn Gloucestershire, GL14 1EF, UK

Phone: 01594 516063

Fax: 01594 516821

Email: [mark.es@aecb.net](mailto:mark.es@aecb.net)

Contact: Mark Moodie

Kits include plans of the chamber recommended for a domestic situation in the UK climate. Includes ceramic pedestal, internal fittings of the tank, water proof 12V or 230V fan (uses ~3W) and power supply where necessary, construction and maintenance manual.

## GARRY SCOTT COMPOST TOILET SYSTEMS

Mullumbimby NSW, 2482, Australia

Phone/Fax: 61 2 6684 3468

Email: [mailto:compost@mullum.com.au](mailto:mailto:compost@mullum.com.au)

Ownerbuilder assistance with consultation, components, plans and books.

## LONG BRANCH ENVIRONMENTAL EDUCATION CENTER

Big Sandy Mush Creek; POB 369; Leicester, NC 28748 USA

Contact: Paul Gallimore, Director

Phone: 828-683-3662

Fax: 828-683-9211

Email: [paulg@buncombe.main.nc.us](mailto:paulg@buncombe.main.nc.us)

Website: <http://main.nc.us/LBEEC>

### **SOLAR COMPOSTING ADVANCED TOILET (S.C.A.T.)**

Larry Warnberg, PO Box 43, Nahcotta, WA 98637, USA

Phone: 360 665 2926

Email: [warnberg@pacifier.com](mailto:warnberg@pacifier.com)

Solar composting toilet plans ([see previous US listing](#))

### **STAN SLAUGHTER 55 GALLON DRUM COMPOST TOILET - GUIDEBOOK AND PLANS**

Stan Slaughter, Tall Oak Productions, Pilar Route, Box 11B, Embudo, NM 87531, USA

Phone: 888 484 4477

Fax: 505 758 0201

Website: <http://www.stanslaughter.com/>

Also has a great audio tape: Rot N' Roll. Offers music/educational programs and a new card game, "Compost Gin."

### **"SUNNY JOHN" SOLAR MOLDERING TOILET CONSTRUCTION PLANS - \$20/POSTPAID**

John Cruickshank, 5569 North County Road 29, Loveland CO 80538

Email: [hobbitouse@compuserve.com](mailto:hobbitouse@compuserve.com)

Website: <http://ourworld.compuserve.com/homepages/hobbitouse>

## **COMPOST THERMOMETERS**

### **REOTEMP**

11568 Sorrento Valley Road, Suite 10 San Diego, CA 92121 USA

Phone: 619 481 7737

Toll free: 1-800-648-7737

Fax: 619 481 7415

Email: [reotemp@reotemp.com](mailto:reotemp@reotemp.com)

Website: <http://www.reotemp.com/>

## **BACKYARD COMPOST BINS**

### **COVERED BRIDGE ORGANIC**

PO Box 91, Jefferson, OH 44047 USA

Phone: 440 576 5515

### **GARDNER EQUIPMENT**

PO Box 106, Juneau, WI 53039 USA

Toll Free: 800 393 0333

### **GEDYE COMPOST BINS**

555 S. Sunrise Way, Ste. 200, Palm Springs, CA 92262 USA

Phone: 760 325 1035

Fax: 760 778 5383

#### HARMONIOUS TECHNOLOGIES

PO Box 1716, Sebastopol, CA 95437 USA

Phone: 707 823 1999

Fax: 707 823 2424

Website: <http://www.homecompost.com/>

Bins made from 100% recycled plastic.

#### PALMOR PRODUCTS

PO Box 38, Thorntown, IN 46071 USA

Phone: 800 872 2822

Fax: 765 436 2490

Website: <http://www.trac-vac.com/>

#### PLASTOPAN NORTH AMERICA, INC.

812 E 59th St., Los Angeles, CA 90001 USA

Phone: 323 231 2225

Fax: 323 231 2068

Website: <http://www.plastopan.com/>

#### PRECISION-HUSKY

Equipment Division POD 507, Leeds, AL 35094 USA

Phone: 205 640 5181

Fax: 205 640 1147

Website: <http://www.precisionhusky.com/>

#### PRESTO PRODUCTS CO.

PO Box 2399, Appleton, WI 54913 USA

Phone: 920 738 0986

Fax: 920 738 1458

#### RECYCLED PLASTICS MARKETING, INC.

2829 152nd Ave. NE, Redmond, WA 98052 USA

Phone: 800 867 3201

Fax: 425 867 3282

Website: <http://www.rrpm.com/>

#### C.E. SHEPHERD CO., INC.

PO Box 9445, Houston, TX 77261 USA

Phone: 713 928 3763



Fax: 713 928 2324

Website: <http://www.ceshepherd.com/>

#### SMITH AND HAWKEN

117 East Strawberry Dr., Mill Valley, CA 94941 USA

Phone: 415 383 4415

Fax: 415 383 8010

Website: <http://www.smithandhawken.com/>

#### SWING AND SLIDE CORPORATION (SHAPE PRODUCTS)

1212 Barberry Dr., Janesville, WI 53545 USA

Phone: 800 888 1232

Fax: 608 755 4763

#### THE WILMARC CO.

225 W Grant St., Thorntown, IN 46071 USA

Ph: 765 436 7089

Fax: 765 436 2634

#### COMPOST TESTING LABS

##### WOODS END AGRICULTURAL INSTITUTE, INC.

PO Box 297, Mt. Vernon, ME 04352 USA

Phone: 207-293-2457

Toll Free: 800-451-0337

Fax: 207-293-2488

Email: [info@woodsend.org](mailto:info@woodsend.org)

Website: <http://www.woodsend.org/>

Ascaris and coliform testing as well as full nutrient tests. Sells the Solvita(R) Maturity Test Kit which is now approved in CA, CT, IL, MA, ME, NJ, NM, OH, TX, and WA. Has developed a soil-respiration test kit that is approved by the USDA for soil quality investigations.

##### WOODS END EUROPE AUC

Agrar und Umwelt-Consult GmbH: Augustastrasse 9 D-53173 Bonn, Germany

Phone: 049 0228 343246

Fax: 049 0228 343237

Officially certified for pathogen survival testing. Sells the Solvita(R) Maturity Test Kit which is now approved in CA, CT, IL, MA, ME, NJ, NM, OH, TX, and WA.

##### CONTROL LAB. INC.

42 Hangar Way, Watsonville, CA 95076 USA

Phone: 831 724 5422

Fax: 831 724 3188

## **AUDIO TAPES**

### **ROT 'N ROLL**

Stan Slaughter, Tall Oak Productions, Pilar Route, Box 11B, Embudo, NM 87531 USA

Phone: 888 484 4477

Fax: 505 758 0201

Website: <http://www.stanslaughter.com/>

### **SONGS FOR THE COMPOST PILE**

Dreams and Bones Performance Company, Jake Weinstein, Rainbow Recycling, 810 State St., New Haven, CT 06511 USA

Phone: 203 865 6507

## **INTERNET LINKS**

### **EARTHWISE PUBLICATIONS**

High Walk House, Kirkby Malzeard, Ripon HG4 3RY England

Phone + 44 01765 658786

Fax on request.

Email: [earthwise@earthwise.nwnet.co.uk](mailto:earthwise@earthwise.nwnet.co.uk)

World of Composting Toilets: <http://www.compostingtoilet.org/>

International Composting Toilet News: <http://www.nwnet.co.uk/earthwise/journal>

Rot Web: [http://net.indra.com/~topsoil/Compost\\_Menu.html](http://net.indra.com/~topsoil/Compost_Menu.html)

Compost Resource Page: <http://www.oldgrowth.org/compost/humanure.html>

Humanure Forum: [http://www.oldgrowth.org/compost/forum\\_humanure1](http://www.oldgrowth.org/compost/forum_humanure1)

Canadian Composting Toilet Website: <http://www.cityfarmer.org/comptoilet64.html#toilet>

Composting council: <http://www.compostingcouncil.org/>

### **Others of interest:**

[http://www.cfe.cornell.edu/compost/Composting\\_homepage.html](http://www.cfe.cornell.edu/compost/Composting_homepage.html)

<http://www.composter.com/>

<http://www.history.rochester.edu/class/compost/compost.html>

### **Vermicomposting:**

<http://www.humic.com/>

<http://www.worndigest.org/>

<http://www.wormwoman.com/>

<http://www.vermint.com.au/>

<http://www.wormpage.com/>

<http://www.allthingsorganic.com/>

<http://www.worm-publications.com/>

<http://www.vermitechnology.com/>

*Source: The Humanure Handbook. Jenkins Publishing, PO Box 607, Grove City, PA 16127. To order, phone: 1-800-639-4099.*

<http://www.jenkinspublishing.com/>

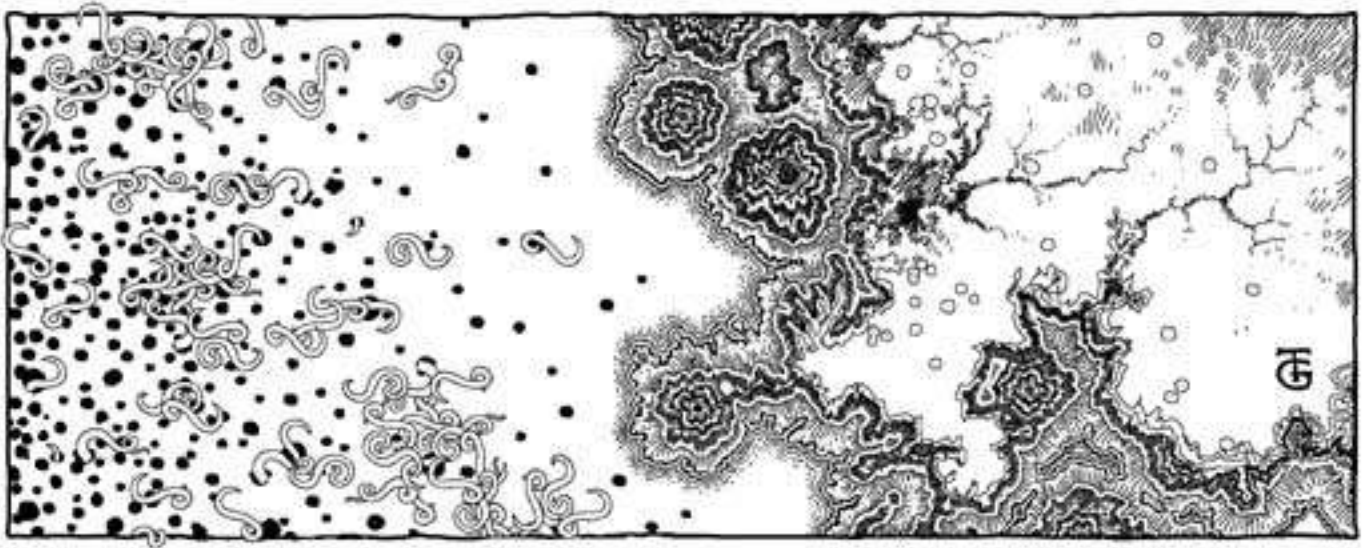
---

**MENU: [HOME](#) » [Reconstruction](#) » [Recovery](#) » [Renewal](#) » [Survival](#) » [Humanure Content](#)**

---

---

## WORMS AND DISEASE



*“A well-made compost heap steams like a tea kettle and gets hot enough to destroy all pathogens that may be present when one uses human sewage. An extraordinary device when one thinks about it. Thermophilic bacteria. Bacteria that can live and flourish in temperatures hot enough to cook an egg. How can they survive in such heat? Truly the tricks of nature are extraordinary!”*

Robert S. deRopp

I well remember in early 1979 when I first informed a friend that I intended to compost my own manure and grow my own food with it. *“Oh my God, you can’t do that!”* she cried.

“Why not?”

“Worms and disease!”

Of course. What else would a fecophobe think of when one mentions using humanure as a fertilizer?

A young English couple was visiting me one summer after I had been composting humanure for about six years. One evening, as dinner was being prepared, the couple suddenly understood the horrible reality of their situation: the food they were about to eat was *recycled shit*. When this “fact” dawned upon them, it seemed to set off some kind of instinctive alarm in their minds, possibly inherited directly from Queen Victoria. *“We don’t want to eat shit!”* they informed me (that’s an exact quote), as if in preparing dinner I

was simply defecating on plates and setting them on the table. Never mind that the food was delicious. It was the *thought* of it that mattered.

*Fecophobia* is alive and well and currently afflicting about a billion westerners. One common misconception is that fecal material, when composted, remains fecal material. *It does not.* Humanure comes from the earth, and through the miraculous process of composting, is converted back into earth. When the composting process is finished, the end product is humus, not crap, and it is useful in growing food. My friends didn't understand this; despite my attempts to clarify the matter for their benefit, they chose to cling to their misconceptions. Apparently, some fecophobes will always remain fecophobes.

Allow me to make a radical suggestion: humanure is not dangerous. More specifically, it is not any more dangerous than the body from which it is excreted. The danger lies in what we *do* with humanure, not in the material itself. To use an analogy, a glass jar is not dangerous either. However, if we smash it on the kitchen floor and walk on it with bare feet, we will be harmed. If we use a glass jar improperly and dangerously, we will suffer for it, but that's no reason to condemn glass jars. When we discard humanure as a waste material and pollute our soil and water supplies with it, we are using it improperly, and that is where the danger lies. When we constructively recycle humanure by composting, it enriches our soil, and, like a glass jar, actually makes life easier for us.

Not all cultures think of human excrement in a negative way. For example, swear-words meaning excrement do not seem to exist in the Chinese language. The Tokyo bureau chief for the New York Times explains why: "*I realized why people [in China] did not use words for excrement in a negative way. Traditionally, there was nothing more valuable to a peasant than human waste.*" <sup>1</sup> Calling someone a "humanure head" just doesn't sound like an insult. "Humanure for brains" doesn't work either. If you told someone they were "full of humanure," they'd probably agree with you. "Shit," on the other hand, is a substance that is widely denounced and has a long history of excoriation in the western world. Our ancestor's historical failure to responsibly recycle the substance caused monumental public health headaches. Consequently, the attitude that humanure *itself* is terribly dangerous has been embraced and promulgated up to the present day.

For example, a recently published book on the topic of recycling "human waste" begins with the following disclaimer: "*Recycling human waste can be extremely dangerous to your health, the health of your community and the health of the soil. Because of the current limits to general public knowledge, [we] strongly discourage the recycling of human waste on an individual or community basis at this time and cannot assume responsibility for the results that occur from practicing any of the methods described in this publication.*" The author adds, "*Before experimenting, obtain permission from your local health authority since the health risks are great.*" The author then elaborates upon a human "waste" composting methodology which includes segregating urine from feces, collecting the manure in 30 gallon plastic containers, and using straw rather than sawdust as a cover material in the toilet.<sup>2</sup> All three of these procedures are ones I would discourage based on my 20 years of humanure composting experience (no need to go to the bother of segregating urine; a 30 gallon container is way too big and heavy to be able to easily handle; and *sawmill* sawdust does, in fact, work beautifully in a composting toilet. These issues will be thoroughly discussed in the next chapter).

I had to ask myself why an author writing a book on recycling humanure would “*strongly discourage the recycling of human waste,*” which seems counterproductive, to say the least. If I didn’t already know that recycling humanure was easy and simple, I might be totally petrified at the thought of attempting such an “*extremely dangerous*” undertaking after reading that book. And the last thing anyone wants to do is get the local health authorities involved. If there is anyone who knows nothing about composting humanure, it’s probably the local health authority, who receives no such training. I had to read between the lines of the book to find an explanation.

It seems that the author was somehow associated with the “Bio-Dynamic” agricultural movement, founded by Dr. Rudolf Steiner. Dr. Steiner has quite some following around the world, and many of his teachings are followed almost religiously by his disciples. The Austrian scientist and spiritual leader had his own opinions about the recycling of humanure, based as it were on intuition rather than on experience or science. He insisted that humanure must only be used to fertilize soil used to grow plants to feed animals *other* than humans. The manure from those animals can then be used to fertilize soil to grow plants for human consumption. According to Steiner, humans must *never* get any closer to a direct human nutrient cycle than that. Otherwise, they will suffer “brain damage and nervous disorders.” Steiner further warned against using “lavatory fluid,” including human urine, which “should never be used as a fertilizer, no matter how well-processed or aged it is.”<sup>3</sup> Steiner, quite frankly, was ill-informed, incorrect, and severely fecophobic, and that fecophobia has, unfortunately, rubbed off on some of his followers. It is unfortunate that sensational, fear-motivated warnings regarding humanure recycling continue to be published.

But, it’s nothing new, and it has historically been based upon ignorance, which is a widespread problem. At one time, for example, doctors insisted that human excrement should be an important and necessary part of one’s personal environment. They argued that, “*Fatal illness may result from not allowing a certain amount of filth to remain in [street] gutters to attract those putrescent particles of disease which are ever present in the air.*” At that time, toilet contents were simply dumped in the street. Doctors believed that the germs in the air would be drawn to the filth in the street and therefore away from people. This line of reasoning so influenced the population that many homeowners built their outhouses attached to their kitchens in order to keep their food germ-free and wholesome.<sup>4</sup> The results were just the opposite — flies made frequent trips between the toilet contents and the food table.

By the early 1900s, the US government was condemning the use of humanure for agricultural purposes, warning of dire consequences, including death, to those who would dare to do otherwise. A 1928 US Department of Agriculture bulletin made the risks crystal clear: “*Any spittoon, slop pail, sink drain, urinal, privy, cesspool, sewage tank, or sewage distribution field is a potential danger. A bit of spit, urine, or feces the size of a pin head may contain many hundred germs, all invisible to the naked eye and each one capable of producing disease. These discharges should be kept away from the food and drink of [humans] and animals. From specific germs that may be carried in sewage at any time, there may result typhoid fever, tuberculosis, cholera, dysentery, diarrhea, and other dangerous ailments, and it is probable that other maladies may be traced to human waste. From certain animal parasites or their eggs that may be carried in sewage there may result intestinal worms, of which the more common are the*

*hookworm, roundworm, whipworm, eelworm, tapeworm, and seat worm.*

*Disease germs are carried by many agencies and unsuspectingly received by devious routes into the human body. Infection may come from the swirling dust of the railway roadbed, from contact with transitory or chronic carriers of disease, from green truck [vegetables] grown in gardens fertilized with night soil or sewage, from food prepared or touched by unclean hands or visited by flies or vermin, from milk handled by sick or careless dairymen, from milk cans or utensils washed with contaminated water, or from cisterns, wells, springs, reservoirs, irrigation ditches, brooks, or lakes receiving the surface wash or the underground drainage from sewage-polluted soil.”*

The bulletin continues, *“In September and October, 1899, 63 cases of typhoid fever, resulting in five deaths, occurred at the Northampton (Mass.) insane hospital. This epidemic was conclusively traced to celery, which was eaten freely in August and was grown and banked in a plot that had been fertilized in the late winter or early spring with the solid residue and scrapings from a sewage filter bed situated on the hospital grounds.”*

And to drive home the point that human waste is highly dangerous, the bulletin adds, *“Probably no epidemic in American history better illustrates the dire results that may follow one thoughtless act than the outbreak of typhoid fever at Plymouth, Pa., in 1885. In January and February of that year the night discharges of one typhoid fever patient were thrown out upon the snow near his home. These, carried by spring thaws into the public water supply, caused an epidemic running from April to September. In a total population of about 8,000, 1,104 persons were attacked by the disease and 114 died.”*

The government bulletin insisted that the use of human excrement as fertilizer was both “dangerous” and “disgusting.” It warned that, *“under no circumstances should such wastes be used on land devoted to celery, lettuce, radishes, cucumbers, cabbages, tomatoes, melons, or other vegetables, berries, or low-growing fruits that are eaten raw. Disease germs or particles of soil containing such germs may adhere to the skins of vegetables or fruits and infect the eater.”* The bulletin summed it up by stating, *“Never use [human] waste to fertilize or irrigate vegetable gardens.”* The fear of human excrement was so severe it was advised that the contents of bucket toilets be burned, boiled, or chemically disinfected, then buried in a trench.<sup>5</sup>

This degree of fecophobia, fostered and spread by authoritative government publications and by spiritual leaders who knew of no constructive alternatives to waste disposal, still maintains a firm grip on the western psyche. It may take a long time to eliminate. A more constructive attitude is displayed by scientists with a broader knowledge of the subject of recycling humanure for agricultural purposes. They realize that the benefits of proper humanure recycling “far outweigh any disadvantages from the health point of view.”<sup>6</sup>

## THE HUNZAS

It’s already been mentioned that entire civilizations have recycled humanure for thousands of years. That

should provide a fairly convincing testimony about the usefulness of humanure as an agricultural resource. Many people have heard of the “Healthy Hunzas,” a people in what is now a part of Pakistan who reside among the Himalayan peaks, and routinely live to be 120 years old. The Hunzas gained fame in the United States during the 1960s health food era, at which time several books were written about the fantastic longevity of this ancient people. Their extraordinary health has been attributed to the quality of their overall lifestyle, including the quality of the natural food they eat and the soil it’s grown on. Few people, however, realize that the Hunzas also compost their humanure and use it to grow their food. They’re said to have virtually no disease, no cancer, no heart or intestinal trouble, and they regularly live to be over a hundred years old while *“singing, dancing and making love all the way to the grave.”*

According to Tompkins (1989), *“In their manuring, the Hunzakuts return everything they can to the soil: all vegetable parts and pieces that will not serve as food for humans or beast, including such fallen leaves as the cattle will not eat, mixed with their own seasoned excrement, plus dung and urine from their barns. Like their Chinese neighbors, the Hunzakuts save their own manure in special underground vats, clear of any contaminable streams, there to be seasoned for a good six months. Everything that once had life is given new to life through loving hands.”* <sup>7</sup> (emphasis mine)

Sir Albert Howard wrote in 1947, *“The Hunzas are described as far surpassing in health and strength the inhabitants of most other countries; a Hunza can walk across the mountains to Gilgit sixty miles away, transact his business, and return forthwith without feeling unduly fatigued.”* Sir Howard maintains that this is illustrative of the vital connection between a sound agriculture and good health, insisting that the Hunzas have evolved a system of farming which is perfect. He adds, *“To provide the essential humus, every kind of waste [sic], vegetable, animal and human, is mixed and decayed together by the cultivators and incorporated into the soil; the law of return is obeyed, the unseen part of the revolution of the great Wheel is faithfully accomplished.”* <sup>8</sup> Sir Howard’s view is that soil fertility is the real basis of public health.

A medical professional associated with the Hunzas claimed, *“During the period of my association with these people I never saw a case of asthenic dyspepsia, of gastric or duodenal ulcer, of appendicitis, of mucous colitis, of cancer . . . Among these people the abdomen over-sensitive to nerve impressions, to fatigue, anxiety, or cold was unknown. Indeed their buoyant abdominal health has, since my return to the West, provided a remarkable contrast with the dyspeptic and colonic lamentations of our highly civilized communities.”*

Sir Howard adds, *“The remarkable health of these people is one of the consequences of their agriculture, in which the law of return is scrupulously obeyed. All their vegetable, animal and human wastes [sic] are carefully returned to the soil of the irrigated terraces which produce the grain, fruit, and vegetables which feed them.”* <sup>9</sup>

The Hunzas composted their organic material, thereby recycling all of it. This actually enhanced their personal health and the health of their community. The US Department of Agriculture was apparently unaware of the effective natural process of composting in 1928 when they described the recycling of



humanure as “dangerous and disgusting.” No doubt the USDA would have confused the Hunzas, who had for centuries safely and constructively engaged in such recycling.

## PATHOGENS

[Much of the following information is adapted from Appropriate Technology for Water Supply and Sanitation, by Feachem et al., World Bank, 1980.<sup>10</sup> This comprehensive work cites 394 references from throughout the world, and was carried out as part of the World Bank’s research project on appropriate technology for water supply and sanitation.]

Clearly, even the primitive composting of humanure for agricultural purposes does not necessarily pose a threat to human health, as evidenced by the Hunzas. Yet, fecal *contamination* of the environment certainly can pose a threat to human health. Feces can harbor a host of disease organisms which can contaminate the environment to infect innocent people when human excrement is discarded as a waste material. In fact, even a healthy person apparently free of disease can pass potentially dangerous pathogens through their fecal material, simply by being a carrier. The World Health Organization estimates that 80% of all diseases are related to inadequate sanitation and polluted water, and that half of the world’s hospital beds are occupied by patients who suffer from water-related diseases.<sup>11</sup> As such, the composting of humanure would certainly seem like a worthwhile undertaking worldwide.

The following information is not meant to be alarming. It’s included for the sake of thoroughness, and to illustrate the need to *compost* humanure, rather than to try to use it raw for agricultural purposes. When the composting process is side-stepped and pathogenic waste is issued into the environment, various diseases and worms can infect the population living in the contaminated area. This fact has been widely documented.

For example, consider the following quote from Jervis (1990): “*The use of night soil [raw human fecal material and urine] as fertilizer is not without its health hazards. Hepatitis B is prevalent in Dacaiyuan [China], as it is in the rest of China. Some effort is being made to chemically treat [humanure] or at least to mix it with other ingredients before it is applied to the fields. But chemicals are expensive, and old ways die hard. Night soil is one reason why urban Chinese are so scrupulous about peeling fruit, and why raw vegetables are not part of the diet. Negative features aside, one has only to look at satellite photos of the green belt that surrounds China’s cities to understand the value of night soil.*”<sup>12</sup>

On the other hand, “worms and disease” are not spread by properly prepared compost, nor by healthy people. There is no reason to believe that the manure of a healthy person is dangerous unless left to accumulate, pollute water with intestinal bacteria, or breed flies and/or rats, all of which are the results of negligence or bad customary habits. It should be understood that the breath one exhales can also be the carrier of dangerous pathogens, as can one’s saliva and sputum. The issue is confused by the notion that if something is potentially dangerous, then it is always dangerous, which is not true. Furthermore, it is generally not understood that the carefully managed thermophilic composting of humanure converts it into a sanitized agricultural resource. No other system of fecal material and urine recycling or disposal can achieve this without the use of dangerous chemical poisons or a high level of technology and energy

consumption.

Even urine, usually considered sterile, can contain disease germs (see Table 7.1). Urine, like humanure, is valuable for its soil nutrients. It is estimated that one person's annual urine output contains enough soil nutrients to grow grain to feed that person for a year.<sup>13</sup> Therefore, it is just as important to recycle urine as it is to recycle humanure, and composting provides an excellent means for doing so.

The pathogens that can exist in human feces can be divided into four general categories: *viruses*, *bacteria*, *protozoa*, and *worms (helminths)*.

## VIRUSES

First discovered in the 1890s by a Russian scientist, viruses are among the simplest and smallest of life forms. Many scientists don't even consider them to be organisms. They are much smaller and simpler than bacteria (some viruses are parasitic to bacteria), and the simplest form may consist only of an RNA molecule. By definition, a virus is an entity which contains the information necessary for its own replication, but does not possess the physical elements for such replication — they have the software, but not the hardware. In order to reproduce, therefore, viruses rely on the hardware of the infected host cell, which is re-programmed by the virus in order to reproduce viral nucleic acid. As such, viruses cannot reproduce outside the host cell.<sup>14</sup>

There are more than 140 types of viruses worldwide that can be passed through human feces, including polioviruses, coxsackieviruses (causing meningitis and myocarditis), echoviruses (causing meningitis and enteritis), reovirus (causing enteritis), adenovirus (causing respiratory illness), infectious hepatitis (causing jaundice), and others (see Table 7.3). During periods of infection, one hundred million to one trillion viruses can be excreted with each gram of fecal material.<sup>15</sup>

## BACTERIA

Of the pathogenic bacteria, the genus *Salmonella* is significant because it contains species causing typhoid fever, paratyphoid, and gastrointestinal disturbances. Another genus of bacteria, *Shigella*, causes dysentery. Mycobacteria cause tuberculosis (see Table 7.4). However, according to Gotaas, pathogenic bacteria “are unable to survive temperatures of 55°-60°C for longer than 30 minutes to one hour.”<sup>16</sup>

## PROTOZOA

The pathogenic protozoa include *Entamoeba histolytica* (causing amoebic dysentery), and members of the Hartmanella-Naegleria group (causing meningo-encephalitis) (see Table 7.5). The cyst stage in the life cycle of protozoa is the primary means of dissemination as the amoeba die quickly once outside the human body. Cysts must be kept moist in order to remain viable for any extended period.<sup>17</sup>

## PARASITIC WORMS

Finally, a number of parasitic worms pass their eggs in feces, including hookworms, roundworms (*Ascaris*), and whipworms (see Table 7.6). Various researchers have reported 59 to 80 worm eggs in sampled liters of sewage. This suggests that billions of pathogenic worm eggs may reach an average wastewater treatment plant daily. These eggs tend to be resistant to environmental conditions due to a thick outer covering,<sup>18</sup> and they are extremely resistant to the sludge digestion process common in wastewater treatment plants. Three months exposure to anaerobic sludge digestion processes appears to have little effect on the viability of *Ascaris* eggs; after six months, 10% of the eggs may still be viable. Even after a year in sludge, some viable eggs may be found.<sup>19</sup> In 1949, an epidemic of roundworm infestation in Germany was directly traced to the use of raw sewage to fertilize gardens. The sewage contained 540 *Ascaris* eggs per 100 ml, and over 90% of the population became infected.<sup>20</sup>

If there are about 59 to 80 worm eggs in a liter sample of sewage, then we could reasonably estimate that there are 70 eggs per liter, or 280 eggs per gallon to get a rough average. That means approximately 280 pathogenic worm eggs per gallon of wastewater enter wastewater treatment plants. My local wastewater treatment plant serves a population of eight thousand people and collects about 1.5 million gallons of wastewater daily. That means there could be 420 million worm eggs entering the plant each day and settling into the sludge. In a year's time, over 153 *billion* parasitic eggs can pass through my local small-town wastewater facility. Let's look at the worst-case scenario: all the eggs survive in the sludge because they're resistant to the environmental conditions at the plant. During the year, 30 tractor-trailer loads of sludge are hauled out of the local facility. Each truckload of sludge could theoretically contain over 5 *billion* pathogenic worm eggs, en route to maybe a farmer's field, but probably a landfill.

It is interesting to note that roundworms co-evolved over millennia as parasites of the human species by taking advantage of the long-standing human habit of defecating on soil. Since roundworms live in the human intestines, but require a period in the soil for their development, their species is perpetuated by our bad habits. If we humans never allowed our excrement to come in contact with soil, and if we instead thermophilically composted it, the parasitic species known as *Ascaris lumbricoides*, a parasite that has plagued us for perhaps hundreds of thousands of years, would soon become extinct. The human species is finally evolving to the extent that we are beginning to understand compost and its ability to destroy parasites. We need to take that a step further and entirely prevent our excrement from polluting the environment. Otherwise, we will continue to be outsmarted by the parasitic worms that rely on our ignorance and carelessness for their own survival.

## INDICATOR PATHOGENS

*Indicator pathogens* are pathogens whose detectable occurrence in soil or water serves as evidence that fecal contamination exists.

The astute reader will have noticed that many of the pathogenic worms listed in Table 7.6 are not found in the United States. Of those that are, the *Ascaris lumbricoides* (roundworm) is the most persistent, and can serve as an indicator for the presence of pathogenic helminths in the environment.

A single female roundworm may lay as many as 27 million eggs in her lifetime.<sup>21</sup> These eggs are protected by an outer covering that is resistant to chemicals and enables the eggs to remain viable in soil for long periods of time. The egg shell is made of five separate layers: an outer and inner membrane, with three tough layers in between. The outer membrane may become partially hardened by hostile environmental influences.<sup>22</sup> The reported viability of roundworm eggs (*Ascaris ova*) in soil ranges from a couple of weeks under sunny, sandy conditions,<sup>23</sup> to two and a half years,<sup>24</sup> four years,<sup>25</sup> five and a half years,<sup>26</sup> or even ten years<sup>27</sup> in soil, depending on the source of the information. Consequently, the *eggs* of the roundworm seem to be the best indicator for determining if parasitic worm pathogens are present in compost. In China, current standards for the agricultural reuse of humanure require an *Ascaris* mortality of greater than 95%.

*Ascaris* eggs develop at temperatures between 15.5°C (59.90° F) and 35°C (95° F), but the eggs disintegrate at temperatures above 38°C (100.40° F).<sup>28</sup> The temperatures generated during thermophilic composting can easily exceed levels necessary to destroy roundworm eggs.

One way to determine if the compost you're using is contaminated with viable roundworm eggs is to have a stool analysis done at a local hospital. If your compost is contaminated and you're using the compost to grow your own food, then there will be a chance that you've contaminated yourself. A stool analysis will reveal whether that is the case or not. Such an analysis cost about \$41.00 in Pennsylvania (USA) in 1993, and \$33 in 1999. I subjected myself to two stool examinations over a period of two years as part of the research for this book. I had been composting humanure for fifteen years at the time of the testings, and I had used all of the compost in my food gardens. Hundreds of other people had also used my toilet over the years, potentially contaminating it with *Ascaris*. Yet, both stool examinations were completely negative.

*Indicator bacteria* include fecal coliforms, which reproduce in the intestinal systems of warm blooded animals (see Table 7.7). If one wants to test a water supply for fecal contamination, then one looks for fecal coliforms, usually *Escherichia coli*. *E. coli* is one of the most abundant intestinal bacteria in humans; over 200 specific types exist. Although some of them can cause disease, most are harmless.<sup>29</sup> The absence of *E. coli* in water indicates that the water is free from fecal contamination.

Water tests often determine the level of *total coliforms* in the water, reported as the number of coliforms per 100 ml. Such a test measures *all* species of the coliform group and is not limited to species originating in warm-blooded animals. Since some coliform species come from the soil, the results of this test are not always indicative of fecal contamination in a stream analysis. However, this test can be used for ground water supplies, as no coliforms should be present in ground water unless it has been contaminated by a warm-blooded animal.

*Fecal* coliforms do not multiply outside the intestines of warm-blooded animals, and their presence in water is unlikely unless there is fecal pollution. They survive for a shorter time in natural waters than the coliform group as a whole, therefore their presence indicates relatively recent pollution. In domestic sewage, the fecal coliform count is usually 90% or more of the total coliform count, but in natural

streams, fecal coliforms may contribute 10-30% of the total coliform density. Almost all natural waters have a presence of fecal coliforms, since all warm-blooded animals excrete them. Most states in the U.S. limit the fecal coliform concentration allowable in waters used for water sports to 200 fecal coliforms per 100 ml.

Bacterial analyses of drinking water supplies are routinely provided for a small fee (in 1994 around \$20.00) by agricultural supply firms, water treatment companies, or private labs.

## **PERSISTENCE OF PATHOGENS IN SOIL, CROPS, MANURE, AND SLUDGE**

According to Feachem et al. (1980), the persistence of fecal pathogens in the environment can be summarized as follows:

### **IN SOIL**

Survival times of pathogens in soil are affected by soil moisture, pH, type of soil, temperature, sunlight, and organic matter. Although fecal coliforms can survive for several years under optimum conditions, a 99% reduction is likely within 25 days in warm climates (see Figure 7.1). *Salmonella* bacteria may survive for a year in rich, moist, organic soil, although 50 days would be a more typical survival time. Viruses can survive up to three months in warm weather, and up to six months in cold. Protozoan cysts are unlikely to survive for more than ten days. Roundworm eggs can survive for several years.

The viruses, bacteria, protozoa, and worms that can be passed in human excrement all have limited survival times outside of the human body. Let's take a look at their survival times when deposited raw into soil (refer to Tables 7.8 through 7.12).

### **SURVIVAL OF PATHOGENS ON CROPS**

Bacteria and viruses cannot penetrate undamaged vegetable skins. Furthermore, pathogens are not taken up in the roots of plants and transported to other portions of the plant.<sup>30</sup> However, pathogens can survive on the surfaces of vegetables, especially root vegetables. Sunshine and low air humidity will promote the death of pathogens. Viruses can survive up to two months on crops but usually live less than one month. Indicator bacteria may persist several months, but usually only last less than one month. Protozoan cysts usually survive less than two days, and worm eggs usually last less than one month. In studies of the survival of *Ascaris* eggs on lettuce and tomatoes during a hot, dry summer, all eggs degenerated enough after 27 to 35 days to be incapable of infection.<sup>31</sup>

Lettuce and radishes in Ohio sprayed with sewage inoculated with Poliovirus I showed a 99% reduction in pathogens after six days; 100% were eliminated after 36 days. Radishes grown outdoors in soil fertilized with fresh typhoid-contaminated feces four days after planting showed a pathogen survival period of less than 24 days. Tomatoes and lettuce contaminated with a suspension of roundworm eggs showed a 99% reduction in eggs in 19 days and a 100% reduction in four weeks. These tests indicate that

if there is any doubt about pathogen contamination of compost, the compost should be applied to long-season crops at the time of planting so that sufficient time ensues for the pathogens to die before harvest.

## PATHOGEN SURVIVAL IN SLUDGE AND FECES/URINE

Viruses can survive up to five months, but usually less than three months in sludge and night soil. Indicator bacteria can survive up to five months, but usually less than four months. Salmonellae survive up to five months, but usually less than one month. Tubercle bacilli survive up to two years, but usually less than five months. Protozoan cysts survive up to one month, but usually less than ten days. Worm eggs vary depending on species, but roundworm eggs may survive for many months.

## PATHOGEN TRANSMISSION THROUGH VARIOUS TOILET SYSTEMS

It is evident that human excrement possesses the capability to transmit various diseases. For this reason, it should also be evident that the composting of humanure is a serious undertaking and should not be done in a frivolous, careless, or haphazard manner. The pathogens that may be present in humanure have various survival periods outside the human body and maintain varied capacities for re-infecting people. This is why the *careful management* of a thermophilic compost system is important. Nevertheless, there is no proven, natural, low-tech method for destroying human pathogens in organic refuse that is as successful and accessible to the average human as well-managed thermophilic composting.

But what happens when the compost is not well-managed? How dangerous is the undertaking when those involved do not make an effort to ensure that the compost maintains thermophilic temperatures? In fact, this is normally what happens in most owner-built and commercial composting toilets. Thermophilic composting does not occur in owner-built toilets because the people responsible often make no effort to create the organic blend of ingredients and the environment needed for such a microbial response. In the case of most commercial composting toilets, thermophilic composting is not even intended, as the toilets are designed to be dehydrators rather than thermophilic composters.

On several occasions, I have seen simple collection toilet systems (sawdust toilets) in which the compost was simply dumped in an outdoor pile, not in a bin, lacking urine (and thereby moisture), and not layered with the coarse organic material needed for air entrapment. Although these piles of compost did not give off unpleasant odors (most people have enough sense to instinctively cover odorous organic material in a compost pile), they also did not necessarily become thermophilic (their temperatures were never checked). People who are not very concerned about working with and managing their compost are usually willing to let the compost sit for years before use, if they use it at all. Persons who are casual about their composting tend to be those who are comfortable with their own state of health and therefore do not fear their own excrement. As long as they are combining their humanure with a carbonaceous material and letting it compost, thermophilically or not, for at least a year (an additional year of aging is recommended), they are very unlikely to be creating any health problems, despite the rantings of fecophobes. What happens to these casually constructed compost piles? Incredibly, after a couple of years, they turn into quite lovely humus and, if left entirely alone, will simply become covered with

vegetation and disappear back into the earth. I have seen it with my own eyes.

A different situation occurs when humanure from a highly pathogenic population is being composted. Such a population would be the residents of a hospital in an underdeveloped country, for example, or any residents in a community where certain diseases or parasites are endemic. In that situation, the composter must make every effort necessary to ensure thermophilic composting, adequate aging time, and total pathogen destruction.

The following information illustrates the various waste treatment methods and composting methods commonly used today and shows the transmission of pathogens through the individual systems.

## OUTHOUSES AND PIT LATRINES

Outhouses have odor problems, breed flies and possibly mosquitoes, and pollute groundwater. However, if the contents of a pit latrine have been filled over and left for a minimum of one year, there will be no surviving pathogens except for the possibility of roundworm eggs, according to Feachem. This risk is small enough that the contents of pit latrines, after twelve months burial, can be used agriculturally. Franceys et al. state, “*Solids from pit latrines are innocuous if the latrines have not been used for two years or so, as in alternating double pits.*” [32](#)

## SEPTIC TANKS

It is safe to assume that septic tank effluents and sludge are highly pathogenic (see Figure 7.2). Viruses, parasitic worm eggs, bacteria, and protozoa can be emitted from septic tank systems in viable condition.

## CONVENTIONAL SEWAGE TREATMENT PLANTS

The only sewage digestion process producing a guaranteed pathogen-free sludge is batch thermophilic digestion in which all of the sludge is maintained at 50°C (122°F) for 13 days. Other sewage digestion processes will allow the survival of worm eggs and possibly pathogenic bacteria. Typical sewage treatment plants instead use a continuous process where wastewater is added daily or more frequently, thereby guaranteeing the survival of pathogens (see Figure 7.3).

I took an interest in my local wastewater treatment plant when I discovered that the water in our local creek below the wastewater discharge point had ten times the level of nitrates that unpolluted water has, and three times the level of nitrates acceptable for drinking water.[33](#) In other words, the water being discharged from the water treatment plant was polluted. We knew the pollution included high levels of nitrates, although we didn’t test for pathogens or chlorine levels. Despite the pollution, the nitrate levels were within legal limits for wastewater discharges.

## WASTE STABILIZATION PONDS

Waste stabilization ponds, or lagoons, large shallow ponds widely used in North America, Latin America, Africa and Asia, involve the use of both beneficial bacteria and algae in the decomposition of organic waste materials. Although they can breed mosquitoes, they can be designed and managed well enough to yield pathogen-free waste water. However, they typically yield water with low concentrations of both pathogenic viruses and bacteria (see Figure 7.4).

## COMPOSTING TOILETS AND MOULDERING TOILETS

Most mouldering and commercial composting toilets are relatively anaerobic and compost at a low temperature. According to Feachem et al., a minimum retention time of three months produces a compost free of all pathogens except possibly some intestinal worm eggs. The compost obtained from these types of toilets can theoretically be composted again in a thermophilic pile and rendered suitable for food gardens (see Figure 7.5 and Table 7.14). Otherwise, the compost can be moved to an outdoor compost bin, layered and covered with straw (or other bulky organic material such as weeds or leaf mould), moistened, and left to age for an additional year or two in order to destroy any possible lingering pathogens. Microbial activity and earthworms will aid in the sanitation of the compost over time.

## WELL-MANAGED THERMOPHILIC COMPOSTING SYSTEM

Complete pathogen destruction is guaranteed by arriving at a temperature of 62°C (143.6°F) for one hour, 50°C (122°F) for one day, 46°C (114.8°F) for one week, or 43°C (109.4°F) for one month. It appears that no excreted pathogen can survive a temperature of 65°C (149°F) for more than a few minutes. A compost pile containing entrapped oxygen may rapidly rise to a temperature of 55°C (131°F) or above, or will maintain a temperature hot enough for a long enough period of time to thoroughly destroy human pathogens that may be in the humanure (see Figure 7.6). Furthermore, pathogen destruction is aided by microbial diversity, as discussed in Chapter 3. Table 7.14 indicates survival times of pathogens in a) soil, b) anaerobic decomposition conditions, c) composting toilets, and d) thermophilic compost piles.

## MORE ON PARASITIC WORMS

This is a good subject to discuss in greater detail as it is rarely a topic of conversation in social circles, yet it is important to those who are concerned about potential pathogens in compost. Therefore, let's look at the most common of human worm parasites: pinworms, hookworms, whipworms, and roundworms.

## PINWORMS

A couple of my kids had pinworms at one time during their childhood. I know exactly who they got them from (another kid), and getting rid of them was a simple matter. However, the rumor was circulated that they got them from our compost. We were also told to worm our cats to prevent pinworms in the kids (these rumors allegedly originated in a doctor's office). Yet, the pinworm life cycle does not include a stage in soil, compost, manure, or cats. These unpleasant parasites are spread from human to human by



direct contact, and by inhaling eggs.

Pinworms (*Enterobius vermicularis*) lay microscopic eggs at the anus of a human being, its only known host. This causes itching at the anus which is the primary symptom of pinworm infestation. The eggs can be picked up almost anywhere; once in the human digestive system they develop into the tiny worms. Some estimate that pinworms infest or have infested 75% of all New York City children in the three to five year age group, and that similar figures exist for other cities.<sup>34</sup>

These worms have the widest geographic distribution of any of the worm parasites, and are estimated to infect 208.8 million people in the world (18 million in Canada and the U.S.). An Eskimo village was found to have a 66% infection rate; a 60% rate has been found in Brazil, and a 12% to 41% rate was reported in Washington D.C.

Infection is spread by the hand to mouth transmission of eggs resulting from scratching the anus, as well as from breathing airborne eggs. In households with several members infected with pinworms, 92% of dust samples contained the eggs. The dust samples were collected from tables, chairs, baseboards, floors, couches, dressers, shelves, window sills, picture frames, toilet seats, mattresses, bath tubs, wash basins and bed sheets. Pinworm eggs have also been found in the dust from school rooms and school cafeterias. Although dogs and cats do not harbor pinworms, the eggs can get on their fur and find their way back to their human hosts. In about one-third of infected children, eggs may be found under the fingernails.

Pregnant female pinworms contain 11,000 to 15,000 eggs. Fortunately, pinworm eggs don't survive long outside their host. Room temperature with 30% to 54% relative humidity will kill off more than 90% of the eggs within two days. At higher summer temperatures, 90% will die within three hours. Eggs survive longest (two to six days) under cool, humid conditions; in dry air, none will survive for more than 16 hours.

A worm's life span is 37-53 days; an infection would self-terminate in this period, without treatment, in the absence of reinfection. *The amount of time that passes from ingestion of eggs to new eggs being laid at the anus ranges from four to six weeks.*<sup>35</sup>

*In 95% of infected persons, pinworm eggs aren't found in the feces.* Transmission of eggs to feces and to soil is not part of the pinworm life cycle, which is one reason why the eggs aren't likely to end up in either feces or compost. Even if they do, they quickly die outside the human host.

One of the worst consequences of pinworm infestation in children is the trauma of the parents, whose feelings of guilt, no matter how clean and conscientious they may be, are understandable. However, if you're composting your manure, you can be sure that you are not thereby breeding or spreading pinworms. Quite the contrary, any pinworms or eggs getting into your compost are being destroyed.<sup>36</sup>

## HOO KWORMS

Hookworm species in humans include *Necator americanus*, *Ancylostoma duodenale*, *A. braziliense*, *A. caninum*, and *A. ceylanicum*.

These small worms are about a centimeter long, and humans are almost the exclusive host of *A. duodenale* and *N. americanus*. A hookworm of cats and dogs, *A. caninum*, is an extremely rare intestinal parasite of humans.

The eggs are passed in the feces and mature into larvae outside the human host in favorable conditions. The larvae attach themselves to the human host usually at the bottom of the foot when they're walked on, and then enter their host through pores, hair follicles, or even unbroken skin. They tend to migrate to the upper small intestine where they suck their host's blood. Within five or six weeks, they'll mature enough to produce up to 20,000 eggs per day.

Hookworms are estimated to infect 500 million people throughout the world, causing a daily blood loss of more than 1 million liters, which is as much blood as can be found in all the people in the city of Erie, PA, or Austin, TX. An infection can last two to fourteen years. Light infections can produce no recognizable symptoms, while a moderate or heavy infection can produce an iron deficiency anemia. Infection can be determined by a stool analysis.

These worms tend to be found in tropical and semi-tropical areas and are spread by defecating on the soil. Both the high temperatures of composting and the freezing temperatures of winter will kill the eggs and larvae (see Table 7.16). Drying is also destructive.<sup>37</sup>

## WHIPWORM

Whipworms (*Trichuris trichiura*) are usually found in humans, but also may be found in monkeys or hogs. They're usually under two inches long and the female can produce 3,000 to 10,000 eggs per day. Larval development occurs outside the host, and in a favorable environment (warm, moist, shaded soil), first stage larvae are produced from eggs in three weeks. The lifespan of the worm is usually considered to be four to six years.

Hundreds of millions of people worldwide, as much as 80% of the population in certain tropical countries, are infected by whipworms. In the US, whipworms are found in the south where heavy rainfall, a subtropical climate, and feces-contaminated soil provide a suitable habitat.

Persons handling soil that has been defecated on by an infected person risk infection by hand-to-mouth transmission. Infection results from ingestion of the eggs. Light infections may not show any symptoms. Heavy infections can result in anemia and death. A stool examination will determine if there is an infection.

Cold winter temperatures of -8°C to -12°C (17.6°F to 10.4°F) are fatal to the eggs, as are the high temperatures of thermophilic composting.<sup>38</sup>

## ROUNDWORMS

Roundworms (*Ascaris lumbricoides*) are fairly large worms (10 inches in length) which parasitize the human host by eating semi-digested food in the small intestine. The females can lay 200,000 eggs per day for a lifetime total of 26 million or so. Larvae develop from the eggs *in soil* under favorable conditions (21°C to 30°C / 69.8°F to 86°F). Above 37°C (98.6°F), they cannot fully develop.

Approximately 900 million people are infected with roundworms worldwide, one million in the US. The eggs are usually transmitted hand to mouth by people, usually children, who have come into contact with the eggs in their environment. Infected persons usually complain of a vague abdominal pain. Diagnosis is by stool analysis.<sup>39</sup> An analysis of 400,000 stool samples throughout the US by the Center for Disease Control found *Ascaris* in 2.3% of the samples, with a wide fluctuation in results depending on the geographical location of the person sampled. Puerto Rico had the highest positive sample frequency (9.3%), while samples from Wyoming, Arizona, and Nevada showed no incidence of *Ascaris* at all.<sup>40</sup> In moist tropical climates, roundworm infection may afflict 50% of the population.<sup>41</sup>

Eggs are destroyed by direct sunlight within 15 hours, and are killed by temperatures above 40°C (104°F), dying within an hour at 50°C (122°F). Roundworm eggs are resistant to freezing temperatures, chemical disinfectants, and other strong chemicals, but thermophilic composting will kill them.

Roundworms, like hookworms and whipworms, are spread by fecal contamination of soil. Much of this contamination is caused and spread by children who defecate outdoors within their living area. One sure way to eradicate fecal pathogens is to conscientiously collect and thermophilically compost all fecal material. Therefore, it is very important when composting humanure to be certain that all children use the toilet facility and do not defecate elsewhere. When changing soiled diapers, deposit the fecal material into the humanure receptacle with toilet paper or another biodegradable material. It's up to adults to keep an eye on kids and make sure they understand the importance of *always using a toilet facility*.

Fecal environmental contamination can also be caused by using raw fecal material for agricultural purposes. *Proper thermophilic composting of all fecal material is essential for the eradication of fecal pathogens.*

## TEMPERATURE AND TIME

There are two primary factors leading to the death of pathogens in humanure. The first is *temperature*. A compost pile that is properly managed will destroy pathogens with the heat it generates.

The second factor is *time*. The lower the temperature of the compost, the longer the subsequent retention time needed for the destruction of pathogens. Given enough time, the wide biodiversity of microorganisms in the compost will destroy pathogens by the antagonism, competition, consumption, and antibiotic inhibitors provided by the beneficial microorganisms. Feachem et al. state that three

months retention time will kill all of the pathogens in a low-temperature composting toilet except worm eggs, although Table 7.14 (also from Feachem) indicates that some additional pathogen survival may occur.

A thermophilic compost pile will destroy pathogens, including worm eggs, quickly, possibly in a matter of minutes. Lower temperatures require longer periods of time, possibly hours, days, weeks, or months, to effectively destroy pathogens. One need not strive for extremely high temperatures such as 65°C (150°F) in a compost pile to feel confident about the destruction of pathogens. It may be more realistic to maintain lower temperatures in a compost pile for longer periods of time, such as 50°C (122°F) for 24 hours, or 46°C (115°F) for a week. According to one source, “*All fecal microorganisms, including enteric viruses and roundworm eggs, will die if the temperature exceeds 46°C (114.8°F) for one week.*”<sup>42</sup> Other researchers have drawn similar conclusions, demonstrating pathogen destruction at 50°C (122°F), which produced compost “completely acceptable from the general hygienic point of view.”<sup>43</sup>

A sound approach to pathogen destruction when composting humanure is to thermophilically compost the organic refuse, then allow the compost to sit, undisturbed, for a lengthy period of time after the thermophilic heating stage has ended. The biodiversity of the compost will aid in the destruction of pathogens as the compost ages. If one wants to be particularly cautious, one may allow the compost to age for two years after the pile has been built, instead of the one year that is normally recommended.

In the words of Feachem et al., “*The effectiveness of excreta treatment methods depends very much on their time-temperature characteristics. The effective processes are those that either make the excreta warm (55°C/131°F), hold it for a long time (one year), or feature some effective combination of time and temperature.*” The time/temperature factor of pathogen destruction is illustrated in Figure 7.7.

In short, the combined factors of temperature and time will do the job of “turning turds into tomatoes.”

## CONCLUSIONS

Humanure is a valuable resource suitable for agricultural purposes and has been recycled for such purposes by large segments of the world’s human population for thousands of years.

However, humanure contains the potential for harboring human pathogens, including bacteria, viruses, protozoa, and parasitic worms or their eggs, and thereby can contribute to the spread of disease when improperly managed or when discarded as a waste material. When pathogenic raw humanure is applied to soil, pathogenic bacteria may continue to survive in the soil for over a year, and roundworm eggs may survive for many years, thereby maintaining the possibility of human reinfection for lengthy periods of time.

However, when humanure is *thermophilically* composted, human pathogens are rapidly destroyed, and the humanure is thereby converted into a hygienically safe form, suitable for soil applications for the purpose of human food production.

Thermophilic composting requires no electricity and therefore no coal combustion, no acid rain, no nuclear power plants, no nuclear waste, no petrochemicals, and no consumption of fossil fuels. The composting process produces no waste, no pollutants, and no toxic by-products. Thermophilic composting of humanure can be carried out century after century, millennium after millennium, with no stress on our ecosystems, no unnecessary consumption of resources, and no garbage or sludge for our landfills. And all the while it will produce a valuable resource necessary for our survival while preventing the accumulation of dangerous and pathogenic waste. If that doesn't describe *sustainability*, nothing does.

*Source: The Humanure Handbook. Jenkins Publishing, PO Box 607, Grove City, PA 16127. To order, phone: 1-800-639-4099.*

<http://www.jenkinspublishing.com/>

---

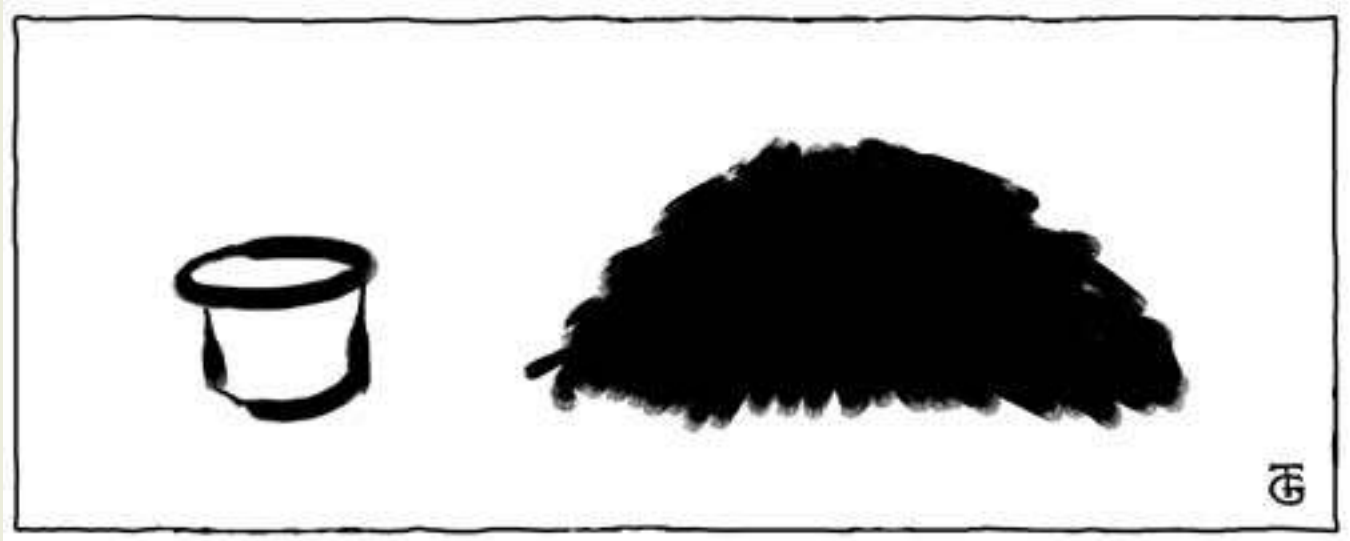
**MENU: [HOME](#) » [Reconstruction](#) » [Recovery](#) » [Renewal](#) » [Survival](#) » [Humanure Content](#)**

---

---

**MENU:** [HOME](#) » [Reconstruction](#) » [Recovery](#) » [Renewal](#) » [Survival](#) » [Humanure Content](#)

## THE TAO OF COMPOST



*"Aspire to simple living? That means, aspire to fulfill the highest human destiny."*

Charles Wagner

Organic material should be recycled by every person on the planet, and recycling should be as normal and integral to daily life as brushing teeth or bathing. Organic materials can be collected by municipalities and composted at central composting facilities. This is now done in many parts of the world where food scraps are composted for urban communities. Toilet materials are not yet being collected and centrally composted in very many places, although such collection will undoubtedly increase as time passes.

However, people can compost their own organic material in their own personal compost bins, in their own backyards. This is already becoming commonplace, and compost bins are now popping up in backyards everywhere like mushrooms after a rain. Composting need not cost money, and it can be practiced by anyone in the world at probably any location where plants can grow. Therefore, it is important that people everywhere learn to understand what compost is and how it can be made.

It is also important that we understand how to compost our toilet materials in a safe and simple manner. A low-cost composting toilet system can be very useful as a back-up toilet in an emergency situation when electrical or water services are disrupted, or when the water supply is diminished as during a

drought, when flushing drinking water down toilets becomes especially ridiculous. It can also be very useful in any area where water or electricity is scarce or non-existent, as well as in developing countries where there may be many people with little or no money to buy commercial composting toilets. Finally, a simple, low-cost composting toilet system is attractive to anyone seeking a low-impact lifestyle, and who is willing to make the minimal effort to compost their organic materials. This chapter details how to compost toilet materials by using a simple, easy, low or no-cost method (a sawdust toilet) which my family and I have used for twenty years at the time of this writing.

The organic materials our bodies excrete can be composted much the same as any apple core or potato peel — by being added to a compost pile. There are essentially two ways to do this. The first is to construct or purchase a toilet which deposits directly into a composting chamber. This is discussed and illustrated in Chapter 6. Such toilets must be properly managed if thermophilic conditions are desired; most commercial composting toilets do not achieve such conditions, and are not meant to.

The second, less expensive, and simpler method is to use one's toilet as a collection device, much the same as any compost bucket, and then compost the contents in a separate compost pile on a regular basis. This simple technique can be done without unpleasant odors, and the toilet can be quite comfortably situated inside one's home. Moving toilet material to a compost bin, however, is an activity that many individuals have no interest in doing, usually not because it is a burdensome task (for a family of four it would involve a twenty minute trip to a compost bin about every three days), but because it's *shit*, for god's sake.

A friend of mine who wanted to use a compost toilet once told me she could never carry “a shit bucket” to a compost bin. She just could not do it, she said, shaking her head. I asked her how often she fed her dog, which was chained about a hundred yards from her house. “Every day,” was her reply.

“How is it that you can carry a container of dog food out to your dog, every day, and not a container of soil nutrients to a compost pile once a week?” (A single person only needs to make a trip to a compost bin once a week.) No reply. “If the ‘shit bucket,’ as you call it, were full of roses, would you be able to carry it to a compost pile once a week?”

“Sure.”

“Then why wouldn't you be able to carry a bucket of other organic material?”

Again, no reply. And none needed. The problem is not practical, it is psychological. I understand perfectly that many people consider the idea of composting their own excrement to be beneath them. In India, such a task was relegated to the “untouchables,” the lowest caste of society. The act of carrying a container of one's own excrement to a recycling bin is an act of humility, and humility is sometimes in short supply. Eventually, toilets in general will be redesigned as collection devices and their contents will be collected and composted as a service by municipal workers. Until then, however, those of us who want to make compost rather than sewage must do it by our own humble selves.

I will never forget the day I introduced a close relative to my composting system. She came to visit me at my newly established homestead one spring day and I gave her a tour of my garden, which was already quite vibrant. A fresh pile of aged compost had been dumped from a wheelbarrow onto one of the raised garden beds and, as we passed, I reached down and scooped up a big handful, thrusting it toward her face. "Smell this," I said. So she put her nose right up to the black earth I held out before me and took a deep breath.

"Boy, that smells good!" she said, inhaling the rich, sweet-smelling aroma of fertile soil, and smiling.

"*This is my alternative to a septic system,*" I proudly informed her, still holding the compost out in front of me as I watched her smile freeze. I will always remember that shocked look on her face, cloaked behind a huge smile. My friend, although very open-minded, had not, prior to that moment, had the experience of so intimately communing with composted humanure. The compost did smell and look wonderful, if I have to say so myself, just like a rich soil from the woods, and I was *proud* of it.

People ask me when I'm going to install a septic system, as if composting is a phase you go through until you become mature and civilized enough to use a flush toilet. Others take one look at my compost toilet and say things like "*I respect the way you're living, but I could never do it.*" Well, I could install a septic system, as I have running water and electricity (when I started using a composting toilet system I lived "off the grid," without electricity, and did so for a period of twelve years). However, a septic system would create environmental pollution and threaten the quality of my ground water, which I drink. It is a *waste disposal* system, collecting and storing waste and allowing the waste to slowly seep into the environment. I'd much rather engage in resource recovery instead of waste disposal, however unfashionable. My compost is my reward — it helps me to grow my food, and that's too valuable for me to be willing to sacrifice.

*Source: The Humanure Handbook. Jenkins Publishing, PO Box 607, Grove City, PA 16127. To order, phone: 1-800-639-4099.*

<http://www.jenkinspublishing.com/>

---

**MENU: [HOME](#) » [Reconstruction](#) » [Recovery](#) » [Renewal](#) » [Survival](#) » [Humanure Content](#)**

---



---

## PRIMAL COMPOST

Try to imagine yourself in an extremely primitive setting, perhaps sometime around 10,000 B.C. Imagine that you're slightly more enlightened than your brutish companions and it dawns on you one day that your feces should be disposed of in a different manner. Everyone else is defecating in the back of the cave, creating a smelly, fly-infested mess, and you don't like it.

Your first revelation is that smelly refuse should be deposited in one place, not spread around for everyone to step in or smell, and it should be deposited away from one's living area. You watch the wild cats and see that they each go to a special spot to defecate. But the cats are still one step ahead of the humans, as you soon find out, because they cover their excrement.

When you've shat outside the cave on the ground in the same place several times, you see that you've still created a foul-smelling, fly-infested mess. Your second revelation is that the refuse you're depositing on the ground should be covered after each deposit. So you scrape up some leaves every time you defecate and throw them over the feces. Or you pull some tall grass out of the ground and use it for cover.

Soon your companions are also defecating in the same spot and covering their fecal material as well. They were encouraged to follow your example when they noticed that you had conveniently located the defecation spot between two large rocks, and positioned logs across the rocks to provide a convenient perch, allowing for care-free defecation above the material collecting underneath.

A pile of dead leaves is now being kept beside the toilet area in order to make the job of covering it more convenient. As a result, the offensive odors of human feces and urine no longer foul the air. Instead, it's food scraps that are generating odors and attracting flies. This is when you have your third revelation: food scraps should be deposited on the same spot and covered as well. Every stinky bit of refuse you create is now going to the same spot and is being covered with a natural material to eliminate odor. This hasn't been hard to figure out, it makes good sense, and it's easy to do.

You've succeeded in solving three problems at once: no more human waste scattered around your living area, no more garbage, and no more offensive odors assaulting your keen sense of smell and generally ruining your day. You also begin to realize that the illnesses that were prone to spread through the group have subsided, a fact that you don't understand, but you suspect may be due to the group's new found hygienic practices.

Quite by accident, you've succeeded in doing one very revolutionary thing: *you've created a compost pile*. You begin to wonder what's going on when the pile gets so hot it's letting off steam. What you don't know is that you've done exactly what nature intended you to do by piling all your organic refuse together, layered with natural, biodegradable cover materials. In fact, nature has "seeded" your excrement with microscopic animals that proliferate in and digest the pile you've created. In the process, they heat the compost to such an extent that disease-causing pathogens resident in the humanure are destroyed. The microscopic animals would not multiply rapidly in the discarded refuse unless you created the pile, and thereby the conditions, which favor their proliferation.

Finally, you have one more revelation, a big one. You see that the pile, after it gets old, sprouts all kind of vibrant plant growth. You put two and two together and realize that the stinking refuse you carefully disposed of has been transformed into rich earth, and ultimately into food. Thanks to you, humankind has just climbed another step up the ladder of evolution.

There is one basic problem with this scenario: it didn't take place 12,000 years ago. It's taking place now. Compost microorganisms are apparently very patient. Not much has changed since 10,000 B.C. in their eyes. The invisible animals that convert humanure into humus don't care what composting techniques are used today anymore than they cared what techniques may have been used eons ago, so long as their needs are met. And those needs haven't changed in human memory, nor are they likely to change as long as humans roam the earth. Those needs include: 1) *temperature* (compost microorganisms won't work if frozen); 2) *moisture* (they won't work if too dry or too wet); 3) *oxygen* (they won't work without it); and 4) *a balanced diet* (otherwise known as balanced carbon/nitrogen). In this sense, compost microorganisms are a lot like people. With a little imagination, we can see them as a working army of microscopic people who need the right food, water, air and warmth.

The art of composting, then, remains the simple and yet profound art of providing for the needs of invisible workers so that they work as vigorously as possible, season after season. And although those needs may be the same worldwide, the techniques used to arrive at them may differ from eon to eon and from place to place.

Composting differs from place to place because it is a bioregional phenomenon. There are thousands of geographic areas on the Earth each with its own unique human population, climatic conditions, and available organic materials, and there will also be potentially thousands of individual composting methods, techniques, and styles. What works in one place on the planet for one group of people may not work for another group in another geographic location (for example, we have lots of hardwood sawdust in Pennsylvania, but no rice hulls). Compost should be made in order to eliminate local waste and pollution as well as to recover resources, and a compost maker will strive to utilize in a wise and efficient manner whatever local organic resources are available.

*Source: The Humanure Handbook. Jenkins Publishing, PO Box 607, Grove City, PA 16127. To order, phone: 1-800-639-4099.*

<http://www.jenkinspublishing.com/>

**MENU:** [HOME](#) » [Reconstruction](#) » [Recovery](#) » [Renewal](#) » [Survival](#) » [Humanure Content](#)

---

---

## THE SAWDUST TOILET

Simple methods of collecting humanure and composting it are sometimes called cartage systems or bucket systems, as the manure is carried to the compost bin, often in buckets or other waterproof vessels. People who utilize such simple techniques for composting humanure simply take it for granted that humanure recycling is one of the regular and necessary responsibilities for sustainable human life on this planet.

How it works is a model of simplicity. One begins by depositing one's organic refuse (feces and urine) into a plastic bucket, clay urn, or other non-corrodible waterproof receptacle with about a five gallon (20 liter) capacity. Food scraps may be collected in a separate receptacle, but can also be deposited into the toilet receptacle. A five gallon capacity is recommended because a larger size would be too heavy to carry when full. If five gallons is still too heavy for someone to carry, it can be emptied when half-full.

The contents of the toilet are kept covered with a clean, organic *cover material* such as rotted sawdust, peat moss, leaf mould, rice hulls, or grass clippings, in order to prevent odors, absorb urine, and eliminate any fly nuisance. Urine is deposited into the same receptacle, and as the liquid surface rises, more cover material is added so that a clean layer of organic material covers the toilet contents *at all times*.

A lid is kept on the toilet receptacle when not in use. The lid need not be air-tight, and a standard, hinged toilet seat is quite suitable. The lid does not necessarily prevent odor from escaping, and it does not necessarily prevent flies from gaining access to the toilet contents. Instead, the *cover material* does. The cover material acts as an organic lid or a "biofilter"; the physical lid (toilet seat) is used primarily for convenience and aesthetics. Therefore, the choice of organic cover material is very important, and a material that has some moisture content, such as rotted sawdust, works beautifully. This is not kiln-dried sawdust from a carpenter shop. It is sawdust from a sawmill where trees are cut into boards. Such sawdust is both moist and biologically active and makes a very effective biofilter. Kiln-dried sawdust is too light and airy to be a 100% effective biofilter. Furthermore, sawdust from wood-working shops may contain hazardous chemical poisons if "pressure-treated" lumber is being used there. It seems that present-day carpenters are more than willing to expose themselves to the chemical hazards of poison-soaked lumber, which contains cancer-causing chemicals. There is no need for composters and gardeners to duplicate such unwise exposure.

I use rotted sawdust as a toilet cover material because it is a readily available, very inexpensive, local resource which works well. I used to haul a free load home from a local sawmill every so often in the back of my pick-up truck, but now I just have a fellow with a small dump truck deliver me a load every year or two. I have the sawdust dumped in a pile in a corner of my backyard adjacent to my compost bins where it can remain exposed to the elements and thereby slowly decompose on its own, as rotting sawdust makes compost more readily than fresh sawdust. The sawdust itself doesn't cost me anything, but I usually have to pay about five dollars to have it loaded onto the dump truck and another twenty-five to have it hauled. This is an expense I'm

happy to pay every year or two in order to ensure for myself a functional compost toilet system. I would speculate that many other cellulose-based materials or combination of materials would work as a toilet cover material, including perhaps ground newsprint.



“I found myself on an organic farm in Thailand...I and some other volunteers made handy use of your book. Instead of shitting in a pit and covering, we decided to make good use of ‘the waste.’ Could not have done it, however, without the information you provided. So yes, even in the remote parts of Thailand, your efforts have made their effects. We used easy-to-get rice husks instead of suggested sawdust — works brilliantly!” R.M. in Thailand

“I’ve been using lately well-rotted leaf mold to cover deposits in the five gallon bucket — and find this a fantastic cover for absorbing all odors — better than when I used sawdust.” J.W. in CT

In the winter, an outdoor pile of sawdust will freeze solid. I have to layer some hay over mine and cover it with a tarp in order to be able to access it all winter. Otherwise, feedsacks filled with sawdust stored in a basement will work as an alternative, as will peat moss and other cover materials stored indoors.

The system of using an organic cover material in a small receptacle works well enough in preventing odors to allow the toilet to be indoors, year round. In fact, a full bucket with adequate and appropriate cover material, and no lid, can be set on the kitchen table without emitting unpleasant odors (take my word for it). An indoor sawdust toilet should be designed to be as warm, cozy, pleasant, and comfortable as possible. A well-lit, private room with a window, a standard toilet seat, a container of cover material, and some reading material will suffice.

### AMERICAN YARDS AND ENGLISH GARDENS

In the United States, a “yard” is a grassy area surrounding a house; the term is equivalent to the English term “garden.” That grassy area may contain trees, shrubs, or flowers. If it is located in front of the house, it is called the “front yard.” Behind the house, it is the “back yard.” Beside the house, it is the “side yard.” An American “garden” is a plot of vegetables, often located within the yard. An American garden can also be a flower garden or fruit

When the bucket is full, it is carried to the composting area and deposited on the pile. Since the material must be moved from the toilet room to an outdoor compost pile, the toilet room should be handy to an outside door. If you are redesigning a sawdust toilet in a new home, situate the toilet room near a door that allows direct access to the outside.

It is best to dig a slight depression in the top center of the compost pile and deposit the fresh material there, in order to

garden; some American gardens contain flowers, fruits, and vegetables. In the UK, the green area around a house is called the “garden,” whether it contains vegetables, flowers, or nothing but mowed grass. English homes do not have “yards.” So the term “back yard composting,” translated to UK English, would be “back garden composting.”

### SAWDUST TOILET VITAL STATISTICS

One hundred pounds of human body weight will fill approximately three gallons (.4 cubic feet, 693 cubic inches, or approximately 11 liters) in a sawdust toilet per week - this volume includes the sawdust cover material. One hundred pounds of human body weight will also require approximately 3 gallons of semi-dry, deciduous, rotting sawdust per week for use as a cover material in a toilet. This amounts to a requirement of approximately 20 cubic feet of sawdust cover material per one hundred pounds of body weight per year for the proper functioning of a sawdust toilet. Human excrement tends to add weight rather than volume to a sawdust toilet as it is primarily liquid and fills the air spaces in the sawdust. Therefore, for every gallon of sawdust-covered excrement collected in a sawdust toilet, nearly a gallon of cover material will need to be used.

keep the incoming humanure in the hotter center of the compost pile. This is easily achieved by raking aside the cover material on top of the pile, depositing the toilet contents in the resulting depression, and then raking the cover material back over the fresh deposit. The area is then immediately covered with additional clean, bulky, organic material such as straw, leaves, or weeds, in order to eliminate odors and to entrap air as the pile is built. The bucket is then thoroughly scrubbed with a small quantity of water, which can be rain water or graywater, and biodegradable soap, if available or desired. A long-handled toilet brush works well for this purpose. Often, a simple but thorough rinsing will be adequate. Rain water or wastewater is ideal for this purpose as its collection requires no electricity or technology. The soiled water is then poured on the compost pile.

It is imperative that the rinse water not be allowed to pollute the environment. The best way to avoid this is to put the rinse water on the compost pile, as stated. However, the rinse water can be poured down a drain into a sewer or septic system, or drained into an artificial wetland. It can also be poured at the base of a tree or shrub that is designated for this purpose. Such a tree or shrub should have a thick layer of organic material (biological sponge) at its base and be staked or fenced to prevent access to children or pets. Under no circumstances should the rinse water be flung aside nonchalantly. This is the weak link in this simple humanure recycling chain, and it provides the

most likely opportunity for environmental contamination. Such contamination is easy to avoid through considerate, responsible management of the system. Finally, never use chlorine to rinse a compost receptacle. Chlorine is a chemical poison that is detrimental to the environment and is totally unnecessary for use in any humanure recycling system. Simple soap and water is adequate.

After rinsing or washing, the bucket is then replaced in the toilet area. The inside of the bucket should then be dusted with sawdust, the bottom of the empty receptacle should be primed with an inch or two of sawdust, and it's once again ready for use. After about ten years, the plastic bucket may begin to develop an odor, even after a thorough washing. Replace odorous buckets with new ones in order to maintain an odor-free system. The old buckets will lose their odor if left to soak in clean, soapy water for a lengthy period (perhaps weeks), rinsed, sun-dried, and perhaps soaked again, after which they can be used for utility purposes (or, if you really have a shortage of buckets, they can be used in the toilet again).

Here's a helpful hint: when first establishing such a toilet system, it's a good idea to acquire at least *four* five gallon buckets, with lids, that are *exactly the same*, and more if you intend to compost for a large number of people. Use one under the toilet seat and two, with lids, set aside in the toilet room, empty and waiting (save

the fourth as a back-up). When the first becomes full, take it out of the toilet, put a lid on it, set it aside, and replace it with one of the empty ones. When the second one fills, take it out, put the other lid on it, set it aside, and replace it with the other empty one. Now you have two full compost buckets, which can be emptied at your leisure, while the third is in place and ready to be used. This way, the time you spend emptying compost is almost cut in half, because it's just as easy to carry two buckets to the compost pile as one. Furthermore, you potentially have a 15 gallon toilet capacity at any one time (20 with the extra bucket), instead of just five gallons. You may find that extra capacity to come in very handy when inundated with visitors.

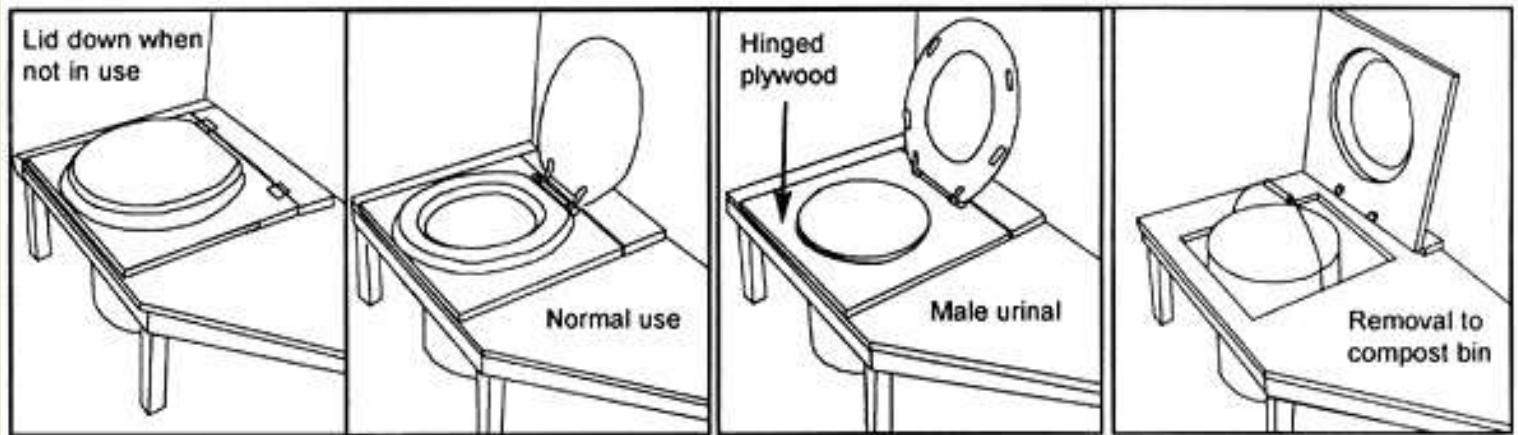


Figure 8.1

### SAWDUST TOILET WITH HINGED SEAT

The above diagram shows a simple sawdust toilet permanently built into a toilet room. The compost receptacle (bucket) sits directly on the floor. A standard toilet seat is attached to an 18" square piece of plywood, which lifts up on hinges to allow easy access when removing the compost material. Bucket setback from the front edge of the plywood is 1&1/2". Height of top surface of plywood is 1/2" lower than height of bucket. Bucket protrudes through cabinet to contact bottom of toilet seat ring. Plastic bumpers on bottom of toilet seat ring are swiveled sideways so as to fit around bucket. Actual toilet shown below.



**DIRECTIONS FOR SAWDUST TOILET:**

1. MAKE YOUR DEPOSIT
2. COVER WITH SAWDUST
3. HAVE A GREAT DAY ~ ENJOY!

Figure 8.2



## SAWDUST TOILET WITH LIFT-OFF TOP

Toilet at left came with directions mounted on the wall.

Why should all of the buckets be exactly the same? If you build a permanent toilet cabinet (seat), the top of the bucket should protrude through the cabinet to contact the bottom of a standard toilet seat. This ensures that all organic material goes into the container, not over its edge. Although this is not usually a problem, it can be with young children who may urinate over the top of a bucket receptacle when sitting on a toilet. A good design will enable the bucket to fit tightly through the toilet cabinet as shown in Figures 8.1, 8.2, and 8.4. Since all plastic buckets are slightly different in height and diameter, you will have to build your toilet cabinet to fit one size bucket. You should have extra identical ones when backup capacity is needed to accommodate large numbers of people.

It is much better to set a full toilet receptacle aside, with a lid, and replace it immediately with an empty one, than to have to empty and replace a full one while someone is waiting to use the toilet. There are some things in life we would all like to avoid: you have no money in the bank, your gas tank is empty, you're out of firewood, your pantry is bare, the sun's not shining, the dog has died, and "nature calls," but the shit bucket's full. Put some harmonica music to that last sentence and you'd have *"The Shit Bucket Blues."* One can avoid singing that tune by properly planning and managing a sawdust toilet system.

Theoretically, with enough containers, a sawdust toilet system can be used for any number of people. For example, if you are using a sawdust toilet in your home, and you are suddenly visited by thirty people all at once, you will be very happy to have empty containers ready to replace the ones that fill up. You will also be very happy that you will not have to empty any compost containers until after your company leaves, because you can simply set them out of the way in the toilet room as they fill up, and then empty them the next day.

Experience has shown that 150 people will require four five gallon containers during a serious party. Therefore, always be prepared for the unexpected, and maintain a reserve toilet capacity at all times by having extra toilet receptacles available, as well as extra cover material. Incidentally, for every full container of compost material carried out of a toilet room, a full, same-sized container of cover material will need to be carried in.

Expecting five hundred people for a major gathering out in the woods? Sawdust toilets will work fine, as long as you keep enough buckets handy, as well as adequate cover materials, and some volunteers to manage it all. You will collect a lot of valuable soil nutrients. Which brings to mind a verse created by a friend and sung to the tune of "Old Joe Clark" at one of my own gatherings, here paraphrased:

*"He feeds us lots of party food,  
and calls it appetizers.  
But we know what he's going to do,  
He'll make it fertilizer!"*

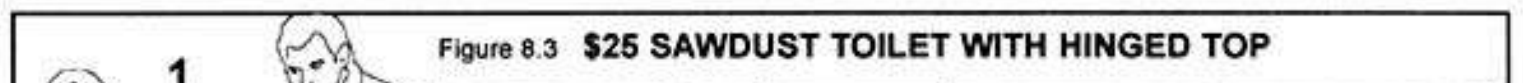
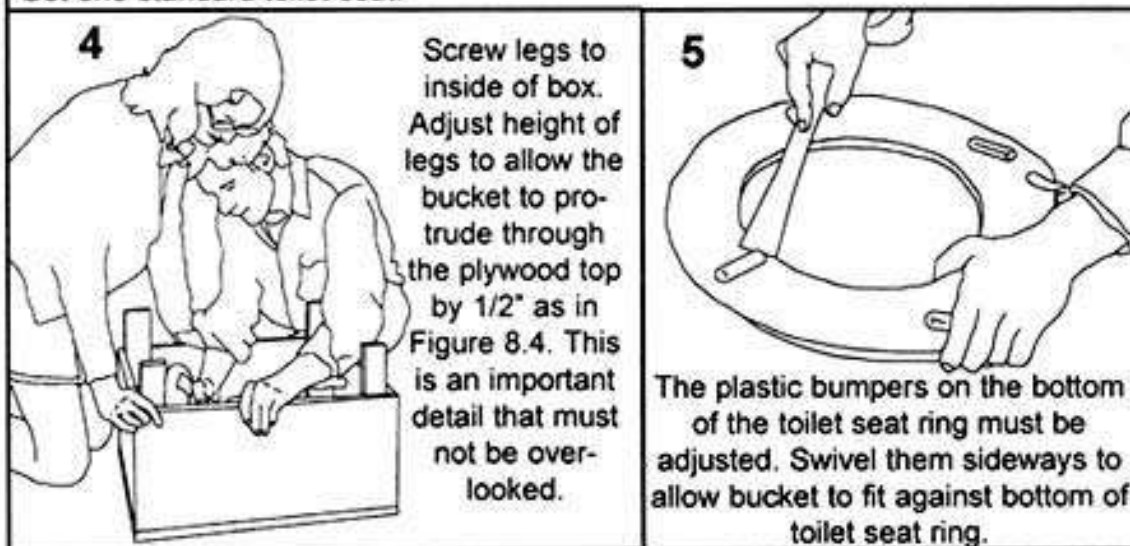
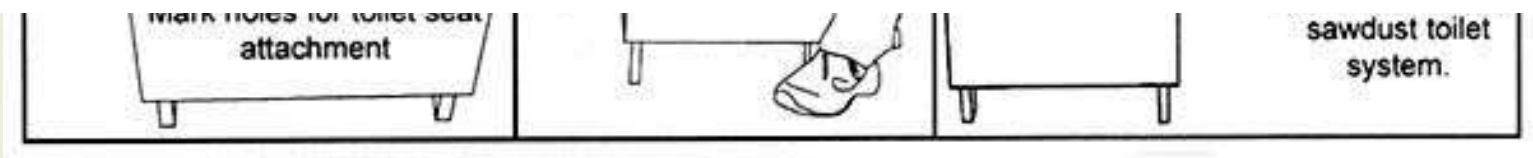


Figure 8.3 \$25 SAWDUST TOILET WITH HINGED TOP



A hinged sawdust toilet box will be 18" wide by 21" long. Get (2) boards 3/4"x10"x18", (2) 3/4"x10"x20.5", (2) hinges, (1) piece of 3/4" plywood 18"x18" and another 18"x3" and hinge them together. Cut a hole in the larger plywood to fit the top of a five-gallon bucket, set back one and one half inches from the front (as in Figure 8.4). Get four five-gallon buckets that are identical. Get (4) 3/4"x3"x12" legs. Get one standard toilet seat.





The advantages of a sawdust toilet system include low financial start-up cost in the creation of the facilities, and low, or no energy consumption in its operation. Also, such a simple system, when the refuse is thermophilically composted, has a low environmental cost, as little or no technology is required for the system's operation, and the finished compost is as nice and benign a material as humanure can ever hope to be. No composting facilities are necessary in or near one's living space, although the toilet can and should be inside one's home and can be quite comfortably designed and totally odor-free. No electricity is needed, and no water is required except a small amount for cleaning purposes. The compost, if properly managed, will heat up sufficiently for sanitation to occur, thereby making it useful for gardening purposes. The composting process is fast, i.e., the humanure is converted quickly (within a few days if not frozen) into an inoffensive substance that will neither attract rodents nor flies. In cold winter months, the compost simply freezes until spring thaw, and then heats up. If the compost is unmanaged and does not become thermophilic, the compost can simply be left to age for a couple of years before horticultural use. In either case, a complete natural cycle is maintained, unbroken.

*Source: The Humanure Handbook. Jenkins Publishing, PO Box 607, Grove City, PA 16127. To order, phone: 1-800-639-4099.  
<http://www.jenkinspublishing.com/>*

---

**MENU: [HOME](#) » [Reconstruction](#) » [Recovery](#) » [Renewal](#) » [Survival](#) » [Humanure Content](#)**

---

## THE COMPOST BINS

A sawdust toilet requires three components: 1) the toilet receptacle; 2) cover materials; and 3) a compost bin system. The system will NOT work without all three of these components. The toilet is only the collection stage of the process. The composting takes place away from the toilet, and the compost bin system is important.

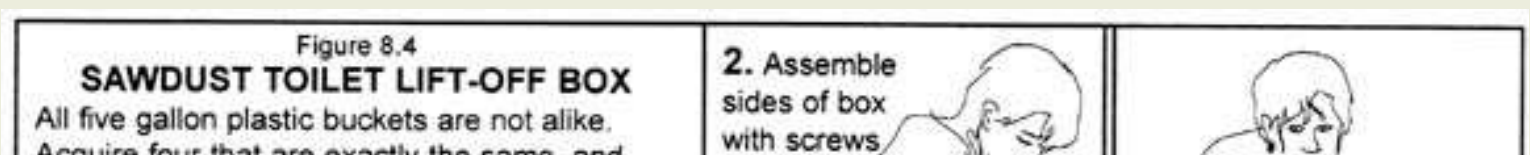
1) *Use at least a double-chambered, above-ground compost bin.* A three-chambered bin is recommended. Deposit in one chamber for a period of time (e.g., a year), then switch to another for an equal period of time.

2) *Deposit a good mix of organic material into the compost pile, including kitchen scraps.* It is a good idea to put all of your organic material into the same compost bin. Pay no attention to those people who insist that humanure compost should be segregated from other compost. They are people who do not compost humanure and don't know what they're talking about.

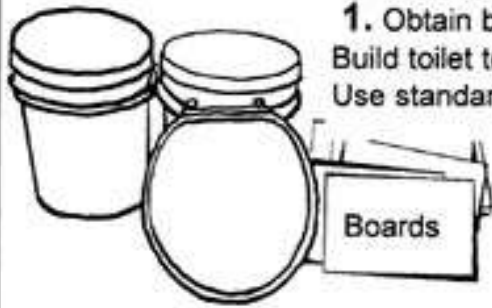
3) *Always cover humanure deposits in the toilet with an organic cover material* such as sawdust, leaf mould, peat moss, or rice hulls. *Always cover fresh deposits on the compost pile with coarser cover materials* such as hay, weeds, straw, or leaves. Make sure that enough cover is applied so that there is neither excess liquid build-up in the toilet nor offensive odors escaping either the toilet or the compost pile. The trick to using cover material is quite simple: if it smells bad or looks bad, cover it until it does neither.

4) *Keep good access to the pile* in order to rake the top flat, to apply bulky cover material when needed, to allow air to access the pile, and to monitor the temperature of the pile. The advantage of aerobic composting, as is typical of an above-ground pile, over relatively anaerobic composting typical of enclosed composting toilets, is that the aerobic compost will generate higher temperatures, thereby ensuring a more rapid and complete destruction of potential human pathogens.

The disadvantages of a collection system requiring the regular transporting of humanure to a compost pile are obvious. They include the inconvenience of: 1) carrying the organic refuse to the compost pile; 2) keeping a supply of organic cover material available and handy to the toilet; 3) maintaining and managing the compost pile itself.



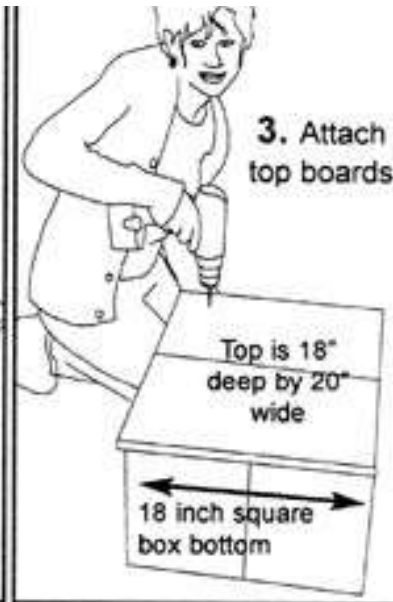
All five gallon plastic buckets are not alike. Acquire four that are exactly the same, and build the box to fit the bucket height and diameter. The bucket should protrude through the top of the box by 1/2" in order to contact the bottom of the toilet seat (as shown in #7).



**1.** Obtain buckets first. Build toilet to fit buckets. Use standard toilet seat.



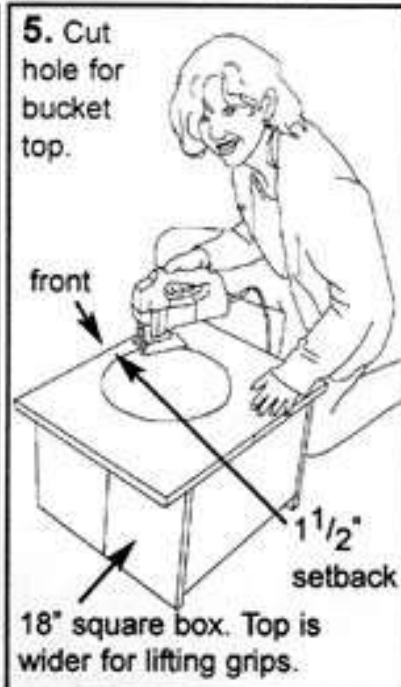
sides of box with screws and glue (or nails)



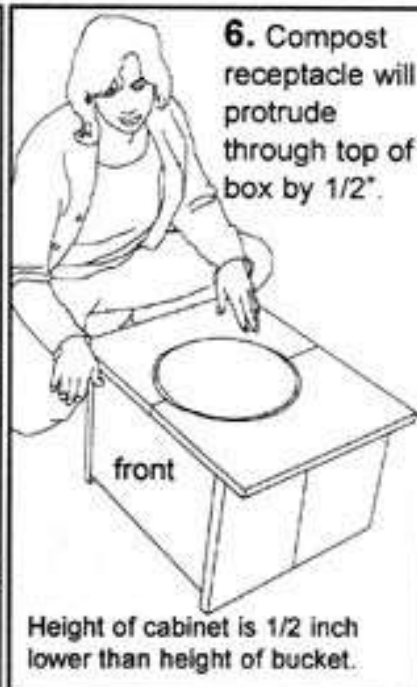
**3.** Attach top boards



**4.** Set bucket 1 1/2" from the front of the box, and center it. Mark for cut.

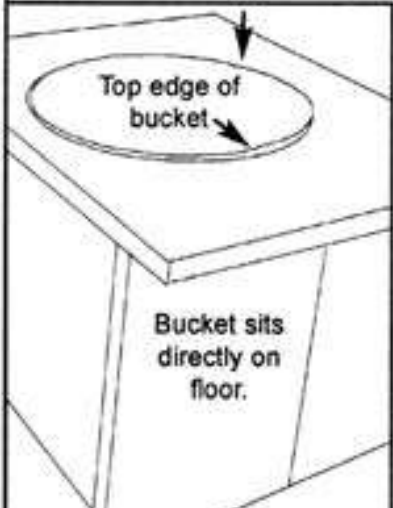


**5.** Cut hole for bucket top.



**6.** Compost receptacle will protrude through top of box by 1/2".

**7.** The overall height of the toilet box is equal to the height of the bucket minus 1/2", allowing the bucket to protrude through the box and contact the bottom of the toilet seat ring.



**8.** The plastic bumpers on the underside of the toilet seat ring must be turned sideways so as to allow the toilet seat ring to contact the top of the bucket. This ensures that all organic material meant to go into the bucket will get there and not go over the top, as may otherwise happen when little children are seated on the toilet.



**9.** Lift box off bucket to empty compost.



Source: *The Humanure Handbook*. Jenkins Publishing, PO Box 607, Grove City, PA 16127. To order, phone: 1-800-639-4099.

<http://www.jenkinspublishing.com/>

---

**MENU: [HOME](#) » [Reconstruction](#) » [Recovery](#) » [Renewal](#) » [Survival](#) » [Humanure Content](#)**

---

**MENU:** [HOME](#) » [Reconstruction](#) » [Recovery](#) » [Renewal](#) » [Survival](#) » [Humanure Content](#)

---

## NORMAL COMPOSTING BIN SEQUENCE

It's very important to understand that *two* factors are involved in destroying potential pathogens in humanure. Along with heat, the *time* factor is important. Once the organic material in a compost pile has been heated by thermophilic microorganisms, it should be left to age or "season." This part of the process allows for the final decomposition to take place, decomposition that may be dominated by fungi and macroorganisms such as earthworms. Therefore, a good compost system will utilize at least two composting bins, one to fill and leave to age, and another to fill while the first is aging. A three-binned composting system is recommended, as the third bin provides a place to store cover materials, and separates the active bins so there is no possible accidental transfer of fresh material to an aging bin.

When composting humanure, fill one bin first. Start the compost pile by establishing a thick layer of coarse and absorbent organic material on the bottom of the bin. This is called a "biological sponge"; its purpose is to act as a leachate barrier. The sponge may be an 18 inch layer of hay or straw, grass clippings, leaves, and/or weeds. Place the first container of the humanure/sawdust mix from the toilet directly on the top center of the sponge. Cover immediately with more straw, hay, weeds, or leaves — the cover acts as a natural "biofilter" for odor prevention, and it causes air to become trapped in the developing compost pile, making physical turning of the pile for aeration unnecessary.

Continue in this manner until the bin is full, being sure to add to this bin *all* of the other organic material you produce. There is no need to have any other compost piles — one is enough for everything produced by the humans in your household. If you have small animals such as chickens or rabbits, their manure can go into the same compost pile. Presumably, pet manures can also go into the same compost pile as well (see Chapter 3), although pet manures, like human manures, can contain human pathogens, so thermophilic composting and/or adequate aging of the compost are essential. Small dead animals can also be added to the compost pile.

You need to do nothing special to prepare material for adding to the compost pile. You do not need to chop up vegetables, for example. Just chuck it all in there. Most of the things compost educators tell you cannot be composted *can*, in fact, be composted in your humanure compost pile (such as meat, fats, oils, etc.). Add it all to the same compost pile. Anything smelly that may attract flies should be dug into the top center of the pile. Keep a shovel or pitchfork handy for this purpose and use the tool *only* for the compost. Keep a clean cover material over the compost at all times, and don't let your compost pile become shaped like the Matterhorn — keep it somewhat flattened so nothing rolls off.



SAWDUST TOILET IN NEW RURAL HOME



LIFT-OFF SAWDUST TOILET IN RURAL HOME



PEAT TOILET (PEAT STORED UNDER LID WITH HANDLE)



EMERGENCY SAWDUST TOILET IN BASEMENT OF NEW HOME WITH SEPTIC SYSTEM



HINGED TOP SAWDUST TOILET IN URBAN HOME



SAWDUST TOILET IN "OUTHOUSE"



When you have a sudden large quantity of cover material available, such as an influx of grass clippings when the lawn is mowed, weeds from the garden, or leaves in the fall, place them in the center bin for storage and use them to cover humanure deposits as you need them. It is assumed that you do not use any poisonous chemicals on your lawn. If you do, bag the lawn clippings, take them to a toxic waste dump, and on the way, reflect upon the folly of such toxic behavior. Do not put poisoned grass clippings on your compost pile.

Filling the first bin should take a year — that's how long it takes us, a family, usually of four, with a lot of visitors. We start to fill a compost bin every summer solstice or at some point near that time. Cover the finished compost pile with a thick layer of straw, leaves, grass clippings, or other clean material (without weed seeds) to insulate it and to act as a biofilter, then leave the pile alone. Start filling the second chamber, following the same procedure as the first (start with a biological sponge). When the second chamber is nearly full (a year later), the first one can begin to be emptied onto the garden, berries, orchard, or flower beds. The finished compost does not need to be dug deeply into the soil or buried in a trench on another planet, as the fecophobes insist. It can either be used as mulch, or it can be dug or tilled into the top layer of your garden soil. You can even roll naked in it if you want to (no, I haven't tried this — yet).



The author's triple chambered compost bins, in use for twenty years. The far bin is the active one, the near bin is the aging one, here being broken into for spring planting.

Source: *The Humanure Handbook*. Jenkins Publishing, PO Box 607, Grove City, PA 16127. To order, phone: 1-800-639-4099.

<http://www.jenkinspublishing.com/>

---

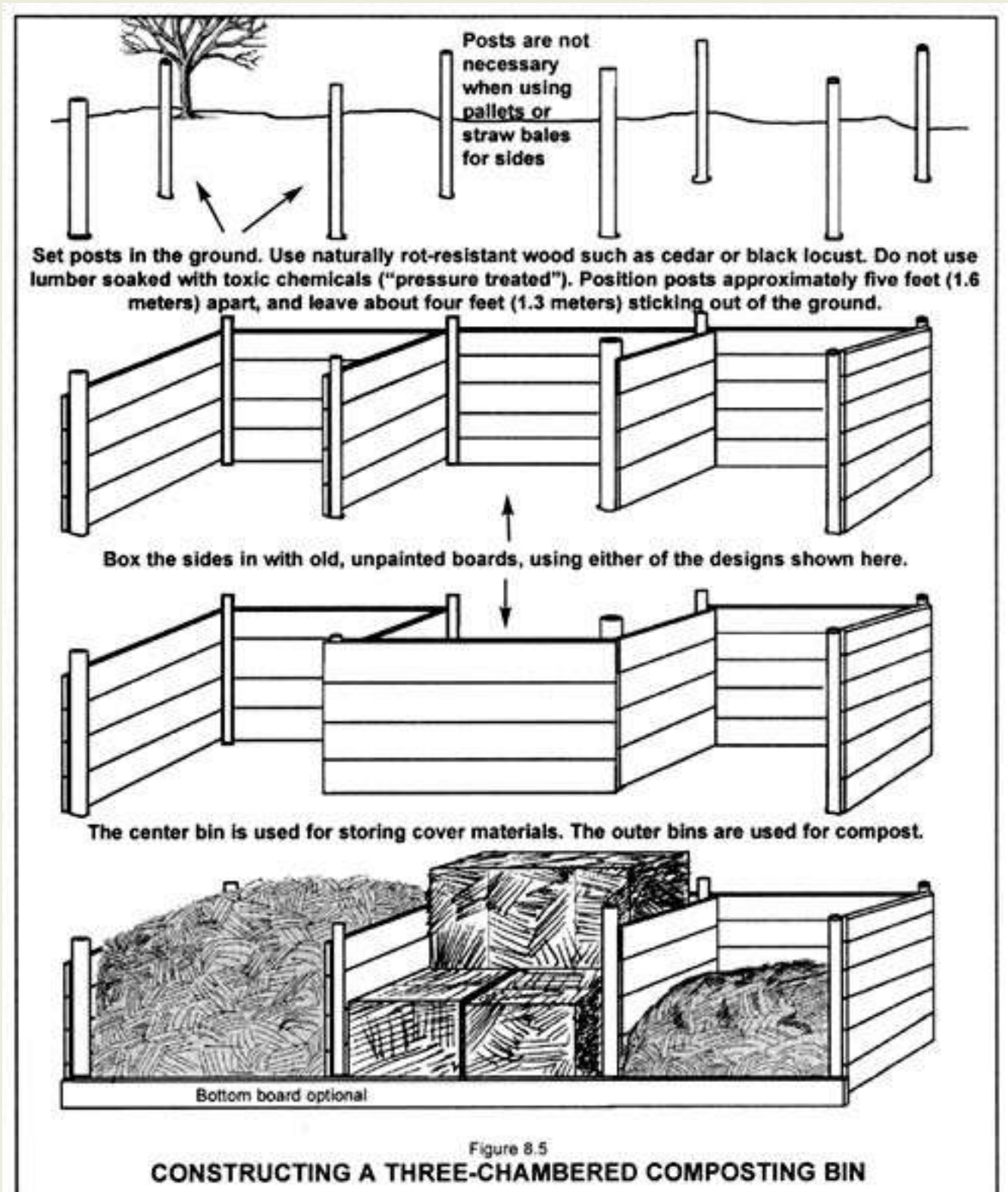
**MENU: [HOME](#) » [Reconstruction](#) » [Recovery](#) » [Renewal](#) » [Survival](#) » [Humanure Content](#)**

---

---

**MENU:** [HOME](#) » [Reconstruction](#) » [Recovery](#) » [Renewal](#) » [Survival](#) » [Humanure Content](#)

## NORMAL COMPOSTING BIN SEQUENCE (CONTINUED)



**CONSTRUCTING A THREE-CHAMBERED COMPOSTING BIN**

The three-chambered bin is ideally suited for humanure composting. The bin can be built of pallets wired, nailed, or screwed together instead of boards. Straw or hay bales (or pallets) can be used to close the open side when filling with compost. Later, the old straw can be used as a cover material. The center bin is used for storing excess cover materials such as garden weeds, lawn grass and leaves, or bales of hay or straw.

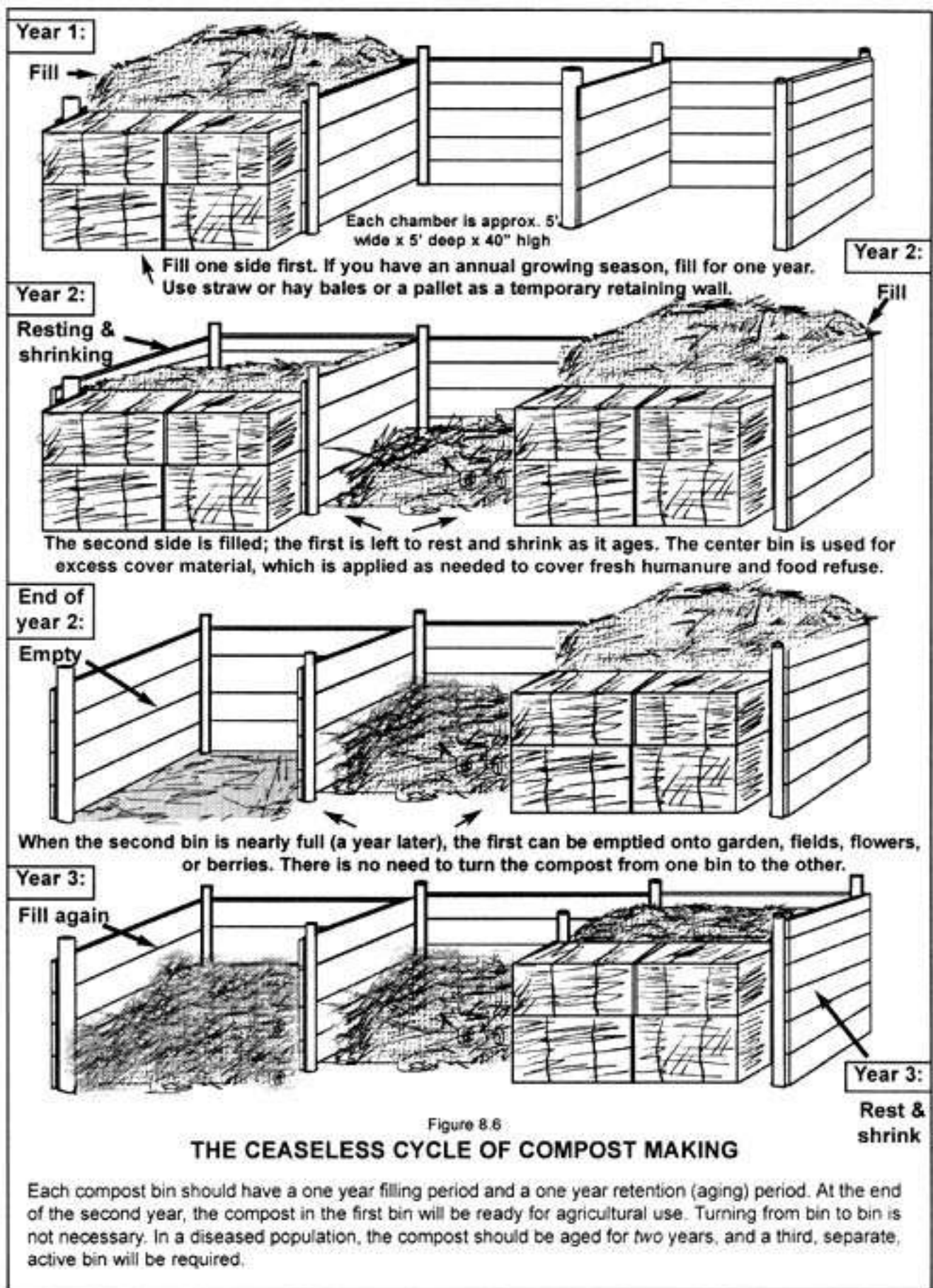
A compost pile can accept a huge amount of refuse, and even though the pile may seem to be full, as soon as you turn your back it will shrink down and leave room for more material. So when I say fill the first bin before filling the second, I mean *fill* it. A year is a good period of time for doing so in any area where there is an annual growing season. In the tropics, a shorter period may be necessary; I don't know. You readers who live in the tropics will have to figure that out. In the cold winters of the north, it is quite likely that the compost will freeze solid. You can, however, keep adding to the pile all winter. In the spring when it thaws out, the compost should work up a head of steam as if nothing happened.

Follow a natural timing cycle when making compost, one that is in tune to your agricultural cycle. A yearly cycle works best for me in Pennsylvania, where we have an annual growing cycle (one growing season per year). By late spring, the compost bin has been completely filled and it's time to let it sit until the next spring, when the finished compost will be ready to be removed and added to the garden.

The system outlined above will not yield any compost until two years after the process has started (one year to build the first pile and an additional year for it to age). However, after the initial two year start-up period, an ample amount of compost will be available on an annual basis.



A few people wrote to me wondering what happens to the leachate from the compost pile. Apparently they imagined that noxious fluids were draining into the soil under the pile, and they were concerned that this would constitute a violation of environmental regulations. Ironically, in most rural and many suburban areas, the alternative would be to use a septic system for waste disposal. Septic systems are *designed* to leach waste into the soil. That makes me wonder why people are concerned about possible leaching into the soil from compost while they show no concern for the leaching from septic systems. The answer to the leaching question is two-fold. First, compost *requires* a lot of moisture; evaporated moisture is one of the main reasons why compost shrinks so much. Compost piles are not inclined to *drain* moisture unless during a very heavy rain. Most rainwater is absorbed by the compost, but in heavy rainfall areas a roof or cover can be placed over the compost pile at appropriate times in order to prevent leaching. Second, a thick biological sponge is layered under the compost before the pile is built. This acts as a leachate barrier. If these two factors aren't effective enough, it is a simple matter to place a layer of plastic underneath the compost pile, under the biological sponge, before the pile is built. Fold the plastic so that it collects any leachate and drains into a sunken five gallon bucket. If leachate collects in the bucket, pour it back over the compost pile. The plastic, however, will act as a biological barrier between the soil and the compost, and its use is therefore not recommended by the author. The interface between the compost pile and the soil acts as a corridor for soil organisms to enter the compost pile, and plastic will prevent that natural migration. However, the plastic can provide simple and effective leachate prevention, if needed.



Source: *The Humanure Handbook*. Jenkins Publishing, PO Box 607, Grove City, PA 16127. To order, phone: 1-800-639-

4099.

<http://www.jenkinspublishing.com/>

---

**MENU: [HOME](#) » [Reconstruction](#) » [Recovery](#) » [Renewal](#) » [Survival](#) » [Humanure Content](#)**

---

---

## PATHOGENIC POPULATIONS AND A TWO YEAR RETENTION TIME

### DO'S AND DON'TS OF A THERMOPHILIC TOILET COMPOSTING SYSTEM

DO — Collect urine, feces, and toilet paper in the same toilet receptacle. Urine provides essential moisture and nitrogen.

DO — Keep a supply of clean, organic cover material handy to the toilet at all times. Rotting sawdust, peat moss, leaf mould, and other such cover materials prevent odor, absorb excess moisture, and balance the C/N ratio.



DON'T — Segregate urine or toilet paper from feces.

DON'T — Turn the compost pile if it is being continuously added to and a batch is not available. Allow the active thermophilic layer in the upper part of the pile to remain undisturbed.

DON'T — Use lime or wood ashes on the compost pile. Put these things directly on the soil.



DO — Keep another supply of cover material handy to the compost bins for covering the compost pile itself.

Coarser materials such as hay, straw, weeds, leaves, and grass clippings, prevent odor, trap air in the pile, and balance the C/N ratio.

DO — Deposit humanure into a depression in the top center of the compost pile, not around edges.

DO — Add a mix of organic materials to the humanure compost pile, including all food scraps.

DO — Keep the top of the compost pile somewhat flat. This allows the compost to absorb rainwater, and makes it easy to cover fresh material added to the pile.

DO — Use a compost thermometer to check for thermophilic activity. If your compost does not seem to be adequately heating, use the finished compost for berries, fruit trees, flowers, or ornamentals, rather than food crops. Or allow the constructed pile to age for two full years before garden use.

DON'T — Expect thermophilic activity until a sufficient mass has accumulated.

DON'T — Deposit anything smelly into a toilet or onto a compost pile without covering it with a clean cover material.

DON'T — Allow dogs or other animals to disturb your compost pile. If you have problems with animals, install wire mesh or other suitable barriers around your compost, and underneath, if necessary.

DON'T — Segregate food items from your humanure compost pile. Add all organic materials to the same compost bin.

DON'T — Use the compost before it has fully aged. This means one year after the pile has been constructed, or two years if the humanure originated from a diseased population.

DON'T — Worry about your compost. If it does not heat to your satisfaction, let it age for a prolonged period, then use it for horticultural purposes.

Fecophobes, as we have seen throughout this book, believe that all human excrement is extremely dangerous, and will cause the end of the world as we know it if not immediately flushed down a toilet. Some insist that humanure compost piles must be turned frequently — to ensure that all parts of the pile are subjected to the internal high temperatures.

The only problem with that idea is that most people produce organic refuse a little at a time. For example, most people defecate once a day. A large amount of organic material suitable for thermophilic composting is therefore usually not available to the average person. As such, we who make compost a daily and normal part of our lives tend to be “continuous composters.” We add organic material

continuously to a compost pile, and almost never have a large “batch” that can be flipped and turned all at once. In fact, a continuous compost pile will have a thermophilic layer, which will be located usually in the top two feet or so of the pile. If you turn the compost pile under these conditions, that layer will become smothered by the thermophilically “spent” bottom of the pile, and all thermophilic activity will grind to a halt.

In healthy human populations, therefore, turning a continuous compost pile is not recommended. Instead, all humanure deposits should be deposited in the top center of the compost pile in order to feed it to the hot area of the compost, and a thick layer of insulating material (e.g., hay) should be maintained over the composting mass. Persons who have doubts about the hygienic safety of their finished humanure compost are urged to either use the compost for non-food crops or orchards, or have it tested at a lab before using on food crops.

On the other hand, one may have the need to compost humanure from a population with known disease problems. If the organic material is available in *batches*, then it can be turned frequently during the thermophilic stage in order to enhance pathogen death. After the thermophilic stage, the compost can be left to age for at least a year.

If the organic material is available only on a continuous basis, and turning the pile, therefore, is counterproductive, an *additional* year-long curing period is recommended. This will require one more composting bin in addition to the two already in use. After the first is filled (presumably for a year), it is left to rest *for two years*. The second is filled during the second year, then it is left to rest for two years. The third is filled during the third year. By the time the third is filled, the first has aged for two years and should be pathogen-free and ready for agricultural use. This system will create an initial lag-time of three years before compost is available for agricultural purposes (one year to build the first pile, and two more years retention time), but the extra year’s retention time will provide added insurance against lingering pathogens. After the third year, finished compost will be available on a yearly basis. Again, if in doubt, either test the compost for pathogens in a laboratory, or use it agriculturally where it will not come in contact with food crops.

#### **A TIP FROM MR. TURDLEY**

Sawdust works best in compost when it comes from logs, not kiln-dried lumber. Although kiln-dried sawdust (from a wood-working shop) will compost, it is a dehydrated material and will not decompose as quickly as sawdust from fresh logs, which are found at sawmills. Kiln-dried sawdust may originate from “pressure-treated” lumber, which usually is contaminated with chromated copper arsenate, a known cancer-causing agent, and a dangerous addition to any backyard compost pile. Sawdust from logs can be an



inexpensive and plentiful local resource in forested areas. It should be stored outside where it will remain damp and continue to decompose. Although some think sawdust will make soil acidic, a comprehensive study between 1949 and 1954 by the Connecticut Experiment Station showed no instance of sawdust doing so.

Source: Rodale, The Complete Book of Composting, 1960, p. 192.

Source: *The Humanure Handbook*. Jenkins Publishing, PO Box 607, Grove City, PA 16127. To order, phone: 1-800-639-4099.

<http://www.jenkinspublishing.com/>

---

**MENU: [HOME](#) » [Reconstruction](#) » [Recovery](#) » [Renewal](#) » [Survival](#) » [Humanure Content](#)**

---

## ANALYSES

After nearly 14 years of composting all of my family's and visitors' humanure on the same spot about 50 feet from my garden, and using all of the finished compost to grow the food in our single garden, I analyzed my garden soil, my yard soil (for comparison), and my compost, each for fertility and pH, using LaMotte test kits from the local university.<sup>1</sup> I also sent samples of my feces to a local hospital lab to be analyzed for indicator parasitic ova or worms.

The humanure compost proved to be adequate in nitrogen (N), and rich in phosphorus (P), and potassium (K), and higher than either the garden or the yard soil in these constituents as well as in various beneficial minerals. The pH of the compost was 7.4 (slightly alkaline), and no lime or wood ashes had been added during the composting process. This is one reason why I don't recommend adding lime (which raises the pH) to a compost pile. A finished compost would ideally have a pH around, or slightly above, 7 (neutral).

The garden soil was slightly lower in nutrients (N, P, K) than the compost, and the pH was also slightly lower at 7.2. I had added lime and wood ashes to my garden soil over the years, which may explain why it was slightly alkaline. The garden soil, however, was still significantly higher in nutrients and pH than the yard soil (pH of 6.2), which remained generally poor.

My stool sample was free of pathogenic ova or parasites. I used my own stool for analysis purposes because I had been exposed to the compost system and the garden soil longer than anyone else in my family by a number of years. I had freely handled the compost, with bare hands, year after year, with no reservations (my garden is mostly hand-worked). I repeated the stool analysis a year later (after 15 years of exposure) again with negative results (no ova or parasites observed). Hundreds of people had used my compost toilet over the years, prior to these tests.

These results indicate that humanure compost is a good soil builder, and that no intestinal parasites were transmitted from the compost to the compost handler. This wasn't a laboratory experiment; it was a real life situation conducted over a period of 15 years. The whole process, for me, has been quite successful.



Adequately aged, thermophilically composted humanure is a pleasant-smelling, hygienic material. It can be freely handled and used as mulch in a food garden. The author's asparagus bed is shown here getting its 17th annual spring mulching.

Another five years have passed since I did those analyses, and over the entire 20 year period, all of the humanure compost my family has produced has been used in our food garden (see color photos following this chapter). We have raised a lot of food with that compost, and a crop of lovely and healthy children with that food.

One person commented that the Ova & Parasite lab analyses I had done at the local hospital were pointless. They didn't prove anything, or so the contention went, because there may not have been any contamination by intestinal parasites in the compost to begin with. If, after fifteen years and literally hundreds of users, no contaminants made their way into my compost, then why do people worry about them so much? Perhaps this proves that the fears are grossly overblown. The point is that my compost has not created any health problems for me or my family, and that's a very important point, one that the fecophobes should take note of.

*Source: The Humanure Handbook. Jenkins Publishing, PO Box 607, Grove City, PA 16127. To order, phone: 1-800-639-4099.*

<http://www.jenkinspublishing.com/>

**MENU:** [HOME](#) » [Reconstruction](#) » [Recovery](#) » [Renewal](#) » [Survival](#) » [Humanure Content](#)

---

---

**MENU:** [HOME](#) » [Reconstruction](#) » [Recovery](#) » [Renewal](#) » [Survival](#) » [Humanure Content](#)

## MONITORING COMPOST TEMPERATURE

### ANOTHER TIP FROM MR. TURDLEY

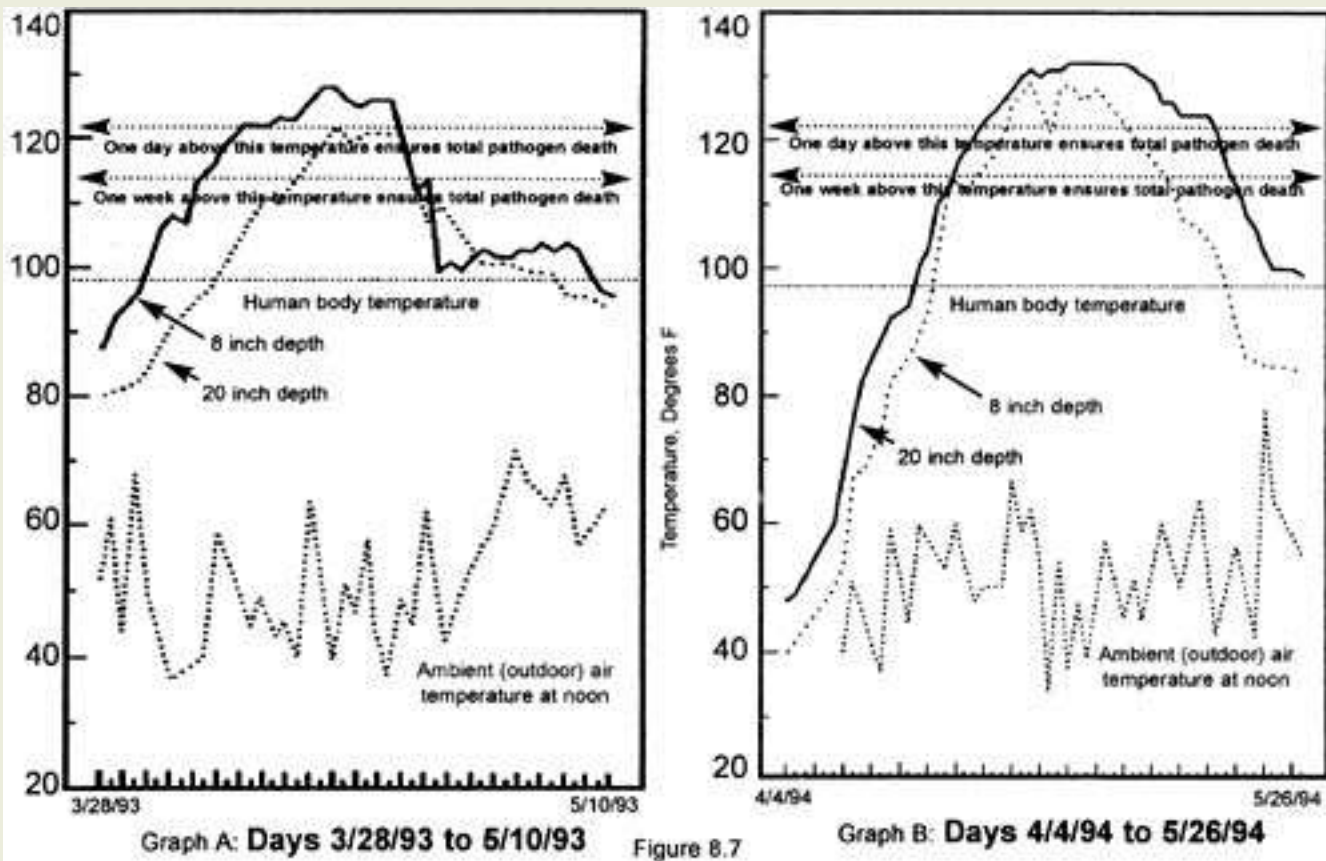


### THE SECRET OF COMPOSTING HUMANURE IS TO KEEP IT COVERED

Always thoroughly cover toilet deposits with a clean, organic cover material such as rotting sawdust, peat moss, leaf mould, rice hulls, or other suitable material to prevent odor, absorb urine, and balance the nitrogen. Always cover toilet deposits again, after adding them to the compost pile, with a clean cover material such as hay, straw, weeds, grass clippings, leaves, or other suitable material in order to prevent odors and flies, to create air spaces in the compost pile, and to balance the nitrogen. Such cover materials also add a blend of organic materials to the compost, and the variety supports a healthier microbial population.

Figure 8.7 shows the rise in temperature of humanure compost piles (feces, urine, and food scraps) which had been frozen all winter. The compost consisted primarily of deposits from the sawdust toilet, which contained raw hardwood sawdust (just enough to cover the material in the toilet), humanure including urine, and toilet paper. In addition to this material, kitchen food scraps were added to the pile intermittently throughout the winter, and hay was used to cover the toilet deposits on the pile. Some weeds and leaves were added now and then.

The material was continuously collected over a period of about four months from a family of four, and added to an existing compost pile. Nothing special was done to the pile at any time. No unusual ingredients were added, no compost starters, no water, no animal manures other than human (although a little chicken manure was added to the pile charted on the right, which may explain the higher composting temperatures). No turning was done whatsoever. The compost piles were situated in a three-sided, open-topped wooden bin on bare soil, outdoors. The only imported materials (not from the home) were sawdust, a locally abundant resource, and hay from a neighboring farm (less than two bales were used during the entire winter).



Graph A: Days 3/28/93 to 5/10/93

Figure 8.7

Graph B: Days 4/4/94 to 5/26/94

### TEMPERATURE CURVE OF HUMANURE COMPOST PILES AFTER SPRING THAW

The above compost piles were situated outdoors, in wooden bins, on bare soil. The compost was unturned and no compost starters were used. Ingredients included humanure, urine, food scraps, hay, weeds, leaves, and some chicken manure (on right). The compost was frozen solid, but exhibited the above temperature climb after thawing. Fresh material was added to the compost pile regularly while these temperatures were being recorded on unmoved thermometers. The hot area of the compost pile remained in the upper section of the compost as the pile continued to be built during the following summer. In the fall, the compost cooled down, finally freezing and becoming dormant until the following spring. It is imperative that humanure compost rise above the temperature of the human body for an extended period of time. This is the "fever effect," which is necessary to destroy pathogens. A temperature exceeding 120°F for at least one day is preferred, although lower temperatures for longer periods can be effective (see Chapter 7). The heating of the compost should be followed by a lengthy curing period (at least a year).





“Thank you for a wonderful book on a subject where little information is available. We started using our ‘system’ the day after receiving your book. It took about two hours to put together. I wish that more problems that at first seemed complicated and expensive could be solved as simply as this one has with your help.” J.F. in NY

From a Christmas letter to friends and relatives:

“I am sorry to say that the solar toilet...never got off the ground. The plans from the book were sketchy and we weren’t able to get it to work. It’s sitting in the back of the property covered and waiting to be converted into a solar oven. But luckily we read another book [Humanure Handbook] which had an even better method suited for our household. With minimal fuss and expense we set up the system, and it’s working great.” J.S. in CA

Two thermometers were used to monitor the temperature of this compost, one having an 8” probe, the other having a 20” probe. The outside of the pile (8” depth) shown on Graph A was heated by thermophilic activity before the inside (20” depth). The outside thawed first, so it started to heat first. Soon thereafter, the inside thawed and also heated. By April 8th, the outer part of the pile had reached 50°C (122°F) and the temperature remained at that level or above until April 22nd (a two-week period). The inside of the pile reached 122°F on April 16th, over a week later than the outside, and remained there or above until April 23rd. The data suggest that the entire pile was at or above 122°F for a period of eight days before starting to cool. The pile shown in Graph B was above 122°C for 25 days.

According to Dr. T. Gibson, Head of the Department of Agricultural Biology at the Edinburgh and East of Scotland College of Agriculture, “All the evidence shows that a few hours at 120 degrees Fahrenheit would eliminate [pathogenic microorganisms] completely. There should be a wide margin of safety if that temperature were maintained for 24 hours.” [2](#)

The significance of the previous graphs is that they show that the humanure compost required no coaxing to heat up sufficiently to be rendered hygienically safe. It just did it on its own, having been provided the simple requirements a compost pile needs.



“The one alteration I’m going to make to the potty pictured in your book is a hinged door on the front and an attachable wagon handle, and, of course, large wheels on a shallow box the bucket rests in. That’s only because I’m older (55), small and have arthritis. I can’t pick up five gallons of anything wet and heavy. I could empty the bucket on a daily basis, but I don’t know if that’s a good idea or if it would screw up the working of the compost pile [author’s note: it wouldn’t]. Thank you for taking on the work and expense of sharing your experience with those of us who want to leave small or no footprints on our Mother Earth. (P.S. My children will be horrified! No doubt they will choose to stay at a motel and eat at restaurants.)” C.M. in AZ

## THE SAWDUST TOILET ON CAMPING TRIPS

Humanure composters have tricks up their sleeves. Ever go on a week-long camping trip or to a camping music festival and hate using those awful portable chemical toilets that stink? If you have a humanure compost bin at home, simply take two five gallon buckets with you on the trip. Fill one with a cover material, such as rotted sawdust, and put a lid on it. Set it inside the empty bucket and pack it along with your other camping gear. Voila! One portable composting toilet! When you set up your camp, string up a tarp for privacy and set the two containers in the private space. Use the empty container as a toilet, and use the cover material to keep it covered. Place a lid on it when not in use. No standing in line, no odors, no chemicals, no pollution. This toilet will last several days for two people. When you leave the camp, take the “soil nutrients” home with you and add them to your compost pile. You will probably be the only campers there who didn’t leave anything behind, a little detail that you can be proud of. And the organic material you collected will add another tomato plant or blueberry bush to your garden. You can improve on this system by taking a toilet seat that clamps on a five gallon bucket, or even taking along a home-made toilet box with seat (as shown in Figures 8.3 and 8.4).

## A SIMPLE URINAL

Want to collect urine only? Maybe you want a urinal in a private office, bedroom, or shop. Simply fill a five gallon bucket with rotted sawdust or other suitable material, and put a tight lid on it. A bucket full of sawdust will still have enough air space in it to hold about a week’s worth of urine from one adult. Urinate into the bucket, and replace the lid when not in use. For a fancy urinal, place the sawdust bucket in a toilet cabinet such as illustrated in Figures 8.1, 8.2, 8.3, and 8.4. When the bucket is full, deposit it on your compost pile. The sawdust inhibits odors, and balances the nitrogen in the urine. It sure beats the frequent trips to a central toilet that coffee drinkers are inclined to

make, and no “soil nutrients” are going to waste down a drain.



## WHY NOT PLACE THE COMPOST BINS DIRECTLY UNDERNEATH THE TOILET?

The thought of carrying buckets of humanure to a compost bin can deter even the most dedicated recycler. What if you could situate your toilet directly over your compost bins? Here's some reader feedback:

"I finally write back to you after 2 1/2 years of excitingly successful and inspiring use of humanure methods applied to a 'direct shitter' compost. We indeed built a beautiful humanure receptacle 10 feet long, 4 feet high and 5 feet wide, divided into two chambers. One chamber was used (sawdust after every shit, frequent green grass and regular dry hay applications) from May 1996 until June 1997, then

nailed shut. We moved to the second chamber until June 1998 — when with excitement mounting, we unscrewed the boards at the back of the “Temple of Turds” (our local appellation) and sniffed the aroma...of the most gorgeous, chocolate brownie, crumbly compost ever SEEN. Yes, I thrust my hands fully into the heavenly honey pot of sweet soil, which soon thereafter graced the foundations of our new raspberry bed. Needless to say, the resulting berries knew no equal. Humanure and the potential for large-scale . . . even a city size composting collection (apartment building toilets into a central collection dumpster), along with the crimes of the so-called “septic system,” has become one of my most favored topics of conversation and promotion. Often through direct exposition at our farm. Many thanks for your noble work of art and contribution to this stinky species of ape.” R.T. in CT



## MORE ON INSTALLING THE COMPOST BINS UNDER YOUR HOUSE

The **Straw Bale House** in Ship Harbor, Nova Scotia, Canada, built in 1993, employed an outhouse until 1998 when a composting toilet was built. The toilet allowed for the direct depositing of humanure into compost chambers underneath the house. Designer/builder Kim Thompson provides feedback:

*“Having heard and experienced mixed success with commercial composting toilets, it was exciting to read the Humanure Handbook and*

*have systems detailed which reinforced ideas that had only existed with me intuitively before. I did a lot of research on the subject, but as far as I could make out, the indoor system I wanted to try hadn't been done before. After several phone conversations with Joe Jenkins, his encouragement, and a sharing of plans, I went ahead with the project. Two concrete chambers, three feet high by five feet square, with four inch thick walls, were built on a six inch gravel base with a French drain, underneath the house. In the bathroom above, a wooden box was fitted with a standard toilet seat as*

*well as a compartment for sawdust storage. All kitchen scraps, straw, and some garden compost were added regularly to the compost chambers, as well as the sawdust cover material. Red wiggler worms were added as well. Two and a half residents used the toilet, and the first chamber filled in six months.*

*Because there wasn't a good starter base of organic material, and because there was no drain (one was added later), the compost was, for many months, a sloppy, ineffectual mess. I now recommend layering the following materials in a composting chamber before it is used: one foot of straw, six inches of sawdust, a couple buckets of compost as a starter, one foot of leaf compost, and three inches of sawdust (or something like that depending on availability of local resources). Be sure to include a drainage system from the chambers to prevent a build-up of urine.*

*Make sure there are screens over the access doors to the chambers which can be easily removed, as easy access to the chambers makes it more likely that they will be maintained and monitored regularly. In a northern climate the chambers need to be constructed in such a way as to insure that they won't heave with the frost. It is important to insulate the chambers during the winter months to optimize conditions for thermophilic activity.*

*The learning curve on how to maintain and use the system efficiently has been steep. It is like learning how to make bread, easy when you know how. Smell has been the biggest problem so far. We have tried three different ways of venting and find that it still smells on occasion. Venting is currently done through a stove-pipe flue. I intend to install a small photovoltaic fan that will either draw air into the stove-pipe or directly outside through a vent. I injured myself over the winter and found that maintenance of the composting toilet system for a single person with a disability was difficult, especially hauling the bags of frozen sawdust cover material into the storage area. I had thought that establishing thermophilic activity in the second chamber over the winter months would be difficult, but a couple buckets of compost from the first chamber activated the new chamber almost immediately. The draft created by the toilet seat hole while in use, especially in the winter, has been variously described. A simple way of sealing the seat when not in use needs to be developed. We have been using a piece of polystyrene foam with a handle which sits in the box under the seat. It works, but isn't elegant.*

*I love the fact that I don't have to deal with a septic system and that the compost produced will help feed my family. The composting toilet complements well my work with low impact, natural building systems. Many people who contact Straw Bale Projects about construction are also interested in the compost toilet alternative."*

For more information contact Kim Thompson, Straw Bale Projects, 13183 Hwy #7, Ship Harbor, NS Canada B0J 1Y0; EMail: <mailto:shipharbor@ns.sympatico.ca>

<http://www.jenkinspublishing.com/>

---

**MENU: [HOME](#) » [Reconstruction](#) » [Recovery](#) » [Renewal](#) » [Survival](#) » [Humanure Content](#)**

---

---

## FECOFRIGGINFOBIA

There seems to be an irrational fear among fecophobes that if you don't die instantly from humanure compost, you'll die a slow, miserable, and wretched death, or you'll surely cause an epidemic of something like the plague and everyone within 200 miles of you will die, or you'll become so infested with parasitic worms that you'll no longer be recognized as human (your head will look like spaghetti).

These fears exist perhaps because much of the information in print concerning the recycling of humanure is confusing, erroneous, or incomplete. For example, when researching the literature during the preparation of this book, I found it surprising that almost no mention is ever made of the thermophilic composting of humanure as a viable alternative to other forms of on-site sanitation. When "bucket" systems are mentioned, they are also called "cartage" systems, and are universally decried as being the least desirable sanitation alternative. For example, in *A Guide to the Development of On-Site Sanitation* by Franceys et al., published by the World Health Organization in 1992, "bucket latrines" are described as "*malodorous, creating a fly nuisance, a danger to the health of those who collect or use the nightsoil, and the collection is environmentally and physically undesirable.*" This sentiment is echoed in Rybczynski's (et al.) World Bank funded work on low-cost sanitation options, where it is stated that "*the limitations of the bucket latrine include the frequent collection visits required to empty the small container of [humanure], as well as the difficulty of restricting the passage of flies and odors from the bucket.*"

### YET ANOTHER TIP FROM THE INFAMOUS MR. TURDLEY

#### PRESSURE TREATED LUMBER SHOULD NEVER BE USED TO MAKE COMPOST BINS

Or for anything else, either, when the lumber is soaked with chromated copper arsenate. CCA saturated lumber would be more appropriately called "cancer-soaked" lumber rather than euphemistically referred to as "pressure treated."

Both arsenic and chromium have been classified as human



carcinogens (causing cancer) and are suspected mutagens (causing mutations). The poisons in cancer-soaked lumber are widely documented to leach into the soil and rub off onto skin and clothing.

Such material has no place in organic gardens or compost bins. You can't even safely burn cancer-soaked lumber to get rid of it — it produces highly toxic fumes and ash. Be very careful when getting sawdust from a lumber yard. It may contain highly toxic cancer-soaked sawdust!

I've personally used a sawdust toilet for 20 years and it has never caused odor problems, fly problems, health problems, or environmental problems. Quite the contrary, it has actually *enhanced* my health, the health of my family, and the health of my environment by producing healthy, organic food in my garden, and by keeping human waste out of the water table. Nevertheless, Franceys et al. go on to say that “[humanure] collection should never be considered as an option for sanitation improvement programmes, and all existing bucket latrines should be replaced as soon as possible.” Say what?

Obviously Franceys et al. are referring to the practice of collecting humanure in buckets without a cover material (which would surely stink to high heaven and attract flies) and without any intention of composting the humanure. Such buckets of feces and urine are presumably dumped raw into the environment. Naturally, such a practice should be decried and strongly discouraged, if not outlawed. However, rather than forcing people who use such crude waste disposal methods to switch to other more prohibitively costly waste disposal methods, perhaps it would be better to educate those people about *resource recovery*, about the *human nutrient cycle*, and about *thermophilic composting*. It would be more constructive to help them acquire adequate and appropriate *cover materials* for their toilets, assist them in constructing compost bins, and thereby eliminate waste, pollution, odor, flies, and health hazards altogether. I find it inconceivable that intelligent, educated scientists who observe bucket latrines and the odors and flies associated with them do not see that the simple addition of a clean organic cover material to the system would solve the aforementioned problems, and balance the nitrogen of the humanure with carbon.

Franceys et al. state, however, in their aforementioned book, that “*apart from storage in double pit latrines, the most appropriate treatment for on-site sanitation is composting.*” I would agree that composting, when done properly, is the most appropriate method of on-site sanitation available to humans. I would not agree that double pit storage is more appropriate than thermophilic composting unless it could be proven that all human pathogens could be destroyed using such a double pit system,

and that such a system would produce no unpleasant odor, and would not require the segregation of urine from feces. According to Rybczynski, the double pit latrine shows a reduction of *Ascaris* ova of 85% after two months, a statistic which does not impress me. When my compost is finished, I don't want *any* pathogens in it.

Ironically, the work of Franceys et al. further illustrates a “decision tree for selection of sanitation” that indicates the use of a “compost latrine” as being one of the least desirable sanitation methods, and one which can only be used if the user is willing to collect urine separately. Unfortunately, contemporary professional literature is rife with this sort of inconsistent and incomplete information which would surely lead a reader to believe that composting humanure just isn't worth the trouble.

On the other hand, Hugh Flatt, who, I would guess, is a practitioner and not a scientist, in *Practical Self-Sufficiency* tells of a sawdust toilet system he had used for decades. He lived on a farm for more than 30 years which made use of “bucket lavatories.” The lavatories serviced a number of visitors during the year and often two families in the farmhouse, but they used no chemicals. They used sawdust, which Mr. Flatt described as “absorbent and sweet-smelling.” The deciduous sawdust was added after each use of the toilet, and the toilet was emptied on the compost pile daily. The compost heap was located on a soil base, the deposits were covered each time they were added to the heap, and kitchen refuse was added to the pile (as was straw). The result was “*a fresh-smelling, friable, biologically active compost ready to be spread on the garden.*” <sup>3</sup>



### From a Public Radio Commentary

“People are saying that the Year 2000 computer problem could foul up a lot of stuff we usually depend on, all at once. I thought I'd give this Y2K Practice Day a try. Turn off the heat, lights, water and phones. Just for 24 hours. The day before Practice Day, I complained to Larry, telling him that I was bitterly disappointed not to try out an emergency toilet. This complaining really paid off. Larry, who's also a writer researching Year 2000 emergency preparedness, phoned a man named Joe Jenkins, author of a book called the Humanure Handbook. Joe reassured my husband of the safe, sanitary, and uncomplicated

method for composting human waste. His solution is based on 20 years of scholarly study. It turns out that the thermophilic bacteria in human waste, when mixed with organic material like peat moss or sawdust, creates temperatures over 120 degrees Fahrenheit, rapidly killing pathogens just as Mother Nature intended.

We grew bold and daring and decided to use our emergency five gallon bucket with the toilet seat, layering everything with peat moss. Larry spent maybe a half hour building a special compost bin. This was right up his alley, since he already composts all the kitchen scraps, yard, and dog wastes.

Surprisingly, I found myself liking that little toilet. It was comfortable, clean, with no odor, just a slightly earthy smell of peat moss. The soul-searching came when I contemplated going back to the flush toilet.



By coincidence, I recently heard a presentation by the director of the local waste treatment facility. He was asked to address the issue of Year 2000 disruptions and explain what preparations were being made. In a matter-of-fact voice, he described what a visitor from another planet would undoubtedly consider a barbaric custom. First, we defecate and urinate in our own clean drinking water. In our town, we have 800 miles of sewers that pipe this effluent to a treatment facility where they remove what are euphemistically called solids. Then they do a bunch more stuff to the water, I forget exactly what. But I do remember that at one point, they dose it with a potent poison — chlorine, of course — and then they do their best to remove the chlorine. When all this is done, the liquid gushes into the Spokane River.

At this meeting was a man named Keith who lives on the shores of Long Lake, down river from us. Keith was quite interested to know what might occur if our sewage treatment process was interrupted. The waste treatment official assured him that all would be well, but I couldn't help reflecting that Keith might end up drinking water that we had been flushing. I like Keith. So I decided to keep on using my camp toilet.

My husband is a passionate organic gardener, at his happiest with a shovel in his hand, and he's already coveting the new compost. He's even wondering if the neighbors might consider making a contribution. I'm just grateful the kids are grown and moved out, because they'd have a thing or two to say."

**Judy Laddon in WA (excerpted with permission)**

Perhaps the "experts" will one day understand, accept, and advocate simple humanure composting techniques such as the sawdust toilet. However, we may have to wait until Composting 101 is taught at the university, which may occur shortly after hell freezes over.

In the meantime, those of us who use simple humanure composting methods must view the comments of today's so-called experts with a mixture of amusement and chagrin. Consider, for example, the following comments posted on the World Wide Web by an "expert." A reader posted a query on a compost toilet forum website wondering if anyone had any scientific criticism about the above mentioned sawdust toilet system. The expert replied that he was about to publish a new book on composting toilets, and he offered the following excerpt:

*"Warning: Though powerfully appealing in its logic and simplicity, I'd expect this system to have an especially large spread between its theoretical and its practical effectiveness. If you don't have a consistent track record of maintaining high temperatures in quick compost piles, I'd counsel against using this system. Even among gardeners, only a small minority assemble compost piles which consistently attain the necessary high temperatures . . . Health issues I'd be concerned about are 1) bugs and small critters fleeing the high-temperature areas of the pile and carrying a coat of pathogen laden feces out of the pile with them; 2) large critters (dog, raccoons, rats . . .) raiding the pile for food and tracking raw waste away; and 3) the inevitable direct exposure from carrying, emptying, and washing buckets.*

*Some clever and open-minded folk have hit on the inspiration of composting feces . . . by adding them to their compost piles! What a revolutionary concept! . . . Sound too good to*

*be true? Well, in theory it is true, though in practice I believe that few folks would pass all the little hurdles along the way to realizing these benefits. Not because any part of it is so difficult, just that, well, if you never ate sugar and brushed and flossed after every meal, you won't get cavities either.”<sup>4</sup>*

Sound a bit cynical? The above comments are entirely lacking in scientific merit, and expose an “expert” who has no experience whatsoever about the subject on which he is commenting. It is disheartening that such opinions would actually be published, but not surprising. The writer hits upon certain knee-jerk fears of fecophobes. His comment on bugs and critters fleeing the compost pile coated with pathogen-laden feces is a perfect example. It would presumably be a bad idea to inform this fellow that fecal material is a product of his body, and that if it is laden with pathogens, he’s in very bad shape. Furthermore, there is some fecal material probably inside him at any given moment. Imagine that — pathogen-infested fecal material brimming with disease-causing organisms actually sitting in the man’s bowels. How can he survive?

When one lives with a humanure composting system for an extended period of time, one understands that fecal material comes from one’s body, and exists inside oneself at all times. With such an understanding, it would be hard to be fearful of one’s own humanure, and impossible to see it as a substance brimming with disease organisms, unless, of course, one is diseased.

The writer hits upon another irrational fear — large animals, including rats, invading a compost pile and spreading disease all over creation. Compost bins are easily built to be animal-proof. If animals are a problem, the problem can be remedied by lining a compost bin with chicken wire, or surrounding the compost with pallets, straw bales, or similar barriers. In 20 years of humanure composting, we have never had a problem with animals, have never seen a rat in our compost, and our compost bins are not wire-lined. We have had dozens of skunks, possums, and raccoons in our chicken house, but never in our compost pile 50 feet away. It seems that the thermophilic composting process itself makes the organic material undesirable for larger animals, including dogs.

The writer warns that most gardeners do not have thermophilic compost. Most gardeners also leave critical ingredients out of their compost, thanks to the fear-mongering of the ill-informed. Those ingredients are humanure and urine, which are quite likely to make one’s compost thermophilic. Commercial composting toilets almost never become thermophilic. Does the author also condemn those? As we have seen, it is not only the temperature of the compost that destroys pathogens, it is retention time. The sawdust toilet compost pile requires a year’s construction time, and another year’s undisturbed retention time. When a thermophilic phase is added to this process, I would challenge anyone to come up with a more effective, earth-friendly, simpler, low-cost system for pathogen destruction.

Finally, the writer warns of “the inevitable direct exposure from carrying, emptying and washing buckets.” I’m not sure what he’s getting at here, as I have carried, emptied, and washed buckets for 20 years and never had a problem.



“We’ve been joyfully composting for some time already, and adding our humanure since this spring. Your book was immensely informative, helping to dispel some of those culturally imposed myths of fecophobia! Please know that the book is being eagerly passed about and many of our friends have also begun composting humanure, too! Again, thank you for all the years and time you and your family have spent experimenting and actively composting! Your work has been a great asset to our path of a simpler, sustainable and self-reliant lifestyle. We believe we are the keys to changing the dominant paradigm and healing the Earth. Thank you, thank you for the book!” B.C. and J.S. in AK

Other recent experts have thrown in their two cents worth on the sawdust toilet. A book on composting toilets (also about to be published as I write this), mentions the sawdust toilet system.<sup>5</sup> Although the comments are not at all cynical and are meant to be informative, a bit of misinformation manages to come through. For example, the suggestion to use “rubber gloves and perhaps a transparent face mask so you do not get anything splashed on you” when emptying a compost bucket onto a compost pile, caused groans, a lot of eyes to roll, and a few giggles when read aloud to seasoned humanure composters. Why not just wear an EPA approved moon suit and carry the compost bucket at the end of a ten-foot pole? How is it that what has just emerged from one’s body can be considered so utterly toxic? More exaggeration and misinformation existed in the book regarding temperature levels and compost bin techniques. One warning to “bury finished compost in a shallow hole or trench around the roots of non-edible plants,” was classic fecophobia. Apparently, humanure compost is to be banned from human food production, never mind the human nutrient cycle. The authors recommended that humanure compost be composted again in a non-humanure compost pile, or micro-waved for pasteurization, both bizarre suggestions. They add, “Your health agent and your neighbors may not care for this [sawdust toilet composting] method.”

I have to scratch my head and wonder why the “experts” would say this sort of thing. Apparently, the act of *composting* one’s own humanure is so radical and even revolutionary to the people who have spent their lives trying to *dispose* of the substance, that they can’t quite come to grips with the idea. Ironically, a very simple sawdust toilet used by a physician and his family in Oregon is featured and illustrated in the above book. The physician states, “*There is no offensive odor. We’ve never had a complaint from the neighbors.*” Their sawdust toilet system is also illustrated and posted on the internet, where a brief description sums it up: “*This simple composting toilet system is inexpensive both in construction and to operate and, when properly maintained, aesthetic and hygienic. It is a perfect complement to organic gardening. In many ways, it out-performs complicated systems costing hundreds of times as much.*” Often, knowledge derived from real-life experiences can be diametrically opposed to the speculations of “experts.” Sawdust toilet users find, through *experience*, that such a simple system can work remarkably well.



“My wife and I have just finished reading your handbook and found it an inspiration in our pursuit of alternative living styles. Our system is up and functioning very well for us and already building our future garden bedding. We have discovered a certain level of ‘alienation’ when ‘friends’ have discovered our system. Although not particularly concerned about this ‘friendship purification process,’ we would like to network with other like-minded people to share ideas and experiences. If you have the fortune of knowing anyone using your technique in Eastern Washington-Northern Idaho area, would you please extend to them our invitation of friendship? Thank you for your book and your leadership into the rather solitary world of fecal familiarity.” K.K. and A.K. in WA

“I line the solids bucket with newspapers so that I don’t need to rinse it out.”  
A.E. in Australia

What about “health agents”? Health authorities can be misled by misinformation, such as that stated by the above authors. Health authorities, according to my experience, generally know very little, if anything, about thermophilic composting. Many have never even heard of it. The health authorities who have contacted me are very interested in getting more information, and seem very open to the idea of a natural, low-cost, effective, humanure recycling system. They know that human sewage is a dangerous pollutant and a serious environmental problem, and they seem to be surprised and impressed to find out that such sewage can be avoided altogether. Most intelligent people are willing and able to expand their awareness and change their attitudes based upon new information. Therefore, if you are using a sawdust toilet and are having a problem with any authority, please give the authority a copy of this book. I have a standing offer to donate, free of charge, a copy of the *Humanure Handbook* to any permitting agent or health authority, no questions asked, upon anyone’s request — just send a name and address to the publisher at the front of this book.

Well-informed health professionals and environmental authorities are aware that “human waste” presents an environmental dilemma that is not going away.

The problem, on the contrary, is getting worse. Too much water is being polluted by sewage and septic discharges, and there has to be a constructive alternative. Perhaps that is why, when health authorities learn about the thermophilic composting of humanure, they realize that there may very likely be no better solution to the human waste problem. That may be also why I received a letter from the US Department of Health and Human Services praising my book and wanting to know more about humanure composting, or why the US Environmental Protection Agency wrote to me to praise the *Humanure Handbook* and order ten copies (and re-order more later), or why the PA Department of Environmental Protection nominated *Humanure* for a public-awareness environmental award in 1998. Fecophobes think composting humanure is dangerous. I will patiently wait until they come up with a better solution to the problem of “human waste.” I expect there will be a few cold days in hell before that happens.



“Just a note to thank you for sending the gratis copies of Humanure to our local supervisors and health director. A small but significant step forward is shown by the

article on the reverse side and no doubt your book played a part [a newspaper article titled “Law Would Back Waterless Toilets” was copied on the back of the letter]. This victory may not seem like much but, believe me, getting these troglodytes to change their minds on anything is nothing less than a miracle! R.W. in CA

*Source: The Humanure Handbook. Jenkins Publishing, PO Box 607, Grove City, PA 16127. To order, phone: 1-800-639-4099.*

<http://www.jenkinspublishing.com/>

---

**MENU: [HOME](#) » [Reconstruction](#) » [Recovery](#) » [Renewal](#) » [Survival](#) » [Humanure Content](#)**

---

---

## LEGALITIES

This is an interesting topic. It seems that some people believe that if you do anything differently from the mainstream, it must be illegal. Certainly composting humanure must be illegal. After all, humanure is a dangerous pollutant and must be immediately disposed of in a professional and approved manner. Recycling it is foolish and hazardous to your health and to the health of your community and your environment. At least that's what the fecophobes think. Therefore, recycling humanure can not be an activity that is within the law, can it? Well, yes actually, the backyard composting of humanure is probably quite within the letter of the laws to which you are subjected.

Waste disposal is regulated, and it should be. Waste disposal is potentially very dangerous to the environment. Sewage disposal and recycling are also regulated, and they should be, too. Sewage includes a host of hazardous substances deposited into a waterborne waste stream. People who compost their humanure are neither disposing of waste, nor producing sewage — they are recycling. Furthermore, regarding the regulating of composting itself, both backyard composting and farm composting are exempt from regulations unless the compost is being sold, or unless the farm compost operation is unusually large.

To quote one source, *“The US Department of Environmental Protection (DEP) has established detailed regulations for the production and use of compost created from [organic material]. These regulations exclude compost obtained from backyard composting and normal farming operations. Compost from these activities is exempt from regulation only if it is used on the property where it was composted, as part of the farming operation. Any compost which is sold must meet the requirements of the regulations.”*

[6](#)

Composting toilets are also regulated in some states. However, composting toilets are usually defined as toilets inside which composting takes place. A sawdust toilet, by definition, is *not* a composting toilet because no composting occurs in the toilet itself. The composting occurs in the “backyard” and therefore is not regulated by composting *toilet* laws. Portable toilet laws may apply instead, although the backyard compost exemption will probably allow sawdust toilet users to continue their recycling undisturbed.

A review of composting toilet laws is both interesting and disconcerting. For example, in Maine, it is apparently illegal to put kitchen food scraps down the toilet chute in a commercial composting toilet, even though the food scraps and toilet materials must go to the exact same place in the composting chamber. Such a regulation makes no sense whatsoever. In Massachusetts, finished compost from

composting toilets must be buried under six inches of soil, or hauled away and disposed of by a septage hauler. These laws are apparently written by people who are either lacking in knowledge and understanding, or are fecophobic, or, most likely, all of the above. Such laws can discourage the necessary and important recycling of humanure.

Ideally, laws are made to protect society. Laws requiring septic, waste, and sewage disposal systems are supposedly designed to protect the environment, the health of the citizens, and the water table. This is all to be commended, and conscientiously carried out by those who produce *sewage*, a waste material. If you don't produce sewage, you have no need for a sewage disposal system; laws pertaining to sewage disposal are not your concern. The number of people who produce backyard compost instead of sewage is so minimal, that few, if any, laws have been enacted to regulate the practice. The thermophilic composting of humanure is not a threat to society, it produces no pollution, does not threaten the health of humans, nor contaminate the groundwater or environment. Unfortunately, because this fact is not understood by many people, ignorance remains a problem.

It would be hard to intelligently argue that a person who produces no sewage must have a costly sewage treatment system. What would they do with it? That would be like requiring someone who doesn't own a car to have a garage. And it would be very difficult to prove that composting humanure is threatening to society, especially given the facts as presented in this book. It is much easier to prove that composting humanure is a *benefit* to society. On the other hand, Galileo, the astronomer, was arrested as a heretic and forced to renounce his theory that the Earth revolves around the sun. Yes, that was three hundred years ago, but sometimes it seems like the consciousness of our society as it relates to human manure is still back in the dark ages.

If you're concerned about your local laws, go to the library and see what you can find about regulations concerning backyard compost. Or inquire at your county seat or state agency as statutes, ordinances, and regulations vary from locality to locality. Where I live, septic system permits aren't required for new home construction, but the next county is two properties over and people there are required to have septic system permits before they can build a new dwelling. This is largely due to the fact that the water table tends to be high in my area, and septic systems don't always work, so sand mounds are required by law for sewage disposal. If you don't want to dispose of your manure but want to compost it instead (which will certainly keep it out of the water table, not to mention raise a few eyebrows at the local municipal office), you may have to stand up for your rights.

A reader called from a small state in New England to tell me his story. It seems the man had a sawdust toilet in his house, but the local municipal authorities decided he could only use an "approved" waterless toilet, meaning, in this case, an incinerating toilet. The man did not want an incinerating toilet because the sawdust toilet was working well for him and he liked making and using the compost. So he complained to the authorities, attended township meetings, and put up a fuss. To no avail. After months of "fighting city hall," he gave up and bought a very expensive and "approved" incinerating toilet. When it was delivered to his house, he had the delivery people set it in a back storage room. And that's where it remained, still in the packing box, never opened. The man continued to use his sawdust toilet for years after that. The authorities knew that he had bought the "approved" toilet, and thereafter left him alone.

He never did use it, but the authorities didn't care. He bought the damn thing and had it in his house, and that's what they wanted. Those local authorities obviously weren't rocket scientists.

Another interesting story comes from a fellow in Tennessee. It seems that he bought a house which had a rather crude sewage system — the toilet flushed directly into a creek behind the house. The fellow was smart enough to know this was not good, so he installed a sawdust toilet. However, an unfriendly neighbor assumed he was still using the direct waste dump system, and the neighbor reported him to the authorities. But let him tell it in his own words:

*“Greetings from rural Tennessee.*

*I'm a big fan of your book & our primitive outhouse employs a rotating 5-gallon bucket sawdust shitter that sits inside a 'throne.' Our system is simple & based largely on your book. We transport the poop to a compost pile where we mix the mess with straw & other organic materials. The resident in our cabin before we bought the farm used a flush toilet that sent all sewage directly to a creekbed. An un-informed neighbor complained to the state in 1998, assuming that we used the same system. The state people have visited us several times. We were forced to file a \$100 application for a septic system but the experts agree that our hilly, rocky house site is not suitable for a traditional septic system even if we wanted one. They were concerned about our grey water as well as our composting outhouse. My rudimentary understanding of the law is that the state approves several alternative systems that are very complicated and at least as expensive as a traditional septic. The simple sawdust toilet is not included & the state does not seem to want any civilian to actually transport his own shit from the elimination site to a different decomposition site. The bureaucrats tentatively approved an experimental system where our sewage could feed a person-made aquatic wetlands type thingie & they agreed to help us design & implement that system. Currently, we cannot afford to do that on our own & continue to use our sawdust bucket latrine. The officials seem to want to leave us alone as long as our neighbors don't complain anymore. So, that's a summary of our situation here in Tennessee. I've read most of the state laws on the topic; like most legal texts, they are virtually unreadable. As far as I can tell, our system is not explicitly banned but it is not included in the list of "approved" alternative systems that run the gamut from high-tech, low volume, factory-produced composting gizmos to the old fashioned pit latrine. For a while now, I've wanted to write an article on our experience and your book. Unfortunately, grad school in English has seriously slowed down my freelance writing.”*

*Cheers, A.S. in Tennessee*

Other than the above two situations, I have heard no details from other readers who may have had problems with authorities in relation to their sawdust toilets. Nevertheless, as part of the research for this second edition, I have undertaken a review of US state regulations pertaining to composting toilets, and that information is included in [Appendix 3](#).



In Pennsylvania, the state legislature has enacted legislation “*encouraging the development of resources recovery as a means of managing solid waste, conserving resources, and supplying energy.*” Under such legislation the term “disposal” is defined as “*the incineration, dumping, spilling, leaking, or placing of solid waste into or on the land or water in a manner that the solid waste or a constituent of the solid waste enters the environment, is emitted into the air or is discharged to the waters of the Commonwealth.*” <sup>7</sup> Further legislation has been enacted in Pennsylvania stating that “*waste reduction and recycling are preferable to the processing or disposal of municipal waste,*” and further stating “*pollution is the contamination of any air, water, land or other natural resources of this Commonwealth that will create or is likely to create a public nuisance or to render the air, water, land, or other natural resources harmful, detrimental or injurious to public health, safety or welfare. . .*” <sup>8</sup> In view of the fact that the thermophilic composting of humanure involves recovering a resource, requires no disposal of waste, and creates no environmental pollution, it is unlikely that anyone who conscientiously engages in such an activity would be unduly bothered by anyone. Don’t be surprised if most people find such an activity commendable, because, in fact, it is.

If there aren’t any regulations concerning backyard compost in your area, then be sure that when you’re making your compost, you’re doing a good job of it. It’s not hard to do it right. The most likely problem you could have is an odor problem, and that would simply be due to not keeping your deposits adequately covered with clean, not-too-airy, organic “biofilter” material. If you keep it covered, it does not give off offensive odors. It’s that simple. Perhaps shit stinks so people will be naturally compelled to cover it with something. That makes sense when you think that thermophilic bacteria are already in the feces waiting for the manure to be layered into a compost pile so they can get to work. Sometimes the simple ways of nature are really profound.

Few people understand that the composting of humanure is a benign method of recycling what would otherwise be a toxic waste material. For that reason, this book is recommended reading for people involved in municipal, county, or township waste treatment or permitting, or resource recovery. So when you’re feeling especially benevolent, buy an extra copy of *Humanure* and give it to your local authority. Anonymously, if necessary.

What about flies — could they create a public nuisance or health hazard? I have never had problems with flies on my compost. Perhaps the compost heats up so fast that flies don’t have a chance to enjoy it. Of course, a clean cover material is kept over the compost pile at all times. Concerning flies, F. H. King, who traveled through China, Korea, and Japan in the early 1900s when organic material, especially humanure, was the only source of soil fertilizer, stated, “*One fact which we do not fully understand is that, wherever we went, house flies were very few. We never spent a summer with so little annoyance from them as this one in China, Korea and Japan. If the scrupulous husbanding of [organic] refuse so universally practiced in these countries reduces the fly nuisance and this menace to health to the extent which our experience suggests, here is one great gain.*” He added, “*We have adverted to the very small number of flies observed anywhere in the course of our travel, but its significance we did not realize until near the end of our stay. Indeed, for some reason, flies were more in evidence during the first two days on the steamship out from Yokohama on our return trip to America, than at any time before on our*

journey.” <sup>9</sup>

If an entire country the size of the United States, but with twice the population (at that time), could recycle all of its organic refuse without the benefit of electricity or automobiles and not have a fly problem, surely we in the United States can recycle a greater portion of our own organic refuse with similar success today.

*Source: The Humanure Handbook. Jenkins Publishing, PO Box 607, Grove City, PA 16127. To order, phone: 1-800-639-4099.*

<http://www.jenkinspublishing.com/>

---

**MENU: [HOME](#) » [Reconstruction](#) » [Recovery](#) » [Renewal](#) » [Survival](#) » [Humanure Content](#)**

---

---

**MENU:** [HOME](#) » [Reconstruction](#) » [Recovery](#) » [Renewal](#) » [Survival](#) » [Humanure Content](#)

---

## ENVIRONMENTAL POTTY TRAINING 101

Simple, low-tech composting systems not only have a positive impact on the Earth's ecosystems, but are proven to be sustainable. Westerners may think that any system not requiring technology is too primitive to be worthy of respect. However, when western culture is nothing more than a distant and fading memory in the collective mind of humanity thousands (hundreds?) of years from now, the humans who will have learned how to survive on this planet in the long term will be those who have learned how to live in harmony with it. That will require much more than intelligence or technology — it will require a sensitive understanding of our place as humans in the web of life. That self-realization may be beyond the grasp of our egocentric intellects. Perhaps what is required of us in order to gain such an awareness is a sense of humility, and a renewed respect for that which is simple.

Some would argue that a simple system of humanure composting can also be the most advanced system known to humanity. It may be considered the most advanced because it works well while consuming little, if any, non-renewable resources, producing no pollution, and actually creating a resource vital to life.

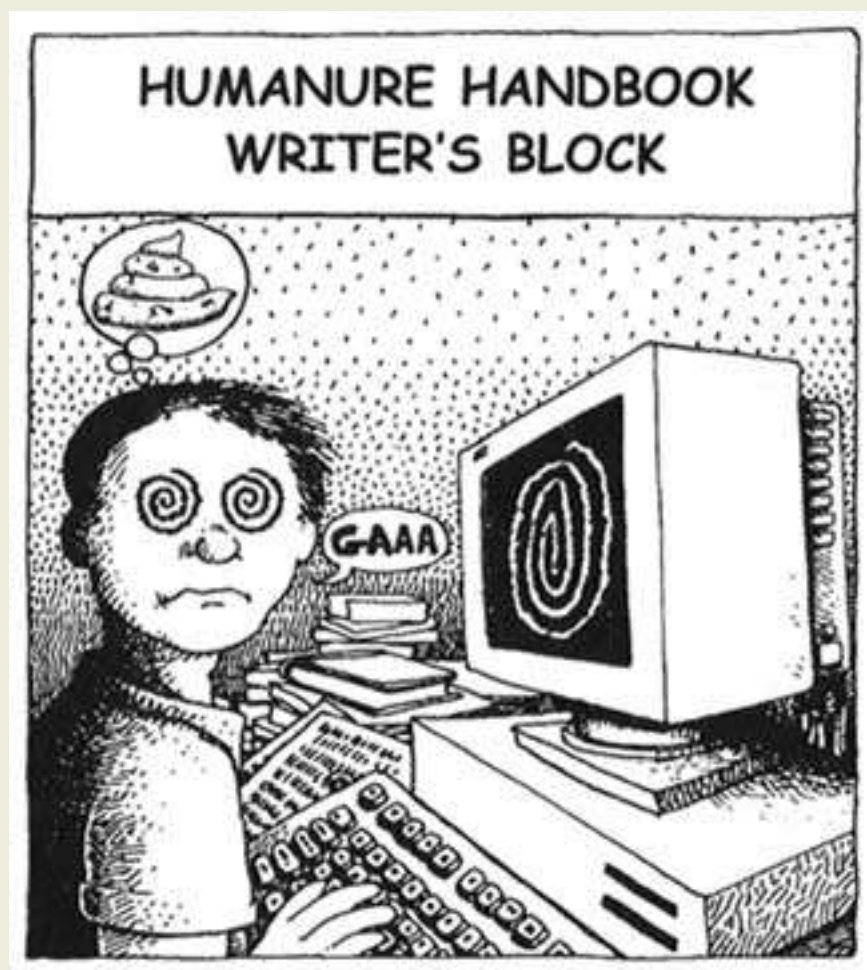
Others may argue that in order for a system to be considered “advanced,” it must display all the gadgets, doodads and technology normally associated with advancement. The argument is that something is advanced if it's been created by the scientific community, by humans, not by nature. That's like saying the most advanced method of drying one's hair is using a nuclear reaction in a nuclear power plant to produce heat in order to convert water to steam. The steam is then used to turn an electric generator in order to produce electricity. The electricity is used to power a plastic hair-drying gun to blow hot air on one's head. That's *technological* advancement. It reflects humanity's *intellectual* progress . . . (which is debatable).

True advancement, others would argue, instead requires the balanced *development* of humanity's intellect with physical and spiritual development. We must link what we know intellectually with the physical effects of our resultant behavior, and with the understanding of ourselves as small, interdependent, interrelated life forms relative to a greater sphere of existence. Otherwise, we create technology that excessively consumes non-renewable resources and creates toxic waste and pollution in order to do a simple task such as hair drying, which is easily done by hand with a towel. If that's advancement, we're in trouble.

Perhaps we're really advancing ourselves when we can function healthfully, peacefully, and sustainably

without squandering resources and without creating pollution. That's not a matter of mastering the intellect or of mastering the environment with technology, it's a matter of mastering one's self, a much more difficult undertaking, but certainly a worthy goal.

Finally, I don't understand humans. We line up and make a lot of noise about big environmental problems like incinerators, waste dumps, acid rain, global warming, and pollution. But we don't understand that when we add up all the tiny environmental problems each of us creates, we end up with those big environmental dilemmas. Humans are content to blame someone else, like government or corporations, for the messes we create, and yet we each continue doing the same things, day in and day out, that have created the problems. Sure, corporations create pollution. If they do, don't buy their products. If you have to buy their products (gasoline for example), keep it to a minimum. Sure, municipal waste incinerators pollute the air. Stop throwing trash away. Minimize your production of waste. Recycle. Buy food in bulk and avoid packaging waste. Simplify. Turn off your TV. Grow your own food. Make compost. Plant a garden. Be part of the solution, not part of the problem. If you don't, who will?



Source: *The Humanure Handbook*. Jenkins Publishing, PO Box 607, Grove City, PA 16127. To order, phone: 1-800-639-4099.

<http://www.jenkinspublishing.com/>

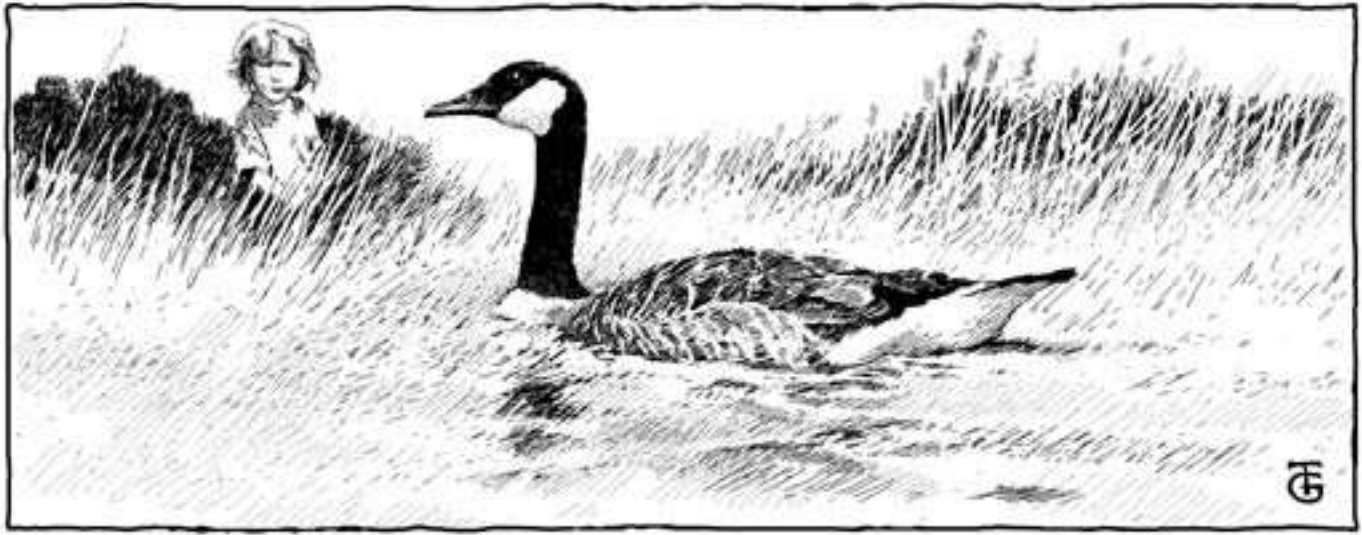
**MENU:** [HOME](#) » [Reconstruction](#) » [Recovery](#) » [Renewal](#) » [Survival](#) » [Humanure Content](#)

---

---

**MENU:** [HOME](#) » [Reconstruction](#) » [Recovery](#) » [Renewal](#) » [Survival](#) » [Humanure Content](#)

## ALTERNATIVE GREY WATER SYSTEMS



*“When dealt with appropriately, graywater is a valuable resource which horticultural and agricultural growers, as well as home gardeners, will increasingly come to appreciate.”*

Carl Lindstrom

There are two concepts that sum up this book: 1) one organism’s excretions are another organism’s food, and 2) there is no waste in nature. We humans need to understand what organisms will consume our excretions if we are to live in greater harmony with the natural world. Our excretions include humanure, urine, and *other* organic materials that we discharge into the environment, such as “graywater,” which is the water resulting from washing or bathing. Graywater should be distinguished from “blackwater,” the water that comes from toilets. Graywater contains recyclable organic materials such as nitrogen, phosphorous, and potassium. These materials are pollutants when discarded into the environment. When responsibly recycled, however, they can be beneficial nutrients.

My first exposure to an “alternative” wastewater system occurred on the Yucatan Peninsula of Mexico in 1977. At that time, I was staying in a tent on a primitive, isolated, beach-front property lined with coconut palms and overlooking the turquoise waters and white sands of the Caribbean. My host operated a small restaurant with a rudimentary bathroom containing a toilet, sink, and shower, primarily reserved for tourists who paid to use the room. The wastewater from this room drained from a pipe, through the

wall, and directly into the sandy soil outside, where it ran down an inclined slope out of sight behind the thatched pole building. I first noticed the drain not because of the odor (there wasn't any that I can remember), but because of the thick growth of tomato plants that cascaded down the slope where the drain was located. I asked the owner why he would plant a garden in such an unlikely location, and he replied that he didn't plant it at all — the tomatoes were volunteers; the seeds sprouted from human excretions. He admitted that whenever he needed a tomato, he didn't have to go far to get one. This is not an example of sanitary wastewater recycling, but it is an example of how wastewater can be put to constructive use, even by accident.

From there, I traveled to Guatemala, where I noticed a similar wastewater system, again at a crude restaurant at an isolated location in the Peten jungle. The restaurant's wastewater drain irrigated a small section of the property separate from the camp sites and other human activities, but plainly visible. That section had the most luxurious growth of banana plants I had ever seen. Again, the water proved to be a resource useful in food production, and in this case, the luxurious growth added an aesthetic quality to the property, appearing as a lush tropical garden. The restaurant owner liked to show off his "garden," admitting that it was largely self-planted and self-perpetuating. "That's the value of drain water," he was quick to point out, and its value was immediately apparent to anyone who looked.

All wastewater contains organic materials, such as food remnants and soap. Microorganisms, as well as plants and macroorganisms, consume these organic materials and convert them into beneficial nutrients. In a sustainable system, wastewater is made available to natural organisms for their benefit. Recycling organic materials through living organisms naturally purifies water.

In the US, the situation is quite different. Household wastewater typically contains all the water from toilet flushings (blackwater) as well as water from sink, bathtub, and washing machine drains (graywater). To complicate this, many households have in-sink garbage disposals. These contraptions grind up all of the organic food material that could otherwise be composted, then eject it out into the drain system. Government regulators assume the worst case scenario for household wastewater (lots of toilet flushings, lots of baby diapers in the wash, and lots of garbage in the disposal unit), then they draft regulations to accommodate this scenario. Wastewater is considered a public health hazard which must be quarantined from human contact. Typically, the wastewater is required to go directly into a sewage system, or, in suburban and rural locations, into a septic system.

A septic system generally consists of a concrete box buried underground into which household wastewater is discharged. When the box fills and overflows, the effluent drains into perforated pipes that allow the water to percolate into the soil. The drain field is usually located deep enough in the soil that surface plants cannot access the water supply.

In short, conventional drainage systems isolate wastewater from natural systems, making the organic material in the water unavailable for recycling. At wastewater treatment plants (sewage plants), the organic material in the wastewater is removed using complicated, expensive procedures. Despite the high cost of such separation processes, the organic material removed from the wastewater is often buried in a

landfill.

The alternatives should be obvious. Albert Einstein once remarked that the human race will require an entirely new manner of thinking if it is to survive. I am inclined to agree. Our “waste disposal” systems must be rethought. As an alternative to our current throw-away mentality, we can understand that organic material is a resource, rather than a waste, that can be beneficially recycled using natural processes.

In pursuing this alternative, the first step is to *recycle* as much organic material as possible, keeping it away from waste disposal systems altogether. We can eliminate all blackwater from our drains by composting all human manure and urine. We can also eliminate almost all other organic material from our drains by composting food scraps. As such, one should never use an in-sink garbage disposal. As an indication of how much organic material typically goes down a household drain, consider the words of one composting toilet manufacturer, “*New regulations will soon demand that septic tanks receiving flush toilet and garbage disposal wastes be pumped out and documented by a state certified septage hauler every three years. When toilet and garbage solids and their associated flush water is removed from the septic system, and the septic tank is receiving only graywater, the septic tank needs pumping only every twenty years.*”<sup>1</sup> According to the US EPA, household garbage disposals contribute 850% more organic matter and 777% more suspended solids to wastewater than do toilets.<sup>2</sup>

The second step is to understand that a drain is not a waste disposal site; it should *never* be used to dump something to “get rid of it.” This has unfortunately become a bad habit for many Americans. As an example, a friend was helping me process some of my home-made wine. The process created five gallons of spent wine as a by-product. When I had my back turned, the fellow dumped the liquid down the sink drain. I found the empty bucket and asked what happened to the liquid that had been in it. “I dumped it down the sink,” he said. I was speechless. Why would anyone dump five gallons of food-derived liquid down a sink drain? But I could see why. My friend considered a drain to be a waste disposal site, as do most Americans. This was compounded by the fact that he had *no idea* what to do with the liquid otherwise. My household effluent drains directly into a constructed wetland which consists of a graywater pond. Because anything that goes down that drain feeds a natural aquatic system, I am quite particular about what enters the system. I keep all organic material out of the system, except for the small amount that inevitably comes from dishwashing and bathing. All food scraps are composted, as are grease, fats, oils, and every other bit of organic food material our household produces (every food item compost educators tell you “not to compost” ends up down a drain or in a landfill otherwise, which is foolish; in our household, it all goes into the compost). This recycling of organic material allows for a relatively clean graywater that can be easily remediated by a constructed wetland, soilbed, or irrigation trench. The thought of dumping something down my drain simply to dispose of it just doesn’t fit into my way of thinking. So I instructed my friend to pour any remaining organic liquids onto the compost pile. Which he did. I might add that this was in the middle of January when things were quite frozen, but the compost pile still absorbed the spent wine. In fact, that winter was the first one in which the active compost pile did not freeze. Apparently, the 30 gallons of liquid we doused it with kept it active enough to generate heat all winter long.

Step three is to eliminate the use of all toxic chemicals and non-biodegradable soaps in one’s household.



Chemicals could find their way down the drains and out into the environment as pollutants. The quantity and variety of toxic chemicals routinely dumped down drains in the US is both incredible and disturbing. We can eliminate a lot of our wastewater problems by simply being careful what we add to our water. Many Americans do not realize that most of the chemicals they use in their daily lives and believe to be necessary are not necessary at all. They can simply be eliminated. This is a fact that will not be promoted on TV or by the government (including schools), because the chemical industry might object. I am quite sure that you, the reader, don't care whether the chemical industry objects or not. Therefore, you willingly make the small effort necessary to find environmentally benign cleaning agents for home use.

Cleaning products that contain boron should not be used with graywater recycling systems because boron is reportedly toxic to most plants. Liquid detergents are better than powdered detergents because they contribute less salts to the system.<sup>3</sup> Water softeners may not be good for graywater recycling systems because softened water reportedly contains more sodium than unsoftened water, and the sodium may build up in the soil, to its detriment. Chlorine bleach or detergents containing chlorine should not be used, as chlorine is a potent poison. Drain cleaners, and products that clean porcelain without scrubbing should not be drained into a graywater recycling system.

Step four is to reduce our water consumption altogether, thereby reducing the amount of water issuing from our drains. This can be aided by collecting and using rainwater, and by recycling graywater through beneficial, natural systems.

The "old school" of wastewater treatment, still embraced by most government regulators and many academics, considers water to be a vehicle for the routine transfer of waste from one place to another. It also considers the accompanying organic material to be of little or no value. The "new school," on the other hand, sees water as a dwindling, precious resource that should not be polluted with waste; organic materials are seen as resources that should be constructively recycled. My research for this chapter included reviewing hundreds of research papers on alternative wastewater systems. I was amazed at the incredible amount of time and money that has gone into studying how to clean the water we have polluted with human excrement. In all of the research papers, without exception, the idea that we should simply stop defecating in water is never suggested.

The change from a water polluting, waste-disposal way of life to an environmentally benign, resource-recovery way of life will not occur from the "top down." Many government authorities and scientists take our wasteful, polluting way of life for granted, and even defend it. Those of us who are courageous enough to be different and who insist upon environmentally friendly lifestyles represent the first wave in the emerging lifestyle changes which we must all inevitably embrace. As our numbers increase, our cumulative impact will become more and more significant.

## **GRAYWATER**

*"The question of residential water conservation is not one of whether it will occur, but rather a question of how rapidly it will occur."*

It is estimated that 42 to 79% of household graywater comes from the bathtub and shower, 5 to 23% from laundry facilities, 10 to 17% from the kitchen sink or dishwasher, and 5 to 6% from the bathroom sink. [By comparison, the flushing of toilets (creating blackwater) constitutes 38 to 45% of all interior water use in the US, and is the single largest use of water indoors. On average, a person flushes a toilet six times a day.<sup>6]</sup>

Various studies have indicated that the amount of graywater generated per person per day varies from 25 to 45 gallons (96 to 172 liters), or 719 to 1,272 gallons (2,688 to 4,816 liters) per week for a typical family of four.<sup>4</sup> In California, a family of four may produce 1300 gallons of graywater in a week.<sup>5</sup> This amounts to nearly a 55 gallon drum filled with sink and bath water by every person every day, which is then drained into a septic or sewage system. This estimate does not include toilet water. Ironically, the graywater we dispose of can still be useful for such purposes as yard, garden, and greenhouse irrigation. Instead, we dump the graywater into the sewers and use drinking water to irrigate our lawns.

Reuse of graywater for landscape irrigation can greatly reduce the amount of drinkable water used during the summer months when landscape water may constitute 50-80% of the water used at a typical home. Even in an arid region, a three person household can generate enough graywater to meet all of their irrigation needs.<sup>7</sup> In Tucson, Arizona, for example, a typical family of three uses 123,400 gallons of municipal water per year.<sup>8</sup> It is estimated that 31 gallons of graywater can be collected per person, per day, amounting to almost 34,000 gallons of graywater per year for the same family.<sup>9</sup> An experimental home in Tucson, known as Casa del Aqua, reduced its municipal water use by 66% by recycling graywater and collecting rainwater. Graywater recycling amounted to 28,200 gallons per year, and rainwater collection amounted to 7,400 gallons per year.<sup>10</sup> In effect, recycled graywater constitutes a “new” water supply by allowing water that was previously wasted to be used beneficially. Water reuse also reduces energy and fossil fuel consumption by requiring less water to be purified and pumped, thereby helping to reduce the production of global warming gases such as carbon dioxide.

Because graywater can be contaminated with fecal bacteria and chemicals, its reuse is prohibited or severely restricted in many states. Since government regulatory agencies do not have complete information about graywater recycling, they assume the worst-case scenario and simply ban its reuse. This is grossly unfair to those who are conscientious about what they put down their drains and who are determined to conserve and recycle water. Graywater experts contend that the health threat from graywater is insignificant. One states, “*I know of no documented instance in which a person in the US became ill from graywater.*”<sup>11</sup> Another adds, “*Note that although graywater has been used in California for about 20 years without permits, there has not been one documented case of disease transmission.*”<sup>12</sup> The health risks from graywater reuse can be reduced first by keeping as much organic material and toxic chemicals out of your drains as possible, and second, by filtering the graywater into a constructed wetland, soilbed, or below the surface of the ground so that the graywater does not come into direct human contact, or in contact with the edible portions of fruits and vegetables.

In November of 1994, legislation was passed in California that allowed the use of graywater in single family homes for subsurface landscape irrigation. Many other states do not currently have any legislation regulating graywater ([see Appendix 3](#)). However, many states are now realizing the value of alternative graywater systems and are pursuing research and development of such systems. The US EPA, for example, considers the use of wetlands to be an emerging alternative to conventional treatment processes.

## PATHOGENS

Graywater can contain disease organisms which originate from fecal material or urine entering bath, wash, or laundry water. Potential pathogens in fecal material and urine, as well as infective doses, are listed in [Chapter 7](#).

Indicator bacteria such as *E. coli* reveal fecal contamination of the water, as well as the possible presence of other intestinal disease-causing organisms. Fecal coliforms are a pollution indicator. A high count is undesirable and indicates a greater chance of human illness resulting from contact with the graywater. Plant material, soil, and food scraps can contribute to the *total* coliform population, but fecal coliforms indicate that fecal material is also entering the water system. This can come from baby diapers, or just from bathing or showering.

More microorganisms may come from shower and bath graywater than from other graywater sources. Studies have shown that total coliforms and fecal coliforms were approximately ten times greater in bathing water than in laundry water (see Figure 9.1).<sup>13</sup>

One study showed an average of 215 total coliforms per 100 ml and 107 fecal coliforms per 100 ml in laundry water; 1810 total coliforms and 1210 fecal coliforms per 100 ml in bath water; and 18,800,000 colony forming units of total coliforms per 100 ml in graywater containing household garbage (such as when a garbage disposal is used).<sup>14</sup> Obviously, grinding and dumping food waste down a drain greatly increases the bacterial population of the graywater.

Due to the undigested nature of the organic material in graywater, microorganisms can grow and reproduce in the water during storage. The numbers of bacteria can actually increase in graywater within the first 48 hours of storage, then remain stable for about 12 days, after which they slowly decline (see Figure 9.2).<sup>15</sup>

For maximum hygienic safety, follow these simple rules when using a graywater recycling system: don't drink graywater; don't come in physical contact with graywater (and wash promptly if you accidentally do come in contact with it); don't allow graywater to come in contact with edible portions of food crops; don't allow graywater to pool on the surface of the ground; and don't allow graywater to run off your property.

## PRACTICAL GRAYWATER SYSTEMS

The object of recycling graywater is to make the organic nutrients in the water available to plants and microorganisms, preferably on a continuous basis. The organisms will consume the organic material, thereby recycling it through the natural system.

It is estimated that 30 gallons of graywater per person per day will be produced from a water-conservative home. This graywater can be recycled either indoors or outdoors. Inside buildings, graywater can be filtered through deep soil beds, or shallow gravel beds, in a space where plants can be grown, such as in a greenhouse.

Outdoors, in colder climates, graywater can be drained into leaching trenches that are deep enough to resist freezing, but shallow enough to keep the nutrients within the root zones of surface plants. Freezing can be prevented by applying a mulch over the subsurface leaching trenches. Graywater can also be circulated through evapotranspiration trenches (Figure 9.3), constructed wetlands (Figures 9.4, 9.5, 9.6, and 9.7), mulch basins (Figure 9.10), and soilbeds (Figures 9.11, 9.12, 9.13, and 9.14).

## EVAPOTRANSPIRATION

Plants can absorb graywater through their roots and then transpire the moisture into the air. A graywater system that relies on such transpiration is called an Evapotranspiration System. Such a system may consist of a tank to settle out the solids, with the effluent draining or being pumped into a shallow sand or gravel bed covered with vegetation. Canna lilies, iris, elephant ears, cattails, ginger lily, and umbrella tree, among others, have been used with these systems. An average two bedroom house may require an evapotranspiration trench that is three feet wide and 70 feet long. One style of evapotranspiration system consists of a shallow trench lined with clay or other waterproof lining (such as plastic), filled with an inch or two of standard gravel, and six inches of pea gravel. Plants are planted in the gravel, and no soil is used.

Other systems, such as the Watson Wick (Figure 9.3), may be deeper and may utilize topsoil.

## CONSTRUCTED WETLANDS

The system of planting aquatic plants such as reeds or bulrushes in a wet (often gravel) substrate medium for graywater recycling is called a “constructed wetland” or “artificial wetland.” The first artificial wetlands were built in the 1970s. By the early 1990s, there were more than 150 constructed wetlands treating municipal and industrial wastewater in the US.

*According to the US Environmental Protection Agency, “Constructed wetlands treatment systems can be established almost anywhere, including on lands with limited alternative uses. This can be done relatively simply where wastewater treatment is the only function sought. They can be built in natural settings, or they may entail extensive earthmoving, construction of impermeable barriers, or building of containment such as tanks or trenches. Wetland vegetation has been established and maintained on*

*substrates ranging from gravel or mine spoils to clay or peat . . . Some systems are set up to recharge at least a portion of the treated wastewater to underlying ground water. Others act as flow-through systems, discharging the final effluent to surface waters. Constructed wetlands have diverse applications and are found across the country and around the world. They can often be an environmentally acceptable, cost-effective treatment option, particularly for small communities.”* <sup>16</sup>

A wetland, by definition, must maintain a level of water near the surface of the ground for a long enough time each year to support the growth of aquatic vegetation. Marshes, bogs, and swamps are examples of naturally occurring wetlands. Constructed wetlands are designed especially for pollution control, and exist in locations where natural wetlands do not.

Two types of constructed wetlands are in common use today. One type exposes the water’s surface (Surface Flow Wetland, Figure 9.6), and the other maintains the water surface below the level of the gravel (Subsurface Flow Wetland, Figures 9.4, 9.5, and 9.7). Some designs combine elements of both. Subsurface flow wetlands are also referred to as Vegetated Submerged Bed, Root Zone Method, Rock Reed Filter, Microbial Rock Filter, Hydrobotanical Method, Soil Filter Trench, Biological-Macrophytic Marsh Bed, and Reed Bed Treatment.<sup>17</sup>

Subsurface flow wetlands are considered to be advantageous compared to open surface wetlands, and are more commonly used for individual households. By keeping the water below the surface of the gravel medium, there is less chance of odors escaping, less human contact, less chance of mosquito breeding, and faster “treatment” of the water (due to more of the water being exposed to the microbially populated gravel surfaces and plant roots). The subsurface water is also less inclined to freeze during cold weather.

Constructed wetlands generally consist of one or more lined beds, or cells. The gravel media in the cells should be as uniform in size as possible and should consist of small to medium size gravel or stone, from one foot to three feet in depth. A layer of sand may be used either at the top or the bottom of a gravel medium, or a layer of mulch and topsoil may be applied over the top of the gravel. In some cases, gravel alone will be used with no sand, mulch, or topsoil. The sides of the wetlands are bermed to prevent rainwater from flowing into them, and the bottom may be slightly sloped to aid in the flow of graywater through the system. A constructed wetland for a household, once established, requires some maintenance, mainly the annual harvesting of the plants (which can be composted).

In any case, the roots of aquatic plants will spread through the gravel as the plants grow. The most common species of plants used in the wetlands are the cattails, bulrushes, sedges, and reeds. Graywater is filtered through the gravel, thereby keeping the growing environment wet, and bits of organic material from the graywater become trapped in the filtering medium. Typical retention times for graywater in a subsurface flow wetland system range from two to six days. During this time, the organic material is broken down and utilized by microorganisms living in the medium and on the roots of the plants. A wide range of organic materials can also be taken up directly by the plants themselves.

Bacteria, both aerobic and anaerobic, are among the most plentiful microorganisms in wetlands and are

thought to provide the majority of the wastewater treatment. Microorganisms and plants seem to work together symbiotically in constructed wetlands, as the population of microorganisms is much higher in the root areas of the plants than in the gravel alone. Dissolved organic materials are taken up by the roots of the plants, while oxygen and food are supplied to the underwater microorganisms through the same root system.<sup>18</sup>

Aquatic microorganisms have been reported to metabolize a wide range of organic contaminants in wastewater, including benzene, naphthalene, toluene, chlorinated aromatics, petroleum hydrocarbons, and pesticides. Aquatic plants can take up, and sometimes metabolize, water contaminants such as insecticides and benzene. The water hyacinth, for example, can remove phenols, algae, fecal coliforms, suspended particles, and heavy metals including lead, mercury, silver, nickel, cobalt, and cadmium from contaminated water. In the absence of heavy metals or toxins, water hyacinths can be harvested as a high-protein livestock feed. It can also be harvested as a feedstock for methane production. Reed-based wetlands can remove a wide range of toxic organic pollutants.<sup>19</sup> Duckweeds also remove organic and inorganic contaminants from water, especially nitrogen and phosphorous.<sup>20</sup>

When the outdoor air temperature drops below a certain point (during the winter months in cold climates), wetland plants will die and microbial activity will drop off. Therefore, constructed wetlands will not provide the same level of water treatment year round. Artificial wetlands systems constitute a relatively new approach to water purification, and the effects of variables such as temperature fluctuations are not completely understood. Nevertheless, wetlands are reported to perform many treatment functions efficiently in winter. One source reports that the removal rates of many contaminants are unaffected by water temperature, adding, “*The first two years of operation of a system in Norway showed a winter performance almost at the same level as the summer performance.*” Some techniques have been developed to insulate wetland systems during the colder months. For example, in Canada, water levels in wetlands were raised during freezing periods, then lowered after a layer of ice had formed. The cattails held the ice in place, creating an air space over the water. Snow collected on top of the ice, further insulating the water underneath.<sup>21</sup>

It is estimated that one cubic foot of artificial wetland is required for every gallon per day of graywater produced. For an average single bedroom house, this amounts to about a 120 square foot system, one foot deep. However, it is better to overbuild a system than to underbuild. Some constructed wetland situations may not have enough drainage water from a residence to keep the system wet enough. In this case, extra water may be added from rain water collection or other sources.

## WETLAND PLANTS

Aquatic plants used in constructed wetland systems can be divided into two general groups: microscopic and macroscopic. Most of the microscopic plants are algae, which can be either single cell (such as *Chlorella* or *Euglena*) or filamentous (such as *Spirulina* or *Spyrogyra*).

Macroscopic (larger) plants can grow under water (submergent) or above water (emergent). Some grow

partially submerged and some partially emerged. Some examples of macroscopic aquatic plants are reeds, bulrushes, water hyacinths, and duckweeds (see Figure 9.8 and Table 9.1). Submerged plants can remove nutrients from wastewaters, but are best suited in water where there is plenty of oxygen (water with a high level of organic material tends to be low in oxygen due to extensive microbial activity).

Examples of floating plants are duckweeds and water hyacinths. Duckweeds can absorb large quantities of nutrients. Small ponds that are overloaded with nutrients such as farm fertilizer run-off can often be seen choked with duckweed, appearing as a green carpet on the pond's surface. In a two and a half acre pond, duckweed can absorb the nitrogen, phosphorous, and potassium from the excretions of 207 dairy cows. The duckweed can eventually be harvested, dried, and fed back to the livestock as a protein-rich feed. Livestock can even eat the plants directly from a water trough.<sup>22</sup>

Algae work in partnership with bacteria in aquatic systems. Bacteria break down complex nitrogen compounds and thereby make the nitrogen available to algae. Bacteria also produce carbon dioxide which is utilized by the algae.<sup>23</sup>

## SOILBOXES OR SOILBEDS

A soilbox is a box designed to allow graywater to filter through it while plants grow on top of it (Figure 9.14). Such boxes have been in use since the 1970s. Since the box must be well-drained, it is first layered with rocks, pea gravel, or other drainage material. This is covered with screening, then a layer of coarse sand is added, followed by finer sand; two feet of top soil is added to finish it off. Soilboxes can be located indoors or outdoors, either in a greenhouse, or as part of a raised-bed garden system.<sup>24</sup>

Soilboxes (soilbeds) located in indoor greenhouses are illustrated in Figures 9.11 and 9.13. An outdoor soilbed is illustrated in Figure 9.12.

## PEEPERS

At one point in the development of my homestead, I had to decide what to do with my graywater. My household produced no blackwater or sewage, and we composted all of our organic material. We only had a hand pump at the kitchen sink, and we carried our drinking water from a spring out behind the house. Nevertheless, we still had a sink and bathtub with drains, and the water had to go somewhere.

The choices I had were pretty limited: install an underground septic tank and drain the graywater into it; run the graywater through some sort of biofilter (such as sawdust) and then compost the sawdust on occasion; or try some sort of constructed wetland. I decided to experiment with the last option, mainly because I had an acid-mine-drainage spring running past my house, and I thought the graywater, which tends to be alkaline because of soap, would help neutralize the acid water. I also thought a pond would provide insurance against a drought, when rain water collection for watering a garden isn't reliable.

The acid spring flowed past my house from an abandoned surface coal mine, and when I first started

living beside it, it was choked with long, slimy, green algae. I introduced ducks to the algae-choked water, and quite by accident, I found that the algae disappeared as long as I kept ducks on the water. Whether the ducks were eating the algae or just breaking it up with their feet, I don't know. In any case, the water changed from ugly to beautiful, almost overnight, by the simple addition of another lifeform to the biological system. This indicated to me that profound changes could occur in ecological systems with proper (even accidental) management. Unfortunately, constructed wetland systems are still new and there is not much concrete information about them that is applicable to single family dwellings. Therefore, I was forced, as usual, to engage in experimentation.

I built a naturally clay-lined pond near my house about the size of a large swimming pool, then diverted some of the acid mine water to fill the pond. I directed my graywater into this "modified lagoon" wastewater system via a six inch diameter drain pipe with an outlet discharging the graywater below the surface of the pond water. I installed a large drainpipe to act as a pre-digestion chamber where organic material could collect and be broken down by anaerobic bacteria en route to the lagoon, like a mini septic tank. I add septic tank bacteria to the system annually by dumping it down the household drains. I assumed that the small amount of organic matter that entered the pond from the graywater drain would be consumed by the organisms in the water, thereby helping to biologically remediate an extensively damaged source of water. The organic material settles into the bottom of the pond, which is about five feet at the deepest point, thereby being retained in the constructed system indefinitely. I also lined the bottom of the pond with limestone to help neutralize the incoming acid mine water.

The ducks, of course, loved the new pond. They still spend countless hours poking their heads under the water, searching the pond bottom for things to eat. Our house is located between our garden and the pond, and the water is clearly visible from the kitchen sink, as well as from the dining room on the east side of the house, while the nearby garden is visible from the west windows. Shortly after we built the pond, my family was working in our garden. Soon we heard the loud honking of Canada geese in the sky overhead, and watched as a mating pair swooped down through the trees and landed on our new, tiny pond. This was quite exciting, as we realized that we now had a place for wild waterfowl, a bonus we hadn't really anticipated. We continued working in the garden, and were quite surprised to see the geese leave the pond and walk past our house toward the garden where we were busy digging. We continued to work, and they continued to walk toward us, eventually walking right past us through the yard, and on to the far end of the garden. When they reached the orchard, they turned around and marched right past us again, making their way back to the pond. To us, this was equivalent to an initiation for our new pond, a way that nature was telling us we had contributed something positive to the environment.

Of course, it didn't end with the two Canada Geese. Soon, a Great Blue Heron landed in the pond, wading around its shallow edges on stilt-like legs. It was spotted by one of the children during breakfast, a mere fifty feet from the dining room window. Then, a pair of colorful wood ducks spent an afternoon playing in the water. This was when I noticed that wood ducks can perch on a tree branch like a songbird. Recently, I counted 40 Canada geese on the little pond. They covered its surface like a feathery carpet, only to suddenly fly off in a great rush of wings.

We raise our own domesticated ducks for algae control, for eggs, and occasionally for meat. At one point



we raised some Mallard ducks, only to find that this wild strain will fly away when they reach maturity. One of the female Mallards became injured somehow, and developed a limp. She was certainly a “lame duck,” but the children liked her and took care of her. Then one day she completely disappeared. We thought a predator had killed the defenseless bird, and we never expected to see her again. To the children’s delight, the following spring a pair of wild Mallard ducks landed on our little pond. We watched them swim around for quite some time, until the female came out of the water and walked toward us. Or, I should say, “limped” toward us. Our lame Mallard duck had flown away for the winter only to come back in the spring with a handsome boyfriend! Our new graywater pond was the point of reference for her migration.

My youngest daughter, Phoebe, was given a Canada goose to raise by one of the neighbors. The tiny gosling couldn’t have been more than a day or two old when it was discovered wandering lost along the road. I’m not sure why Phoebe was asked to take care of the goose, other than she loves animals and she had a pond in her backyard, but she enthusiastically accepted the responsibility. She named the goose “Peepers,” and everywhere Phoebe went, Peepers followed. The two of them spent many a day at the graywater pond, Peepers splashing around in the water while Phoebe sat on the shore watching. Soon Peepers was a full grown goose, and everywhere Peepers went, large piles of goose droppings followed. The goose doo situation finally became so intolerable (to Dad, who renamed the goose “Poopers”) that Peepers was furtively exported to the wild. Phoebe was heartbroken.

This spring, as I write this, ten years after our graywater pond was constructed, a pair of honking Canada geese once again flew overhead. Except this time, only the female landed in our little pond. Phoebe went running to the pond when she heard that familiar honking, yelling “Peepers! Peepers!” Peepers had come back to say hello to Phoebe. How did I know it was Peepers? I didn’t. But somehow, Phoebe did. She stood on the pond bank for quite some time talking to the majestic goose, and the goose, also standing on the bank, talked back. They carried on a conversation that is rarely witnessed. Finally, Peepers flew off, and this time, Phoebe was happy.

I have more stories to tell about our graywater pond, and no doubt will have many more in the future. A buried, quarantined, septic tank for graywater, on the other hand, is pretty boring. I believe I made the right decision in deciding to construct a pond for our graywater. The benefits of such a system can go far beyond what one may imagine.

*Source: The Humanure Handbook. Jenkins Publishing, PO Box 607, Grove City, PA 16127. To order, phone: 1-800-639-4099.*

<http://www.jenkinspublishing.com/>

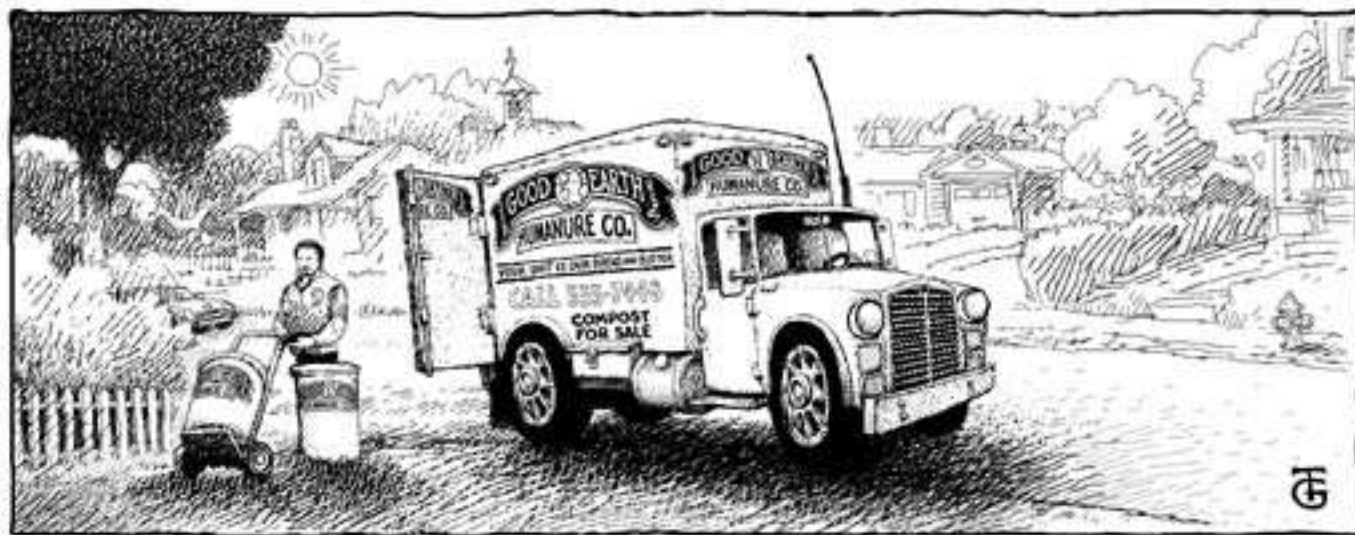
---

**MENU: [HOME](#) » [Reconstruction](#) » [Recovery](#) » [Renewal](#) » [Survival](#) » [Humanure Content](#)**

---



## THE END IS NEAR



*“If you want to be free, learn to live simply.  
Use what you have and be content where you are.”*

J. Heider

Ladies and gentlemen, allow me to introduce you to a new and revolutionary literary device known as the *self-interview*! (Applause heard in background. Someone whoops.) Today I'll be interviewing myself. In fact, here I am now. (Myself walks in.)

***Me:** Good morning, sir. Haven't I seen you somewhere before?*

**Myself:** Cut the crap. It's too early in the morning for this. You see me every time you look in the mirror, which isn't very often, thank god. What, for crying out loud, would possess you to interview yourself, anyway?

***M:** If I don't, who will?*

**MS:** You do have a point there. In fact, that may be an issue worthy of contemplation.

**M:** *Well, let's not get off the track. The topic of discussion today is a substance near and dear to us all. Shall we step right into it?*

**MS:** What the hell are you talking about?

**M:** *I'll give you a hint. It often can be seen with corn or peanuts on its back.*

**MS:** Elephants?

**M:** *Close, but no cigar. Actually, cigar would have been a better guess. We're going to talk about humanure.*

**MS:** You dragged me out of bed and forced me to sit here in front of all these people to talk about CRAP?!

**M:** *You wrote a book on it, didn't you?*

**MS:** So what? OK, OK. Let's get on with it. I've had enough of your theatrics.

**M:** *Well, first off, do you expect anyone to take the Humanure Handbook seriously?*

**MS:** Why wouldn't they?

**M:** *Because nobody gives a damn about humanure. The last thing anyone wants to think about is a turd, especially their own. Don't you think that by bringing the subject to the fore you're risking something?*

**MS:** You mean like mass constipation? Not quite. I'm not going to put any toilet bowl manufacturers out of business. I'd estimate that one in a million people have any interest at all in the topic of resource recovery in relation to human excrement. Nobody thinks of human manure as a resource; the concept is just too bizarre.

**M:** *Then what's the point?*

**MS:** The point is that long-standing cultural prejudices and phobias need to be challenged once in a while by somebody, anybody, or they'll never change. Fecophobia is a deeply rooted fear in the American, and perhaps Western, psyche. But you can't run from what scares you. It just pops up somewhere else, where you least expect it. We've adopted the policy of defecating in our drinking water and then piping it off somewhere to let someone else deal with it. So now we're finding that our drinking water sources are dwindling and becoming increasingly contaminated. What goes around comes around.

**M:** *Oh, come on. I drink water every day and it's never contaminated. We Americans probably have the*

*most abundant supply of safe drinking water of any country on the planet.*

**MS:** Yes and no. True, your water may not suffer from fecal contamination, meaning intestinal bacteria in water. But how much chlorine do you drink instead? Then there's water pollution from sewage in general, such as beach pollution. But I don't want to get into all this again. I've already discussed human waste pollution in Chapter Two.

**M:** *Then you'll admit that American drinking water supplies are pretty safe?*

**MS:** From disease-causing microorganisms, generally yes, they are. Even though we defecate in our water, we go to great lengths and expense to clean the pollutants back out of it. The chemical additives in our water, such as chlorine, on the other hand, are not good to drink. And let's not forget that drinking water supplies are dwindling all over the world, water tables are sinking, and water consumption is on the increase with no end in sight. That seems to be a good reason to not pollute water with our daily bowel movements. Yet, that's only half the equation.

**M:** *What do you mean?*

**MS:** Well, we're still throwing away the agricultural resources that humanure should be providing us. We're not maintaining an intact human nutrient cycle. By piping sewage into the sea, we're essentially dumping grain into the sea. By burying sludge, we're burying a source of food. That's a cultural practice that should be challenged. It's a practice that's not going to change overnight, but will change incrementally if we begin acknowledging it now.

**M:** *So what're you saying? You think everybody should shit in a five-gallon bucket?*

**MS:** God forbid. Then you would see mass constipation!

**M:** *Well then, I don't understand. Where do we go from here?*

**MS:** I'm not suggesting we have a mass cultural change in toilet habits. I'm suggesting that, for starters, we need to change the way we understand our habits. Most people have never heard of such a thing as a nutrient cycle. Many people don't even know about compost. Recycling humanure is just not something people think about. I'm simply suggesting that we begin considering new approaches to the age-old problem of what to do with human excrement. We also need to start thinking a bit more about how we live on this planet, because our survival as a species depends on our relationship with the Earth.

**M:** *That's a beginning, but that's probably all we'll ever see in our lifetime, don't you think? Some people, like you for example, will think about these things, maybe write about them, maybe even give them some lip service. Most people, on the other hand, would rather have a bag of cheese puffs in one hand, a beer in the other, and a TV in front of them.*

**MS:** Don't be so sure about that. Things are changing. There are more than a few people who will turn off their TVs, pick the orange crumbs out of their teeth, and get busy making the world a better place. I predict, for example, that composting toilets and toilet systems will continue to be designed and redesigned in our lifetimes. Eventually, entire housing developments or entire communities will utilize composting toilet systems. Some municipalities will eventually install composting toilets in all new homes.

*M: You think so? What would that be like?*

**MS:** Well, each home would have a removable container made of recycled plastic that would act as both a toilet receptacle and a garbage disposal.

*M: How big a container?*

**MS:** You'd need about five gallons of capacity per person per week. A container the size of a fifty gallon drum would be full in about two weeks for an average family. Every household would deposit all of its organic material except graywater into this receptacle, including maybe some grass clippings and yard leaves. The municipality could provide a cover material for odor prevention, consisting of ground leaves, rotted sawdust, or ground newsprint, neatly packaged for each household and possibly dispensed automatically into the toilet after each use. This would eliminate the production of all organic garbage and all sewage, as it would all be collected without water and composted at a municipal compost yard.

*M: Who'd collect it?*

**MS:** Once every couple of weeks or so, your municipality or a business under contract with your municipality would take the compost receptacle from your house. A new compost receptacle would then replace the old. This is already being done in the entire province of Nova Scotia, Canada, and in areas of Europe where organic kitchen materials are collected and composted.

When toilet material is added to the collection system, your manure, urine, and garbage, mixed together with ground leaves and other organic refuse or crop residues, would be collected regularly, just like your garbage is collected now. Except the destination would not be a landfill, it'd be the compost yard where the organic material would be converted, through thermophilic composting, into an agricultural resource and sold to farmers, gardeners, and landscapers who'd use it to grow things. The natural cycle would be complete, immense amounts of landfill space would be saved, a valuable resource would be recovered, pollution would be prevented, and soil fertility would be enhanced. So would our long-term survival as human beings on this planet.

*M: I don't know . . . how long before people will be ready for that?*

**MS:** In Japan today, a similar system is in use, except that rather than removing the container and replacing it with a clean one, the truck that comes to pick up the humanure suctions it out of a holding

tank. Sort of like a truck sucking the contents out of a septic tank.

Such a truck system involves a capital outlay about a third of that for sewers. One study which compares the cost between manual humanure removal and waterborne sewage in Taiwan estimates manual collection costs to be less than one-fifth the cost of waterborne sewage treated by oxidation ponds. That takes into account the pasteurization of the humanure, as well as the market value of the resultant agricultural soil additive.<sup>1</sup>

*M: But that's in the Far East. We don't do stuff like that in America.*

**MS:** One of the most progressive large scale examples I have seen is in Nova Scotia, Canada. On November 30, 1998, Nova Scotia banned all organic material from entering its landfills. The municipality provides free receptacles for every household to deposit their food scraps into. So when a banana peel or burnt pop-tart gets pitched into the trash, it goes into the *green cart* along with egg shells, coffee grounds, and even cereal boxes, waxed paper, and file folders. Then, every two weeks, a truck comes around, just like the standard garbage trucks we're used to seeing, and picks up the organic material. From there, it goes to one of many central composting yards, where the material gets run through a grinder and shoved into a giant composting bin. Within 24 to 48 hours, the thermophilic microorganisms in the garbage have raised the temperature of the organic mass to 60-70°C (140-158°F). And it's a natural process.

The Netherlands was one of the first countries to mandate large scale source separation of organic material for composting, having done so since 1994; in at least five European countries, such separation is common.<sup>2</sup> Since 1993, in Germany, for example, discarded waste material must contain less than 5% organic matter, otherwise the material has to be recycled, mainly by composting.<sup>3</sup> In England and Wales, a target has been set to compost a million tonnes of organic household material by the year 2000.<sup>4</sup>

*M: But those are not toilets.*

**MS:** Can't you see? This is only one small step away from collecting toilet materials and composting them, too. Toilets will be redesigned as collection devices, not disposal devices. We've developed the art, science, and technology of composting enough to be able to constructively recycle our own excrement on a large scale.

*M: So why don't we?*

**MS:** Because humanure doesn't exist, as far as most compost professionals are concerned. It's not even on the radar screen. Human manure is seen as human waste, something to be disposed of, not recycled. When I was visiting composting operations in Nova Scotia, one compost educator told me there were 275,000 metric tonnes of animal manures produced annually in his county suitable for composting. He did not include human manure in his assessment. As far as he was concerned, humans are not animals and they don't produce manure.

To give you an example of how clueless Americans are about composting humanure, let me tell you about some missionaries in Central America.

*M: Missionaries?*

**MS:** That's right. A group of missionaries was visiting an indigenous group in El Salvador and they were appalled by the lack of sanitation. There were no flush toilets anywhere. The available toilet facilities were crude, smelly, pit latrines that bred flies. When the group returned to the United States, they were very concerned about the toilet problem they had seen, and decided they should help. But they didn't know what to do. So they shipped a dozen portable toilets down there, at great expense.

*M: Portable toilets?*

**MS:** Yeah, you know, those big, plastic outhouses you see at rest stops along the highways, at construction sites, and festivals. The ones that smell bad, and are filled with a blue liquid choked with floating turds and toilet paper.

*M: Oh yeah.*

**MS:** Well, the village in El Salvador got the portable toilets and the people there set them up. They even used them — until they filled up. The following year, the missionaries visited the village again to see how their new toilets were working.

*M: And?*

**MS:** And nothing. The toilets had filled up and the villagers stopped using them. They went back to their pit latrines. They had a dozen portable toilets sitting there filled to the brim with urine and crap, stinking to high heaven, and a fly heaven at that. The missionaries hadn't thought about what to do with the toilets when they were full. In the US, they're pumped out and the contents are taken to a sewage plant. In El Salvador, they were simply abandoned.

*M: So what's your point?*

**MS:** The point is that we don't have a clue about constructively recycling humanure. Most people in the US have never even had to think about it, let alone do it. If the missionaries had known about composting, they may have been able to help the destitute people in Central America in a meaningful and sustainable way. But they had no idea that human manure is as recyclable as cow manure.

*M: Let me get this straight. Now you're saying that humans are the same as cows?*

**MS:** Well, all animals defecate. Many westerners simply won't admit it. But we're starting to. We



Americans have a long way to go. The biggest obstacle is in understanding and accepting humanure and other organic materials as resource materials rather than waste materials. We have to stop thinking of human excrement and organic refuse as waste. When we do, then we'll stop defecating in our drinking water and stop sending our garbage to landfills.

It's critical that we separate water from humanure. As long as we keep defecating in water we'll have a problem that we can't solve. The solution is to stop fouling our water, not to find new ways to clean it up. Don't use water as a vehicle for transporting human excrement or other waste. Humanure must be collected and composted along with other solid (and liquid) organic refuse produced by human beings. We won't be able to do this as long as we insist upon defecating into water. Granted, we can dehydrate the waterborne sewage sludge and compost that. However, this is a complicated, expensive, energy-intensive process. Furthermore, the sludge can be contaminated with all sorts of bad stuff from our sewers which can become concentrated in the compost.<sup>5</sup>

*M: Composting sewage sludge is bad?*

**MS:** No. In fact, composting is probably the best thing you can do with sludge. It's certainly a step in the right direction. There are many sludge composting operations around the world, and when the sludge is composted, it makes a useful soil additive. I've visited sludge composting sites in Nova Scotia, Pennsylvania, Ohio, and Montana, and the finished compost at all of the sites is quite impressive.

*M: It'll never happen (shaking his head). Face it. Americans, westerners, will never stop shitting in water. They'll never, as a society, compost their manure. It's unrealistic. It's against our cultural upbringing. We're a society of Howdy-Doody, hotdogs, hairspray, and Ho-Hos, not composted humanure, fer chrissake. We don't believe in balancing human nutrient cycles! We just don't give a damn. Compost making is unglamorous and you can't get rich doing it. So why bother?!*

**MS:** You're right on one point — Americans will never stop shitting. But don't be so hasty. In 1988, in the United States alone, there were 49 operating municipal sludge composting facilities.<sup>6</sup> By 1997, there were over 200.<sup>7</sup> A solid waste composting plant in Oregon is designed to handle 800 tons of refuse daily.

In Duisberg, Germany, a decades-old plant composts 100 tons of domestic refuse daily. Another plant at Bad Kreuznach handles twice that amount. Many European composting plants compost a mixture of refuse and sewage sludge. There are at least three composting plants in Egypt. In Munich, a scheme was being developed in 1990 to provide 40,000 households with "biobins" for the collection of compostable refuse.<sup>8</sup>

It's only a matter of time before the biobin concept is advanced to collect humanure as well. In fact, some composting toilets already are designed so that the humanure can be wheeled away and composted at a separate site. Eventually, municipalities will assume the responsibility for collecting and composting all organic material from urban and suburban human populations, including toilet materials.

*M: Yeah, right.*

**MS:** And you are now revealing the main obstacle toward a sustainable society. Personal attitude. Everything we take for granted today — shoes, clothing, metal tools, electronic equipment, heck, even toilet paper, exists for one reason, and one reason only: because someone in the past cared about the future. You'd be running around naked today chasing rabbits with a stick if people in the past hadn't made things better for us in the present. We all have an obligation to our future generations. That's what evolution is, and that's what survival of the species requires. We have to think ahead. We have to care about our descendants too, and not just about ourselves. That means we have to understand that waste is not good for us, or for future generations. When we dump endless amounts of garbage into the environment with the attitude that someone in the future can deal with it, we are not evolving, we're *devolving*.

*M: What's that supposed to mean?*

**MS:** It's simple enough. OK, you have trash. You don't throw the trash "out." There is no "out." It has to go somewhere. So you simply sort the trash into separate receptacles in your home, and that makes it easy to recycle the stuff. When it's recycled, it's not wasted. A chimpanzee could figure that out. It's easy to understand and it's easy to do.

A lot of compost that's been produced by big composting plants has been contaminated with things like batteries, metal shards, bottle caps, paints, and heavy metals. As a result, much of it hasn't been useful for agriculture. Instead, it's been used for filler or for other non-agricultural applications, which, to me, is absurd. The way to keep junk out of compost is to value compostable material enough to collect it separately from other trash. A household biobin would do the trick. The biobin could be collected regularly, emptied, its contents composted, and the compost sold to farmers and gardeners as a financially self-supporting service provided by independent businesses.

The trick to successful large-scale compost production can be summed up in two words: *source separation*. The organic material must be separated at the source. This means that individual families will have to take some responsibility for the organic material they discard. They will no longer be permitted to throw it all in one garbage can with their plastic Ho-Ho wrappers, pop bottles, broken cell phones, and worn out toaster ovens. Organic material is too valuable to be wasted. The people in Nova Scotia have figured that out, as have many others throughout the world. Americans are a little slow.

*M: But they're not composting toilet materials, are they?*

**MS:** They're composting sewage sludge, which is a big step in the right direction. Some entrepreneurs are in the sewage composting business in the United States, too. In 1989, the town of Fairfield, Connecticut, contracted to have its yard material and sewage sludge composted. The town is said to have saved at least \$100,000 in waste disposal costs in its first year of composting alone. The Fairfield operation is just a quarter mile from half million dollar homes and is reported to smell no worse than wet

leaves from only a few yards away.<sup>9</sup>

In Missoula, Montana, all of the city's sewage sludge is composted, and the entire composting operation is funded by the tipping fees alone. All of the compost produced is pure profit, and all of it is sold. Composting is a profitable venture when properly managed.

*M: But still, there's the fear of humanure and its capability of causing disease and harboring parasites.*

**MS:** That's right. But according to the literature, a biological temperature of 50°C (122°F) for a period of 24 hours is sufficient to kill the human pathogens potentially in humanure. EPA regulations require that a temperature of 55°C (131°F) be maintained for three days when composting sewage sludge in bins. Thermophilic microorganisms are everywhere, waiting to do what they do best — make compost. They're on grass, tree branches, leaves, banana peels, garbage, and humanure. Creating thermophilic compost is not difficult or complicated, and thermophilic composting is what we need to do in order to sanitize human excrement without excessive technology and energy consumption. Thermophilic composting is something humans all over the world can do whether or not they have money or technology.

There will always be people who will not be convinced that composted humanure is pathogen-free unless every tiny scrap of it is first analyzed in a laboratory, with negative results. On the other hand, there will always be people, like me, who conscientiously compost humanure by maintaining a well-managed compost pile, and who feel that their compost has been rendered hygienically safe as a result. A layer of straw covering the finished compost pile, for example, will insulate the pile and help keep the outer surfaces from cooling prematurely. It's common sense, really. The true test comes in living with the composting system for long periods of time. I don't know anyone else who has done so, but after twenty years, I've found that the simple system I use works well for me. And I don't do anything special or go to any great lengths to make compost, other than the simple things I've outlined in this book.

Perhaps Gotaas hits the nail on the head when he says, *“The farm, the garden, or the small village compost operator usually will not be concerned with detailed tests other than those to confirm that the material is safe from a health standpoint, which will be judged from the temperature, and that it is satisfactory for the soil, which will be judged by appearance. The temperature of the compost can be checked by: a) digging into the stack and feeling the temperature of the material; b) feeling the temperature of a rod after insertion into the material; or c) using a thermometer. Digging into the stack will give an approximate idea of the temperature. The material should feel very hot to the hand and be too hot to permit holding the hand in the pile for very long. Steam should emerge from the pile when opened. A metal or wooden rod inserted two feet (0.5 m) into the pile for a period of 5-10 minutes for metal and 10-15 minutes for wood should be quite hot to the touch, in fact, too hot to hold. These temperature testing techniques are satisfactory for the smaller village and farm composting operations.”*

[10](#)

In other words, humanure composting can remain a simple process, achievable by anyone. It does not

need to be a complicated, high-tech, expensive process controlled and regulated by nervous people in white coats bending over a compost pile, shaking their heads and wringing their hands while making nerdy clucking sounds.

I want to make it clear though, that I can't be responsible for what other people do with their compost. If some people who read this book go about composting humanure in an irresponsible manner, they could run into problems. My guess is the worst thing that could happen is they would end up with a mouldered compost pile instead of a thermophilic one (I see this happen a lot). The remedy for that would be to let the mouldered pile age for a couple years before using it agriculturally, or to use it horticulturally instead.

I can't fault someone for being fecophobic, and I believe that fecophobia lies at the root of most of the concerns about composting humanure. What fecophobes may not understand is that those of us who aren't fecophobes understand the human nutrient cycle and the importance of recycling organic materials. We recycle organic refuse because we know it's the right thing to do, and we aren't hampered by irrational fears. We also make compost because we need it for fortifying our food-producing soil, and we consequently exercise a high degree of responsibility when making the compost. It's for our own good.

Then, of course, there's the composter's challenge to fecophobes: *show us a better way to deal with human excrement.*

**M:** *Sounds to me like you have the final word on the topic of humanure.*

**MS:** Hardly. The Humanure Handbook is only a tiny beginning in the dialogue about human nutrient recycling.

**M:** *Well, sir, this is starting to get boring and our time is running out, so we'll have to wrap up this interview. Besides, I've heard enough talk about the world's most notorious "end" product. So let's focus a little on the end itself, which has now arrived.*

**MS:** And this is it. This is the end?

**M:** *"This is the end." (Sung like Jim Morrison.) What d'ya say folks? (Wild applause, stamping of feet, frenzied whistling, audience jumping up and down, yanking at their hair, rolls of toilet paper thrown confetti-like through the air, clothes being torn off, cheering and screaming. Someone starts chanting "Source separation, Source separation!" What's this!?! The audience is charging the stage! The interviewee is being carried out over the heads of the crowd! Hot dang and hallelujah!)*

*Source: The Humanure Handbook. Jenkins Publishing, PO Box 607, Grove City, PA 16127. To order, phone: 1-800-639-4099.*

<http://www.jenkinspublishing.com/>

**MENU:** [HOME](#) » [Reconstruction](#) » [Recovery](#) » [Renewal](#) » [Survival](#) » [Humanure Content](#)

---

---

## THE HUMANURE HANDBOOK -- REFERENCE CITATIONS

[CHAPTER ONE](#) | [TWO](#) | [THREE](#) | [FOUR](#) | [FIVE](#) | [SIX](#) | [SEVEN](#) | [EIGHT](#) | [NINE](#) | [TEN](#)

### REFERENCES - CHAPTER ONE - CRAP HAPPENS

- 1 - Brown, Lester R., et al. (1998). State of the World 1998. New York: W. W. Norton and Co., p. 115.
- 2 - Brown, Lester R., et al. (1999). State of the World 1999. New York: W. W. Norton and Co., p. 15.
- 3 - Associated Press. (1999 January 12).
- 4 - State of the World 1999, p. 14.
- 5 - State of the World 1999, p. 88.
- 6 - State of the World 1998, p. 3, 10.
- 7 - State of the World 1999, p. 10; State of the World 1998, p. 3.
- 8 - Brown, Lester R., et al. (1998). Vital Signs 1998. New York: W. W. Norton and Co., p. 20.
- 9 - State of the World 1998, p. 4, 5.
- 10 - State of the World 1998, p. 14.
- 11 - State of the World 1999, p. 79, 83.
- 12 - State of the World 1999, p. 87.
- 13 - State of the World 1998, p. 11, 41; State of the World 1999, p. 97.
- 14 - State of the World 1999, p. 13, 97.
- 15 - State of the World 1999, p. 20, 21, 41, 46.

- 16 - Steingraber, Sandra. (1997). Living Downstream. Reading, MA: Perseus Books, p. 70.
- 17 - Living Downstream, p. 90.
- 18 - Colborn, Theo, Dumanoksi, Diane and Myers, John Peterson. (1996). Our Stolen Future. New York: Penguin Books, p.137.
- 19 - Living Downstream, p. 103.
- 20 - State of the World 1999, p. 49; Living Downstream, p. 70.
- 21 - Living Downstream, p. 38, 40, 49, 59, 60.
- 22 - Our Stolen Future, p. 137.
- 23 - Ryan, Frank, M.D. (1997). Virus X. New York: Little, Brown and Co., p. 383-390.
- 24 - State of the World 1999, p. xix.
- 25 - Gelbspan, Ross. (1997). The Heat is On. Reading, MA: Addison-Wesley Publishing Co., Inc., p. 148, 157.
- 26 - Barker, Rodney. (1998). And the Waters Turned to Blood. New York: Touchstone.

## REFERENCES - CHAPTER TWO - WASTE NOT WANT NOT

- 1 - Hershkowitz, Allen. (1997). Too Good to Throw Away: Recycling's Proven Record. Washington, D.C.: Natural Resources Defense Council, Chapter 2.
- 2 - Steingraber, Sandra. (1997). Living Downstream. Reading, MA: Perseus Books, p. 95.
- 3 - Living Downstream, p. 238.
- 4 - Too Good to Throw Away, Chapter Two.
- 5 - Brown, Lester R., et al. (1998). State of the World 1998. New York: W. W. Norton and Co., p. 106.
- 6 - Kantor, Linda S., et al. (1997, January - April). "Estimating and Addressing America's Food Losses." Food Review. Washington, D.C.: US Department of Agriculture, Commodity Economics Division, Economic Research Service.
- 7 - US Environmental Protection Agency. (May 1998) Characterization of Municipal Solid Waste in the United States: 1997 Update. Report # EPA530-R-98-007. Washington, D.C.: US Environmental Protection Agency, p. 29, 45.

- 8 - State of the World 1998, p. 102.
- 9 - State of the World 1998, p. 101, 166.
- 10 - State of the World 1998, p. 101.
- 11 - Environment Reporter. (1996 September 27)
- 12 - Too Good to Throw Away, Chapter Two.
- 13 - Too Good to Throw Away, Chapter Two.
- 14 - World Resource Foundation. (1998, April). Warmer Bulletin Information Sheet - Landfill.
- 15 - Hammond, A., et al. (Eds.) (1993). 1993 Information Please Environmental Almanac. New York. Houghton Mifflin Co., p. 60-64.
- 16 - Brown, Lester R., et al. (1999). State of the World 1999. New York: W. W. Norton and Co., p. 141.
- 17 - Daniel, J.E., et al., (Eds.). 1992 Earth Journal. Boulder, CO: Buzzworm Books, p. 94.
- 18 - Fahm, Lattee A. (1980). The Waste of Nations: The Economic Utilization of Human Waste in Agriculture. Montclair, NJ: Allenheld, Osmun & Co., p. 45.
- 19 - Golden, Jack, et al. (1979). The Environmental Impact Data Book. Ann Arbor, MI: Ann Arbor Science Publishers, Inc., p. 495.
- 20 - US Department of Commerce, National Oceanic and Atmospheric Administration, Office of Ocean Resources, Conservation and Assessment. (1987). The National Coastal Pollutant Discharge Inventory Database. Silver Spring, MD: DOC/NOAA/ORCA.
- 21 - Environment Reporter. (1991 November 22) p. 1799.
- 22 - Environment Reporter. (1992 January 3) p. 2103.
- 23 - Environment Reporter. (1992 February 14) p. 2373.
- 24 - Environment Reporter. (1991 December 27) p. 2072.
- 25 - Environment Reporter. (1992 January 17) p. 2144.
- 26 - Environment Reporter. (1992 May 1) p. 13.
- 27 - US Environmental Protection Agency. (September 1997). Beach Program, EPA#820-F-97-002. Washington, D.C.:



US Environmental Protection Agency, p. 5.

28 - Environment Reporter. (1992 July 31). Washington D.C.: Bureau of National Affairs, Inc., p. 1110.

29 - Paul, Elizabeth. (1998). Testing the Waters VIII: Has Your Vacation Beach Cleaned Up Its Act?. Washington, D.C.: Natural Resources Defense Council, Inc.; NRDC Worldview News. (1998). Pollution Persists at US Beaches. Washington, D.C.: Natural Resources Defense Council, Inc.

30 - Bitton, Gabriel. (1994). Wastewater Microbiology. New York: Wiley-Liss, Inc., p. 368-369.

31 - National Resources Defense Council. (1997). Bulletin: Stop Polluted Runoff - 11 Actions to Clean up Our Waters. <http://www.nrdc.org/nrdcpn/fppubl.html>

32 - Wastewater Microbiology, p. 86.

33 - Ralof, Janet. (1998 March 21). "Drugged Waters--Does it Matter that Pharmaceuticals are Turning Up in Water Supplies?" Science News, Vol. 153 (No. 12), p. 187-189.

34 - State of the New England Environment. (1996). Preserving New England Natural Resources. <http://www.epa.gov/region01/soe/coastal.html>

35 - Environment Reporter. (1991 November 8) p. 1745-46; (1992 January 31) p. 2299.

36 - Toward Organic Security: Environmental Restoration or the Arms Race?. Peace and Environment Platform Project, c/o World Citizens Assembly, Suite 506, 312 Sutter St., San Francisco, CA 94018.

37 - Vital Signs 1998, p. 156.

38 - Courier. (1985, January). UNESCO. 7 Place de Fentenoy, 75700 Paris, France.

39 - State of the World 1999, p. 137.

40 - Vital Signs 1998, p. 156.

41 - Vital Signs 1998, p. 156, 157.

42 - Wastewater Microbiology, p. 79-80.

43 - Wastewater Microbiology, p. 261.

44 - Associated Press. (1993 April 10). Observer-Reporter. Washington and Green Counties, PA, p. A2; Carrolton, GA statistics from Wastewater Microbiology, p. 97.

45 - Goldstein, Debra. (1997). "Your drinking water: H<sub>2</sub>O+what else?." e-Amicus. Washington, D.C.: National

- Resources Defense Council, <http://www.nrdc.org/eamicus/index.html>; US Environmental Protection Agency. Indicator 2: Population Served by Unfiltered Surface Water Systems at Risk from Microbiological Contamination. Washington, D.C.: US Environmental Protection Agency.
- 46 - Gever, John, et al. (1986). Beyond Oil: The Threat to Food and Fuel in the Coming Decades, A Summary Report. Cambridge, MA: Ballinger Publishing Co.
- 47 - Solley, Wayne B., et al. (1990). "Estimated Water Use in the United States in 1990." US Geological Survey Circular 1081, Table 31. Denver, CO. United State Geological Service, p. 65.
- 48 - National Resources Defense Council. (1996 December 24). Population and Consumption at NRDC: US Population Scorecard. Washington, D.C.: National Resources Defense Council.
- 49 - The Waste of Nations, p. xxiv.
- 50 - Stoner, Carol (Ed.). (1977). Goodbye to the Flush Toilet. Emmaus, PA: Rodale Press, Inc., p. vii.
- 51 - 1993 Information Please Environmental Almanac, p. 340-341.
- 52 - Environment Reporter. (1992 April 24) p. 2877-78.
- 53 - State of the World 1998, p. 100.
- 54 - Sides, S. (1991, August/September). "Compost." Mother Earth News, Issue 127, p. 50.
- 55 - Environment Reporter. (1992 February 28) p. 2439.
- 56 - Brown, Lester R., et al. (1998). Vital Signs 1998. New York: W. W. Norton and Co., p. 44-45.
- 57 - Vital Signs, p. 44.
- 58 - Vital Signs, p. 132.
- 59 - Vital Signs 1998, p. 132.
- 60 - US Environmental Protection Agency. PA IRIS Substance File: Nitrate, CASRN 14797-55-8. Washington, D.C.: US Environmental Protection Agency.
- 61 - 1992 Earth Journal, p. 159.
- 62 - US Environmental Protection Agency. (1990). National Survey of Pesticides in Drinking Water Wells. Washington, D.C.: US Environmental Protection Agency.
- 63 - State of the World 1999, p. 135.

64 - State of the World 1990, p. 184.

65 - Rybczynski, Witold, et al. (1982). Low Cost Technology Options for Sanitation - A State of the Art Review and Annotated Bibliography. Washington, D.C.: World Bank, p. 23.

66 - Cannon, Charles A. (1997 September 3-5). "Life Cycle Analysis and Sustainability Moving Beyond the Three R's -- Reduce, Reuse, and Recycle -- to P2R2 -- Preserve, Purify, Restore and Remediate." In E.I. Stentiford (Ed.), Proceedings of the 1997 Organic Recovery and Biological Treatment International Conference. Harrogate, UK, p. 252-253. Available from Stuart Brown, National Compost Development Association, PO Box 4, Grassington, North Yorkshire, BD23 5UR UK ([stuartbrown@compuserve.com](mailto:stuartbrown@compuserve.com))

## REFERENCES - CHAPTER THREE - MICROHUSBANDRY

1 - Shuval, Hillel I., et al. (1981). Appropriate Technology for Water Supply and Sanitation - Night Soil Composting. p.2. International Bank for Reconstruction and Development (World Bank), Washington DC, 20433, USA.

2 - Shuval, Hillel I. et al. (1981). Appropriate Technology for Water Supply and Sanitation - Night Soil Composting. p.2. International Bank for Reconstruction and Development (World Bank), Washington DC, 20433, USA.

3 - Shuval, Hillel I. et al. (1981). Appropriate Technology for Water Supply and Sanitation - Night Soil Composting. p.ii. International Bank for Reconstruction and Development (World Bank), Washington DC, 20433, USA.

4 - Rodale, J. I. (1960). The Complete Book of Composting. p. 9. Rodale Books, Inc., Emmaus, PA.

5 - Sides, S. (1991). Compost. *Mother Earth News*. Issue 127, Aug/Sept 1991 (pp.49-53).

6 - Bem, R., (1978). Everyone's Guide to Home Composting. Van Nostrand Reinhold Co., NY (p.4).

7 - Haug, Roger T. (1993). The Practical Handbook of Compost Engineering. p. 2. CRC Press, Inc., 2000 Corporate Blvd. N.W., Boca Raton, FL 33431 USA.

8 - Cannon, Charles A., (1997). *Life Cycle Analysis and Sustainability Moving Beyond the Three R's - Reduce, Reuse, and Recycle - to P2R2 - Preserve, Purify, Restore and Remediate*. As seen in the 1997 Organic Recovery and Biological Treatment Proceedings, Stentiford, E.I. (ed.). International Conference, Harrogate, United Kingdom. 3-5 September, 1997. P. 253. Available from Stuart Brown, National Compost Development Association, PO Box 4, Grassington, North Yorkshire, BD23 5UR UK ([stuartbrown@compuserve.com](mailto:stuartbrown@compuserve.com)).

9 - Howard, Sir Albert, (1943). An Agricultural Testament. Oxford University Press: New York.

10 - Bhamidimarri, R. (1988). Alternative Waste Treatment Systems. Elsevier Applied Science Publishers LTD., Crown House, Linton Road, Barking, Essex, IG11 8JU, England. (p.129).

11 - Rynk, Robert, ed. (1992). On-Farm Composting Handbook. Northeast Regional Agricultural Engineering Service. Ph:

(607) 255-7654. p. 12.

12 - Haug, Roger T. (1993). The Practical Handbook of Compost Engineering. p. 2. CRC Press, Inc., 2000 Corporate Blvd. N.W., Boca Raton, FL 33431 USA.

13 - Palmisano, Anna C. and Barlaz, Morton A. (Eds.) (1996). Microbiology of Solid Waste. P. 129. CRC Press, Inc., 2000 Corporate Blvd., N.W., Boca Raton, FL 33431 USA.

14 - Howard, Sir Albert, (1943). An Agricultural Testament. (p.48).

15 - Ingham, Elaine (1998). *Anaerobic Bacteria and Compost Tea*. *Biocycle*, June 1998, p 86. The JG Press, Inc., 419 State Avenue, Emmaus, PA 18049.

16 - Stoner, C.H. (Ed.). (1977). Goodbye to the Flush Toilet. Rodale Press: Emmaus, PA, 1977. (p.46).

17 - Rodale, J.I. et al. (Eds.). (1960). The Complete Book of Composting. Rodale Books Inc.: Emmaus, Pa (pp.646-647).

18 - Gotaas, Harold B., (1956). Composting - Sanitary Disposal and Reclamation of Organic Wastes. p.39. World Health Organization, Monograph Series Number 31. Geneva.

19 - *Mixing Browns and Greens For Backyard Success*. *Biocycle*, Journal of Composting and Recycling, January 1998. p. 20 (Regional Roundup). JG Press, Inc., 419 State Ave., Emmaus, PA 18049 USA.

20 - Brock, Thomas D. (1986). Thermophiles - General, Molecular, and Applied Biology. p.4. John Wiley and Sons, Inc.

21 - Madigan, Michael T. et al. (1997). Brock Biology of Microorganisms, Eighth edition. Pp. 150, 167. Information about water heaters, as well as temperature ranges of bacteria.

22 - Waksman, S.A. (1952). Soil Microbiology. John Wiley and Sons, Inc., New York. (p.70).

23 - Rynk, Robert, ed. (1992). On-Farm Composting Handbook. Northeast Regional Agricultural Engineering Service. Ph: (607) 255-7654. p. 55.

24 - Thimann, K.V. (1955). The Life of Bacteria: Their Growth, Metabolism, and Relationships. The Macmillan Co., New York. (p.177).

25 - Wade, Nicholas (1996). *Universal Ancestor*. The New York Times, as seen in the Pittsburgh Post-Gazette, Monday, August 26, 1996, p. A-8.

26 - Brock, Thomas D. (1986). Thermophiles - General, Molecular, and Applied Biology. p.23. John Wiley and Sons, Inc.

27 - Bitton, Gabriel (1994). Wastewater Microbiology. p. 81. Wiley-Liss, Inc. 605 Third Avenue, New York, NY 10518-0012.

28 - Bitton, Gabriel (1994). Wastewater Microbiology. p. 212. Wiley-Liss, Inc. 605 Third Avenue, New York, NY 10518-

0012.

29 - Palmisano, Anna C. and Barlaz, Morton A. (Eds.) (1996). Microbiology of Solid Waste. P. 123. CRC Press, Inc., 2000 Corporate Blvd., N.W., Boca Raton, FL 33431 USA.

30 - Lynch, J.M. and Poole, N.L. (Eds.). (1979). Microbial Ecology: A Conceptual Approach. Blackwell Scientific Publications, London. (p.238).

31 - Sterritt, Robert M. (1988). Microbiology for Environmental and Public Health Engineers. P. 53. E. & F. N. Spon Ltd., New York, NY 10001 USA.

32 - Palmisano, Anna C. and Barlaz, Morton A. (Eds.) (1996). Microbiology of Solid Waste. Pp. 124, 125, 129, 133. CRC Press, Inc., 2000 Corporate Blvd., N.W., Boca Raton, FL 33431 USA.

33 - Ingham, Elaine (1998). *Replacing Methyl Bromide with Compost*. *Biocycle*, Journal of Composting and Recycling, December 1998. p. 80. JG Press, Inc., 419 State Ave., Emmaus, PA 18049 USA.

34 - Curry, Dr. Robin (1977). Composting of Source Separated Domestic Organic Waste by Mechanically Turned Open Air Windrowing. As seen in the 1997 Organic Recovery and Biological Treatment Proceedings, Stentiford, E.I. (ed.). International Conference, Harrogate, United Kingdom. 3-5 September, 1997. P. 184.

35 - *Applied Microbiology*, December 1969.

36 - Gotaas, Harold B., (1956). Composting - Sanitary Disposal and Reclamation of Organic Wastes (p.20). World Health Organization, Monograph Series Number 31. Geneva.

37 - Curry, Dr. Robin (1977). Composting of Source Separated Domestic Organic Waste by Mechanically Turned Open Air Windrowing. As seen in the 1997 Organic Recovery and Biological Treatment Proceedings, Stentiford, E.I. (ed.). International Conference, Harrogate, United Kingdom. 3-5 September, 1997. P. 183.

38 - Palmisano, Anna C. and Barlaz, Morton A. (Eds.) (1996). Microbiology of Solid Waste. P. 169. CRC Press, Inc., 2000 Corporate Blvd., N.W., Boca Raton, FL 33431 USA.

39 - Palmisano, Anna C. and Barlaz, Morton A. (Eds.) (1996). Microbiology of Solid Waste. Pp. 121, 124, 134. CRC Press, Inc., 2000 Corporate Blvd., N.W., Boca Raton, FL 33431 USA.

40 - Rodale, J. I. (1960). The Complete Book of Composting. p. 702. Rodale Books, Inc., Emmaus, PA.

41 - Curry, Dr. Robin (1977). Composting of Source Separated Domestic Organic Waste by Mechanically Turned Open Air Windrowing. As seen in the 1997 Organic Recovery and Biological Treatment Proceedings, Stentiford, E.I. (ed.). International Conference, Harrogate, United Kingdom. 3-5 September, 1997. P. 183.

42 - Brock, Thomas D. (1986). Thermophiles - General, Molecular, and Applied Biology. p.244. John Wiley and Sons, Inc.

43 - Rynk, Robert, ed. (1992). On-Farm Composting Handbook. Northeast Regional Agricultural Engineering Service. Ph:

(607) 255-7654. p. 13.

44 - *Biocycle*, November 1998, p.18.

45 - Rodale, J. I. (1960). The Complete Book of Composting. p. 932. Rodale Books, Inc., Emmaus, PA.

46 - Smalley, Curtis (1998). *Hard Earned Lessons on Odor Management*. *Biocycle*, Journal of Composting and Recycling, January 1998. p. 59. JG Press, Inc., 419 State Ave., Emmaus, PA 18049 USA.

47 - Brinton, William F. Jr. (date unknown). *Sustainability of Modern Composting - Intensification Versus Cost and Quality*. Woods End Institute, PO Box 297, Mt. Vernon, Maine 04352 USA.

48 - Brinton, William F. Jr. (date unknown). *Sustainability of Modern Composting - Intensification Versus Cost and Quality*. Woods End Institute, PO Box 297, Mt. Vernon, Maine 04352 USA.

49 - Palmisano, Anna C. and Barlaz, Morton A. (Eds.) (1996). Microbiology of Solid Waste. P. 170. CRC Press, Inc., 2000 Corporate Blvd., N.W., Boca Raton, FL 33431 USA.

50 - *Researchers Study Composting in the Cold*. *Biocycle*, Journal of Composting and Recycling, January 1998. p. 24 (Regional Roundup). JG Press, Inc., 419 State Ave., Emmaus, PA 18049 USA.

51 - Gotaas, Harold B., (1956). Composting - Sanitary Disposal and Reclamation of Organic Wastes. p.77. World Health Organization, Monograph Series Number 31. Geneva.

52 - Regan, Raymond W. (1998). *Approaching 50 years of Compost Research*. *Biocycle*, Journal of Composting and Recycling, October 1998. p. 82. JG Press, Inc., 419 State Ave., Emmaus, PA 18049 USA.

53 - Howard, Sir Albert (1943). An Agricultural Testament. Oxford University Press: New York. (p.44). Also see: Rodale, J.I. (1946). *Pay Dirt*. The Devon-Adair Co.: New York.

54 - Rodale, J.I. et al. (Eds.) (1960). The Complete Book of Composting. Rodale Books Inc.: Emmaus, PA (p.658).

55 - Regan, Raymond W. (1998). *Approaching 50 years of Compost Research*. *Biocycle*, Journal of Composting and Recycling, October 1998. p. 82. JG Press, Inc., 419 State Ave., Emmaus, PA 18049 USA.

56 - Poncavage, J. and Jesiolowski, J. (1991). Mix Up a Compost and a Lime. *Organic Gardening*. March 1991, Vol. 38, Issue 3. (p.18).

57 - Gotaas, Harold B., (1956). Composting - Sanitary Disposal and Reclamation of Organic Wastes. p.93. World Health Organization, Monograph Series Number 31. Geneva.

58 - Palmisano, Anna C. and Barlaz, Morton A. (Eds.) (1996). Microbiology of Solid Waste. P. 132. CRC Press, Inc., 2000 Corporate Blvd., N.W., Boca Raton, FL 33431 USA.

59 - US EPA (1998). An Analysis of Composting as an Environmental Remediation Technology. EPA530-B-98-001,

March 1998.

60 - Haug, Roger T. (1993). The Practical Handbook of Compost Engineering. p. 9. CRC Press, Inc., 2000 Corporate Blvd. N.W., Boca Raton, FL 33431 USA.

61 - US EPA (October 1997). *Innovative Uses of Compost - Bioremediation and Pollution Prevention*. EPA530-F-97-042.

62 - US EPA (1998). An Analysis of Composting as an Environmental Remediation Technology. EPA530-B-98-001, March 1998.

63 - Cannon, Charles A., (1997). Life Cycle Analysis and Sustainability Moving Beyond the Three R's - Reduce, Reuse, and Recycle - to P2R2 - Preserve, Purify, Restore and Remediate. As seen in the 1997 Organic Recovery and Biological Treatment Proceedings, Stentiford, E.I. (ed.). International Conference, Harrogate, United Kingdom. 3-5 September, 1997. P. 253. Available from Stuart Brown, National Compost Development Association, PO Box 4, Grassington, North Yorkshire, BD23 5UR UK ([stuartbrown@compuserve.com](mailto:stuartbrown@compuserve.com)).

64 - US EPA (October 1997). *Innovative Uses of Compost - Bioremediation and Pollution Prevention*. EPA530-F-97-042.

65 - Logan, W.B. (1991). "Rot is Hot." *New York Times Magazine*. 9/8/91, Vol. 140, Issue 4871. (p.46).

66 - *Compost Fungi Used to Recover Wastepaper*. Biocycle, Journal of Composting and Recycling, May 1998. p. 6 (Biocycle World). JG Press, Inc., 419 State Ave., Emmaus, PA 18049 USA.

67 - Young, Lily Y., and Cerniglia, Carl E. (Eds.) (1995). Microbial Transformation and Degradation of Toxic Organic Chemicals. Pp. 408, 461, and Table 12.5. Wiley-Liss, Inc. 605 Third Avenue, New York, NY 10518-0012.

68 - Palmisano, Anna C. and Barlaz, Morton A. (Eds.) (1996). Microbiology of Solid Waste. P. 127. CRC Press, Inc., 2000 Corporate Blvd., N.W., Boca Raton, FL 33431 USA.

69 - Logan, W.B. (1991). "Rot is Hot." *New York Times Magazine*. 9/8/91, Vol. 140, Issue 4871. (p.46).

70 - Lubke, Sigfried. (1989). Interview: All Things Considered in the Wake of the Chernobyl Nuclear Accident. *Acres U.S.A.* December 1989. (p. 20) [also contact Uta and Sigfried Lubke, A4722 Peuerbach, Untererleinsbach 1, Austria]

71 - US EPA (1998). An Analysis of Composting as an Environmental Remediation Technology. EPA530-B-98-001, March 1998.

72 - Cannon, Charles A., (1997). *Life Cycle Analysis and Sustainability Moving Beyond the Three R's - Reduce, Reuse, and Recycle - to P2R2 - Preserve, Purify, Restore and Remediate*. As seen in the 1997 Organic Recovery and Biological Treatment Proceedings, Stentiford, E.I. (ed.). International Conference, Harrogate, United Kingdom. 3-5 September, 1997. P. 254. Available from Stuart Brown, National Compost Development Association, PO Box 4, Grassington, North Yorkshire, BD23 5UR UK ([stuartbrown@compuserve.com](mailto:stuartbrown@compuserve.com)).and Schonberner, Doug (1998). *Reclaiming Contaminated Soils*, as well as Block, Dave (1998). *Composting Breaks Down Explosives*. Biocycle, Journal of Composting and Recycling, September 1998, 36-40.

73 - US EPA (1998). An Analysis of Composting as an Environmental Remediation Technology. EPA530-B-98-001,

March 1998.

74 - Block, Dave (1998). *Degrading PCB's Through Composting*. Biocycle, Journal of Composting and Recycling, December 1998. p. 45-48. JG Press, Inc., 419 State Ave., Emmaus, PA 18049 USA.

75 - US EPA (October 1997). *Innovative Uses of Compost - Bioremediation and Pollution Prevention*. EPA530-F-97-042.

76 - US EPA (October 1997). *Innovative Uses of Compost - Bioremediation and Pollution Prevention*. EPA530-F-97-042.

77 - Rynk, Robert, ed. (1992). On-Farm Composting Handbook. Northeast Regional Agricultural Engineering Service. Ph: (607) 255-7654. p. 83.

78 - Hoitink, Harry A. J. et al., (1997). Suppression of Root and Foliar Diseases Induced by Composts. As seen in the 1997 Organic Recovery and Biological Treatment Proceedings, Stentiford, E.I. (ed.). International Conference, Harrogate, United Kingdom. 3-5 September, 1997. p. 95.

79 - US EPA (October 1997). *Innovative Uses of Compost - Disease Control for Plants and Animals*. EPA530-F-97-044.

80 - US EPA (1998). An Analysis of Composting as an Environmental Remediation Technology. EPA530-B-98-001, March 1998.

81 - Logan, W.B. (1991). "Rot is Hot". *New York Times Magazine*. 9/8/91, Vol. 140, Issue 4871. (p.46).

82 - US EPA (1998). An Analysis of Composting as an Environmental Remediation Technology. EPA530-B-98-001, March 1998.

83 - Trankner, Andreas, and Brinton, William (date unknown). *Compost Practices for Control of Grape Powdery Mildew (Uncinula necator)*. Woods End Institute, PO Box 297, Mt. Vernon, Maine 04352 USA.

84 - Quote from Elaine Ingham as reported in: Grobe, Karin (1998). *Fine-Tuning the Soil Web*. Biocycle, Journal of Composting and Recycling, January 1998. p. 46. JG Press, Inc., 419 State Ave., Emmaus, PA 18049 USA.

85 - Sides, S. (1991). Compost. *Mother Earth News*. Issue 127, Aug/Sept 1991 (p.50).

86 - US EPA (October 1997). *Innovative Uses of Compost - Disease Control for Plants and Animals*. EPA530-F-97-044.

87 - Biocycle, Journal of Composting and Recycling, October 1998. p. 26. JG Press, Inc., 419 State Ave., Emmaus, PA 18049 USA.

88 - US EPA (October 1997). *Innovative Uses of Compost - Disease Control for Plants and Animals*. EPA530-F-97-044.

89 - Brodie, Herbert L., and Carr, Lewis E. (1997). Composting Animal Mortality. As seen in the 1997 Organic Recovery and Biological Treatment Proceedings, Stentiford, E.I. (ed.). International Conference, Harrogate, United Kingdom. 3-5 September, 1997. Pp. 155-159.



- 90 - McKay, Bart (1998). *Com-Postal-Ing in Texas*. Biocycle, Journal of Composting and Recycling, May 1998. p. 44-46. JG Press, Inc., 419 State Ave., Emmaus, PA 18049 USA.
- 91 - *Garbage: the Practical Journal for the Environment*. May/June 1992, p.66, Old House Journal Corp., 2 Main St., Gloucester, MA 01930.
- 92 - Logan, W.B. (1991). "Rot is Hot." *New York Times Magazine*. 9/8/91, Vol. 140, Issue 4871.
- 93 - Biocycle, Journal of Composting and Recycling, November 1998. p. 18. JG Press, Inc., 419 State Ave., Emmaus, PA 18049 USA.

## **REFERENCES - CHAPTER FOUR - DEEP SH\*T**

- 1 - Bulletin of the Atomic Scientists. September/October 1998.
- 2 - Wilson, N.W., (1966). Three Ways of Asian Wisdom. Simon and Shuster: New York. (p.11-12).
- 3 - Ibid. (p.77-78).
- 4 - Ibid. (p.137).
- 5 - Ibid. (p.145).
- 6 - Ibid. (p.140).
- 7 - Lao Tsu. Tao Te Ching. Vintage Books Edition, 1972. Vintage Books (Random House): New York. (#57).
- 8 - Holy Bible. King James Version. The World Publishing Co.: New York. (p.9).
- 9 - Rodale, J. I., (1946). Paydirt, Devon-Adair Co.: NY, (p.vi).
- 10 - *Beyond Oil: The Threat to Food and Fuel in the Coming Decades, A summary Report*. November 1986. Carrying Capacity Inc., 1325 G. Street, NW, Suite 1003, Wash. D.C. 10005.
- 11 - King, F.H., (1911). Farmers of Forty Centuries. Rodale Press: Emmaus, PA 18049.
- 12 - Ibid. (p.193, 196-7).
- 13 - Ibid. (p.10).
- 14 - Ibid. (p.19).
- 15 - Ibid. (p.199).

- 16 - White, A.D. (1955). The Warfare of Science with Theology. George Braziller: New York. (pp.68,70).
- 17 - Ibid. (p.69).
- 18 - Ibid. (p.71).
- 19 - Ibid. (p.73).
- 20 - Ibid. (pp.76-77).
- 21 - Ibid. (p.84).
- 22 - Ibid. (p.85).
- 23 - Reyburn, Wallace (1989). Flushed with Pride - The Story of Thomas Crapper. Pavilion Books Limited, 196 Shaftesbury Avenue, London WC2H 8JL. pp. 24-25.
- 24 - Seaman, L.C.B. (1973). Victorian England. Methuan & Co.: London. (pp. 48-56).
- 25 - Shuval, Hillel I. et al. (1981). Appropriate Technology for Water Supply and Sanitation - Night Soil Composting. Abstract. World Bank, Washington DC 20433, USA.
- 26 - Winblad, Uno, and Kilama, Wen (1985). Sanitation Without Water. Macmillan Education Ltd., London and Basingstoke. p. 12.
- 27 - Edmonds, Richard Louis (1994). Patterns of China's Lost Harmony - A Survey of the Country's Environmental Degradation and Protection. p. 9, 132, 137, 142, 146, 156. Routledge, 11 New Fetter Lane, London EC4P 4EE and 29 West 35th Street, New York, NY 10001.
- 28 - Hoitink, Harry A. J. et al., (1997). *Suppression of Root and Foliar Diseases Induced by Composts*. As seen in the 1997 Organic Recovery and Biological Treatment Proceedings, Stentiford, E.I. (ed.). International Conference, Harrogate, United Kingdom. 3-5 September, 1997. p. 97.
- 29 - Farmers of Forty Centuries. (p.198).

## REFERENCES - CHAPTER FIVE - A DAY IN THE LIFE OF A TURD

- 1 - Mancini, K. *Septic Tank - Soil Absorption Systems*. Agricultural Engineering Fact Sheet SW-44. Penn State College of Agriculture Cooperative Extension, University Park, PA 16802.
- 2 - Mancini, K. *Mound Systems for Wastewater Treatment*. SW-43. Same as above.

- 3 - Stewart, John G. (1990). Drinking Water Hazards: How to Know if There Are Toxic Chemicals in Your Water and What to Do If There Are. Envirographics: Hiram, Ohio. (pp.177-178).
- 4 - van der Leeden, F. et al. (1990). The Water Encyclopedia. Lewis Publishers Inc.: Chelsea, Michigan, 48118. (p.526).
- 5 - Ibid. (p.525).
- 6 - Stewart, John G. (as in #3 above, same pages).
- 7 - Ibid.
- 8 - Environment Reporter. 2/28/92. The Bureau of National Affairs, Inc., Washington D.C., (pp. 2441-2).
- 9 - Gray, N.F. (1990). Activated Sludge Theory and Practice. Oxford University Press: New York. (p.125).
- 10 - Journal of Environmental Health. July/August 1989. "EPA Proposes New Rules for Sewage Sludge Disposal". (P.321).
- 11 - Logan, W.B. (1991). "Rot is Hot." New York Times Magazine. 9/8/91 Vol. 140, Issue 4871, p.46.
- 12 - van der Leeden, F. et al. (1990). The Water Encyclopedia Second Edition. Lewis Publishers, 121 South Main Street, Chelsea, Michigan 48118 (p. 541).
- 13 - Garbage. February/March 1993. Old House Journal Corp., 2 Main St., Gloucester, MA 01930. (p.18).
- 14 - Pickford, John (1995). Low-Cost Sanitation - A Survey of Practical Experience. p. 96. IT Publications, 103-105 Southampton Row, London WC1B 4HH, UK.
- 15 - US EPA (1996). Wastewater Treatment: Alternatives to Septic Systems (Guidance Document). EPA/909-K-96-001. US Environmental Protection Agency, Region 9, Drinking Water Program (W-6-3). p. 16-19. and:US EPA (1987). It's Your Choice - A Guidebook for Local Officials on Small Community Wastewater Management Options. EPA 430/9-87-006. United States Environmental Protection Agency, Office of Municipal Pollution Control (WH-595), Municipal Facilities Division, Washington DC 20460. p.55.
- 16 - Manahan, S.E. (1990). Hazardous Waste Chemistry, Toxicology and Treatment. Lewis Publishers, Inc.: Chelsea, Michigan. (p.131).
- 17 - Bitton, Gabriel (1994). Wastewater Microbiology. p. 120. Wiley-Liss, Inc. 605 Third Avenue, New York, NY 10518-0012.
- 18 - Ibid. (pp. 148-49).
- 19 - Baumann, Marty. USA Today. Feb 2, 1994, p. 1A, 4A. USA Today (Gannet Co. Inc.) 1000 Wilson Blvd., Arlington, VA 22229.

- 20 - "The Perils of Chlorine." *Audubon Magazine*, 93:30-2. Nov/Dec 1991.
- 21 - Liptak, B.G. (1991). Municipal Waste Disposal in the 1990's. Chilton Book Co.: Radnor, PA. (pp.196-8).
- 22 - Bitton, Gabriel (1994). Wastewater Microbiology. p. 312. Wiley-Liss, Inc. 605 Third Avenue, New York, NY 10518-0012.
- 23 - Stiak, J. "The Trouble With Chlorine." *Buzzworm*. Nov/Dec 1992. (p.22).
- 24 - Bitton, Gabriel (1994). Wastewater Microbiology. p. 121. Wiley-Liss, Inc. 605 Third Avenue, New York, NY 10518-0012.
- 25 - Environment Reporter. 7/10/92. (p.767).
- 26 - Bitton, Gabriel (1994). Wastewater Microbiology. p. 121. Wiley-Liss, Inc. 605 Third Avenue, New York, NY 10518-0012.
- 27 - *Buzzworm*. March/April 1993. (p.17).
- 28 - *Environment Reporter*. 7/10/92. (p.767).
- 29 - Ibid. 4/24/92. (p.2879).
- 30 - Ibid. 8/7/92. (p.1155).
- 31 - Burke, W.K. "A Prophet of Eden." *Buzzworm*. Vol. IV, Number 2, March/April 1992. (pp.18-19).
- 32 - Environment Reporter. 8/7/92. (P.1152).
- 33 - Ibid. 5/15/92. (p.319).
- 34 - Bitton, Gabriel (1994). Wastewater Microbiology. p. 352. Wiley-Liss, Inc. 605 Third Avenue, New York, NY 10518-0012.
- 35 - Ibid. 3/6/92 (p. 2474) and 1/17/92 (p.2145).
- 36 - Ibid. 1/3/92 (p.2109).
- 37 - Ibid. 11/1/91 (p.1657) and 9/27/96 (p. 1212).
- 38 - Hammond, A. et al. (Eds.) (1993). The 1993 Information Please Environmental Almanac. Compiled by the World Resources Institute. Houghton Mifflin Co.: New York. (p.41).
- 39 - Purves, D. (1990). "Toxic Sludge." *Nature*. Vol. 346, 8/16/1990 (pp. 617-18).

- 40 - Bitton, Gabriel (1994). Wastewater Microbiology. p. 352. Wiley-Liss, Inc. 605 Third Avenue, New York, NY 10518-0012.
- 41 - Rybczynski, W. et al. (1982). Appropriate Technology for Water Supply and Sanitation - Low Cost Technology Options for Sanitation, A State of the Art Review and Annotated Bibliography. World Bank. (p. 124).
- 42 - Ibid. (p. 125).
- 43 - Sterritt, Robert M. (1988). Microbiology for Environmental and Public Health Engineers. P. 160. E. & F. N. Spon Ltd., New York, NY 10001 USA.
- 44 - Fahm, L.A. (1980). The Waste of Nations. Allanheld, Osmun & Co.: Montclair, NJ (p.61).
- 45 - Shuval, Hillel I. et al. (1981). Appropriate Technology for Water Supply and Sanitation - Night Soil Composting. p.5. International Bank for Reconstruction and Development (World Bank), Washington DC, 20433, USA
- 46 - Bitton, Gabriel (1994). Wastewater Microbiology. p. 166, 352. Wiley-Liss, Inc. 605 Third Avenue, New York, NY 10518-0012.
- 47 - Sterritt, Robert M. (1988). Microbiology for Environmental and Public Health Engineers. P. 242, 251-2. E. & F. N. Spon Ltd., New York, NY 10001 USA.
- 48 - Radtke, T.M., and Gist, G.L. (1989). "Wastewater Sludge Disposal: Antibiotic Resistant Bacteria May Pose Health Hazard." *Journal of Environmental Health*. Vol 52, No.2, Sept/Oct 1989. (pp.102-5).
- 49 - *Environment Reporter*. 7/10/92. (p.770).
- 50 - *Environment Reporter*. 11/1/91. (p.1653).
- 51 - Ibid. 1/17/92. (p.2154).
- 52 - Damsker, M. (1992). "Sludge Beats Lead." *Organic Gardening*. Feb, 1992, Vol. 39, Issue 2, p.19.
- 53 - Contact JCH Environmental Engineering, Inc., 2730 Remington Court, Missoula, MT 59801-7121. Phone (406) 721-1164.
- 54 - Miller, T. L. et al., (1992). *Selected Metal and Pesticide Content of Raw and Mature Compost Samples from Eleven Illinois Facilities*. Illinois Department of Energy and Natural Resources. and: Manios, T. and Stentiford, E.I. (1998). Heavy Metals Fractionation Before, During, and After Composting of Urban Organic Residues. As seen in the 1997 Organic Recovery and Biological Treatment Proceedings, Stentiford, E.I. (ed.). International Conference, Harrogate, United Kingdom. 3-5 September, 1997. p. 227-232.
- 55 - US EPA, (1989) - Summary Report: In-Vessel Composting of Municipal Wastewater Sludge. pp. 20, 161. EPA/625/8-89/016. Center for Environmental Research Information, Cincinnati, OH.

56 - Fahm. (1980). The Waste of Nations. (p.xxiv).

57 - Ibid. (p.40).

58 - Shuval, Hillel I. et al. (1981). Appropriate Technology for Water Supply and Sanitation - Night Soil Composting. (summary). International Bank for Reconstruction and Development (World Bank), Washington DC, 20433, USA.

59 - Rivard, C.J. et al. (1989). "Waste to Energy." *Journal of Environmental Health*. Vol 52, No.2, Sept/Oct 1989. (p.100).

60 - See *Garbage*, Oct/Nov 1992, (p.14).

## REFERENCES - CHAPTER SIX - COMPOSTING TOILETS & SYSTEMS

1 - Rybczynski, W. et al. (1982). Appropriate Technology for Water Supply and Sanitation - Low Cost Technology Options for Sanitation, A State of the Art Review and Annotated Bibliography. World Bank. Transportation and Water Department, 1818 H Street N.W., Washington D.C. 20433 USA.

2 - Franceys et al. (1992). A Guide to the Development of On-Site Sanitation. World Health Organization, Geneva. (p. 213).

3 - McGarry, Michael G., and Stainforth, Jill (eds.) (1978). Compost, Fertilizer, and Biogas Production from Human and Farm Wastes in the People's Republic of China. International Development Research Center, Box 8500, Ottawa, Canada, K1G 3H9 (pages 9, 10, 29, 32).

4 - Rybczynski, W. et al. (1982). Appropriate Technology for Water Supply and Sanitation - Low Cost Technology Options for Sanitation, A State of the Art Review and Annotated Bibliography. World Bank. Transportation and Water Department, 1818 H Street N.W., Washington D.C. 20433 USA. (p. 114).

5 - McGarry, Michael G., and Stainforth, Jill (eds.) (1978). Compost, Fertilizer, and Biogas Production from Human and Farm Wastes in the People's Republic of China. International Development Research Center, Box 8500, Ottawa, Canada, K1G 3H9.

6 - Winblad, Uno, and Kilama, Wen (1985). Sanitation Without Water. Macmillan Education Ltd., London and Basingstoke. pp. 20-21.

7 - Winblad, Uno (Ed.) (1998). Ecological Sanitation. Swedish International Development Cooperation Agency, Stockholm, Sweden. p. 25.

8 - Rybczynski, W. et al. (1982). Appropriate Technology for Water Supply and Sanitation - Low Cost Technology Options for Sanitation, A State of the Art Review and Annotated Bibliography. World Bank. Transportation and Water Department, 1818 H Street N.W., Washington D.C. 20433 USA.

9 - Ibid.

10 - Clivus Multrum Maintenance Manual, Clivus Multrum, Inc., 21 Canal St., Lawrence, Mass. 01840. (Also contact Hanson Assoc., Lewis Mill, Jefferson, MD 21755).

11 - Ibid.

12 - Ibid.

13 - Source: Pickford, John (1995). Low-Cost Sanitation, Intermediate Technology Publications, 103-105 Southampton Row, London WC1B 4HH, UK. p. 68.

14 - Sun Mar Corp., 900 Hertel Ave., Buffalo, NY 14216 USA; or 5035 North Service Road, Burlington, Ontario, Canada L7L 5V2.

15 - AlasCan, Inc., 3400 International Way, Fairbanks, Alaska 99701, phone/fax (907) 452-5257 [as seen in *Garbage*, Feb/Mar 1993, p.35].

16 - Composting Toilet Systems, PO Box 1928 (or 1211 Bergen Rd.), Newport, WA 99156, phone: (509) 447-3708; Fax: (509) 447-3753.

## REFERENCES - CHAPTER SEVEN - WORMS AND DISEASE

1 - Kristof, Nicholas D. (1995). *Japanese is Too Polite for Words*. Pittsburgh Post Gazette, Sunday, September 24, 1995. P. B-8.

2 - Beeby, John (1995). The Tao of Pooh (now titled Future Fertility). Disclaimer, and pp. 64-65. Ecology Action of the Midpeninsula, 5798 Ridgewood Road, Willits, CA 95490-9730.

3 - Beeby, John (1995). The Tao of Pooh (now titled Future Fertility). Pp. 11-12. Ecology Action of the Midpeninsula, 5798 Ridgewood Road, Willits, CA 95490-9730.

4 - Barlow, Ronald S. (1992). The Vanishing American Outhouse. P. 2. Windmill Publishing Co., 2147 Windmill View Road, El Cajon, California 92020 USA.

5 - Warren, George M. (1922 - revised 1928). Sewage and Sewerage of Farm Homes. US Department of Agriculture, Farmer's Bulletin No. 1227. As seen in: Barlow, Ronald S. (1992). The Vanishing American Outhouse. Pp. 107-110. Windmill Publishing Co., 2147 Windmill View Road, El Cajon, California 92020 USA.

6 - Shuval, Hillel I. et al. (1981). Appropriate Technology for Water Supply and Sanitation - Night Soil Composting. p.8. International Bank for Reconstruction and Development (World Bank), Washington DC, 20433, USA.

7 - Tompkins, P., and Boyd, C. (1989). Secrets of the Soil. Harper and Row: New York. (pp.94-5).

8 - Howard, Sir Albert. The Soil and Health: A Study of Organic Agriculture. Schocken: New York. 1947. (pp. 37-38).

- 9 - Ibid. (p.177).
- 10 - Feachem, et al. (1980). Appropriate Technology for Water Supply and Sanitation. The World Bank, Director of Information and Public Affairs, Washington D.C. 20433.
- 11 - Sterritt, Robert M. (1988). Microbiology for Environmental and Public Health Engineers. P. 238. E. & F. N. Spon Ltd., New York, NY 10001 USA.
- 12 - Jervis, N. "Waste Not, Want Not". *Natural History*. May, 1990 (p.73).
- 13 - Winblad, Uno (Ed.) (1998). Ecological Sanitation. Swedish International Development Cooperation Agency, Stockholm, Sweden. p. 75.
- 14 - Sterritt, Robert M. (1988). Microbiology for Environmental and Public Health Engineers. Pp. 59-60. E. & F. N. Spon Ltd., New York, NY 10001 USA.
- 15 - Palmisano, Anna C. and Barlaz, Morton A. (Eds.) (1996). Microbiology of Solid Waste. Pp. 159. CRC Press, Inc., 2000 Corporate Blvd., N.W., Boca Raton, FL 33431 USA.
- 16 - Gotaas, Harold B., (1956). Composting - Sanitary Disposal and Reclamation of Organic Wastes. p.20. World Health Organization, Monograph Series Number 31. Geneva.
- 17 - Sopper, W.E. and Kardos, L.T. (Eds.). (1973). Recycling Treated Municipal Wastewater and Sludge Through Forest and Cropland. The Pennsylvania State University, University Park, PA (pp. 248-51).
- 18 - Ibid. (pp. 251-252).
- 19 - Shuval, Hillel I. et al. (1981). Appropriate Technology for Water Supply and Sanitation - Night Soil Composting. p.4. International Bank for Reconstruction and Development (World Bank), Washington DC, 20433, USA.
- 20 - Sterritt, Robert M. (1988). Microbiology for Environmental and Public Health Engineers. P. 252. E. & F. N. Spon Ltd., New York, NY 10001 USA.
- 21 - Cheng, Thomas C. (1973). General Parasitology. Academic Press, Inc., 111 Fifth Avenue, New York, NY 10003 (p. 645).
- 22 - Shuval, Hillel I. et al. (1981). Appropriate Technology for Water Supply and Sanitation - Night Soil Composting. p.6. International Bank for Reconstruction and Development (World Bank), Washington DC, 20433, USA.
- 23 - Feachem et al. (1980). Appropriate Technology for Water Supply and Sanitation: Health Aspects of Excreta and Sullage Management. Energy, Water and Telecommunications Department of the World Bank, 1818 H Street N.W., Washington D.C. 20433. This comprehensive work cites 394 references from throughout the world, and was carried out as part of the World Bank's research project on appropriate technology for water supply and sanitation.
- 24 - Ibid.



- 25 - Olson, O. W. (1974). Animal Parasites - Their Life Cycles and Ecology. University Park Press, Baltimore, MD (p. 451-452).
- 26 - Crook, James (1985). "Water Reuse in California." *Journal of the American Waterworks Association*. v77, no. 7. as seen in The Water Encyclopedia by van der Leeden et al. (1990), Lewis Publishers, Chelsea, Mich. 48118.
- 27 - Boyd, R. F. and Hoerl, B. G. (1977). Basic Medical Microbiology. Little, Brown and Co., Boston Mass. (p. 494).
- 28 - Cheng, Thomas C. (1973) General Parasitology. Academic Press Inc., 111 Fifth Ave., New York, NY 10003. (p. 645).
- 29 - Sterritt, Robert M. (1988). Microbiology for Environmental and Public Health Engineers. Pp. 244-245. E. & F. N. Spon Ltd., New York, NY 10001 USA.
- 30 - Epstein, Elliot (1998). "Pathogenic Health Aspects of Land Application." *Biocycle*, September 1998, p.64. The JG Press, Inc., 419 State Avenue, Emmaus, PA 18049.
- 31 - Shuval, Hillel I. et al. (1981). Appropriate Technology for Water Supply and Sanitation - Night Soil Composting. p.5. International Bank for Reconstruction and Development (World Bank), Washington DC, 20433, USA.
- 32 - Franceys, R. et al. (1992). A Guide to the Development of On-Site Sanitation. World Health Organization, Geneva. p. 212.
- 33 - Schoenfeld, M., and Bennett, M. (1992). Water Quality Analysis of Wolf Creek. (Unpublished manuscript). Slippery Rock University, Applied Ecology Course, PREE, Fall Semester. (Prof. P. Johnson), Slippery Rock, PA 16057
- 34 - Pomeranz, V.E. and Schultz, D., (1972). The Mother's and Father's Medical Encyclopedia. The New American Library, Inc., 1633 Broadway, New York, NY 10019. (p.627).
- 35- Chandler, A.C. and Read, C.P. (1961). Introduction to Parasitology. John Wiley and Sons, Inc.: New York.
- 36 - Brown, H.W. and Neva, F.A. (1983). Basic Clinical Parasitology. Appleton-Century-Crofts/Norwalk, Connecticut 06855. (pp.128-31). Pinworm destruction by composting mentioned in: Gotaas, Harold B., (1956). Composting - Sanitary Disposal and Reclamation of Organic Wastes . p.20. World Health Organization, Monograph Series Number 31. Geneva.
- 37 - Brown, H.W. and Neva, F.A. (1983). Basic Clinical Parasitology. Appleton-Century-Crofts/Norwalk, Connecticut 06855. (pp.119-126).
- 38 - Ibid.
- 39 - Ibid.
- 40 - Haug, Roger T. (1993). The Practical Handbook of Compost Engineering. p. 141. CRC Press, Inc., 2000 Corporate Blvd. N.W., Boca Raton, FL 33431 USA.
- 41 - Shuval, Hillel I. et al. (1981). Appropriate Technology for Water Supply and Sanitation - Night Soil Composting. p.4.

International Bank for Reconstruction and Development (World Bank), Washington DC, 20433, USA.

42 - Franceys, R. et al. (1992). A Guide to the Development of On-Site Sanitation. World Health Organization, Geneva. p. 214.

43 - Shuval, Hillel I. et al. (1981). Appropriate Technology for Water Supply and Sanitation - Night Soil Composting. p.7. International Bank for Reconstruction and Development (World Bank), Washington DC, 20433, USA.

## **REFERENCES - CHAPTER EIGHT - THE TAO OF COMPOST**

1 - LaMotte Chemical Products Co., Chestertown, MD 21620

2 - Rodale, J. I., (1960). The Complete Book of Composting. P. 650, Rodale Books, Emmaus, PA.

3 - Kitto, Dick. (1988). Composting: The Organic Natural Way. Thorsons Publishers Ltd.: Wellingborough, England. (p. 103).

4 - World of Composting Toilets Forum Update No. 3, Monday, November 2, 1998. Reply to: [earthwise@earthwise.nwnet.co.uk](mailto:earthwise@earthwise.nwnet.co.uk).

5 - Del Porto, David, and Steinfeld, Carol (1999). The Composting Toilet System Book - editor's draft. Center for Ecological Pollution Prevention, PO Box 1330, Concord, MA 01742-1330.

6 - Olexa, M. T. and Trudeau, Rebecca L., (1994). *How is the Use of Compost Regulated?* University of Florida, Florida Cooperative Extension Service, Document No. SS-FRE-19, September 1994.

7 - Pennsylvania Solid Waste Management Act, Title 35, Chapter 29A.

8 - Pennsylvania Municipal Waste Planning, Recycling and Waste Reduction Act (1988), Title 53, Chapter 17A.

9 - King, F.H. (1911). Farmers of Forty Centuries. Rodale Press, Inc., Emmaus, PA 18049. (pp.78, 202).

## **REFERENCES - CHAPTER NINE - ALTERNATIVE GREY WATER SYSTEMS**

1 - Waterless Toilets as Repair for Failed Septic Tank Systems. Bio-Sun Systems, Inc., RR #2, Box 134A, Millerton, PA 16936. Ph: 717-537-2200. Email: [Bio-sun@ix.netcom.com](mailto:Bio-sun@ix.netcom.com)

2 - US EPA (1992). Wastewater Treatment/Disposal for Small Communities. P. 42. EPA/625/R-92/005. US EPA Office of Research and Development, Office of Water, Washington DC 20460 USA.

3 - Bennett, Dick (1995). *Graywater, An Option for Household Water Reuse*. Home Energy Magazine, July/August, 1995.

- 4 - Gerba, Charles P. et al. (1995). *Water Quality Study of Graywater Treatment Systems*. Water Resources Bulletin, February, 1995, Vol. 31, No. 1, p. 109. American Water Resources Association.
- 5 - Rose, Joan B. et al. (1991). *Microbial Quality and Persistence of Enteric Pathogens in Graywater from Various Household Sources*. Water Resources, Vol. 25, No. 1, pp. 37-42, 1991.
- 6 - Karpiscak, Martin M. et al. (1990). *Residential Water Conservation: Casa del Agua*. Water Resources Bulletin, December 1990, p. 945-946. American Water Resources Association.
- 7 - Gerba, Charles P. et al. (1995). *Water Quality Study of Graywater Treatment Systems*. Water Resources Bulletin, February, 1995, Vol. 31, No. 1, p. 109. American Water Resources Association.
- 8 - Karpiscak, Martin M. et al. (1990). *Residential Water Conservation: Casa del Agua*. Water Resources Bulletin, December 1990, p. 940. American Water Resources Association.
- 9 - Rose, Joan B. et al. (1991). *Microbial Quality and Persistence of Enteric Pathogens in Graywater from Various Household Sources*. Water Resources, Vol. 25, No. 1, p. 40, 1991.
- 10 - Karpiscak, Martin M. et al. (1990). *Residential Water Conservation: Casa del Agua*. Water Resources Bulletin, December 1990, p. 940. American Water Resources Association.
- 11 - Ludwig, Art (1994). Create an Oasis with Greywater. Oasis Design, 5 San Marcos Trout Club, Santa Barbara, CA 93105-9726. Phone: 805-967-9956.
- 12 - Bennett, Dick (1995). *Graywater, An Option for Household Water Reuse*. Home Energy Magazine, July/August, 1995.
- 13 - Rose, Joan B. et al. (1991). *Microbial Quality and Persistence of Enteric Pathogens in Graywater from Various Household Sources*. Water Resources, Vol. 25, No. 1, p. 40, 1991.
- 14 - Rose, Joan B. et al. (1991). *Microbial Quality and Persistence of Enteric Pathogens in Graywater from Various Household Sources*. Water Resources, Vol. 25, No. 1, pp. 37-38, 1991.
- 15 - Rose, Joan B. et al. (1991). *Microbial Quality and Persistence of Enteric Pathogens in Graywater from Various Household Sources*. Water Resources, Vol. 25, No. 1, pp. 39, 41, 1991.
- 16 - Bastian, Robert K. (date unknown). Needs and Problems in Sewage Treatment and Effluent Disposal Facing Small Communities; The Role of Wetland Treatment Alternatives. US EPA, Office of Municipal Pollution Control, Washington DC 20460.
- 17 - Hoang, Tawni et al. (1998). Greenhouse Wastewater Treatment with Constructed Wetlands. Greenhouse Product News, August 1998, p.33.
- 18 - Golueke, Clarence G. (1977). *Using Plants for Wastewater Treatment*. Compost Science, September/October 1977, p. 18.

- 19 - Berghage, R.D. et al. (date unknown). "Green" Water Treatment for the Green Industries: Opportunities for Biofiltration of Greenhouse and Nursery Irrigation Water and Runoff with Constructed Wetlands. and: Gupta, G.C. (1980). *Use of Water Hyacinths in Wastewater Treatment*. Journal of Environmental Health. 43(2):80-82. and: Joseph, J. (1978). *Hyacinths for Wastewater Treatment*. Reeves Journal. 56(2):34-36.
- 20 - Hillman, W.S. and Culley, D.D. Jr. (1978). *The Uses of Duckweed*. American Scientist, 66:442-451
- 21 - Pries, John (date unknown, but 1996 or later). *Constructed Treatment Wetland Systems in Canada*. Gore and Storrie Ltd., Suite 600, 180 King St. S., Waterloo, Ontario, N2J 1P8. Ph: 519-579-3500.
- 22 - Golueke, Clarence G. (1977). *Using Plants for Wastewater Treatment*. Compost Science, September/October 1977, p. 18.
- 23 - Golueke, Clarence G. (1977). *Using Plants for Wastewater Treatment*. Compost Science, September/October 1977, p. 17.
- 24 - For more information, contact Carl Lindstrom at: <http://www.greywater.com/>

## REFERENCES - CHAPTER TEN - THE END IS NEAR

- 1 - Rybczynski, W. et. al. (1982). Appropriate Technology for Water Supply and Sanitation - Low Cost Technology Options for Sanitation, A State of the Art Review and Annotated Bibliography. World Bank, Geneva. (p. 20).
- 2 - Kugler, R. et al. (1998). *Technological Quality Guarantees for H.Q. Compost from Bio-Waste*. As seen in the 1997 Organic Recovery and Biological Treatment Proceedings, Stentiford, E.I. (ed.). International Conference, Harrogate, United Kingdom. 3-5 September, 1997. P. 31. Available from Stuart Brown, National Compost Development Association, PO Box 4, Grassington, North Yorkshire, BD23 5UR UK ([stuartbrown@compuserve.com](mailto:stuartbrown@compuserve.com)).
- 3 - Vorkamp, Katrin et al. (1998). *Multiresidue Analysis of Pesticides and their Metabolites in Biological Waste*. As seen in the 1997 Organic Recovery and Biological Treatment Proceedings, Stentiford, E.I. (ed.). International Conference, Harrogate, United Kingdom. 3-5 September, 1997. p. 221. Available from Stuart Brown, National Compost Development Association, PO Box 4, Grassington, North Yorkshire, BD23 5UR UK ([stuartbrown@compuserve.com](mailto:stuartbrown@compuserve.com)).
- 4 - Wheeler, Pat (1998). *Results of the Environment Agency Research Programme into Composting of Green and Household Wastes*. As seen in the 1997 Organic Recovery and Biological Treatment Proceedings, Stentiford, E.I. (ed.). International Conference, Harrogate, United Kingdom. 3-5 September, 1997. p. 77. Available from Stuart Brown, National Compost Development Association, PO Box 4, Grassington, North Yorkshire, BD23 5UR UK ([stuartbrown@compuserve.com](mailto:stuartbrown@compuserve.com)).
- 5 - Johnson, Julie. (1990). "Waste That No One Wants." *New Scientist*. 9/8/90, Vol. 127, Issue 1733. (p.50).
- 6 - Benedict, Arthur H. et. al. (1988). "Composting Municipal Sludge: A Technology Evaluation." Appendix A. Noyes Data Corporation.

7 - Biocycle, January 1998, p. 71.

8 - Johnson, Julie. (1990). *Waste That No One Wants*. (p. 53) see above.

9 - Simon, Ruth. (1990). *The Whole Earth Compost Pile?* Forbes. 5/28/90, Vol. 145, Issue 11. p. 136.

10 - Gotaas, Harold B., (1956). Composting - Sanitary Disposal and Reclamation of Organic Wastes. p.101. World Health Organization, Monograph Series Number 31. Geneva.

Source: *The Humanure Handbook*. Jenkins Publishing, PO Box 607, Grove City, PA 16127. To order, phone: 1-800-639-4099.

<http://www.jenkinspublishing.com/>

---

**MENU: [HOME](#) » [Reconstruction](#) » [Recovery](#) » [Renewal](#) » [Survival](#) » [Humanure Content](#)**

---

---

## APPENDIX 3

### State Regulations (US), Compiled in 1999: Composting Toilets, Graywater Systems, and Constructed Wetlands

[AL](#) | [AK](#) | [AZ](#) | [AR](#) | [CA](#) | [CO](#) | [CT](#) | [DE](#) | [FL](#) | [GA](#) | [HI](#) | [ID](#) | [IL](#) | [IN](#) | [IA](#) | [KS](#) | [KY](#) | [LA](#) | [ME](#) | [MA](#) | [MD](#) | [MI](#) | [MN](#) | [MS](#) | [MO](#) | [MT](#) | [NC](#) | [NE](#) | [NV](#) | [NH](#) | [NJ](#) | [NM](#) | [NY](#) | [ND](#) | [OH](#) | [OK](#) | [OR](#) | [PA](#) | [RI](#) | [SC](#) | [SD](#) | [TN](#) | [TX](#) | [UT](#) | [VT](#) | [VA](#) | [WA](#) | [WV](#) | [WI](#) | [WY](#) | [CANADA](#) | [OTHER INFO](#)

**Notes:** 1. Although many states do not have formal design standards or regulations concerning composting toilets, graywater systems, and/or constructed wetlands as they pertain to on-site sewage management for residences, many of the rules and regulations do contain a section allowing “experimental” and/or “alternative” systems which may be permitted by individual application to the regulating agency. Individuals interested in these systems should check with their state agency for more information.

2. When the phrase “no existing regulations,” is used it is not meant to imply that those systems may be used without prior approval from the local or state permitting agency. In all cases, check with your local or state permitting agency to see what their permitting requirements are.

**Alabama:** Alabama Department of Public Health, Division of Community Environmental Protection, RSA Tower, Suite 1250, PO Box 303017, Montgomery, AL 36130-3017; Ph. (334) 206-5373; Contact: John Paul O’Driscoll.

**REGULATION(S):** Chapter 420-3-1: Onsite Sewage Disposal and Subdivision-Onsite Sewage Systems, Water Supplies and Solid Waste Management (23 December 1998). Composting Toilets: As of December 23, 1998, no regulations exist for composting toilets.

Composting toilets are not expressly forbidden, but the homeowner does have to show adequate sewage disposal for graywater. Alabama is working on a set of new regulations, as the current rules have been overcome by time, and are not adequate for many of the situations that the regulated community faces today. The main shortcoming of the current regulations is that they do not adequately address the large systems and alternative technologies that are present today.<sup>1</sup> In the proposed regulations, composting toilets are discussed in Chapter 420-3-1-.59 under Non-Waterborne Systems: Pit Privies, Portable, Composting, and Incinerating Toilets. A composting toilet is defined as a dry closet which combines toilet and urinal waste with optional food waste in an aerobic vented environment. Decomposition of the waste is accomplished by the dehydration and digestion of organic matter, yielding a composted residue which is removed for sanitary disposal.<sup>2</sup> Conditions which justify the use of non-waterborne systems include when soil and site conditions are unsuitable for on-site sewage treatment and disposal systems (OSTDS) or when water under pressure is not available. Composting toilets must meet the standards of the National Sanitation Foundation (NSF), Canadian Standards Association (CSA), Underwriter’s Laboratory, or Warnock Hershey. Other requirements call for continuous ventilation of the components for the storage or treatment of materials. Disposal of the compost must be in accordance with the guidance of EPA Part 503. Disposal of any liquids from the system must be to a sanitary sewer or to an approved OSTDS.

**GRAYWATER:** Ch. 420-3-1-.03. Defined, graywater is that portion of sewage generated by a water-using fixture or appliance, excluding the toilet and possibly the garbage disposal.<sup>3</sup> References to graywater can be found under 402-3-1-.27 Effluent from Clothes Washing Machine and Residential Spa. Water from these systems can circumvent a septic tank and go into a separate effluent disposal field (EDF). In the current regulations, in the absence of water under pressure, graywater shall be disposed of by an effluent distribution line of 50 linear feet per dwelling. Graywater is also covered under the proposed draft of Ch. 420-3-1-.59. No new recommendations besides the EDF system are proposed.

**CONSTRUCTED WETLANDS:** A constructed wetland is defined in the proposed rules as a human-made, engineered, marsh-like area which is designed, constructed, and operated to treat wastewater by attempting to optimize physical, chemical, and biological processes of natural ecosystems.<sup>4</sup> However, there are no existing regulations.

**Alaska:** Alaska Department of Environmental Conservation, Domestic Wastewater Program, 410 West Willoughby Avenue, Suite 105, Juneau, AK 99801; Ph. (907) 465-5324; Fax (907) 465-5362; <http://www.state.ak.us/dec>.

**REGULATION(S):** 18 AAC 72 Wastewater Disposal (1 April 1999).

**COMPOSTING TOILETS:** No existing regulations.

**GRAYWATER:** 18 AAC 72.990. Graywater means wastewater a) from a laundry, kitchen, sink, shower, bath, or other domestic sources; and wastewater b) that does not contain excrement, urine, or combined stormwater. No existing regulations.

**CONSTRUCTED WETLANDS:** No existing regulations.

**Arizona:** Arizona Department of Environmental Quality, 3033 North Central Avenue, Phoenix, AZ 85012-2809; Toll-free Ph. (800) 234-5677; Ph. (602) 207-4335; Fax (602) 207-4872; Contact: Nabil Anouti at (602) 207-4723;

[http://www.sosaz.com/public\\_services/Title\\_18/18-09.htm](http://www.sosaz.com/public_services/Title_18/18-09.htm)

**REGULATION(S):** Arizona Department of Environmental Quality (ADEQ) Bulletin No. 12, Minimum Requirements for the Design and Installation of Septic Tank Systems and Alternative On-site Disposal Systems (June 1989); Arizona Administrative Code Title 18, Ch. 9, Article 7: Regulations for the Reuse of Wastewater (30 September 1998); Arizona Guidance Manual for Constructed Wetlands for Water Quality Improvement (August 1996).

**COMPOSTING TOILETS:** No regulations. Bulletin 12 suggests the use of composting toilets where conditions are such as to make it impossible or impractical to construct either a septic tank disposal or an earth-pit privy.<sup>5</sup> Provided they can be maintained and operated without endangering the public health or creating a nuisance, composting toilets may be permitted.<sup>6</sup>

**GRAYWATER:** Defined under R18-9-701. Graywater means wastewater that originates from clothes washers, dishwashers, bathtubs, showers and sinks, except kitchen sinks and toilets. Under R18-9-703, section C6, graywater from single and multi-family residences may be used for surface irrigation. The design and construction of the system must be approved by the Department. Irrigation sites must be designed to contain a 10-year, 24-hour (i.e., maximum possible) rainfall event and the graywater must fall under the allowable limits of less than 25 colony forming units per 100 milliliters (CFU/ml) fecal coliform and less than 2.0 mg/l chlorine for surface irrigation. Under section 7, formation of a wetlands marsh is allowable reuse of reclaimed wastewater.<sup>7</sup>

**CONSTRUCTED WETLANDS:** Bulletin 12 describes onsite alternatives to septic tank and drainfield disposal systems. The first general requirement of Bulletin No. 12 is that alternative onsite disposal systems are intended and will be approved for individual lots only where conventional septic tank systems are not suitable and cannot be approved.<sup>8</sup> Use of a septic tank with a minimum of two compartments for preliminary solids removal is necessary prior to a constructed wetland. Constructed subsurface flow wetlands are viewed as a beneficial augmenting step in the septic tank system, providing additional treatment between the septic tank and the soil absorption system.<sup>9</sup> The bulletin points out several benefits of segregating blackwater and graywater: 1) conservation of water resources; 2) potential of recycling valuable nutrients to the soil; 3) reuse potential of recycled graywater; and 4) prolonged life of the septic tank soil absorption system.<sup>10</sup> However, until further field data becomes available and is evaluated, graywater treatment and disposal systems shall be designed similarly for typical residential wastewater septic tank soil absorption systems. Under this scenario, it may be possible to reduce the septic tank system capacities, sometimes by one-third.<sup>11</sup>

**Arkansas:** Arkansas Department of Health, Sanitary Division, State Health Building, 4815 West Markham, Little Rock, AR 72201; Ph. (501) 661-2171.

**REGULATION(S):** Alternate Systems Manual published by Environmental Program Services, Division of Environmental Health Protection (April 1993). According to the Alternate Systems Manual, the Arkansas Department of Health encourages studies and submission of plans for alternative methods of treating and disposing of wastes generated by individual residences.<sup>12</sup> However, if site and soil conditions indicate that a standard septic tank and soil absorption system is feasible, no alternative or experimental system will be considered.<sup>13</sup>

**COMPOSTING TOILETS:** are allowed as long as they are NSF approved. In fact, composting toilets are currently being used in state park systems.<sup>14</sup> A composting toilet is defined as a device specifically designed to retain and process body waste, and, in some cases, household garbage, by biological degradation. The process may be thermophilic or mesophilic, depending on the design of the toilet.<sup>15</sup> Some manufacturers claim the stabilized compost is safe and may be used as a soil additive in gardens. The actual health risks associated with this composted material have not been adequately assessed. The stabilized compost from a composting toilet must be buried onsite or deposited in an approved sanitary landfill. All composting devices must be evaluated by an ANSI approved laboratory under NSF Standard 41.<sup>16</sup> Approved composting toilets for the state of Arkansas include Clivus Multrum models 08, 08-0A, 08-A, 202 and 205; and Sun-Mar Biological Composting Toilet and Sun-Mar-XL. Each application requesting approval of a composting toilet must also provide for the disposal of the home's graywater.<sup>17</sup>

**GRAYWATER:** Essentially, graywater is treated the same as blackwater. The preferred method of handling graywater is through a conventional septic tank and absorption field. A 35% reduction in the absorption field size will be granted. Other methods of treating and/or disposing of graywater will be reviewed on a case by case basis.<sup>18</sup>

**CONSTRUCTED WETLANDS (ROCK PLANT FILTERS):** Rock plant filters (RPFs) provide secondary treatment to septic tank effluent. RPFs act as artificial marshes that rely on microorganisms and the roots of aquatic plants to achieve treatment. RPF systems may be considered on sites where low soil permeability prohibits use of a conventional septic system. Discharge from an RPF must be retained on site, which requires a lot size of at least three acres. This requirement may be waived on repairs to existing, failed septic systems. All off-site discharges must be undergo chlorination prior to discharge.<sup>19</sup>

**California:** California Department of Water Resources, Water Conservation Office, 1020 9th Street, Sacramento, CA 95814; Ph. (916) 327-1655; Contact: Ed Craddock. For Composting Toilets and Constructed Wetlands Regulations, Contact: California Department of Health Services, 724 P Street, Room 1350, Sacramento, CA 95814; Ph. (916) 654 0584; Fax (916) 657-2996.

**REGULATION(S):** Appendix G. Graywater Systems. Uniform Plumbing Code, Title 24, Part 5, California Administrative Code (18

March 1997).

**COMPOSTING TOILETS:** No existing regulations, check with your local or county agency. **GRAYWATER:** G-1. General. (b) The type of system shall be determined on the basis of location, soil type, and ground water level and shall be designed to accept all graywater connected to the system from the building. The system shall discharge into subsurface irrigation fields and may include surge tanks and appurtenances, as required by the Administrative Authority. (d) No permit for any graywater system shall be issued until a plot plan with appropriate data satisfactory to the Administrative Authority has been submitted and approved. When there is insufficient lot area or inappropriate soil conditions for adequate absorption of the graywater, as determined by the Administrative Authority, no graywater system shall be permitted. G2. Graywater is untreated wastewater which has not come into contact with toilet waste. Graywater includes used water from bathtubs, showers, bathroom wash basins, clothes washing machines and laundry tubs or an equivalent discharge as approved by the Administrative Authority. It does not include wastewater from kitchen sinks, photo lab sinks, dishwashers, or laundry water from soiled diapers. Surfacing of graywater means the ponding, running off, or other release of graywater from the land surface. G13 Health and Safety. (a) Graywater may contain fecal matter as a result of bathing and/or washing of diapers and undergarments. Water containing fecal matter, if swallowed, can cause illness in a susceptible person. (b) Graywater shall not include laundry water from soiled diapers. (c) Graywater shall not be applied above the land surface or allowed to surface and shall not be discharged directly into or reach any storm sewer system or any water of the United States. (d) Graywater shall not be contacted by humans, except as required to maintain the graywater treatment and distribution system. (e) Graywater shall not be used for vegetable gardens.<sup>20</sup>

**CONSTRUCTED WETLANDS:** No existing regulations.

**Colorado:** Colorado Department of Public Health and Environment, Water Quality Control Division, 4300 Cherry Creek Drive South, Denver, CO 80246-1530; Ph. (303) 692-3500.

**REGULATION(S):** Guidelines on Individual Sewage Disposal Systems, Chapter 25, Article 10 (1994).

**COMPOSTING TOILETS:** Composting toilets, according to the Colorado Department of Health, are defined as unit(s) which consist of a toilet seat and cover over a riser which connects to a compartment or a vault that contains or will receive composting materials sufficient to reduce waste by aerobic decomposition.<sup>21</sup> Composting toilets receive deposits of feces, urine, and readily decomposable household garbage that are not diluted with water or other fluids.<sup>22</sup> These deposits are retained in a compartment in which aerobic composting will occur. The compartment may be located within a dwelling or building, provided that the unit complies with the applicable requirements of these guidelines and provided the installation will not result in conditions considered to be a health hazard as determined by the local health department. The effective volume of the receptacle must be sufficient to accommodate the number of persons served. When the receptacle is filled to 75% capacity, residue from the unit shall be disposed of by acceptable solid waste practices. Composting toilets must be NSF approved.<sup>23</sup>

**GRAYWATER:** Graywater systems collect, treat, and dispose of liquid wastes from sinks, lavatories, tubs, showers, and laundry or other approved plumbing fixtures, excluding toilet fixtures.<sup>24</sup> Graywater systems shall meet at least all minimum design and construction standards for septic tank systems based on the amount and character of wastes for the fixtures and the number of persons served.<sup>25</sup>

**CONSTRUCTED WETLANDS:** are systems which utilize various wetland plants to provide secondary treatment of wastewater through biological, physical, and chemical processes.<sup>26</sup> Constructed wetland systems must be designed by a registered professional engineer. Designs have to be site-specific and must include estimates of effluent quality at the inlet and outlet. Periodic sampling is required at the owner's expense.<sup>27</sup>

**Connecticut:** Connecticut Department of Public Health, 410 Capitol Avenue, MS #51 SEW, PO Box 340308, Hartford, CT 06134-0308; Ph. (860) 509-7296; <http://www.dep.state.ct.us/dph>.

**REGULATION(S):** Connecticut Public Health Code: Regulations and Technical Standards for Subsurface Sewage Disposal Systems, Section 19-13-B100 (Conversions, Changes in Use, Additions) (25 October 1976); Section 19-13-B103 (Discharges 5,000 Gallons Per Day or Less) (16 August 1982); and Technical Standards (Pursuant to Section 19-13-B103) (1 January 1997).

**COMPOSTING TOILETS:** (b)(1) The local director of health may approve the use of a large capacity composting toilet or a heat-assisted composting toilet for replacing an existing privy or a failing subsurface sewage disposal system, or for any single-family residential building where application is made by the owner and occupant, and the lot on which the building will be located is tested by the local director of health and found suitable for a subsurface sewage disposal system meeting all the requirements of Section 19-13-B103d of these regulations. (2) All wastes removed from composting toilets shall be disposed of by burial or other methods approved by the local director of health.<sup>28</sup> 19-13-B103f XI. Non-Discharging Sewage Disposal Systems A. Large capacity composting toilets shall have separate receiving, composting, and storage compartments, arranged so that the contents are moved from one compartment to another without spillage or escape of odors within the dwelling. No large capacity composting toilets shall have an interior volume of less than 64 cubic feet. All toilet waste shall be deposited in the receiving chamber, which shall be furnished with a tight self-closing toilet lid. Food waste or other materials necessary to the composting action shall be deposited in the composting compartment through a separate opening with a tight fitting lid. The final composting material shall be removed from the storage compartment through a cleanout opening fitted with a tight door or lid. The cleanout shall not be located in a food storage or preparation area. The receiving and composting compartments shall be connected to the outside atmosphere by a screened vent. The vent shall be a minimum of six inches in diameter and shall extend at least



20 feet above the openings in the receiving and composting compartments, unless mechanical ventilation is provided. Air inlets shall be connected to the storage compartment only, and shall be screened. B. Heat assigned composting toilets shall have a single compartment furnished with a tight, self-closing toilet lid. The compartment shall be connected to the outside atmosphere by a screened vent. There shall be a mechanical ventilation fan arranged to control the humidity in the compartment and provide positive venting of odors to the outside atmosphere at all times. A heating unit shall be provided to maintain temperature in the optimum range for composting.<sup>29</sup>

**GRAYWATER:** (n) Graywater means domestic sewage containing no fecal material or toilet wastes. Sec. 19-13-B103d. Minimum Requirements. (f) Gray Water Systems. Disposal systems for sinks, tubs, showers, laundries, and other graywater from residential buildings, where no water flush toilet fixtures are connected, shall be constructed with a septic tank and leaching system at least one-half the capacity specified for the required residential sewage disposal system.<sup>30</sup> Sec. 19-13-B103f. Non-discharging Sewage Disposal Systems (a) All non-discharging sewage disposal systems shall be designed, installed, and operated in accordance with the Technical Standards and the requirements of this section, unless an exception is granted by the Commissioner upon a determination that system shall provide for the proper and complete disposal and treatment of toilet wastes or graywater.<sup>31</sup>

**CONSTRUCTED WETLANDS:** No existing regulations.

**Delaware:** Department of Natural Resources and Environmental Control, Division of Water Resources, 89 Kings Highway, Dover, DE 19901; Ph. (302) 739-4761.

**REGULATION(S):** Regulations Governing the Design, Installation and Operation of On-Site Wastewater Treatment and Disposal Systems (4 January 1984).

**COMPOSTING TOILETS, GRAYWATER, CONSTRUCTED WETLANDS:** No existing regulations. However, a substantial portion of Delaware's population lives where centralized water supply or wastewater treatment services are limited. The Department's mission is to aid and assist the public in the installation of on-site sewage disposal systems, where possible, by utilizing the best information, techniques, and soil evaluations for the most suitable system that site and soil conditions permit. In the past, inadequately renovated wastewater has contaminated Delaware's groundwater and presented a threat to the public health, safety, and welfare. Corrective measures required the replacement of water supply and wastewater systems at a very high cost which was sometimes borne by the general public. In developing these Regulations, the Department operated under the philosophy that where soil and site conditions permit, the least complex, easy to maintain, and most economical system should be used. The Department's policy is to encourage development of systems, processes, and techniques which may benefit significant numbers of people in Delaware.<sup>32</sup>

**Florida:** Florida Department of Health, Bureau of Water and On-Site Sewage Programs, 2020 Capital Circle SE, BIN #A08, Tallahassee, FL 32399-1713; Ph. (850) 488-4070; FAX (850) 922-6969; <http://www.doh.state.fl.us/>;

<http://www.dep.state.fl.us/ogc/documents/rules/rulelistpa.htm#wastewater>; Contact: David Hammonds; Email:

[David\\_Hammonds@doh.state.fl.us](mailto:David_Hammonds@doh.state.fl.us)

**REGULATION(S):** 381.0065 Florida Statutes Regulations: Chapter 64E-6, Florida Administrative Code, Standards for Onsite Sewage Treatment and Disposal Systems (3 March 1998).

**COMPOSTING TOILETS:** Although they are not widely used, they are allowed, especially in floodprone areas. Florida encourages the use of composting toilets.<sup>33</sup> 64E-6.009 Alternative Systems. Upon approval by the DOH county health department, alternative systems may, at the applicant's discretion, be used in circumstances where standard subsurface systems are not suitable or where alternative systems are more feasible. Under this section, composting toilets may be approved for use if found in compliance with NSF Standard 41. Graywater and any other liquid and solid waste must be properly collected and disposed of in accordance with Chapter 64E.<sup>34</sup> 64E-6.010 Disposal of Sewage. No receptacle associated with an onsite sewage treatment and disposal system shall be cleaned or have its contents removed until the service person has obtained an annual written permit (form DH4013) from the DOH county health department in the county in which the service company is located.<sup>35</sup>

**GRAYWATER:** as defined under Title XXIX, Public Health Chapter 381.0065 Onsite Sewage treatment and disposal systems, means that part of domestic sewage that is not blackwater, including the waste from the bath, lavatory, laundry, and sink, except kitchen sink waste.<sup>36</sup> Graywater systems are described in Rule 64E-6.013(4).<sup>37</sup> When a separate system is installed to dispose of graywater, the retention tank for such systems shall meet certain design standards as specified in Rule 64E-6.008(3): The minimum effective capacity of the graywater retention tank shall be 250 gallons, with such system receiving not more than 75 gallons of flow per day. Where separate graywater and blackwater systems are used, the size of the blackwater system can be reduced by not more than 25%. 10D-6.046 Location and Installation. (7) Onsite graywater tank and drainfield systems may, at the homeowner's discretion, be utilized in conjunction with an onsite blackwater system where a sewerage system is not available for blackwater disposal.<sup>38</sup> 10D-6.048 System Size Determination (4) A separate laundry waste tank and drainfield system may be utilized for residences and may be required by the county public health unit where building codes allow for separation of discharge pipes of the residence to separate stubouts and where lot sizes and setback allow system construction. (a) The minimum laundry waste trench drainfield absorption area for slightly limited soil shall be 75 square feet for a one or two bedroom residence with an additional 25 square feet for each additional bedroom. 10D-6.055 (k) All graywater tanks distributed by the state shall be approved for use by the department prior to being installed. Such approval shall be obtained only after the manufacturer of a specific model has submitted engineering designs of the tank. (4) Graywater retention tanks - when a separate system is

installed to dispose of graywater, the retention tank for such system shall meet the following minimum design standards: a) the minimum effective capacity shall be as specified in Rule 10D-6.048(3). Liquid depth shall be at least 30 inches; and b) retention tanks shall be baffled and vented as specified in the septic tank construction standards found elsewhere in the section provided that an inlet tee, ell, or baffle shall be provided for graywater tanks.<sup>39</sup>

CONSTRUCTED WETLANDS: No existing regulations.<sup>40</sup>

**Georgia:** Department of Human Resources, Division of Public Health, Environmental Health Section, 5th Floor-Annex, 2 Peachtree Street NW, Atlanta, GA 30303-3186; Ph. (404) 657-2700 or 6538; FAX (404) 657-6533; <http://www.ganet.org/dnr/environ/rules>;

Contact: Warren Abrahams, Program Consultant.

REGULATION(S): Rules of Department of Human Resources, Public Health, Chapter 290-5-26: Onsite Sewage Disposal Management Systems (20 February 1998).

COMPOSTING TOILETS: Where the availability of land for installation of conventional septic tank systems is limited so as to allow for only a septic tank and a reduced size absorption system, composting toilets may be considered. Laundry, bath, and kitchen wastes must be disposed of in a conventional septic tank system, although the size of the absorption field may be reduced by 35% from that of a conventional system, provided water conservation devices are utilized. Composted wastes from the treatment unit shall be removed as per the manufacturer's recommendations and the residue shall be buried by covering with at least six inches of soil. Wastes should not be used as fertilizer for root or leaf crops which may be eaten raw. Composting toilets must be certified by the NSF as meeting the current standard or certified by the manufacturer as meeting a nationally recognized standard for such purpose.<sup>41</sup>

GRAYWATER: Graywater means wastewater generated by water-using fixtures and appliances, excluding water closets, urinals, bidets, kitchen sinks, and garbage disposals. Chapter 290-5-59, Special Onsite Sewage Management Systems, defines sewage as human excreta, all water-carried wastes, and/or liquid household waste including graywater from residences or similar wastes or by-products from commercial and industrial establishments.<sup>42</sup> Where a separate graywater system is to be used, the minimum effective capacity of the graywater retention tank shall be 500 gallons. The minimum absorption area for graywater or blackwater absorption systems serving residential properties shall be based on the number of bedrooms and the percolation rate. The blackwater portion of the total daily sewage flow shall be 35%; the graywater portion shall be 65%.<sup>43</sup>

CONSTRUCTED WETLANDS: No existing regulations. Although no regulations are formally in place, an article in the Georgia Environmentalist gives design information and recommendations for both free water surface (FWS) and subsurface flow (SSF) constructed wetlands.<sup>44</sup>

**Hawaii:** Department Of Health, Wastewater Branch, Environmental Management Division, 919 Ala Moana Boulevard, Suite 309, Honolulu, HI 96814; Ph. (808) 586-4294.

REGULATION(S): Hawaii Administrative Rules, Chapter 11-62 (30 August 1991).

COMPOSTING TOILETS: 11-62-03 Definitions. "Compost toilet" means a non-flush, waterless toilet that employs an aerobic composting process to treat toilet wastes.<sup>45</sup> Ch. 11-62-35 states that specific design requirements for composting (and other) toilets shall be reviewed and approved by the director on a case-by-case basis.<sup>46</sup> Products, if sold in Hawaii, are to be approved by the director, based on appropriate testing procedures and standards as set forth by the National Sanitation Foundation (NSF) Testing Laboratory.<sup>47</sup> The following toilets are approved the NSF Standard 041: Biolet XL; Clivus Multrum Model M-1, M-2, M-12, M-15, M-18, M-22, M-25, M-28, M-32, M-35, M54ADA; Ecotech Carousel; and Sun Mar Excel.

GRAYWATER: means liquid waste from a dwelling or other establishment produced by bathing, washdown, minor laundry, and minor culinary operations, and specifically excluding toilet waste.<sup>48</sup> Chapter 11-62-31.1 states that individual wastewater systems may be used as a temporary on-site means of wastewater disposal in lieu of wastewater treatment works in residential developments when there is 10,000 square feet or more of land area for each individual wastewater system.<sup>49</sup> Section G covers graywater systems and their respective design characteristics.<sup>50</sup> Graywater conveyance systems include: sand filters, absorption trenches and beds, mounds or seepage pits, or when disinfected in accordance with 11-62-26(b) (which governs total coliform levels), used for irrigation.<sup>51</sup> 11-62-31.1 gives the general requirements for proposed individual wastewater systems. (g) A graywater system shall be designed in accordance with the following criteria: (1) design of graywater systems for dwelling units shall be based on a minimum graywater flow of 150 gallons per day per bedroom; and (2) graywater tanks, when required, shall be sized with no less than a 600 gallon capacity and shall conform to the requirements of section 11-62-33-1(a).<sup>52</sup>

CONSTRUCTED WETLANDS: No existing regulations.

**Idaho:** Division of Environmental Quality, 1410 North Hilton, Boise, ID 83706-1255; Ph. (208) 373-0502. Contact: Barry Burnell, Watershed Protection Supervisor.

REGULATION(S): IDAPA 16, Title 01, Chapter 03, Rules for Individual/Subsurface Sewage Disposal Systems (7 May 1993) and the Technical Guidance Manual (TGM) for Individual Subsurface Sewage Disposal Systems. The TGM can be viewed at [http://www.state.id.us/phd1/tgm/tgm\\_toc.htm](http://www.state.id.us/phd1/tgm/tgm_toc.htm) Section 10 of the Idaho code covers Alternative Systems. If a standard system as described in the rules cannot be installed on a parcel of land, an alternative system may be permitted if that system is in accordance with the

recommendations of the Technical Guidance Committee and is approved by the Director.<sup>53</sup>

**COMPOSTING TOILETS:** are defined as toilets within the dwelling that store and treat non-water carried human urine and feces and small amounts of household garbage by bacterial decomposition. The resultant product is compost.<sup>54</sup> Composting toilets are allowed in residences that also have water under pressure, with the understanding that a public sewer or another acceptable method of on-site disposal is available. Permission must be obtained from the Idaho Health Department, as current plumbing code prohibits the use of composting toilets without their permission.<sup>55</sup>

**GRAYWATER:** The Technical Guidance Manual contains a draft for graywater system guidelines and design requirements, but current Idaho rules permit graywater systems only as experimental systems.<sup>56</sup> The draft proposal describes graywater as untreated household wastewater that has not come into contact with toilet waste. Graywater includes used water from bathtubs, showers, bathroom wash basins, and water from clothes washing machines and laundry tubs. It shall not include wastewater from kitchen sinks, dishwashers, or laundry water from soiled diapers. A graywater system consists of a separate plumbing system from the blackwater and kitchen plumbing, a surge tank to temporarily hold large drain flows, a filter to remove particles that could clog the irrigation system, a pump to move the graywater from the surge tank to the irrigation field, and an irrigation system to distribute the graywater. Graywater may not be used to irrigate vegetable gardens. Graywater systems may only be permitted for individual dwellings. The capacity of the septic tank and size of the blackwater drainfield and replacement area shall not be reduced by the existence or proposed installation of a graywater system servicing the dwelling. Graywater shall not be applied on the land surface or be allowed to reach the land surface.<sup>57</sup>

**CONSTRUCTED WETLANDS:** Constructed wetlands are only permitted under experimental systems. All experimental systems require a variance. Experimental systems also are required to be designed by a Idaho licensed professional engineer.<sup>58</sup>

**Illinois:** Illinois Department of Public Health, Division of Environmental Health, 525-535 West Jefferson Street, Springfield, IL 62761-0001; Ph. (217) 782-5830; Contact: Elaine Beard or Doug Ebelherr.

**REGULATION(S):** Title 77: Public Health, Chapter I: Department of Public Health, Subchapter r: Water and Sewage, Part 905: Private Sewage Disposal Code, Section 905.30, Approved Private Sewage Disposal Systems (15 March 1996).

**COMPOSTING TOILETS:** are approved for private sewage disposal of human wastes.<sup>59</sup> Compost toilets shall be designed in accordance with the manufacturer's recommendation to serve the anticipated number of persons. The owner of a compost toilet shall maintain the toilet and dispose of the contents in accordance with Section 905.170, which lists several methods of disposal: 1) discharge to a municipal sanitary sewer system; 2) discharge to sludge lagoons or sludge drying beds; 3) discharge to an incinerator device; or 4) discharge to a sanitary landfill.<sup>60</sup> Compost toilets shall comply with the requirement of the NSF Standard 41 and shall bear the NSF Seal.<sup>61</sup>

**GRAYWATER, CONSTRUCTED WETLANDS:** No existing regulations (governed under experimental systems).

**Indiana:** Indiana Department of Environmental Management, 100 North Senate Avenue, PO Box 6015, Indianapolis, IN 46206-6015; Ph. (317) 233-7179 or (317) 233-7188; Contact: Alan Dunn or Tim Decker; Email: [adunn@ISDH.state.in.us](mailto:adunn@ISDH.state.in.us).

**REGULATION(S):** Regulations, if they existed, would most likely be found under 401 Indiana Administrative Code 6-8.1.

**COMPOSTING TOILETS, GRAYWATER:** No existing regulations.

**CONSTRUCTED WETLANDS:** Constructed wetlands are approved only for experimental use in residential situations. Indiana outlines some basic design criteria for subsurface constructed wetlands, as follows: 1) The wetland is usually designed for five to seven days retention time; 2) Each wetland has one cell for residential projects, with each cell having a length to width ratio of no greater than 2:1; 3) The depth of gravel in the wetland is no greater than 24 inches; 4) There are three different gravel sizes in the wetland. The inlet and outlet ends of the wetland have coarse gravel in the range of 1 1/2 to 3 inches in size. The area between the ends has gravel in the range of 1/2 to 1 inch in size. The surface layer of gravel over the entire wetland is usually six inches in depth with a range of 3/8 to 1/2 inch size (pea gravel). All gravels are screened and washed to remove fines; 5) The water level in the wetland is set at a depth of two to three inches below the surface of the gravel by the outlet adjustable sump pipe. The outlet sump pipe is orificed with a 1 1/2 inch hole to regulate the flow from the wetland after a six inch rainfall event to spread the rainfall accumulation over a 24-hour period; 6) The wetlands are lined with at least a 20 mil liner for residential projects; 7) The wetland is tested for leaks over a 24-hour period with at least six inch depth of water above the inlet and outlet distribution and collection pipe; 8) The inlet distribution and outlet collection pipes for each cell of the wetland are placed at the bottom of the wetland gravel; 9) Some commonly used wetland plants are cattails (*Typha* sp.) and bulrushes (*Scirpus* sp.) along with other appropriate species. The shallower rooted plants are located near the inlet because of the higher influent temperatures and high nutrient levels, with deeper rooted plants located toward the end of the wetland; and 10) There is required monitoring at the inlet and outlet ends of the wetland for three to five years. Absorption field criteria: 1) Selection and sizing of the absorption field is always based upon the peak daily wastewater load and the on-site soil survey report that is done by an ARCPAC certified soil scientist, in the area of the absorption field; 2) There is an allowable reduction in the size of the absorption field associated with a subsurface constructed wetland based on the soil loading rate. For soil loading rates equal to or greater than 0.5 gallons per day (GPD) per square foot, but less than or equal to 1.2 GPD per square foot, the allowable reduction in field size is 50%. For soil loading rates of less than 0.5 GPD per square foot but greater than or equal to 0.25 GPD per square foot, the allowable reduction in the field is 33%; 3) There must be a 50 to 100% set aside area for the proposed absorption field associated with the subsurface constructed wetland because this combination is still considered experimental when there is an allowable absorption field size reduction; and 4) The septic

tanks are sized for either a 36 or 48 hour detention time.<sup>62</sup>

**Iowa:** Iowa Department of Natural Resources, Wallace State Office Building, 502 East 9th Street, Des Moines, IA 50319-0034; Ph. (515) 281-7814; Contact: Brent Parker.

REGULATION(S): Chapter 69: On-Site Wastewater Treatment and Disposal Systems 567-69.11(455B).

COMPOSTING TOILETS, GRAYWATER: No existing regulations. Constructed wetlands: are governed under 69.1(2). "On-site wastewater treatment and disposal system" means all equipment and devices necessary for proper conduction, collection, storage, treatment, and disposal of wastewater from four or fewer dwelling units or other facilities serving the equivalent of 15 persons (1,500 gpd) or less. This includes domestic waste, whether residential or nonresidential, but does not include industrial waste of any flow rate. Included within the scope of this definition are building sewers, septic tanks, subsurface absorption systems, mound systems, sand filters, constructed wetlands and individual mechanical/aerobic wastewater treatment systems. 567---69.11(455B) Constructed wetlands. 69.11(1) Constructed wetlands shall only be used where soil percolation rates at the site exceed 120 minutes per inch. Because of the higher maintenance requirements of constructed wetland systems, preference should be given to sand filters, where conditions allow. b). The effluent from a constructed wetland shall receive additional treatment through the use of intermittent sand filters of a magnitude of half that prescribed in rule 69.9(455B). c) Effluent sampling of constructed wetlands shall be performed twice a year or as directed by the administrative authority. Tests shall be run on all parameters as required in 69.9(1). d). Specifications given in these rules for constructed wetlands are minimal and may not be sufficient for all applications. Technical specifications are changing with experience and research. Other design information beyond the scope of these rules may be necessary to properly design a constructed wetland system. 69.11(2) a). The wetland shall be of a subsurface flow construction with a rock depth of 18 inches and a liquid depth of 12 inches. b). Substrate shall be washed river gravel with a diameter of 3/4 inch to 2½ inches. If crushed quarried stone is used, it must meet the criteria listed in 69.6(4)"a." c). Detention time shall be a minimum of seven days. (1) This may be accomplished with trenches 16 to 18 inches deep (12 inches of liquid), three feet wide with 100 feet of length per bedroom. This may also be done with beds 16 to 18 inches deep, with at least 300 square feet of surface area per bedroom. The bottom of each trench or bed must be level within ±½ inch. (2) Multiple trenches or beds in series should be used. Beds or trenches in series may be stepped down in elevation to fit a hillside application. If the system is on one elevation, it should still be divided into units by earthen berms at about 50 and 75% of the total length. (3) Each subunit shall be connected to the next with an overflow pipe (rigid sewer pipe) that maintains the water level in the first section. Protection from freezing may be necessary. d). Wetlands shall be lined with a synthetic PVC or PE plastic liner 20 to 30 mils thick. e). Effluent shall enter the wetland by a four inch pipe sealed into the liner. With beds, a header pipe shall be installed along the inlet side to distribute the waste. f). Wetland system sites shall be bermed to prevent surface water from entering the trenches or beds. 69.11(3) Vegetation shall be established on the wetlands at time of construction. Twelve inches of rock is placed in each unit, the plants are set, then the final four to six inches of rock is placed. b). Only indigenous plant species shall be used, preferably collected within a 100-mile radius of the site. Multiple species in each system are recommended. Preferred species include, but are not limited to: (1) *Typha latifolia* - Common cattail; (2) *Typha angustifolia* - Narrow leaf cattail; (3) *Scirpus* spp. - Bullrush; (4) *Phragmites communis* - Reed. Transplantation is the recommended method of vegetation establishment. For transplanting, the propagule should be transplanted, at a minimum, on a two-foot grid. The transplants should be fertilized, preferably with a controlled release fertilizer such as Osmocote 18-5-11 for fall and winter planting, 18-6-12 for spring planting, and 19-6-12 for summer planting. Trenches or beds should be filled with fresh water immediately. d). In the late fall, the vegetation shall be mown and the detritus left on the wetland surface as a temperature mulch. In the early spring, the mulch shall be removed and disposed of to allow for adequate bed aeration.<sup>63</sup>

**Kansas:** Department of Health and Environment, Bureau of Water, Nonpoint Source Section, Forbes Field, Building 283, Topeka, KS 66620; Ph. (785) 296-4195 or 1683.

REGULATION(S): No existing regulations. If regulations existed, they should fall under the Kansas Administrative Regulations (KAR) Chapter 25, Article 5, Sewage and Excreta Disposal.

COMPOSTING TOILETS, GRAYWATER, CONSTRUCTED WETLANDS: No existing regulations. Bulletin 4-2, Minimum Standards for Design and Construction of Onsite Wastewater Systems (March 1997) mentions alternative systems when conventional absorption fields or ponds are not suitable.<sup>64</sup> K.A.R. 28-5-9 gives authority to county health departments, in counties that have local codes, to grant variances for alternative onsite wastewater treatment and disposal systems. The variance request is filed with the county administrative agency.<sup>65</sup>

**Kentucky:** Department for Public Health, Division of Public Health Protection and Safety, Environmental Management Branch, Community Environment Section, 275 East Main Street, Frankfort, KY 40621; Ph. (502) 564-4856; FAX (502) 564-6533; Contact: Craig Sheehan, R.S., Health Inspection Program Evaluator; Email: [Craig.sheehan@mail.state.ky.us](mailto:Craig.sheehan@mail.state.ky.us) REGULATION(S): 902 Kentucky Administrative Regulations 10:085 Kentucky Onsite Sewage Disposal Systems (September 1989).

COMPOSTING TOILETS: are mentioned under 1b, 8. System Sizing Standards. When approved permanent non-water carriage water closet type devices (composting toilets, incinerator toilets, oil carriage toilets, etc.) are installed exclusively in any residence and no other blackwater type wastes are created, the daily design flow unit for that specific residence may be reduced.<sup>66</sup>

**GRAYWATER:** in Section 2(13) means wastewater generated by water-using fixtures and appliances, excluding the toilet and the garbage disposal.<sup>67</sup> Graywater standards are mentioned under 13a-c, 8. When improved performance (of a septic system) may be attained by separating laundry graywater waste flows from other residential waste flow for new system installations, or as repair for existing systems, such separation shall be accomplished in the following manner: a) Graywater sewer for the washing machine shall be separated from the main house sewer; b) laundry graywater shall discharge into a lateral bed or trench(es) of a minimum of 100 square feet of bottom surface soil absorption area for a two bedroom residence and an additional 50 square feet for each additional bedroom; c) new system installations where laundry wasteflow separation exists are permitted a 15% reduction in the primary system lateral field requirements shall be allowed only for sites with soils in Soil Groups I-III. On sites with soils in Soil Group IV, such separation may be required, but no system size reduction will be granted.<sup>68</sup>

**CONSTRUCTED WETLANDS:** or plant-rock filters generally consist of a primary treatment unit, usually a septic tank with two compartments or special filters, with a lined rock bed or cell containing approximately 12 inches of rock and a small overflow lateral field. Aquatic plants are planted in the rock media and treat the effluent to a very high degree. Any excess effluent is disposed of in the lateral field. Wetlands are sized based on 1.3 cubic feet of gravel area for each one gallon of total daily waste flow. A typical size for a three bedroom home would be 468 square feet of interior area. Various length to width ratios are acceptable with generally a relatively narrow width to longer length preferable. The system functions primarily by wastewater entering the treatment unit where some treatment occurs. The partially treated wastewater then enters the lined wetlands cell through solid piping where it is distributed across the cell. The plants within the system act to introduce oxygen into the wastewater through their roots. As the wastewater becomes oxygenated, beneficial microorganisms and fungi can thrive, where they in turn digest organic matter. In addition, fairly large amounts of water may be lost through evapotranspiration. Advantages of installing a constructed wetlands system are that they: 1) are space conservative (approximately 1/3 of conventional rock lateral); 2) can be placed on irregular or segmented lots; and 3) may be placed in areas with shallow water tables, high bedrock or restrictive horizons. Disadvantages include that constructed wetlands systems: 1) require a higher level of maintenance than other conventional systems; 2) may be more costly to install; and 3) have an unknown life span.<sup>69</sup>

**Louisiana:** Department of Health and Hospitals, Office of Public Health, Sanitation Services, 106 Canal Blvd., Thibodaux, LA 70301; Ph. (504) 449 5007; Contact: Teda Boudreaux.

**COMPOSTING TOILETS, GRAYWATER SYSTEMS, CONSTRUCTED WETLANDS:** No existing regulations.<sup>70</sup>

**Maine:** Department of Human Services, Bureau of Health, Division of Health Engineering, Wastewater and Plumbing Control Program, State House Station 10, Augusta, ME 04333-0010; Ph. (207) 287-5689.

**REGULATION(S):** Maine Subsurface Waste Water Disposal Rules 144A CMR 241(20 January 1998).

**COMPOSTING TOILETS:** are regulated in Ch. 15, Section 1504.0. A composting toilet is designed to receive, store, and compost human wastes. Stabilized (that is, composted) wastes shall be removed for disposal when the toilet's capacity is reached. The minimum interior volume of a composting toilet shall be large enough to allow complete stabilization of all wastes when the toilet is used continuously at its proposed usage level. Toilet wastes shall be deposited into a receiving area with a self-closing, tightly fitting lid. There shall be a separate access, with a tightly fitting lid, through which food wastes, or other materials needed for the composting process, are routed to the composting compartment. Composted material shall be removed from the storage area through a cleanout opening fitted with a tight door or lid. Non cleanout may be located in a food storage or preparation area. Any liquid overflow shall be discharged to a primitive or conventional disposal field. The contents of an alternative toilet shall be removed and disposed of in a legal and sanitary manner whenever they reach recommended capacity of the alternative toilet.<sup>71</sup>

**GRAYWATER:** 1509.0 Separated Laundry Disposal Systems. The plumbing inspector may approve a separate laundry system for single-family dwelling units. A separated laundry field requires an application for subsurface waste water disposal system completed by a licensed site evaluator and a permit to install the system. Only waste water from a washing machine may be discharged to the separate laundry disposal field designed for that purpose. Separate laundry disposal fields may be designed and used for hot tubs or backwash water. A separated laundry disposal field does not require a septic tank.<sup>72</sup>

**CONSTRUCTED WETLANDS:** No existing regulations.

**Maryland:** Maryland Department of the Environment, Water Management Administration, 2500 Broening Highway, Baltimore, MD 21224; Ph. (410) 631-3778.

**REGULATION(S):** Regulations may be discussed under Chapter 9, Subtitle 14A. Waterless Toilets (1993).

**COMPOSTING TOILETS:** Waterless toilets are covered in Chapter 9, Subtitle 14A-01. Waterless Toilets The Maryland Department of the Environment does not prohibit the use of any NSF approved composting toilet for use anywhere in the State. The Department's current regulation is to allow a 36% design flow reduction for residences when utilizing an NSF approved composting/waterless toilet.<sup>73</sup>

**GRAYWATER:** Innovative graywater designs are currently allowed on a case-by-case basis under the Innovative and Alternative Program.<sup>74</sup>

**CONSTRUCTED WETLANDS:** No existing regulations.

**Massachusetts:** Department of Environmental Protection, Division of Water Pollution Control, One Winter Street, 8th Floor, Boston, MA 02108; Ph. (617) 292-5500; <http://www.magnet.state.ma.us/dep/brp/wwm/wwwhome.htm>; Contact: Doug Roth; Email:

[douglas.roth@state.ma.us](mailto:douglas.roth@state.ma.us) For graywater, contact: Ruth Alfasso, graywater piloting coordinator; Email: [Ruth.Alfasso@state.ma.us](mailto:Ruth.Alfasso@state.ma.us)

REGULATION(S): 310 CMR 15.000, Title 5: Innovative and Alternative Subsurface Sewage Disposal Technologies Approved for Use in Massachusetts (4 March 1998).

COMPOSTING TOILETS: are certified for general use for new construction and for remedial use. Specific regulations concerning composting toilets follow: 1) compost temperature must be maintained above 131 degrees F (55 degrees C); 2) moisture must be maintained between 40-60% for best results; and 3) the system must be designed to store compostable and composted solids for at least two years, either inside the composting chamber or in a separate compost container. Compost must be disposed by one of two methods: 1) by on-site burial, covered with a minimum of six inches of clean compacted earth; or 2) by a licensed septage hauler. If any liquid by-product exists, it should be discharged through a graywater system that includes a septic tank and leaching system or removed by licensed septic hauler.<sup>75</sup>

GRAYWATER: If the facility generates graywater (i.e., wastewater from sinks, showers, washing machines, etc.) a disposal system is still needed for the graywater. Title 5 has different requirements for remedial use and for new construction. Remedial use is for facilities which have a design flow of less than 10,000 gallons per day, are served by an existing system, and where there is no proposed increase in the design flow. An existing cesspool may be used as a leaching pit, provided that the cesspool is pumped and cleaned and is not located in groundwater, and meets the design criteria of 310 CMR 15.253 with respect to effective depth, separation between units, and inspection access. The cesspool may be replaced by a precast concrete leaching pit meeting those requirements, and the effluent loading requirements of Title 5. A septic tank should also be installed. Pertaining to graywater, a filter system specifically approved by the Department can be used instead of a septic tank.<sup>76</sup> Non-traditional graywater systems, such as those which use constructed wetlands or evapotranspiration beds, are approved on a piloting, site-specific basis.<sup>77</sup>

CONSTRUCTED WETLANDS: No existing regulations, approved on a piloting basis only.<sup>78</sup>

**Michigan:** Department of Environmental Quality, Environmental Health Section, Drinking Water and Radiological Protection Division, PO Box 30630, Lansing, MI 48909-8130; Toll-free Ph. (800) 662-9278; Ph. (517) 335-8284.

REGULATION(S): Michigan has one of the oldest existing guidelines for composting toilets and graywater systems. However, as there is no statewide sanitary code, the 46 local health departments define the criteria for onsite sewage disposal and "each county runs its own show."<sup>79</sup> The Michigan Department of Health publishes Guidelines for Acceptable Innovative or Alternative Waste Treatment Systems and Acceptable Alternative Graywater Systems under authority of Act 421, P.A. 1981 (1986). Under Act 421, an owner of a structure using an acceptable an innovative or alternative waste treatment system (heretofore referred to as "alternative systems") in combination with an acceptable alternative graywater system (heretofore referred to as "graywater systems") shall not be required to connect to an available public sanitary sewer system.<sup>80</sup> Alternative system means a decentralized or individual waste system which has been approved for use by a local health department and which is properly operated and maintained so as to not cause a health hazard or nuisance. An acceptable alternative system may include, but is not limited to, an organic waste treatment system or composting toilet which operates on the principle of decomposition of heterogenous organic materials by aerobic and facultative anaerobic organisms and utilizes an effectively aerobic composting process which produces a stabilized humus. Alternative systems do not include septic tank-drainfield systems or any other systems which are determined by the department to pose a similar threat to the public health, safety and welfare, and the quality of surface and subsurface waters of this state.<sup>81</sup> A person may install and use in a structure an alternative system or an alternative system in combination with a graywater system. The installation and use of an alternative system or an alternative system in combination with a graywater system in a structure shall be subject to regulations by the local health department in accordance with the ordinances and regulations of the local units of government in which the structure lies. A local health department may inspect each alternative system within its jurisdiction at least once each year to determine if it being properly operated and maintained. 1) A local health department may charge the owner of an alternative system a reasonable fee for such an inspection and for the plan review and installation inspection. 2) The department shall maintain a record of approved alternative systems and their maintenance and adoption. The department, after consultation with the state plumbing board, shall adopt guidelines to assist local health departments in determining what are graywater systems and what are alternative systems. The department shall advise local health departments regarding the appropriate installation and use of alternative systems and alternative systems in combination with graywater systems. 3) A person who installs and uses an alternative system or an alternative system in combination with a graywater system shall not be exempt from any special assessments levied by a local unit of government for the purpose of financing the construction of an available public sanitary sewer system. 4) An owner of a structure using an alternative in combination with a graywater system shall not be required to connect to an available public sanitary sewer system.<sup>82</sup>

GRAYWATER: system means a system for the treatment and disposal of wastewater which does not receive human body wastes or industrial waste which has been approved for use by a local health department and which is properly operated and maintained so as not to cause a health hazard or nuisance.<sup>83</sup> Structures which utilize alternative systems and graywater systems which are self-contained systems that do not have an on-site discharge should not be required to connect to an available public sanitary sewer system.<sup>84</sup> Alternative systems must meet the requirements of Sections 5 (6) and 21 of the Michigan Construction Code, act 230, Public Acts of 1972 as amended.

Structures using alternative systems must also meet the requirements of the Michigan Plumbing Code.<sup>85</sup> Alternative systems and graywater systems should be tested by the National Sanitation Foundation (NSF) under Standard 41 testing protocol or by an equivalent independent testing agency and procedure. Lacking this testing procedure, the local health department should require performance data prior to approval. When requested, the Michigan Department of Public Health will assist local health departments in evaluating performance data from the NSF and other sources. Each local health department should require appropriate methods for disposal of stored liquid or solid end products from alternative systems.<sup>86</sup> To the extent that funds are available, the department will provide training and technical field assistance to local health departments regarding the appropriate installation and use of alternative systems and graywater systems.<sup>87</sup> A person may petition, in writing, the commission to approve the use of a particular material, product, method of manufacture or method or manner of construction or installation. On receipt of the petition, the commission shall cause to be conducted testing and evaluation it deem desirable. After testing and evaluation, and an open public hearing, the commission may reject the petition in whole or in part, may amend the code in such matter as the commission deems appropriate, or may grant a certificate of acceptability.<sup>88</sup>

**CONSTRUCTED WETLANDS:** The Department of Environmental Quality provides a document entitled Review of Subsurface Flow Constructed Wetlands Literature and Suggested Design and Construction Practices. Constructed wetlands are run through a primary septic tank and then through a subsurface disposal system.<sup>89</sup> In fact, this guide recommends that at least two septic tanks should be provided with a total volume of at least two times the design daily flow.<sup>90</sup>

**Minnesota:** Minnesota Pollution Control Agency, Water Quality Division, Nonpoint Source Compliance Section, 520 Lafayette Road, St. Paul, MN 55155-4194; Ph. (612) 296-7574; <http://www.revisor.leg.state.mn.us/arule/7080>

**REGULATION(S):** Chapter 7080.9010, Alternative and Experimental Systems **[Repealed as of 02/28/00!]**

**COMPOSTING TOILETS:** No regulations,<sup>91</sup> except in Subpart 3G which mentions that other toilet waste treatment devices may be used where reasonable assurance of performance is provided.<sup>92</sup>

**GRAYWATER:** Use of alternative systems is allowed only in areas where a standard system cannot be installed or is not the most suitable treatment. Subpart 3E of Ch. 7080.9010 states that a toilet waste treatment device must be used in conjunction with a graywater system. Accordingly, toilets wastes shall be discharged only to toilet waste treatment devices. Graywater or garbage shall not be discharged to the device, except as specifically recommended by a manufacturer. Septic systems are required for graywater systems. The drainage system in new dwellings or other establishments shall be based on a pipe diameter of two inches to prevent installation of a water flush toilet. There shall be no openings or connections to the drainage system, including floor drains, larger than two inches in diameter. For repair or replacement of an existing system, the existing drainage system may be used. Toilets or urinals of any kind shall not be connected to the drainage system. Toilet waste or garbage shall not be discharged to the drainage system. Garbage grinders shall not be connected to the drainage system. The building sewer shall meet all requirements for part 7080.0120, except that the building sewer for a graywater system shall be no greater than two inches in diameter. Graywater septic tanks shall meet all requirements of 7080.0130, subpart 1, except that the liquid capacity of a graywater septic tank serving a dwelling shall be based on the number of bedrooms existing and anticipated in the dwelling served and shall be at least as large as the following given capacities: 2 bedrooms, 300 gallon capacity; 3 or 4 rooms, 500 gallons; 5 or 6 rooms, 750 gallons; 7, 8 or 9 rooms, 1000 gallons. 4) Sizing for the system can be 60% of the amount calculated for a standard septic system. For ten or more bedrooms or other establishments, the graywater septic tank shall be sized as for any other establishment, except the minimum liquid capacity shall be at least 300 gallons. Graywater aerobic tanks shall meet all requirements of part 7080.0130. 6) Distribution and dosing of graywater shall meet all requirements of parts 7000.0150 and 7080.0160. 7) A standard graywater system shall meet all requirements of part 7080.0170. Experimental systems are discussed in subpart 3a. They may be used in areas where a standard systems cannot be installed or if a system is considered new technology with limited data on reliability.<sup>93</sup>

**CONSTRUCTED WETLANDS:** No existing regulations.

**Mississippi:** Mississippi State Department of Health, PO Box 1700, Jackson, MS 39215-1700; Ph. (601) 576-7689; Contact: Ralph Turnbo.

**REGULATION(S):** Mississippi Individual On-Site Wastewater Disposal System Law, Chapter 41-67 (1996).

**COMPOSTING TOILETS:** 2.3 (28) Non-Waterborne Disposal System - any non-water carried system that treats and/or disposes of human excreta.<sup>94</sup> Non-Waterborne Wastewater Systems are covered under MSDH 300-Section 02A-XIII-01 (revised February 17, 1997). 1. In remote areas of the State or certain transient or temporary locations, the use of non-waterborne systems such as sanitary pit privies, portable toilets, incinerating toilets, composting toilets and related sewage systems may be approved. Due to their limited capacities, these systems are restricted to receive excreta only. Since such systems require regular service and maintenance to prevent their malfunction and overflow, they shall only be used where the local health department approves such use.<sup>95</sup>

**GRAYWATER:** No existing regulations.

**CONSTRUCTED WETLANDS:** Constructed wetlands are discussed in Design Standard VII: Plant Rock Filter System, MSDH 300-Section 021-VII. I. A plant rock filter (constructed wetlands) wastewater treatment system may be utilized as an overland/containment system on sites where soil and site conditions prohibit the installation of a conventional or modified subsurface disposal system. In suitable soils, a plant rock filter may utilize underground absorption to dispose of effluent. It may also be utilized to polish effluent from malfunctioning "seeping" absorption field lines on existing systems. II. The plant rock filter may consist of a single cell, two cells in series

or multiple cells in series. The design will depend on the topography. Differences in individual design, construction materials and construction methods allow each of these types of plant/rock filter to vary widely in their application. Careful consideration should be made during the soil/site evaluation to ensure that the “best choice” is recommended for the particular site. Recommendations developed by the Tennessee Valley Authority’s General Design, Construction, and Operation Guidelines Constructed Wetlands Wastewater Treatment Systems for Small Users Including Individual Residences, Second Edition, have been adopted by reference.<sup>96</sup>

**Missouri:** Missouri Department of Health, Bureau of Community Environmental Health, PO Box 570, Jefferson City, MO 65102-0570; Ph. (573) 751-6095; FAX (573) 526-6946 or 751-0247.

REGULATION(S): Missouri Laws for On-Site Disposal Systems, Chapter 701, Section 701.025 (28 August 1998).

COMPOSTING TOILETS: No existing regulations. May be covered under “Other Systems.” Where unusual conditions exist, special systems of treatment and disposal, other than those specifically mentioned in this rule, may be employed, provided: 1) reasonable assurance of performance of the system is presented to the administrative authority; 2) the engineering design of the system is first approved by the administrative authority; 3) adequate substantiating data indicate that the effluent will not contaminate any drinking water supply, groundwater used for drinking water or any surface water; 4) treatment and disposal of the waste will not deteriorate the public health and general welfare; and 5) discharge of effluent, if any, shall be within setback distances as described in the rules.<sup>97</sup>

GRAYWATER: Under 701.025,12(b), graywater includes bath, lavatory, laundry, and sink waste, excepting human excreta, toilet waste, residential kitchen waste and other similar waste from household or establishment appurtenances.<sup>98</sup> Title 19, Division 20, Chapter 3, General Sanitation, defines graywater as liquid waste, specifically excluding toilet, hazardous, culinary and oily wastes, from a dwelling or other establishment which is produced by bathing, laundry, or discharges from floor drains.<sup>99</sup> There are no design recommendations or regulations governing graywater systems.

CONSTRUCTED WETLANDS: provide secondary levels of treatment, which means that some form of pretreatment (septic tank, aeration tank, lagoon, etc.), must be used prior to the wetland, as wetlands cannot withstand large influxes of suspended solids. The pretreatment used must be capable of removing a large portion of these solids. Effluent from wetlands must be contained on the owner’s property with the same set-back distances as required for lagoons. 1. Free water surface wetlands are shallow beds or channels with a depth less than 24 inches and filled with emergent aquatic plants. This type of wetland shall not be allowed. 2. Submerged flow wetlands are similar to free water surface wetlands except that the channels are filled with shallow depths of rock, gravel or sand. The depth of the porous media is usually less than 18 inches. The porous medium supports the root systems of the emergent aquatic vegetation. The water level is to be maintained below the top of the porous medium so that there is no open water surface. The configuration of a wetland for an individual home can be a one cell or two cells in a series, depending on the soil properties of the site.<sup>100</sup>

**Montana:** Montana Department of Environmental Quality, Lee Metcalf Building, 1520 E. Sixth Avenue, PO Box 200901, Helena, MT 59620-0901; Ph. (406) 444-4633; FAX (406) 444-1374; Contact: Mark M. Peterson, P.E., Environmental Engineering Specialist, Permitting and Compliance Division; Email: mkpeter@mt.gov. REGULATION(S): Circular WQB 5. Minimum Design Standards for On-Site Alternative Sewage Treatment and Disposal Systems (1992).

COMPOSTING TOILETS: Under Chapter 70.1, waste segregation systems consist of dry disposal for human waste such as various chemical and incinerator type systems with separate disposal for graywater. However, regardless of the type of dry disposal system used, the graywater must be disposed of by primary (septic tank) and secondary (subsurface drainfield) treatment.<sup>101</sup> Waste segregation systems will only be considered for recreational type dwellings which receive seasonal use or commercial buildings.<sup>102</sup>

GRAYWATER: No existing regulations. Graywater must be disposed of through a septic tank and drainfield system.

CONSTRUCTED WETLANDS: No existing regulations.

**Nebraska:** Nebraska Department of Environmental Quality, Ground Water Section, PO Box 98922, Lincoln, NE 68509-8922; Ph. (402) 471-2580 or (505) 827-7541;

<http://www.deq.state.ne.us/RuleAndR.nsf/390ed3941b29c12f8625682c006210e9/80857228ae0f5c2786256800005153a8?OpenDocument>;

Contact: Brian Sohall.

REGULATION(S): If they existed, regulations would probably be found in Title 124, Rules and Regulations for Design, Operation and Maintenance of Onsite Wastewater Treatment Systems.

COMPOSTING TOILETS, GRAYWATER, CONSTRUCTED WETLANDS: No existing regulations. Graywater is defined, but no systems are necessarily allowed under Title 124.

**Nevada:** Department of Human Resources, Health Division, Bureau of Health Protection Services, 1179 Fairview Drive, Suite 101, Carson City, NV 89701-5405; Ph. (702) 687-6615 (general number); Ph. (702) 687-4750 (direct line); Contact: Joe Pollack.

REGULATION(S): R129-98. Sewage disposal is regulated under Nevada Administrative Code 444.750 (February 1998).

COMPOSTING TOILETS: Not approved.

GRAYWATER: systems are governed under Regulation R129-98, Section 78. 1. Graywater may be used for underground irrigation if approved by the administrative authority. A homeowner must obtain a permit to construct, alter or install a system that uses graywater for



underground irrigation from the administrative authority before such a system may be constructed, altered or installed. 2. A system that uses graywater for underground irrigation: a) may be used only for a single family dwelling; b) must not be used in soils which have a percolation rate that is greater than 120 minutes per inch; c) must consist of a three-way diversion valve, a holding tank for the graywater and an irrigation system; d) may be equipped with a pump or siphon, or may rely on gravity to cause the water to flow to the irrigation system; e) must not be connected to a system for potable water; and f) must not result in the surfacing of any graywater. 3. A system that uses graywater for underground irrigation, or any part thereof, must not be located on a lot other than the lot which is the site of the single-family dwelling that discharges the graywater to be used in the system. Section 79. 1. An application to construct, alter or install a system that uses graywater for underground irrigation must include: a) detailed plans of the system to be constructed, altered or installed; b) detailed plans of the existing and proposed sewage disposal system; and c) data from percolation tests conducted in accordance with NAC 444.796 and sections 40 to 43, inclusive, of this regulation. 2. A holding tank for graywater must: a) be watertight and constructed of solid, durable materials that are not subject to excessive corrosion or decay; b) have a minimum capacity of 50 gallons; c) have an overflow and an emergency drain. The overflow and emergency drain must not be equipped with a shutoff valve. 3. A three-way diversion valve, emergency drain and overflow must be permanently connected to the building drain or building sewer and must be located upstream from any septic tanks. The required size of an individual sewage disposal system must not be reduced solely because a system that uses graywater for underground irrigation is being used in conjunction with the individual sewage disposal system. 4. The piping for a system that uses graywater for underground irrigation which discharges into the holding tank or is directly connected to the building sewer must be downstream of any vented trap to protect the building from possible sewer gases. 5. The estimated discharge of a system that uses graywater for underground irrigation must be calculated based on the number of bedrooms in the building, as follows: a) for the first bedroom, the estimated discharge of graywater is 80 gallons per day; and b) for each additional bedroom, the estimated discharge of graywater is 40 gallons per day. 6. The absorption area for an irrigation system that includes a system that uses graywater for underground irrigation must be calculated in accordance with the following parameters: percolation rate of 0-20 minutes per inch, 20 square feet (minimum square feet per 100 gallons discharged per day); 21-40 minutes/inch, 40 gallons/day; 41-60 minutes/inch, 60 gallons/day.<sup>103</sup>

CONSTRUCTED WETLANDS: No existing regulations.

**New Hampshire:** Department of Environmental Services, Bureau of Wastewater Treatment, 6 Hazen Drive, Concord, NH 03301; Ph. (603) 271-3711 or 3503; <http://www.state.nh.us/gencourt/ols/rules/env-ws.htm>

REGULATION(S): Chapter Env-Ws 1000 Subdivision and Individual Sewage Disposal System Design Rules. Env-Ws 1022 deals with Alternate Systems.

COMPOSTING TOILETS, GRAYWATER, CONSTRUCTED WETLANDS: No existing regulations. New Hampshire, does, however, have extensive regulations pertaining to Alternate Systems, as follows. Part Env-Ws 1024 Innovative/Alternative Technology. The purpose of this part is to provide the methodology and review process for the approval of innovative/alternative individual sewage disposal systems, in compliance with RSA 485-A:29, I. b. This part shall apply to any proposed individual sewage disposal system technology not described elsewhere in Env-Ws 1000. a. "Conventional system" means an individual sewage disposal system regulated under Env-Ws 1000 other than Env-Ws 1024. b. "Innovative/Alternative waste treatment" as defined in RSA 485-A:2, XXI, includes individual sewage disposal systems. c. "ITA" means innovative/alternative technology approval. Env-Ws 1024.03 a. If the system will require ongoing professional maintenance, a service contract for such maintenance shall be executed before operational approval is granted. b. In exchange for obtaining the benefit of an operational approval based on innovative/alternative technology, the owner shall covenant to replace the innovative/alternative system with a conventional system should the innovative/alternative system fail to operate lawfully. The covenant shall be recorded by the owner at the registry of deeds where the property is located. Env-Ws 1024.04 ITA Applications. a. Before an innovative/alternative waste treatment system may be used the technology shall be evaluated and approved in an ITA. b. To obtain an ITA, an owner, designer, or other person shall submit a letter of application that includes the following: 1). A written description of the proposed system; 2) All operational reports, patent information, technical reports, and laboratory reports published on the proposed system, even if the information might in whole or in part reflect negatively on the system; 3) A description of any advantages of the proposed system over conventional systems in the prevention of health hazards, surface and groundwater pollution, and any other environmental benefits; 4). A description of the possible risks to public health, surface or groundwaters, or other aspects of the environment of using the proposed system; 5). The names, addresses, and phone numbers of at least three individuals who have experience in the design operation of the same type of system; 6). The proposed system's effect on the area of land required for operation; 7). A list of any rules under Env-Ws 1000 for which waivers will be required; and 8). A list of site locations where the system has been used, whether successfully or not.<sup>104</sup>

**New Jersey:** Department of Environmental Protection, Bureau of Nonpoint Pollution Control, PO Box 029, Trenton, NJ 08625-0029; Ph. (609) 292-0404 or 4543; <http://www.state.nj.us/dep/dwq/rules.htm>

REGULATION(S): New Jersey Administrative Code 7:9A Standards for Individual Subsurface Sewage Disposal Systems.

COMPOSTING TOILETS: No existing regulations. GRAYWATER: 7:9A-2.1 "Graywater" means that portion of the sanitary sewage generated within a residential, commercial or institutional facility which does not include discharges from water closets or urinals.<sup>105</sup> 7:9A-1.8 (c) In cases where the actual volume of sanitary sewage discharged from a facility will be reduced by use of water-saving plumbing

fixtures, recycling of renovated wastewater, incineration or composting of wastes, evaporation of sewage effluent or any other process, the requirement for obtaining a treatment works approval and a NJPDES permit shall be based upon the design volume of sanitary sewage, calculated as prescribed in N.J.A.C. 7:9A-7.4, rather than the actual discharge volume as modified by water conservation or special treatment processes. 7:9A-7.3 (a) The system(s) shall be designed to receive all sanitary sewage from the building served except in the following cases: 1. Separate systems may be designed to receive only graywater, or only blackwater, as allowed in N.J.A.C. 7:9A-7.5. 7:9A-7.5 A graywater system may be approved by the administrative authority provided that all of the requirements of these standards are satisfied and provided that an acceptable means for disposal of the blackwater from the building served is indicated in the system design. When the blackwater from the building served by a graywater system is to be disposed of into a waterless toilet, a variance from the Uniform Construction Code, Plumbing sub-code, N.J.A.C. 5:23-3.5, must be obtained by the applicant prior to approval of the graywater system by the administrative authority and the volume of sanitary sewage to be used in the design of the graywater system shall be determined as prescribed in N.J.A.C. 7:9A-7.4. When the blackwater from the building served by a graywater system is to be disposed of into a separate subsurface sewage disposal system, the blackwater system shall meet all the requirements of this chapter and the volume of sanitary sewage used in the design of both the graywater system and the blackwater system shall be a minimum of 75 % of the volume of sanitary sewage determined as prescribed in N.J.A.C. 7:9A-7.4.<sup>106</sup> 7:9A-7.6 Each system approved by the administrative authority pursuant to this chapter shall consist of a septic tank which discharges effluent through a gravity flow, gravity dosing or pressure dosing network to a disposal field as hereafter described. Seepage pits shall not be approved for new installations except in the case of a graywater system as provided by in N.J.A.C. 7:9A-7.5. Installation of a seepage pit may be approved as an alteration for an existing system subject to the requirements of N.J.A.C. 7:9A-3.3.<sup>107</sup>

**CONSTRUCTED WETLANDS:** No existing regulations.<sup>108</sup> 7:9A-3.11 Experimental systems The Department encourages the development and use of new technologies which may improve the treatment of sanitary sewage prior to discharge or allow environmentally safe disposal of sanitary sewage in areas where standard sewage disposal systems might not function adequately. Where the design, location, construction or installation of the system or any of its components does not conform to this chapter, the administrative authority shall direct the applicant to apply to the Department for a treatment works approval. Depending upon the volume and quality of the wastewater discharged, a NJPDES permit may also be required.<sup>109</sup>

**New Mexico:** State of New Mexico Environment Department, 524 Camino De Los Marquez, Suite 4, Santa Fe, NM 87505; Ph. (505) 827-7545 or 7541 (direct number); FAX (505) 827-7545; Contact: R. Brian Schall, Water Resource Specialist/Community Services.  
REGULATION(S): 20 NMAC 7.3, Liquid Waste Disposal Regulations (10 October 1997).

**COMPOSTING TOILETS:** Composting toilets are allowed, although there is no mention of them in the regulations.<sup>110</sup>

**GRAYWATER:** Subpart I, Part 107. AF. "graywater" means water carried waste from kitchen (excluding garbage disposal) and bathroom sinks, wet bar sinks, showers, bathtubs and washing machines. Graywater does not include water carried wastes from kitchen sinks equipped with a garbage disposal, utility sinks, any hazardous materials, or laundry water from the washing of material soiled with human excreta.<sup>111</sup> Revised regulations will have a separate section allowing graywater systems. However, the system will still have to run through a septic tank. Graywater can then be used for subsurface irrigation.<sup>112</sup>

**CONSTRUCTED WETLANDS:** Constructed wetlands are considered an "alternative system."<sup>113</sup> Subpart II deals with alternative systems. The Department may issue a permit, on an individual basis, for the installation of an alternative on-site liquid waste system, including a system employing new and innovative technology, if the permit applicant demonstrates that the proposed system, by itself or in combination with other on-site liquid waste systems, will neither cause a hazard to public health nor degrade a body of water, and that the proposed system will provide a level of treatment at least as effective as that provided by on-site liquid waste systems, except privies and holding tanks, that meet the requirements of this Part and the New Mexico Design Standards.<sup>114</sup>

**New York:** New York State Department of Health, Bureau of Community Sanitation and Food Protection, 2 University Place, Room 404, Albany, NY 12203-3399; Ph. (518) 458-6706; Contact: Ben Pierson.

**REGULATION(S):** Appendix 75-A, Wastewater Treatment Standards - Individual Household Systems, Statutory Authority: Public Health Law 201(1)(1) (1 December 1990).

**COMPOSTING TOILETS:** 75-A. 10 Other Systems. (b) Non-Waterborne Systems. (1) In certain areas of the State where running water is not available or is too scarce to economically support flush toilets, or where there is a need or desire to conserve water, the installation of non-waterborne sewage systems may be considered, however, the treatment of wastewater from sinks, showers, and other facilities must be provided when non-flush toilets are installed. The Individual Residential Wastewater Treatment Systems Design Handbook gives more detail regarding composting toilets.<sup>115</sup> The State Uniform Fire Prevention and Building Code [9NYCRR Subtitle S Sections 900.1(a) and (b)] requires wet plumbing (i.e., potable water plus sewerage) for all new residences. In accordance with Section 900.2(b), minimal required plumbing fixtures may be omitted for owner occupied single family dwellings if approved by the authority having jurisdiction. Health Department approval for said omission(s) shall be fully protective of public health and be in general harmony with the intent of Section 900.1 (i.e., provide satisfactory sanitary facilities). In some areas of the state where available water becomes insufficient to economically use flush toilets (i.e., even those with only 1.6 gallons per flush) or where a need or desire exists to conserve water, use of non-waterborne systems may be justified.<sup>116</sup> **Composters:** These units accept human waste into a chamber where composting of the waste

occurs.<sup>117</sup> Composters accept only toilet wastes and kitchen food scraps coupled with supplemental additions of carbon-rich bulking agents such as planar shavings or coarse sawdust. Household cleaning products should not be placed in the unit. Failure to add adequate bulking agents or maintain aerobic moisture can result in the pile becoming hard (and difficult to remove) or anaerobic. The composted humus contains numerous bacteria and may also contain viruses and cysts. Residual wastes (i.e., the composted humus) should be periodically removed by a professional septage hauler. If a homeowner chooses to personally remove the composted humus, it should be disposed of at a sanitary landfill or buried and well mixed into soil distant from food crops, water supply sources and watercourses. The humus comprises an admixture of recent additions and composted older additions and should be disposed of accordingly. Humus disposal sites shall meet Table 2 separation distances for sanitary privy pits.<sup>118</sup> These units shall be installed in accordance with the manufacturers instructions. The units shall have a label indicating compliance with the requirements of NSF Standard 41 or equivalent. Only units with a warranty of five years or more shall be installed.<sup>119</sup>

**GRAYWATER:** systems shall be designed upon a flow of 75 gpd/bedroom and meet all the criteria previously discussed for treatment of household wastewater.<sup>120</sup> The treatment of household wastewater is regulated by 75-A.8. Subsurface Treatment. (a) General Information. All effluent from septic tanks or aerobic tanks shall be discharged to a subsurface treatment system. Surface discharge of septic tank or aerobic effluent shall not be approved by the Department of Health or a local health department acting as its agent.<sup>121</sup>

**CONSTRUCTED WETLANDS:** There is no official state policy regarding constructed wetlands. It is doubtful that the state or county health departments would approve them.<sup>122</sup>

**North Carolina:** Department of Environmental Health and Natural Resources, Division of Environmental Health, On-Site Wastewater Section, PO Box 27687, Raleigh, NC 27611-7687; Ph. (919) 733-2895 or 7015.

**REGULATION(S):** Sewage Treatment and Disposal Systems, Section .1900 (April 1993).

**COMPOSTING TOILETS:** Section.1934. The rules contained in this Section shall govern the treatment and disposal of domestic type sewage from septic tank systems, privies, incinerating toilets, mechanical toilets, composting toilets, recycling toilets, or other such systems serving single or multiple family residences, places of business, or places of public assembly, the effluent from which is designed not to discharge to the land surface or surface waters. Section.1958 (a) Where an approved privy, an approved septic tank system, or a connection to an approved public or community sewage system is impossible or impractical, this Section shall not prohibit the state or local health department from permitting approved non-ground absorption treatment systems utilizing heat or other approved means for reducing the toilet contents to inert or stabilized residue or to an otherwise harmless condition, rendering such contents noninfectious or noncontaminating. Alternative systems shall be designed to comply with the purposes and intent of this Section. (c) Incinerating, composting, vault privies, and mechanical toilets shall be approved by the state agency or local health department only when all of the sewage will receive adequate treatment and disposal.<sup>123</sup>

**GRAYWATER, CONSTRUCTED WETLANDS:** No existing regulations.<sup>124</sup>

**North Dakota:** North Dakota Department of Health, Environmental Health Section, Division of Municipal Facilities, 1200 Missouri Avenue, Bismarck, ND 58504-5264; Ph. (701) 328-5211 or 5150; FAX (701) 328-5200; Contact: Jeff Hauge, P.E, Environmental Engineer.

**REGULATION(S):** Chapter 62-03-16. Individual Sewage Treatment Systems for Homes and Other Establishments Where Public Sewage Systems are not Available (1996).

**COMPOSTING TOILETS:** 62-03-16-01. Where water under pressure is not available, all human body wastes shall be disposed of by depositing them in approved privies, chemical toilets or such other installations acceptable to the administrative authority.<sup>125</sup>

**GRAYWATER:** 62-03-16-01. 6. Water-carried sewage from bathrooms, kitchens, laundry fixtures, and other household plumbing shall pass through a septic or other approved sedimentation tank prior to its discharge into the soil or into an alternative system. Where underground disposal for treatment is not feasible, consideration will be given to special methods of collection and disposal.<sup>126</sup>

**CONSTRUCTED WETLANDS:** No existing regulations.

**Ohio:** Bureau of Local Services, Ohio Department of Health, 246 North High Street, Columbus, OH 43266-0588; Ph. (614) 466-5190 or 1390; Contact: Tom Grigsby, Program Specialist; Email: [tgrigsby@gw.odh.state.oh.us](mailto:tgrigsby@gw.odh.state.oh.us)

**REGULATION(S):** O.A.C. Chapter 3701-29 Household Sewage Disposal Rules (1977).

**COMPOSTING TOILETS, GRAYWATER, CONSTRUCTED WETLANDS:** No existing regulations. Chapter 3701-29-20. Variance. (C). Household sewage disposal system components or household sewage disposal systems differing in design or principle of operation from those set forth in rules 3701-29-01 to 3701-29-21, may qualify for approval as a special device or system provided, comprehensive tests and investigations show any such component or system produces results equivalent to those obtained by sewage disposal components or systems complying with such regulations. Such approval shall be obtained in writing from the director of health.<sup>127</sup>

**Oklahoma :** Department of Environmental Quality, 1000 Northeast 10th Street, Oklahoma City, OK 73177-1212; Ph. (405) 271-7363 or 702-8100 (Division of Water Quality); Contact: Donnie Johnson.

**REGULATION(S):** Chapter 640. Individual and Small Public Sewage Disposal (1998).

**COMPOSTING TOILETS, GRAYWATER, CONSTRUCTED WETLANDS:** No existing regulations. Chapter 640-1-12 governs alternative/experimental disposal systems. Where unusual conditions exist, special systems of treatment and disposal, other than individual sewage disposal systems mentioned may be employed, provided that: 1) reasonable assurance is presented to the Department that the system will work properly; 2) the design of the system is approved by the Department prior to installation; 3) there is no discharge to the waters of the state; 4) treatment and disposal of waste are in such a manner as to protect public health and the environment; 5) such systems comply with all local codes and ordinances. (b) Special alternative systems or experimental systems shall be considered on a case-by-case basis, weighing heavily in the approval process. The plans for alternative systems shall be reviewed by the Department and approved or disapproved by the Area or Regional Supervisor. After construction, the installation of the alternative system shall be approved or disapproved by the local DEQ representative. (c) To apply for approval of such systems an applicant shall file two copies of test results based on OAC 252:640-1-9 and two copies of the design plan for the proposed system with the local representative of the Department for the area in which the property is located.<sup>128</sup>

**Oregon:** Department of Environmental Quality, Water Quality Division, 811 Southwest 6th Avenue, Portland, OR 97204-1390; Ph. (503) 229-6443; <http://www.cbs.state.or.us/> (click on statute/rules and go to oar 918-770 (division 770)); <http://landru.leg.state.or.us/ors/447.htm>; <http://arcweb.sos.state.or.us/banners/rules.htm>; Contact: Sherman Olson, Terry Swisher: Ph (503) 373-7488.

**REGULATION(S):** Oregon Administrative Rules, Chapter 918, Division 790, Composting Toilet Rules (1998); Oregon Revised Statutes 447.115 (1997); OAR Chapter 340, Division 71 (1997).

**COMPOSTING TOILETS:** As used in ORS 447.118 and 447.124, "compost toilet" means a permanent, sealed, water-impervious toilet receptacle screened from insects, used to receive and store only human wastes, urine and feces, toilet paper and biodegradable garbage, and ventilated to utilize aerobic composting for waste treatment. 447.118 (1) Nothing in ORS 447.010 to 447.160 shall prohibit the installation of a compost toilet for a dwelling by the occupant of the dwelling if the compost toilet complies with the minimum requirements established under this section. (2) Rules adopted under ORS 447.020 shall provide minimum requirements for the design, construction, installation and maintenance of compost toilets. (3) The Director of the Department of Consumer and Business Services with the approval of the State Plumbing Board may require by rule that, in addition to any other requirements provided by law, any manufacturer or distributor of a compost toilet and any person other than the owner of the dwelling in which the compost toilet is to be installed who proposes to install a compost toilet file with the Department of Consumer and Business Services a satisfactory bond, irrevocable letter of credit issued by an insured institution as defined in ORS 706.008 or other security in an amount to be fixed by the department with approval of the board but not to exceed \$5,000, conditioned that such bond, letter of credit or security shall be forfeited in whole or in part to the department for the purpose of carrying out the provisions of ORS 447.124 by failure of such manufacturer, distributor or person to comply with the rules adopted under this section. 447.124 The Department of Consumer and Business Services, with the assistance of the Health Division: (1) May conduct periodic inspections of any compost toilet; (2) Upon making a finding that a compost toilet is in violation of the rules adopted pursuant to ORS 447.118 (2), may issue an order requiring the owner of the dwelling served by the compost toilet to take action necessary to correct the violation; and (3) Upon making a finding that a compost toilet presents or threatens to present a public health hazard creating an emergency requiring immediate action to protect the public health, safety or welfare, may issue an order requiring the owner of the dwelling served by the compost toilet to take any action necessary to remove such hazard or threat thereof. If such owner fails to take the actions required by such order, the department shall take such action, itself or by contract with outside parties, as necessary to remove the hazard or threat thereof.<sup>129</sup> More specific information regarding composting toilets is given under Chapter 918-718-0010. Composting toilets: 1) must be ventilated (electrical or mechanical); 2) shall have at least one cubic yard capacity for a one or two bedroom dwelling; 3) shall be limited to installation in areas where a graywater disposal system can be installed and used; 4) shall be installed in an insulated area to keep a biological balance of the materials therein; and 5) humus from composting toilets may be used around ornamental shrubs, flowers, trees, or fruit trees and shall be buried under at least 12 inches of soil cover. Deposit of humus from any compost toilet around any edible vegetation or vegetable shall be prohibited.<sup>130</sup> Composting toilets must be approved by the NSF Standard 41.<sup>131</sup>

**GRAYWATER:** 447.140 (1) All waste water and sewage from plumbing fixtures shall be discharged into a sewer system or alternate sewage disposal system approved by the Environmental Quality Commission or department of Environmental Quality under ORS chapters 468, 468A and 468B. Graywater is technically defined as sewage and still requires a septic tank and drainfield, although the septic system can be reduced in size.<sup>132</sup> Chapter 340, Divisions 71 and 73: Under the "split-waste method," blackwater sewage and graywater sewage from the same dwelling or building are disposed of by separate systems.<sup>133</sup> 340-71-320. Split Waste Method. In a split waste method, wastes may be disposed of as follows: (1) Black wastes may be disposed of by the use of State Building Codes Division approved non-water carried plumbing units such as recirculating oil flush toilets or compost toilets. (2) Graywater may be disposed of by discharge to: a) an existing on-site system which is not failing; or b) a new on-site system with a soil absorption facility 2/3 normal size. A full size initial disposal area and replacement disposal area of equal size are required; or c) a public sewerage system.<sup>134</sup>

**CONSTRUCTED WETLANDS:** Performance based permits are issued for constructed wetlands. Several systems have been installed in Oregon, but not for single family homes.<sup>135</sup>

**Pennsylvania:** Department of Environmental Protection, Bureau of Water Quality Protection, Division of Wastewater Management, Rachel Carson State Office Building, 11th Floor, 400 Market Street, Harrisburg, PA 17101-2301; Ph. (717) 787-8184.

REGULATION(S): Title 25. Environmental Protection, Chapter 73. Standards for Sewage Disposal Facilities, Current through 28 Pa.B. 348 (17 January 1998).

COMPOSTING TOILETS: under Chapter 73.1 are defined as devices for holding and processing human and organic kitchen waste employing the process of biological degradation through the action of microorganisms to produce a stable, humus-like material.<sup>136</sup> Composting toilets are permitted under Ch. 73.65. Toilets must bear the seal of the NSF indicating testing and approval by that agency under Standard No. 41. (b) The device utilized shall meet the installation specifications of the manufacturer and shall be operated and maintained in a manner that will preclude any potential pollution or health hazards. (c) When the installations of a recycling toilet, incinerating toilet or composting toilets is proposed for a new residence or establishment, an onlot sewage system or other approved method of sewage disposal shall be provided for treatment of washwater or excess liquid from the unit. For existing residences, where no alteration of the on lot system is proposed, a permit is not required to install a composting toilet.<sup>137</sup>

GRAYWATER: 73.11. (c) Liquid wastes, including kitchen and laundry wastes and water softener backwash, shall be discharged to a treatment tank.<sup>138</sup>

CONSTRUCTED WETLANDS: No existing regulations. Ch. 73.71 governs Experimental Sewage Systems, which may be implemented upon submittal of a preliminary design plan. Experimental systems may be considered for individual or community systems in any of the following cases: 1) To solve existing pollution or public health problem; 2) To overcome specific site suitability deficiencies, or as a substitute for systems described in this chapter on suitable lots; 3) To overcome specific engineering problems related to the site or proposed uses; and 4) To evaluate new concepts or technologies applicable to onlot disposal.<sup>139</sup>

**Rhode Island:** Department of Environmental Management, Division of Groundwater and Individual Sewage Disposal Systems, ISDS Section, 291 Promenade Street, Providence, RI 02908-5767; Ph. (401) 277-4700; <http://www.state.ri.us/dem/regs/water/isds9-98.pdf> or [.doc](#)

REGULATION(S): Chapter 12-120-002, Individual Sewage Disposal Systems (September 1998).

COMPOSTING TOILETS: Regulation 12-120-002, amended September 1998, governs composting toilet guidelines. SD 14.00 discusses the acceptability of composting, or humus, toilets, stating that a humus or incinerator type toilet may be approved for any use where a septic tank and leaching system can be installed. The regulation governs two types of composting toilets: 1) large capacity composting toilets; and 2) heat assisted composting toilets. Large capacity toilets must have an interior volume greater than or equal to 64 cubic feet. All waste removed from large capacity composting toilets shall be disposed of by burial or other means approved by the director. Separate subsurface sewage disposal facilities must be provided for disposal of any liquid wastes from sinks, tubs, showers and laundry facilities (SD 14.05).<sup>140</sup>

GRAYWATER: The term, "graywater," shall be held to mean any wastewater discharge from a structure excluding the waste discharges from water closets and waste discharges containing human or animal excrement. The term, "sanitary sewage," shall be held to mean any human or animal excremental liquid or substance, any putrescible animal or vegetable matter and/or any garbage and filth, including, but not limited to, any graywater or blackwater discharged from toilets, laundry tubs, washing machines, sinks, and dishwashers as well as the content of septic tanks, cesspools, or privies.<sup>141</sup>

CONSTRUCTED WETLANDS: No existing regulations. Section SD14.06 governs Innovative or Alternative Technology Approval Procedures (this is an extensive section on the procedures, that are required to install an alternative system).<sup>142</sup>

**South Carolina:** Onsite Wastewater Management Branch, Division of Environmental Health, Department of Health and Environmental Control, 2600 Bull Street, Columbia, SC 29201; Ph. (803) 935-7945; FAX (803) 935-7825; Contact: Richard Hatfield; Email: [HATFIERL@columb72.dhec.state.sc.us](mailto:HATFIERL@columb72.dhec.state.sc.us)

REGULATION(S): Chapter 61-56, Individual Waste Disposal Systems (27 June 1986).

COMPOSTING TOILETS: Composting toilets may be used in conjunction with an approved septic system, for facilities that are provided with water under pressure. If site and soil conditions are not acceptable for an approved septic system, an alternative toilet may be considered, but only if the facility is not connected to water under pressure.

GRAYWATER: No existing regulations. Graywater is included within the Department's definition of sewage and must be managed appropriately. A permit applicant could elect to install separate systems to handle blackwater and graywater, but the same site and soil requirements apply for both systems.

CONSTRUCTED WETLANDS: Constructed wetlands (rock/plant filter) may be installed by an owner, but only in conjunction with an approved pre-treatment system, such as a septic tank, and an approved disposal system, such as a drain field. A limited number of homeowners have elected to use constructed wetlands systems in an effort to mitigate failing conventional systems.<sup>143</sup> Regulation 61-56, Individual Waste Disposal Systems, grants authority to the Department of Health and Environmental Control to adopt standards for alternative onsite treatment and disposal systems. However, no technical standards have been developed for graywater systems, constructed wetlands or composting toilets.

**South Dakota:** Department of Environment and Natural Resources, Air and Surface Water Program, Joe Foss Building, 523 East Capitol, Pierre, SD 57501; Ph. (605) 773-3151; <http://www.state.sd.us/state/legis/lrc/rules/7453.htm>

REGULATION(S): Chapter 74:53:01:10 (1 July 1996).

COMPOSTING TOILETS: Unconventional systems are only to be used when water or electrical systems are unavailable. Vault privies, chemical toilets, incinerator toilets, or composting units shall be used when a water or electrical system is not available. With the exception of vault privies, all unconventional systems are considered experimental systems, and plans and specifications shall be submitted to the secretary for approval as an experimental system prior to installation.<sup>144</sup>

GRAYWATER: Under Chapter 74:03: 01:38, graywater systems are wastewater systems designed to recycle or treat wastes from sinks, lavatories, tubs, showers, washers, or other devices which do not discharge garbage or urinary or fecal wastes. In areas where they will not create a public nuisance or enter any water of the state, graywater systems are exempt from the requirement that normally states that wastewater is not allowed to surface on, around, or enter state waters. 74-03:01:75. A graywater system shall be designed in accordance with the following criteria: 1) All graywater treatment and recycle systems shall be located in accordance of the distances specified in 74:03.01:56, Table 1; 2) Design of graywater systems shall be based on a minimum graywater flow of 25 gallons per day per person. Three days retention time shall be provided for each graywater tank; 3) Graywater tanks are septic tanks and shall conform to the requirements for septic tanks; and 4) Effluent from graywater systems may be recycled for toilet use, conveyed to absorption fields, mounds or seepage pits, or used for irrigation of lawns and areas not intended for food production. Percolation tests shall be conducted and the minimum size of absorption area shall be determined in accordance with 74:03:01:66 to 74:03:01:69, inclusive.<sup>145</sup>

CONSTRUCTED WETLANDS: No existing regulations.

**Tennessee:** Tennessee Department of Environment and Conservation, Division of Ground Water Protection, L & C Tower, 10th Floor, 401 Church Street, Nashville, TN 37243-1540; Ph. (615) 532-0774; Contact: Stephen Morse, Environmental Manager. Regulation(s): Rules of Department of Environment and Conservation, Division of Ground Water Protection, Chapter 1200-1-6: Regulations to Govern Subsurface Sewage Disposal Systems (1997).

COMPOSTING TOILETS: (2) Composting toilets must be certified by the NSF to be in compliance with NSF Standard 41, and be published in their Listing of Certified Wastewater Recycle/Reuse and Water Conservation Devices before they may be used for disposal of human excreta by non-water carriage methods. (c) A pit privy or composting toilet shall not be permitted for a facility where the facility has running water available unless there is an acceptable means to dispose of wastewater.<sup>146</sup>

GRAYWATER, CONSTRUCTED WETLANDS: No existing regulations. However, the Tennessee Valley Authority does publish a set of guidelines for the design and construction of constructed wetlands: Tennessee Valley Authority's General Design, Construction, and Operation Guidelines — Constructed Wetlands Wastewater Treatment Systems for Small Users Including Individual Residences, Second Edition, by Steiner, et al., 1993.

**Texas:** Texas Natural Resource Conservation Commission, PO Box 13087, Austin, TX 78711-3087; Ph. (512) 239-4775; <http://www.tnrcc.state.tx.us/>

REGULATION(S): Chapter 285: On-Site Sewage Facilities (1999).

COMPOSTING TOILETS: 285.2 (13) Composting toilet - A self-contained treatment and disposal facility constructed to decompose non-waterborne human wastes through bacterial action facilitated by aeration. 285.34 Other Requirements (e) Composting toilets will be approved by the executive director provided the system has been tested and certified under NSF Standard 41 <sup>147</sup> 285.2 (27)

GRAYWATER: wastewater from clothes washing machines, showers, bathtubs, handwashing lavatories, and sinks not used for the disposal of hazardous or toxic ingredients or waste from food preparations. Subchapter H: 285.80. Treatment and Disposal of Graywater. New construction or modification to an existing graywater conveyance, treatment, storage or disposal system outside of a structure or building must be carried out in accordance with provisions of this chapter and any established requirements of the permitting authority. Any new construction or modification to an existing graywater reuse or reuse conveyance system associated with a structure or building must be carried out in accordance with the requirements of the State Board of Plumbing Examiners.<sup>148</sup> Graywater must be treated through a septic system first.<sup>149</sup>

CONSTRUCTED WETLANDS: Permitted under 285.32C. Non-standard systems include, but are not limited to, all forms of the activated sludge process, rotating biological contactors, recirculating sand filters, and submerged rock biological filters (a fancy name for constructed wetlands). Non standard systems submitted for review will be analyzed on basic engineering principles and the criteria established in Chapter 285. These systems will be reviewed as one of a kind, site-specific installations. Whether blackwater or graywater, all domestic water-carried discharges have to go through a septic tank first before going through a wetland system. After passing through the wetland system, it must still go through a drainfield.<sup>150</sup>

**Utah:** Department of Environmental Quality, Division of Water Quality, 288 North 1460 West, PO Box 144870, Salt Lake City, UT 84114-4870; Ph. (801) 538-6146; <http://www.eq.state.ut.us/eqwq/wqrules.htm>

REGULATION(S): If they existed, they may be covered under R317-502-3, Individual Wastewater Disposal Systems (1993).

COMPOSTING TOILETS, GRAYWATER, CONSTRUCTED WETLANDS: No existing regulations. R317-502-3. does speak to

alternative systems. The drainage system of each dwelling, building or premises covered herein shall receive all wastewater (including but not limited to bathroom, kitchen, and laundry wastes) as required by the Uniform Plumbing Code and shall have a connection to a public sewer except when such sewer is not available or practicable for use, in which case connection shall be made as follows: 3.1 To an individual wastewater disposal system found to be adequate and constructed in accordance with requirements stated herein. 3.2 To any other type of wastewater disposal system acceptable under R317-1, R317-3, R317-5, or R317-560. R317-502-20. Experimental and Alternate Disposal Methods. 20.1 Where unusual conditions exist, experimental methods of wastewater disposal may be employed provided they are acceptable to the Division and to the local health department having jurisdiction. 20.2 When considering proposals for experimental individual wastewater disposal systems, the Division shall not be restricted by this rule provided that: A. The experimental system proposed is attempting to resolve an existing pollution or public health hazard, or when the experimental system proposal is for new construction, it has been predetermined that an acceptable back-up disposal system will be installed in event of failure of the experiment; B. The proposal for an experimental individual wastewater disposal system must be in the name of and bear the signature of the person who will own the system; and C. The person proposing to utilize an experimental system has the responsibility to maintain, correct, or replace the system in event of failure of the experiment. 20.3 When sufficient, successful experience is established with experimental individual wastewater disposal systems, the Division may designate them as approved alternate individual wastewater disposal systems. Following this approval of alternate individual wastewater disposal systems, the Division will adopt rules governing their use.<sup>151</sup>

**Vermont:** Agency of Natural Resources, Department of Environmental Conservation, Wastewater Management Division, 103 South Main Street, The Sewing Building, Waterbury, VT 05671-0401; Ph. (802) 241-3834; Contact: Bonnie J. Loomer-Hostelter; Email: [bonniel@dec.anr.state.vt.us](mailto:bonniel@dec.anr.state.vt.us)

REGULATION(S): If they existed, they would most likely be found under Environmental Protection Rules, Chapter 1, Small Scale Wastewater Treatment and Disposal Rules (8 August 1996).

COMPOSTING TOILETS, GRAYWATER, CONSTRUCTED WETLANDS: No existing regulations. Innovative systems are regulated under Chapter 1, Small Scale Wastewater Treatment and Disposal Rules. Innovative Systems are governed under subchapter 2, 1-203. Alternative systems are allowed in Vermont only if a back-up, in ground conventional (septic) system is installed.<sup>152</sup> Constructed wetlands as treatment units could be approved if the design was sufficiently reliable given the extended winter season in Vermont. However, for all practical purposes, the discharge from a constructed wetland unit could not be discharged directly into surface waters under these regulations but would have to be discharged to a subsurface leachfield or possibly a sprayfield system.<sup>153</sup>

**Virginia:** State of Virginia, Office of Environmental Health Services, Main Street Station, Suite 117, PO Box 2448, Richmond, VA 23218-2448; Ph. (804) 225-4030; <http://www.vdh.state.va.us/onsite/regulations/sew-vac4.htm>; Contact: Donald Alexander; Email: [dalexander@vdh.state.va.us](mailto:dalexander@vdh.state.va.us)

REGULATION(S): 12 VAC 5-610-980.

COMPOSTING TOILETS: Article 6. 12 VAC 5-610-970. 3. Composting toilets are devices which incorporate an incline plane, baffles, or other suitable devices onto which human excreta is deposited for the purpose of allowing aerobic decomposition of the excreta. The decomposing material is allowed to accumulate to form a humus type material. These units serve as both toilet and disposal devices. Composting toilets are located interior to a dwelling. All materials removed from a composting privy shall be buried. Compost material shall not be placed in vegetable gardens or on the ground surface. All composting toilets must be certified by the National Sanitation Foundation as meeting the current Standard 41.

GRAYWATER: No existing regulations.

CONSTRUCTED WETLANDS: 12VAC5-640-370. Constructed wetlands are considered experimental and will be considered on a case by case basis by the department. All constructed wetland systems shall be designed to meet or exceed 10 mg/l BOD5 and 10 mg/l suspended solids. Experimental systems are exactly that: experimental. Only the results of testing will determine if they will become an approved method of treating wastewater. Some systems can solve site and soil problems that a conventional septic system cannot handle; however, no system can overcome all of the problems on some difficult sites. The Division is looking to find safe, sanitary and economical solutions for every site but some problems still lack a viable solution. In short, not every site "percs" and many, if not all, alternative technologies are more expensive than a conventional gravel system. The Department urges prospective buyers to get an approval letter or construction permit before buying property you wish to build on.<sup>154</sup>

**Washington:** Department of Health, Community Environmental Health Programs LD-11, Building 2, Airdustrial Center, PO Box 47826, Olympia, WA 47826; Ph. (360) 236-4501 or 3011 (Environmental Health Programs direct line); <http://access.wa.gov/government/awlaws.asp>; Contact: Jen Haywood.

REGULATION(S): WAC 246-272; Technical Review Committee, Guidelines for Composting Toilets (1994); Recommended Standards and Guidance for Water Conserving On-Site Wastewater Treatment Systems (1999).

COMPOSTING TOILETS: I. The Technical Review Committee for On-Site Sewage Disposal, established under WAC 246-272-040, has reviewed the available literature on composting toilets. The committee has determined that composting toilets could be an approved

method of sewage treatment if use is consistent with the guidelines herein. Composting toilets are not designed to handle the total wastewater volume generated in the home. The units are usually designed to accommodate fecal and urinary wastes together with small amounts of organic kitchen wastes. The remaining wastewater originating from bathing facilities, sinks and washing machines (graywater) must therefore be collected, treated and disposed of in an approved manner. Because there generally will be additional wastewater to dispose of, composting toilets are restricted.

II. Composting toilets are any device designed to store and compost by aerobic bacterial digestion human urine and feces which are non-water carried, together with the necessary venting, piping, electrical and/or mechanical components.<sup>155</sup> Section A. Waterless Toilets/WLTs. Composting - Unit designed to store and compost (by microbial digestion) human urine and feces. These units are commonly designed to accommodate fecal and urinary wastes together with small amounts of organic material to assist their function. No water is used for transport of urine or feces within these units. They may be small enough to sit on the floor of a bathroom or large enough to require space below the floor to house the storage/composting chamber.<sup>156</sup> The units may be used to replace private privies or chemical toilets, including such applications as highway weigh stations, warehouses, port facilities, construction sites, residences, etc., may be used in dwellings where water supply is not available or provided (example: mountain cabins), or may be used in dwellings where an on-site sewage system is or can be provided for disposal of graywater. Where non-discharging blackwater treatment systems are used, a 50% reduction in septic tank volume and a 40% reduction in the daily hydraulic loading to be used in sizing the grey water disposal mechanism (drainfield, mound system, etc.) are recommended from standard design requirements. The units may be used in facilities where a public sewage system is provided for disposal of graywater.<sup>157</sup> The devices shall be capable of accommodating full or part-time usage without accumulating excess liquids when operated at the design rated capacity. Continuous forced ventilations (e.g., electric fan or wind-driven turbovent) of the storage or treatment chamber must be provided to the outside.<sup>158</sup> Components in which biological activity is intended to occur shall be insulated, heated, or otherwise protected from low temperature conditions, in order to maintain the stored wastes at temperatures conducive to aerobic biological decomposition: 20 to 50 degrees C (68 to 130 degrees F). The device shall be capable of maintaining wastes within a moisture range of 40 to 75%. The device shall be designed to prevent the deposition of inadequately treated wastes near parts used for the removal of stabilized end products. The solid end product (i.e., waste humus) shall be stabilized to meet NSF criteria when ready for removal at the clean out port.

1. Performance Standards. 1.2.1.2. Toilets of proprietary design must be tested according to the NSF International Standard No. 41 (May 1983).<sup>159</sup> The maintenance of carbon-to-nitrogen ratios of approximately 20:1 are recommended. Consequently, additions of vegetable matter, wood chips, sawdust, etc., can be helpful. Removal of composted and liquid materials shall be done in a manner approved with the local health departments and as a minimum, shall comply with Guidelines for Sludge Disposal, Washington Department of Health, 1954. Persons finding it necessary to handle this material shall take adequate protective sanitation measures, and should wash their hands carefully with soap and hot water. Compost shall not be used directly on root crops or on low-growing vegetables, fruits or berries which are used for human consumption; however, this general restriction does not apply if stabilized compost is applied 12 months prior to planting. Where it can be shown that sludge will not come in direct contact with the food products, such as in orchards or where stabilized sludges are further treated for sterilization or pathogen reduction, less restrictive periods may be applicable. Performance monitoring shall be performed on composting toilets permitted under this guideline. Permits should include a statement indicating the permitter's right of entry and/or right to inspect. The frequency of monitoring shall be: 1) Two years after installation; 2) Four years after installation; and 3) in response to a complaint or problem. Non-water carried sewage treatment units are presently acknowledged to be a method of sewage disposal under the Uniform Plumbing Code, but variances to use the devices might be required by local administrative authorities. Variances must therefore be obtained from these departments together with approval of the local health department before the installation can be allowed. The Revised Code of Washington (RCW) 70.118 gives local boards of health the authority to waive applicable sections of local building/plumbing codes when they might prohibit the use of an alternative method for correcting a failure.<sup>160</sup>

**GRAYWATER:** Section B. Graywater systems are virtually the same as combined-wastewater on-site sewage systems. Gravity flow graywater systems consist of a septic tank and subsurface drainfield. Pressurized graywater systems consist of a septic tank, a pump chamber or vault, and a subsurface drainfield. Other types of alternative systems, pre-treatment methods and drainfield design and materials options may also be incorporated in graywater systems. The primary distinction between a graywater system and a combined wastewater system is the lower volume of wastewater. As a result, the size of the septic tank and subsurface drainfield is smaller compared to a system that treats and disposes all the household wastewater (combined) through a septic tank and drainfield. In addition to the water conserving nature of waterless toilets/graywater systems, the graywater system drainfield can be designed and located to reuse graywater for subsurface irrigation. Drainfield designs (methods and materials) which place the distributed wastewater in close proximity to the root zone of turf grasses, plants, shrubs, and trees may be used to enhance the reuse potential of graywater as it is treated in the soil, assuring public health protection. When graywater systems are designed, installed, operated and maintained to maximize their potential as a graywater reuse irrigation system, various items should be considered. Among these are plant water and nutrient needs and limits, salt tolerances, depths of root zones, etc. The development of a landscape plan is recommended. Graywater treatment and disposal/reuse systems must provide treatment and disposal at least equal to that provided by on-site system. Graywater on-site systems may be used with new residential construction and existing dwellings. Internal household plumbing may be modified (consistent with local plumbing code) to route any portion of the household graywater to the graywater on-site sewage system. Graywater on-site sewage systems may be located anywhere conventional or alternative on-site sewage systems are allowed. Site conditions, vertical separation, pretreatment requirements, setbacks and other location requirements are the same as described in Chapter 246-272 WAC. 2.4 Graywater on-sites sewage systems must provide permanent, year-round treatment and disposal of graywater unless this is already provided by an approved



on-site system or connection to public sewer. Graywater on-site systems must be installed with an approved waterless toilet or other means of sewage treatment for blackwater approved by the local health officer. Graywater systems are intended to treat and dispose “residential strength” graywater. Graywater exceeding residential strength must receive pre-treatment to at least residential strength levels. Design requirements for graywater on-site sewage systems, unless otherwise noted, are the same as requirements for combined wastewater systems presented in Chapter WAC 246-272. Graywater may be used for subsurface irrigation of trees (including fruit trees) shrubs, flowers, lawns and other ground covers but must not be used for watering of food crops of vegetable gardens, any type of surface or spray irrigation, to flush toilets/urinals or to wash wall, sidewalks or driveways. The disposal component of a graywater treatment system may be designed to enhance the potential for subsurface irrigation. The efficiency of graywater reuse via subsurface irrigation depends upon the proximity of the drainfield to the root-zone of plants, shrubs, trees or turf and the method of distribution. This may be enhanced by: Installing narrower-than-normal trenches shallow in the soil profile (state rules do not have a minimum trench width; minimum trench depth is six inches). Gravel and pipe size may limit how narrow a “conventional” trench may be. It is recommended that at least two inches of gravel be provided between the sides of the distribution pipe and trench sidewalls. Small gravel size (no less than 3/4 inch) is recommended for narrow trenches; using pressure distribution to reduce the height of the trench cross section to enable shallow trench placement and to assure even distribution; and using subsurface drip irrigation (SDS) technology for shallow system placement and equal distribution in close proximity to plant, shrub, turf and trees roots. Some agronomic issues that should be considered with graywater reuse are the water needs and salt tolerances of plants to be irrigated. In many cases, the volume of graywater generated may not meet the needs of the landscape plantings. If potable water is used to augment graywater for irrigation within the same distribution network, a method of backflow prevention approved by the local health officer is required. In some geographical and climatic areas, the frost-protection needs of an SDS or a conventional drainfield trench system may be counter-productive to effective graywater reuse via subsurface irrigation (distribution piping may be too deep for plant root systems). In these areas, local health officers may permit seasonal systems where year-round treatment and disposal is provided by an approved sewage system and seasonal subsurface irrigation with graywater is provided by a separate system with a shallow drainfield or SDS. Where seasonal systems are allowed, various administrative and design issues must be addressed. Both drainfields must meet state and local rule requirements, including soil application rates, to assure treatment and disposal at least equal to that provided by conventional gravity or pressure on-site sewage systems according to Chapter 246-272 WAC. 3.4.2 Municipal sewer systems may provide year-round sewage disposal in conjunction with seasonal graywater treatment and disposal systems designed to enhance graywater reuse via subsurface irrigation. Seasonal graywater treatment and disposal/reuse systems must include a three-way diverter valve to easily divert graywater to the year-round disposal field or sewer when needed (when freezing is a problem). Local health officers may permit “laundry wastewater only” graywater disposal or reuse systems for single family residences for either year-round or seasonal use. Graywater systems limited only to laundry wastewater (including laundry sinks) may differ from other graywater systems according to the following: A single compartment retention/pump tank, with a minimum liquid capacity of 40 gallons may be used in lieu of the tank recommendations. The tank must be warranted by the manufacturer for use with wastewater and meet requirements listed in Appendix G of the 1997 edition of the Uniform Plumbing Code (UPC). Minimum design flow for “laundry wastewater only” systems (for the purpose of drainfield sizing) must be based on the number of bedrooms in the residence and must be no less than 30% of the minimum graywater system design flows. A wastewater filter or screen (with a maximum size opening of 1/16 inch) must be provided in an accessible location conducive to routine maintenance. Homeowners are responsible for proper operation and maintenance of their graywater systems. Specific requirements will vary according to the county where the system is located and the specific type of system. See your local health jurisdiction for local system O & M requirements.<sup>161</sup>

CONSTRUCTED WETLANDS: No existing regulations.

**West Virginia:** Secretary of State, Administrative Law Division, State Capitol, 1900 Kanawha Boulevard East, Building 1, Suite 157K, Charleston, WV 25305-0770; Ph. (304) 558-6000; FAX (304) 558-0900; <http://www.state.wv.us/sos>; Email: [WVSOS@Secretary.State.WV.US](mailto:WVSOS@Secretary.State.WV.US); Contact: Leah Powell.

REGULATION(S): Title 64, Interpretive Rules Board of Health, Series 47, Sewage Treatment and Collection System Design Standards (1983).

COMPOSTING TOILETS: Interpretive Rule 16-1, Series VII, 10.1. Composting toilets may be utilized only in conjunction with an approved graywater treatment and disposal system. 10.2 The design and construction of a composting toilet must meet the requirements of NSF Standard 41.

GRAYWATER: 12.1 Those houses served by a graywater disposal system must have a house sewer of not more than two inches in diameter. 12.2. Houses served by graywater disposal systems shall not have garbage disposal units. 12.3 Manufactured graywater disposal systems must be approved by the director. 12.4. Non-commercial graywater disposal systems shall consist of the following: 12.4.1. A soil absorption field designed on the basis of a 30% reduction in water usage, and constructed in accordance with the design requirements for the standard soil absorption fields. 12.4.2. A septic tank sized according to the following room sizes and minimum capacities: 2 rooms, 500 gallons; 3 to 4 rooms, 750 gallons; 5 or more rooms, add 210 gallons for each additional bedroom.<sup>162</sup>

CONSTRUCTED WETLANDS: No existing regulations.

**Wisconsin:** Department of Commerce, Bureau of Program Management, 715 Post Road, Stevens Point, WI 54481-6456; Ph. (715) 345-

5334; FAX (715) 345-5269; <http://www.commerce.state.wi.us/sb-comm83revisionsandarticles.htm>;  
<http://www.legis.state.wi.us/rsb/code/comm/comm083.pdf>; Contact: Jim Klass, Ph. (608) 266-9292 (Water Regulation).

REGULATION(S): If they existed, they may be found in Wisconsin Comm083.

COMPOSTING TOILETS, GRAYWATER SYSTEMS, CONSTRUCTED WETLANDS: No existing regulations.

**Wyoming:** Department of Environmental Quality, Water Quality Division, Herschler Building, 122 West 25th Street, Cheyenne, WY 82002; Ph. (307) 777-7075; <http://deq.state.wy.us/wqd/w&wwpage.htm>; Contact: Larry Robinson; <mailto:lharmo@missc.state.wy.us>

REGULATION(S): If they existed, regulations would most likely be found in Chapter XI, Part D, Septic Tank and/or Soil Absorption System, Water Quality Rules and Regulations in the Innovative and Alternative section.

COMPOSTING TOILETS, GRAYWATER SYSTEMS, CONSTRUCTED WETLANDS: No existing regulations.

**Canada:** Systems would be governed by the provincial Ministries of Health (municipal affairs and health, similar to our county government in the US). Check your local agency.

**Other information sources:** National Small Flows Clearinghouse: West Virginia University, PO Box 6064, Morgantown, WV 26506-6064; Ph. (304) 294-4191; 1-800-624-8301; National Sanitation Foundation: NSF Standard 41: Nonliquid Saturated Treatment Systems: <http://www.nsf.org/>

### ENDNOTES (Appendix 3)

1. Memorandum from James M. Coles, Deputy Director. Division of Community Environmental Protection, State of Alabama Department of Public Health. 7 December 1998.
2. Alabama State Board of Health. 7 December 1998. Rules of State Board of Health Bureau of Environmental Services Division of Community Environmental Protection. Chapter 420-3-1, Onsite Sewage Disposal. Draft. p. 126.
3. Alabama State Board of Health, Bureau of Environmental Services, Division of Community Environmental Protection. 23 December 1998. Rules of State Board of Health Bureau of Environmental Services Division of Community Environmental Protection. Chapter 420-3-1, Onsite Sewage Disposal and Subdivision-Onsite Sewage Systems, Water Supplies and Solid Waste Management. p. 6.
4. Alabama State Board of Health. 7 December 1998. Rules of State Board of Health Bureau of Environmental Services Division of Community Environmental Protection. Chapter 420-3-1, Onsite Sewage Disposal. Draft. p. 126.
5. Arizona Department of Environmental Quality (ADEQ). Bulletin No. 12: Minimum Requirements for the Design and Installation of Septic Tank Systems and Alternative On-site Disposal Systems. June 1989. p. 65.
6. Ibid. p. 65-66.
7. Arizona Administrative Code. Department of Environmental Quality, Water Pollution Control. Article 7. Regulations for the Reuse of Wastewater. p. 14, 15, 17.
8. Knight, R. L, Randall, R. and M. Girts. May 1995. Arizona Guidance Manual for Constructed Wetlands for Water Quality Improvement. Arizona Department of Environmental Quality. p. 8-14.
9. Arizona Department of Environmental Quality. June 1989. Engineering Bulletin No. 12: Minimum Requirements for the Design and Installation of Septic Tank Systems and Alternative On-Site Disposal Systems. p.64.
10. Ibid.
11. Ibid. p. 65.
12. Environmental Program Services, Division of Environmental Health Protection. April 1993. Alternate Systems Manual. Arkansas Department of Health. p. 1.
13. Ibid.
14. Ibid. p. 18.

15. Carl J. Graves, R.S., Sanitarian, Arkansas Department of Health. Personal communication. 25 February 1999. 12. Environmental Program Services, Division of Environmental Health Protection. April 1993. Alternate Systems Manual. Arkansas Department of Health. p. 18.
16. Ibid. p. 18.
17. Ibid.
18. Ibid. p. 13-16
19. Ibid. p. 13-16
20. State of California. Building Standards Commission. 28 September 1997. Appendix G. Graywater Systems. Uniform Plumbing Code (UPC). Title 24, Part 5, California Administrative Code. p. 79-85.
21. Colorado Department of Health. 1994. Guidelines on Individual Sewage Disposal Systems. p. 6.
22. Colorado Department of Health. 1994. Guidelines on Individual Sewage Disposal Systems. p. 46.
23. Ibid. p. 47.
24. Ibid. p. 7.
25. Ibid. p. 44.
26. Ibid. p. 6.
27. Ibid. p. 43.
28. Connecticut Public Health Code. Regulations and Technical Standards for Subsurface Sewage Disposal Systems. Section 19-13-B100, Section 19-13-B103, Technical Standards, Section 19-13-B104. January 1997. p. 12.
29. Ibid. p. 42-43.
30. Ibid. p. 7.
31. Ibid. p. 12.
32. State of Delaware, Department of Natural Resources and Environmental Control. 31 January 1995. Regulations Governing the Design, Installation and Operation of On-Site Wastewater Treatment and Disposal Systems. Forward.
33. David Hammonds, Florida Bureau of Water and Onsite Sewage Programs. Personal conversation. 25 February 1999.
34. State of Florida, Department of Health. 3 March 1998. Chapter 64E-6, Florida Administrative Code, Standards for On-Site Sewage Treatment and Disposal Systems. p. 20.
35. Ibid. p. 22.
36. [http://www.leg.state.fl.us/citizen/documents/statutes/1998/ch0381/sec0065\\_.htm](http://www.leg.state.fl.us/citizen/documents/statutes/1998/ch0381/sec0065_.htm) 5 April 1999. p. 1.
37. State of Florida, Department of Health. 3 March 1998. Chapter 64E-6, Florida Administrative Code, Standards for On-Site Sewage Treatment and Disposal Systems. p. 31.
38. Florida Administrative Code. 13 February 1997. Standards for On-Site Sewage Treatment and Disposal Systems, Chapter 10D-6.
39. National Small Flows Clearinghouse. 1997. Graywater Systems from the State Regulations. WWBLRG24. p. 19, 20, 23-24.
40. David Hammonds, Florida Bureau of Water and Onsite Sewage Programs. Personal conversation. 25 February 1999.

41. State of Georgia. 20 February 1998. Chapter 290-5-59. Special Onsite Sewage Management Systems. p. D-18.
42. State of Georgia. 20 February 1998 Chapter 290-5-59. Special Onsite Sewage Management Systems. p. 2.
43. Ibid. p. D-19.
44. Corbitt, Bill. 16 July 1997. Aquatic Sewage Treatment Systems in Georgia, Past and Present. Georgia Environmentalist. Georgia Environmental Health Association. p. 8-14.
45. Hawaii Department of Health. 30 August 1991. Amendment and Compilation of Chapter 11-62. p. 62-4.
46. Ibid. p. 62-5.
47. Ibid. p. 62-24.
48. Ibid. p. 62-26.
49. Ibid. p. 62-23.
50. National Small Flows Clearinghouse. 1997. Graywater Systems from the State Regulations. WWBLRG24. p. 25.
51. Hawaii Department of Health. 30 August 1991. Amendment and Compilation of Chapter 11-62. p. 62-23.
52. Ibid. p. 62-26.
53. State of Idaho. 993. IDAPA 16. Title 01, Chapter 03. Rules for Individual/Subsurface Sewage Disposal Systems. p. 16-8.
54. Idaho Division of Environmental Quality. 8 January 1999. Technical Guidance Manual for Individual Subsurface Sewage Disposal Systems. p. 33.
55. Barry Burnell, Idaho Division of Environmental Quality. Personal communication. 8 January 1999.
56. Ibid.
57. Idaho Division of Environmental Quality. 25 October 1996. Technical Guidance Manual for Individual Subsurface Sewage Disposal Systems. p. 1-4.
58. Barry Burnell, Idaho Division of Environmental Quality. Personal communication. 8 January 1999.
59. Illinois Department of Public Health. 1996. Private Sewage Disposal Licensing Act and Code. p. 54.
60. Ibid. p. 63.
61. Ibid. p. 56.
62. Tim Decker, Indiana State Department of Health. Personal communication. 30 April 1999.
63. Iowa Chapter 69: On-Site Wastewater Treatment and Disposal Systems. 567--69.11(455B) Constructed wetlands section.
64. Kansas Administrative Regulations. 1 January 1973. Chapter 25-5-9. Variance. p. 126.
65. State of Kansas Department of Health and Environment. March 1997. Bulletin 4-2: Minimum Standards for Design and Construction of Onsite Wastewater Systems. p. 1.
66. Kentucky Cabinet for Human Resources. September 1989. On-Site Sewage Disposal Systems Regulations. 902 KAR 10:081 and 902 KAR 10:085. p. 25.
67. Ibid. p. 58-59.
68. Ibid. p. 48.

69. Department for Public Health. August 1997. Kentucky Public Health Homeowner's Manual. Onsite Sewage Disposal Systems. p. 29
70. Teda Boudreaux. Louisiana Department of Health. Personal communication 3 May 1999.
71. Department of Human Services. 20 January 1998. Maine Subsurface Waste Water Disposal Rules. 144A CMR 214. p. 15-1, 15-2.
72. Ibid. p. 15-3.
73. Jay Prager, Acting Chief, Division of Residential Sanitation, Maryland Department of the Environment. 26 October 1990. Innovative/Alternative Section. Memorandum: Guidance on Waterless Toilet Systems. p. 1.
74. Ibid. p. 2.
75. Commonwealth of Massachusetts. Executive Office of Environmental Affairs. Department of Environmental Protection. 4 March 1998. 310 CMR 15.000: Title 5: Innovative and Alternative Subsurface Sewage Disposal Technologies Approved for Use in Massachusetts. p.1,9. Commonwealth of Massachusetts. Executive Office of Environmental Affairs. Department of Environmental Protection. 16 April 1998. The Use of Composting Toilets in Massachusetts. p. 1-4.
76. Ibid. p. 4.
77. Ruth Alfasso, Graywater Piloting Coordinator, Massachusetts DEP. Personal communication. 6 January 1999.
78. Ibid.
79. Rick Fallardeau, Michigan Department of Environmental Quality. Personal communication. April 1999.
80. Michigan Department of Public Health. July 1986. Guidelines for Acceptable Innovative or Alternative Waste Treatment Systems and Acceptable Graywater Systems. p. 1.
81. Ibid. Attachment A. Act No. 421. Public Acts of 1980. Approved by Governor. 13 January 1981. p. 1.
82. Ibid. p. 2.
83. Michigan Department of Public Health. July 1986. Guidelines for Acceptable Innovative or Alternative Waste Treatment Systems and Acceptable Graywater Systems. p. 2.
84. Ibid. p. 2.
85. Ibid. p. 3.
86. Ibid. p. 3.
87. Ibid. p. 3.
88. Ibid Attachment C. Act 230, Public Acts of 1972, as amended Michigan Construction Code. p. 1.
89. Rick Fallardeau, Michigan Department of Environmental Quality. Personal communication. April 1999.
90. McGeachy, Ben. date unknown. A Review of Subsurface Flow Constructed Wetlands Literature and Suggested Design and Construction Practices. Michigan Department of Environmental Quality.
91. Roberta Wirth, Minnesota Department of Natural Resources. Personal communication. 14 January 1999.
92. Minnesota Rules. 3 November 1998.. Chapter 7080.0910. Alternative and Experimental Systems.
93. Ibid. Section E1-E7.
94. Mississippi Individual On-Site Wastewater Disposal System Law. 1996. Chapter 41-67. MSDH 300-Section 02A-03.

95. Ibid. MSDH 300-Section 02A-XIII-01.
96. Ibid. MSDH 300-Section 02A-VII-01.
97. Missouri Department of Health. 1995. Missouri Laws Accompanied by Department of Health Rules Governing On-site Sewage Systems. Missouri Laws for On-Site Disposal Systems. p. 1.
98. Missouri Department of Health. 1995 Missouri Laws Accompanied by Department of Health Rules Governing On-site Sewage Systems. Title 19- Department of Health, Division 20-Environmental Health & Epidemiology, Chapter 3- General Sanitation. p. 37.
99. Ibid. p. 9.
100. Ibid. p. 34.
101. Montana Department of Health and Environmental Sciences. Circular WQB 5. Minimum Design Standards for On-Site Alternative Sewage Treatment and Disposal Systems. p. 4.
102. Ibid. p. 5
103. Nevada Adopted Regulation R 129-98. February 1998. p. 59-61.
104. <http://www.state.nh.us/gencourt/ols/rules/env-ws.htm>
105. <http://www.state.nj.us/dep/dwq/rules.htm> p. 11.
106. Ibid. p. 6-7.
107. Ibid. p. 65, 68-69.
108. Ibid. p. 6.
109. Ibid. p. 25.
110. Brian Schall, New Mexico Environment Department. Personal communication. 1999.
111. Ibid.
112. Ibid.
113. New Mexico Environmental Improvement Board. October 1997. Liquid Waste Disposal Regulations. p. 6.
114. New Mexico Environmental Improvement Board. October 1997. Liquid Waste Disposal Regulations. p 38.
115. New York State Department of Health. 1996. Individual Residential Wastewater Treatment Systems Design Handbook.
116. Ibid. p. 56.
117. Ibid.
118. Ibid. p. 56-57.
119. State of New York. 1 December 1990. Appendix 75-A. Wastewater Treatment Standards - Individual Household Systems. Statutory Authority,; Public Health Law, 201(1)(1), New York. p. 31.
120. Ibid.
121. Ibid. p. 14.

122. Ben Pierson, New York State Department of Health. Personal communication. 6 April 1999.
123. National Small Flows Clearinghouse. September 1997. Alternative Toilets from the State Regulations. WWBKRG23. p. 53-54.
124. Joni Cardin, North Carolina Division of Water Quality. Personal communication. 7 January 1999.
125. State of North Dakota. 1996. Chapter 62-03-16. Individual Sewage Treatment Systems for Homes and Other Establishments Where Public Sewage Systems are not Available. p. 249.
126. Ibid.
127. Ohio Department of Health. 1 July 1977. Chapter 3701-29-01 to 3701-29-21. Household Sewage Disposal Rules. p. 21.
128. Oklahoma Chapter 640, Individual and Small Public Sewage Disposal. 1998. p. 12-13.
129. Oregon Chapter 447.115. 1997. <http://landru.leg.state.or.us/ors/447.htm> 21 January 1999.
130. Oregon Chapter 918-790-0010. 1998. [http://arcweb.sos.state.or.us/rules/OARS\\_900/OAR\\_918/918\\_770.htm](http://arcweb.sos.state.or.us/rules/OARS_900/OAR_918/918_770.htm)
131. Oregon Chapter 918-770-0050. 1998. Plumbing Product Approval. [http://arcweb.sos.state.or.us/rules/OARS\\_900/OAR\\_918/918\\_770.htm](http://arcweb.sos.state.or.us/rules/OARS_900/OAR_918/918_770.htm)
132. Oregon Chapter 447.115. 1997. <http://landru.leg.state.or.us/ors/447.htm> 21 January 1999.
133. National Small Flows Clearinghouse. September 1997. Greywater Systems from the State Regulations. p. 36.
134. Ibid. p. 37.
135. Terry Swisher, Oregon Chief Plumbing Inspector. Personal communication. 14 January 1999.
136. Commonwealth of Pennsylvania. 17 January 1998. Pennsylvania Code. Title 25. Environmental Protection. p. 73-6.
137. Ibid. p. 73-47 - 73-48.
138. Ibid. p. 73-10.
139. Ibid. p. 73-48 to 73-49.
140. Rhode Island. September 1998. Chapter 12-120-002, Individual Sewage Disposal Systems. p. 40-42.
141. Ibid.
142. Ibid. p. 43-46.
143. Richard Hatfield, South Carolina Onsite Wastewater Management Branch. Personal communication. 7 January 1999.
144. <http://landru.leg.state.or.us/ors/447.htm> 7 January 1999.
145. National Small Flows Clearinghouse. September 1997. Greywater Systems from the State Regulations. p. 39-41.
146. Tennessee Rules of Department of Environment and Conservation, Division of Ground Water Protection. 1997. Chapter 1200-1-6: Regulations to Govern Subsurface Sewage Disposal Systems. p. 59.
147. Texas Natural Resource Conservation Commission. 8 January 1999. Chapter 285, On-Site Sewage Facilities. p. 2, 19.
148. Ibid. p. 1, 3.
149. Ken Graber, Texas Natural Resource Conservation Commission. Personal communication. 4 April 1999.

150. Ibid.
151. <http://www.eq.state.ut.us/eqwq/wqrules.htm> 6 January 1999.
152. Bonnie Loomer-Hostetler, Information Services Chief of the Vermont Wastewater Management Division. Personal communication. 7 January 1999.
153. John Akielaszek, Vermont Department of Environmental Conservation. Personal communication. 12 January 1999.
154. <http://www.vdh.state.va.us/onsite/text/appr-sys.htm>
155. Technical Review Committee. June 1994. Guidelines for Composting Toilets. Washington State Department of Health. p. 2.
156. Water Conserving On-Site Wastewater Treatment Systems. 5 April 1999. Washington State Department of Health. p. 3.
157. Technical Review Committee. June 1994. Guidelines for Composting Toilets. Washington State Department of Health. p. 1.
158. Water Conserving On-Site Wastewater Treatment Systems. 5 April 1999. Washington State Department of Health. p. 2.
159. Ibid. p. 4.
160. Technical Review Committee. June 1994. Guidelines for Composting Toilets. Washington State Department of Health. p. 3, 4, 5.
161. Technical Review Committee. June 1994. Guidelines for Composting Toilets. Washington State Department of Health. p. 19, 20, 22, 23.
162. West Virginia Board of Health. 1983. Interpretive Rule 16-1. Series VII. Part V. Sec. 10.0. p. 135.

*Source: The Humanure Handbook. Jenkins Publishing, PO Box 607, Grove City, PA 16127. To order, phone: 1-800-639-4099.  
<http://www.jenkinspublishing.com/>*

---

**MENU: [HOME](#) » [Reconstruction](#) » [Recovery](#) » [Renewal](#) » [Survival](#) » [Humanure Content](#)**

---



## Humanure Glossary:

### **actinomycete**

Bacteria resembling fungi because they usually produce a characteristic, branched mycelium.

### **activated sludge**

Sewage sludge that is treated by forcing air through it in order to activate the beneficial microbial populations resident in the sludge.

### **aerobic**

Able to live, grow, or take place only where free oxygen is present, such as aerobic bacteria.

### **algae**

Small aquatic plants.

### **ambient air temperature**

The temperature of the surrounding air, such as the outdoor air temperature in the vicinity of a compost pile.

### **amendment**

See “bulking agent.”

### **anaerobic**

Able to live and grow where there is no oxygen.

### **Ascaris**

A genus of roundworm parasitic to humans.

### **Aspergillus fumigatus**

A spore-forming fungus that can cause allergic reactions in some people.

### **bacteria**

One-celled microscopic organisms. Some are capable of causing disease in humans, others are capable of elevating the temperature of a pile of decomposing refuse sufficiently to destroy human pathogens.

### **biochemical oxygen demand (BOD)**

The amount of oxygen used when organic matter undergoes decomposition by microorganisms. Testing for BOD is done to assess the amount of organic matter in water.

### **blackwater**

Wastewater from a toilet.

### **bulking agent**

An ingredient in compost, such as sawdust or straw, used to improve the structure, porosity, liquid absorption, odor, and carbon content. The terms “bulking agent” and “amendment” are often interchangeable.

### **carbonaceous**

Consisting of or containing carbon.

**carbon dioxide (CO<sub>2</sub>)**

An inorganic gas composed of carbon and oxygen produced during composting.

**cellulose**

The principal component of cell walls of plants, composed of a long chain of tightly bound sugar molecules.

**C/N ratio**

The ratio of carbon to nitrogen in an organic material.

**combined sewers**

Sewers that collect both sewage and rain water runoff.

**compost**

A mixture of decomposing vegetable refuse, manure, etc., for fertilizing and conditioning soil.

**continuous composting**

A system of composting in which organic refuse material is continuously or daily added to the compost bin or pit.

**cryptosporidia**

A pathogenic protozoa which causes diarrhea in humans.

**curing**

Final stage of composting. Also called aging, or maturing.

**effluent**

Wastewater flowing from a source.

**enteric**

Intestinal

**evapotranspiration**

The transfer of water from the soil into the atmosphere both by evaporation and by transpiration of the plants growing on the soil.

**fecal coliforms**

Generally harmless bacteria that are commonly found in the intestines of warm-blooded animals, used as an indicator of fecal contamination.

**fecophobia**

Fear of fecal material, especially in regard to the use of human fecal material for agricultural purposes.

**fungi**

Simple plants, often microscopic, that lack photosynthetic pigment.

**graywater**

Household drain water from sinks, tubs, and washing (not from toilets).

**green manure**

Vegetation grown to be used as fertilizer for the soil, either by direct application of the vegetation to the soil, by composting it before soil application, or by the leguminous fixing of nitrogen in the root nodules of the vegetation.

**heavy metal**

Metals such as lead, mercury, cadmium, etc., having more than five times the weight of water. When concentrated in the environment, can pose a significant health risk to humans.

**helminth**

A worm or worm-like animal, especially parasitic worms of the human digestive system, such as the roundworm or hookworm.

**human nutrient cycle**

The endlessly repeating cyclical movement of nutrients from soil to plants and animals, to humans, and back to soil.

**humanure**

Human feces and urine used for agriculture purposes.

**humus**

A dark, loamy, organic material resulting from the decay of plant and animal refuse.

**hygiene**

Sanitary practices, cleanliness.

**indicator pathogen**

A pathogen whose occurrence serves as evidence that certain environmental conditions, such as pollution, exist.

**K**

Chemical symbol for potassium.

**latrine**

A toilet, often for the use of a large number of people.

**leachate**

Any liquid draining from a source. Pertaining to compost, it is the liquid that drains from organic material, especially when rain water comes in contact with the compost.

**lignin**

A substance that forms the woody cell walls of plants and the “cement” between them. Lignin is found together with cellulose and is resistant to biological decomposition.

**macroorganism**

An organism which, unlike a microorganism, can be seen by the naked eye, such as an earthworm.

**mesophile**

Microorganisms which thrive at medium temperatures (20-37°C or 68-99°F).

**metric tonne**

A measure of weight equal to 1,000 kilograms or 2,204.62 pounds.

**microhusbandry**

The cultivation of microscopic organisms for the purpose of benefiting humanity, such as in the production of fermented foods, or in the decomposition of organic refuse materials.

**microorganism**

An organism that needs to be magnified in order to be seen by the human eye.

**moulder (also molder)**

To slowly decay, generally at temperatures below that of the human body.

**mulch**

Organic material, such as leaves or straw, spread on the ground around plants to hold in moisture, smother weeds, and feed the soil.

**municipal solid waste (MSW)**

Solid waste originating from homes, industries, businesses, demolition, land clearing, and

construction.

## **mycelium**

Fungus filaments or hyphae.

## **N**

Chemical symbol for nitrogen.

## **naturalchemy**

The transformation of seemingly valueless materials into materials of high value using only natural processes, such as the conversion of humanure into humus by means of microbial activity.

## **night soil**

Human excrement used raw as a soil fertilizer.

## **nitrates**

A salt or ester of nitric acid, such as potassium nitrate or sodium nitrate, both used as fertilizers, and which show up in water supplies as pollution.

## **organic**

Referring to a material from an animal or vegetable source, such as refuse in the form of manure or food scraps; also a form of agriculture which employs fertilizers and soil conditioners that are primarily derived from animal or vegetable sources as opposed to mineral or petrochemical sources.

## **P**

Chemical symbol for phosphorous.

## **pathogen**

A disease-causing microorganism.

## **PCB**

Polychlorinated biphenyl, a persistent and pervasive environmental contaminant.

## **peat moss**

Organic matter that is under-decomposed or slightly decomposed originating under conditions of excessive moisture such as in a bog.

## **pH**

A symbol for the degree of acidity or alkalinity in a solution, ranging in value from 1 to 14. Below 7 is acidic, above 7 is alkaline, 7 is neutral.

## **phytotoxic**

Toxic to plants.

## **pit latrine**

A hole or pit into which human excrement is deposited. Known as an outhouse or privy when sheltered by a small building.

## **protozoa**

Tiny, mostly microscopic animals each consisting of a single cell or a group of more or less identical cells, and living primarily in water. Some are human pathogens.

## **psychrophile**

Microorganism which thrives at low temperatures [as low as -10oC (14oF), but optimally above 20oC (68oF)].

## **schistosome**

Any genus of flukes that live as parasites in the blood vessels of mammals, including humans.

- septage**  
The organic material pumped from septic tanks.
- septic**  
Causing or resulting from putrefaction (foul-smelling decomposition).
- shigella**  
Rod-shaped bacteria, certain species of which cause dysentery.
- sludge**  
The heavy sediment in a sewage or septic tank.
- source separation**  
The separation of discarded material by specific material type at the point of generation.
- sustainable**  
Able to be continued indefinitely without a significant negative impact on the environment or its inhabitants.
- thermophilic**  
Characterized by having an affinity for high temperatures (above 40.50C or 1050F), or for being able to generate high temperatures.
- tipping fee**  
The fee charged to dispose of refuse material.
- vector**  
A route of transmission of pathogens from a source to a victim. Vectors can be insects, birds, dogs, rodents, or vermin.
- vermicomposting**  
The conversion of organic material into worm castings by earthworms.
- vermin**  
Objectionable pests, usually of a small size, such as flies, mice, and rats, etc..
- virus**  
Any group of submicroscopic pathogens which multiply only in connection with living cells.
- waste**  
A substance or material with no inherent value or usefulness, or a substance or material discarded despite its inherent value or usefulness.
- wastewater**  
Water discarded as waste, often polluted with human excrements or other human pollutants, and discharged into any of various wastewater treatment systems, if not directly into the environment.
- Western**  
Of or pertaining to the Western hemisphere (which includes North and South America and Europe) or its human inhabitants.
- windrow**  
A long, low, narrow pile, such as of compost.
- worm castings**  
Earthworm excrement. Worm castings appear dark and granular like soil, and are rich in soil nutrients.
- yard material**  
Leaves, grass clippings, garden materials, hedge clippings, and brush.

Source: *The Humanure Handbook*. Jenkins Publishing, PO Box 607, Grove City, PA 16127. To order, phone: 1-800-639-4099.

<http://www.jenkinspublishing.com/>

---

**MENU:** [HOME](#) » [Reconstruction](#) » [Recovery](#) » [Renewal](#) » [Survival](#) » [Humanure Content](#)

---

---

363.7288 J52h  
Jenkins, Joseph C.  
The humanure handbook : a  
guide to composting human  
S  
33293006046736

# HUMANURE HANDBOOK

*A GUIDE TO COMPOSTING HUMAN MANURE*

(Emphasizing Minimum Technology and Maximum Hygienic Safety)

*Copyright 1994 by Joseph C. Jenkins*

*All Rights Reserved*

*Third Printing*

The author permits the use of substantial excerpts from this book, providing that the use of such excerpts is not for the purpose of financial profit, and that the source of the information, including title of this book and the publisher's address, is acknowledged on the copied information. This license is granted for the purpose of making information on the subject of composting humanure available to those people who cannot afford to purchase the entire book.

Correspondences and/or book orders may be addressed to:  
Jenkins Publishing, PO Box 607, Grove City, PA 16127 USA

ISBN 0-9644258-4-X

Library of Congress Catalog Card Number: 95-94239

# The Humanure Handbook

Copyright 1994 by Joseph C. Jenkins  
All rights reserved except as outlined on previous page.

Printed in the United States of America. - Published in the United States by:  
Jenkins Publishing • PO Box 607 • Grove City, PA 16127 USA.

## *Acknowledgements*

Editorial assistance from the following persons is gratefully acknowledged: Jeanine Jenkins, Joseph J. Jenkins, Michael Crews, Barry Smith, and Stephen Brown.

Thanks also to Tom Benevento for the information on the Guatemalan mouldering toilet and for allowing me to photograph him next to a Clivus Multrum; to Pam Owens for allowing me to photograph her with cedar posts in hand; to Jeanine for gracing the pages of this book with photos of her working with humanure compost; and to all the neighbors and friends who helped in the creation of this book by loaning the author reference materials, by suggesting sources of information, and for allowing the author to photograph their sawdust toilets, which was done in some cases (quite by accident) when they weren't home, allowing for candid photos of sawdust toilets as they look everyday.

A word of appreciation is in order for the Slippery Rock University Master of Science in Sustainable Systems program, Slippery Rock, PA 16057 USA, which played a significant role in encouraging the author to focus his attention on the subject at hand.

A note of appreciation must be added for the international permaculture, organic agriculture, and sustainable gardening communities, whose existence and support has been inspirational.

Finally, a *special* note of recognition must be added in behalf of the author's wife, Jeanine, whose assistance at every stage in the creation of this work was tremendously beneficial.

Photographs, design and graphics are by the author unless otherwise indicated. Some of the graphics include clip art, or modified clip art, and any advertisements or segments of advertisements came from very old magazines found in a barn.

Cartoon artwork on pages 28, 49, 64, 84, 108, 136, 184, 188, and back cover by  
Tom Griffin, Otter Creek, Mercer, PA 16137 USA.

Front cover artwork by Joanna and Chris Ithen, Ithen Printing Services, Grove City,  
PA 16127 USA.



### Third Printing Notes from the Author

When first published, I wondered whether this book would sink or swim, suspecting that not many people would want to read about “*humanure*”. But I should have known - this book neither sinks nor swims. It *floats*. And like a turd that won’t flush, the Humanure Handbook keeps coming back. This is surprising, considering the humor throughout this book is execrable, and there is plenty to be offended or annoyed by if you have a mind for it. Worse, there are two prerequisites to reading this book: you must be able to read, and you must be able to defecate. Apparently there are still *some* people who fit into this category, and for the most part, their comments have been encouraging. Here’s a sampling:

*“Your discovery of the proper small scale of the operation is world shaking.”*

F. A., Delaware

*“I enjoyed the book immensely, but my mother is appalled. Pleasing me and irritating my mother - you score big in my two favorite categories.”* K. L., Indiana

*“Your book is pure gold, just what I needed to give to my County Health Department.”* M. T., Missouri

*“Your book was carefully handed to me in a brown paper bag at church last spring. Great research, clear writing and terrific humor.”* L. U., West Virginia

*“I showed a review of your book to my dad and he almost gagged! Would you mail me one in a plain wrapper? I live with my parents.”* M. C., Colorado

*“If you could claim credit for engineering the thermophilic decomposers, you would probably win the Nobel Peace Prize.”* T. C., Arizona

*“We started using our ‘system’ the day after receiving the book. It took about two hours to put together. I wish more problems that at first seemed complicated and expensive could be solved as simply as this.”* J. F., New York

*“I’ve been composting and using my own waste for the past 20 years. Most of my friends think it odd. I counter that not even barbarians piss and shit in their drinking water!”* E. S., Washington

*“Fascinating! We are indebted to you for your book Humanure Handbook.”*  
R. L., New York

*“I’m sure you’ve probably heard it all before, but I really appreciate the fact that someone finally did their research and put it together in a pleasant readable form.”* S. C., Wisconsin

*“For 22 years I have used scarab beetle/larvae . . . they eat my shit in five minutes flat.”* C. M., South Carolina

*“I live and work in an international youth hostel and we’re using your saw-dust toilets.”* B. S., Georgia

*"This wonderful book fits right into my compost = redemption religious philosophy. You have answered questions I have held open since childhood."* R., Massachusetts

*"Just finished reading your book and I'm glad. Seeing Mr. Turdly dancing around the compost pile wasn't my ideal dream."* E. S., Washington

*"I'm wracking my brain, trying to find a compelling way to tell you how great I think your book is."* K. W., Wisconsin

*"I've spent my whole life recycling, reducing, reusing everything but my own shit and I'm ecstatically grateful to have your directions reach my lap."* W., Maine

*"I found your book entertaining, informative, and a great motivating force compelling us to start recycling our "humanure" immediately."* B. W., Texas

*"It is the shittiest book I've ever read, but it's great!"* D. H., Wyoming

*"I liked your book. Putting back nutrients after taking them away makes sense as well as the image of dropping a turd in a 5 gallon toilet filled with pure drinking water seems crazy."* T. O., New Hampshire

*"As parasites attached to the earth, it would seem that the only conscious thing we do that isn't killing the host, is manuring in the woods, fields or a compost toilet."* D. G., Minnesota

*"Two things you might be interested in: A more natural way to eliminate is in the squatting position. [and] Urine is not a waste product. Taking urine internally has been going on for some time (1000's of years) and by many is considered a wonderful medicine. I take my first urine daily. Also, urine is used today in ear wax removal, hand creams, and other. Now is that full of crap . . . or is it?"* W. E., Ohio

*"Your book (Humanure) saved my butt at a town council meeting yesterday. Thank you for writing it."* D. W., Colorado

*"My 74 year old father thinks human waste should not be used in a garden, and I want to prove him wrong."* A. M., Washington

*"I had to call my dear heart long distance immediately to read her what may be the most hopeful environmental news I've read in my 35 years, that something can transmute horrible toxins. Why aren't all the environmentalists raving about this?"* C., Vermont

There have been enough written comments about the Humanure Handbook to fill an entire book. The first two printings have been read in every state in the USA including Puerto Rico, and in at least nine other countries (Canada, Australia, Japan, England, Mexico, Guatemala, Spain, Wales, and Malaysia), by people of all ages (teens to nonagenarians). Perhaps the time has come to make *humanure* a household word. And with enough brown paper bags, perhaps the book will even get passed around a bit!

JCJ - Spring, 1996

# **TABLE OF CONTENTS**

## **INTRODUCTORY INFORMATION**

Page 7

### **Chapter 1**

#### **CRAP HAPPENS**

Page 13

*Soiled Water; Waste Reduction-Resource Recovery; Waste vs. Manure; Experience Helps.*

### **Chapter 2**

#### **MICROHUSBANDRY**

Page 29

*Naturalchemy; Gomer the Pile; The Carbon/Nitrogen Ratio; Misinformation; Have a Good Blend; Newspaper; Lime.*

### **Chapter 3**

#### **DEEP SHIT**

Page 51

*Waste vs. Manure, Again; The Advances of Science; Holy Sheesh; When the Crap Hit the Fan.*

### **Chapter 4**

#### **A DAY IN THE LIFE OF A TURD**

Page 65

*Mexican Biological Digester; The Old Fashioned Outhouse; Septic Systems; Sand Mounds; Ground Water Pollution from Septic Systems; Wastewater Treatment Plants; Chlorine; Alternative Wastewater Treatment Systems; Agricultural Use of Sewage Sludge; Global Sewers and Pet Turds.*

**Chapter 5**  
**COMPOSTING TOILETS AND SYSTEMS**

Page 85

*The Non-Commercial (Homemade) Mouldering Toilet; Commercial Mouldering (or Multrum) Toilets; More Commercial Composting Toilets; Asian Composting; Simple, Low-Tech Humanure Composting.*

**Chapter 6**  
**WORMS AND DISEASE**

Page 109

*The Hunzas; Pathogens; Indicator Pathogens; Persistence of Pathogens on Soil, Crops, Manure and Sludge; Eliminating Pathogens From Humanure; More on Parasitic Worms; Summary of Conditions Needed to Kill Pathogens; Conclusions.*

**Chapter 7**  
**THE TAO OF COMPOST**

Page 137

*Primal Compost; The Evolution of Compost; Thermophilic Microorganisms; Four Necessities for Good Compost; Doing It; The Sawdust Toilet; Analyses; Low-Impact Composting; Monitoring Compost Temperature; Legalities.*

**Chapter 8**  
**THE END IS NEAR**

Page 175

**APPENDICES**

Page 185

*1) Sources of compost thermometers; 2) Metric conversions; 3) Centigrade/Fahrenheit conversions; 4) Sawdust toilet temperature curve.*

**GLOSSARY**

Page 189

**INDEX**

Page 193

**INTRODUCTORY INFORMATION**

Figure A: The human nutrient cycle - intact .....11  
 Figure B: The human nutrient cycle - broken .....12

**CHAPTER ONE**

Figure 1.1: Gross solid waste generated in the USA, not including sewage .....15  
 Figure 1.2: Amount of humanure available worldwide per square mile of  
 tillable land .....16  
 Figure 1.3: Sewage sludge dumped in U.S. ocean waters, 1973-1986 .....18  
 Figure 1.4: Average annual per capita water use in selected countries .....20  
 Figure 1.5: Use of fertilizer worldwide since 1950 .....19  
 Figure 1.6: Amount of nitrogen used in fertilizers in the USA derived from  
 organic sources (1900 and 1948) .....19  
 Figure 1.7: Composition of unrecycled discarded solid waste in the  
 USA, 1980-2000 .....23  
 Figure 1.8: Percentage of world population without adequate sanitation .....21  
 Figure 1.9: Composition of municipal waste in USA, 1986 .....21  
 Figure 1.10: Our increasing impact on planet Earth - world population  
 growth, production and fuel consumption since 1900 .....22

**CHAPTER TWO**

Figure 2.1: Size of bacteria relative to a red blood cell, a hair, and a grain  
 of sand .....33  
 Figure 2.2: The Marino toilet - 1858 - Copenhagen .....42  
 Table 2.1: Composition of humanure .....39  
 Table 2.2: Carbon/nitrogen ratios for some compostable materials .....40  
 Table 2.3: Nitrogen loss and C/N ratio .....39

**CHAPTER FOUR**

Figure 4.1: Biological Digester - South India .....66  
 Figure 4.2: Spread of pollution through dry soil by outhouses .....66  
 Figure 4.3: Pour flush latrines .....67  
 Figure 4.4: The BOTVIP latrine: Botswana's rural ventilated improved  
 pit latrines .....67  
 Figure 4.5: Spread of pollution from outhouses (pit latrines) in wet soil .....68  
 Figure 4.6: Cross section of a septic tank .....68  
 Figure 4.7: Septic tank gravity distribution system .....69  
 Figure 4.8: Sand mound waste distribution system .....69  
 Figure 4.9: Sources of ground water contaminants in the United States .....70  
 Figure 4.10: Ground water contaminants in the United States .....71  
 Figure 4.11: Activated sludge wastewater treatment process .....72  
 Figure 4.12: Wetland wastewater treatment system .....76

**CHAPTER FIVE**

Figure 5.1: Mouldering toilet (cutaway side view) .....89  
 Figure 5.2: Mouldering toilet (cutaway south view) .....90  
 Figure 5.3: Guatemalan mouldering toilet .....91  
 Figure 5.4: Multrum toilet .....93  
 Figure 5.5: Vietnamese double vault .....99

**CHAPTER SIX**

Table 6.1: Pathogens in urine .....112  
 Table 6.2: Viral pathogens in feces .....113  
 Table 6.3: Bacterial pathogens in feces .....114  
 Table 6.4: Protozoan pathogens in feces .....114  
 Table 6.5: Worm pathogens in feces .....115  
 Table 6.6: Survival of enteroviruses in soil .....119  
 Table 6.7: Survival time of some protozoa in soil .....119  
 Table 6.8: Survival time of some bacteria in soil .....120  
 Table 6.9: Survival time of polioviruses in soil .....120  
 Table 6.10: Survival time of some pathogenic worms in soil .....121  
 Table 6.11: Pathogen survival by composting or soil application .....127  
 Table 6.12: Hookworms .....129  
 Table 6.13: Average density of fecal coliforms excreted in 24 hours  
 by various animals .....117  
 Table 6.14: Parasitic Worm Egg Death .....131  
 Figure 6A: Transmission of pathogens through septic tank waste

disposal systems .....	123
Figure 6B: Transmission of pathogens through conventional sewage treatment plants .....	124
Figure 6C: Transmission of pathogens through waste stabilization ponds .....	124
Figure 6D: Transmission of pathogens through passive, low temperature composting toilets and mouldering toilets .....	125
Figure 6E: Transmission of pathogens through a thermophilic composting system .....	126
Figure 6F: Safety zone for pathogen death .....	133
Figure 6G: Survival times of fecal coliforms in soil .....	118
<b>CHAPTER SEVEN</b>	
Figure 7.1: The Tao of the sawdust toilet .....	154
Figure 7.2: Diagrams of sawdust toilet .....	155
Figure 7.3: Constructing a simple compost bin .....	157
Figure 7.4: Two styles of three-chambered compost bins .....	159
Figure 7.5: Anatomy of a continuous compost bin .....	160
Figure 7.6: Temperature curve of frozen humanure compost pile after spring thaw .....	164
Figure 7.7: Camp composter .....	168
Figure 7.8: Camp composter on a bank .....	171

## **SIDEBARS**

	<b>PAGE</b>
<b>CHAPTER ONE</b>	
Fun Facts: Waste not want not .....	14
Fun Facts: About water .....	18
<b>CHAPTER TWO</b>	
Fun Facts: Carbon/nitrogen ratio .....	41
Essential Reading for Insomniacs: pH .....	47
<b>CHAPTER SEVEN</b>	
Essential Reading for Insomniacs: Thermophilic microorganisms .....	143
A Tip from Mr. Turdley: Sawdust .....	151
Another Tip from Mr. Turdley: The secret to composting humanure is to keep it covered .....	153
Yet Another Tip from Mr. Turdley: Pressure treated lumber should never be used for constructing compost bins .....	156
Do's and Don't's of a Thermophilic Toilet Composting System .....	166

## **PHOTOGRAPHS**

	<b>PAGE</b>
<b>CHAPTER ONE</b>	
Humanure compost being wheelbarrowed to a garden .....	17
Humanure compost applied by hand to garden beds .....	24
<b>CHAPTER TWO</b>	
Humanure compost being removed from a double chambered bin .....	34
Humanure compost being applied to a raised bed in the spring .....	45
Probing a compost pile with compost thermometers .....	46
<b>CHAPTER FIVE</b>	
A Clivus Multrum toilet at Slippery Rock University .....	94
The contents of a Clivus Multrum toilet being examined through the access door .....	95
A young lady setting cedar posts for a compost bin .....	97
A sawdust toilet 100 .....	101
A sawdust toilet showing removability of contents .....	103
A sawdust shed at a sawmill .....	103
<b>CHAPTER SEVEN</b>	
Indoor sawdust toilet in new home .....	152
Sawdust toilet with recessed peat moss container .....	158
Sawdust toilet in a basement .....	162
Sawdust toilet made of wooden box .....	165
Sawdust toilet in mobile home .....	167
Outdoor sawdust toilet .....	169
Sawdust toilet "outhouse" .....	170
<b>CHAPTER EIGHT</b>	
The author at the end of a long day .....	183

The Humanure Handbook  
**INTRODUCTORY INFORMATION**

*"It is more important to tell the simple, blunt truth than it is to say things that sound good."*

John Heider



**A**merica is a land of waste. Much of what we waste consists of organic material which would prove very valuable if we would recycle it for agricultural purposes. That organic material includes food wastes, municipal leaves and other yard wastes, agricultural residues, and human waste in the form of digestive refuse material, otherwise known as fecal material and urine. The simple blunt truth is that we shit every day and we should be returning that organic material back to the soil.

Each of us is responsible for the byproducts of our digestive systems, namely feces and urine. Feces and urine are not waste. They are natural, organic refuse materials discarded by our bodies after completing the digestive processes. We choose to make these organic materials either waste materials or resource materials depending on what we do with them. When we discard them, we waste them. When we recycle them, we recover a natural resource.

*Recycled refuse is not waste.* It is a common misuse of semantics to say that waste is, can be, or should be recycled. Resource materials are recycled. Refuse is recycled. But waste is never recycled. That's why it's called "waste". This may seem like a trifling point to some, however it's actually quite important. Those of you who take the responsibility for recycling your refuse materials are not creating waste, and the term "waste" should not be associated with you. If you are composting all of your body's organic refuse and returning it to the soil and someone asks you, "*What do you do with your human waste?*" the correct response would be, "*What waste?*"

So let's define some terms. Feces and urine are byproducts of the human digestive system. They are refuse materials. When discarded, they're known as human waste. When recycled for agricultural purposes they're known by various names, including night soil (in Asia) and human manure or **humanure**. *Humanure is not human waste. Humanure is not waste - it is an agricultural resource.*

Humanure is a valuable organic resource material, in contrast to human waste, which is a dangerous pollutant. Humanure originated from the soil and can be quite readily returned to the soil, especially if properly composted. Human waste (discarded feces and urine), on the other hand, creates significant environmental problems, provides a route of transmission for disease, and deprives humanity of important soil nutrients. It's also one of the primary ingredients in sewage, and is largely responsible for much of the world's water pollution.

When crops of any sort are produced from soil, it is imperative that the organic residues - the refuse materials resulting from those crops, including animal excrements - are returned to the soil from which the crops originated. *This recycling of all organic residues for agricultural purposes should be axiomatic to sustainable agriculture.* Yet, spokespersons for the sustainable agriculture movement in the West remain silent about using humanure for agricultural purposes. Why?

In the 1970's I played around with the idea of composting my own manure for a few years, but I didn't get into it seriously until I settled down on my own homestead in 1979. At that time, I began composting humanure, proceeding through the process instinctively, altering my procedures when necessary, but always maintaining an emphasis on simplicity. Now, fifteen years later, I've decided to write about my experiences for the sake of those who are interested.

In the process of creating this book, I engaged in an extensive review of the literature related to the topic of composting humanure. I have carefully listed all of my references at the end of each chapter, and I encourage the reader to look to those references for verification or for additional information. In that review, I was surprised and even shocked to find that a) there is very little in print on the subject of composting humanure, and b) the information that is available is inconsistent with and sometimes diametrically opposed to the information which I gleaned from my own experiences. For example, current literature still lists humanure as a taboo and dangerous compost ingredient. (I don't. In fact, I would describe it more as an *essential* compost ingredient.) It recommends turning compost piles. (I don't. In fact, turning compost piles can do more harm than good.) It recommends liming compost, using other rock dusts in compost, or covering it with wood ashes (I don't. Rock dusts have no place in a compost pile.) It recommends segregating urine from feces when humanure is composted (I don't, and I can't imagine anything more undesirable than segregating urine from fecal material.) And the list goes on.

Before I continue, I want to make it perfectly clear that I do not consider myself an agricultural or scientific expert in any professional sense of the word. I am simply a layperson with twenty years of gardening experience who has done research



and gained experiences on composting humanure which others may find valuable. Nobody has paid me in any way to write this book, and all expenses incurred have come out of my own pocket.

It has not been my intent or goal, nor will it ever be, to profit financially from this book, although I'd be happy if my production expenses are one day eventually reimbursed. My intent has been to provide helpful information to those who want it, and to stimulate discussion about neglected topics including composting, humanure, the human nutrient cycle, waste, sustainable gardening, sustainable agriculture, etc. I'd roughly estimate that one in a million Americans have an interest in composting humanure. If I manage to find all of them and they read this book, I'll need a total of about 250 copies available in print. If that. On the other hand, there are millions of people throughout the developing world who could benefit from the information in this book. These are people who live simple lives with minimal resources and who are more apt to understand the increasing need to hygienically recycle organic refuse as the human population continues to swell upon an ever-shrinking planet.

I approach this topic (composting humanure) with a certain bias in favor of simplicity; or perhaps *sustainability* would be a more appropriate word. Therefore, most of the practical information that I present in this book reflects a sustainable approach. I don't encourage energy intensive or resource consumptive approaches to humanure composting. The methods I encourage are ones requiring little, if any, technology, and no electricity. They focus on the single family level, and not on the municipal level. The information I present is ideal for people who cannot or do not want to use running water or electricity for organic resource recycling, either by choice, culture, or emergency circumstances, or who have meager material resources at their disposal and can't afford expensive waste disposal systems or the loss of soil nutrients that would result from such systems. It is also ideal for anyone wanting to gain a basic understanding of humanure composting, no matter how complicated a recycling system they want to use for themselves, if any at all.

Composting humanure involves a simple process of microbial digestion. Like anything, the process can be made as difficult or complicated as one wants. It's the *process* itself that's important, not to mention interesting. For example, few people realize that there are reportedly 100 billion bacteria *per gram* of humanure, or that bacteria can digest diesel fuel and TNT, or chemically alter uranium. Some say that microorganisms in a compost pile can even produce enough heat to cook an egg (so far I haven't tried this).

Let's face it- everybody shits. It's one of those basic functions of the human body. We breathe, we eat, we copulate, we defecate, not necessarily in that order. Yet,

few people know anything about what happens to their excrement after it's been flushed down a toilet, or about the value of humanure as agricultural fertilizer, or about how to render it hygienically safe for recycling. Must our topsoil become depleted of nutrients and our agricultural petrochemicals that currently replace those nutrients become scarce, and our water supplies polluted before the art of composting humanure will be taken seriously by the human race?

In a nutshell, the purpose of this book is to explain why we Westerners aren't composting our humanure, why we should be, and how it can be done. Much of the discussion about why we're not doing it is philosophical, with a bit of delving into history and (god forbid) religion. The discussion of why we should be composting humanure focuses on the environmental problems associated with current waste disposal systems, as well as on the loss of agricultural nutrients that is the legacy of such systems. Chapter six focuses on "worms and disease", the often repeated cry of warning from those humans who equate the recycling of humanure with barbaric and unsanitary foolishness. There is no greater barrier to the recycling of humanure than this ignorance of the Western populace. And that ignorance is pervasive, deeply rooted, and tenacious. Granted, the warnings of "worms and disease" certainly bear some merit, however, such warnings tend to be exaggerated, sensational, and rooted in ignorance or fear. It is possibly for this reason more than any other that I have been goaded into writing this book.

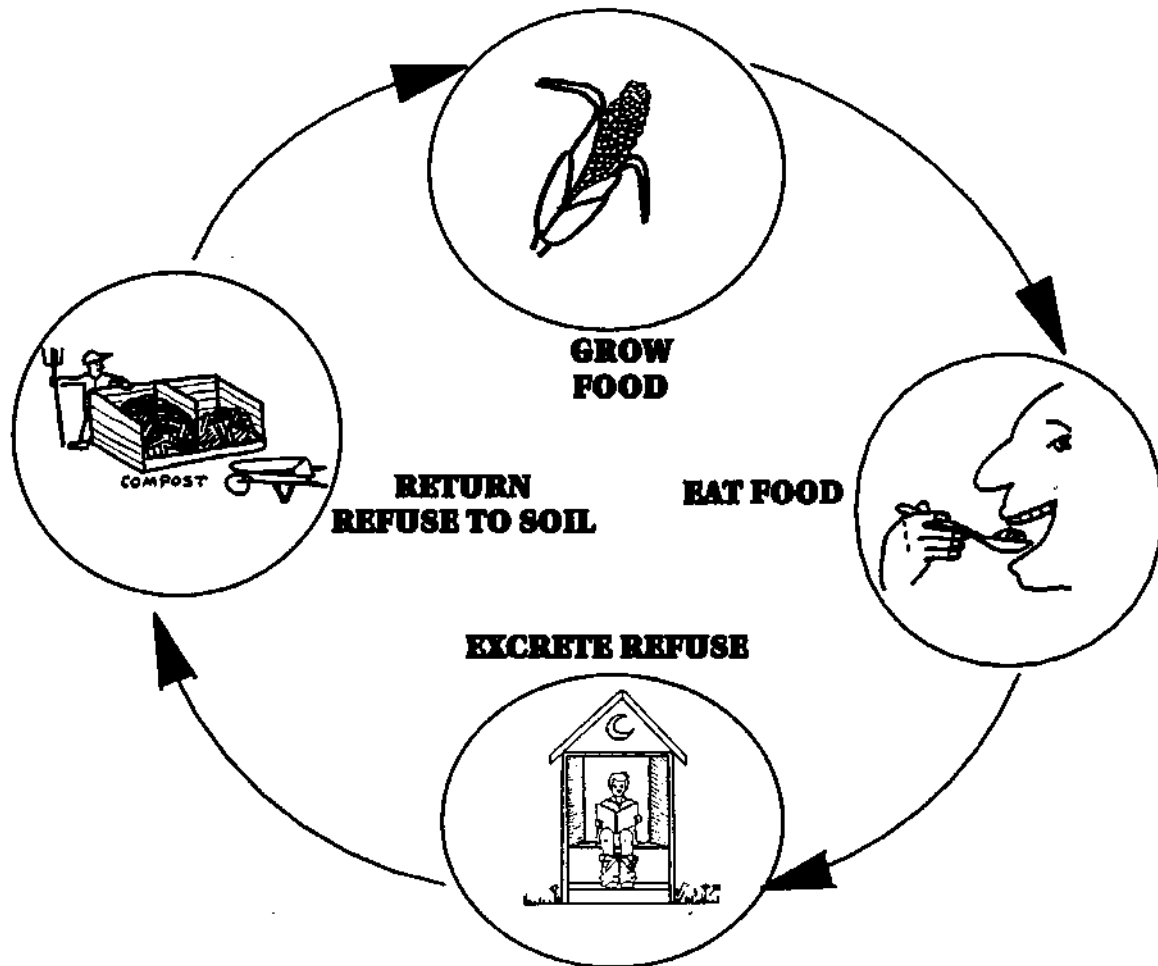
The observant reader may notice that there are some apparent inconsistencies in the information presented in this book. In cases where various sources present inconsistent data about specific topics, I have simply reported the data as presented and left the reader to draw his or her own conclusions. Such inconsistencies are infrequent and of little consequence, nevertheless their existence should not be ignored (for example, one source reports that roundworm eggs will die in two hours when subjected to a temperature of 55°C, while another source reports that the eggs will die in ten minutes at the same temperature). Furthermore, don't be surprised if some information is repeated within this book. This is not by accident, as some information is worth repeating, especially as this book may end up on a shelf to be used for later reference by many readers who may tend to refer to only one chapter or another, in which case the repetition of material may be to the reader's long-term advantage.

If you're only interested in composting humanure, and want to skip the philosophy and other extraneous information, go straight to chapter seven. However, I'd encourage the reader to start at the beginning. The story of humanure is an interesting one. It begins with witches, travels to the Far East, and ends up in one's backyard. Not in my backyard you say? Ha! Read on.

J. C. J.

FIGURE A

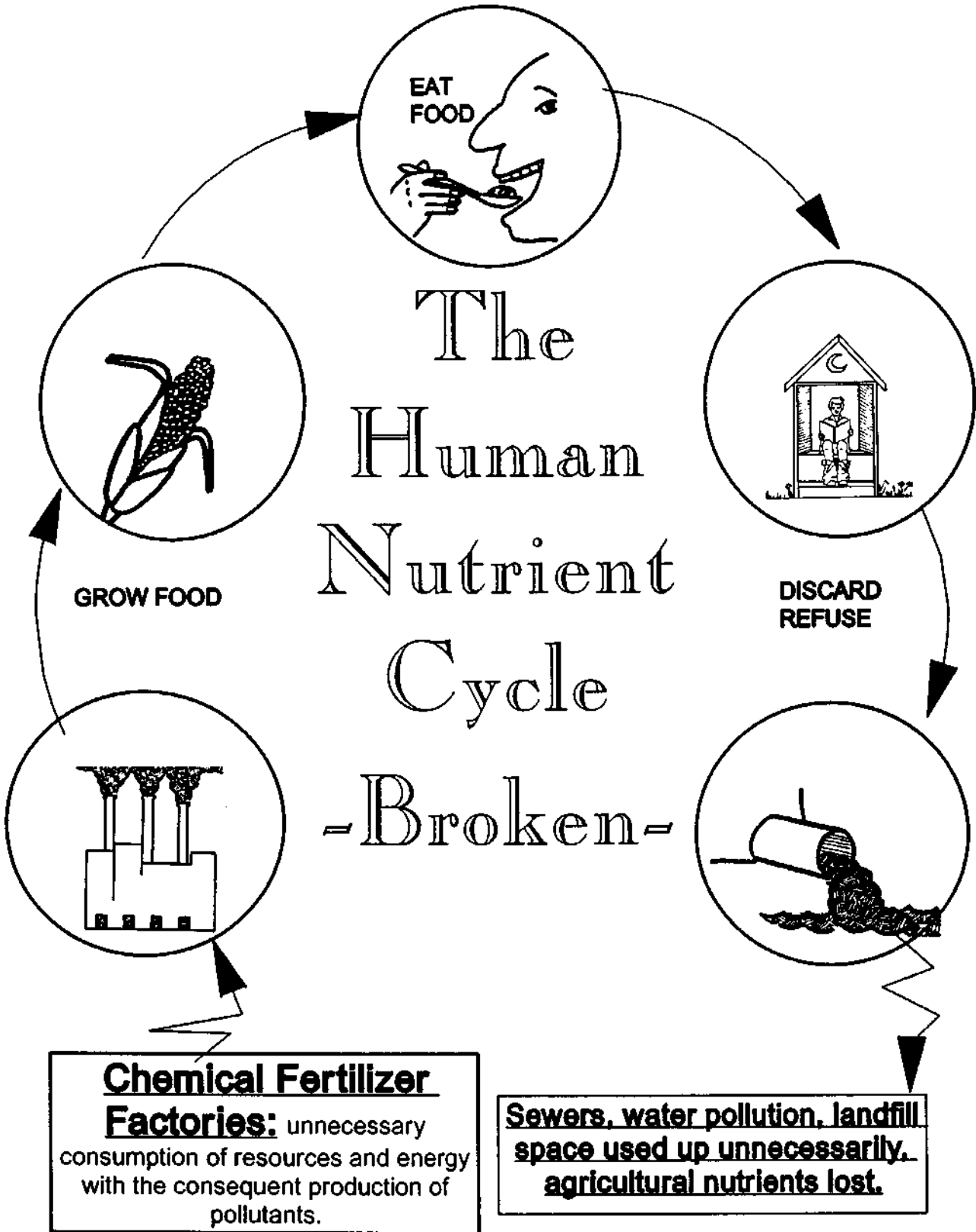
# THE HUMAN NUTRIENT CYCLE - INTACT -



**THE HUMAN NUTRIENT CYCLE IS AN ENDLESS NATURAL CYCLE.**

*IN ORDER TO KEEP THE CYCLE INTACT, FOOD FOR HUMANS MUST BE GROWN ON SOIL THAT IS ENRICHED BY THE CONTINUOUS ADDITION OF ORGANIC REFUSE MATERIALS DISCARDED BY HUMANS, SUCH AS HUMANURE, FOOD SCRAPS, AGRICULTURAL RESIDUES, AND THE LIKE. BY RESPECTING THIS CYCLE OF NATURE, HUMANS CAN MAINTAIN THE FERTILITY OF THEIR AGRICULTURAL SOILS INDEFINITELY, INSTEAD OF DEPLETING THEM OF NUTRIENTS AS IS COMMON TODAY. FOOD-PRODUCING SOILS MUST BE LEFT MORE FERTILE AFTER EACH HARVEST, DUE TO THE EVER-INCREASING HUMAN POPULATION AND THE NEED TO PRODUCE MORE FOOD WITH EACH PASSING YEAR.*

FIGURE B



## CRAP HAPPENS

*“Anyone starting out from scratch to plan a civilization would hardly have designed such a monster as our collective sewage system. Its existence gives additional point to the sometimes asked question, Is there any evidence of intelligent life on the planet Earth?”*

G. R. Stewart



**T**he world is divided into two categories of people: those who shit in drinking water and those who don't. We in the Western world are in the former class. We defecate in water, usually purified drinking water. After polluting the water with our body's digestive system byproducts, we flush the once pure but now polluted water "away". Away to where? Good question.

This ritual of defecating in water may be useful for maintaining a good standing within Western culture. If you don't deposit your feces into a bowl of drinking water on a regular basis, you may be considered a miscreant of sorts, perhaps uncivilized or dirty or poverty stricken. You may be seen as a non-conformist or a radical. However, these perspectives are based upon ignorance. There is currently a profound lack of knowledge and understanding among Westerners about what is referred to as the "human nutrient cycle" and the need to keep the cycle intact.

The human nutrient cycle goes like this: a) grow food, b) eat it, c) collect and process the food refuse (feces, urine, food scraps and agricultural residues), and d) return the processed refuse to the soil, thereby enriching the soil and enabling more food to be grown. Then the cycle is repeated, endlessly. When our food refuse is instead discarded as waste, the natural human nutrient cycle is broken and all manner of problems can result. Those problems can be summed up in two convenient words: waste and pollution.

Crap happens. However, it's interesting to note that the creation of human waste is a matter of human choice. We *choose* to throw things away rather than recycle them. We *choose* to create waste rather than recycle useful resources, because it's more convenient to discard things than to reuse them. Even though those resources may be refuse materials with little *apparent* value, such as the refuse of our digestive

systems, when recycled, they can prove to be both useful and valuable.

It's common to refer to human fecal material and human urine as "human waste". However, such a term is misleading at best. Human waste actually consists of a huge number of items and substances (cigarette butts for example), and human digestive system refuse is only waste when it's discarded. When it's recycled for agricultural purposes it's called, among other things, human manure or *humanure* for short.

All humans create fecal material and urine. However, some people create human waste, or sewage, while others create humanure, an agricultural resource, depending on whether the material is wasted or recycled. We in the United States each waste about a thousand pounds of humanure every year, which is discarded into sewers and septic systems throughout the land. Much of the discarded humanure finds its final resting place in a landfill along with the other solid waste we Americans discard, which, coincidentally, also amounts to about a thousand pounds per person per year. For a population of 250 million people, that adds up to nearly *250 million tons of solid waste discarded every year, at least half of which is valuable as an agricultural resource.*

This is not to suggest that *sewage* should be used to produce food crops. In my opinion, it should not. Sewage consists of human digestive-system refuse collected along with other hazardous materials such as industrial, medical and chemical wastes, all carried in a common water-borne waste stream. Humanure, on the other hand, when kept out of the sewers, collected as a resource material, and properly

## **FUN FACTS**



### **WASTE NOT - WANT NOT**

*America is a land of waste. Of the top fifty municipal solid waste producers in the world, America is fifth in line, being outranked only by Australia, New Zealand, France and Canada. Although the U.S. population increased by 18% between 1970 and 1986, its trash output increased by 25% during that time period, indicating that as time passes, we become more wasteful as a nation. Today, every individual in America produces about four pounds of trash daily, which will add up to 216 million tons per year by the year 2000, almost ten percent more than in 1988. If this sounds like a lot, sit down for a minute: municipal solid waste (the 216 million tons per year just mentioned) make up only one percent of the total solid waste created annually in the United States. The rest comes from industry, mining, utilities and other sources.*

processed (composted), makes for a fine agricultural resource material suitable for food crops. Granted, there are certain hygiene considerations involved in the processing of humanure for food purposes, and these will be discussed at length later in this book.

The United States Environmental Protection Agency estimates that 13.2 million tons of food refuse are produced in American cities alone every year. That food refuse would make great organic material for composting, especially if mixed with humanure. If we composted the food refuse, we would be recycling a *resource* instead of creating *waste*. Instead, much of that food waste is buried in landfills, as is most of our discarded feces and urine. Yet, it is becoming more and more obvious that it is unwise to rely on landfills to dispose of recyclable materials. Landfills fill up, and new ones need to be built to replace them. The estimated cost of building and maintaining an EPA approved landfill is now nearly \$125 million. In fact, the 8,000 operating landfills we had in the United States in 1988 had dwindled to 5,812 by the end of 1991. Slowly, we're catching on to the fact that this trend has to be turned around. We can't continue to throw "away" usable resources in a wasteful fashion by burying them in disappearing landfills.

As a result, recycling is slowly becoming more widespread in the U.S.. Between 1989 and 1992 recycling increased from 9 to 14% and the amount of U.S. municipal solid waste sent to landfills decreased by 8%.<sup>2</sup> This is a welcome trend, however it doesn't adequately address a subject sorely in need of attention: what to do with humanure, which is not being recycled.

If we had scraped up all the human excrement in the world and piled it on the world's tillable land in 1950, we'd have applied nearly 200 metric tons per square mile at that time (roughly 690 pounds per acre). In the year 2000 we'll be collecting significantly more than *double* that amount because the global population is increasing, but the global land mass isn't. In fact, the global area of agricultural land is steadily *decreasing* as the world loses, for farming and grazing, an

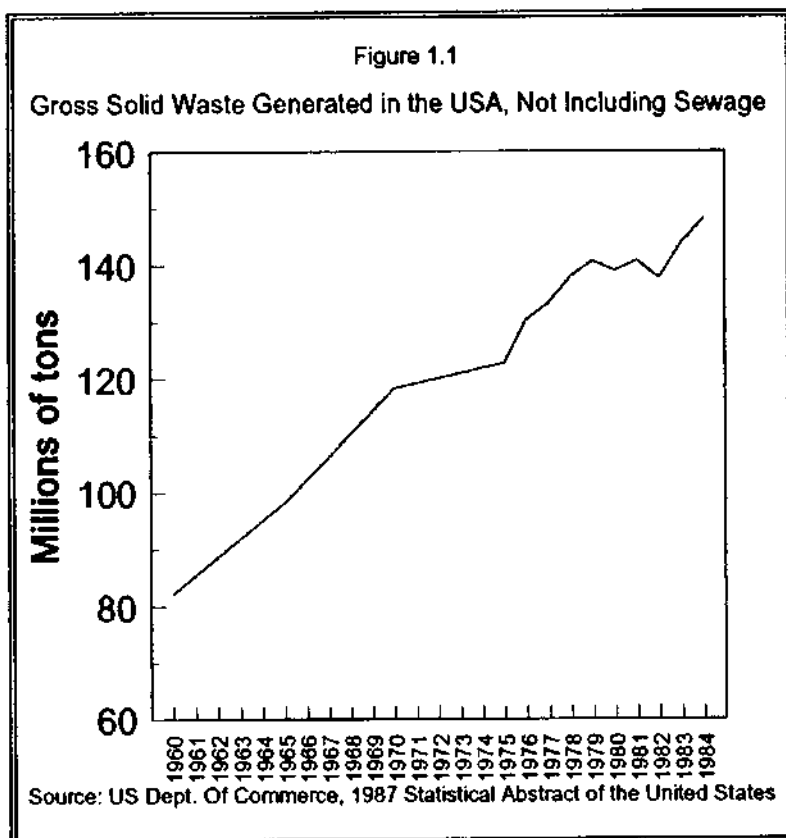
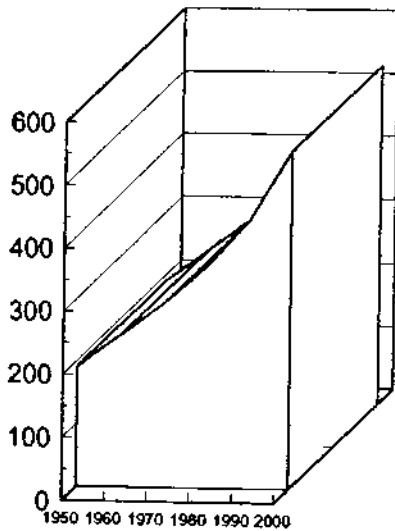


Figure 1.2

### Amount of humanure available worldwide per square mile of tillable land.



□ Metric tons per square mile.

If the world's output of human excrement were collected and applied only to arable land, we would have applied nearly 200 million tons per square mile in 1950. By the year 2000, we will have over double that amount. This does not take into account the loss of farmland due to desertification.

(Fahm, L. *The Waste of Nations*, 1980, Osmund and Co., New Jersey, pp. 37-38.)

area the size of Kansas each year.<sup>3</sup> The world's burgeoning human population is producing a ballooning amount of organic refuse which will eventually have to be dealt with responsibly and constructively. It's not too soon to begin to understand human organic refuse materials as valuable resource materials begging to be recycled.

In 1950 the dollar value of the agricultural nutrients in the world's gargantuan pile of humanure was 6.93 billion

dollars. In 2000 it will be worth 18.67 billion dollars (calculated in 1975 prices).<sup>4</sup> This is money currently being flushed down the drain and out somewhere into the environment where it shows up as pollution, and/or landfill material. Every pipe line has an outlet somewhere; everything thrown "away" just moves from one place to another. Humanure and other organic refuse materials are no exception. Not only are we flushing "money" away, we're paying through the nose to do so. And the cost is not only economic, it's environmental.

A cursory review at the local library of sewage pollution incidents in the United States yielded the following: More than 2,000 beaches and bays in twelve states were closed in 1991 because of bacterial levels deemed excessive by health authorities. The elevated bacteria levels were primarily caused by storm-water runoff, raw sewage, and animal wastes entering the oceans. The sources of the pollution included inadequate and overloaded sewage treatment plants, sewage overflows from sanitary sewers and combined sewers, faulty septic systems, boating wastes, and polluted storm water from city streets and agricultural areas.<sup>5</sup>

Also in 1991, the city of Honolulu faced penalties of about \$150 million for some 9000 alleged sewage discharge violations that were recorded since 1985<sup>6</sup>. That same year, Ohio Environmental Protection Agency fined Cincinnati's Metropolitan Sewer District \$170,000, the largest fine ever levied against an Ohio municipality, for failure to enforce its wastewater treatment program.<sup>7</sup> In 1992, the U.S. EPA sued the Los Angeles County Sanitation Districts for failing to install secondary sewage treatment at a plant which discharges wastewater into the Pacific Ocean, and for fourteen



years of raw sewage spills and other discharges that have violated California Ocean Plan bacteria standards.<sup>8</sup>

That same year California was required to spend \$10 million to repair a leaking sewer pipeline that had forced the closure of twenty miles of southern California beaches. The broken pipeline was spilling up to 180 million gallons of sewage per day into the Pacific Ocean less than one mile offshore, resulting in a state of emergency in San Diego County. This situation was compounded by the fact that a recent heavy storm had caused millions of gallons of raw sewage from Mexico to enter the ocean from the Tijuana River.<sup>9</sup>

Environmental advocates in Portland, Oregon sued the city in 1991 for allegedly discharging untreated sewage up to 3,800 times annually into the Willamette River and the Columbia Slough.<sup>10</sup> In April of 1992, national environmental groups announced that billions of gallons of raw waste pour into lakes, rivers, and coastal areas each year when combined sewers, which carry storm water and wastewater in the same pipe, overflow during heavy rains, also causing many cities to suffer from discharges of completely untreated sewage.<sup>11</sup>

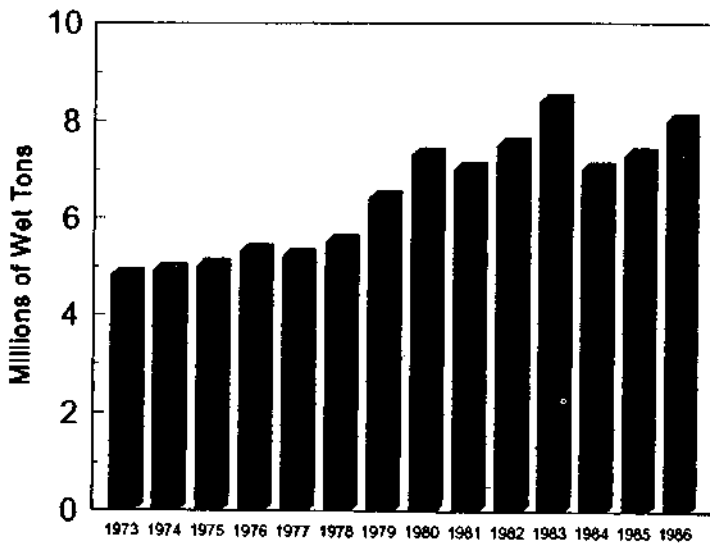
Much of the sewage sludge along coastal cities in the United States has simply been dumped into the ocean. However, dumping of sewage sludge in the ocean was banned as of December 31, 1991. Nevertheless, the city of New York was unable to meet that deadline and was forced to pay \$600 per dry ton to dump its sludge at the Deepwater Municipal Sludge Dump Site 106 miles off the coast of New Jersey. Illegal dumping of sewage into the sea also continues to be a problem.<sup>12</sup> A bigger problem may be what to do with sewage sludge now that landfill space is



When humanure is composted with other organic refuse, it is converted into a sweet-smelling soil building material. Here it is applied to a garden.

Figure 1.3

**Sewage Sludge Dumped in US Ocean Waters 1973-1986**



Source: US EPA, 1988, Report to Congress on Administration of the Marine Protection, Research, and Sanctuaries Act of 1972, EPA-503/8-88/002.

diminishing and it can no longer be dumped into the ocean. We'll get into that later.

## SOILED WATER

The discarding of human waste adversely affects the quality of our planet's water supplies. First, by defecating directly into water, we pollute the water. Every time we flush a toilet, we launch five or six gallons of polluted water out into the world.<sup>13</sup> Secondly, even after the polluted water is treated in wastewater treatment plants, it may still

be polluted with excessive levels of nitrates, chlorine, and other pollutants. This treated water is discharged directly into the environment. Also, by discarding organic human refuse materials as waste, we deprive ourselves of valuable soil nutrients. We should be returning the organic material back to the land in order to keep the human nutrient cycle intact.

Instead of using humanure to replenish the soil depleted by agriculture, we manufacture and use chemical fertilizers. From 1950 to 1980 the global consumption

## FUN FACTS about water



- ▶ If all the world's drinking water were put into one cubical tank, the tank would measure only 95 miles on each side.
- ▶ Number of people currently lacking access to clean drinking water: 1.2 billion.
- ▶ Percent of the world's households that must fetch water from outside their homes: 67%.
- ▶ Percent increase of the world's population by the middle of the next century: 100%.
- ▶ Percent increase in drinking water supplies by the middle of the next century: 0%.
- ▶ Amount of water Americans use every day: 340 billion gallons.
- ▶ Number of gallons of water needed to produce a car: 100,000.
- ▶ Number of cars produced every year: 50 million.
- ▶ Amount of water required by a nuclear reactor every year: 1.9 cubic miles.
- ▶ Amount of water used by U.S. nuclear reactors every year: the equivalent of one and a third lake Eries.

▶ Sources: Der Spiegel, May 25, 1992; and Annals of Earth, Vol. 8, No. 2, 1990, Ocean Arks International, One Locust St., Falmouth, MA 02540.

of artificial fertilizers rose by 900%<sup>14</sup>, and in 1988, U.S. farmers used almost 19 million tons of synthetic fertilizers.<sup>15</sup> All the while, hundreds of millions of tons of organic wastes are generated in the U.S. each year, including humanure, then buried in landfills when they could instead be composted and returned to the soil in place of artificial fertilizers.

Today, pollution from agriculture is said to be a main reason for poor water quality in our rivers, lakes and streams, the pollution being caused by both siltation (erosion) and nutrient runoff due to excessive or incorrect use of fertilizers.<sup>16</sup> For example, in 1992 the state of Florida was required, through litigation, to build some 35,000 acres of marshlands to filter farm-related runoff that was polluting the Everglades with nutrients such as phosphorous.<sup>17</sup> Nitrates from fertilizers are also causing pollution, seeping into ground water, lakes, rivers and streams. A 1984 U.S. EPA survey indicated that out of 124,000 water wells sampled, 24,000 had elevated levels of nitrates and 8,000 were polluted above health limits.<sup>18</sup>

Chemical fertilizers provide a quick fix of nitrogen, phosphorous, and potassium for impoverished soils. However, it's estimated that 25-85% of chemical nitrogen applied to soil and 15-20% of the phosphorous and potassium are lost to leaching, much of which can pollute groundwater.<sup>19</sup> Much of this pollution shows up in small ponds which become choked with algae as a result of the unnatural influx of nutrients.

Not only are we polluting our water with agricultural runoff and sewage, we're

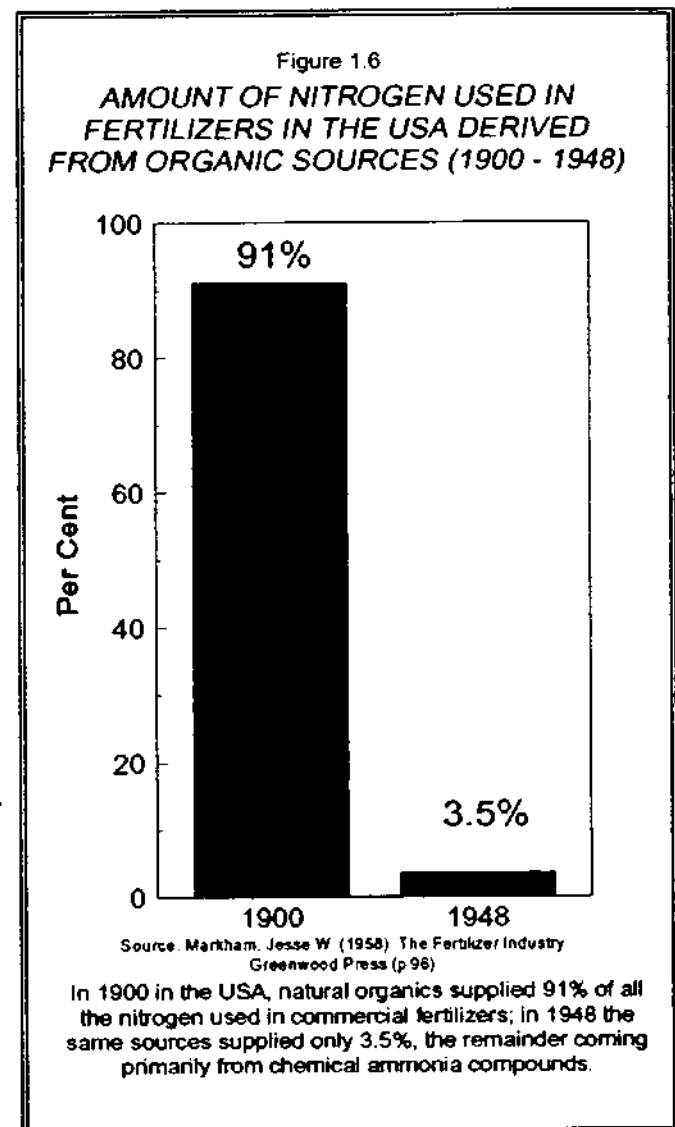
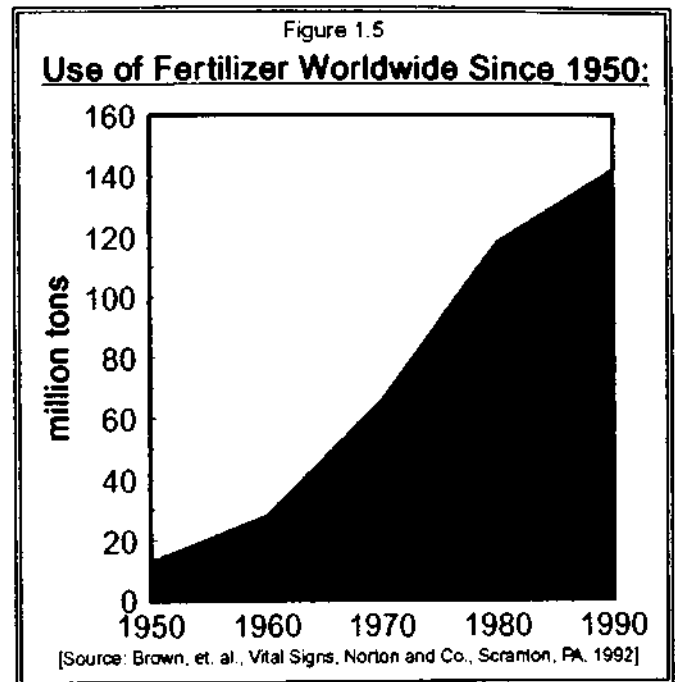
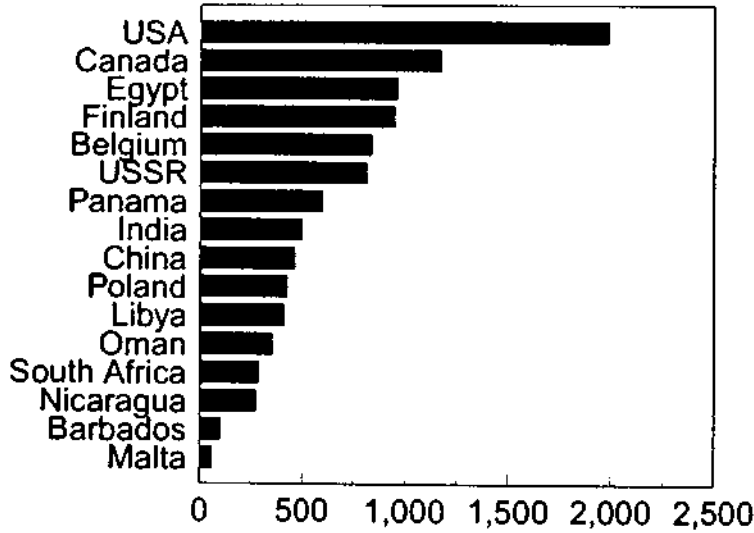


Figure 1.4

**Average Annual Per Capita Water Use in Selected Countries**



Source: World Resources Institute, 1986, World Resources 1986.  
As seen in The Water Encyclopedia, van der Leeden et.al.

using it up, and flushing toilets is one way it's being wasted. Of 143 countries ranked for per capita water usage by the World Resources Institute, America came in at #2 using *188 gallons per person per day* (Bahrain was #1).<sup>20</sup> The use of groundwater in the United States exceeds replacement rates by 21 billion gallons a day<sup>21</sup>. It takes one to two thousand tons of water to flush one ton of human waste (see chapter 4, reference # 43).

The impacts of polluted water are far ranging, causing the deaths

of 25 million people each year, three fifths of them children.<sup>22</sup> Diarrhea, a disease associated with polluted water, kills 6 million children each year in developing countries, and it contributes to the death of up to 18 million people.<sup>23</sup> It's not necessarily the flushing of toilets that's polluting drinking water in developing countries, yet it's still, to a large extent, fecal contamination of water supplies, a problem that could be avoided by composting humanure instead of neglecting to do so. The object is to keep fecal material out of the environment and out of streams, rivers, wells and underground water sources, thereby eliminating the transmission of various diseases. Thermophilic (heat producing) composting will effectively convert fecal material into a hygienically safe humus, yet composting humanure has not become widespread in the West. Instead, human waste continues to pollute the world around us.

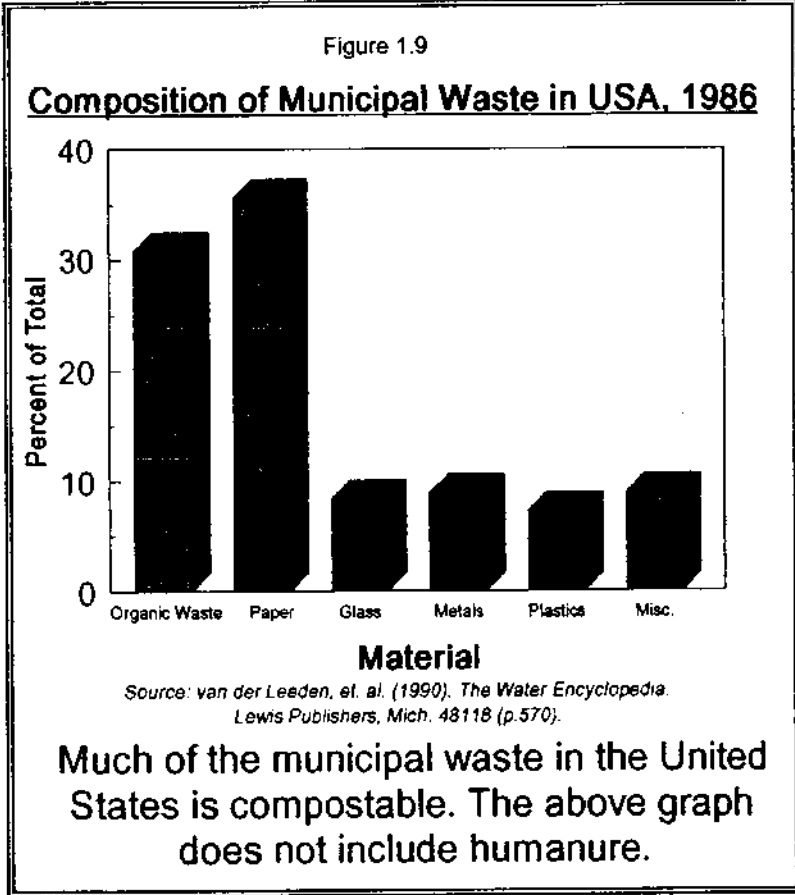
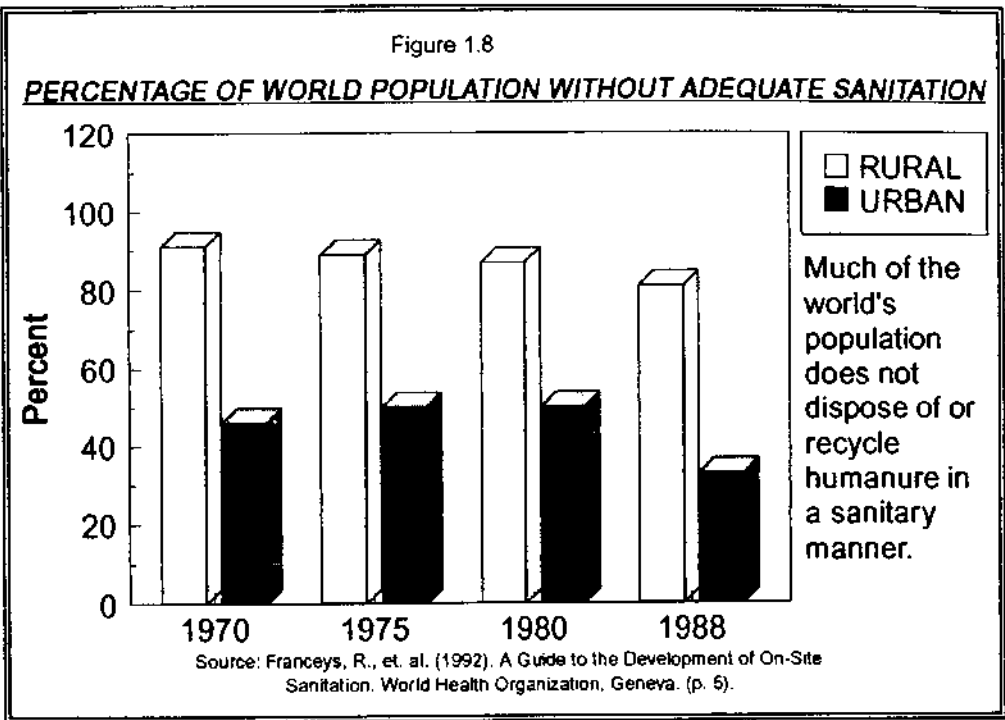
But in the United States haven't we solved the problem of water borne diseases? Largely yes, but not entirely. Illness related to polluted water afflicted 85,875 Americans from 1971-82. Forty-nine percent of these were caused by water treatment deficiencies.<sup>24</sup> Several American cities have suffered from outbreaks of cryptosporidia since 1984, cryptosporidia being protozoa which cause severe diarrhea. These protozoa enter people when they drink water contaminated by infected feces from humans and animals. Outbreaks occurred in Braun Station, Texas in 1984; in Carrollton, Georgia, in 1987; in Medford and Talent, Oregon in 1992; and in Milwaukee in 1993. Hundreds of thousands of people have been afflicted by the bug, for which there is no treatment. The illness runs its course in about fourteen days in healthy people, but can kill people who have weak immune systems.<sup>25</sup>

*Pollution from sewage and synthetic fertilizers results in part from the belief that humanure and food refuse are waste materials rather than recyclable natural resources. There is, however, an alternative. Humanure and food refuse can be composted and thereby rendered hygienically safe for agricultural or garden use.*

Much of the Eastern world recycles humanure. Those parts of the world have known for millennia that humanure is a valuable resource which should be returned to the land, as any animal manure should. The West has yet to arrive at that conclusion.

**WASTE REDUCTION-  
RESOURCE RECOVERY**

According to Sandra Postel (1992), *"The protective ozone shield in heavily populated latitudes of the northern hemisphere is thinning twice as fast as scientists thought just a few years ago. A minimum of 140 plant and animal species are condemned to extinction each day. Atmospheric levels of heat-trapping carbon dioxide are now 26 percent higher than the pre-industrial concentration, and continue to climb. The Earth's surface was warmer in 1990 than in any year since record keeping began in*



the mid-nineteenth century; six of the seven warmest years on record have occurred since 1980. Forests are vanishing at a rate of some 17 million hectares per year, an area about half the size of Finland. World population is growing by 92 million people annually, roughly equal to adding another Mexico each year; of this total, 88 million people are being added in the developing world."<sup>26</sup>

Mr. Lester Brown adds that we're losing 24 billion tons of topsoil each year worldwide, and that areas of global farmland, grassland, and forestland are shrinking and being replaced by wasteland.<sup>27</sup>

It should be added that CO<sub>2</sub> levels are on the increase because of air pollution from the burning of fossil fuels such as coal and petroleum, and that CO<sub>2</sub> and other gaseous pollutants bring us acid rain, acid fog, acid snow, and smog.

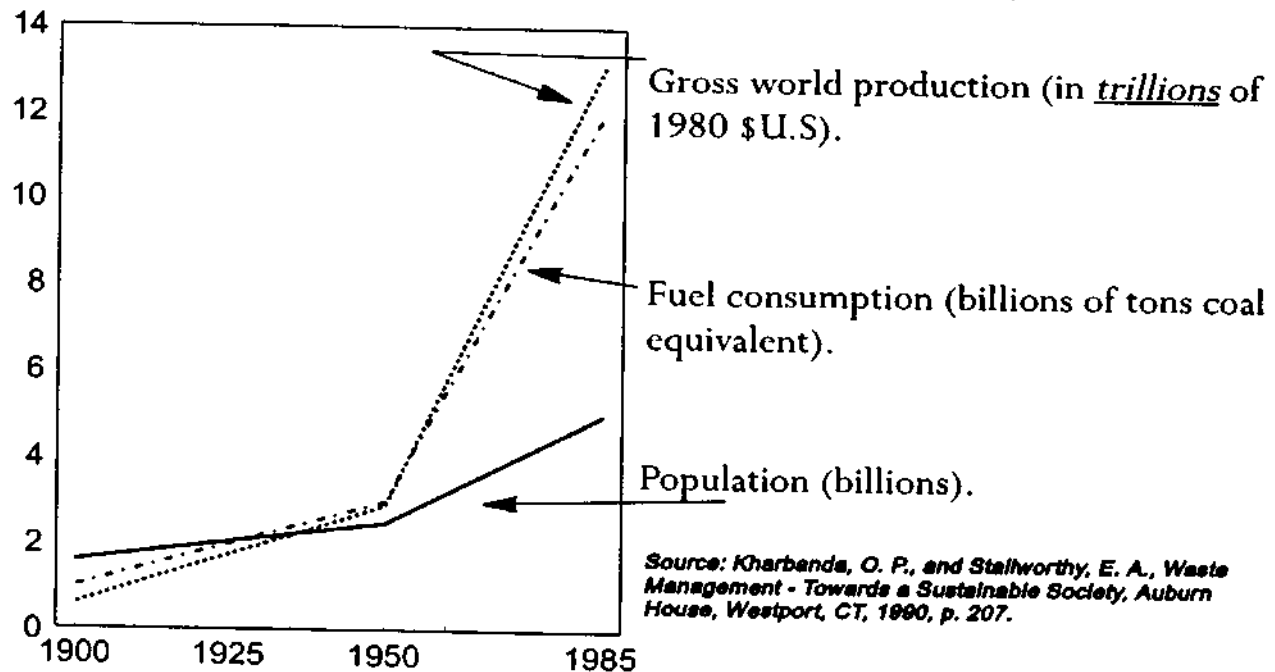
Crap happens. However, we don't inherit the earth, as the saying goes, we borrow it from our children, and we should be stewarding it for our future progeny. That's the sane thing to do. Most humans are sane, and they care about the future, about their children, their own health and their planet's health. The social and environmental problems we're faced with today are caused by poor leadership, lack of political foresight, and fear, greed and corruption caused by power and wealth, or a lack of it. If what Sandra Postel and Lester Brown are saying is true, our resources are dwindling and our ability to support life is slowly but steadily deteriorating. We

Figure 1.10

## Our increasing impact on planet Earth:

World population growth, world production, and world fuel consumption since 1950 are increasing at a rapid rate with no end in sight-

Billions



Source: Kharbenda, O. P., and Stallworthy, E. A., *Waste Management - Towards a Sustainable Society*, Auburn House, Westport, CT, 1990, p. 207.

should do something about that, and we can start with ourselves. What can we do? We can change our *minds*.

What we should be discarding is our throw-away *mentality*. Would it be so difficult to replace such a mentality with one which emphasizes *waste reduction and resource recovery*? “Waste reduction - resource recovery” is a worthy motto to lead us toward a sustainable future. A throw-away society eventually strangles itself in its own waste, while squandering valuable natural resources and energy in the process.

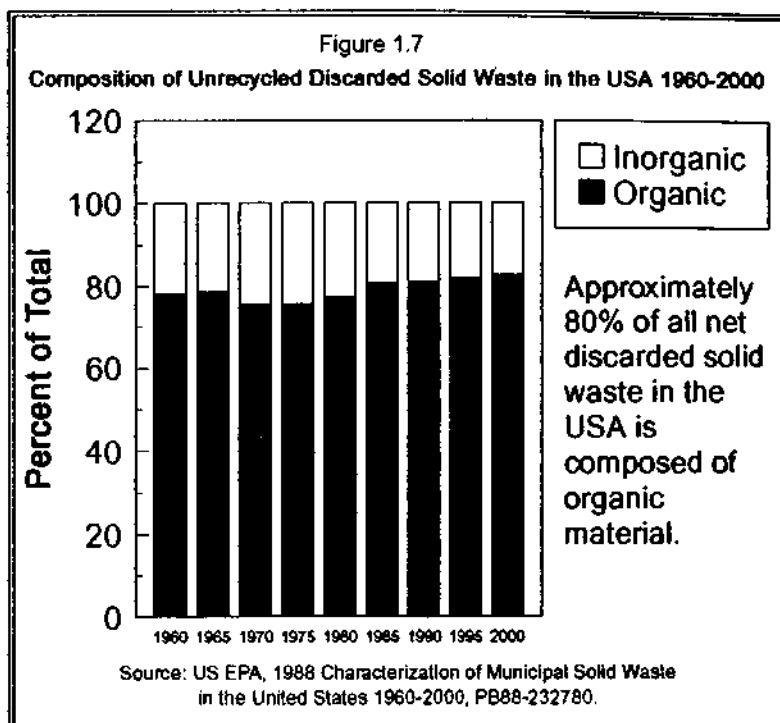
Ironically, the majority of the unrecycled solid waste discarded in the United States is organic waste and could be composted and thereby converted into one of the necessities of life: food.

Our refusal, as humans, to take intelligent responsibility for the recycling of our own nutrients, our own manure and food refuse, indicates a very significant blind spot in our understanding of natural processes.

## WASTE VS. MANURE

Human digestive-system refuse is only waste if it's not recycled. Otherwise, it's manure, and a valuable resource and soil amendment material at that. Farmers never speak of “cow waste”, they speak of cow manure. Nor does one hear of “horse waste” or “pig waste” or “chicken waste”, instead they are all “manures” and for good reason. They aren't wasted. They're returned to the soil as they should be, thereby completing a natural cycle. These manures are valuable fertilizers for the soil, preventing the soil from becoming depleted of nutrients and inoculating the soil with bacteria and microorganisms which give the soil life and vitality.

Let's take a look at the process. Crops are grown, say oats; the oats are harvested and fed to animals, say cows. Now we stand back and wait. Eventually, the oats, which entered the cow's mouth, go through the cow's digestive system and the





Properly composted humanure yields a rich, loamy, pleasant-smelling soil-building material, here being applied to spring garden beds.

lots of money on fertilizers, and keeping his soil healthy. Sounds reasonable enough. But what about *human* manure?

Humanure is a little bit different. It shouldn't simply be flung around in a fresh and repulsive state. It should undergo a process of bacterial digestion first, usually known as *composting*, in order to destroy possible pathogens. This is the missing link in the human nutrient recycling process. The process is similar to a cow's: A human grows food for itself on a field, or in a garden. The food enters the human's mouth and continues on into the digestive system where the body extracts what it needs, rejecting what it doesn't need at the time, or what it can't use. The body then excretes the rejected material.

At that moment the body is no longer responsible for the excretion. The body did its share of the work, now it's time for the mind to go to work. Thinking must now happen. The human mind now has basically two choices - consider the excretion to be waste and try to get rid of it, or consider the excretion to be a resource which must be recycled. Either way, the body's refuse must be collected. As waste, the human waste must be dispensed with in a manner that is safe to human health and to

cow's body takes what it needs from them. What it doesn't need or can't use goes out the other end and plummets to the barn floor as a "cow patty".

Now farmers know that cow manure is valuable. They also know that those cow patties are digested crops, and that crops are soil, water and sunshine converted into food, and the best way to get rid of those patties is to put them back in the field from where they originated. So the farmer loads up the manure spreader and flings the manure back into the fields, thereby cleaning up his barn, saving himself



the environment; as a resource, the humanure must be conscientiously composted to ensure the destruction of potential pathogens, then returned to the soil.

Much of the humanure (also known as "night soil") recycled in Asia is not composted. It's simply applied raw to the fields. *That is not what this book is about.* Raw humanure carries with it a significant element of danger in the form of disease pathogens. Those diseases, such as intestinal parasites, hepatitis, and others, are destroyed by composting, *when the composting process generates heat.* Raw applications of humanure to fields, on the other hand, are not hygienically safe and can assist in the spread of various diseases which may be endemic to areas of Asia where raw humanure is used. Americans who have traveled to Asia tell of the "horrible stench" of raw humanure that wafts through the air when such a material is applied to fields. For these reasons it is imperative that humanure always be composted before agricultural applications. Proper thermophilic (heat producing) composting destroys possible pathogens and results in a pleasant smelling material.

On the other hand, raw night soil applications to fields in Asia return humanure to the land and thereby do recover a valuable resource which is used to produce human food. *Composted* humanure is used in Asia as well. Cities in China, South Korea and Japan recycle humanure where it's returned to the land around the cities in greenbelts where vegetables are grown. Shanghai (China), a city which had a population of nearly 11 million people in 1970<sup>28</sup>, produces an exportable surplus of vegetables in this manner.

Humanure can also be used to feed algae which can in turn feed fish for aquacultural enterprises. In Calcutta, such an aquaculture system produces 20,000 kilograms of fresh fish daily.<sup>29</sup> The city of Tainan, Taiwan, is well known for its fish, which are farmed in over 6,000 hectares of fish farms fertilized by humanure. Here humanure is so valuable that it's sold on the black market.<sup>30</sup>

Furthermore, humanure can be mixed with other organic refuse from human activity such as kitchen and food scraps, grass clippings, leaves, garden refuse, and sawdust. When composted, this blend of nutrients can yield a balanced, loamy, rich, pleasant-smelling and hygienically safe soil additive suitable for food gardens as well as for agriculture.

The following chapters discuss the roots of the cultural bias against the recycling of humanure that we Westerners are burdened with. The amazing phenomenon of compost is also discussed, as it is the obvious alternative to organic waste disposal. Various conventional waste disposal systems currently in use, such as sewers and septic systems, are looked at, and a more detailed analysis of their environmental shortcomings is given. Common composting toilets, including home-made as well as store-bought ones, are also looked at, as are simple humanure composting systems

(which focus more on the composting and less on the toilet). The issue of human pathogens associated with humanure is closely scrutinized. Finally, a low-impact, largely technology-free system of humanure composting (the sawdust toilet) is discussed in detail.

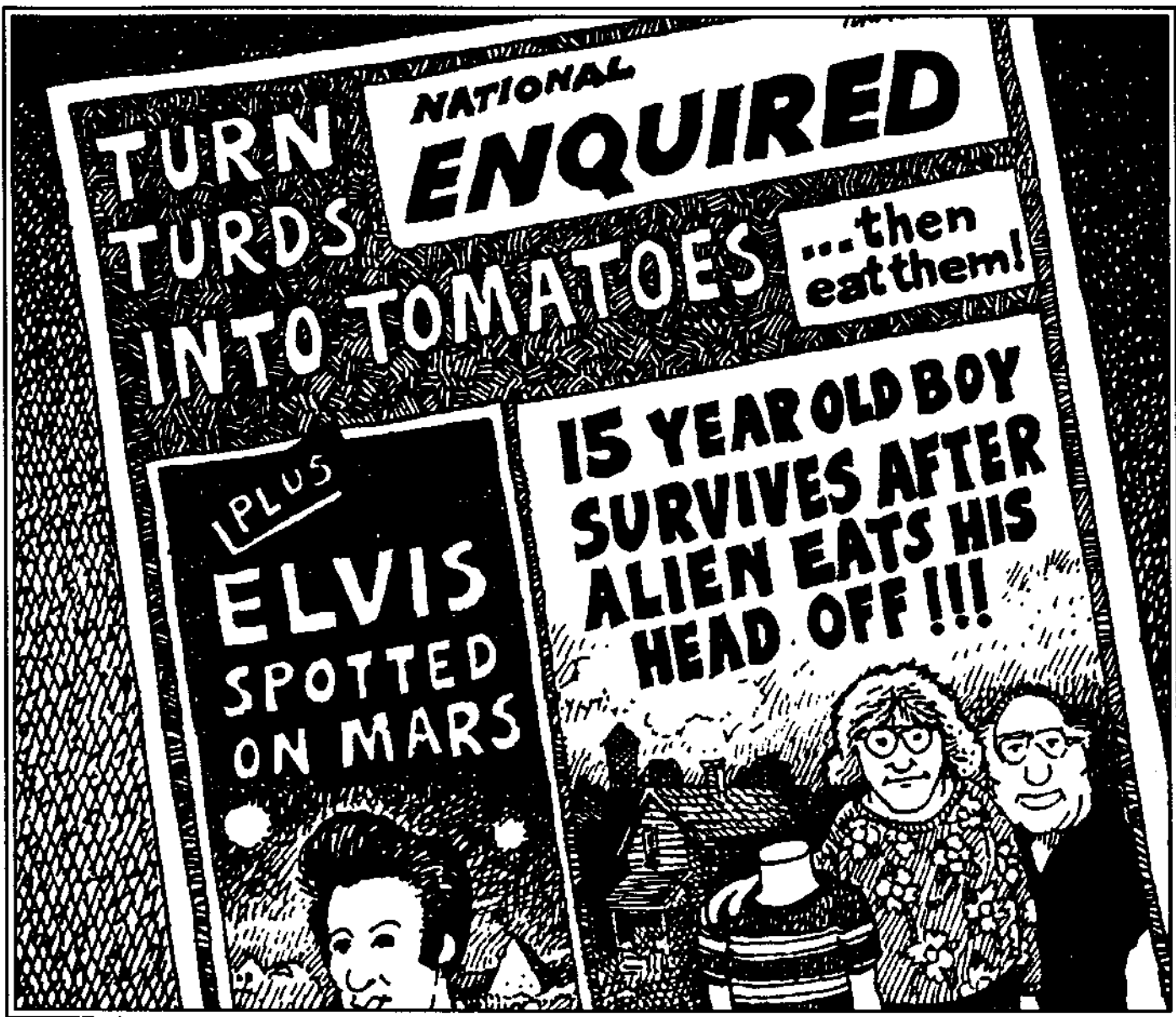
### ***EXPERIENCE HELPS***

Allow me to interject here that I'm not advocating the composting of humanure based on theory. In fact, I have composted all of my family's humanure since 1979 (fifteen continuous years at the time of this writing) on our rural homestead using a very simple, low-impact, low-technology system (a *sawdust toilet*). The resulting compost has always been used in our food garden.

I've had an unusual opportunity to experiment with the composting of humanure, and this experience has yielded for me an abundance of empirical data. My experiences have made me confident that humanure can be easily and safely composted using only the simplest methods, yielding a valuable soil additive from what would otherwise be putrid and dangerous waste. By no means do I claim to have all the answers. But I do hope to at least be able to provide a *starting point* for those of you who seek information about composting humanure. Perhaps this book will shed a small ray of light onto what is otherwise a vacuum of information.

## REFERENCES - CHAPTER 1

- 1 - Hammond, A., et. al. (Eds.). 1993 Information Please Environmental Almanac. Compiled by World Resources Institute. Houghton Mifflin Co. New York. 1993. (pp.50-51 and 339).
- 2 - Ibid. (pp.60-64).
- 3 - Daniel, J.E., et. al, editors. 1992 Earth Journal. Buzzworm Books. Boulder CO. (p.94).
- 4 - Fahm, L.A., (1980). The Waste of Nations. Allenheld, Osmon & Co. Montclair, NJ. (p.45).
- 5 - Environmental Reporter. 7/31/92 (p.1110). Bureau of National Affairs, Inc. Washington D.C.
- 6 - Environmental Reporter. 11/22/91 (p.1799).
- 7 - Environmental Reporter. 1/3/92 (p.2103).
- 8 - Environmental Reporter. 1/17/92 (p.2144).
- 9 - Env. Rep. 2/14/92 (p.2373).
- 10 - Env. Rep. 12/27/91 (p.2072).
- 11 - Env. Rep. 5/1/92 (p.13).
- 12 - Env. Rep. 11/8/91 p.1745-46 and 1/31/92 (p.2299)
- 13 - Golden, Jack. et. al. (1979). The Environmental Impact Data Book. Ann Arbor Science Publishers, Inc., PO Box 1425, Ann Arbor, Michigan 48106. (p. 495).
- 14 - Fahm, L.A., (1980). The Waste of Nations (p.46), see previous listing.
- 15 - 1992 Earth Journal, (p.159).
- 16 - Env. Rep. 4/24/92 (p.2877-78).
- 17 - Env. Rep. 2/28/92 (p.2439).
- 18 - 1992 Earth Journal, (p.159).
- 19 - Sides, S., Compost. The Mother Earth News. Aug/Sept. 1991. Issue 127. (p.50).
- 20 - Beyond Oil: The Threat to Food and Fuel in the Coming Decades. A Summary Report. November, 1986. Carrying Capacity Inc. 1325 G Street NW, Suite 1003, Wash. D.C. 10005.
- 21 - 1993 Information Please Environmental Almanac. (pp.340-341).
- 22 - Toward Organic Security: Environmental Restoration or the Arms Race?. Peace and Environment Platform Project, c/o World Citizens Assembly, Suite 506, 312 Sutter St., San Francisco, CA 94018.
- 23 - Courier. January, 1985. UNESCO. 7 Place de Fentenoy 75700 Paris, France.
- 24 - EPA Journal. Vol. 12 No. 7, September 1986, and Vol. 11 No. 7, September 1985, USEPA Office of Public Affairs, Wash. D.C. 20460.
- 25 - Associated Press, as seen in the Observer-Reporter (Washington and Green Counties, PA), Saturday, April 10, 1993. (p.A2).
- 26 - Brown, L.R. et. al. State of the World 1992. W.W. Norton & Co. New York. (p.3).
- 27 - Brown, L.R. et. al. State of the World 1990. (p.3).
- 28 - Mitchell, B. R. (1982) International Historical Statistics of Africa and Asia. New York University Press, New York, NY, 10003.
- 29 - State of the World 1990 (p.184).
- 30 - Rybczynski, W. et. al. (1982). Low Cost Technology Options for Sanitation - A State of the Art Review and Annotated Bibliography. World Bank. (p.23).



## MICROHUSBANDRY

### *Harnessing the Power of Microscopic Organisms*

*“Making compost is an art rather than a science. To go about it mechanically, merely following rules, not only will not yield the best results, but the work will not be as enjoyable.”*

J. I. Rodale



**T**here are essentially four ways to deal with human excrement. The first is to *dispose of it*. People do this by defecating in water, or in outhouses or latrines. Most of this excrement ends up wasted, buried in the ground, or becomes a source of pollution. The second way to deal with human excrement is to *apply it raw to agricultural land*. This is popular in Asia where “night soil”, or raw human excrement, is spread on fields. Although this keeps the soil enriched, it acts as a vector, or route of transmission, for disease organisms. The third way to deal with human excrement is to *slowly compost it over an extended period of time*. This is the way of most commercial composting toilets and mouldering toilets. Slow composting generally takes place at temperatures below that of the human body (98.6 °F or 37°C). This method of composting eliminates most disease organisms in a matter of months, and should eliminate all human pathogens eventually, although some sources suggest that the total destruction of pathogens may require a period of up to ten years. Slow composting or mouldering, however, creates a useful soil additive that is at least safe for ornamental gardens or orchard use. The fourth way to deal with human excrement is to *thermophilically compost it*.

Thermophilic composting involves the cultivation of thermophilic (heat loving, or heat producing) microorganisms in the initial stage of the composting process. These bacteria and fungi can produce heat sufficient to destroy the disease organisms (human pathogens) that may be present in humanure. Thermophilic composting can render humanure into a friendly, pleasant-smelling, humus safe for food gardens. It's this type of composting which is the primary focus of this book, and this focus is not to be confused with the other three ways of dealing with human excrement. Thermophilically composted humanure is somewhat different from mouldered humanure, and *entirely different from night soil*.

What is compost anyway? I'm glad you asked that question. I remember

when I first moved out to the country and started living off the land at the age of 22. I was fresh out of college, so naturally I knew very little. One word that was a mystery to me was “compost”, another was “mulch”. I didn’t know what either of these things were, I only knew they had something to do with organic gardening, and that’s what I intended to learn about. Of course, it didn’t take me long to understand mulch. Anybody who can throw a layer of straw on the ground can mulch. But compost took a little longer.

Making compost is sort of like making bread, or maybe wine. My compost-learning experiences were a parallel of my wine-making experiences. Back then, having just graduated from the university, I had been conditioned to believe that everything had to be learned by using books. I had little awareness that instinct or intuition were powerful teachers. It seemed I was expected to believe that humans were the only thing in the universe with intelligence, and everything in nature was somehow below us. Furthermore, simple, natural processes had to be complicated with charts, graphs, measurements, devices, and all the wonderful tools of science, otherwise the processes had no validity. It was with this attitude that I set out to learn how to make wine.

Of course, the first thing I did was obtain a very scientific book replete with charts, graphs, tables, and detailed, step by step procedures. The book was titled something like “Foolproof Winemaking” and the trick, or so the author said, was simply to follow his procedures *to the letter*. This was no simple feat. The most difficult part of the process was acquiring the list of chemicals which the author insisted must be used in the winemaking process. After much searching and travel I managed to get the required materials and I then followed his procedures *to the letter*. This lengthy process involved boiling sugar, mixing chemicals etc. To make a long story short, I did succeed in making two kinds of wine in this way. Both tasted like hell though, and had to be thrown out. I was very discouraged.

It wasn’t too long after that when a friend of mine, Bob, decided he would try his hand at winemaking. Bob and I had a friend, Jim, who worked at a Pennsylvania vineyard, and Jim offered to bring Bob five gallons of grape juice for a try at the oenologist’s art. Jim, being the good sport that he is, even brought the juice in a five gallon glass winemaking container (carboy) with an airlock already on top of it (to allow fermentation gasses to escape while preventing air from entering). When he got the grape juice to Bob’s house, Bob took one look at the heavy carboy of juice and said, “*Jim, would you mind carrying that into the basement for me?*” Which Jim obligingly did. That was it. That utterance constituted Bob’s entire effort at winemaking. Two seconds of flapping jaws is the only work Bob did toward making that wine. He added no sugar, no yeast, did no racking, certainly used no chemicals. He didn’t

do a damn thing to that five gallons of grape juice except abandon it in his basement. And yet, that turned out to be the best homemade wine I had ever drunk. It tasted good and had a nice kick to it too. It was superb.

Now, I admit, there was an element of luck there, but I learned an important lesson about winemaking: the basic process is very simple - start with good juice and keep the air out of it. That simple, natural process can easily be ruined by complicating it with scientific procedures, and heck, all those charts and graphs took the *fun* out of it. Making compost is exactly the same sort of phenomenon.

## NATURALCHEMY

What exactly *is* compost, you ask again? According to Webster, compost is “a mixture of decomposing vegetable refuse, manure, etc. for fertilizing and conditioning the soil.” To compost means to convert organic refuse into soil or humus. Humus is a brown or black substance resulting from the decay of organic animal or vegetable refuse. Organic refuse could be considered anything on the Earth’s surface that had been recently alive, or from a living thing, such as manure, plants, leaves, sawdust, peat, straw, grass clippings, food scraps, urine etc. A rule of thumb is that anything that will rot will compost. In some cases, even petroleum products are compostable.

In the Middle Ages alchemists sought to change base metals into gold. Old German folklore tells of a tale in which a dwarf named Rumpelstiltskin had the power to spin flax straw into precious metal. Somewhere in the psyche of the Western society was a belief that substances of little or no worth could be transmuted by a miraculous process into materials of priceless value. Our ancestors were right, but they were barking up the wrong tree. The miraculous process of thermophilic *composting* will transmute humanure into humus. In this way, a dangerous waste material becomes a soil additive vital for the processes of human life.

Our ancestors didn’t understand that the key to this alchemy was right at their fingertips. Had they better known and understood natural processes they could have provided themselves with a wealth of soil fertility and saved themselves the tremendous suffering caused by diseases originating from fecal contamination of the environment. For some reason they believed that gold embodied value, and in pursuit of glittering riches they neglected the things of real value in life: health, vitality, self-sufficiency, sustainability.

Their ignorance involved microbiology. Our ancestors had little understanding of a vast, invisible world which surrounded them, a world of billions of creatures

so small as to be quite beyond the range of human sight. And yet, some of those microscopic creatures were already being used to do work for humanity in the form of the fermentation of foods such as beer, wine or bread dough. Although *yeasts* have been used by people for centuries, *bacteria* have only relatively recently become harnessed by Western humanity. Composting is one means by which the power of bacteria can be utilized in a big way for the betterment of humankind. Unfortunately, our ancestors didn't understand the role of microorganisms in the decomposition of organic matter, and the efficacy of microscopic life in converting humanure, food scraps, plant residues and the like into soil. They didn't understand compost.

The decomposition of organic materials requires armies of bacteria which work so hard digesting (decomposing) the refuse they heat the stuff up. Other micro and macro organisms such as fungi and insects help in the composting process, too. When the compost cools down, earthworms often move in and eat their fill of delicacies, their excreta becoming a further refinement of the compost.

And so, successful composting requires the maintenance of an environment in which bacteria and fungi can thrive. Same for wine, except the microorganisms are yeast, not bacteria. Same for bread (yeast), beer (yeast), yogurt (bacteria), sauerkraut (bacteria); all of these things require the cultivation of microorganisms which do the work you want done. All of these things involve simple processes which, once you know the basic principles, are easy to carry out successfully. Sometimes bread doesn't rise, sometimes yogurt turns out watery, sometimes compost doesn't seem to turn out right. When this happens, a simple change of procedure will rectify the matter. Once you get the hang of it, you'd think that even a chimpanzee could be trained to make compost.

Often, in our household, we have yogurt being made by millions of hard-working bacteria in a few quart mason jars beside the cookstove. At the same time, millions of yeast cells are cheerfully brewing beer in carboys in the back pantry, millions more yeasts are happily brewing wine beside the beer, sauerkraut is blithely fermenting in a crock behind the stove, bread is rising on the kitchen counter, and fungi are tirelessly forcing their fruits from oak logs on the sunporch. And then there's the compost pile. At times like these, I feel like a real slave driver. But the workers never complain. Those little fellas work day and night, and they do a real nice job.

Making compost and using it agriculturally has its advantages. The end product of compost making, *humus*, consists of broken down organic matter that is the basis of soil life. Humus holds moisture, and therefore increases the soil's capacity to absorb and hold water. Compost is said to hold nine times its weight in water (900%), as compared to sand which only holds 2%, and clay 20%.<sup>1</sup> Compost also adds slow-release nutrients essential for plant growth, creates air spaces in soil, helps balance

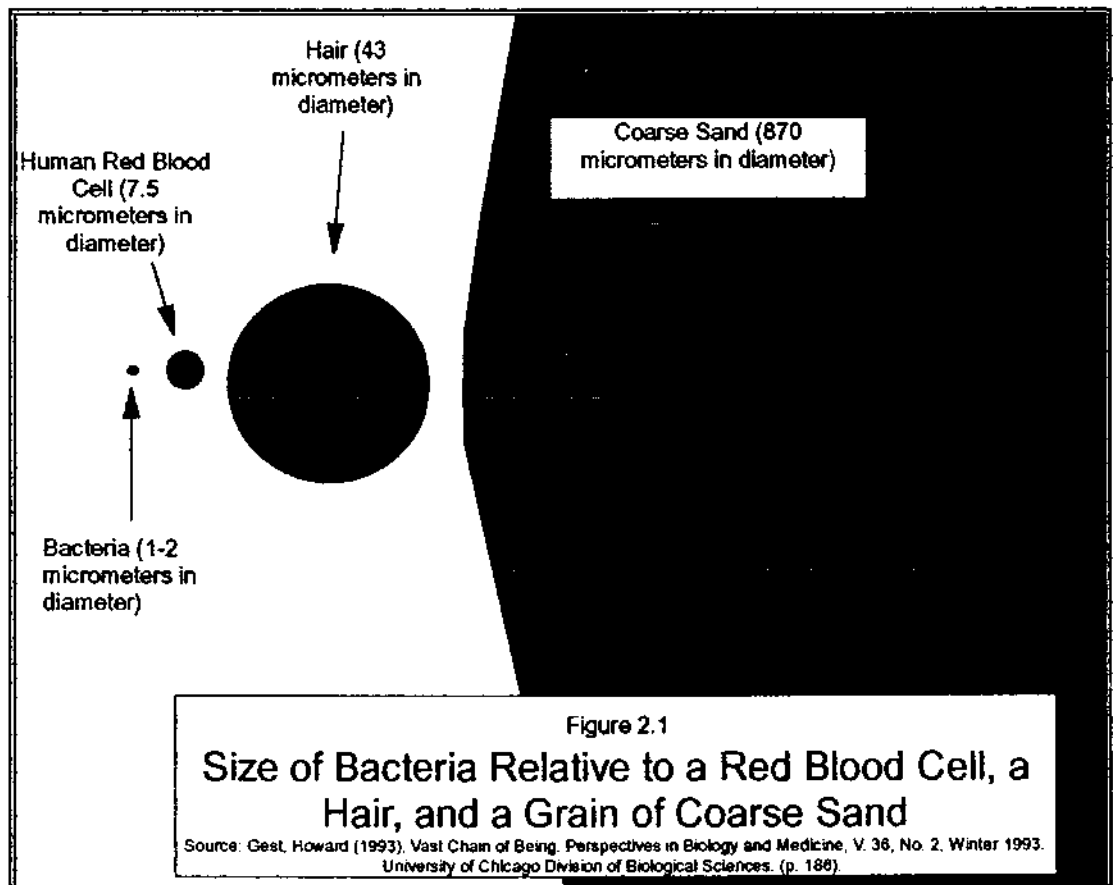


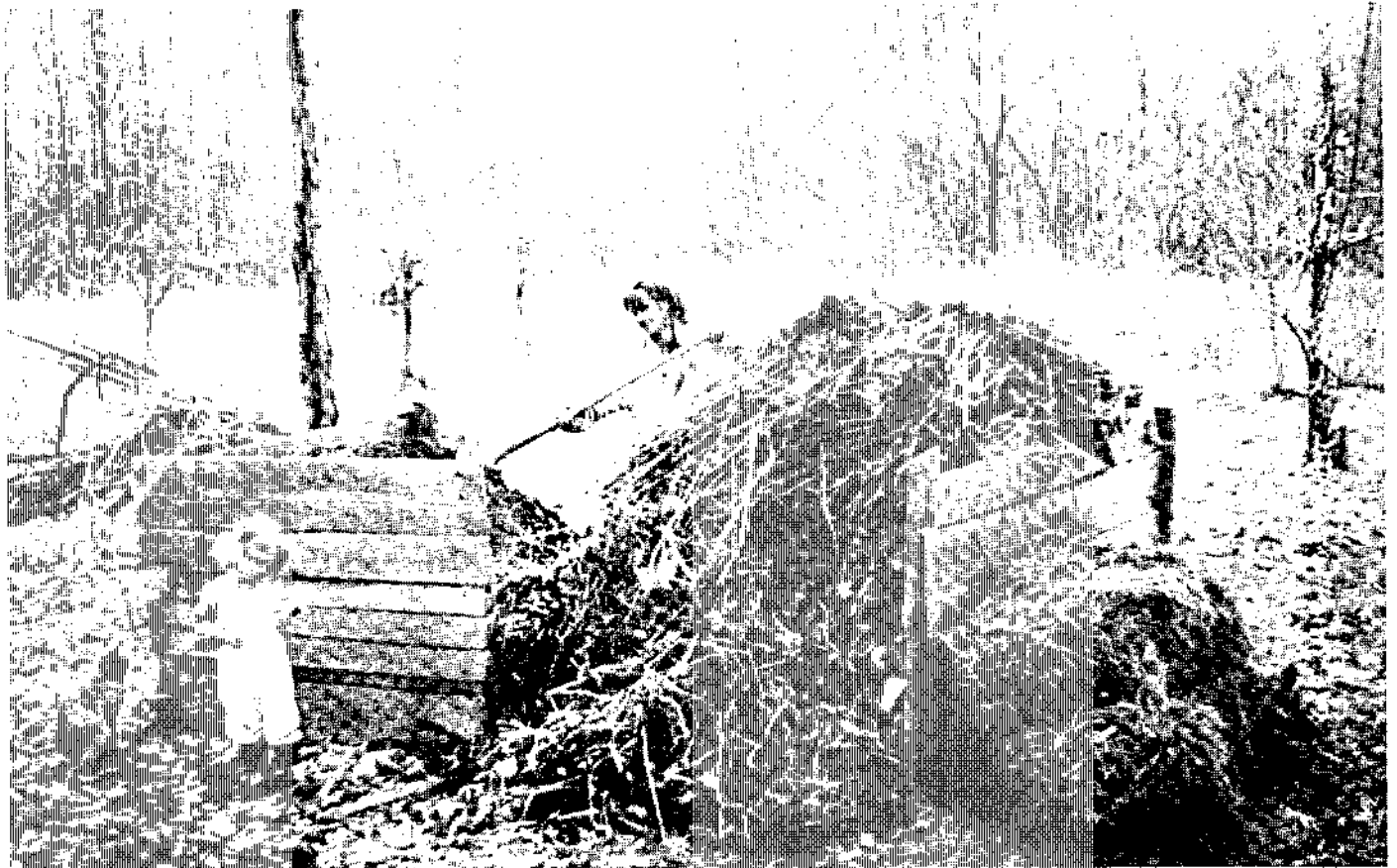
the soil pH, darkens the soil and thereby helps it absorb heat, and supports microbial populations that add life to the soil.

The building of topsoil by Mother Nature is a centuries long process. Adding compost to soil will help to quickly restore fertility that might otherwise take nature hundreds of years to replace. We humans deplete our soils in relatively short periods of time. We can restore that fertility also in relatively short periods of time by composting our organic refuse and returning it to the land.

Another way to look at it is by seeing organic refuse as stored solar energy. Every apple core or potato peel holds a tiny amount of stored energy, converted into useable plant food by the compost pile. Perhaps S. Sides of the *Mother Earth News* states it more succinctly: *"Plants convert solar energy into food for animals (ourselves included). Then the [refuse] from these animals along with dead plant and animal bodies, 'lie down in the dung heap,' are composted, and 'rise again in the corn.' This cycle of light is the central reason why composting is such an important link in organic food production. It returns solar energy to the soil. In this context such common compost ingredients as onion skins, hair trimmings, eggshells, vegetable parings, and even burnt toast are no longer seen as garbage, but as sunlight on the move from one form to another."*

Adding compost to soil helps control plant diseases. Studies in 1968 by researcher Harry Hoitink indicated that compost, by adding beneficial microorganisms to the soil, inhibited the growth of disease-causing microorganisms in greenhouses. In 1987, he and a team of scientists took out a patent for compost that could reduce or suppress plant diseases caused by





Finished compost is being removed from a double chambered compost bin.

The large pile of refuse in the chamber on the right is undergoing thermophilic decomposition, and represents nearly a year's worth of accumulated material, including humanure. When finished, it will shrink to half its size.

Clean hay is stacked against the right side of the bin to be used as cover material.

three deadly microorganisms: *phytophthora*, *pythium*, and *fusarium*. Growers who used this compost in their planting soil reduced their crop losses from 25-75% to 1% without applying fungicides. The studies suggested that sterile soils could provide optimum breeding conditions for plant disease microorganisms, while a rich diversity of microorganisms in soil, such as that found in compost, would render the soil unfit for the proliferation of disease organisms.<sup>3</sup>

Besides helping to control soil diseases, compost helps control nematodes, attracts earthworms, and aids plants in producing growth stimulators.<sup>4</sup> It can also destroy some toxic wastes. One man who composted a batch of sawdust contaminated with diesel oil said, "*We did tests on the compost, and we couldn't even find the oil!*" The compost had apparently "eaten" it all.

Composting also seems to be able to decontaminate soil polluted with TNT

from munitions plants. The microorganisms in the compost digest the hydrocarbons in TNT and convert them into carbon dioxide, water, and simple organic molecules. Furthermore, some bacteria “eat” uranium. Derek Lovley, a microbiologist, has been working with a strain of bacteria that normally lives 650 feet under the earth’s surface. These microorganisms will eat, then excrete, uranium. The chemically altered uranium excreta becomes water insoluble as a result of the microbial digestion process, and can consequently be removed from the water it was contaminating.<sup>5</sup>

An Austrian farmer claims that the microorganisms he introduces into his fields have prevented them from being contaminated by the radiation from Chernobyl, the ill-fated Russian nuclear power plant, which contaminated his neighbor’s fields. Sigfried Lubke sprays his green manure crops with compost-type microorganisms just before plowing them under. This practice has produced a soil rich in humus and teeming with microscopic life. After the Chernobyl disaster, crops from fields in Lubke’s farming area were banned from sale due to high amounts of radioactive cesium contamination. However, when officials tested Lubke’s crops, no trace of cesium could be found. The officials made repeated tests because they couldn’t believe that one farm showed no radioactive contamination while the surrounding farms did. Lubke thinks that the humus just “ate up” the cesium.<sup>6</sup>

Finally, fertile soil yields food that promotes good health. One group of people, the Hunzas of northern India, has been studied to a great extent. One man who studied them extensively, Sir Albert Howard, stated, *“When the health and physique of the various northern Indian races were studied in detail the best were those of the Hunzas, a hardy, agile, and vigorous people, living in one of the high mountain valleys of the Gilgit Agency. . . There is little or no difference between the kinds of food eaten by these hillmen and by the rest of northern India. There is, however, a great difference in the way these foods are grown. . . [T]he very greatest care is taken to return to the soil all human, animal and vegetable wastes [sic] after being first composted together. Land is limited: upon the way it is looked after, life depends.”* We’ll take another look at the Hunzas in chapter six.

## GOMER THE PILE

Back to the compost pile. Notice I said “pile”. Refuse is usually piled up in bins, racks, pits, drums or what have you. There are three basic reasons for piling the composting refuse. First, it keeps the pile from drying out or cooling down prematurely. A level of moisture (50-60%) is necessary for the bacteria to work happily.<sup>8</sup> A vertical stack prevents leaching, prevents waterlogging, and holds heat in the pile.

Vertical walls around a pile, especially if they're made of wood, keep the wind off and will prevent one side of the pile (the windward side) from cooling down prematurely.

Secondly, a neat, contained pile just plain looks better. It looks like you know what you're doing, instead of looking like a garbage dump.

Thirdly, a pile makes it easier to layer, or cover over the compost. It's a good idea to cover the pile with clean refuse when a smelly deposit is added to the top, in order to eliminate unpleasant odors and to trap necessary oxygen in the pile. Therefore, if you're going to compost your refuse, don't just fling it out in your yard in a heap. Construct a nice little bin and do it right. That bin doesn't have to cost money, it can be made from recycled wood or cement blocks. Wood may be preferable as it'll insulate the pile and prevent heat loss and frost penetration. A compost bin doesn't have to be complicated in any way. It doesn't require electricity, technology, gimmicks or doodads. You don't need shredders or choppers, grinders or any machines whatsoever.

Compost *pits* are more likely to be used in dry, arid or cool climates where conservation of moisture and temperature is imperative. The main disadvantage of pits is that they can become waterlogged in the event of an unexpected cloudburst, and excessive water will rob the pile of oxygen, a critical element in the process of decomposition by aerobic microorganisms. When pits are used, therefore, a roof over them may be an advantage.

What sort of environment does the bacterial community like? As stated, the compost must be moist. A dry pile will not work. When composting humanure, the urine provides quite a bit of the necessary moisture. Other moisture comes from food scraps. In some cases, a compost pile may have to be watered. This would most likely occur in a very dry climate where the pile may also require a roof over it to reduce dehydration. In Pennsylvania, where I live, we have ample rainfall (35 inches per year, nearly one meter) and my compost never dries out, unless during an unusual drought. It is never covered by a roof and leaching has never been a problem. I've rarely had to water my compost. On the other hand, we compost all of our refuse, including our urine. We use rotting hardwood sawdust in our waterless sawdust toilet as an odor-preventing cover material, which also soaks up the urine to create a good moisture balance. Compost should be moist, not wet.

The amount of moisture a compost pile receives or needs depends on the materials put into the pile and on the location of the pile. According to Sir Albert Howard, watering a compost pile in England where the annual rainfall is 24 inches is also unnecessary. Nevertheless, the water required for compost-making may be around 200 to 300 gallons for each cubic yard of finished compost.<sup>9</sup> This moisture

requirement will be met when human urine is used in the compost and the top of the pile is open and receiving adequate rainfall. If adequate rainfall is not available and the contents of the pile are not moist, watering will be necessary to produce a moisture content equivalent to a squeezed out sponge.

The bacteria we want to cultivate in the compost pile in order to ensure thermophilic decomposition are *aerobic* and they will suffer from a lack of oxygen if drowned in liquid. Bacterial decomposition can also take place anaerobically, but this is a slower, cooler process, which can, quite frankly, stink.

A good, healthy, aerobic compost pile need not offend one's sense of smell. However, in order for this to be true, one simple rule must be followed: anything added to the compost collection that smells bad must be covered with clean organic material. This means in your compost toilet, this means on your compost pile. Shit stinks, I don't care what Adelle Davis\* said. When you defecate or urinate in your toilet, cover it. Use sawdust, use peat, use clean soil, use leaves, but keep it covered. Then there will be no odor. When you deposit smelly manure on your compost pile, cover it. Use weeds, use straw, use hay, whatever you can get your hands on (especially bulky material which will trap oxygen), but keep it covered. That's the secret. That's all there is to it (the smell issue, that is).

Dehydration will cause your bacteria to go on strike and stop working. So will freezing. Compost piles will not work if frozen, as during the cold winters of the north. However, don't despair, the bacteria will wait until the temperature rises and then they'll work like hell. I continue to add to my outdoor compost pile all winter, even when the pile is frozen solid as a rock. The freezing stage helps to destroy potential pathogens, and after the thaw, the pile works up a steam as if nothing happened. (See page 164, and appendix 4 on page 187, for charts showing the rise of temperature after a frozen pile thaws.)

Actually, I consider this whole process to be one of the miracles of nature. I take humanure with urine mixed in sawdust from our low-impact toilet, buckets of food scraps from the kitchen, armfulls of weeds from the garden, and anything else on hand, and layer it all onto a pile where it's transformed into a rich loamy garden soil before my eyes. The final product looks and smells like a beautiful soil. This process requires no electricity, no technology, no bells or whistles, no heaters, and no dancing girls. It's a model of simplicity,

*The top of a compost pile should be kept somewhat flat.* Keep a garden utensil handy to the compost bin for this purpose. I use an old hay fork with a broken handle. The short handle is long enough to rake the top of my pile. The flat top collects water and prevents leaching. It makes it easier to layer things on the pile. Things don't roll

off a flat-topped pile. This is just a simple and standard maintenance procedure. If the pile is frozen and can't be flattened, don't worry about it. When it thaws, flatten the top. Don't overdue it though, as your thermophiles may not like being disturbed!

Don't be confused by layering. Layering occurs naturally. Every time you add something to your pile you're adding another layer. No, you don't have to stir these layers up. Many people believe that you do, but you don't.

Don't be confused about mixing and blending the compost. This happens naturally when you add all of your organic refuse to the same compost pile, including humanure. By adding a variety of materials to the pile, you are creating a mix of ingredients, trapping oxygen into the pile, balancing nutrients, and eliminating the need to turn or stir the pile. If the bacteria like your compost, they'll heat the pile up and won't want to be disturbed by turning or stirring. If they don't like your compost, it's more than likely you're not adding a mix of materials to the pile. One can't just defecate in a 55 gallon drum, throw lime on it and expect it to compost. This is the single most common mistake I've seen made by people trying to compost humanure. They think humanure is dangerous and must be isolated, quarantined from all other compost. This is ironic, as the potential dangers of humanure are most effectively eradicated by thermophilic composting. To get a good, hot pile, you need organic material such as kitchen scraps, garden weeds, and maybe some hay or straw or leaves layered with your manure. These rough materials create interstitial air spaces in the pile that aid the aerobic digestion. They create a good blend of nutrients for the microbes. Think about it, how would *you* like it if you had only crap to eat?

## ***THE CARBON/NITROGEN RATIO***

One way to look at the blend of ingredients in your compost pile is by using the C/N ratio, the carbon/nitrogen ratio. Quite frankly, the chance of anyone measuring and monitoring the carbon and nitrogen quantities of their refuse is almost nil. This is like making wine the "foolproof" way. If composting requires this sort of drudgery, no one would do it.

However, I've found that by using all of the organic refuse my family produces, including humanure, urine, food refuse, weeds from our garden, rotting sawdust (which is hauled in), and maybe a little straw or hay now and then, we get the right mix of carbon and nitrogen for successful thermophilic composting.

Nevertheless, no discussion of composting is complete without a review of the subject of the carbon/nitrogen ratio. A good C/N ratio for a compost pile is between 20/1 and 35/1.<sup>10</sup> That's 20 parts of carbon to one part of nitrogen, up to 35

**Table 2.1**  
**Composition of Humanure**

*Fecal Material -*

0.3-0.6 pounds per person per day, or 135-270 grams, wet weight.

Organic Matter (dry weight).....	88-97%
Moisture Content .....	66-80%
Nitrogen.....	5-7%
Phosphorous.....	3-5.4%
Potassium.....	1-2.5%
Carbon.....	40-55%
Calcium.....	4-5%
C/N Ratio.....	5-10

*Urine-*

1.75-2.25 pints per person per day (1.0-1.3 liters)

Moisture.....	93-96%
Nitrogen.....	15-19%
Carbon.....	11-17%
Calcium.....	4.5-6%
Potassium.....	3.0-4.5%
Phosphorous.....	2.5-5%

Source: Gotaas, *Composting*, (1956), p. 35

parts of carbon to one part of nitrogen. Or, for simplicity you can figure on shooting for an optimum 30/1 ratio.

The reason this ratio is good is because the microorganisms that digest the compost need 30 parts of carbon for every part of nitrogen they consume. If there's too much nitrogen and not enough carbon, the microorganisms can't use the excess nitrogen. Then the excess nitrogen is lost in the form of ammonia gas, which you can

smell. Nitrogen loss due to excess nitrogen in the pile (a low C/N ratio) can be over 60%. At a C/N ratio of 30 or 35 to 1, only one half of one percent of the nitrogen will be lost. That's why you don't want too much nitrogen in your pile: you'll lose a lot of it in the form of ammonia gas, and nitrogen is too valuable for plants to allow it to go to waste (see Table 2.3).<sup>11</sup>

**Table 2.3**

**NITROGEN LOSS AND C/N RATIO**

Initial C/N Ratio	Nitrogen Loss %
20 .....	38.8
20.5 .....	48.1
22 .....	14.8
30 .....	.05
35 .....	.05
76 .....	-8

Source: Gotaas, *Composting*, 1956, p. 92

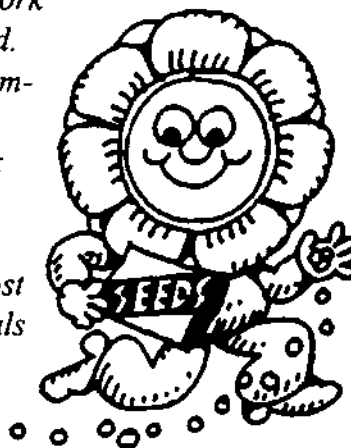
*The C/N ratio of humanure is between 5 and 10, or roughly around*

Table 2.2 (Source: Gotaas, *Composting*, 1956, p. 44)

## Carbon/Nitrogen Ratios for Some Compostable Materials

MATERIAL	% N	C/N RATIO		MATERIAL	% N	C/N RATIO
Urine	15-18	0.8		Grass Clippings	2.4	19
Humanure	5-7	5-10		Amaranth	3.6	11
Activated Sludge	5-6	6		Lettuce	3.7	----
Rotted Sawdust	0.25	208		Cabbage	3.6	12
Raw Sawdust	0.11	511		Tomato	3.3	12
Wheat Straw	0.3	128		Onion	2.65	15
Oat Straw	1.05	48		Pepper	2.6	15
Timothy Hay	0.85	58		Turnip Tops	2.3	19
Poultry Manure	6.3	----		Raw Garbage	2.15	25
Sheep Manure	3.75	----		Bread	2.10	----
Pig Manure	3.75	----		Seaweed	1.9	19
Horse Manure	2.3	----		Red Clover	1.8	27
Farmyard Manure	2.25	14		Whole Carrot	1.6	27
Cow Manure	1.7	----		Mustard	1.5	26
Blood	10-14	3		Potato Tops	1.5	25
Fish Scrap	6.5-10	----		Fern	1.15	43
Meat Scraps	5.1	----		Whole Turnip	1.0	44
Purslane	4.5	8				

The above chart reveals the ratio of carbon to nitrogen in various common organic materials. For example, the C/N ratio of rotted sawdust is 208, indicating that there are 208 parts of carbon to every one part of nitrogen. The optimum C/N ratio for compost is 25 or 30/1, so obviously sawdust should have quite a bit of nitrogen added to it to ensure vigorous microbial decomposition. It should be evident from the above chart that humanure requires a fair amount of carbonaceous material to be mixed with it in order to obtain the optimum C/N ratio of 25 or 30/1. Sawdust happens to work quite well for this purpose, especially if somewhat rotted. When rotted sawdust is used as a cover material in a compost toilet, it also very effectively eliminates odors. Presumably, many common organic materials will work well as compost toilet cover. The idea is to use what's locally available. Note that garbage has nearly an optimum C/N ratio and would feel right at home in a compost pile, and straw and hay are well suited as cover materials for compost piles when manure is to be covered. The carbon in the hay balances the nitrogen in the manure.





8/1, or eight parts of carbon to one part of nitrogen. Therefore, you need to add a fair amount of carbon to humanure to get a 30/1 ratio and good compost. I've found that the proper balance is obtained by putting all the organic refuse of my household in the same pile, layered with weeds, straw, hay or whatever else happens to be within reach. The humanure is collected in a twenty-liter non-corrodible receptacle where it is constantly kept covered with clean, partially rotted, hardwood sawdust (I live in a hardwood forest). The sawdust adds quite a bit of carbon, although no extra sawdust is ever added to the compost pile other than what's put into the toilet. I'm getting ahead of myself here, as I'll discuss a bio-solids (sawdust) toilet in detail in chapter 7.

### **MISINFORMATION**

There was some literature published on the subject of composting humanure back in the 1970's which insinuated that humanure compost was practically as toxic as nuclear waste. And this information came from a publisher *promoting* the recycling of humanure.<sup>12</sup> Undoubtedly the publisher's intentions were good, and fecophobia (fear of fecal material) is understandable in our culture, but I must question the perpetuation of fecophobia from published information that is incomplete or incorrect. By some stroke of luck I didn't run across this book until recently, although I realize now that many of my acquaintances had been influenced by the publication and therefore feared the use of human excrement in compost. They were rendered fecophobic.

For example, the publisher had strongly recommended that human urine and feces be collected separately as the urine was "good" and the feces "bad". I had seen

#### **FUN FACTS**

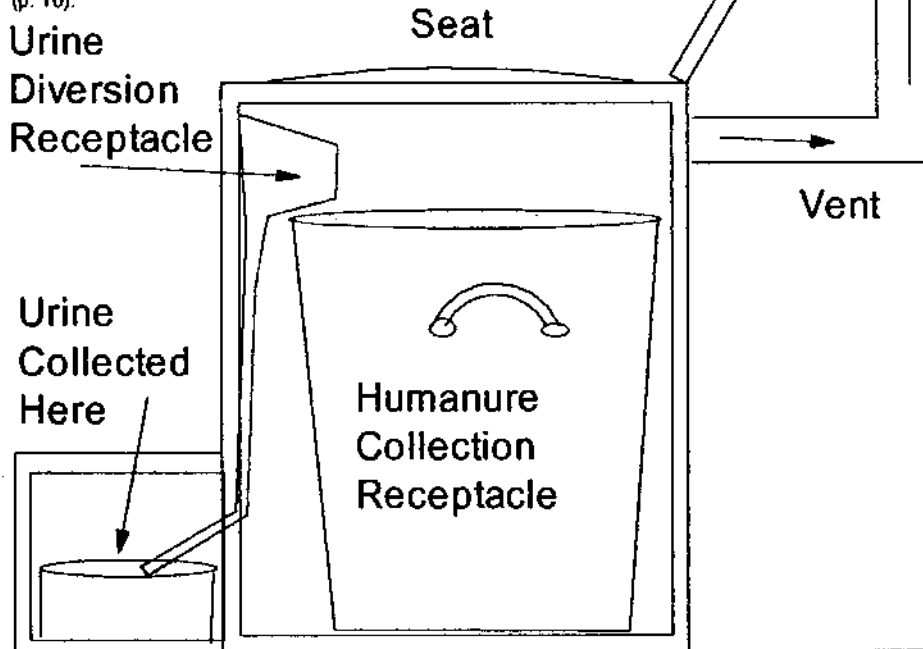


Proper composting requires a balance of carbon and nitrogen in the organic material being composted. Human excreta is not properly balanced as it is too high in nitrogen, and it requires a carbon material to be added to it for the encouragement of rapid and thorough microbial decomposition. In the mid 1800's, the concept of balancing carbon and nitrogen was not known, and the high nitrogen content of humanure in dry toilets prevented the organic material from efficiently decomposing. The result was a foul, fly-attracting stench. It was thought that this problem could be alleviated by segregating urine from feces (which thereby reduced the nitrogen content of the fecal material) and dry toilets were devised to do just that. Today, the practice of segregating urine from feces is still widespread, even though the simple addition of a carbonaceous material to the feces/urine will balance the nitrogen of the material and render the segregation of urine unnecessary.

Figure 2.2  
**THE MARINO TOILET**  
 1858 - Copenhagen

Cutaway view of the chamberpot version:

Source: Rybczynski, et. al. (1982). *Low Cost Technology Options for Sanitation: A State of the Art Review and Annotated Bibliography*. World Bank (p. 10).



In the mid-1800's, attempts were made to devise humanure collection devices which did not require water. Since the organic material was not being composted, the urine was segregated from the fecal material to minimize odor problems. This technique is still in wide use today, even though the simple use of a semi-dry, organic cover material such as rotting sawdust in the toilet absorbs excess liquids, prevents odors, eliminates flies and makes unnecessary the need to segregate urine. Such a cover material further balances the carbon-nitrogen ratio of the organic material, rendering it suitable for composting.

people doing this, but I could never understand where they came up with this idea until I read that book and also did some additional research into the subject. Urine was to be collected in a bucket and applied to the garden or compost pile, while fecal material was to be collected in a separate receptacle and buried in a trench far away (as in a distant orchard, maybe on another planet) and covered with twelve inches of soil. Now, the idea of defecating in one receptacle and urinating in another seems bizarre enough (I've never tried it and don't intend to),

but if you think fecal material stinks, you should smell a bucket of urine. It's enough to gag a maggot.

A neighbor of mine tried the separation method recommended in the book (defecating in one receptacle and urinating in another). However, the urine stank so bad that he couldn't continue to use this method without modifying the recommended system in some way. He said it was especially repulsive when he had to pour the urine from one container to another when applying it to the garden or compost pile. Now, my neighbor is a resourceful guy and he realized that all he had to do was fill a five-gallon bucket with *sawdust* and urinate in that to eliminate the odors. This worked so well that he wrote to the publisher suggesting this improvement to the

method, but the publisher never responded.

In the Rodale Book of Composting (1992, Rodale Press, Emmaus, PA 18098), human feces is listed under “Materials to Avoid”, where we are informed that *“human feces should not be used unless they have been properly treated and permitted to age sufficiently. Even then, concerns about disease pathogens make the use of such material dubious at best for the home gardener.”*

Ironically, however, the best way to “properly treat” humanure is to thermophilically compost it, which destroys potential pathogens. When humanure is thermophilically composted and then left to age for a while, it makes a fine soil additive for the home gardener. Furthermore, humanure provides a source of nitrogen for compost-making that is available to all people. When that nitrogen source is discarded as waste, we not only lose an essential and critical compost ingredient and an agricultural resource, we also pollute the environment. Rather than perpetuate fecophobia by continuing to relentlessly portray humanure as dangerous and to be avoided, advocates of organic gardening would provide a greater service to society by objectively researching the merits of composted humanure for agricultural purposes.

For example, the World Health Organization Expert Committee on Environmental Sanitation stated at its third session in 1954 that *“the committee recognizes the widespread use, in many parts of the world, of human excreta as fertilizer . . . With the growing world population and the limited extent of world resources, all efforts to utilize sanitary by-products and return them to the soil should be encouraged. The necessity of controlling these activities in such a way as to reduce to an absolute minimum their inherent public health hazards cannot be too strongly emphasized”* (see Rybczynski et. al., 1982).

Granted, humanure can be dangerous. Drink some water polluted with fecal material that came from someone afflicted with typhoid or cholera. You’ll soon find out how dangerous humanure can be when harboring disease organisms and polluting the environment. Cars can also be dangerous. Jump out in front of one on the highway some day and you’ll see what I mean. Matches can be dangerous. Try lighting your bed sheets. No, don’t. But do you get my point? There is potential danger everywhere. Humanure has the potential to be harmful too, but when *thermophilically composted* it is transformed into a friendly and valuable material.

Perhaps Gotaas (Composting, 1956, p.21) best sums it up: *“Van Vuren was unable to demonstrate any health hazards in properly managed [humanure] composting operations in South Africa. His findings are confirmed by Blair [South Africa]; Loots [South Africa]; Hamblin [South Africa]; Acharya [India]; Scharff [Malaya]; and others in Great Britain, Germany, Australia,, the Netherlands, Denmark, and New Zealand.*

## HAVE A GOOD BLEND

A sawdust-filled receptacle makes a good urine depository, as my neighbor discovered, but it can also act as a receptacle for human fecal material. Instead of beginning with a full receptacle of sawdust as with the urine receptacle, the sawdust is added after each use so that *there's a clean layer on the top at all times*. Urine is added to the same receptacle. Sawdust is added after urination as well as after defecation, if needed. Then, when the bucket is full, the whole works goes on the compost pile - feces, urine and sawdust (which is saturated with urine). The bucket is then rinsed, and the rinse water also deposited on the compost pile. This, in essence, constitutes the collection process of an absolutely minimum technology hygienic toilet. Waste is completely eliminated using this routine, *but the humanure must be thermophilically composted in a responsible and conscientious manner*. That's the missing link that must be incorporated into the process. How?

At the risk of repeating myself, you must blend the humanure with a healthy mix of other materials if you want good finished compost. What constitutes a healthy mix? If you're a serious gardener, most of your food scraps and some of your garden refuse will do. A clean cover material (such as hay, straw or weeds) ices the cake. It's that simple. I compost everything in the way of organic refuse produced on my small (no livestock,) gardening homestead, in a bin that is approximately five feet by five feet and four feet high. Everything. This provides a nice mix which produces approximately 75 cubic feet of lovely compost each year. If your garden produces large quantities of weeds at times, pile the weeds *beside* the compost bin and use them for cover material *a little at a time* (see three-chambered bin designs on page 159). This subject will be discussed in detail in chapter seven.

Compost shrinks. Unbelievably. That 5x5 bin holds a year's worth of humanure (family of four), and a year's worth of everything else. We just keep piling it on and it just keeps shrinking down and down. We pile, it shrinks. When it's all done, it stops shrinking.

Toilet paper composts too. So do the cardboard tubes in the center of the rolls. Use unscented, undyed paper if you want to keep trace contaminants out of your compost. Unbleached, recycled paper is ideal. Or you can use the old fashioned toilet paper, otherwise known as corncobs. Popcorn cobs work best, they're softer. Corncobs don't compost very readily though, so you have a good excuse not to use them. There are other things that don't compost so well: eggshells, bones, hair, and woody stems, to name a few. We throw our eggshells back to our chickens, or into the woodstove. Bones (rare in our house) go into the woodstove, too, or to the cats or

dog. Hair goes out to the birds for nests, if not into the compost pile.

And never put woody stemmed plants, such as tree saplings, on your compost pile. I hired a young lad to clear some brush for me one summer and he innocently put the small saplings on my compost pile without me knowing it. Later, I found them networked through the pile like iron reinforcing rods. I'll bet the lad's ears were itching that day - I sure had a lot of nasty things to say about him. Fortunately, only Gomer, the compost pile, heard me.



Applying thermophilically composted humanure to a raised bed garden in the springtime.

What about things like sanitary napkins and disposable diapers? Forget it. Sure, they'll compost, but they'll leave strips of plastic throughout your finished compost which is quite unsightly. Of course, that's OK if you don't mind picking the strips of plastic out of your compost. Otherwise, use cloth diapers and washable cloth menstrual pads instead.

Furthermore, it has been reported that food preserved with BHT should stay out of the compost pile, as research has shown that very small amounts of this antioxidant can alter plant growth profoundly.<sup>13</sup>

## **NEWSPAPER**

What about newspapers? Yes, newspaper will compost, but there are some



The author probing a humanure compost pile in late winter. This compost had not yet become thermophilically active. Of the two thermometers, one has a long probe and the other a short one. PHOTO BY JEANINE JENKINS.

concerns about newsprint. For one, the glossy pages are covered with a clay that retards composting. For another, the inks can be petroleum-based solvents or oils with pigments containing toxic substances such as chromium, lead and cadmium in both black and colored inks. Pigment for newspaper ink still comes from benzene, toluene, naphthalene and other benzene ring hydrocarbons which may be quite harmful to human health if accumulated in the food chain. Fortunately, quite a few newspapers today are using soy-based inks instead of petroleum-based inks.\*\* If you really want to know about the type of ink in your newspaper, call your newspaper office and ask them. Otherwise, don't use glossy paper or colored pages in your compost and keep the newspaper to a minimum. Remember, ideally, compost is being made to use for producing human food. One should try to keep the contaminants out of it if possible.<sup>14</sup>

On the other hand, Wood's End Laboratory in Maine did some research on composting ground up telephone books and newsprint, which had been used as bedding for dairy cattle. The ink in the paper contained common carcinogenic chemicals,

but after composting it with dairy cow manure, the dangerous chemicals were reduced by 98%.<sup>15</sup> So it appears that if you're using shredded newspaper for bedding under livestock, you *should* compost it, if for no other reason than to eliminate some of the toxic elements from the newsprint. It'll probably make acceptable compost too, especially if layered with garbage, manure and the like.

## LIME

One other thing. It is not necessary to put lime (ground agricultural limestone) on your compost pile. The belief that compost piles must be limed is a common misconception. Nor are other mineral additives needed on your compost. If your soil needs limed, put the lime on your soil, not your compost. Bacteria don't digest limestone. Why ruin their day? My compost is not acidic, even with the use of sawdust. The pH of my finished compost slightly exceeds 7 (neutral). I never put lime on my pile. I once put all my wood ashes on my compost pile, but in recent years I've put my wood ashes straight on my soil. The compost pile doesn't need them. Even without the wood ashes, the potassium content of my finished compost is more than adequate and the pH is good. It may seem logical that one should put into one's compost pile whatever one also wants to put into one's garden soil, as the compost will end up in the garden eventually, but that's not the reality of the situation. *What one should put into one's compost is what the microorganisms in the compost want or need, not what the garden soil wants or needs.*

According to a 1991 report, scientists who were studying various commercial fertilizers found that agricultural plots to which composted sewage sludge had been

**ESSENTIAL  
READING FOR  
INSOMNIACS**



**pH: pH LITERALLY MEANS  
HYDROGEN POWER.**

It is a measure of the degree of alkalinity or acidity of a solution, and is often expressed as the logarithm of the reciprocal of the hydrogen ion concentration in gram equivalents per liter of solution: pH7 = .0000001 gram atom of hydrogen per liter. Pure distilled water is regarded as neutral with a pH of 7. pH values from 0 to 7 indicate acidity, and from 7 to 14 indicate alkalinity.



added made better use of lime than plots without composted sludge. The lime in the composted plots changed the pH deeper in the soil, indicating that organic matter assists calcium movement through the soil "*better than anything else*" according to Cecil Tester, Ph.D., research chemist at USDA's Microbial Systems Lab in Beltsville, MD.<sup>16</sup> The implications are that compost should be added to the soil when lime is added *to the soil*.

Sir Albert Howard, one of the most well-known proponents of composting, as well as J. I. Rodale, another organic gardening great, have recommended adding lime to compost piles.<sup>17</sup> They seemed to base their reasoning on the belief that the compost will become acidic during the composting process, and therefore the acidity must be neutralized by adding lime to the pile while it's composting. It may well be the case that compost becomes acidic during the process of decomposition, however, my experience shows me that it seems to neutralize itself if left alone, yielding a neutral end product. Therefore, I'd recommend that you make sure you need to neutralize the pH of your compost before you jump to the conclusion that you do. You can do that by testing your *finished* compost for pH.

I find it ironic that the same author who has recommended liming compost piles in one book (Rodale, as mentioned above), states in another, "*The control of pH in composting is seldom a problem requiring attention if the material is kept aerobic . . . the addition of alkaline material is rarely necessary in aerobic decomposition and, in fact, may do more harm than good because the loss of nitrogen by the evolution of ammonia as a gas will be greater at the higher pH.*"<sup>18</sup> In other words, don't assume that you should lime your pile. Only do so if your finished compost is consistently acidic. Get a soil pH test kit and check it out.

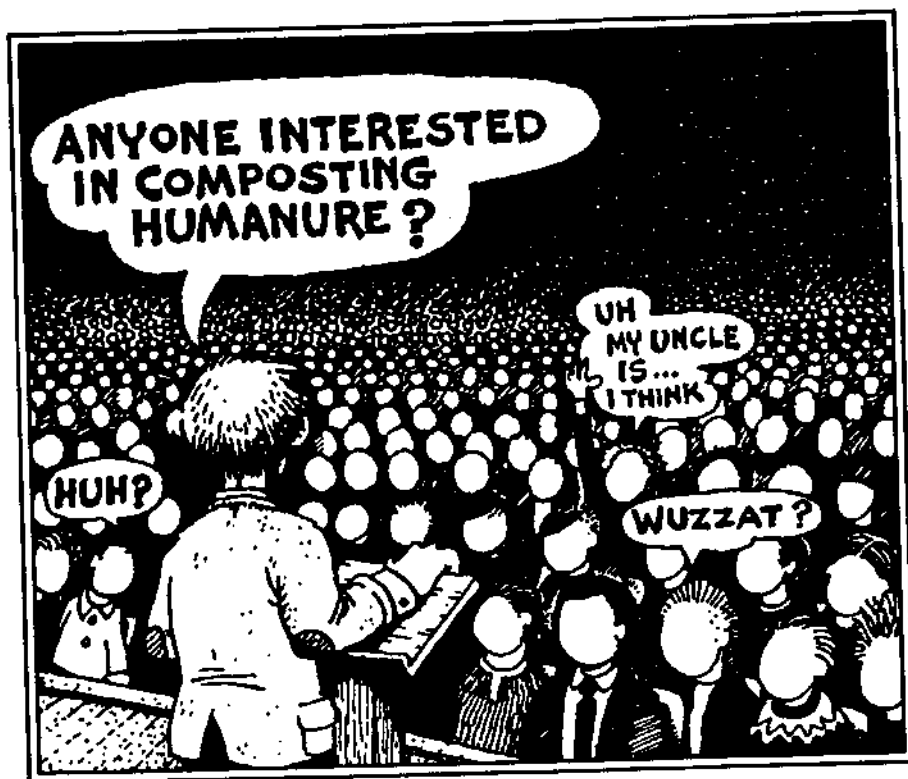
What is pH? It's a measure of acidity and alkalinity. pH ranges from 1 - 14. Neutral is 7. Below seven is acidic, above seven is basic (alkaline). If the pH is too acidic or too alkaline bacterial activity will be hindered or stopped completely. Lime and wood ashes raise the pH. This is where things could get complicated, taking us into the domain of the chemist rather than the composter.

How does one become an accomplished composter, a master composter? That's easy - just do it. Then keep doing it. Throw the books away (not this one, of course) and get some good, old-fashioned experience. There's no better way to learn. Book learning will only get you so far, but not far enough. There's nothing worse than someone who's read a lot of books and thinks s/he knows everything. A book such as the one you're now reading is for inspiring you, for sparking your interest, and for reference. But you have to get out there and do it if you really want to learn.

One's best bet is to work with the compost, get the feel of the process, look at your compost, smell the finished product, buy or borrow a compost thermometer and



get an idea of how well your compost is heating up, then use your compost for food production. Rely on your compost. Make it a part of your life. Need it and value it. In no time, without the need for charts or graphs, Ph.D.s, or worry, your compost will be as good as the best of them. Perhaps someday we'll be like the Chinese who give prizes for the best compost in a county, then have inter-county competitions. Now *that's* getting your shit together.



## REFERENCES - CHAPTER TWO

- 1 - Bem, R., (1978). Everyone's Guide to Home Composting. Van Nostrand Reinhold Co., NY (p.4).
  - 2 - Sides, S. (1991). Compost. *Mother Earth News*. Issue 127, Aug/Sept 1991 (pp.49-53).
  - 3 - Logan, W.B. (1991). Rot is Hot. *New York Times Magazine*. 9/8/91, Vol. 140, Issue 4871. (p.46).
  - 4 - Sides, S. (1991). Compost. *Mother Earth News*. Issue 127, Aug/Sept 1991 (p.50).
  - 5 - Logan, W.B., (1991). Rot is Hot. (see #3).
  - 6 - Lubke, Sigfried. (1989). Interview: All Things Considered in the Wake of the Chernobyl Nuclear Accident. *Acres U.S.A.* December 1989. (p. 20) [also contact Uta and Sigfried Lubke, A4722 Peuerbach, Untererleinsbach 1, Austria]
  - 7 - Howard, Sir Albert, (1943). An Agricultural Testament. Oxford University Press: New York.
  - 8 - Bhamidimarri, R. (1988). Alternative Waste Treatment Systems. Elsevier Applied Science Publishers LTD., Crown House, Linton Road, Barking, Essex, IG11 8JU, England. (p.129).
  - 9 - Howard, Sir Albert, (1943). An Agricultural Testament. (p.48).
  - 10 - Stoner, C.H. (Ed.). (1977). Goodbye to the Flush Toilet. Rodale Press: Emmaus, PA, 1977. (p.46).
  - 11 - Rodale, J.I. et. al. (Eds.). (1960). The Complete Book of Composting. Rodale Books Inc.: Emmaus, Pa (pp.646-647).
  - 12 - See Stoner, Goodbye to the Flush Toilet (as above).
  - 13 - Sides, S. (as above) (p.51).
  - 14 - *Garbage: the Practical Journal for the Environment*. May/June 1992, p.66, Old House Journal Corp., 2 Main St., Gloucester, MA 01930.
  - 15 - Logan, W.B. (as above).
  - 16 - Poncavage, J. and Jesiolowski, J. (1991). Mix Up a Compost and a Lime. *Organic Gardening*. March 1991, Vol. 38, Issue 3. (p.18).
  - 17 - Howard, Sir Albert (1943). An Agricultural Testament. Oxford University Press: New York. (p.44).
- Also see:  
Rodale, J.I. (1946). Pay Dirt. The Devon-Adair Co.: New York.
- 18 - Rodale, J.I. et. al. (Eds.) (1960). The Complete Book of Composting. Rodale Books Inc.: Emmaus, PA (p.658).

\*Adelle Davis was a popular nutritionist in the 1960's and 70's who advocated that people take dietary supplements to replace the lack of nutrition in the typical refined-food American diet. Much of what she wrote about in her list of books was on target. However, she also contended that a healthy person's shit won't stink. Dead wrong on that one, Adelle.

\*\* Contact the National Soy Ink Information Center, c/o Iowa Soybean Association, 1025 Ashworth Road, No. 310, West Des Moines, Iowa 50265-3542.

## DEEP SHIT

*"I do not think that any civilization can be called complete until it has progressed from sophistication to unsophistication, and made a conscious return to simplicity of thinking and living."*

Lin Yutang



**T**he Asian people have recycled humanure for thousands of years. Why haven't we? This is a philosophical question which should be delved into. Now let's think about this for a second. The Asian cultures, namely Chinese, Korean, Japanese and others have evolved to understand human excrement to be a natural resource. Smelly perhaps, but not to be wasted, nor to be conceived of as a waste material. We have human waste, they have humanure (also known as night soil). We produce waste and pollution, they produce soil nutrients and food. It's clear to me that the Asians are more advanced than the Western world in this regard. And they should be, they've been working on developing sustainable lifestyles, especially sustainable agriculture for four thousand years on the same land. For four thousand years those people have worked the same land with little or no chemical fertilizers and, in many cases, have produced greater crop yields than Western farmers, the same farmers who are quickly destroying the soils of their own countries through depletion and erosion.

Here is a fact largely being ignored by people in Western agriculture: *agricultural land must produce a greater output over time because the human population is constantly increasing, but available agricultural land is not. Therefore, our farming practices should leave us with land more fertile with each passing year.* Nevertheless, we are doing just the opposite.

Back in 1938, the U.S. Department of Agriculture came to the alarming conclusion that *a full 61% of the total area under crops in the U.S. at that time had been completely or partly destroyed, or had lost most of its fertility.*<sup>1</sup> Nothing to worry about? We have artificial fertilizers, tractors, and oil to keep it all going? True, U.S. agriculture is heavily dependent upon fossil fuel resources. However, in 1993 we were importing about half our oil from foreign sources, and it's estimated that the U.S. will be out of domestic oil reserves by the year 2020. Some sources also report that the U.S. will be unable to export food beyond the year 2000.<sup>2</sup> If this is true, then

a heavy dependence on foreign oil for our food production seems unwise at best, and probably just plain foolish, especially when we're producing soil nutrients every day in the form of organic refuse, then throwing those nutrients "away" by burying them in landfills.

Now, it seems to me that if we want to learn something about sustainability, we would look to those people who are doing it. The Chinese have it figured out: *waste not, want not*. But there's a lot more to it than that.

Why don't we follow the Asian example? It's not for a lack of information. Dr. F. H. King wrote an interesting book, published in 1910 and titled Farmers of Forty Centuries<sup>3</sup>. Dr. King (D.Sc.) was a former chief of the Division of Soil Management of the U.S. Department of Agriculture who traveled through Japan, Korea and China in the early 1900's as an agricultural visitor. He was interested in finding out how people could farm the same fields for 4,000 years without destroying their fertility. He states:

*"One of the most remarkable agricultural practices adopted by any civilized people is the centuries long and well nigh universal conservation and utilization of all human waste [sic] in China, Korea and Japan, turning it to marvelous account in the maintenance of soil fertility and in the production of food. To understand this evolution it must be recognized that mineral fertilizers so extensively employed in modern Western agriculture has been a physical impossibility to all people alike until within very recent years. With this fact must be associated the very long unbroken life of these nations and the vast numbers their farmers have been compelled to feed.*

*When we reflect upon the depleted fertility of our own older farm lands, comparatively few of which have seen a century's service, and upon the enormous quantity of mineral fertilizers which are being applied annually to them in order to secure paying yields, it becomes evident that the time is here when profound consideration should be given to the practices the Mongolian race has maintained through many centuries, which permit it to be said of China that one-sixth of an acre of good land is ample for the maintenance of one person, and which are feeding an average of three people per acre of farm land in the three southernmost islands of Japan.*

*[Western humanity] is the most extravagant accelerator of waste the world has ever endured. His withering blight has fallen upon every living thing within his reach, himself not excepted; and his besom of destruction in the uncontrolled hands of a generation has swept into the sea soil fertility which only centuries of life could accumulate, and yet this fertility is the substratum of all that is living."*<sup>4</sup>

According to King's research, the average daily excreta of the adult human weighs in at 40 ounces. Multiplied by 250 million, a rough estimate of the current U.S. population, Americans each year produce 1,448,575,000 pounds of nitrogen,

456,250,000 pounds of potassium, and 193,900,000 pounds of phosphorous, almost all of which is discarded into the environment as a waste material and a pollutant, or as Dr. King puts it, "*poured into the seas, lakes or rivers and into the underground waters.*"

According to King, "*The International Concession of the city of Shanghai, in 1908, sold to a Chinese contractor the privilege of entering residences and public places early in the morning of each day and removing the night soil, receiving therefor more than \$31,000 gold, for 78,000 tons of waste [sic]. All of this we not only throw away but expend much larger sums in doing so.*"

In case you didn't catch that, the contractor paid \$31,000 gold for the humanure, referred to as "night soil" and incorrectly as "waste" by Dr. King.

Furthermore, using Dr. King's figures, the U.S. population today produces approximately 228,125,000,000 pounds of fecal material annually. That's 228 billion pounds. You could call that the *Gross National Shit*.

Admittedly, the spreading of raw human excrement on fields, as is done in Asia, will probably never become culturally acceptable in the United States, and rightly so. The use of night soil in this regard produces an assault to the sense of smell, and provides a vector for various human pathogens (disease organisms). Americans who have traveled abroad and witnessed the use of raw human excrement in agricultural applications have largely been repulsed by the experience. That repulsion has instilled among many Americans an intransigent bias against, and even a fear of the use of humanure for soil enrichment. However, few Americans have witnessed the *composting* of humanure as a preliminary step in its recycling. Proper thermophilic composting converts humanure into a pleasant smelling material devoid of human pathogens.

Although the agricultural use of raw human excrement will never become a common practice in the U.S., the use of composted human refuse, including humanure, food refuse, and other organic municipal refuse such as leaves, can and should become a widespread and culturally encouraged practice in the United States. The act of composting humanure instead of using it raw will set Americans apart from Asians in regard to the recycling of human excrements, *for we too will have to constructively deal with all of our refuse materials eventually*. We can put it off, but not forever. As it stands now, at least the Asians are recycling their refuse. We're not.

## **WASTE VS. MANURE, AGAIN**

Human *waste* is human excrement *that is not recycled*. A waste material is

something *with no inherent value*. Waste is something we believe to be useless and we discard it. People who recycle things are not wasting them. People who compost their manure do not produce human waste in the form of body excrements.

Sorry, I know it's a hard concept to grasp, that human waste is *something we create by choice*. In the English language today, human waste is synonymous with human feces and urine. Eventually, this will change. We don't necessarily create human waste naturally. We produce human manure naturally. What we do with it constitutes whether it's waste or not. Now this may seem like a trivial matter to some. You've always known fecal material to be human waste, therefore you'll always call it human waste.

On the other hand, you may be capable of advancing your understanding. As understanding and consciousness change, so does language change. In the same way that the word "man" is no longer appropriate when referring to the human race because we've finally figured out that half of the human race is made up of women, human "waste" is no longer appropriate when referring to humanure, unless that manure is being wasted (which, in the USA, it usually is). There's no reason why we can't clarify our terms, evolve our language a bit, and thereby enhance communication and understanding.

What is human waste? Human waste is cigarette butts, empty beer cans lying along the road, plastic six-pack rings, styrofoam clamshell burger boxes, deodorant cans, disposable diapers, discarded appliances, discarded pop bottles, newspapers, old car tires, spent batteries, junk mail, nuclear garbage, convenience foods, exhaust emissions, the five billion gallons of drinking water we flush down our toilets every day, and the millions of tons of organic refuse discarded into the environment year after year after year.

My household produces one bag of waste, i.e. non-recyclable junk, every two months. Six garbage bags a year that end up in a landfill. I believe that's excessive. It's waste and my family produces it. Let's face it - six bags a year in fifty years means we've "thrown" 300 bags out into the environment. If those all stayed in my own backyard I'd eventually be living by a small mountain of garbage. Our consumption of electricity, use of internal combustion engines, and consumption of consumer goods also add to the waste my family contributes to our ecosystem. Unfortunately, in the United States we take waste for granted. It's a way of life, one promoted by our government and our business leaders and one far removed from the harmonious existence with our planet that a sustainable future requires of us. "Waste reduction - resource recovery" will not be meaningful words to Americans unless they're spoken, written, published, and most importantly, lived.

## THE ADVANCES OF SCIENCE

How is it that the Asian peoples developed an excellent understanding of human nutrient recycling which pervades their collective consciousness and is completely accepted and taken for granted, and we haven't? After all, we're the advanced, developed, scientific nation, aren't we? Dr. King makes an interesting observation concerning scientists. He states:

*"It was not until 1888, and then after a prolonged war of more than thirty years, generated by the best scientists of all Europe, that it was finally conceded as demonstrated that leguminous plants acting as hosts for lower organisms living on their roots are largely responsible for the maintenance of soil nitrogen, drawing it directly from the air to which it is returned through the processes of decay. But centuries of practice had taught the Far East farmers that the culture and use of these crops are essential to enduring fertility, and so in each of the three countries the growing of legumes in rotation with other crops very extensively, for the express purpose of fertilizing the soil, is one of their old fixed practices."*<sup>5</sup> [Emphasis mine.]

In our culture we believe we have to wait for the experts to figure things out before we can claim any real knowledge. This appears to have put us several centuries behind the Asians. It certainly seems odd to me that people who gain their knowledge in real life through practice and experience are shunned, ignored or trivialized by the academic world and associated government agencies. Such agencies will only credit learning that has taken place within their institutional framework. As such, it's no wonder that Western humanity's crawl toward a sustainable existence on the planet Earth is so pitifully slow.

*"Strange as it may seem, says King, there are not today and apparently never have been, even in the largest and oldest cities of Japan, China or Korea, anything corresponding to the hydraulic systems of sewage disposal used now by Western nations. When I asked my interpreter if it was not the custom of the city during the winter months to discharge its night soil into the sea, as a quicker and cheaper mode of disposal [than recycling], his reply came quick and sharp, 'No, that would be waste. We throw nothing away. It is worth too much money.'"<sup>6</sup> The Chinaman, says King, wastes nothing while the sacred duty of agriculture is uppermost in his mind."<sup>7</sup>*

Perhaps, a few centuries from now, our scientific community will understand.

## HOLY SHEESH

Here I must propose some philosophical speculation. My theory is this: the

Asians evolved over the millennia with a spiritual perspective that maintained, to some extent, a view of the earth, and of nature, as sacred. This was a relatively holistic spiritual perspective which did not single out the human race as being the pinnacle of creation, but instead recognized the totality of interconnected existence as sacred, and advocated human harmony with the Whole.

Now contrast this to our Western religious heritage which taught us that divinity lies only in the human form, and that peoples who revere nature are “pagans”, “heathens”, “witches” and worse. Admittedly, this is a broad and contentious topic, too broad for the scope of this book. Perhaps a few quotes here, however, will help to illustrate my point.

**Hinduism**, more common to India, but reaching into the Far East, seemed to be sensitive to the sanctity of the natural world:

*“He who tries to give an idea of God by mere book learning is like the person who tries to give an idea of the city of Benares by means of a map or a picture.” (Shri Ramakrishna)<sup>8</sup>*

*“When Svetaketu, at his father’s bidding, had brought a ripe fruit from the banyan tree, his father said to him, Split the fruit in two, dear son.*

*Here you are. I have split it in two.*

*What do you find there?*

*Innumerable tiny seeds.*

*Then take one of the seeds and split it.*

*I have split the seed.*

*And what do you find there?*

*Why, nothing, nothing at all.*

*Ah, dear son, but this great tree cannot possibly come from nothing. Even if you cannot see with your eyes that subtle something in the seed which produces this mighty form, it is present nonetheless. That is the power, that is the spirit unseen, which pervades everywhere and is all things. Have faith! That is the spirit which lies at the root of all existence, and that also art thou, O Svetaketu.” (Chandogya Upanishad)<sup>9</sup>*

**Buddhism** is a dominant influence in vast sections of Asia:

*“May all living things be happy and at their ease! May they be joyous and live in safety! All beings, whether weak or strong - omitting none - in high, middle, or low realms of existence, small or great, visible or invisible, near or far away, born or*



*to be born - may all beings be happy and at their ease! Let none deceive another, or despise any being in any state; let none by anger or ill will wish harm to another! Even as a mother watches over and protects her only child, so with a boundless mind should one cherish all living beings, radiating friendliness over the entire world, above, below and all around without limit; so let him cultivate a boundless good will toward the entire world, uncramped, free from ill will or enmity.” (the Metta Sutra)<sup>10</sup>*

**Zen** is a transliteration of the Sanskrit word “dyhana” meaning meditation, or more fully “contemplation leading to a higher state of consciousness”, “union with Reality”. It can be described as a blend of Indian mysticism and Chinese naturalism with a Japanese influence:

*“When the mind rests serene in the oneness of things . . . dualism vanishes by itself.” (from the Hsis-hsis-ming by Seng-ts’an)<sup>11</sup>*

*“Zen does not go along with the Judaic-Christian belief in a personal savior or a God - outside the Universe - who has created the cosmos and the human race. To the Zen view, the Universe is one indissoluble substance, one total whole, of which humanity is a part.” (Nancy Wilson Ross)<sup>12</sup>*

**Confucius**, like Buddha, was born in the sixth century B.C. and preached a philosophy of common Chinese virtue:

*“The path of duty lies in what is near and people seek for it in what is remote. The work of duty lies in what is easy and people seek for it in what is difficult.” (Confucius)<sup>13</sup>*

**The Tao** (the way), written by Lao Tsu, a contemporary of Confucius, has provided one of the major underlying influences in Chinese thought and culture for 2,500 years:

*“Those who know do not talk. Those who talk do not know. Keep your mouth closed. Guard your senses. Temper your sharpness. Simplify your problems. Mask your brightness. Be at one with the dust of the earth. This is primal union. He who has achieved this state is unconcerned with friends and enemies, with good and harm, with honor and disgrace. This therefore is the highest state of humanity.” (Lao Tsu)<sup>14</sup>*

**Christianity**, the primary religious influence of the Western world, strongly supported the idea that humans were separate from and dominant over the natural world:

*“And God said, Let us make man in our image, after our likeness, and let them have dominion over the fish of the sea, and over the fowl of the air, and over the cattle, and over all the earth, and over every creeping thing that creepeth on the earth. . . And God blessed them, and God said unto them, Be fruitful and multiply, and replenish the earth, and subdue it: and have dominion over the fish of the sea, and over the fowl of the air, and over every living thing that moveth upon the earth.”* (the Bible)<sup>15</sup>

Far Eastern culture is imbued with the concepts of oneness, with the belief that the highest state of human evolution is one of harmony and peace with one's inner self and with one's outer reality, i.e. the natural world, one's society, the Universe. This would certainly seem to contribute to the development of sustainable agricultural methods. When one accepts the sacredness of life, one can easily understand why one should create compost and soil rather than waste and pollution.

### **WHEN THE CRAP HIT THE FAN**

While the Asians were practicing sustainable agriculture and recycling their organic resources and doing so over a period of millennia, what were the people of the West doing? What were the Europeans and those of European descent doing? Why weren't our ancestors returning their manures to the soil too? After all, it does make sense. The Asians who recycled their manures not only recovered a resource and reduced pollution, but by returning their excrement to the soil they succeeded in reducing threats to their health. There was no putrid sewage collecting and breeding disease germs. Instead the humanure was, for the most part, undergoing a natural, non-chemical purification process in the soil which required no technology.

Granted, a lot of “night soil” in the Far East today is not completely composted or composted at all, and is the source of health problems in Asia. However, even the returning of humanure raw to the land succeeds in destroying many human pathogens in the manure, and returns nutrients to the soil. We'll get more into this later. Let's take a look at what was happening in Europe from, say, the 1300's on, regarding public hygiene.

Great pestilences swept Europe throughout recorded history. The Black Death killed more than half the population of England in the fourteenth century. In 1552,

67,000 patients died of the Plague in Paris alone. Fleas from infected rats were the carriers of this disease. Did the rats dine on human waste? Other pestilences included the sweating sickness (attributed to uncleanness), cholera (spread by food and water contaminated by the excrement of infected persons), "jail fever" (caused by a lack of sanitation in prisons), typhoid fever (spread by water contaminated with infected feces), and numerous others.

Andrew D. White, cofounder of Cornell University, writes, "*Nearly twenty centuries since the rise of Christianity, and down to a period within living memory, at the appearance of any pestilence the [Christian] Church authorities, instead of devising sanitary measures, have very generally preached the necessity of immediate atonement for offenses against the Almighty. In the principal towns of Europe, as well as in the country at large, down to a recent period, the most ordinary sanitary precautions were neglected, and pestilences continued to be attributed to the wrath of God or the malice of Satan.*"<sup>16</sup>

It's now known that the main cause of such immense sacrifice of life was a lack of proper hygienic practices. It's argued that certain theological reasoning at that time resisted the evolution of proper hygiene. According to Mr. White, "*For century after century the idea prevailed that filthiness was akin to holiness.*" Living in filth was regarded by holy men as an evidence of sanctity, according to Mr. White, who lists numerous saints who never bathed parts or all of their bodies, such as St. Abraham, who washed neither his hands nor his feet for fifty years, or St. Sylvia, who never washed any part of her body save her fingers.<sup>17</sup>

Interestingly, after the Black Death left its grim wake across Europe, "*an immensely increased proportion of the landed and personal property of every European country was in the hands of the church.*"<sup>18</sup> Apparently, the church was reaping some benefit from the deaths of huge numbers of people. Perhaps the church had a vested interest in maintaining public ignorance about the sources of disease. This insinuation is almost too diabolical for serious consideration. Or is it?

Somehow, the idea developed around the 1400's that Jews and witches were causing the pestilences. Jews were suspected because they didn't succumb to the pestilences as readily as the Christian population did, presumably because they employed a unique sanitation system more conducive to cleanliness, including the eating of kosher foods. Not understanding this, the Christian population arrived at the conclusion that the Jew's immunity resulted from protection by Satan. As a result, attempts were made in all parts of Europe to stop the plagues by torturing and murdering the Jews. Twelve thousand Jews were reportedly burned to death in Bavaria alone during the time of the plague, and additionally thousands more were likewise killed throughout Europe.<sup>19</sup>

In 1484, the “infallible” Pope Innocent VIII issued a proclamation supporting the church’s opinion that witches were causes of disease, storms, and a variety of ills affecting humanity. The feeling of the church was summed up in one sentence: “*Thou shalt not suffer a witch to live.*” From the middle of the sixteenth to the middle of the seventeenth centuries, women and men were sent to torture and death by the thousands, by both Protestant and Catholic authorities. It’s estimated that the number of victims sacrificed during that century in Germany alone was over a hundred thousand.

The following case in Milan, Italy summarizes the ideas of sanitation in Europe during the seventeenth century:

The city was under the control of Spain, and had received notice from the Spanish government that witches were suspected of being on the way to Milan to “anoint the walls” (smear the walls with disease-causing ointments). The church rang the alarm from the pulpit, putting the population on the alert. One morning, in 1630, an old woman looking out of her window saw a man who was walking along the street wipe his fingers on a wall. He was promptly reported to the authorities to whom he claimed he was simply wiping ink from his fingers which had rubbed off the ink-horn he carried with him. Not satisfied with this explanation, the authorities threw the man into prison and tortured him until he “confessed”. The torture continued until the man gave the names of his “accomplices”, who were subsequently rounded up and tortured. They in turn named their “accomplices” and the process continued until members of the foremost families were included in the charges. Finally, a large number of innocent people were sentenced to their deaths, which is all reportedly a matter of record.<sup>20</sup>

One loathsome disease of the 15-1700’s was the jail fever. The prisons of that period were filthy; people were confined in dungeons connected to sewers with little ventilation or drainage. Prisoners incubated the disease and spread it to the public, especially the police, lawyers and judges. In 1750, for example, the disease killed two judges, the lord mayor, various aldermen and many others in London, not to mention prisoners.<sup>21</sup>

The pestilences at that time in the Protestant colonies in *America* were also attributed to divine wrath or satanic malice, but when the pestilences afflicted the Native Americans, they were considered acts of divine mercy. “*The pestilence among the Indians, before the arrival of the Plymouth Colony, was attributed in a notable work of that period to the Divine purpose of clearing New England for the heralds of the gospel.*”<sup>22</sup>

Well, let’s not get too far off the track. But perhaps the reason the Asian countries have such large populations in comparison to Western countries is because they

escaped some of the pestilences common to Europe, especially pestilences spread by the failure to responsibly recycle human excrement. They presumably plowed their manure back into the land because their spiritual perspectives supported such behavior. Westerners were too busy burning witches and Jews with the church's wholehearted assistance to bother to think about recycling humanure.

Our ancestors did eventually come to understand that poor hygiene was a causal factor in epidemic diseases. Nevertheless, it was not until the late 1800's in England that improper sanitation and sewage were suspected as causes of epidemics. At that time, large numbers of people were still dying from pestilences, especially cholera, which killed at least 130,000 people in England in 1848-9 alone. In 1849, an English medical practitioner published the theory that cholera was spread by water contaminated with sewage. Ironically, even where sewage was being piped away from the population, the sewers were still leaking into drinking water supplies.

The English government couldn't be bothered with the fact that hundreds of thousands of (mostly poor) citizens were perishing like flies year after year. So it rejected a Public Health Bill in 1847. A Public Health Bill finally became an act in 1848 in the face of the latest outbreak, but wasn't terribly effective. However, it did bring poor sanitation to the attention of the public, as the following statement from the General Board of Health (1849) implies: *"Householders of all classes should be warned that their first means of safety lies in the removal of dung heaps and solid and liquid filth of every description from beneath or about their houses and premises."* This may make one wonder if a compost heap would have been considered a "dung heap" in those days, and therefore banned.

The wealthy folks, including the Tories or "conservatives" of the English government still thought that spending on social services was a waste of money and an unacceptable infringement by the government on the private sector (sound familiar?). A leading newspaper, "The Times", maintained that the risk of cholera was preferable to being bullied by the government. However, a major act was finally passed in 1866, the Public Health Act, with only grudging support from the Tories. Once again, cholera was raging through the population, and it's probably for that reason that any act was passed at all. Finally, by the end of the 1860's, a framework of public health policy was established in England. Thankfully, that cholera epidemic of 1866 was the last and the least disastrous.<sup>23</sup>

The powers of the church eventually diminished enough for scientists to have their much delayed say about the origins of disease. Today, the church no longer remains such an insurmountable obstacle to the progress of society, and in many cases acts as a force of hope for peace, justice, and even environmental awareness in the Western world. Our modern sanitation systems have yielded a life safe for most

of us, although not without shortcomings. The eventual solution developed by the West was to collect humanure in water and discard it, perhaps chemically treated and dehydrated, in the seas, on the surface of the land, and in landfills, somewhere away from population centers.

Finally, I'm not naive enough to suggest that the Asian societies are perfect by any stretch of the imagination. Asian history is rife with the problems that have plagued humanity since the first person hatched out of the first egg. You know what I mean: wars, oppressive rule by the rich, more war, famine, natural catastrophes, oppressive rule by heathens, more war, and now overpopulation. There is also ample evidence of diseases and parasites afflicting the Asian peoples even to this day. However, the causes of the health problems that are linked to human excrement most likely stem from the failure to responsibly compost it. Not all Asian families strive to attain impeccably clean surroundings, and they pay for their lax habits with poor health. That is a universal problem.

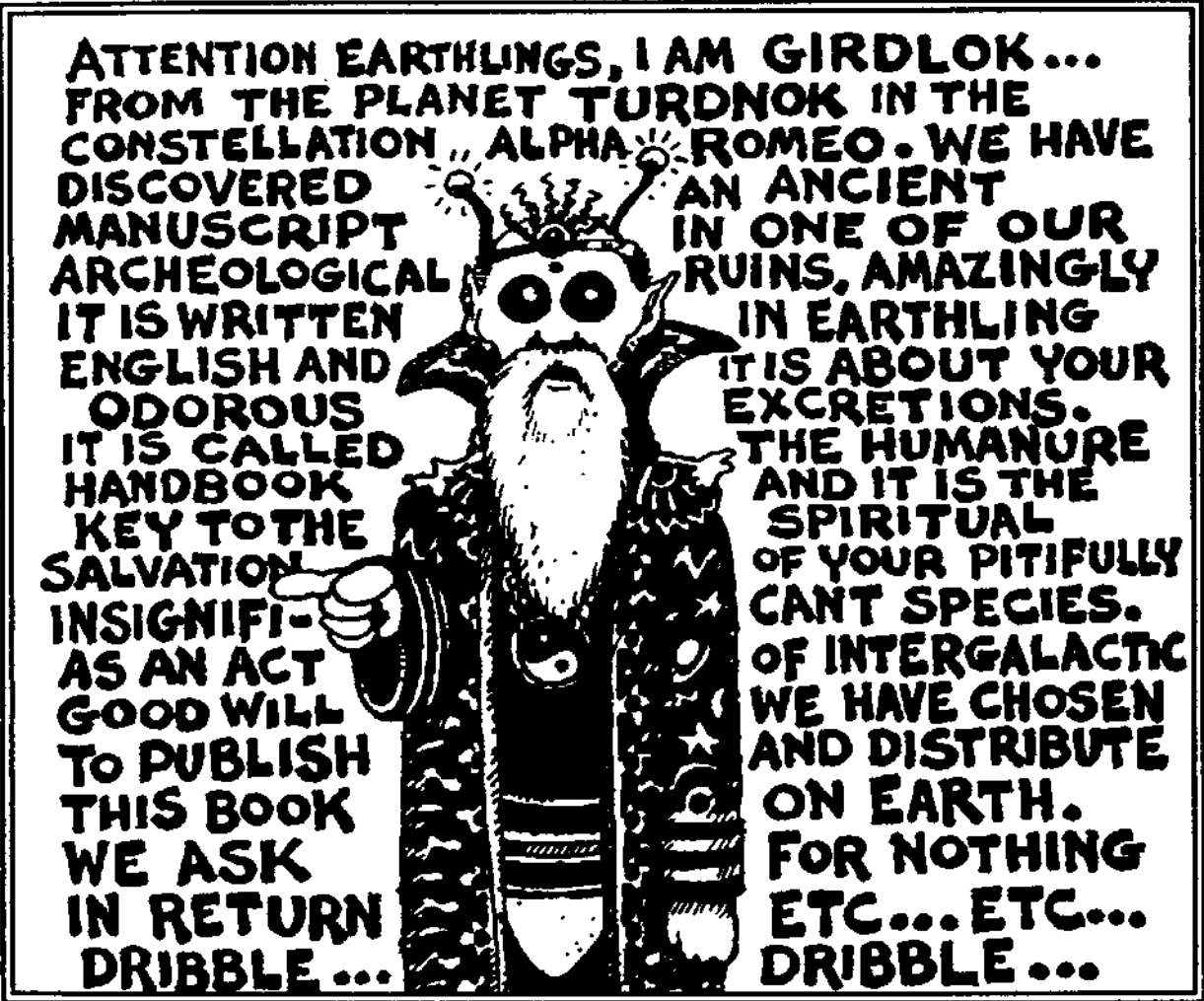
I'll leave you with a quote from Dr. Arthur Stanley, health officer of the city of Shanghai, China, in his annual report for 1899, when the population of China amounted to about 500 million people, roughly double that of the U.S. today, and no artificial fertilizers were being employed for agricultural purposes - only organic, natural materials such as agricultural residues and humanure were being used:

*“Regarding the bearing on the sanitation of Shanghai of the relationship between Eastern and Western hygiene, it may be said, that if prolonged national life is indicative of sound sanitation, the Chinese are a race worthy of study by all who concern themselves with public health. It is evident that in China the birth rate must very considerably exceed the death rate, and have done so in an average way during the three or four thousand years that the Chinese nation has existed. Chinese hygiene, when compared to medieval English, appears to advantage.”<sup>24</sup>*

Sounds like an understatement to me.

## REFERENCES - CHAPTER THREE

- 1 - Rodale, J. I., (1946). Paydirt. Devon-Adair Co.: NY, (p.vi).
- 2 - *Beyond Oil: The Threat to Food and Fuel in the Coming Decades, A summary Report*. November 1986. Carrying Capacity Inc., 1325 G. Street, NW, Suite 1003, Wash. D.C. 10005.
- 3 - King, F.H., (1911). Farmers of Forty Centuries. Rodale Press: Emmaus, PA 18049.
- 4 - Ibid. (p.193, 196-7).
- 5 - Ibid. (p.10).
- 6 - Ibid. (p.19).
- 7 - Ibid. (p.199).
- 8 - Wilson, N.W., (1966). Three Ways of Asian Wisdom. Simon and Shuster: New York. (p.11).
- 9 - Ibid. (p.11-12).
- 10 - Ibid. (p.77-78).
- 11 - Ibid. (p.137).
- 12 - Ibid. (p.145).
- 13 - Ibid. (p.140).
- 14 - Lao Tsu. Tao Te Ching. Vintage Books Edition, 1972. Vintage Books (Random House): New York. (#57).
- 15 - Holy Bible. King James Version. The World Publishing Co.: New York. (p.9).
- 16 - White, A.D. (1955). The Warfare of Science with Theology. George Braziller: New York. (pp.68,70).
- 17 - Ibid. (p.69).
- 18 - Ibid. (p.71).
- 19 - Ibid. (p.73).
- 20 - Ibid. (pp.76-77).
- 21 - Ibid. (p.84).
- 22 - Ibid. (p.85).
- 23 - Seaman, L.C.B. (1973). Victorian England. Methuan & Co.: London. (pp. 48-56).
- 24 - Farmers of Forty Centuries. (p.198).





*The Humanure Handbook - Chapter Four*  
**A DAY IN THE LIFE OF A TURD**

*“Civilization is a limitless multiplication of unnecessary necessities.”*

Mark Twain

*“Most of the luxuries, and many of the so-called comforts of life, are not only not indispensable, but positive hindrances to the elevation of [humanity].”*

Henry David Thoreau

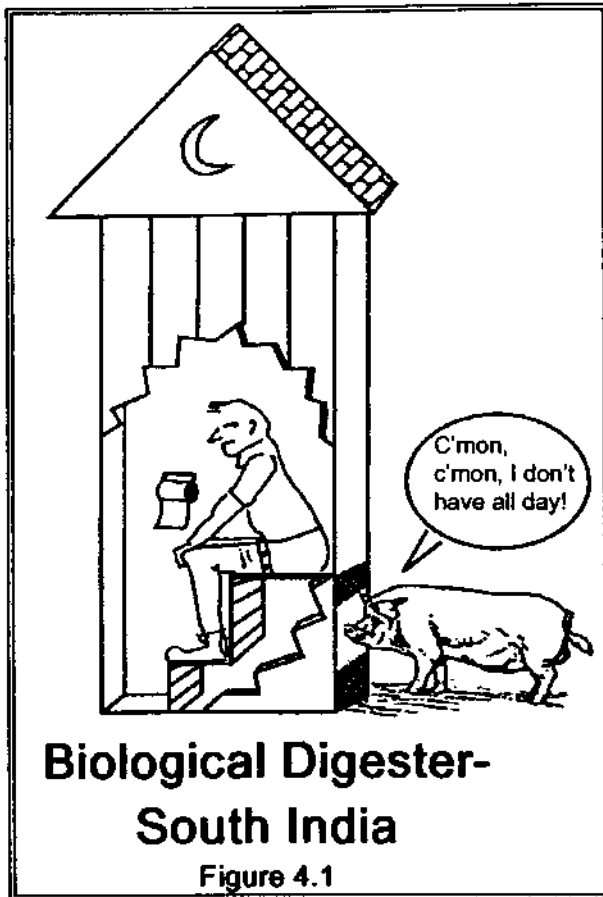


I remember when I was a kid and veterans would talk about their stints in the Korean war. Usually after a beer or two they'd turn their conversation to the “outhouses” used by the Koreans. They were amazed, even mystified about the fact that the Koreans tried to lure passers-by to use their outhouses by making the toilets especially attractive. The idea of someone wanting someone else's shit always brought out a good guffaw from the vets. Only a groveling, impoverished, backward gink would stoop so low as to beg for a turd. Haw, Haw.

Perhaps this attitude sums up the consciousness of Americans. Humanure is a waste product, plain and simple. We have to get rid of it and that's all there is to it. Only fools and scoundrels would think otherwise. One of the effects of this sort of consciousness is that Americans don't know and probably don't care where their organic refuse goes after it emerges from their backsides, so long as they don't have to deal with it.

### ***MEXICAN BIOLOGICAL DIGESTER***

Well, where it goes depends on the type of “waste disposal system” used. Let's start with the simplest: the Mexican biological digester, also known as the stray dog. In India this may be known as the stray pig (see figure 4.1). I spent a few months in southern Mexico in the late 70's in Quintana Roo on the Yucatan peninsula. There, toilets were not available and people simply used the sand dunes on the coast. No problem though, one of the small, unkempt, and ubiquitous Mexican dogs

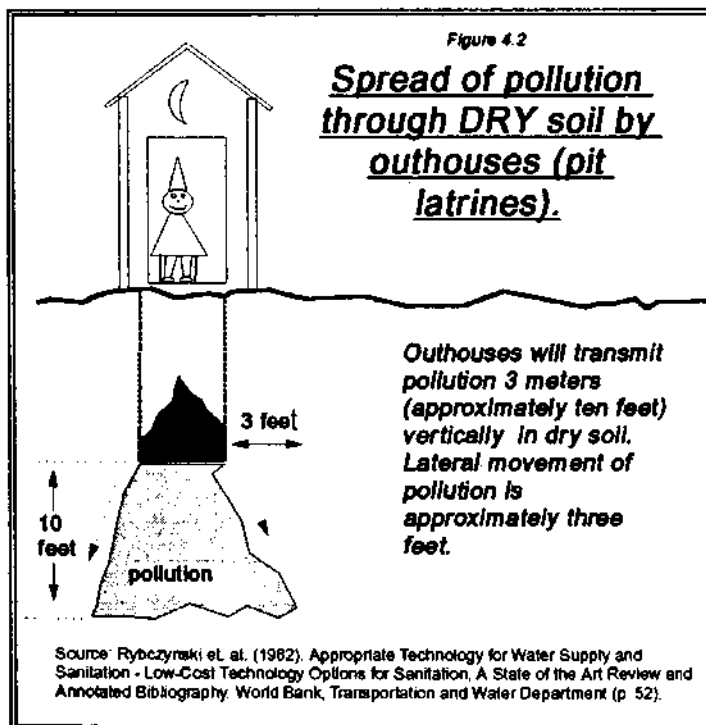


would wait nearby with watering mouth until you've done your thing. Burying your excrement in that situation would have been an act of disrespect to the dog. No one wants sand in their food. A good, healthy, steaming turd at the crack of dawn on the Caribbean coast never lasted more than 60 seconds before it became a hot meal for a human's best friend. Yum.

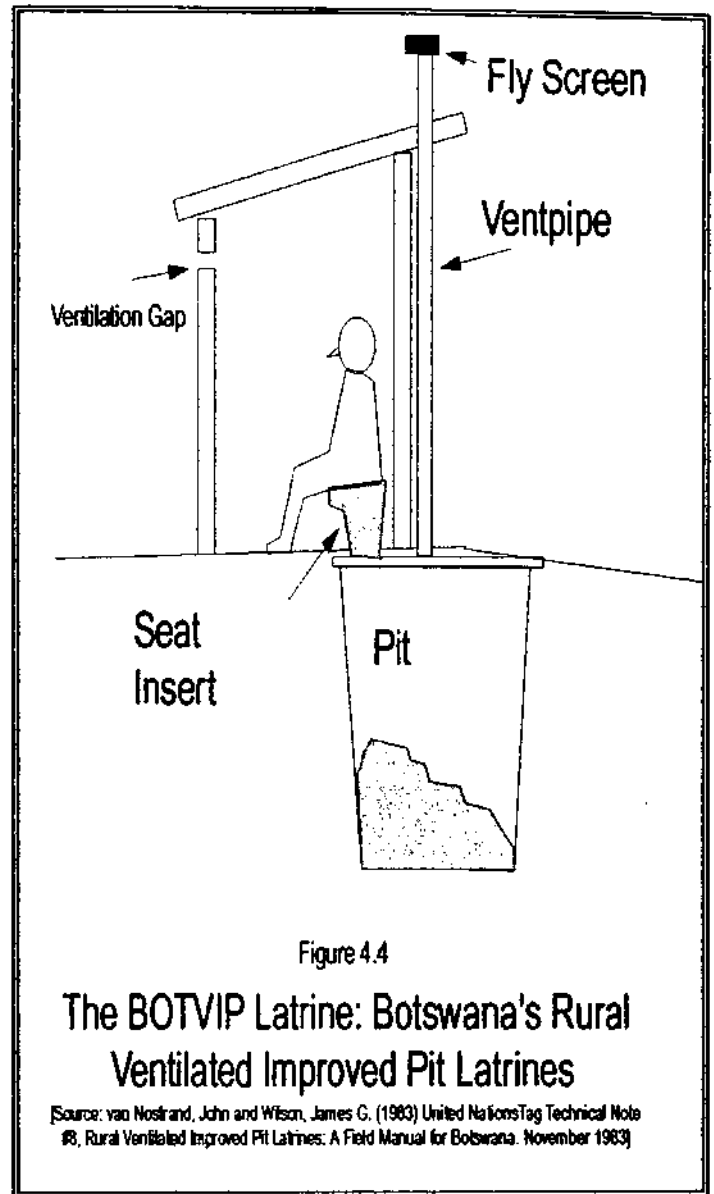
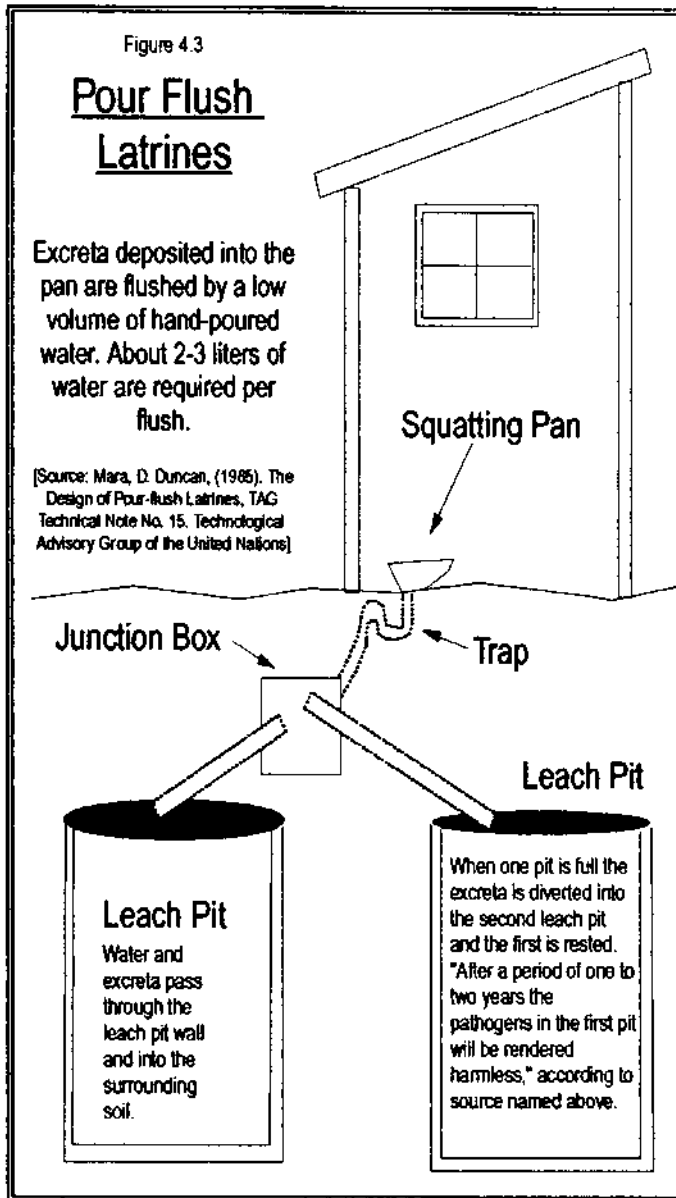
## THE OLD-FASHIONED OUTHOUSE

Next up the ladder of sophistication is the old-fashioned outhouse, which is also known as the pit latrine. Simply stated, one digs a hole and defecates in it, and then does so again and again until the hole fills up. It's nice to have a small building (privy) over the hole to provide some privacy and to keep the elements off. However, the concept is simple: dig a hole and

bury your excrement. Interestingly, this level of sophistication has not yet been surpassed in America. We still bury our excrement, in the form of sewage sludge, in landfill holes. But I'm getting ahead of myself again.



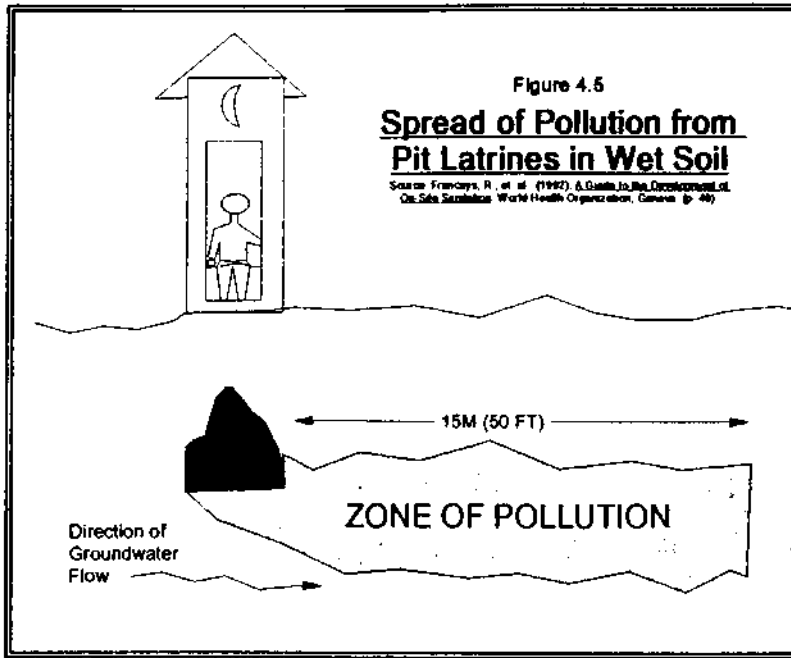
The first farmhouse I lived in during the mid-seventies had an outhouse behind it and no plumbing whatsoever. What I remember most about the outhouse is the smell, which could be described as quite undesirable, to say the least. The flies and wasps weren't very inviting either, and of course the cold weather made the process of "going to the bathroom" uncomfortable. When the hole filled up, I simply dug another hole twenty feet away from the first and dragged the outhouse from one hole to the other. The dirt from the second hole was used to cover the first. The excrement was left in



the ground, probably to contaminate groundwater. Of course, I didn't know I might be contaminating anything because, as I've stated earlier, I had just graduated from college and was quite ignorant about practical matters. Therefore, I plead not guilty to environmental pollution on the grounds of a college education.

Outhouses create very real health, environmental and aesthetic problems. The hole in the ground is accessible to flies and mosquitoes which can transmit disease over a wide area. The pits leak pollutants into the ground even in dry soil. And the smell. *Hold your nose.*

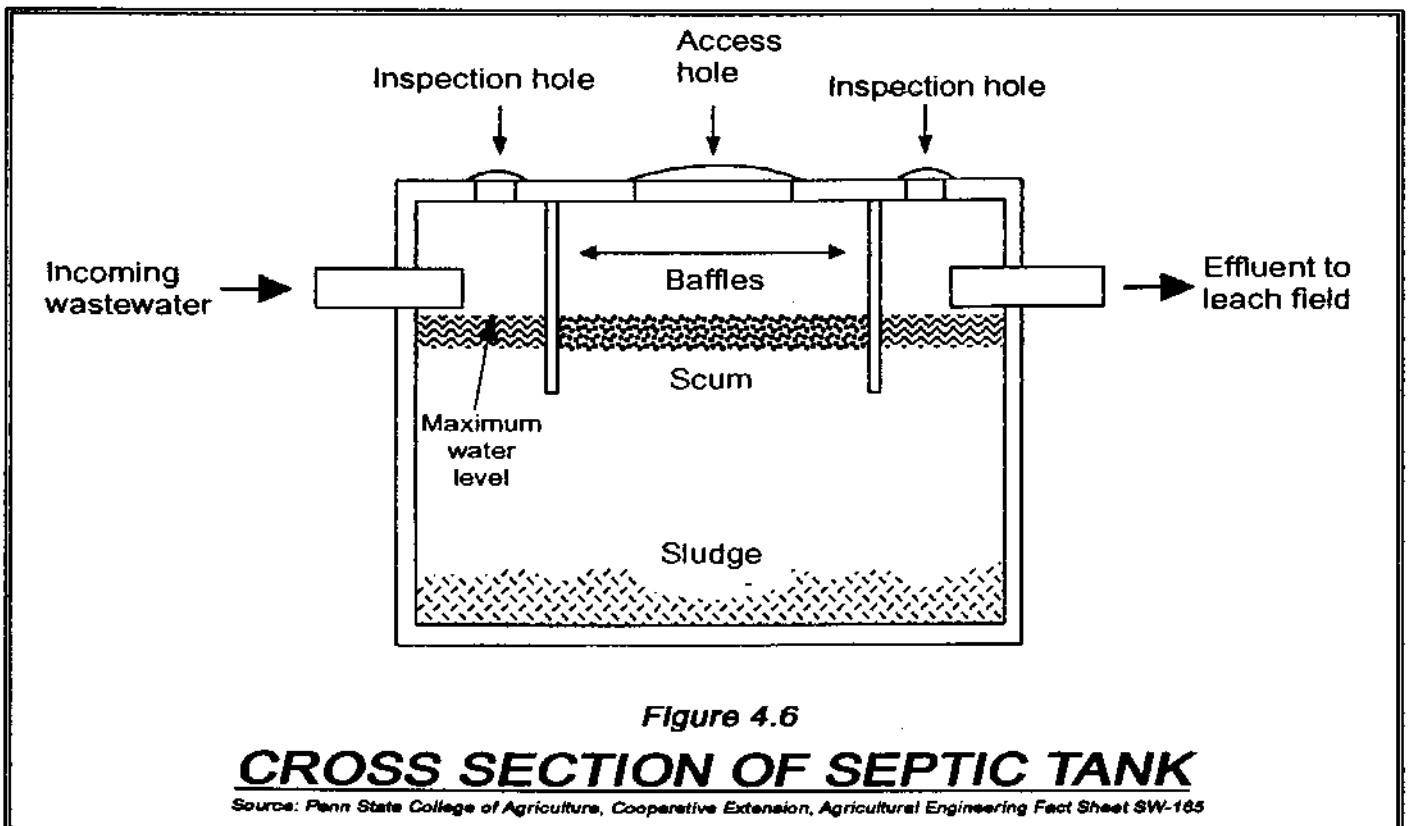
## SEPTIC SYSTEMS



Another step up on the sophistication ladder one finds the septic tank, which is a common method of human waste disposal in rural and suburban areas of the United States. In this technique of organic waste disposal, the turd is deposited into a container of water, usually pure drinking water such as in a toilet, and the water is piped away.

After the turd, now carried by the water, travels away from the house inside a sewage pipe, it

plops into a fairly large underground storage tank, or septic tank, which is usually made of concrete and sometimes of fiberglass. In Pennsylvania (USA), a 900 gallon tank is the minimum size allowed for a home with three or fewer bedrooms.<sup>1</sup> The heavier solids settle to the bottom of the tank and the liquids continue on to drain off into a leach field, which consists of an array of drain pipes situated below the ground surface allowing the liquid to seep out into the soil (see figures 4.6 and 4.7). While in the tank, the wastewater should be undergoing anaerobic decomposition. If septic



tanks fill up, they are pumped out and the waste material is supposed to be trucked to a sewage treatment plant.

### SAND MOUNDS

Some soils drain poorly because they may have a high clay content or may be low-lying or otherwise water impermeable. In the event of poorly drained soil, a standard leach field will not work very well, especially when the ground is saturated with rain water or snow melt. One can't drain

wastewater into soil that is already saturated with water. That's when the *sand mound* sewage disposal system is useful. In this method of waste disposal, when the septic tank isn't draining properly, a pump will kick in and pump the effluent into a pile of sand and gravel above ground (although sometimes a pump isn't necessary and gravity does the job). In the pile of sand is a perforated pipeline which allows the effluent to drain down through the mound. Sand mounds are usually covered with soil and grass. In Pennsylvania, sand mounds must be at least one hundred feet downslope from a well or spring, fifty feet from a stream, and five feet from a property line.<sup>2</sup>

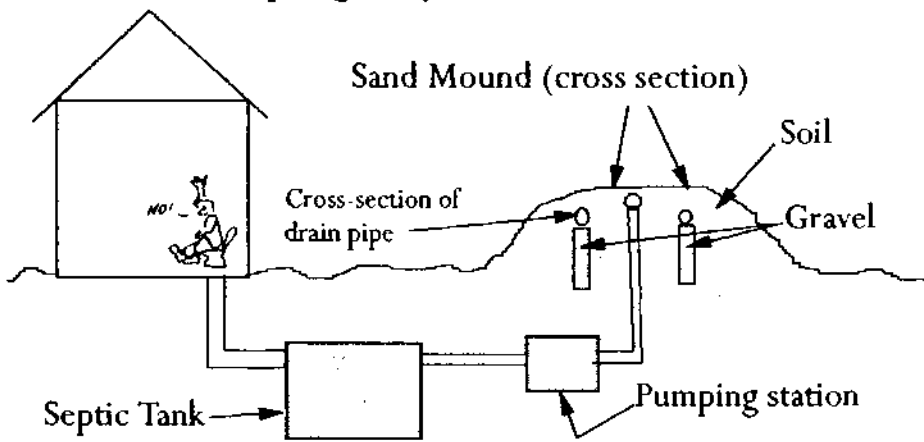
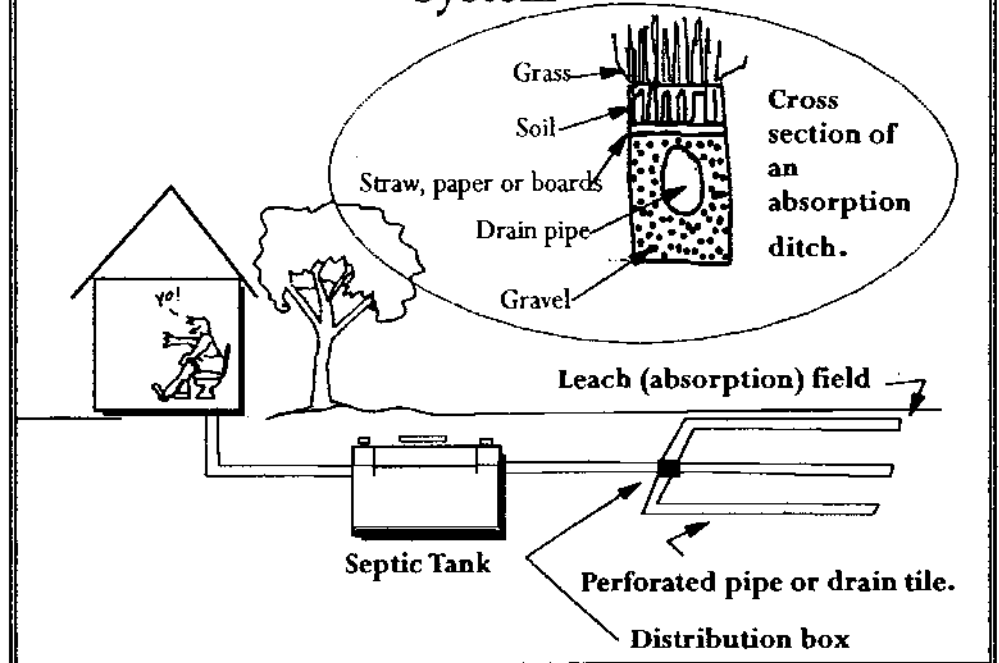


Figure 4.8

### Sand Mound (or Trench Mound) Waste Distribution System

Figure 4.7

### Septic Tank Gravity Distribution System



According to local excavating contractors, sand mounds cost \$5,000 to \$12,000 to construct (1993). They must be built to exact government specifications, and aren't usable until they pass an official inspection (see figure 4.8).

## GROUND WATER POLLUTION FROM SEPTIC SYSTEMS

We civilized humans started out by defecating into a hole in the ground (outhouse), then discovered we could float our turds out to the hole using water and never have to leave the house. However, one of the unfortunate problems with septic systems is, like outhouses, they pollute our groundwater.



**IF you have a  
Septic Tank System...**

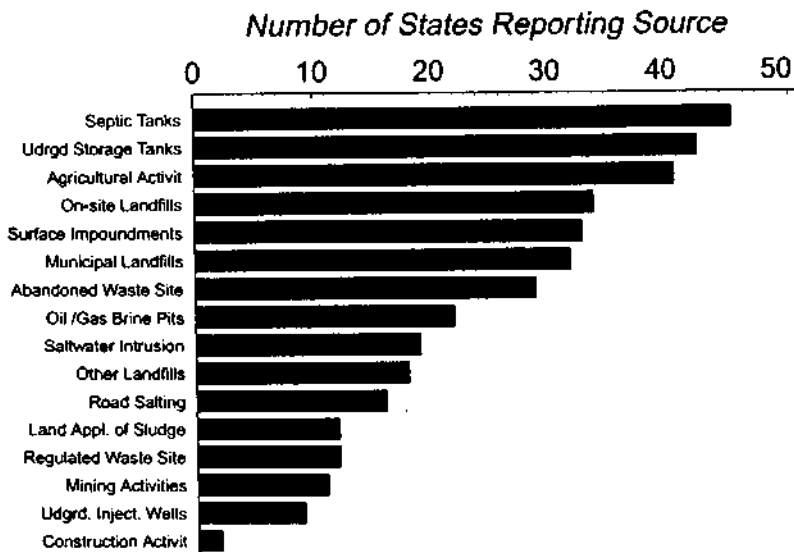
There are currently 22 million septic system sites in the United States issuing contaminants such as bacteria, viruses, nitrates, phosphates, chlorides, and organic compounds such as trichloroethylene into the environment. An EPA study of chemicals in septic tanks found toluene, methylene chloride, benzene, chloroform, and other volatile synthetic organic compounds related to home chemical use.<sup>3</sup> Between 820 and 1,460 billion gallons of this contaminated water are discharged per year to our shallowest aquifers.<sup>4</sup> According to the EPA, states reported septic tanks as a source of ground water contamination more than any other source, with 46 states citing septic systems as sources

of groundwater pollution, and nine of these reporting them to be the primary source of groundwater contamination in their state<sup>5</sup> (see figures 4.9 and 4.10).

The word "septic" comes from the Greek "septikos" which means "to make putrid". Today it still means "causing putrefaction", putrefaction being "the decomposition of organic matter resulting in the formation of foul-smelling products" (see

Figure 4.9

### Sources of Ground-Water Contamination in the United States



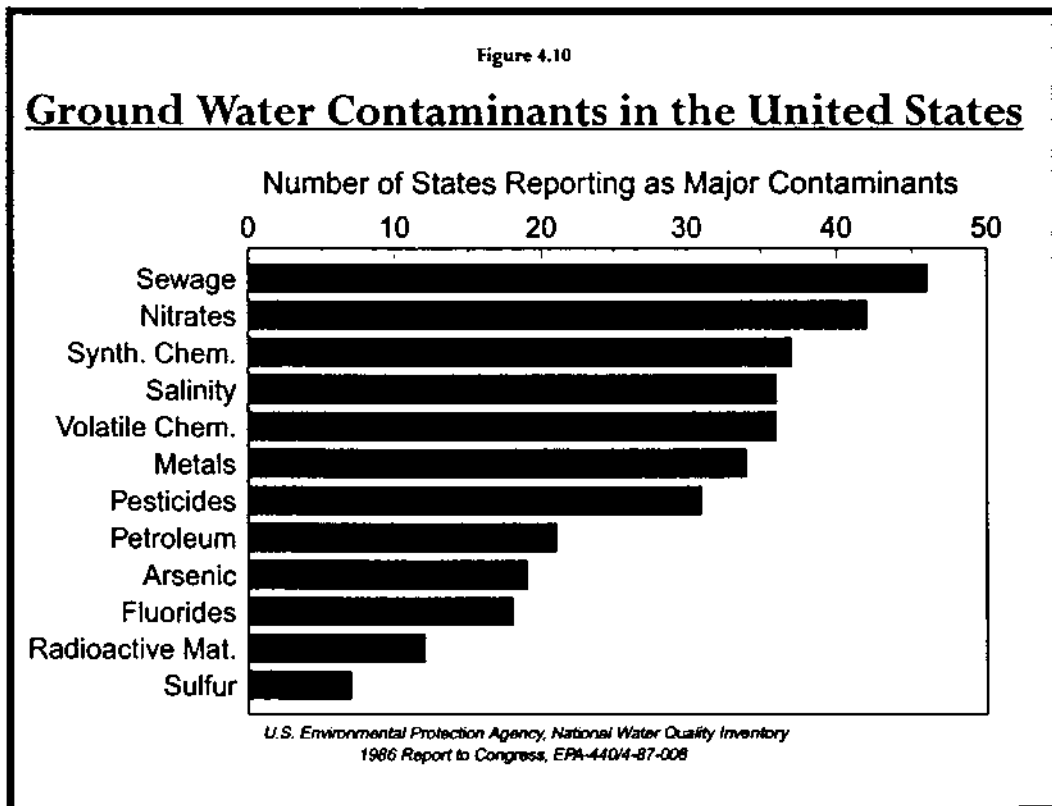
Source: U.S. Environmental Protection Agency, National Water Quality Inventory  
1986 Report to Congress, EPA-440/4-87-008

Webster). Septic systems are not designed to destroy human pathogens that may be in the human waste that enters the septic tank. Septic systems are instead designed to collect human wastewater, settle out the solids and anaerobically digest them to some extent, and then leach the effluent into the ground. Therefore, septic systems can be highly pathogenic, allowing the transmission of disease-causing bacteria, viruses, protozoa and intestinal parasites through the system.

One of the main problems associated with septic systems is the problem of human population density. Too many septic systems in any given area will overload the soil's natural purification systems and allow large amounts of wastewater to contaminate the underlying watertable. A density of more than forty household septic systems per square mile will cause an area to become a likely target for subsurface contamination, according to the EPA.<sup>6</sup>

Toxic synthetic organic chemicals are commonly released into the environment from septic systems because people dump toxic chemicals down their drains. The chemicals are found in pesticides, paint and coating products, toilet cleaners, drain cleaners, disinfectants, laundry solvents, many other cleaning solutions, antifreeze, rust proofers, even septic tank and cesspool cleaners. In fact, over 400,000 gallons of septic tank cleaner liquids containing synthetic organic chemicals were used in one year by just the residents of Long Island alone. Furthermore, some synthetic organic chemicals can corrode pipes thereby causing even more heavy metals to enter septic systems.<sup>7</sup>

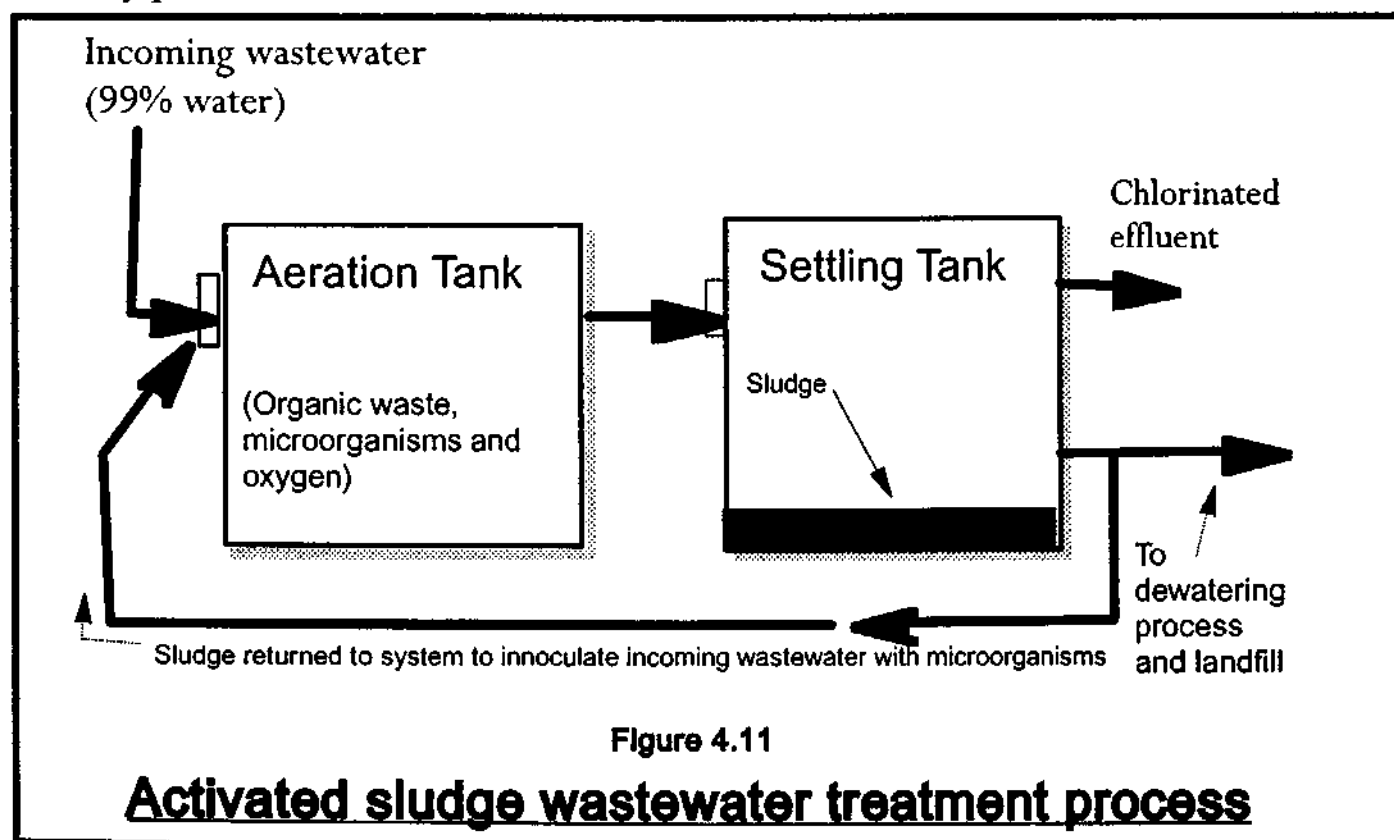
In many cases, people who have septic tanks are forced to connect to sewage lines when the lines are made available to them. A U.S. Supreme Court case in 1992 reviewed a situation whereby town members in New Hampshire had been forced to connect to a sewage line that simply discharged untreated, raw sewage into the Connecticut River for 57 years. Despite the crude



method of sewage disposal, state law required properties within 100 feet of the town sewer system to connect to the system when it was built in 1932. This sewage disposal system apparently continued to operate in this barbaric manner until 1989, when state and federal sewage treatment laws forced a stop to the dumping of raw sewage into the river.<sup>8</sup>

## WASTEWATER TREATMENT PLANTS

There's still another step up the ladder of wastewater treatment sophistication: the wastewater treatment plant, or sewage plant. The wastewater treatment plant is like a huge, very sophisticated septic tank, because it collects the water-borne excrement of large numbers of humans. Inevitably, when one defecates or urinates into water, one pollutes the water. Therefore, that "wastewater" must somehow be rendered fit to return to the environment in order to avoid environmental pollution. The liquid entering the wastewater treatment plant is 99% water because all sink water, bath water and everything else that goes down one's drain ends up at the plant too, which is why it's called a *water* treatment plant. In some cases, storm water runoff also enters wastewater treatment plants via *combined sewers*. Also, a lot of contaminants can and do enter this wastewater stream from industries, hospitals, gas stations, and any place with a drain.





Many modern wastewater plants use a process of activated sludge treatment whereby oxygen is vigorously bubbled through the wastewater in order to activate microbial digestion of the solids. This aeration stage is combined with a settling stage that allows the solids to be removed. The removed solids (sludge) are either used to reinoculate the incoming wastewater, or they're dewatered to the consistency of a dry mud and buried in landfills (see figure 4.11). Sometimes the sludge is applied to agricultural land. The microbes that digest the sludge consist of bacteria, fungi, protozoa, rotifers, and nematodes.<sup>9</sup> The water left behind is treated (usually with chlorine) and discharged into a stream, river, or other body of water. Sewage treatment water releases to surface water in the United States in 1985 amounted to nearly *31 billion gallons per day*.<sup>10</sup>

U.S. sewage treatment plants generated about 7.6 million dry tons of sludge in 1989.<sup>11</sup> New York City alone produces 143,810 dry tons of sludge every year.<sup>12</sup> In 1993, the amount of sewage sludge produced annually in the U.S. was 110-150 million wet metric tons. Incidentally, the amount of toilet paper used (1991) to send all this waste to the sewers was 2.3 million tons.<sup>13</sup>

## CHLORINE

Wastewater leaving wastewater treatment plants is often treated with chlorine before being released into the environment. For this reason, the act of defecating into water often ultimately contributes to the contamination of water resources with *chlorine* in addition to feces.

Chlorine, used since the early 1900's, is one of the most widely produced industrial chemicals with about 10 million metric tons manufactured in the U.S. each year - \$72 billion worth.<sup>14</sup> Approximately 5% of the chlorine manufactured is used for wastewater treatment and drinking water "purification", amounting to about 1.2 billion pounds annually. The lethal liquid or green gas is mixed with the wastewater from sewage treatment plants, in order to kill disease causing microorganisms, before the water is discharged into streams, lakes, rivers and seas. It is also added to household drinking water via household and municipal water treatment systems.

Chlorine (CL<sub>2</sub>) doesn't exist in nature. It's a potent poison which reacts with water to produce a strongly oxidizing solution that can damage the moist tissue lining of the human respiratory tract. Ten to twenty parts per million (ppm) of chlorine gas in air rapidly irritates the respiratory tract, and even brief exposure at levels of 1,000 ppm (one part in a thousand) can be fatal.<sup>15</sup> Chlorine also kills fish, and reports of fish kills caused chlorine to come under the scrutiny of scientists in the 1970's.

The fact that harmful compounds are formed as *by-products* of chlorine use also raises concern. In 1976, the U.S. Environmental Protection Agency (EPA) reported that chlorine use not only poisoned fish, but could also cause the formation of cancer-causing compounds such as chloroform. Some known effects of chlorine-based pollutants on animal life include memory problems, stunted growth and cancer in people; reproductive problems in minks and otters; reproductive problems, hatching problems and death in lake trout; and embryo abnormalities and death in snapping turtles.<sup>16</sup>

In a national study of 6,400 municipal wastewater treatment plants, the EPA estimated that two thirds of them used too much chlorine, which exerts lethal effects at all levels of the food chain. Chlorine damages the gills of fish, inhibiting their ability to absorb oxygen. It also can cause behavioral changes in fish, thereby affecting migration and reproduction. Chlorine in streams can create chemical “dams” which prevent the free movement of some migratory fish. Fortunately, since 1984, there has been a 98% reduction in the use of chlorine by sewage treatment plants, although chlorine use continues to be a widespread problem because a lot of wastewater plants are still discharging it into small receiving waters.<sup>17</sup>

Another controversy associated with chlorine use involves “dioxin”, which is a common term for a large number of chlorinated chemicals that are classified as possible human carcinogens by the EPA. It’s known that dioxins cause cancer in laboratory animals, but their effects on humans are still being debated. Dioxins, byproducts of the chemical manufacturing industry, are present in the total environment, and are concentrated through the food chain where they’re deposited in human fat tissues. A key ingredient in the formation of dioxin is chlorine, and indications are that an increase in the use of chlorine results in an increase in the dioxin content of the environment, even in areas where the only dioxin source is the atmosphere.<sup>18</sup> Dioxins are unintended byproducts of chlorine use.

In the upper atmosphere, chlorine molecules gobble up ozone, in the lower atmosphere they bond with carbon to form organochlorines. Some of the 11,000 commercially used organochlorines include hazardous compounds such as DDT, PCBs and carbon tetrachloride. Organochlorines rarely occur in nature, and living things have little defense against them. They’ve been linked not only to cancer, but also to neurological damage, immune suppression, and reproductive and developmental effects. When chlorine products are washed down the drain to a septic tank, they’re producing organochlorines.

*“Any use of chlorine results in compounds that cause a wide range of ailments,”* says Joe Thorton, a Greenpeace researcher, who adds, *“Chlorine is simply not compatible with life. Once you create it you can’t control it.”*<sup>19</sup>

There’s no doubt that our nation’s sewage treatment systems are polluting our

drinking water sources with pathogens (see chapter 6). As a result, chlorine is also being used to disinfect *the water we drink* as well as to disinfect discharges from wastewater treatment facilities.



According to a 1992 study, *chlorine is added to 75% of the nation's drinking water* and is linked to cancer. The results of the study suggested that at least 4,200 cases of bladder cancer and 6,500 cases of rectal cancer each year in the U.S. are associated with consumption of chlorinated drinking water.<sup>20</sup>

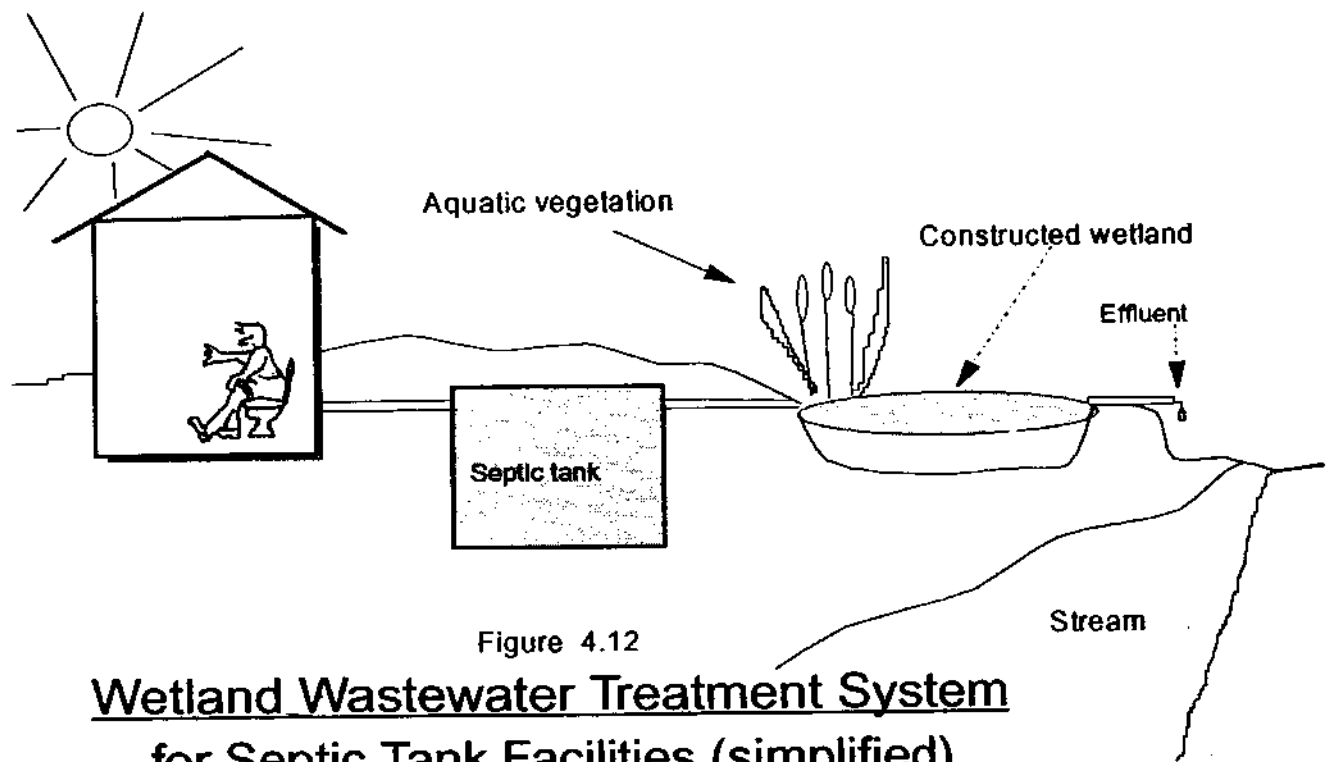
In December, 1992, the U.S. Public Health Service reported that pregnant women who routinely drink or bathe in chlorinated tap water are at a greater risk of bearing premature or small babies, or babies with congenital defects.<sup>21</sup>

According to a spokesperson for the chlorine industry, 87% of water systems in the U.S. use free chlorines, and 11% use chloramines. Chloramines are a combination of chlorine and ammonia. The chloramine treatment is becoming more widespread due to the health concerns over chlorine.<sup>22</sup> However, EPA scientists admit that we're pretty ignorant about the potential byproducts of the chloramine process, which involves ozonation of the water prior to the addition of chloramine.<sup>23</sup>

Of course, we don't have to worry. The government will take care of us, and if the government doesn't, then industry will. Won't they? Well, not exactly. According to a U.S. General Accounting Office report in 1992, consumers are poorly informed about potentially serious violations of drinking water standards. In a review of twenty water systems in six states, out of 157 drinking water quality violations, the public received a timely notice in only 17 of the cases.<sup>24</sup>

## **ALTERNATIVE WASTEWATER TREATMENT SYSTEMS**

New systems are being developed to purify wastewater. One popular experimental system today is the *constructed, or artificial wetlands system*, which runs wastewater through an aquatic environment consisting of aquatic plants such as water hyacinths, bullrushes, duckweed, lilies, and cattails (see figure 4.12). The plants act



as marsh filters, and the microbes which thrive on their roots do most of the work. They break down nitrogen and phosphorous compounds as well as toxic chemicals. Although they don't break down heavy metals, the plants absorb them, and they can then be harvested and incinerated or landfilled.<sup>25</sup>

According to EPA officials, the emergence of constructed wetlands technology shows great potential as a cost effective alternative to wastewater treatment. The wetlands method is said to be relatively affordable, energy efficient, practical and effective. However, scientists don't yet have the data to determine with assurance the performance expectations of wetlands systems, or contaminant concentrations released by these systems into the environment. However, the treatment efficiency of properly constructed wetlands is said to compare well with conventional treatment systems.<sup>26</sup> Unfortunately, wetlands systems don't recover the agricultural resources available in humanure.

Another system uses solar powered greenhouse-like technology to treat wastewater. This system uses hundreds of species of bacteria, fungi, protozoa, snails, plants and fish, among other things, to produce advanced levels of wastewater treatment. These solar aquatics systems are also experimental, but appear hopeful.<sup>27</sup> Again, the agricultural resources of humanure are lost when using this or any disposal method or wastewater treatment technique instead of a humanure recycling method.

## AGRICULTURAL USE OF SEWAGE SLUDGE

Now here's where a thoughtful person may ask, "Why not put *sewage sludge* back into the soil for agricultural purposes?"

One reason: government regulation. When I asked the supervisor of my local wastewater treatment plant if the one million gallons of sludge the plant produces each year (for a population of 8,000) was being applied to agricultural land, he said, "*It takes six months and five thousand dollars to get a permit for a land application. Another problem is that due to regulations, the sludge can't lie on the surface after it's applied so it has to be plowed under shortly after application. When farmers get the right conditions to plow their fields, they plow them. They can't wait around for us, and we can't have sludge ready to go at plowing time.*" It may be just as well.

Sewage sludge is a lot more than organic human refuse. It can contain DDT, PCBs, mercury, other heavy metals, and the like.<sup>28</sup> One scientist alleges that more than 20 million gallons of used motor oil are dumped into sewers every year in the United States.<sup>29</sup> America's largest industrial facilities released over 550 million pounds of toxic pollutants into U.S. sewers in 1989 alone, according to the U.S. Public Interest Research Group. In 1987, 614 million pounds of toxic pollutants were released into sewers, and in 1988, another 570 million pounds were released, although the actual levels of toxic discharges are said to be much higher than these.<sup>30</sup> Of the top ten states responsible for toxic discharges to public sewers in 1991, Michigan took the cake with nearly 80 million pounds, followed in order by New Jersey, Illinois, California, Texas, Virginia, Ohio, Tennessee, Wisconsin and Pennsylvania (around 20 million pounds from PA).<sup>31</sup>

An interesting study on the agricultural use of sludge was done by a Mr. Purves in Scotland. He began applying sewage sludge at the rate of 60 tons per acre to a plot of land in 1971. After fifteen years of treating the soil with the sludge, he tested the vegetation grown on the plot for heavy metals. On finding that the heavy metals (lead, copper, nickel, zinc and cadmium) had been taken up by the plants, he concluded, "*Contamination of soils with a wide range of potentially toxic metals following application of sewage sludge is therefore virtually irreversible.*"<sup>32</sup> In other words, the heavy metals don't wash out of the soil, they enter the food chain.

Other studies have shown that heavy metals accumulate in the vegetable tissue of the plant to a much greater extent than in the fruits, roots or tubers. Therefore, if one must grow food crops on soil fertilized with sewage sludge contaminated with heavy metals, one might be wise to produce carrots or potatoes instead of lettuce.<sup>33</sup> Guinea pigs experimentally fed with swiss chard grown on soil fertilized with sewage sludge showed no observable toxicological effects, however their adrenals showed

elevated levels of antimony, their kidneys had elevated levels of cadmium, there was elevated manganese in the liver and elevated tin in several other tissues.<sup>34</sup>

Furthermore, *"the fact that sewage sludge contains a large population of fecal coliforms renders it suspect as a potential vector of bacterial pathogens and a possible contaminant of soil, water and air, not to mention crops. Numerous investigations in different parts of the world have confirmed the presence of intestinal pathogenic bacteria and animal parasites in sewage, sludge, and fecal materials."*<sup>35</sup> (See chapter 6)

Another interesting study was published in 1989 indicating that the bacteria that survive in sewage sludge show a high level of resistance to antibiotics, especially penicillin, one of the most commonly used. The theory is this: because heavy metals are concentrated in sludge during the treatment process, the bacteria that survive in the sludge can obviously resist heavy metal poisoning. But these same bacteria also show an inexplicable resistance to antibiotics, suggesting that somehow the resistance of the two environmental factors are related in the bacterial strains that survive. The implication is that sewage sludge selectively breeds antibiotic-resistant bacteria, which may enter the food chain if the agricultural use of the sludge becomes widespread. The results of the study indicated that more knowledge of antibiotic-resistant bacteria in sewage sludge should be acquired before sludge is disposed of on land, as this method of disposal can be dispersing countless antibiotic resistant bacteria into the environment.<sup>36</sup>

This poses somewhat of a problem. Collecting human excrement with wastewater and industrial pollutants seems to render the organic refuse incapable of being adequately sanitized. It becomes contaminated enough to be unfit for agricultural purposes. As a consequence, sewage sludge is not highly sought after as a soil additive. For example, the state of Texas sued the U.S. EPA in July of 1992 for failing to study environmental risks before approving the spreading of sewage sludge in west Texas. Sludge was being spread on 128,000 acres there by an Oklahoma firm, but the judge nevertheless refused to issue an injunction to stop the spreading.<sup>37</sup> Considering that the sludge was from New York City, who can blame the Texans?

Now that ocean dumping of sludge has been stopped, where's it going to go? Researchers at Cornell University have suggested that sewage sludge can be disposed of by surface applications in forests. Their studies suggest that brief and intermittent applications of sludge to forestlands won't adversely affect wildlife, despite the nitrates and heavy metals that are present in the sludge. They point out that the need to find ways to get rid of sludge is compounded by the fact that many landfills are expected to close over the next several years and ocean dumping is now banned. Some sources say that landfills in the U.S. are being closed permanently at the rate of

two per day.<sup>38</sup> In a report to congress by the EPA in 1989, 45% of the landfills then currently in operation were expected to be closed by 1991.<sup>39</sup>

Under the Cornell model, one dry ton of sludge could be applied to an acre of forest each year.<sup>40</sup> New York state alone produces 370,000 tons of dry sludge per year, which would require 370,000 acres of forest each year for New York state sludge disposal. Then there are the other forty-nine states and the 7.6 million dry tons of sludge produced in the U.S.. Then there's figuring out how to get the sludge into the forests and how to spread it around. With all this in mind, a guy has to stop and wonder. The woods used to be the only place left to get away from it all.\*

The problem of treating and dumping sludge isn't the only one. The costs of maintenance and upkeep of wastewater treatment plants is another. According to a report issued by the EPA in 1992, U.S. cities and towns need as much as \$110.6 billion over the next twenty years for enlarging, upgrading, and constructing wastewater treatment facilities.<sup>41</sup>

Ironically, when sludge is *composted*, it may help to keep heavy metals *out* of the food chain. According to a 1992 report, composted sludge lowered the uptake of lead in lettuce that had been deliberately planted in lead-contaminated soil. The lettuce grown in the contaminated soil to which composted sludge had been added had a 64% lower uptake of lead than lettuce planted in the same soil but without the compost. The composted soil also lowered lead uptake in spinach, beets and carrots by more than 50%.<sup>42</sup> Three cheers for compost!

Some scientists claim that the composting process transforms heavy metals into benign materials. According to Joseph C. Horvath, a soil and compost scientist who designs facilities that compost sewage sludge, *"at the final product stage, these [heavy] metals actually become beneficial micro-nutrients and trace minerals that*

## SEWER TROUBLE?

**"Root Eliminator" KEEPS Sewers & Septic Tanks OPEN**

Easy-to-use chemical prevents and frees stoppage of sewer by roots. Just drop one soluble briquette in your lavatory monthly.

**A year's supply for only \$3.95**

Show this ad to your local store, or mail your order direct to us. Sent promptly, postpaid.



*BETTER LIVING THROUGH CHEMICALS*

**MONEY BACK GUARANTEE**

## Dripless toilets China's top priority

**BEIJING, June 7** — With oceans of scarce water literally going down China's drains, Communist Party chief Jiang Zemin has made the dripless toilet a national priority. "If the country can send satellites and missiles into space, it should be able to dry up its latrines," today's China Daily quoted Jiang as saying. The Construction Ministry estimates leaky toilets sold by negligent manufacturers waste 200 million cubic meters of water a year. Vice Minister of Construction Ye Rutang launched a purge of leaky and sub-standard toilet hardware. Three hundred of China's 570 cities, including the capital, Beijing, face serious water shortages, China Daily said.

(From a Saudi Arabian newspaper, 1994)

add to the productivity of soil. This principal is now finding acceptance in the scientific community of the USA and is known as biological transmutation, or also known as the Kervran-Effect." Composted sewage sludge that is microbiologically active can also be used to detoxify areas contaminated with nuclear radiation or oil spills, according to Dr. Horvath. Clearly, the composting of sewage sludge is a grossly underutilized alternative to landfill application, and it should be strongly promoted.\*\*

## GLOBAL SEWERS AND PET TURDS


Let's assume that the whole world adopted the sewage philosophy we have in the United States: defecate into water and then treat the polluted water. What would that scenario be like? Well, for one thing it wouldn't work. It takes between 1,000 and 2,000 tons of water at various stages in the process to flush one ton of humanure. In a world of just five billion people producing a conservative estimate of one million metric tons of human excrement daily, the amount of water required to flush it all would not be obtainable.<sup>43</sup> When one adds to this equation the increasing landfill space that would be needed to dispose of the increasing amounts of sewage sludge, and the tons of toxic chemicals required to "sterilize" the wastewater, then one can

see that this system of human waste disposal is not sustainable and will not serve the needs of humanity in the long term.

As one person puts it, "Conventional 'Western' methods of waterborne sewerage are simply beyond the reach of most [of the world's] communities. They are far too expensive. And they often demand a level of water use that local water resources cannot supply. If Western standards were made the norm, some \$200 billion alone [early 1980's] would have to be invested in sewerage to achieve the target of basic sanitation for all. Resources on this scale are simply not in sight." (Barbara Ward, President of the International Institute for Environment and Development).

To quote Lattee Fahm, "In today's

**TRICKLING ...**



**NOISY?  
TOILET**

**GET THE  
GENUINE**

**WATER  
MASTER**

**America's Largest Selling  
TOILET TANK BALL**

Noisy running toilets can waste over 1000 gallons of water a day. Stop this annoying noise, waste and expense. The amazing patented Water-Master Tank Ball instantly stops the flow of water after each flushing, stops the flow everytime, not just some of the time.

**75c at hardware stores EVERYWHERE**  
Higher in Canada



*world [1980], some 4.5 billion people produce excretal matters at about 5.5 million metric tons every twenty-four hours, close to two billion metric tons per year.*

*[Humanity] now occupies a time/growth dimension in which the world population doubles in thirty five years or less. In this new universe, there is only one viable and ecologically consistent solution to the body waste problems - the processing and application of [humanure] for its agronutrient content.”<sup>44</sup>* In other words, we have to understand that humanure is a natural substance, produced by a process vital to life (human digestion), originating from the earth in the form of food, and valuable as an organic refuse material that can be returned to the earth in order to produce more food for humans. That’s where composting comes in.

But hey, wait, let’s not be rash. We forgot about incinerating our excrements. We can dry our turds out, then truck them to big incinerators and burn the hell out of them. That way, instead of having fecal pollution in our drinking water or forests, we can breathe it in our air. Unfortunately, burning sludge with other municipal waste produces *emissions* of: particulate matter, sulfur dioxide, nitrogen oxides, carbon monoxide, lead, volatile hydrocarbons, acid gasses, trace organic compounds and trace metals. The left-over *ash* has a high concentration of heavy metals, such as cadmium and lead.<sup>45</sup> Doesn’t sound so good if you live downwind, does it?

How about microwaving it? Don’t laugh, someone’s already invented the microwave toilet.<sup>46</sup> This just might be a good cure for hemorrhoids, too. But heck, let’s get serious and shoot it into outer space. Why not? It probably wouldn’t cost too much per fecal log after we’ve dried the stuff out. This could add a new meaning to the phrase “the Captain’s log”. Beam up another one, Scotty!

Better yet, we can dry our turds out, chlorinate them, get someone in Taiwan to make little plastic sunglasses for them, and we’ll sell them as pet turds! Now that’s a realistic entrepreneurial solution, isn’t it? Any volunteer investors out there?



## REFERENCES - CHAPTER FOUR

- 1 - Mancini, K. *Septic Tank - Soil Absorption Systems*. Agricultural Engineering Fact Sheet SW-44. Penn State College of Agriculture Cooperative Extension, University Park, PA 16802.
- 2 - Mancini, K. *Mound Systems for Wastewater Treatment*. SW-43. Same as above.
- 3 - Stewart, J.G. (1990). Drinking Water Hazards: How to Know if There Are Toxic Chemicals in Your Water and What to Do If There Are. Envirographics: Hiram, Ohio. (pp.177-178).
- 4 - van der Leeden, F. et al. (1990). The Water Encyclopedia. Lewis Publishers Inc.: Chelsea, Michigan, 48118. (p.526).
- 5 - Ibid. (p.525).
- 6 - Stewart, John G. (as in #3 above, same pages).
- 7 - Ibid.
- 8 - *Environmental Reporter*. 2/28/92. The Bureau of National Affairs, Inc., Washington D.C., (pp. 2441-2).
- 9 - Gray, N.F. (1990). Activated Sludge Theory and Practice. Oxford University Press: New York. (p.125).
- 10 - van der Leeden, F. et al. (1990). The Water Encyclopedia Second Edition. Lewis Publishers, 121 South Main Street, Chelsea, Michigan 48118 (p. 541).
- 11 - *Journal of Environmental Health*. July/August 1989. "EPA Proposes New Rules for Sewage Sludge Disposal". (P.321).
- 12 - Logan, W.B. (1991). "Rot is Hot". *New York Times Magazine*. 9/8/91 Vol. 140, Issue 4871, p.46.
- 13 - *Garbage*. February/March 1993. Old House Journal Corp., 2 Main St., Gloucester, MA 01930. (p.18).
- 14 - Manahan, S.E. (1990). Hazardous Waste Chemistry, Toxicology and Treatment. Lewis Publishers, Inc.: Chelsea, Michigan. (p.131).
- 15 - Ibid. (pp. 148-49).
- 16 - Baumann, Marty. *USA Today*. Feb 2, 1994, p. 1A, 4A. USA Today (Gannet Co. Inc.) 1000 Wilson Blvd., Arlington, VA 22229.
- 17 - "The Perils of Chlorine". *Audubon Magazine*, 93:30-2. Nov/Dec 1991.
- 18 - Liptak, B.G. (1991). Municipal Waste Disposal in the 1990's. Chilton Book Co.: Radnor, PA. (pp.196-8).
- 19 - Stiak, J. "The Trouble With Chlorine". *Buzzworm*. Nov/Dec 1992. (p.22).
- 20 - *Environmental Reporter*. 7/10/92. (p.767).
- 21 - *Buzzworm*. March/April 1993. (p.17).
- 22 - *Environmental Reporter*. 7/10/92. (p.767).
- 23 - Ibid. 4/24/92. (p.2879).
- 24 - Ibid. 8/7/92. (p.1155).
- 25 - Burke, W.K. "A Prophet of Eden". *Buzzworm*. Vol. IV, Number 2, March/April 1992. (pp.18-19).
- 26 - *Environmental Reporter*. 8/7/92. (P.1152).
- 27 - Ibid. 5/15/92. (p.319).

- 28 - Ibid. 3/6/92 (p. 2474) and 1/17/92 (p.2145).
- 29 - Ibid. 1/3/92 (p.2109).
- 30 - Ibid. 11/1/91 (p.1657).
- 31 - Hammond, A. et al. (Eds.) (1993). The 1993 Information Please Environmental Almanac. Compiled by the World Resources Institute. Houghton Mifflin Co.: New York. (p.41).
- 32 - Purves, D. (1990). "Toxic Sludge". *Nature*. Vol. 346, 8/16/1990 (pp. 617-18).
- 33 - Rybczynski, W. et al. (1982). Appropriate Technology for Water Supply and Sanitation - Low Cost Technology Options for Sanitation, A State of the Art Review and Annotated Bibliography. World Bank. (p. 124).
- 34 - Ibid. (p. 125).
- 35 - Fahm, L.A. (1980). The Waste of Nations. Allanheld, Osmun & Co.: Montclair, NJ (p.61).
- 36 - Radtke, T.M., and Gist, G.L. (1989). "Wastewater Sludge Disposal: Antibiotic Resistant Bacteria May Pose Health Hazard". *Journal of Environmental Health*. Vol 52, No.2, Sept/Oct 1989. (pp.102-5).
- 37 - *Environmental Reporter*. 7/10/92. (p.770).
- 38 - Daniel, J.E., et al. (Eds.). (1992) 1992 Earth Journal. Buzzworm Books: Boulder, CO. (p.131).
- 39 - Rivard, C.J. et al. (1989). "Waste to Energy". *Journal of Environmental Health*. Vol.52, No.2, Sept/Oct 1989. (p.99).
- 40 - *Environmental Reporter*. 11/1/91. (p.1653).
- 41 - Ibid. 1/17/92. (p.2154).
- 42 - Damsker, M. (1992). "Sludge Beats Lead". *Organic Gardening*. Feb, 1992, Vol. 39, Issue 2, p.19.
- 43 - Fahm. (1980). The Waste of Nations. (p.xxiv).
- 44 - Ibid. (p.40).
- 45 - Rivard, C.J. et al. (1989). "Waste to Energy". *Journal of Environmental Health*. Vol 52, No.2, Sept/Oct 1989. (p.100).
- 46 - See *Garbage*, Oct/Nov 1992, (p.14).

**\* "All sewer sludge is not bad," according to Ancil Schmidt, West Virginia Division of Environmental Protection Extension Agent. Mr. Schmidt offers a very helpful packet of information about the use of sewage sludge for agricultural purposes ("Use and Disposal of Municipal Wastewater Sludge"), which is available from: West Virginia University Extension Service, 200 1/2 South Kanawha Street, Beckley, West Virginia, 25801-5616; Phone (304) 255-9321.**

**\*\* Contact JCH Environmental Engineering, Inc., 2730 Remington Court, Missoula, MT 59801-7121. Phone (406) 721-1164.**

**YOU MAY HAVE NOTICED THAT THIS BOOK  
HASN'T (YET) MADE IT TO THE NEW YORK  
TIMES BESTSELLER LIST.**

**HERE'S YOUR MANUSCRIPT  
BACK SIR. SORRY, WE DON'T  
PUBLISH CRAP LIKE THIS.  
PERHAPS YOU COULD USE IT  
FOR EMERGENCY  
TOILET PAPER.**



## COMPOSTING TOILETS AND SYSTEMS

*"Simplicity of life, even the barest, is not misery but the very foundation of refinement."*

William Morris



The act of composting humanure can be done *actively*, with full and voluntary participation by the person(s) creating the refuse, or it can be done *passively*, with little or no participation in the composting process by the person(s) creating the refuse. Many people in the West who agree with the idea of composting humanure want to do so, but only if the process is passive. They don't want to be actively involved in the compost-making process. They want the toilet to do the work, although they may be willing to haul the finished compost off somewhere to be disposed of, usually desiring to do so as infrequently as possible. For many people, a composting toilet is another disposal system, one that doesn't require water (usually), and one that is not to be used in the human nutrient cycle.

Others, those who make compost through an aerobic, thermophilic process, know that there's a technique to building a compost pile that must be respected in order to achieve the desired result, i.e. good quality garden compost. These people use their finished compost to produce food for themselves to eat, therefore they want to be actively involved in the composting process in order to assure quality control over the finished product.

People who actively compost their organic refuse, including humanure, are as rare as hen's teeth in the West. The practice is so alien to Western culture that a person who thermophilically composts humanure may as well walk around with a bone through his or her nose. This is ironic because well-managed thermophilic composting ensures the destruction of human pathogens in the composted material and transforms organic refuse into humus in a relatively short period of time compared to passive composting, which is not thermophilic (the compost does not heat up). However, as pointed out in chapter three, Westerners gained a deep distrust of human excrement over the past several hundred years. This was largely due to terrible epidemic diseases during the Middle Ages and up to the late 1800's spread by fecal contamination of the environment, a condition caused by a cultural ignorance of both the

origins of disease and of the the benefits of composting in destroying human pathogens. That deeply entrenched bias against the use of humanure agriculturally, still currently prevalent in the West, will not be easily rooted out, although eventually it must be. I call the belief that humanure is unsafe for agricultural use: *fecophobia*.

People who are fecophobic can suffer from severe fecophobia or a relatively mild fecophobia, the mildest form being little more than a healthy concern about personal hygiene. Severe fecophobics do not want to use humanure for food growing, composted or not. They believe that it's dangerous and unwise to use such a material in their garden. Milder fecophobics may, however, compost humanure passively and use the finished compost in horticultural applications. People who are not fecophobic may thermophilically compost humanure and utilize it in their food garden. Some may even use it raw, a practice not recommended by the author.

In any case, humanure is best rendered hygienically safe by proper thermophilic composting. Passive, low-temperature composting is very unlikely to become thermophilic and usually does not focus on the destruction of possible human pathogens in the organic refuse being composted. Yet, even passive composting will eventually yield a relatively pathogen-free compost after a period of time, a period which, according to some sources, may be as long as five and a half<sup>1</sup> or even ten<sup>2</sup> years. This is in contrast to thermophilic composting which will destroy human pathogens in a matter of hours or days, or, for larger quantities, weeks or months.

Commercial composting toilets are, for the most part, passive. They are *mouldering* toilets, meaning that the compost moulders or decomposes slowly at temperatures lower than that of the human body. The consumer who buys a commercially distributed composting toilet can rest assured that s/he will have to do little more than use the toilet and then once a year (or two or three) empty out some compost. Often, a dry, organic cover material such as peat moss is recommended to be added to the contents of the toilet on a regular basis. Other than that, there's not much to it.

On the other hand, *non-commercial* mouldering toilets, or *toilets constructed by the users*, are in widespread use throughout the world since many people do not have the financial resources required to purchase commercially produced toilets. Non-commercial mouldering toilets usually require the separation of urine from feces when collecting the organic refuse. This is done by urinating in a separate container or into a diversion device which causes the urine to collect separately from the feces. The rationale for separating urine from feces is that the urine/feces blend contains too much nitrogen to allow for effective composting and the collected refuse gets too wet and odorous. Therefore, the urine is collected separately, thereby reducing the nitrogen, the liquid content, and the odor of the collected refuse.

However, there is a little known alternative method of achieving the same

result which does not require the separation of urine from feces. Organic material with too much nitrogen for effective composting (such as a urine/feces mixture) *can be balanced by adding sufficient carbon material such as cellulose in the form of sawdust or a similar material, rather than removing nitrogen.* The extra carbon material also absorbs excess liquids and can cover the collected refuse to eliminate odor completely. This alternative of adding a carbon material to humanure instead of segregating urine from it, also sets the stage for thermophilic composting because of the carbon/nitrogen balancing. However, almost all commercial and non-commercial composting toilets are designed to only achieve mouldering conditions in the compost and not to generate thermophilic conditions.

A *commercial* composting toilet such as a Clivus Multrum (see figure 5.4 on page 93 and the photos on pages 94 and 95) is a manufactured device including a toilet seat and a composting chamber whereby individuals can deposit their feces with little or no active involvement in a nutrient cycling process. In other words, you can take a shit and forget about it, and urine does not need to be segregated. Commercial composting toilets are convenient for that reason. The compost may or may not be suitable for a kitchen garden, as the composting process is usually slow and usually maintains a relatively low temperature which can allow some pathogens to survive. These toilets are popular among those who understand that defecating in water doesn't make sense, or among those who have no electricity or water in their summer cottages and can't use a water-based waste disposal system even if they wanted to. Commercial composting toilets often strive to dehydrate the organic refuse deposited in them so as to reduce bulk and minimize the quantity of compost being produced. This is done by blowing air through and over the organic refuse with fans, and/or by heating the refuse electrically, or by draining excess liquids out into the soil.

On the other hand, an *active, thermophilic composting system* (not a mouldering system) may only use a toilet for *collection* purposes. The humanure may be collected regularly, perhaps daily or weekly, in a simple, low-cost receptacle and deposited on a compost pile or in a compost pit away from the toilet area and layered with other organic materials so that a high aerobic decomposition temperature is generated in order to kill all potential pathogens. (By the way, *a pathogen is any microorganism or worm that can cause a disease.* See glossary or see next chapter.) In some cases, the humanure is deposited directly onto a compost pile in a basement or under an elevated toilet, and layered with other household organic refuse and organic cover materials. Those who use such an active composting system understand that the composting process is only one step in a larger cyclical system of nutrient transfer: soil produces food, we eat the food, we discharge organic refuse (feces, urine, food scraps, agricultural refuse), the humanure is composted with other veg-

etable or animal refuse, the compost turns back into soil, the soil produces more food, we eat the food, we discharge refuse, and so on. This never-ending human nutrient cycle, when humanure is composted and used to grow human food, maintains a harmonious balance between the human and the earth. It's an active process and requires diligent and conscientious involvement by the human participant(s). What's of value here is the entire, unbroken system, the process itself. The physical toilet may only be a small but important part of the entire cycle. When the actual composting takes place away from the toilet area, this approach requires little construction cost. An active composting system is more labor intensive, but requires little use of technology or natural resources, including water.

Thermophilic composting of humanure has not gained popularity among Westerners for three basic reasons: 1) You can't take a shit and forget about it. The organic refuse has to be dealt with on a regular basis, even if only covered after each deposit and the finished compost removed regularly. S/he who defecates and/or urinates must acknowledge and take responsibility for what comes out of his/her body. 2) Fecophobia. There seems to be a general fear that if you don't die outright from actively composting humanure, you'll die a slow, miserable and wretched death, or you'll surely cause an epidemic of something like the plague and everyone within two hundred miles of you will die, or you'll become so infested with worms that you'll no longer be recognized as human. 3) Misinformation. Much of the information in print concerning the recycling of humanure is confusing, erroneous or incomplete.

As chapter 6 deals with pathogens and chapter 7 deals with the subject of practical thermophilic composting, I won't go into either subject here in any great detail. Let's take a look at some commercial and/or passive composting toilets instead.

## ***THE NON-COMMERCIAL (HOME-MADE) MOULDERING TOILET***

The objectives of a mouldering toilet are to achieve safe and sanitary treatment of fecal material, to conserve water, to function with a minimum of maintenance and energy consumption, to operate without unpleasant odors, and to recycle humanure for horticultural use in a form usable to nature (see figures 5.1, 5.2, and 5.3).

The decomposition process is akin to what happens on a forest floor, i.e. cool, slow decomposition. Because the temperature of the compost does not elevate high



enough to destroy all pathogens, the resulting compost, also known as duff, is considered suitable only for horticultural purposes, not for agricultural purposes, except, perhaps, for orchard use where the duff is covered or buried after application.

It is well known that humanure contains the potential to harbor disease-causing microorganisms, or pathogens. Compost temperatures must rise significantly *above the temperature of the human body* (98.6°F or 37°C) in order to begin eliminating disease-causing organisms, as human pathogens can live happily in temperatures similar to that of the human being. The human body attempts to destroy pathogenic infections by elevating its own temperature, thereby creating a fever, which pathogens don't like. Human fevers rarely rise above 104°F (40° C), and when they do, they rarely sustain that level of heat for more than a day or two. Compost must also generate heat in order to destroy human pathogens, and fortunately thermophilic composting will readily create temperatures much higher than the human body temperature and sustain them, perhaps for weeks.

However, mouldering toilets generally do not achieve thermophilic conditions and therefore do not achieve temperatures higher than that of the human body. Consequently, some human pathogens may smugly reside in the finished compost, perhaps for years. According to current scientific evidence, which is discussed at greater length in chapter six, a few months retention time in just about any compost toilet will result in the deaths of nearly all human pathogens. The most persistent pathogen seems to be the roundworm (*Ascaris lumbricoides*) however, and particularly the egg of the roundworm, which is pro-

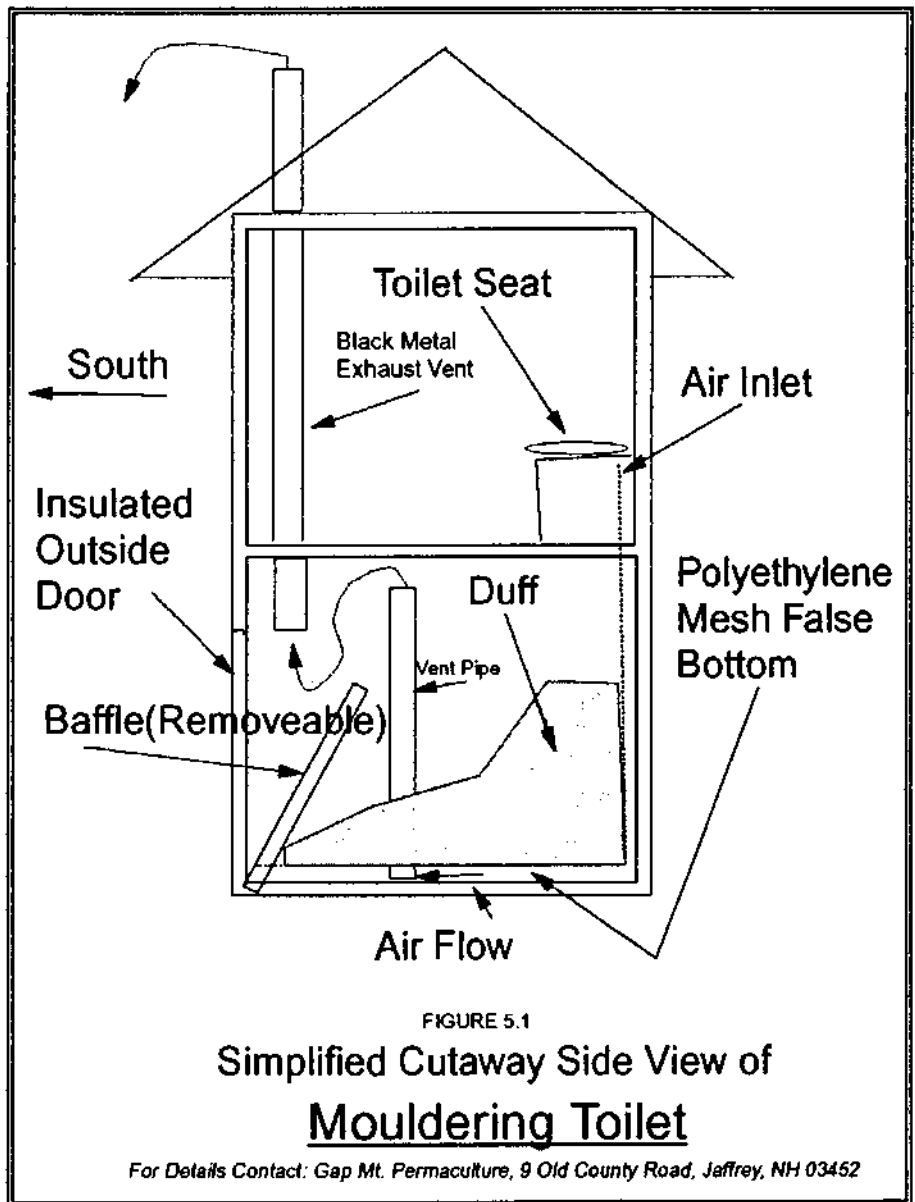
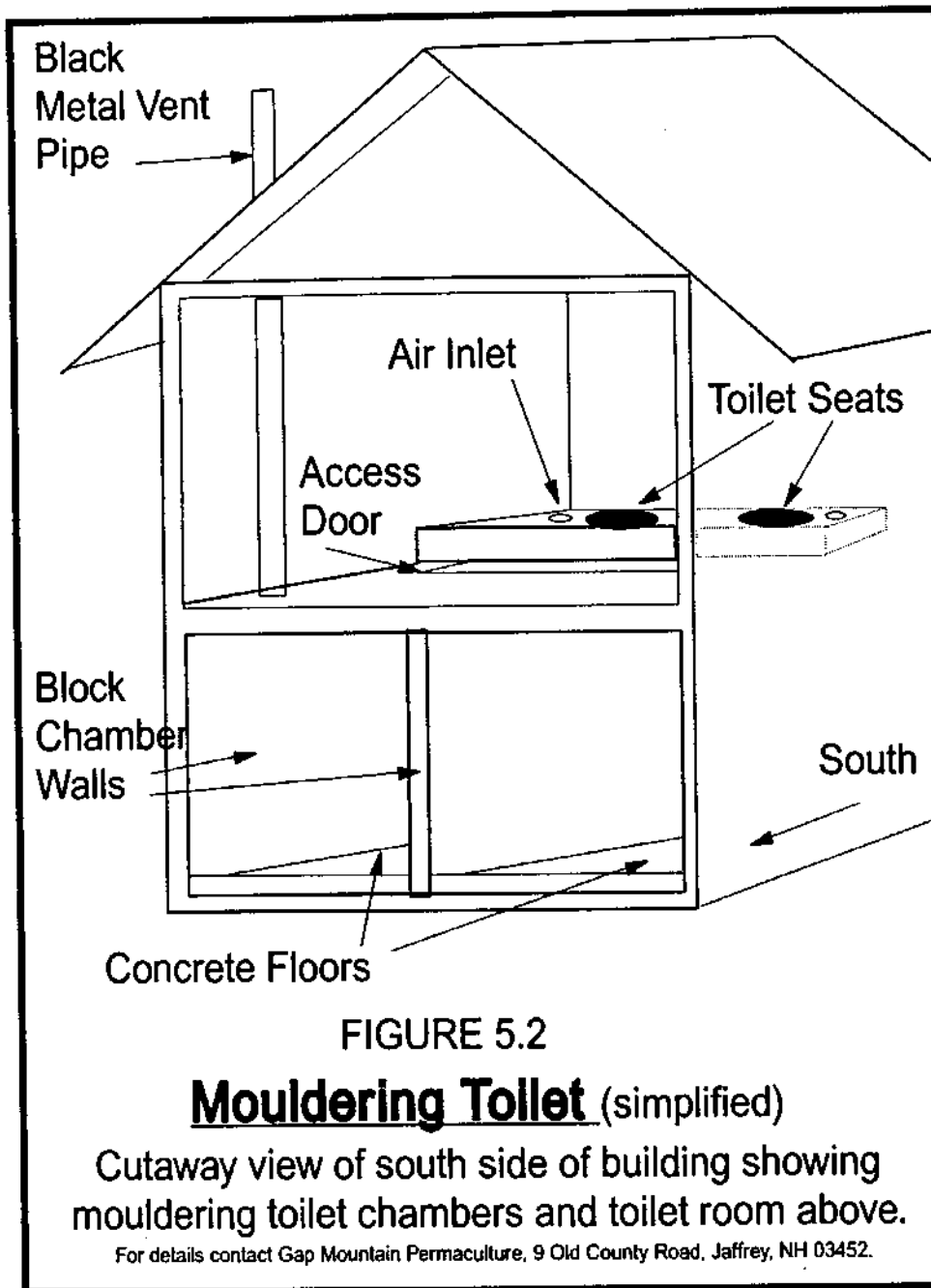


FIGURE 5.1  
Simplified Cutaway Side View of  
Mouldering Toilet

For Details Contact: Gap Mt. Permaculture, 9 Old County Road, Jaffrey, NH 03452



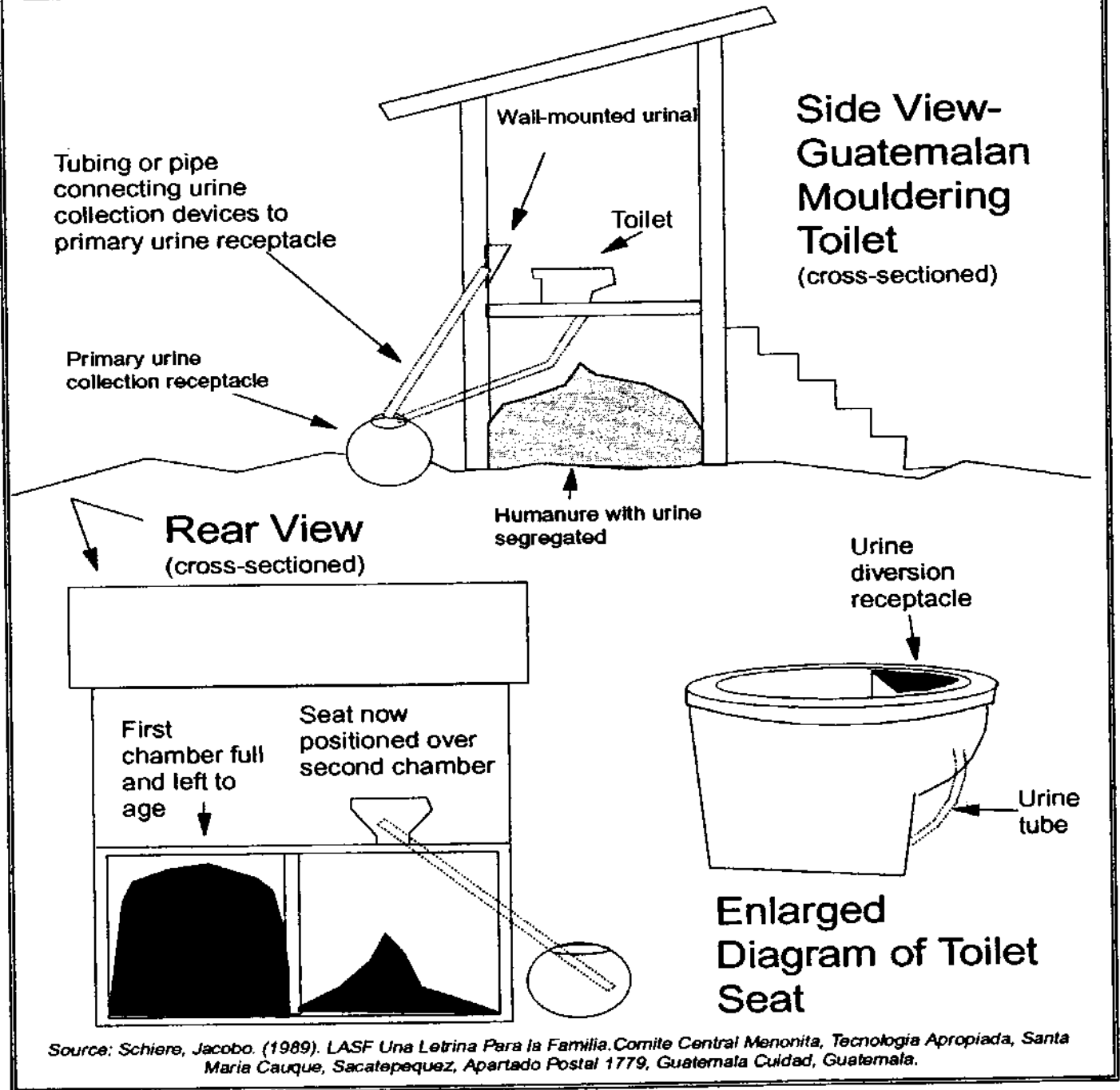
tected by an outer covering which renders the egg resistant to chemicals and adverse environmental conditions. Estimates of the viability of *Ascaris* eggs in soil range as high as ten years. Although the *Ascaris* and the eggs are readily destroyed by thermophilic composting, the eggs may survive in conditions generated by a mouldering toilet. This is why the compost resulting from a mouldering toilet is not recommended for human food production, and why mouldering toilets are only used as elements of the human nutrient cycle in groups of people who are willing to accept the possibility of a level of *Ascaris* infection in their population.

The primary advantage to this sort of toilet is the passive involvement of the user, as the toilet collection area need not be entered into more than every two or three years, unless to rake the pile flat. The pile that collects in the chamber must be raked and mixed somewhat every few months (which can be done through a floor access door), and the chamber is emptied only after nothing has been deposited in it for at least two years, although this time period may vary depending on the individual systems used.

In order for this system to work well, each toilet must consist of two chambers. The first is deposited into until it's full, then the second is used. By the time the

FIGURE 5.3

# Guatemalan Mouldering Toilet



second side is full the first should be emptied. It may take five years to fill a side. In addition to feces, carbonaceous organic matter such as sawdust is regularly added to the chamber in use. One drawback to this system may be the desire to segregate urine from feces in order to minimize odors and waterlogging of the duff. Urination then takes place in a separate container and the collected urine is deposited on a garden or compost pile. Some toilets, such as one currently being used in Guatemala (see figure

5.3 on page 91), automatically separate urine from feces during defecation. However, an alternative to segregating urine to prevent waterlogging of the duff would be to simply add more dry cover material to soak up the excess moisture. Urine-soaked sawdust composts quite well.

An advantage to this system is that there are no moving parts or electrical devices. Air ventilation may take place through a large, black vertical pipe which passes indoors through the toilet room in front of a south-facing window (in the northern hemisphere) where it will be heated, passively causing the air to rise.

In short, the mouldering toilet seems to offer a method of composting humanure that would be attractive to persons wanting a low-maintenance, low-cost, passive approach to excrement recycling. However, urination in a separate receptacle seems to somewhat offset the passive nature of this type of toilet, as the urine must be dealt with on a regular basis. The other primary drawback, as I see it, aside from occasional fly infestations, is the low-temperature composting of the humanure rendering it unfit for growing human food, except for orchard application, until after a quite lengthy period of time. The total destruction of human pathogens should be the goal of anyone composting humanure. However, any effort which successfully returns organic refuse to the soil without polluting water or the environment and without using electricity certainly demands a high level of commendation.<sup>3</sup>

## ***COMMERCIAL MOULDERING (OR MULTRUM) TOILETS***

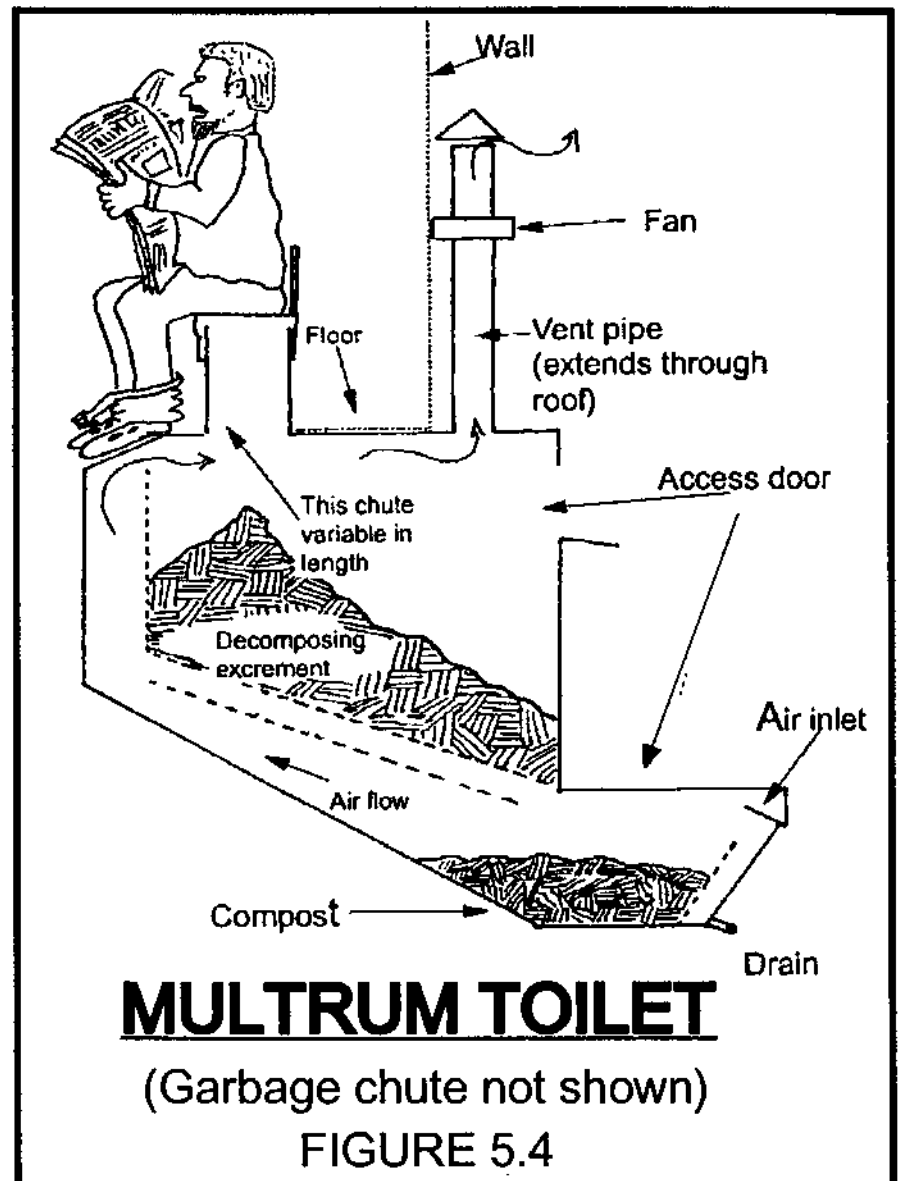
Commercial mouldering toilets have been popular in Scandinavia for some time, and at least twenty-one different mouldering toilets were on the market in Norway alone in 1975.<sup>4</sup> One of the most popular types of commercially available composting toilets in the United States today is the multrum toilet, invented by a Swedish engineer and first put into production in 1964. These toilets have found their way into public buildings, banks, even universities. The concept is similar to that of a simple double-chambered mouldering toilet, although fecal material and urine are deposited *together* into a single chamber with a double bottom. The decomposition takes place slowly over a period of years, and the finished compost gradually falls down to the very bottom of the toilet chamber where it can be removed. Again, the decomposition temperatures remain cool, not usually climbing above 90° F, which is not high enough to kill all pathogens. Therefore, it is recommended that the finished compost be buried under one foot of soil or used in an ornamental garden.<sup>5</sup>

The advantages of this type of toilet include the passive nature of user partici-

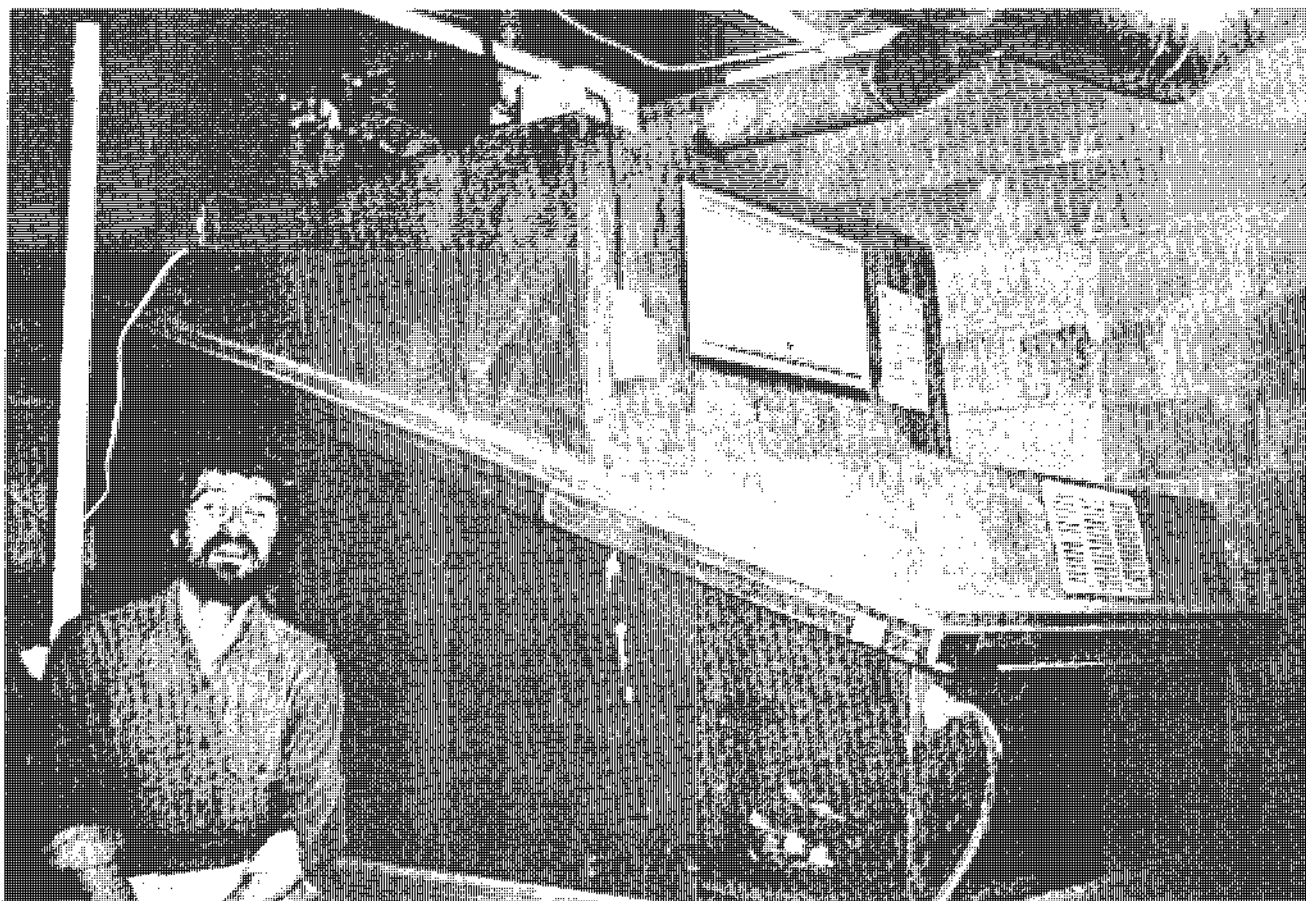
pation. Anybody will happily use a multrum toilet because they know full well that *someone else* someday will have to empty it out. Also, no water is used or required during the operation of this toilet, thereby keeping human excrement out of the water supplies as well as conserving water. According to one report, a single person using a Clivus Multrum will produce 40 kg (88 lbs) of compost per year while refraining from polluting 25,000 liters (6,604 gallons) of water annually.<sup>9</sup> Finally, the finished compost can be used as a soil additive where the compost will not come in contact with food crops.

Drawbacks include the cost, which can easily exceed two or three thousand dollars (1990's), and the fact that the composting chamber is usually made of plastic, which means that for every plastic multrum toilet purchased, a non-biodegradable plastic multrum toilet will probably end up someday in a landfill. If these toilets were made from recycled plastic, that would certainly be a bonus, but that currently doesn't seem to be the case. Also, the multrums require electricity to run both a fan-driven ventilation system and a pump for pumping excess liquid (urine) from the composting chamber. Finally, the composting process does not kill all pathogens in the manure by means of thermophilic composting, although the lengthy retention time of the compost undoubtedly contributes to the destruction of most pathogens that may exist in the excrement (see table 6.11 on page 127).

I'm aware of a couple of multrum toilets currently being used by friends of mine, and they both have had problems with odors, while one has had problems with flies and excess liquid buildup in the composting chamber.

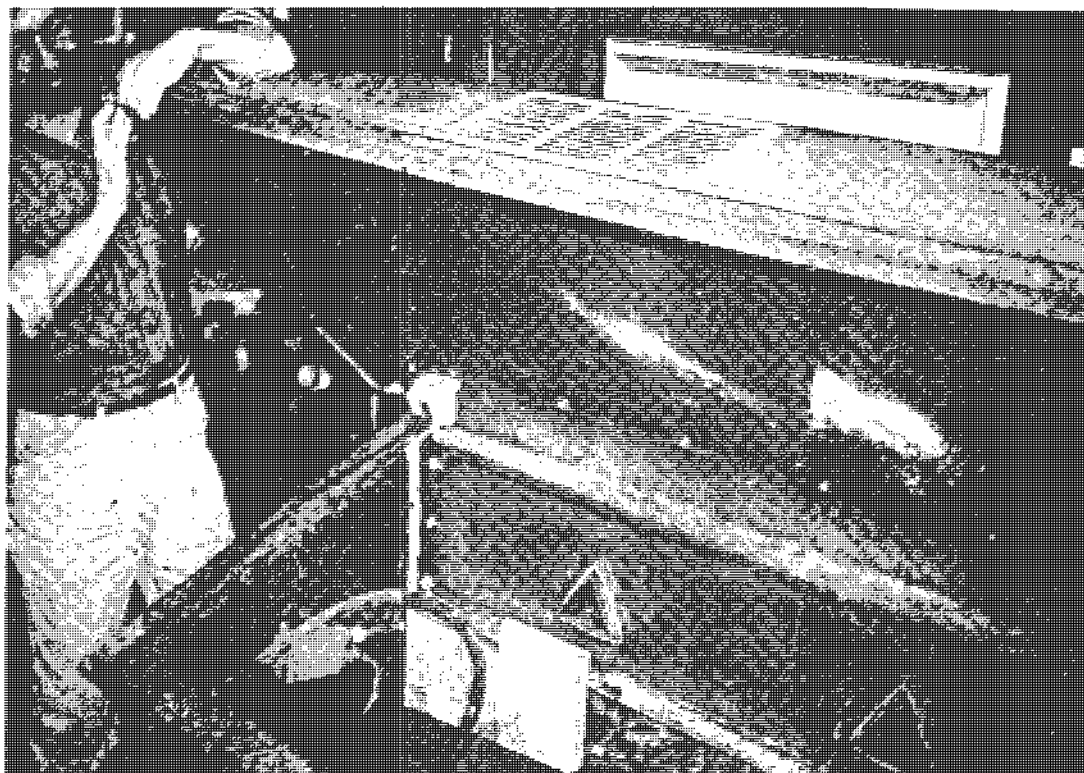


Now, it seems to me that these problems *are due to improper use of the toilet, not necessarily to the toilet itself*, as eventually both parties managed to get their toilets working well, without odors or flies. However, this indicates that some management of the composting toilet is required by someone using the toilet in order to avoid these kinds of problems. For example, organic bulking materials such as sawdust or fine wood shavings must be added regularly to the toilet to absorb excess liquids, aid the composting process, and minimize or eliminate odors. If a multrum toilet is managed properly, it should easily be odor and worry free. As always, a good understanding of the basic concepts of composting will help anyone who wishes to use a composting toilet. Nevertheless, the multrum toilets, when used properly, should provide a suitable alternative to flush toilets for people who want to stop defecating in their drinking water. You can probably grow a heck of a rose bed with the compost, too.



**A CLIVUS MULTRUM IN THE BASEMENT OF SLIPPERY ROCK UNIVERSITY'S HARMONY HOUSE. THE TOILET AND THE KITCHEN COMPOST DISPOSAL CHUTE ARE ON THE FIRST FLOOR.**

Finished compost from seven Clivus Multrum toilets which had been in use for 4 to 14 years was analyzed for nutrients, according to a report issued by Clivus Multrum USA in 1977. The compost averaged 58% organic matter, with 2.4% of nitrogen, 3.6% of phosphorous, and 3.9% of potassium, which is report-



**THE CONTENTS OF A CLIVUS MULTRUM ARE BEING EXAMINED THROUGH ITS MAIN ACCESS DOOR.**

edly higher than composted sewage sludge, municipal compost, or ordinary garden compost. Suitable concentrations of trace nutrients were also found. Toxic metals were found to exist in concentrations far below recommended safe levels.<sup>9</sup>

### ***MORE COMMERCIAL COMPOSTING TOILETS***

There are a variety of other composting toilets available on the market today (see reference list and additional sources of composting toilets on pages 107-108). One manufacturer (*Sun Mar*) claims that over 200,000 composting toilets have been sold worldwide. The same manufacturer produces a fiberglass and stainless steel toilet which consists of a drum under the toilet seat or under the bathroom floor into which the feces and urine are deposited. The drum is rotated by hand in order to blend the ingredients, which should include garbage and a carbon material such as peat moss. The toilet can come equipped with an electric heating system and an electrical fan ventilation system. The compost is produced in small quantities which are

removed by pulling out a drawer beneath the drum. The compost is said to be suitable for garden purposes.

Drawbacks? Some of the models require water as well as electricity (although some require no electricity or water). Again, the cost may be prohibitive to some, although these smaller, more self-contained toilets seem to cost less than the multrums. 1993 price quotes ranged from \$1100.00 to \$1400.00. Also, for every fiberglass toilet unit purchased, someday a fiberglass toilet unit will undoubtedly end up thrown "out" somewhere when it wears out.

However, as the manufacturer insists that the toilet produces absolutely no odor and generates compost suitable for a food garden, it must be assumed that the heating element in the electric toilets in combination with the active compost blending create optimum composting conditions which kill all pathogens. The literature on these toilets doesn't discuss the pathogen issue in any detail though, and as some of the toilets aren't electrically heated, the destruction of pathogens in the finished compost remains a matter of speculation.<sup>6</sup>

Another composting toilet that is currently on the market (*AlasCan*) is even further up the ladder of technological sophistication. Made in Alaska and costing upwards of \$10,000 or more, the toilet is complete with an insulated tank, conveyers, motor-driven agitators, a pump and sprayer, and exhaust fan.<sup>7</sup>

Finally, another source of a composting toilet<sup>8</sup> (*Composting Toilet Systems*) manufactures a fiberglass unit similar to a multrum toilet, and advertises it as a "waste disposal system". The 1993 price for this unit, which uses no water, but does require electricity, is \$3656.00. According to the manufacturer, waterless composting toilets reduce household water consumption by 40,000 gallons per year. This is significant when one considers that only 3% of the Earth's water is fresh, even more so when one realizes that two thirds of that fresh water is locked up in ice. That means that less than one percent of the Earth's water is available as fresh water. Why shit in it?

## ASIAN COMPOSTING

As stated in chapter three, it is well known that Asians have *recycled* humanure for centuries, possibly millennia. However, historical information concerning the *composting* of humanure in Asia seems difficult to find. Rybczynski et. al.<sup>9</sup> in fact state that such composting was only introduced to China in a systematic way in the 1930's, and that it wasn't until 1956 that compost toilets were used on a wide scale in Vietnam. On the other hand, Franceys et. al. tell us that composting, "*has been practiced by farmers and gardeners throughout the world for many centuries.*" They add



that, “ *In China, the practice of composting human wastes [sic] with crop residues has enabled the soil to support high population densities without loss of fertility for more than 4000 years.*”<sup>10</sup>

However, a book published in 1978 and translated directly from the original Chinese (Compost, Fertilizer and Biogas Production from Human and Farm Wastes in the People’s Republic of China, by M. G. McGarry and J. Stainforth, International Development and Research Center, Ottawa)<sup>13</sup> indicates that composting has *not* been a cultural practice in China until only recently. An agricultural report from the Province of Hopei, for example, states that the standardized management and hygienic disposal (i.e. composting) of excreta and urine was only initiated there in 1964. The composting techniques being adopted and developed at that time included the segregation of feces and urine, which were later “*poured into a mixing tank and mixed well to form a dense fecal liquid*” before piling on a compost heap. The compost was made of 25% human feces and urine, 25% livestock manure, 25% miscellaneous organic refuse, and 25% soil.

Two *aerobic* methods of composting were reported to be in widespread use in China, according

to the 1976 report. The two methods are described as a) surface aerobic continuous composting, and b) pit aerobic continuous composting. The *surface* method involves constructing a compost pile around an internal framework of bamboo, approximately nine feet by nine feet by three feet high (3m x 3m x 1m).



A YOUNG LADY SETTING CEDAR POSTS IN THE GROUND FOR THE CONSTRUCTION OF A DOUBLE-CHAMBERED COMPOST BIN.

Compost ingredients include fecal material (both human and non-human), organic refuse, and soil. The bamboo is removed from the constructed pile and the resultant holes allow for the penetration of air into this rather large pile of refuse. The pile is then covered with earth or an earth/horse manure mix, and left to decompose for 20 - 30 days, after which the composted material is used in agriculture. The *pit* method involves constructing compost pits five feet wide and four feet deep by various lengths, then digging channels in the floor of the pits. The channels (one lengthwise and two widthwise) are covered with coarse organic material such as millet stalks, and a bamboo pole is placed vertically along the walls of the pit at the end of each channel. The pit is then filled with organic refuse and covered with earth, and the bamboo poles are removed to allow for air circulation.<sup>11</sup>

Additional light is shed on the subject of Chinese composting by a report from a hygienic committee of the Province of Shantung, as published in the aforementioned work by McGarry and Stainforth. The report lists three traditional methods used in that Province for the recycling of humanure: 1) drying it (*"drying has been the most common method of treating human excrement and urine for years"*), 2) using it raw for agricultural purposes, and 3) *"connecting the household pit privy to the pigpen . . . a method that has been used for centuries"*, a method in which the excrement was simply eaten by a pig. No mention is made whatsoever of composting being a traditional method used by the Chinese for recycling humanure. On the contrary, all indications were that the Chinese government in the 1960's was *at that time* attempting to establish composting as preferable to the three traditional recycling methods listed above, mainly because the three methods were hygienically unsafe, while composting, when properly managed, would destroy pathogens in humanure while preserving agriculturally valuable nitrogen. Once again, the report describes composting techniques in which soil was being used as a main ingredient in the compost, or, to quote directly, *"Generally, it is adequate to combine 40-50% of excreta and urine with 50-60% of polluted soil and weeds"*.

For further information on Asian composting I must defer to Rybczynski et. al., whose World Bank research on low-cost options for sanitation considered over 20,000 references and reviewed approximately 1200 documents. Their review of Asian composting is brief, but includes the following information, which I have condensed:

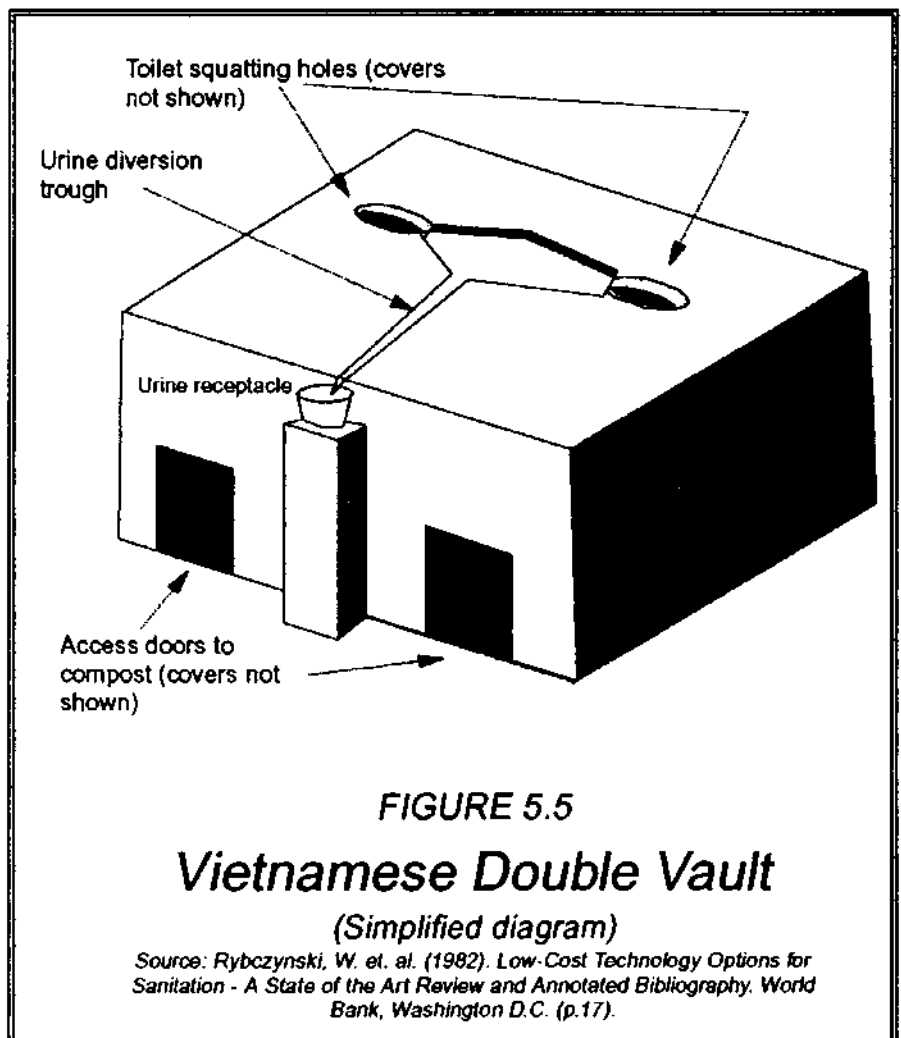
There are no reports of composting privys (toilets) being used on a wide scale until the 1950's, when the Democratic Republic of Vietnam initiated a five-year plan of rural hygiene and a large number of *anaerobic* composting toilets were built. These toilets, known as the Vietnamese double vault (see figure 5.5), consisted of two, above ground water-tight tanks, or *vaults*, for the collection of humanure. For a

family of five to ten people, each vault was required to be 1.2 m wide, 0.7 m high, and 1.7 m long (approximately 4 feet wide by 28 inches high and 5 feet seven inches long). One tank is used until full then left to decompose while the other tank is used. The use of this sort of composting toilet requires the segregation of urine, which is diverted to a separate receptacle by means of a groove on the floor of the toilet. The fecal material is collected in the tank and covered with soil, where it anaerobically decomposes. Kitchen ashes are added to the fecal material for the purpose of reducing odor. Intestinal worm eggs, which are one of the most persistently viable forms of human pathogens, were found to be 85% destroyed after a two month composting period in this system.

Another anaerobic double-vault composting toilet in use in Vietnam includes the use of fecal material *and* urine, but the bottom of the vaults are perforated to allow drainage, and the urine is filtered through limestone to neutralize acidity. Other organic refuse is also added to the vaults, and ventilation is provided via a pipe.

In India, the composting of organic refuse and humanure is advocated by the government. A study of such compost prepared in pits in the 1950's showed that intestinal worm parasites

were completely eliminated in 3 months and pathogenic bacteria were also completely destroyed. The destruction of pathogens in the compost was attributed to the maintenance of a temperature of about 104°F for a period of 10-15 days. However, it was also concluded that the compost pits had to be properly constructed and managed, and the compost not removed until fully "ripe", in order to achieve the total destruction of human pathogens. If done properly, it is reported that *"there is very little hygienic risk involved in the use and handling of [humanure] compost for agricultural purpos-*



es". The issue of pathogens will be discussed at length in the next chapter.

## ***SIMPLE, LOW-TECH HUMANURE COMPOSTING***



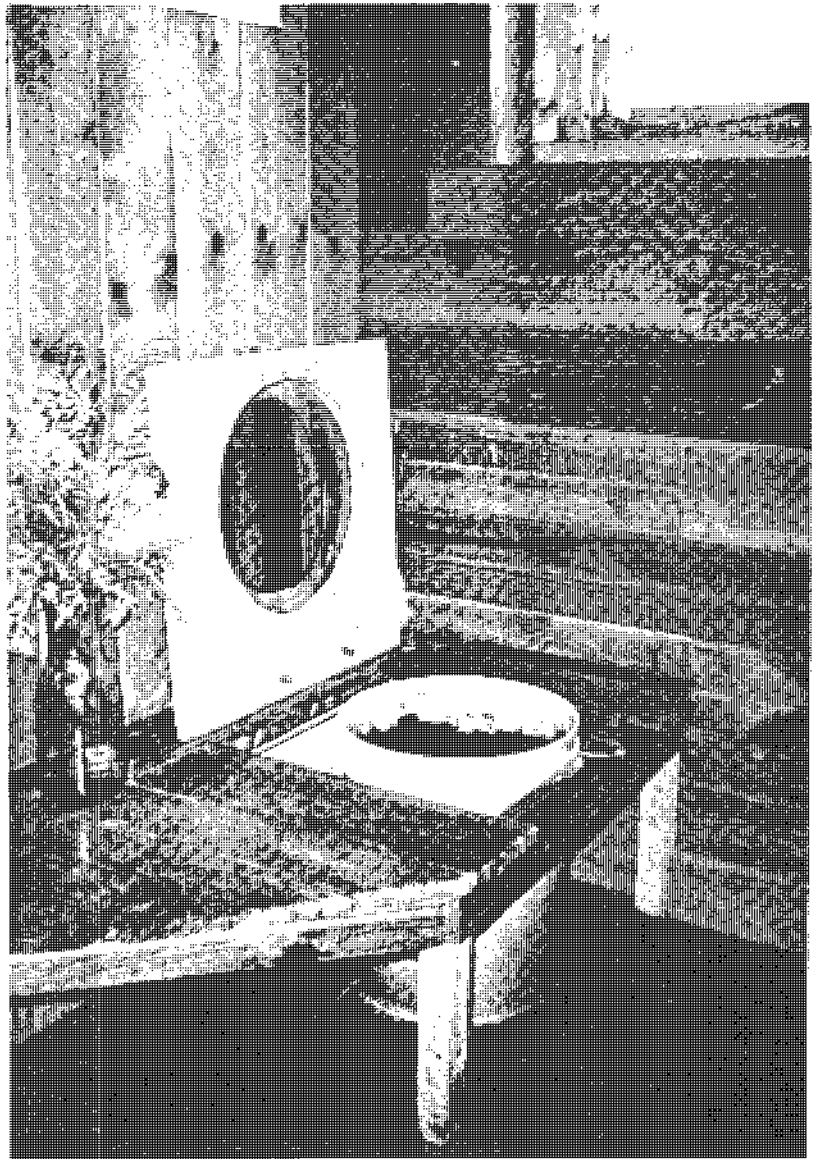
**A SAWDUST TOILET. HUMANURE IS COLLECTED IN THE FIVE-GALLON CONTAINER UNDER THE SEAT AND KEPT COVERED WITH ROTTED SAWDUST. WHEN FULL, THE ORGANIC MATERIAL IS DEPOSITED INTO A COMPOST BIN FOR THERMOPHILIC COMPOSTING (SEE NEXT PAGE). SUCH A TOILET COSTS VERY LITTLE TO INSTALL OR OPERATE AND REQUIRES NO WATER OR ELECTRICITY.**

Simple, low-tech compost systems are traditionally used by people who do not have the luxury of buying expensive, electrically powered, plastic or fiberglass receptacles to defecate in. Instead, they develop simple methods of collecting their manure and composting it, often away from their living spaces. Sometimes these systems are called cartage systems or bucket systems, as the manure is carried to the compost pit, chamber or bin, often in buckets or other waterproof vessels. People who utilize such simple techniques for composting humanure simply take it for granted that feces recycling is one of the regular and necessary chores of sustainable human life on this planet.

How it works is a model of simplicity. One begins by depositing one's organic refuse (feces and urine) into a plastic bucket, clay urn or other non-corrodible waterproof receptacle with about a five gallon (approximately 20 liters) capacity. Food scraps may be collected in a separate receptacle. The humanure is kept covered with a clean, organic material such as sawdust, peat moss,

soil, etc. in order to prevent odors, absorb urine, and eliminate any fly nuisance, and a lid is kept on the receptacle when not in use. A standard, hinged toilet seat is quite suitable as a lid. This system of using an organic cover material works well enough in preventing odors to allow the toilet to be indoors, year round. When the bucket is full, it is carried to the composting area and deposited on the pile. The deposit is then immediately covered with a layer of clean, bulky, organic material such as straw or weeds, in order to eliminate odors and trap air. The bucket is then thoroughly scrubbed with a small quantity of water, which can be rain water or wastewater, and biodegradable soap, if available or desired. A long-handled toilet brush works well for this purpose. The soiled water is then poured on the compost pile. Rain water or wastewater is ideal for this purpose as its collection requires no electricity. The bucket is then replaced in the toilet area. The inside of the bucket can then be dusted with clean, dry sawdust and it's ready to "go".

Drawbacks to this system include the inconvenience of carting buckets of excrement on a regular basis; having to look at and smell the excrement (mixed in sawdust), no



THE FULL SAWDUST TOILET RECEPTACLE IS SIMPLY LIFTED OUT OF THE TOILET AND EMPTIED INTO A COMPOST BIN OUTDOORS. ALL URINE AND FECES IS COLLECTED IN SUCH A TOILET. A FAMILY OF FOUR CAN EXPECT TO FILL A SAWDUST TOILET OF THIS SORT IN THREE OR FOUR DAYS. THE SAWDUST COVER ELIMINATES ODORS AND FLIES, AND BALANCES THE NITROGEN OF THE HUMANURE WITH CARBON, THEREBY FACILITATING THERMOPHILIC COMPOSTING. SUCH A TOILET SHOULD BE LOCATED INSIDE, BUT NEAR AN OUTSIDE DOOR FOR EASE OF REMOVAL.

matter how briefly, when depositing it on the compost pile; having to clean the bucket after emptying; and having to keep a supply of clean, organic material (e.g. sawdust, peat or clean soil, and straw/hay, weeds or leaves) available to use as cover materials, which is absolutely essential to the success of this sort of humanure composting system. Furthermore, when the bucket gets full, it can't be used until it's been emptied, no matter how bad one has to go. There is a degree of conscientious and serious responsibility involved in this system of composting in order for it to work well.

The advantages to this system include low financial cost in the creation of the facilities and low, or no energy consumption in its operation. Also, such a simple system, when the refuse is thermophilically composted, has a low environmental cost, as little or no technology is required for the system's operation, and the finished compost is as nice and benign a material as humanure can ever hope to be. No large, non-biodegradable composting chambers are required, and no composting facilities are necessary in or near one's living space, unless by choice (the manure collection can and should be inside one's home and can be quite comfortably designed). No electricity is needed, and no water is required except a small amount for cleaning purposes. The compost, if properly managed, will heat up sufficiently to kill all pathogens and thereby be useful for gardening purposes. A complete natural cycle is maintained, unbroken. Finally, the composting process is fast, i.e. the humanure is converted quickly (within a few days if not frozen) into an inoffensive substance that will neither attract rodents nor flies. In cold winter months, the compost simply freezes until spring thaw, then heats up.

The thought of carrying humanure to a compost site away from one's living space is one that will cause most Westerners to immediately reject the idea of composting their manure in this manner. The Western culture is built upon the idea of convenience, which is one reason why commercial composting toilets are relatively popular in the West, and the inconvenience of carrying refuse (*any* refuse) to a compost pile on a regular basis is just unacceptable. It is more convenient to *discard* organic refuse, such as down a toilet or in a garbage can, and that's why Western cultures do so. However, there are still more than a few people on the planet who are happy to endure a small inconvenience in exchange for less waste, a cleaner environment, and for soil-building compost. Furthermore, there are many people who do not have the luxury of choosing the convenience of waste disposal, as they don't have electricity, running water, or garbage pick-up, and they are therefore prime candidates for the thermophilic composting of their manure.

Likewise, there are those who want to compost their manure, are willing to endure some inconvenience, and still don't want to have to carry it anywhere. Those are people who may want to try situating their toilets directly above their compost

piles, such as is done with a mouldering toilet. This may be best suited in warm climates where an outdoor toilet is acceptable, or in situations where an easily accessible basement is available for the location of the compost pile. There's no reason why this scenario would not work *if the compost is properly managed*. Proper management can be summed up simply with four requirements:



This sawmill shed is full of raw, hardwood sawdust. Large quantities of this carbon-rich organic material are typically available at numerous sawmills throughout any forested area, either free for the hauling, or at very little cost. The above sawdust is being protected from the weather so it won't freeze, however, for composting purposes it is best to leave the sawdust exposed to the elements so it will become damp and will more rapidly decompose. Rotted sawdust is better for a compost pile than raw sawdust; kiln-dried sawdust (from a lumber yard) is the worst due to its relatively inert dehydrated state which resists microbial decomposition (let it sit out in the rain to rehydrate it). Sawdust alone decomposes slowly and may take 15 years to fully decompose. However, when blended with nitrogen rich, moist humanure, it will decompose relatively rapidly, returning to humus in year or two.

### **An Important Note About Sawdust**

Not all sawdust decomposes well. Some tree species contain antibiotic oils that retard the development of microorganisms, and sawdust from these trees does *not* make good compost. These trees include **CEDAR, REDWOOD, BLACK LOCUST, OSAGE ORANGE, CYPRESS, WHITE OAK**, and perhaps others. Some rot-resistant hardwoods such as white oak *will* make good compost if the sawdust is left to decompose outside for a year or two before using for compost. Although the author uses only hardwood sawdust for compost because he lives in a hardwood forest area, **softwood sawdust makes good compost too, and some say it's even better than hardwood**. You be the judge. Experiment!

1) *Use at least a double chambered, above ground compost bin.* Deposit in one chamber for a period of time (e.g. a year), then switch to the other for an equal period of time.

2) *Deposit a good mix of organic refuse into the compost pile, including kitchen scraps.*

3) *Always cover humanure deposits with an organic cover material such as sawdust, leaves or hay.* Make sure that enough cover is applied so that there is neither excess liquid build-up nor offensive odors escaping the compost pile. The trick to using cover material is quite simple: *if it smells bad, cover it.*

4) *Keep good access to the pile* in order to rake the top flat, to apply bulky cover material when needed, and to monitor the temperature of the pile, if desired. The advantage of aerobic composting, as is typical of an above-ground pile, over anaerobic composting typical of sealed pits, is that the aerobic compost will generate higher temperatures, thereby ensuring a more rapid and complete destruction of potential human pathogens. It is still widely reported today that the aeration of a compost pile is best achieved by manual methods, especially turning of the pile, such as with a shovel, although I dispute this. Because of the widespread encouragement to turn compost piles, I turned my compost every year for over a decade, until I started monitoring the temperature of my compost pile using a compost thermometer. That's when I discovered that when I turned my compost, the thermophilic activity of the pile immediately stopped, and the pile cooled down, which is just the opposite of what one would expect. Yet the explanation is simple.

Perhaps my composting technique is unique in that it is as simple as it can get. I build the same pile for a year in an above-ground wooden bin, then I leave it to age for another year as I build a second pile. After the second year, I remove the first pile, which is now finished, and I start over in the first bin with a new pile. I use an annual system because my growing season is based on an annual system. I apply compost to my garden once a year because I only plant a garden once a year. When one builds the same pile *continuously* for a year, one will find during the course of that year that the thermophilic area of the pile is on the top where the fresh deposits reside. The lower sections of the pile have already heated and are now undergoing a cooler decomposition by fungi, earthworms etc. The pile is constantly growing on top and constantly shrinking beneath, and the thermophilic layer is therefore constantly rising to digest the newer deposits. When a pile such as this is turned, the thermophilic layer on top becomes diluted with the cooler, thermophilically-spent lower layers, and the carbon/nitrogen balance consequently becomes disrupted. The thermophiles don't have the proper balanced diet, and they cool down and die off, oxygen or no oxygen. All the oxygen in the world isn't going to ensure a successful compost



pile when the other requirements for successful compost are not met.

When I came to understand this phenomenon as it relates to continuous composting, I realized that if the compost pile is heating sufficiently, it obviously has enough oxygen. There is no need to add more, and if one tries to do so by turning the pile, one instead runs the risk of disrupting the C/N ratio of the thermophilic layer of the compost, thereby putting out its fire. Since my compost heats more than adequately for the purposes of hygiene, I've been forced to come to the conclusion that the simple act of covering humanure deposits with coarse materials such as straw or weeds, actually helps to trap sufficient oxygen in the pile *to render any additional or manual aeration of the compost unnecessary.*

Furthermore, in my case, all human urine is collected with fecal material and composted in the same elevated pile. This is made possible and convenient by using an absorbent carbonaceous material in the toilet receptacle itself, which absorbs the urine and covers the humanure deposits, thereby eliminating odors, flies and any other problems. I use rotting sawdust from logs because it is a readily available and inexpensive local resource, and it works. I used to haul a free load home every so often in the back of my pick-up truck, but now I just have a fellow with a small dump truck deliver me a load every year or two. I have the sawdust dumped outside where it can remain exposed to the elements and thereby slowly decompose on its own, as rotting sawdust makes compost more quickly than fresh sawdust. The sawdust doesn't cost anything, but it usually costs about five dollars to have it loaded and another twenty or so to have it hauled. This is an expense I'm happy to pay in order to ensure for myself a functional compost toilet system. However, my guess is that any cellulose-based material or combination of materials would work, including perhaps ground newsprint, or even just plain soil, if collected and kept dry enough to be absorbent.

*Anaerobic* systems seem best suited in situations where large amounts of refuse need to be composted, such as in an anaerobic pit where municipal refuse is deposited. Compost microorganisms, in the absence of oxygen (anaerobic), convert organic nitrogen to ammonia, while carbon is reduced to methane, and sulfur to hydrogen sulfide. This results in rather severe odor problems, and the destruction of pathogens proceeds slowly due to the relatively low composting temperatures. Such destruction may take up to twelve months for roundworm eggs.<sup>12</sup>

When I read about all of the styles and techniques for composting humanure, including vaults, pits, segregation of urine, liming, ashing, sealing, turning, etc., I wonder if anyone has tried to simply collect humanure, with urine and a carbon cover material, and pile it in a bin with garbage and other local organic cover materials such as weeds. Such a simple system, although not glamorous or sophisticated, works.

And that's what really matters, doesn't it?

Simple, low-tech compost systems not only have a low negative impact on the Earth's ecosystems, but are proven to be sustainable. Westerners may think that any system not requiring technology is too primitive to be worthy of respect. However, when Western culture is nothing more than a distant and fading memory in the collective mind of humanity thousands (hundreds?) of years from now, the humans who will have learned how to survive on this planet in the long term will be those who have learned how to live in harmony with it. That will require much more than intelligence or technology - it'll require a sensitive understanding of our place as humans in the web of life. That self-realization may be beyond the grasp of our egocentric intellects. Perhaps what is required of us in order to gain such an awareness is a sense of humility, and a renewed respect for that which is simple.

Some would argue that a very simple system of humanure composting can also be the most advanced system known to humanity. It may be considered the most advanced because it works well *while consuming little, if any, non-renewable resources, producing no pollution, and actually creating a resource vital to life.*

Now others may argue that in order for a system to be considered "advanced", it must display all the gadgets, doodads and technology normally associated with advancement. The argument is that something is advanced if it's been created by the scientific community, by humans, not by nature. That's like saying the most advanced method of drying one's hair is using a nuclear reaction in a nuclear power plant to produce heat in order to convert water to steam in order to turn electric generators in order to produce electricity in order to power a plastic hair-drying gun in order to blow hot air on one's head. But that's only technological advancement. It reflects humanity's *intellectual* progress . . . (I think).

True advancement, others would argue, instead requires the *balanced* development of humanity's intellect with physical and spiritual advancement. We must link what we know intellectually with the physical effects of our resultant behavior, and with the understanding of ourselves as small, interdependent, interrelated life forms in relation to a greater sphere of existence. Otherwise, unbalanced technological advancement uses technology to excessively consume non-renewable resources and to create toxic waste and pollution in order to do a simple task such as hair drying, which is easily done by hand with a towel. If that's advancement, we're in trouble.

Perhaps we're really advancing ourselves when we can function healthfully, peacefully and sustainably without squandering resources and without creating pollution. That's not a matter of mastering the intellect or of mastering the environment with technology, it's a matter of mastering one's self, a much more difficult undertaking, but certainly a worthy goal.

## REFERENCES - CHAPTER FIVE

- 1 - Crook, James. (1985). "Water Reuse in California", *Journal American Water Works Association*, v.77, no.7, as seen in The Water Encyclopedia (van der Leeden, et. al., 1990, Lewis Publishers, Chelsea, Mich. 48118).
- 2 - Boyd, Robert F. and Hoerl, Bryan G. (1977). Basic Medical Microbiology. Little, Brown and Co., Boston. (p.494).
- 3 - Clayton, D., and Jacke, D. (1992). The Gap Mountain Permaculture Mouldering Toilet. Published by Gap Mountain Permaculture, 9 Old County Road, Jaffrey, NH 03452, phone:(603) 532-6877. Cost of mouldering toilet publication is \$12.00.
- 4 - Rybczynski, W. et. al. (1982). Appropriate Technology for Water Supply and Sanitation - Low Cost Technology Options for Sanitation, A State of the Art Review and Annotated Bibliography. World Bank. (p. 63). [see below]
- 5 - See ***Clivus Multrum Maintenance Manual***, Clivus Multrum, Inc., 21 Canal St., Lawrence, Mass. 01840. (Also contact Hanson Assoc., Lewis Mill, Jefferson, MD 21755)
- 6 - Contact ***Sun Mar Corp.***, 900 Hertel Ave., Buffalo, NY 14216 USA; or 5035 North Service Road, Burlington, Ontario, Canada L7L5V2.
- 7 - Contact ***AlasCan, Inc.***, 3400 International Way, Fairbanks, Alaska 99701, phone/fax (907) 452-5257 [as seen in *Garbage*, Feb/Mar 1993, p.35].
- 8 - ***Composting Toilet Systems***, PO Box 1928 (or 1211 Bergen Rd.), Newport, WA 99156, phone: (509) 447-3708/ fax (509) 447-3753.
- 9 - Rybczynski, W. et. al. (1982). Appropriate Technology for Water Supply and Sanitation - Low Cost Technology Options for Sanitation, A State of the Art Review and Annotated Bibliography. World Bank. Transportation and Water Department, 1818 H Street N.W., Washington D.C. 20433 USA. [Note: This work contains a bibliography on compost toilets that the reader may find useful.]
- 10 - Franceys et. al. (1992). A Guide to the Development of On-Site Sanitation. World Health Organization, Geneva. (p. 213).
- 11 - Rybczynski, as above. (p. 114).
- 12 - Franceys, et. al., as above. (p.214).
- 13 - McGarry, Michael G., and Stainforth, Jill (eds.) (1978). Compost, Fertilizer, and Biogas Production from Human and Farm Wastes in the People's Republic of China. International Development Research Center, Box 8500, Ottawa, Canada, K1G 3H9 (pages 9, 10, 29, 32).

### Additional Sources of Composting Toilet Plans and/or General Information:

- \***Appalachia Science in the Public Interest**. Route 5, Box 423, Lexington KY 40445. [ASPI has a technical bulletin on composting toilets which includes a schematic for a compost toilet which ASPI designed.]
- \***Water Conservation Systems, Inc.** Damonmill Square, Nine Pond Lane, Concord, MA 01742 (508) 369-3951 [A source of several brands of composting toilets, including Biolet, Sunmar, Carousel, Alascan, Ecos Soltran, Sealand, Pactosan, and Nepon, as well as a variety of toilet accessories.]

\***EKAT**, Robert J. Fairchild, Executive Director, 150 Gravel Lick Branch Road, Dreyfus, KY 40426-9700, ph. (606) 986-6146. ["Big Batch Composting Toilet Plans" \$7. Describes the do-it-yourself construction of compost toilets built of large, rolling, polyethylene dump carts, or "tilt trucks".]

\***Long Branch Environmental Education Center**. P.O. Box 369, Leicester, NC 28748 (704) 683-3662. ["Do-It Yourself Passive Solar Compost Toilet" (\$25.00 for blueprints); Goodbye to the Flush Toilet by Carol Stoner (\$18.00 postpaid); "Compost Toilets: A Guide for Owner Builders" (\$8.00 postpaid).]

\***National Center for Appropriate Technology**. 3040 Continental Drive, PO Box 3838, Butte MT 59702 (406) 494-4572. ["Compost Toilets: Suggested Readings", 1992, 6 pages, \$2; and "Wastes to Resources: Appropriate Technologies for Waste Conversion", 1984, 28 pages, \$4.]

\***Real Goods**. 966 Mazzoni St., Ukiah, CA 95482-9486 USA, (800)762-7325. [They sell compost toilets and many other things.]

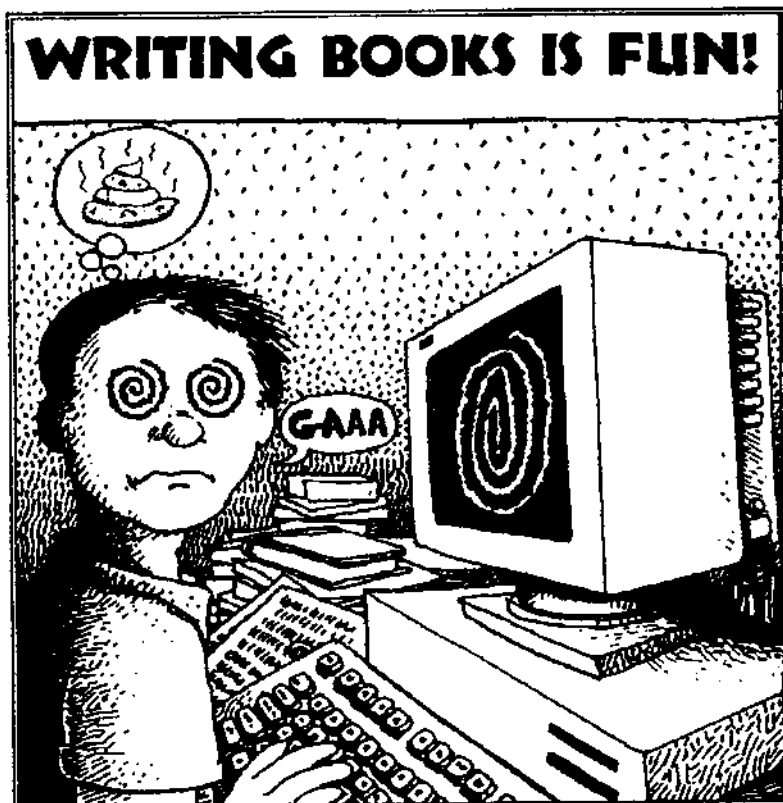
\* **Biolet** (International, Canada, and USA)

Biolet USA Inc., Damonmill Square, Nine Pond Lane, Concord, MA 01742; 1-8005BIOLET. In Canada: Biolet Toilets Ltd., 1177 West Hastings Street, Suite 1106, Vancouver, BC, V6E2K3; Ph: 604-685-5265.

\***Jade Mountain** 717 Poplar Ave., Boulder, CO 80304, or PO Box 4616, Boulder, CO 80306-4616; Ph: 303-449-6601 or 800-442-1972. (They sell various toilets).

\***Lehman Hardware**, Box 41, Kidron, Ohio 44636; Ph: 216-857-5441. (They have a selection of toilets).

\***Soiltech** (Biolet distributor) 607 E. Canal St., Newcomerstown, Ohio 43832-1207; Ph: 614-498-5929 or 800-296-6026.



## WORMS AND DISEASE

*“Compost heaps. We built them regularly out of all the waste material we could find and watered them lavishly with liquid from the communal cesspool. I had, as chief composter, responsibility for seeing that they heated properly . . . A well-made compost heap steams like a tea kettle and gets hot enough to destroy all pathogens that may be present when one uses human sewage. An extraordinary device when one thinks about it. Thermophilic bacteria. Bacteria that can live and flourish in temperatures hot enough to cook an egg. How can they survive in such heat? Truly the tricks of nature are extraordinary!”*

Robert S. deRopp



I well remember in 1979 when I first informed a friend that I intended to compost my own manure and grow my own food with it. *“Oh my God, you can’t do that!”* she cried.

“Why not?”

“Worms and disease!”

Of course. What else would a fecophobe think of when one mentions using humanure as a fertilizer?

An English couple was visiting me one summer after I had been composting humanure for about six years. One evening, as dinner was being prepared, the couple suddenly understood the horrible reality they now found themselves faced with: the food they were about to eat was *recycled shit*. When this “fact” dawned upon them it seemed to set off some kind of instinctive English alarm in their minds, possibly inherited directly from Queen Victoria. *“We don’t want to eat shit!”* they quite seriously informed me (that’s an exact quote), as if in preparing dinner I was simply defecating on plates and setting them on the table. Never mind that the food appeared quite palatable. It was the *thought* of it that mattered.

*Fecophobia* is alive and well and currently residing in about a billion Westerners. Oh well, ignorance is a problem. I have no doubt that if I were living five hundred years ago, I’d be considered one of those “witches” of bygone days. What made a person a witch was their refusal to accept the intellectual constraints of the era, which forced them to be seen as nonconforming and threatening to the status quo. The solution at that time reflected the puny intelligences and spiritual destitution of the establishment leaders: they’d simply gather up the non-conformists and burn

them alive. Yes, ignorance is a chronic human problem.

One common misconception is that fecal material, when composted, remains fecal material. *It does not.* Humanure comes from the earth, and through the miraculous process of composting, returns to earth. When the composting process is finished, the end product is earth, not shit. That earth, or humus, is useful in growing food. My friends unfortunately didn't understand this, and they chose instead to continue clinging to their misconceptions, despite my attempts to clarify the matter for their benefit. Apparently, some fecophobes will always remain fecophobes.

## THE HUNZAS

It's already been mentioned that entire civilizations have recycled humanure for thousands of years. That should provide a fairly convincing testimony about the usefulness of humanure as an agricultural resource. Nearly everyone's heard of the "healthy Hunzas", a people in what is now a part of Pakistan who live among the Himalayan peaks, and routinely survive to be 120 years old. The Hunzas gained fame in the United States during the 1960's health food era, at which time several books were written about the fantastic longevity of this ancient people. Their extraordinary health has been attributed to the quality of their overall lifestyle, including the quality of the natural food they eat and the soil it's grown on. Few people, however, realize that the Hunzas also compost their humanure and use it to grow their food. The Hunzas, who call themselves "Hunzakuts", have bronzed but Caucasian features like southern Europeans. They're said to have virtually no disease, no cancer, no heart or intestinal trouble, and they regularly live to be over a hundred years old while *"singing, dancing and making love all the way to the grave."*

According to Tompkins (1989), *"In their manuring, the Hunzakuts return everything they can to the soil: all vegetable parts and pieces that will not serve as food for humans or beast, including such fallen leaves as the cattle will not eat, mixed with their own seasoned excrement, plus dung and urine from their barns. Like their Chinese neighbors, the Hunzakuts save their own manure in special underground vats, clear of any contaminable streams, there to be seasoned for a good six months. Everything that once had life is given new to life through loving hands (emphasis mine)."*<sup>1</sup>

Sir Albert Howard wrote in 1947, *"The Hunzas are described as far surpassing in health and strength the inhabitants of most other countries; a Hunza can walk across the mountains to Gilgit sixty miles away, transact his business, and return forthwith without feeling unduly fatigued."* Sir Howard maintains that this is illustra-

tive of the vital connection between a sound agriculture and good health, insisting that the Hunzas have evolved a system of farming which is perfect. He adds, *“To provide the essential humus, every kind of waste [sic], vegetable, animal and human, is mixed and decayed together by the cultivators and incorporated into the soil; the law of return is obeyed, the unseen part of the revolution of the great Wheel is faithfully accomplished.”*<sup>2</sup>

Sir Howard’s view is that soil fertility is the real basis of public health. A medical professional associated with the Hunzas claimed, *“During the period of my association with these people I never saw a case of asthenic dyspepsia, of gastric or duodenal ulcer, of appendicitis, of mucous colitis, of cancer. . .Among these people the abdomen over-sensitive to nerve impressions, to fatigue, anxiety, or cold was unknown. Indeed their buoyant abdominal health has, since my return to the West, provided a remarkable contrast with the dyspeptic and colonic lamentations of our highly civilized communities.”*

Sir Howard’s response to this is, *“The remarkable health of these people is one of the consequences of their agriculture, in which the law of return is scrupulously obeyed. All their vegetable, animal and human wastes [sic] are carefully returned to the soil of the irrigated terraces which produce the grain, fruit, and vegetables which feed them.”*<sup>3</sup>

## **PATHOGENS**

[Much of the following information is adapted from Appropriate Technology for Water Supply and Sanitation, by Feachem, et. al., World Bank, 1980.<sup>4</sup> This comprehensive work cites 394 references from throughout the world, and was carried out as part of the World Bank’s research project on appropriate technology for water supply and sanitation. The reader can assume that the following facts and figures for which no references are shown originated in the above work. Other sources used for reference are as indicated.]

Clearly, the recycling of humanure for agricultural purposes does not necessarily pose a threat to human health, as evidenced by the Hunzas. And yet, it can. Feces can harbor any of a host of disease germs which can make their way into the environment to infect innocent people, as was apparently the case in medieval Europe. In fact, even a healthy person apparently free of disease can pass potentially dangerous pathogens through the feces, simply by being a carrier. Even urine, usually considered sterile, can contain disease germs (see table 6:1).

*Table 6.1 (Source: Feachem et. al., 1980)*  
**POTENTIAL PATHOGENS IN URINE**

Healthy urine on its way out of the human body may contain up to 1,000 bacteria, of several types, per milliliter. More than 100,000 bacteria per milliliter of a single type signals a urinary tract infection.<sup>23</sup> Infected individuals will pass pathogens in the urine that may include:

<b><u>Bacteria</u></b>	<b><u>Disease</u></b>
1. <i>Salmonella typhi</i> .....	<i>typhoid</i>
2. <i>Salmonella paratyphi</i> .....	<i>paratyphoid fever</i>
3. <i>Leptospira</i> .....	<i>leptospirosis</i>
4. <i>Yersinia</i> .....	<i>yersiniosis</i>
<b><u>Worms</u></b>	<b><u>Disease</u></b>
<i>Schistosoma haematobium</i> .....	<i>schistosomiasis</i>

The following information is not meant to be alarming. It's included for the sake of thoroughness, and to illustrate the need to *thermophilically compost* humanure, rather than to try to use it raw for agricultural purposes. Humanure has been used raw in farm fields and is still used in such a state at times in various places throughout the world, including China. This is where the danger lies, as the process of thermophilic composting is required in order to kill dangerous pathogens that may reside in human excrement. When the composting process is side-stepped and pathogenic organic material is distributed throughout the environment, various diseases and worms can infect the population living in the contaminated area. This fact has been widely documented in societies where members recycle their manure carelessly as well as in those that don't recycle at all.

For example, consider the following quote from Jervis (1990): "*The use of night soil [raw human fecal material and urine] as fertilizer is not without its health hazards. Hepatitis B is prevalent in Dacaiyuan [China], as it is in the rest of China. Some effort is being made to chemically treat human waste [sic] or at least to mix it with other ingredients before it is applied to the fields. But chemicals are expensive, and old ways die hard. Night soil is one reason why urban Chinese are so scrupulous about peeling fruit, and why raw vegetables are not part of the diet. Negative features aside, one has only to look at satellite photos of the green belt that surrounds China's cities to understand the value of night soil.*"<sup>5</sup>

On the other hand, "worms and disease" are not spread by properly prepared compost, nor by healthy people. There is no reason to believe that the manure of a



healthy person is dangerous unless left to accumulate, pollute water with intestinal bacteria, and breed flies and/or rats, all of which are the results of negligence or bad customary habits. It should be understood that the breath one exhales can also be the carrier of dangerous pathogens, as can one's saliva and sputum. The issue is confused by the notion that if something is potentially dangerous, then it is always dangerous, which is not true. Furthermore, it is generally not understood that the carefully managed thermophilic composting of humanure kills all human pathogens in the manure. No other system of fecal material and urine recycling or disposal does this without the use of dangerous chemical poisons or a high level of technology and energy consumption.

The pathogens that can exist in human feces can be divided into four general categories: *viruses, bacteria, protozoa, and worms (helminths)*.

There are more than 100 types of **viruses** worldwide that can be passed through human feces, including polioviruses, coxsackieviruses (causing meningitis and myocarditis), echoviruses (causing meningitis and enteritis), reovirus (causing enteritis), adenovirus (causing respiratory illness), infectious hepatitis (causing jaundice), and others (see table 6:2).

Of the pathogenic **bacteria**, the genus *Salmonella* is significant because it contains species causing typhoid fever, paratyphoid, and gastrointestinal disturbances. Another genus of bacteria, *Shigella*, causes dysentery. *Mycobacterium* cause

Table 6.2 (Source: Feachem et. al., 1980)

**POTENTIAL VIRAL PATHOGENS IN FECES**

<u>Virus</u>	<u>Disease</u>	<u>Can Carrier Be Symptomless?</u>
1. <i>Rotaviruses</i> .....	Diarrhea.....	yes
2. <i>Hepatitis A</i> .....	Infectious hepatitis .....	yes
3. <i>Adenoviruses</i> .....	varies .....	yes
4. <i>Reoviruses</i> .....	varies .....	yes
5. <i>Coxsackievirus</i> .....	varies .....	yes
6. <i>Echoviruses</i> .....	varies .....	yes
7. <i>Polioviruses</i> .....	Poliomyelitis .....	yes

Rotaviruses may be responsible for the majority of infant diarrheas. Hepatitis A causes infectious hepatitis, but is often without symptoms, especially in children. Coxsackievirus infection can lead to meningitis, fevers, respiratory diseases, paralysis, and myocarditis. Echovirus infection can cause simple fever, meningitis, diarrhea, or respiratory illness. Most poliovirus infections don't give rise to any clinical illness, although sometimes infection causes a mild, influenza-like illness which may lead to virus-meningitis, paralytic poliomyelitis, permanent disability or death. It's estimated that almost everyone in developing countries becomes infected with poliovirus, and that one out of every thousand poliovirus infections leads to paralytic poliomyelitis.

tuberculosis (see table 6:3).

The pathogenic **protozoa** include *Entamoeba histolytica* (amoebic dysentery), and members of the Hartmanella-Naegleria group (meningo-encephalitis). The cyst stage in the life cycle of protozoa is the primary means of dissemination as the amoeba die quickly once outside the human body. Cysts must be kept moist in order to remain viable for any extended period (see table 6:4).<sup>6</sup>

Finally, a number of parasitic **worms** pass their eggs in feces, including hookworms, roundworms, and whipworms (see table 6:5). Various researchers have reported 59 to 80 worm eggs in sampled liters of sewage. This suggests that billions of pathogenic worm eggs may reach an average wastewater treatment plant daily. These eggs tend to be resistant to environmental conditions due to a thick outer covering.<sup>7</sup>

Now here's a good place to stop and do some calculations. If there are fifty-nine to eighty worm eggs in a liter sample of sewage, then we could reasonably estimate that there are 70 eggs per liter, or 280 eggs per gallon to get a ballpark average.

*Table 6.3 (Source: Feachem et. al., 1980)*  
**POTENTIAL BACTERIAL PATHOGENS IN FECES**

<u>Bacteria</u>	<u>Disease</u>	<u>Symptomless Carrier</u>
1. <i>Salmonella typhi</i> .....	Typhoid fever.....	yes
2. <i>Salmonella paratyphi</i> .....	Paratyphoid fever.....	yes
3. Other <i>Salmonellae</i> .....	Food poisoning .....	yes
4. <i>Shigella</i> .....	Dysentery.....	yes
5. <i>Vibrio cholerae</i> .....	Cholera.....	yes
6. Other <i>Vibrios</i> .....	Diarrhea .....	yes
7. <i>E. coli</i> .....	Diarrhea .....	yes
8. <i>Yersinia</i> .....	Yersiniosis .....	yes
9. <i>Campylobacter</i> .....	Diarrhea .....	yes

*Table 6.4 (Source: Feachem et. al., 1980)*  
**POTENTIAL PROTOZOAN PATHOGENS IN FECES**

<u>Protozoa</u>	<u>Disease</u>	<u>Symptomless carrier?</u>
1. <i>Balantidium coli</i> .....	Diarrhea .....	yes
2. <i>Giardia lamblia</i> .....	Diarrhea.....	yes
3. <i>Entamoeba histolytica</i> .....	Dysentery, colonic .....	yes
	ulceration, liver abscess	

*Table 6.5 (Source: Feachem et. al., 1980)*  
**POTENTIAL WORM PATHOGENS IN FECES**

<u>Common Name</u>	<u>Pathogen</u>	<u>Transmission</u>	<u>Distribution</u>
1. Hookworm	<i>Ancylostoma doudenale</i> <i>Necator americanus</i>	Human-soil-human	Warm, wet climates
2. ———	<i>Heterophyes heterophyes</i>	Dog/cat-snail-fish-human	Middle east, S. Europe, Asia
3. ———	<i>Gastrodiscoides</i>	Pig-snail-aquat. veg.-human	India, Bangladesh, Vietnam, Philippines
4. Giant Intestinal fluke	<i>Fasciolopsis buski</i>	Human/pig-snail-aq. veg.-human	S.E. Asia, China
5. Sheep liver fluke	<i>Fasciola hepatica</i>	Sheep-snail- aq. veg.-human	Worldwide
6. Pinworm	<i>Enterobius vermicularis</i>	Human-human	Worldwide
7. Fish tapeworm	<i>Diphyllobothrium latum</i>	Human/animal-copepod-fish-human	Mainly temperate
8. Cat liver fluke	<i>Opisthorchis felineus</i> , <i>O. viverrini</i>	Animal-aq. snail-fish-human	USSR, Thailand
9. Chinese liver fluke	<i>Chlonorchis sinensi</i>	Animal/human-snail-fish-human	S.E. Asia
10. Roundworm	<i>Ascaris lumbricoides</i>	Human-soil- human	Worldwide
11. Dwarf tapeworm	<i>Hymenolepis spp</i>	Human/rodent-human	Worldwide
12. ———	<i>Metagonimus yokogawai</i>	Dog/cat-snail-fish-human	Japan, Korea, China, Taiwan, Siberia
13. Lung fluke	<i>Paragonimus westermani</i>	Animal/human- snail-crab/crayfish-human	S.E. Asia, Africa, S.America
14. Schistosome, bilharzia	<i>Schistosoma haematobium</i>	Human-snail- human	Africa, M. East, India
-----	<i>S. mansoni</i>	Human-snail- human	Africa, Arabia , Latin America
-----	<i>S. japonicum</i>	Animal/human- snail-human	S.E. Asia
15. Threadworm	<i>Strongyloides stercoralis</i>	Human-human (dog-human?)	Warm, wet climates
16. Beef tapeworm	<i>Taenia saginata</i>	Human-cow- human	Worldwide
Pork tapeworm	<i>T. solium</i>	Human-pig-human or human-human	Worldwide
17. Whipworm	<i>Trichuris trichiura</i>	Human-soil-human	Worldwide

That's approximately 280 pathogenic worm eggs per gallon of wastewater entering wastewater treatment plants. My local wastewater treatment plant serves a population of eight thousand people and collects about 1.5 million gallons of wastewater daily. That means there could be 420 million worm eggs entering the plant each day and settling into the sludge. In a year's time over 153 *billion* parasitic eggs can pass through my local small-town wastewater facility. Now let's look at the worst scenario: all the eggs survive in the sludge because they're resistant to the environmental conditions at the plant. Well, in a year's time, 30 tractor-trailer loads of sludge are hauled out of the local facility. Each truckload of sludge could then contain over 5 *billion* pathogenic worm eggs, en route to maybe a farmer's field, but probably a landfill. Now, if we were composting that manure instead of floating it downstream, we'd be killing those eggs. But there I go getting ahead of myself again.

## INDICATOR PATHOGENS

*Indicator pathogens* are pathogens whose detectable occurrence in soil or water serves as evidence that fecal contamination exists.

The astute reader will have noticed that many of the pathogenic worms listed previously are not found in the United States. Of those that are, the *Ascaris lumbricoides* (roundworm) is the most persistent, and can serve as an indicator for the presence of pathogenic helminths in the environment.

A single female roundworm may lay as many as 27 million eggs in her lifetime.<sup>8</sup> These eggs are protected by an outer covering that is resistant to chemicals and that can enable the eggs to remain viable in soil for long periods of time. The reported viability of roundworm eggs (*Ascaris ova*) in soil ranges from a couple of weeks under sunny, sandy conditions<sup>9</sup>, to 2 and a half years<sup>10</sup>, four years<sup>11</sup>, five and a half years<sup>12</sup> or even ten years<sup>13</sup> in soil, depending on the source of the information. Consequently, the eggs of the roundworm seem to be the best indicator for the determination of parasitic worm pathogens in compost. In China, current standards for the agricultural reuse of humanure require an *Ascaris* mortality of greater than 95 percent.

*Ascaris* eggs develop at temperatures between 15.5°C (59.90° F) and 35°C (95.00° F), but the eggs disintegrate at temperatures above 38°C (100.40° F)<sup>14</sup>. The temperatures generated during thermophilic composting can significantly exceed levels necessary to destroy roundworm eggs.

One way to determine if the compost you're using is contaminated with viable roundworm eggs is to have a stool analysis done at a local hospital. If your compost

is contaminated and you're using the compost to grow your own food, then there's a good chance that you've contaminated yourself. A stool analysis will reveal whether that is the case or not. Such an analysis cost about \$41.00 (1993). [\*See page 135]

**Indicator bacteria** include fecal coliforms, which reproduce in the intestinal systems of warm blooded animals. If one wants to test a water supply for fecal contamination, then fecal coliforms, usually *Escherichia coli*, are looked for. The absence of *E. coli* in water indicates that the water is free from fecal contamination.

Water tests, however, often determine the level of *total coliforms* in the water, reported as the number of coliform/100 ml. Such a test measures *all* species of the coliform group and is not limited to species originating in warm-blooded animals. Since some coliform species come from the soil, the results of this test are not always indicative of fecal contamination in a *stream* analysis. However, this test can be used for *ground water* supplies, as no coliforms should be present in ground water unless it has been contaminated by a warm blooded animal.

*Fecal* coliforms do not multiply outside the intestines of warm blooded animals, and their presence in water is unlikely unless there is fecal pollution, They survive for a shorter time in natural waters than the coliform group as a whole, therefore their presence indicates relatively recent pollution. In domestic sewage, the fecal coliform count is usually 90% or more of the total coliform count, but in natural streams fecal coliforms may range from 10-30% of the total coliform density. Almost all natural waters have a presence of fecal coliforms, since all warm-blooded animals excrete them. Most states in the U.S. limit the fecal coliform concentration allowable in waters used for water sports to 200 fecal coliform/100ml.

Table 6.13

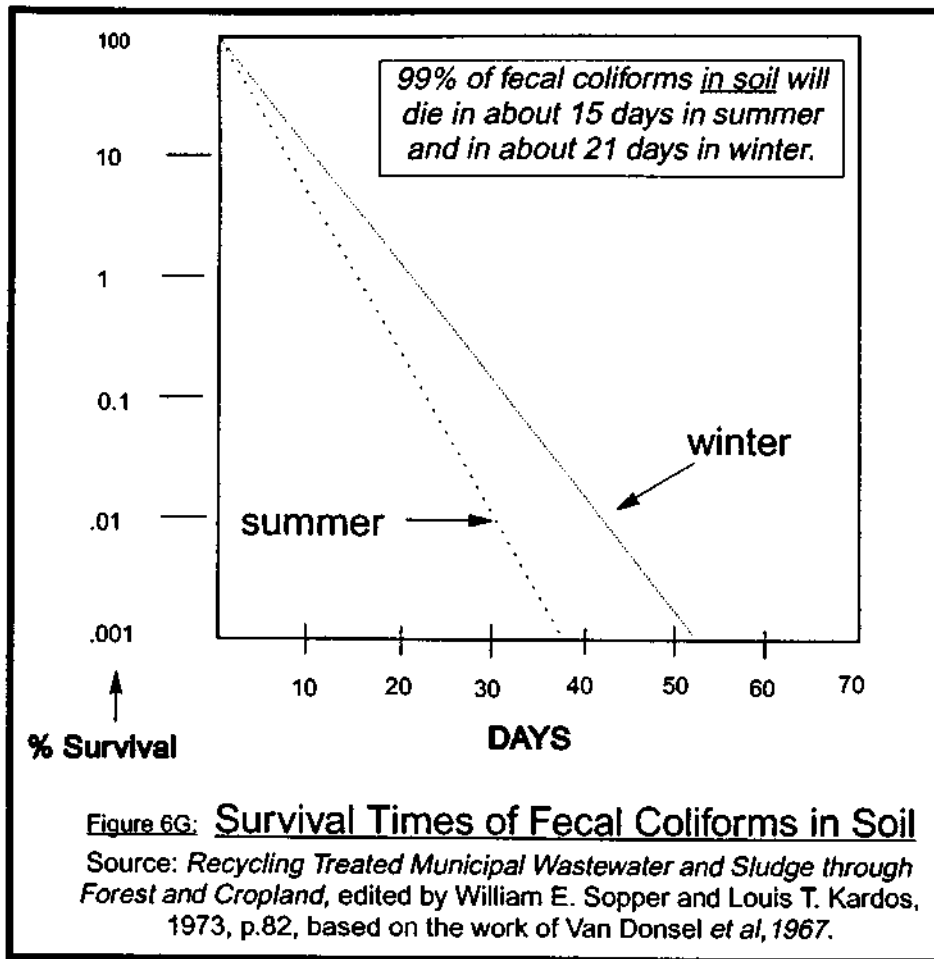
**Average Density of Fecal Coliforms Excreted in 24 Hours (million/100ml)**

Human	13.0
Duck	33.0
Sheep	16.0
Pig	3.3
Chicken	1.3
Cow	.23
Turkey	.29

Bacterial analyses of drinking water supplies are routinely provided for a small fee (in 1994 around \$20.00) by agricultural supply firms, water treatment companies, or private labs.

### **PERSISTENCE OF PATHOGENS IN SOIL, CROPS, MANURE AND SLUDGE**

According to Feachem, et. al. (1980), the persistence of fecal pathogens in the environment can be summarized as follows:



## In Soil

Survival times of pathogens in soil are affected by soil moisture, pH, type of soil, temperature, sunlight, and organic matter. Although **fecal coliforms** can survive for several years under optimum conditions, a 99% reduction is likely within 25 days in warm climates (see Figure 6G). **Salmonella bacteria** may survive for a year in rich, moist, organic soil, although 50 days would be a more typical survival time. **Viruses** can

survive up to three months in warm weather, and up to six months in cold. **Protozoan cysts** are unlikely to survive for more than 10 days. **Roundworm eggs** can survive for several years.

The viruses, bacteria, protozoa and worms that can be passed in human excrement all have limited survival times outside of the human body. Let's take a look at their survival times when deposited raw into soil (refer to tables 6.6 through 6.10):

## Survival of pathogens On Crops

**Bacteria** and **viruses** cannot penetrate undamaged vegetable skins. However, pathogens can survive on the surfaces of vegetables, especially root vegetables. Sunshine and low air humidity will promote the death of pathogens. **Viruses** can survive up to 2 months on crops but usually less than one month. **Indicator bacteria** up to several months, but usually less than one month. **Protozoan cysts** usually less than two days. **Worm eggs** usually less than one month.

For example, lettuce and radishes sprayed with sewage inoculated with poliovirus I showed a 99% reduction in pathogens after 6 days, 100% after 36 days (in Ohio). Radishes grown outdoors in soil fertilized with fresh typhoid feces four

*Table 6.6 (Source: Feachem et. al., 1980)*  
**SURVIVAL OF ENTEROVIRUSES IN SOIL**

**Viruses** - These parasites, which are smaller than bacteria, can only reproduce inside the animal or plant they parasitize. However, some can survive for long periods outside of their host:

**Enteroviruses** - Enteroviruses are those that reproduce in the intestinal tract. They have been found to survive in soil for periods ranging between 15 and 170 days. The following chart shows the survival times of enteroviruses in various types of soil and soil conditions:

<u>Soil Type</u>	<u>pH</u>	<u>% Moisture</u>	<u>°C</u>	<u>Days of Survival</u> (less than)
Sterile, sandy	7.5-----	10-20%-----	3-10 -----	130-170 days
		"	18-23	90-110
	5-----	"-----	3-10 -----	110-150
		"	18-23	40-90
Non-sterile, sandy	7.5-----	"-----	3-10 -----	110-170
		"	18-23	40-110
	5-----	"-----	3-10 -----	90-150
		"	18-23	25-60
Sterile, loamy	7.5-----	"-----	3-10 -----	70-150
		"	18-23	70-110
	5-----	"-----	3-10 -----	90-150
		"	18-23	25-60
Non-sterile, loamy	7.5-----	"-----	3-10 -----	110-150
		"	18-23	70-110
	5-----	"-----	3-10 -----	90-130
		"	18-23	25-60
Non-sterile, sandy	7.5-----	"-----	18-23 -----	15-25

*Table 6.7 (Source: Feachem et. al., 1980)*  
**SURVIVAL TIME OF SOME PROTOZOA IN SOIL**

<u>Protozoa</u>	<u>Soil</u>	<u>Moisture</u>	<u>Temp°C</u>	<u>Survival</u>
<i>E. histolytica</i>	loam/sand	Damp	28-34	8-10 days
"	soil	Moist	?	42-72 hr
"	"	Dry	?	18-42 hrs.

*Table 6.8 (Source: Feachem et. al., 1980)*  
**SURVIVAL TIME OF SOME BACTERIA IN SOIL**

<u>Bacteria</u>	<u>Soil</u>	<u>Moisture</u>	<u>Temp. °C</u>	<u>Survival</u>
<i>Streptococci</i> -----	<i>Loam</i>	?	?	<i>9-11 weeks</i>
“-----	<i>Sandy loam</i>	?	?	<i>5-6 weeks</i>
<i>S. Typhi</i> -----	<i>various soils</i>	?	22	<i>2 days-400 days</i>
<i>Bovine tubercule bacilli</i>	<i>soil &amp; dung</i>	?	?	<i>less than 178 days</i>
<i>Leptospire</i> s-----	<i>varied</i>	<i>varied</i>	<i>summer</i>	<i>12 hrs-15 days</i>

*Table 6.9 (Source: Feachem et. al., 1980)*

**SURVIVAL OF POLIOVIRUSES IN SOIL**

<u>Soil Type</u>	<u>Virus</u>	<u>Moisture</u>	<u>Temp. °C</u>	<u>Days of Survival</u>
<i>Sand dunes</i> -----	<i>Poliovirus</i>	<i>dry</i>	?	<i>Less than 77</i>
		<i>moist</i>	?	<i>" 91</i>
<i>Loamy fine sand</i> -----	<i>Poliovirus I</i>	<i>moist</i>	4	<i>90% reduction in 84 days</i>
		<i>moist</i>	20	<i>99.999% red. in 84 days</i>
<i>Soil irrigated w/ effluent, pH=8.5</i> -----	<i>Polioviruses 1,2 &amp;3</i>	<i>9-20%</i>	<i>12-33</i>	<i>Less than 8</i>
<i>Sludge or effluent irrigated soil</i> -----	<i>Poliovirus I</i>	<i>180mm total rain</i>	<i>-14-27</i> -----	<i>96-123 after sludge applied</i>
			<i>-14-27</i> -----	<i>89-96 after effluent applied</i>
		<i>190mm total rain</i>	<i>15-33</i> -----	<i>less than 11 days after sludge or effluent applied</i>



Table 6.10 (Source: Feachem et. al., 1980)

**SURVIVAL TIME OF SOME PATHOGENIC WORMS IN SOIL**

<u>Worm</u>	<u>Soil</u>	<u>Moisture</u>	<u>°C</u>	<u>Survival</u>
Hookworm larvae	Sand	?	rm. temp.	less than 4 months
	Soil	?	open shade, Sumatra	less than 6 months
	Soil	Moist	Dense shade	9-11 wks
			Mod. shade	6-7.5 wks
			Sunlight	5-10 days
	Soil	Water covered	varied	10-43 days
	Soil	Moist	0°	less than 1 week
16	14-17.5 weeks			
27	9-11 weeks			
35	less than 3 weeks			
		40	less than 1 week	
Hookworm ova (eggs)	Heated soil with night soil	water covered	15-27	9% survival after 2 weeks
	Unheated soil with night soil	water covered	15-27	3% survival after 2 weeks
Roundworm ova	Sandy, shaded	25-36	31% dead after 54 days	
	Sandy, sun	24-38	99% dead after 15 days	
	Loam, shad	25-36	3.5% dead after 21 days	
	Loam, sun	24-38	4% dead after 21 days	
	Clay, shade	25-36	2% dead after 21 days	
	Clay, sun	24-38	12% dead after 21 days	
	Humus, shade	25-36	1.5% dead after 22 days	
	Clay, shade	22-35	more than 90 days	
	Sandy, shade	22-35	less than 90 days	
	Sandy, sun	22-35	less than 90 days	
	Soil irrigated with sewage	?	less than 2.5 years	
	Soil	?	2 years, 5.5 years <sup>14</sup> , even 10 years <sup>15</sup>	

days after planting showed a pathogen survival period of less than 24 days. Tomatoes and lettuce contaminated with a suspension of roundworm eggs showed a 99% reduction in eggs in 19 days and a 100% reduction in 4 weeks. These tests indicate that if there is any doubt about pathogen contamination of compost, the compost should be applied to long-season crops at the time of planting, so that sufficient time ensues for the pathogens to die before harvest.

***Pathogen survival In Sludge and Feces/Urine***

**Viruses** can survive up to 5 months, but usually less than 3 months in sludge and night soil. **Indicator bacteria** up to 5 months, but usually less than 4 months.

Salmonellae up to 5 months, but usually less than one month. Tubercle bacilli up to 2 years, but usually less than 5 months. **Protozoan cysts** up to one month, but usually less than 10 days. **Worm eggs** vary depending on species, but roundworm eggs may survive for many months.

When I started writing this book, I'd been composting my own humanure for nearly fourteen years and using it to grow about 50% of my food (the other 50% I buy). My sawdust toilet was used by many other people during that time period, especially since I operated an alternative school for five years on my property with a peak enrollment of 23 kids, which involved frequent use of my composting toilet system. I had many gatherings of people at my homestead over the years, as many as 150 people during a weekend. Not long before I began writing this book, I had 130 people visit within a twenty-four hour period. The humanure receptacle had to be emptied onto the compost pile four times that day. I've had little control over who's been using my toilet. There may have been people infected with all manner of pathogens depositing their contaminated feces into my composting system. However, I've had faith that the thermophilic composting routine I use has been killing any human pathogens present in the compost. Nevertheless, for the sake of thoroughness I had two stool analyses conducted by the local hospital laboratory as I wrote this, and no intestinal worms or eggs were found.

### ***ELIMINATING PATHOGENS FROM HUMANURE***

It should be evident to the reader by now that humanure certainly possesses the capability of transmitting various diseases. For this reason, it should also be evident that the composting of humanure is a serious undertaking and should not be done in a frivolous, careless or haphazard manner. The pathogens that may be present in humanure have various survival periods outside the human body and maintain varied capacities for re-infecting people. This is why the *careful management* of a thermophilic compost system is so important. Nevertheless, there is no proven, natural, low-tech method for destroying human pathogens in organic refuse that is as successful and accessible to the average human as well-managed thermophilic composting.

The following information illustrates the various waste treatment methods and composting methods commonly used today and shows the transmission of pathogens through the individual systems:

## Outhouses and Pit Latrines

Outhouses have odor problems, breed flies and possibly mosquitoes, and pollute groundwater. However, if the contents of a pit latrine have been filled over and left for a minimum of one year, there will be no surviving pathogens except for the possibility of roundworm eggs, according to Feachems. This risk is small enough that the contents of pit latrines, after twelve months burial, can be used agriculturally. Franceys, et. al. (1992) state, "Solids from pit latrines are innocuous if the latrines have not been used for two years or so, as in alternating double pits."<sup>15</sup>

### Septic Tanks

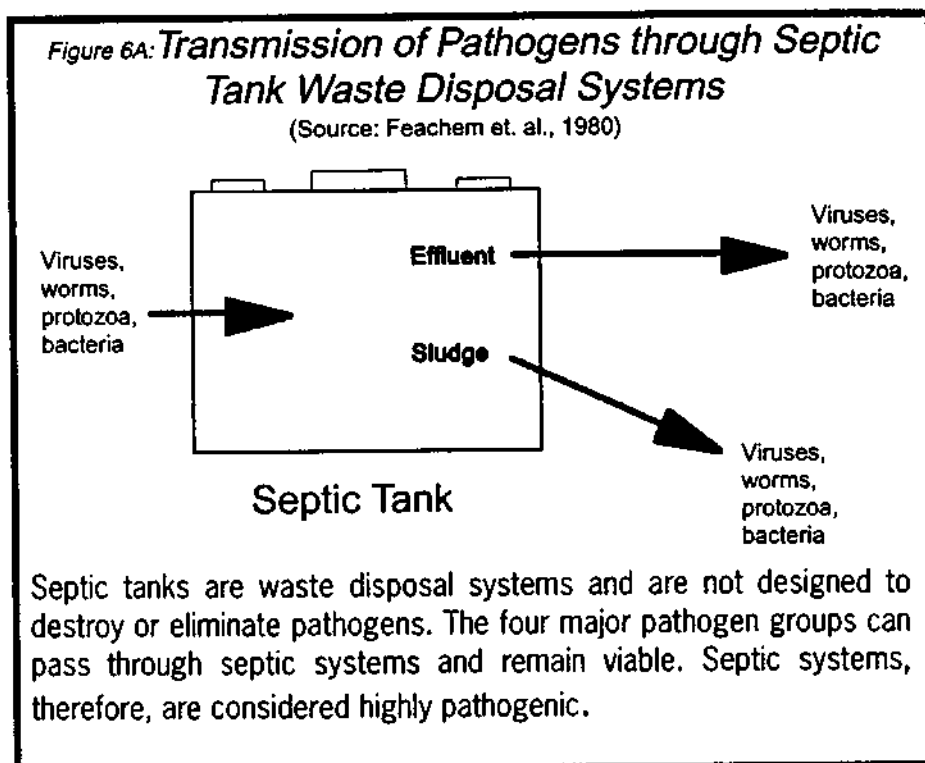
It is safe to assume that septic tank effluents and sludge are highly pathogenic (see figure 6A).

### Conventional Sewage Treatment Plants

The only sewage digestion process producing a guaranteed pathogen-free sludge is batch ther-

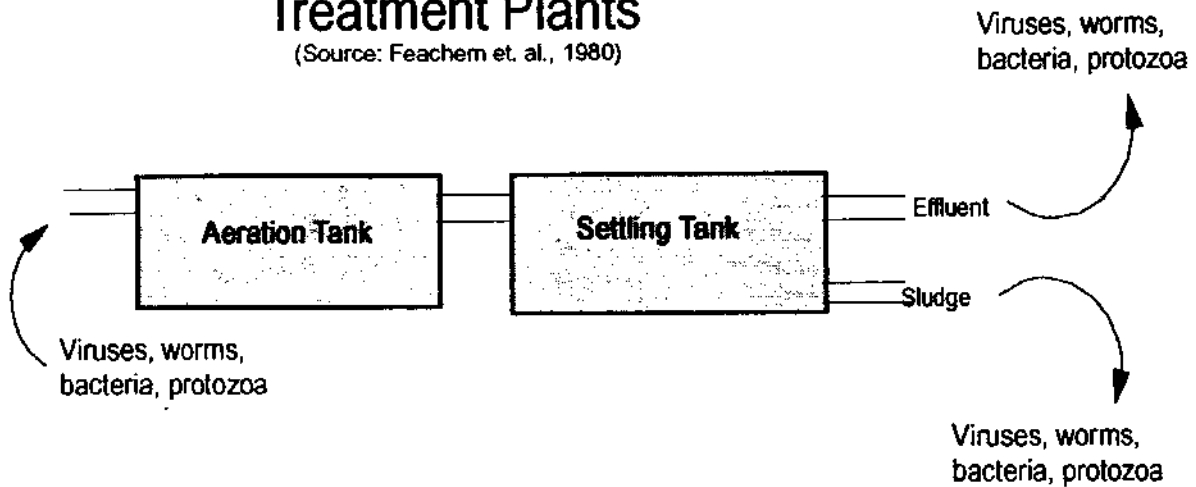
mophilic digestion in which all of the sludge is maintained at 50°C (122°F) for 13 days. All other sewage digestion processes will allow the survival of worm eggs and possibly pathogenic bacteria. Typical sewage treatment plants instead use a continuous process where wastewater is added daily or more frequently, thereby guaranteeing the survival of pathogens.

I took an interest in my local wastewater treatment plant when I discovered that the treated water it was discharging into our local creek had ten times the level of nitrates that unpolluted water has, and three times the level of nitrates acceptable for drinking water.<sup>16</sup> In other words, the water being discharged from the water treatment plant was polluted with nitrates (we didn't test for pathogens or chlorine levels). Despite the pollution, the levels were within legal limits for wastewater discharges (see figure 6B).



## Figure 6B: Transmission of Pathogens through Conventional Sewage Treatment Plants

(Source: Feachem et. al., 1980)

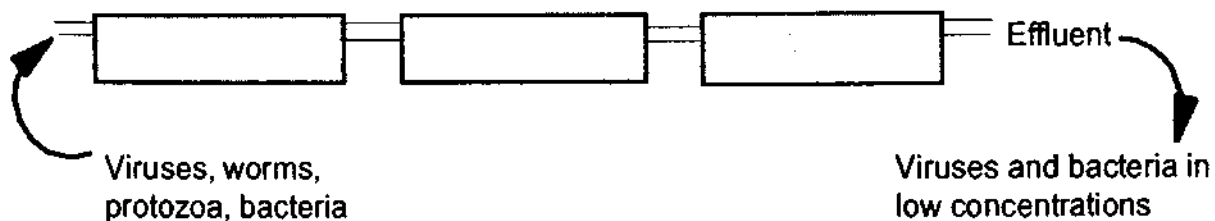


*Conventional sewage treatment plants allow the transmission of pathogens through them. Consequently, the effluent is commonly treated with chemical poisons such as chlorine, and the sludge is commonly buried in landfills.*

## Waste Stabilization Ponds

Waste stabilization ponds, large shallow ponds widely used in North America, Latin America, Africa and Asia, involve the use of both beneficial bacteria and algae in the decomposition of organic waste materials. Although they can breed mosquitoes, they can be designed and managed well enough to yield pathogen-free waste

## Figure 6C: Transmission of Pathogens through Waste Stabilization Ponds



(Source: Feachem et. al., 1980)

water. However, they typically yield water with low concentrations of both pathogenic viruses and bacteria (see figure 6C).

### ***Composting Toilets and Mouldering Toilets***

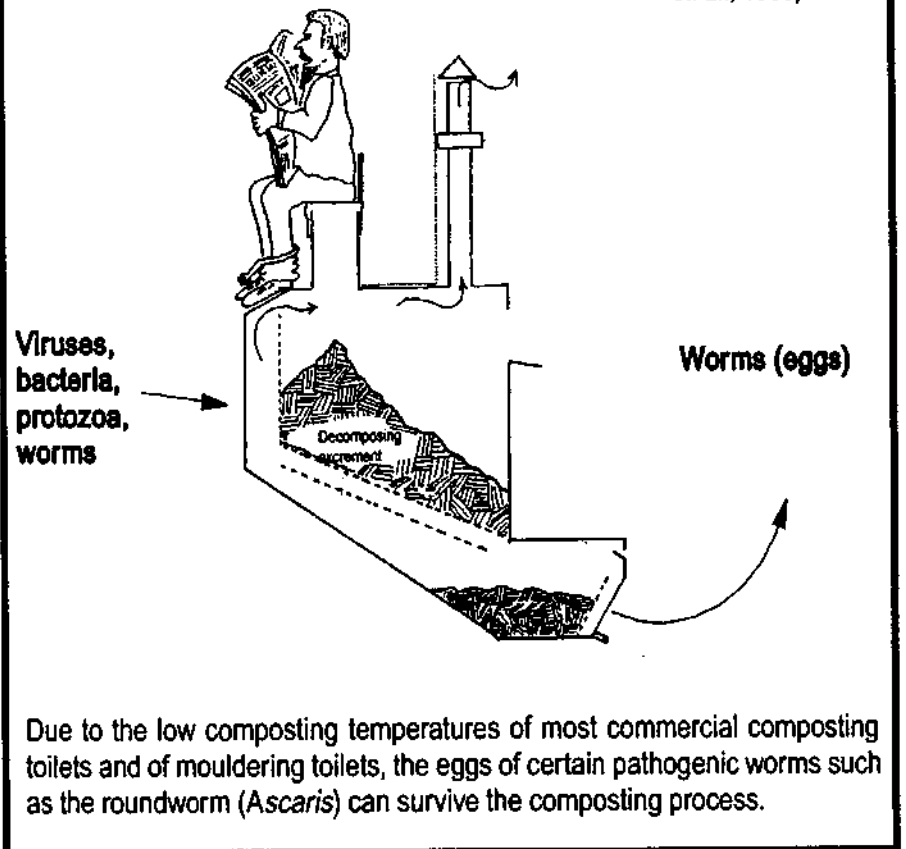
Due to the relatively anaerobic conditions of the multrum and mouldering toilets and the consequently low decomposition temperatures, complete elimination of pathogens from the manure is not likely to be obtained.

However, according to Feachems, et. al., a minimum retention time of three months produces a compost

free of all pathogens except possibly some intestinal worm eggs. Also, the compost obtained from these types of toilets can conceivably be composted again in a thermophilic pile and rendered suitable for food gardens (see figure 6D and table 6.11).

**Figure 6D: Transmission of Pathogens through Passive, Low Temperature Composting Toilets and Mouldering Toilets**

(Source: Feachem et. al., 1980)

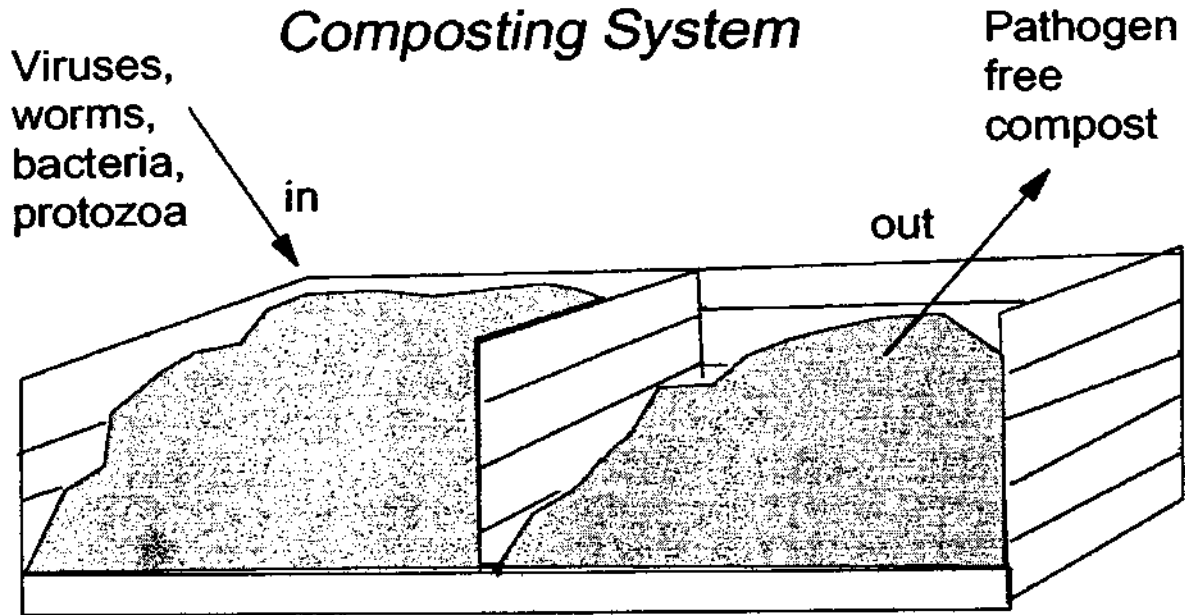


### ***Well-managed Thermophilic Composting System***

Complete pathogen destruction is guaranteed by arriving at a temperature of 62°C (143.6°F) for one hour, or 50°C (122°F) for one day, or 46°C (114.8°F) for one week, or 43°C (109.4°F) for one month. It appears that no excreted pathogen can survive a temperature of 65°C (149°F) for more than a few minutes. A compost pile containing entrapped oxygen may rapidly rise to a temperature of 55°C (131°F) or above, or will maintain a temperature hot enough for a long enough period of time to thoroughly destroy human pathogens (see figure 6E). Table 6.11 indicates survival times of pathogens in a) soil, b) anaerobic decomposition conditions, c) composting toilets and d) thermophilic compost piles.

*Figure 6E: Transmission  
of Pathogens through  
a Thermophilic  
Composting System*

(Source: Feachem et. al., 1980)



A properly managed thermophilic composting system will generate enough heat to destroy all four groups of human pathogens including parasitic worms and their eggs, viruses, bacteria and protozoa. The resulting finished compost is a hygienically safe, user friendly, soil-building humus.

### ***MORE ON PARASITIC WORMS***

This is a good topic to discuss in greater detail as most people know so little about it. Therefore, I'll take a few minutes here to discuss the most common of human worm parasites: pinworms, hookworms, whipworms and roundworms.

#### ***Pinworms***

I confess, my kids had pinworms during childhood. I know exactly who they

Table 6.11 (Source: Feachem et. al. 1980)

**PATHOGEN SURVIVAL BY COMPOSTING OR SOIL APPLICATION**

<b><u>Pathogen</u></b>	<b><u>Soil Application</u></b>	<b><u>Unheated Anaerobic Digestion</u></b>	<b><u>Composting Toilets (3 mo. min. ret.)</u></b>	<b><u>Thermophilic Composting</u></b>
<i>Enteric viruses</i>	May survive 5 months	Over 3 months	Probably eliminated	Killed rapidly at 60°C
<i>Salmonellae</i>	3 months to 1 year	Several weeks	A few may survive	Killed in 20 hrs. at 60°C
<i>Shigellae</i>	Up to 3 months	A few days	Probably eliminated	Killed in 1 hr. at 55°C or in 10 days at 40°C
<i>E. coli</i>	Several months	Several weeks	Probably eliminated	Killed rapidly above 60°C
<i>Cholera vibrio</i>	1 week or less	1 or 2 weeks	Probably eliminated	Killed rapidly above 55°C
<i>Leptospires</i>	Up to 15 days	2 days or less	Eliminated	Killed in 10 min. at 55°C
<i>Entamoeba histolytica cysts</i>	1 week or less	3 weeks or less	Eliminated	Killed in 5 min. at 50°C or 1 day at 40°C
<i>Hookworm eggs</i>	20 weeks	Will survive	May survive	Killed in 5 min. at 50°C or 1 hr at 45°C
<i>Roundworm (Ascaris) eggs</i>	Several years	Many months	Survive well	Killed in 2 hrs. at 55°C, 20 hrs. at 50°C, 200 hrs. at 45°C
<i>Schistosome eggs</i>	One month	One month	Eliminated	Killed in 1 hr. at 50°C
<i>Taenia eggs</i>	Over 1 year	A few months	May survive	Killed in 10 min. at 59°C, over 4 hrs. at 45°C

got them from (another kid), and getting rid of them was a simple matter. However, the rumor was circulated that they got them from our compost. We were also told to worm our cats to prevent pinworms in the kids (these rumors allegedly originated in a doctor's office). Yet, the pinworm life cycle does not include a stage in soil, compost, manure or cats. These unpleasant parasites are spread from human to human by direct contact, and by inhaling eggs.

Pinworms (*Enterobius vermicularis*) lay microscopic eggs at the anus of a human being, its only known host. This causes itching at the anus which is the primary symptom of pinworm infestation. The eggs can be picked up almost anywhere, and once in the human digestive system they develop into the tiny worms. Some estimate that pinworms infest or have infested 75% of all New York City children in the 3-5 year age group, and that similar figures exist for other cities.<sup>17</sup>

These worms have the widest geographic distribution of any of the worm parasites, and are estimated to infect 208.8 million people in the world (18 million in Canada and the U.S.). An Eskimo village was found to have a 66 per cent infection rate, a 60% rate has been found in Brazil, and a 12-41 % rate in Washington D.C.

Infection is spread by the hand to mouth transmission of eggs resulting from scratching the anus, as well as from breathing airborne eggs. In households with several members infected with pinworms, 92% of dust samples contained the eggs. The dust samples were collected from tables, chairs, baseboards, floors, couches, dressers, shelves, window sills, picture frames, toilet seats, mattresses, bath tubs, wash basins and bed sheets. Pinworm eggs have also been found in the dust from school rooms and school cafeterias.

Pregnant female pinworms contain 11,000 to 15,000 eggs. Fortunately, pinworm eggs don't survive long outside their host. At room temperature and 30% to 54% relative humidity more than 90% of the eggs will die within two days. At higher summer temperatures, 90% will die within three hours. Eggs survive longest (2-6 days) under cool, humid conditions; in dry air, none will survive for more than 16 hours.

A worm's life span is 37-53 days and an infection would self-terminate in this period, without treatment, in the absence of reinfection. *The amount of time that passes from ingestion of eggs to new eggs being laid at the anus is from 4 to 6 weeks.*<sup>18</sup>

Although dogs and cats do not harbor pinworms, the eggs can get on their fur and find their way back to their human hosts. In about one-third of infected children, eggs may be found under the fingernails.

*In 95% of infected persons, pinworm eggs aren't found in the feces.* Transmission of eggs to feces and to soil is not part of the pinworm life cycle, which



is one reason why the eggs aren't likely to end up in either feces or compost. Even if they do, they quickly die outside the human host.

One of the worst symptoms of pinworm infestation is the trauma of the parents, whose feelings of guilt, no matter how clean and conscientious they may be, are understandable. However, if you're composting your manure, you can be sure that you are not thereby breeding or spreading pinworms. Quite the contrary, any pinworms or eggs getting into your compost are being destroyed.<sup>19</sup>

### Hookworms

Hookworm species in humans include *Necator americanus*, *Ancylostoma duodenale*, *A. braziliense*, *A. caninum*, and *A. ceylanicum*.

The small worms are about a centimeter long, and humans are almost the exclusive host of *A. duodenale* and *N. americanus*. A hookworm of cats and dogs, *A. caninum*, is an extremely rare intestinal parasite of humans.

The eggs are passed in the feces and mature into larvae outside the human host in favorable conditions. The larvae attach themselves to the human host usually at the bottom of the foot when they're walked on, and then enter their host through pores, hair follicles or even unbroken skin. They tend to migrate to the upper small intestine where they suck their host's blood. Within 5 or 6 weeks they'll mature enough to produce up to 20,000 eggs per day.

Hookworms are estimated to infect 500 million people throughout the world, causing a *daily blood loss of more than 1 million liters*, which is as much blood as can be found in all the people in the city of Erie, PA, or Austin, Texas. An infection can last 2 - 14 years. Light infections can produce no recognizable symptoms, while a moderate or heavy infection can produce an iron deficiency anemia. Infection can be determined by a stool analysis.

These worms tend to be found in tropical and semi-tropical areas and are

Table 6.12  
**Hookworms:**

*Hookworm larvae develop outside the host and favor a temperature range of 23°C to 33°C (73°F to 91°F).*

<u>Temperature</u>	<u>Survival Time of</u>	
	<u>Eggs</u>	<u>Larvae</u>
45°C (113°F).....	Few hours .....	less than 1 hour
0°C (32°F).....	7 days .....	less than 2 weeks
-11°C (12°F).....	.....	less than 24 hours

Both thermophilic composting and freezing weather will kill hookworms and eggs.

spread by defecating on the soil. Both the high temperatures of composting will kill the eggs and larvae, as will the freezing temperatures of winter. Drying is also destructive<sup>20</sup>

### ***Whipworm***

Whipworms (*Trichuris trichiura*) are usually found in humans, but also may be found in monkeys or hogs. They're usually under two inches long and the female can produce 3,000 to 10,000 eggs per day. Larval development occurs outside the host, and in a favorable environment (warm, moist, shaded soil) first stage larvae are produced from eggs in 3 weeks.

Hundreds of millions of people worldwide, as much as 80% of the population in certain tropical countries, are infected by whipworms. In the U.S., whipworm is found in the south where there is heavy rainfall, a subtropical climate, and soil polluted with feces. The lifespan of the worm is usually considered to be 4 to 6 years.

Infection results from ingestion of the eggs, which can contaminate the hands of persons handling soil that has been defecated on by an infected person. Light infections may not show any symptoms. Heavy infections can result in anemia, and death. A stool examination will determine if there is an infection.

Cold winter temperatures of -8°C to -12°C (17.6°F to 10.4°F) are fatal to the eggs, as are the high temperatures of thermophilic composting.<sup>21</sup>

### ***Roundworms***

The roundworms (*Ascaris lumbricoides*) are fairly large worms (10 inches) which parasitize the human host by eating semi-digested food in the small intestine. The females can lay 200,000 eggs per day for a lifetime total of 26 million or so. The larvae develop from the eggs *in soil* under favorable conditions (21°C to 30°C or 69.8°F to 86°F). Above 37°C (98.6°F) they cannot fully develop.

Approximately 900 million people are infected with roundworms worldwide, one million of them in the U.S. The eggs are usually transmitted hand to mouth by people, usually children, who have come into contact with the eggs in his/her environment. Infected persons usually complain of a vague abdominal pain. Diagnosis is by stool analysis.<sup>22</sup>

The eggs are destroyed by direct sunlight within 15 hours, and are killed by temperatures above 40°C (104°F), dying within an hour at 50°C (122°F). Roundworm eggs are resistant to freezing temperatures, chemical disinfectants, and other strong chemicals. Thermophilic composting will kill them.

Roundworms, like hookworms and whipworms, are spread by fecal contamination of soil. Much of this contamination is caused and spread by children who defecate outdoors within their living area. One sure way to eradicate fecal pathogens is to conscientiously collect and thermophilically compost *all* fecal material. Therefore, it is very important when composting humanure to be certain that *all* children use the toilet facility and do not defecate elsewhere. When changing soiled diapers, scrape the fecal material into the humanure receptacle with toilet paper or another biodegradable material. It's up to adults to keep an eye on kids and make sure they understand the importance of *always using a toilet facility*.

Fecal environmental contamination can also be caused by using raw fecal material for agricultural purposes. *Proper thermophilic composting of all fecal material is essential for the eradication of fecal pathogens.*

## ***SUMMARY OF CONDITIONS NEEDED TO KILL PATHOGENS***

There are two primary factors leading to the death of pathogens in humanure. The first is *temperature*. A compost pile that is properly managed in order to cultivate thermophilic organisms will destroy pathogens with the heat it generates.

The second factor is *time*. The lower the temperature of the compost, the longer the retention time needed for the destruction of pathogens. That period may be long if the pile doesn't heat at all, such as in a mouldered pile, as roundworm eggs have been known to survive for years in soil, and some bacteria can survive for two years in sludge and over a year in soil. Feachem, however, states that three months retention time will kill all of the pathogens in a low-temperature composting toilet except worm eggs, although table 6.11 (also from Feachem) indicates that some additional pathogen survival may occur.

A high-temperature thermophilic compost pile will destroy pathogens, including worm eggs, quickly, possibly in a matter of minutes. Lower temperatures require longer periods of time, possibly hours, days, weeks or months, to effectively destroy pathogens. One need not strive for extremely high temperatures (say 150°F or 65°C) in a compost pile to feel confident about the destruction of pathogens. Instead, it may be more realistic for one to strive to maintain lower temperatures in a compost pile for longer periods of time (say 120°F or 50°C for twenty four hours, or 115°F or 46°C for a week). For example, as one source puts it, "*All fecal microorganisms, including enteric viruses and roundworm eggs, will die if the temperature exceeds 46°C (114.80° F) for one week.*"<sup>15</sup>

A sound approach to pathogen destruction when composting humanure is to

thermophilically compost the organic refuse, then allow the compost to sit, undisturbed, for a lengthy period of time after the thermophilic heating stage has ended. The subject of thermophilic composting is discussed in greater detail in chapter seven.

In the words of Feachem (et. al.), *“The effectiveness of excreta treatment methods depends very much on their time-temperature characteristics. The effective processes are those that either make the excreta warm (55°C) [131°F], hold it for a long time (one year), or feature some effective combination of time and temperature.”*

In short, the combined factors of temperature and time will do the job of converting “turds into tomatoes” (The time/temperature factor of pathogen destruction is illustrated in figure 6F.)

## CONCLUSIONS

Humanure is a valuable resource suitable for agricultural purposes and has been recycled for such purposes by large segments of the world’s human population for thousands of years.

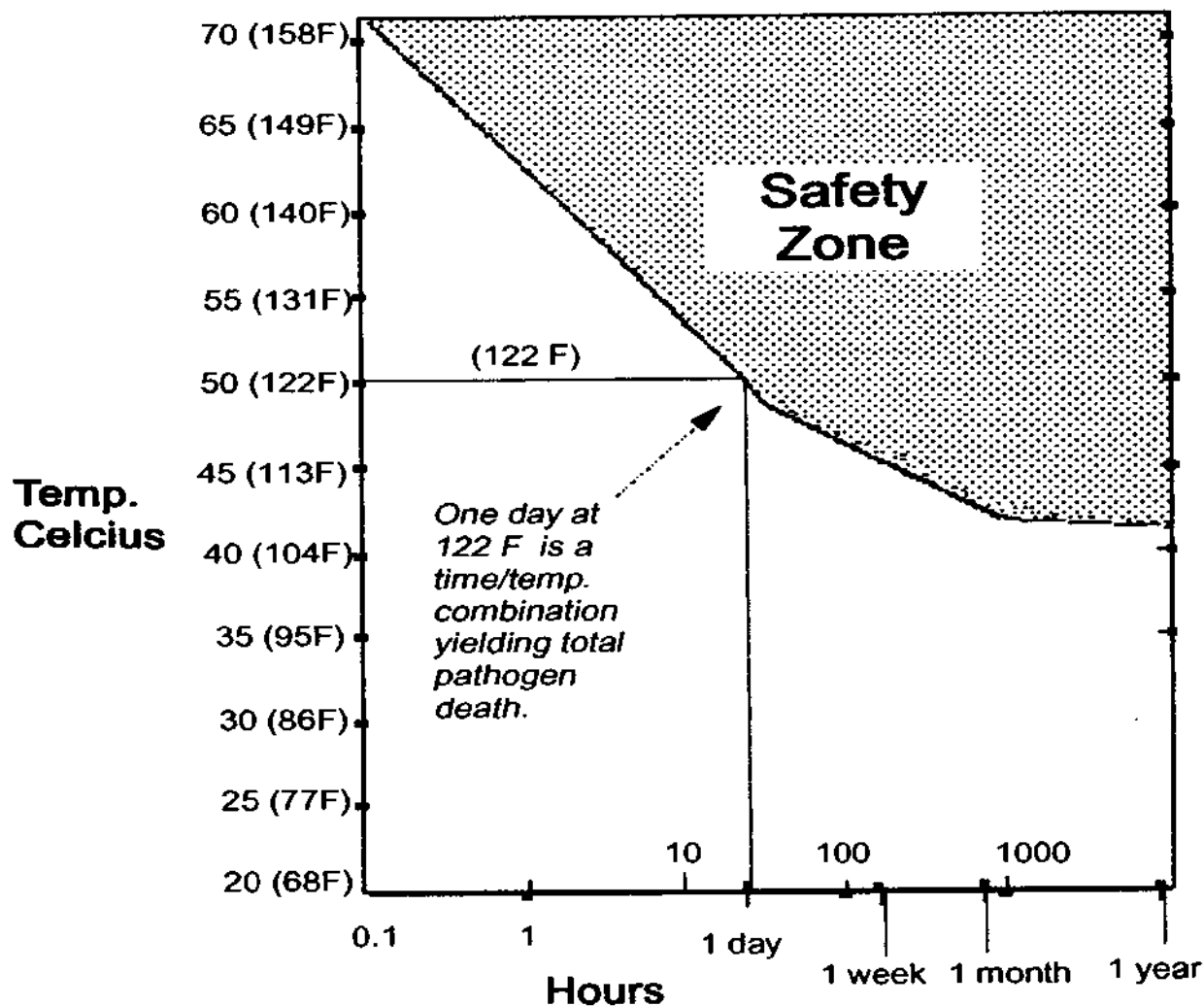
However, humanure contains the potential for harboring human pathogens, including bacteria, viruses, protozoa and parasitic worms or their eggs, and thereby can contribute to the spread of disease. When pathogenic raw humanure is applied to soil, pathogenic bacteria may continue to survive in the soil for over a year, and roundworm eggs may survive for many years, thereby maintaining the possibility of human reinfection for lengthy periods of time.

However, when humanure is thermophilically composted, human pathogens are rapidly destroyed, and the humanure is thereby converted into a hygienically safe form suitable for soil applications for the purpose of human food production.

Finally, it must be added that thermophilic composting requires no electricity and therefore no coal combustion, no acid rain, no nuclear power plants, no nuclear waste, no petrochemicals, and no consumption of fossil fuels. The composting process produces no waste, no pollutants, and no toxic byproducts. Thermophilic composting of humanure can be carried out century after century, millennium after millennium, with no stress on our ecosystems, no consumption of resources, no garbage or sludge for our landfills. And all the while it will produce a valuable resource necessary for our survival while preventing the accumulation of dangerous and pathogenic waste. If that doesn’t describe *sustainability*, nothing does.

Figure 6 F (Source: Feachem et. al. 1980)

## Safety Zone for Pathogen Death



The above pathogen death boundaries include those for *enteric viruses, shigella, taenia, vibrio cholera, Ascaris (roundworm), salmonella, and entamoeba histolytica*. Source: Feachem, et. al., 1980.

Table 6.14- Parasitic Worm Egg Death

Eggs	Temp.(°C)	Time required to die
Schistosome	53.5	1 minute
Hookworm	55.0	1 minute
Roundworm	55.0	10 minutes
"	60.0	.5 seconds
"	0	4 years
"	-30	24 hours

[Source: *Compost, Fertilizer, and Biogas Production from Human and Farm Wastes in the People's Republic of China*, (1978), M. G. McGarry and J. Stainforth, editors, International Development Research Center, Ottawa, Canada. (page 43)]

## REFERENCES - CHAPTER SIX

- 1 - Tompkins, P., and Boyd, C. (1989). Secrets of the Soil. Harper and Row: New York. (pp.94-5).
- 2 - Howard, Sir Albert. The Soil and Health: A Study of Organic Agriculture. Schocken: New York. 1947. (pp. 37-38).
- 3 - Ibid. (p.177).
- 4 - Feachem, et al. (1980). Appropriate Technology for Water Supply and Sanitation. The World Bank, Director of Information and Public Affairs, Washington D.C. 20433 (see listing #9).
- 5 - Jervis, N. "Waste Not, Want Not". *Natural History*. May, 1990 (p.73).
- 6 - Sopper, W.E. and Kardos, L.T. (Eds.). (1973). Recycling Treated Municipal Wastewater and Sludge Through Forest and Cropland. The Pennsylvania State University, University Park, PA (pp. 248-51).
- 7 - Ibid. (pp. 251-252).
- 8 - Cheng, Thomas C. (1973). General Parasitology. Academic Press, Inc., 111 Fifth Avenue, New York, NY 10003 (p. 645).
- 9 - Feachem, et. al. (1980). Appropriate Technology for Water Supply and Sanitation: Health Aspects of Excreta and Sullage Management. Energy, Water and Telecommunications Department of the World Bank, 1818 H Street N.W., Washington D.C. 20433.
- 10 - Ibid.
- 11 - Olson, O. W. (1974). Animal Parasites - Their Life Cycles and Ecology. University Park Press, Baltimore, MD (p. 451-452).
- 12 - Crook, James (1985). "Water Reuse in California". *Journal of the American Waterworks Association*. v77, no. 7. as seen in The Water Encyclopedia by van der Leeden et. al. (1990), Lewis Publishers, Chelsea, Mich. 48118.
- 13 - Boyd, R. F. and Hoerl, B. G. (1977). Basic Medical Microbiology. Little, Brown and Co., Boston Mass. (p. 494).
- 14 - Cheng, Thomas C. (1973) General Parasitology. Academic Press Inc., 111 Fifth Ave., New York, NY 10003. (p. 645).
- 15 - Franceys, R., et. al. (1992). A Guide to the Development of On-Site Sanitation. World Health Organization, Geneva (pit latrine info p. 212, quote on time/temperature factor, p. 214).
- 16 - Schoenfeld, M., and Bennett, M. (1992). Water Quality Analysis of Wolf Creek. (Unpublished manuscript). Slippery Rock University, Applied Ecology Course, PREE, Fall Semester. (Prof. P. Johnson), Slippery Rock, PA 16057
- 17 - Pomeranz, V.E. and Schultz, D., (1972). The Mother's and Father's Medical Encyclopedia. The New American Library, Inc., 1633 Broadway, New York, NY 10019. (p.627).
- 18- Chandler, A.C. and Read, C.P. (1961). Introduction to Parasitology. John Wiley and Sons, Inc.: New York.
- 19 - Brown, H.W. and Neva, F.A. (1983). Basic Clinical Parasitology. Appleton-Century-Crofts/Norwalk, Connecticut 06855. (pp.128-31).
- 20 - Ibid. (pp.119-126).
- 21 - Ibid. (page numbers uncertain).
- 22 - Ibid. (page numbers uncertain)

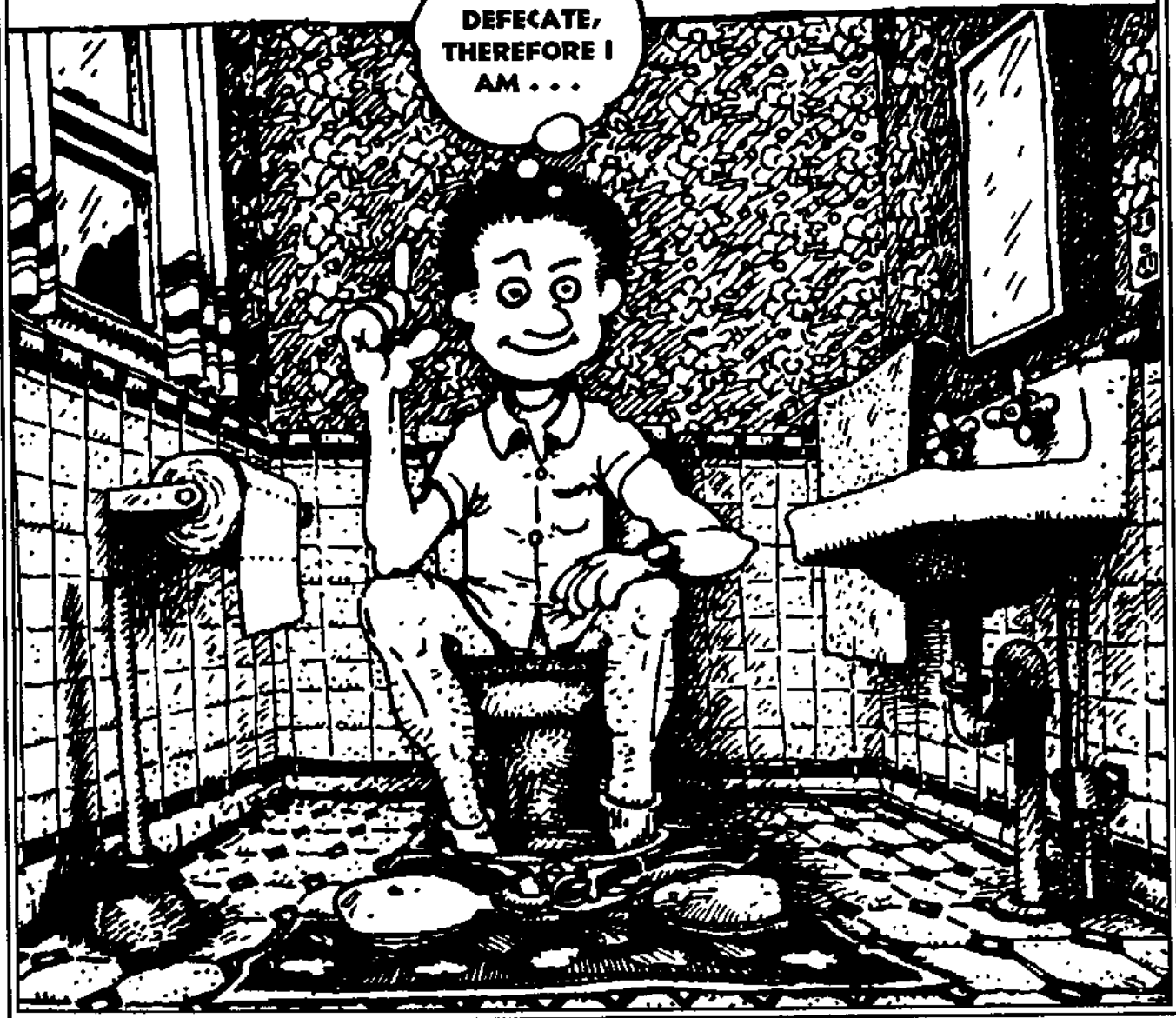
23 - Lewis, Ricki. (1992). *FDA Consumer*, September 1992 (p. 41).

24 - Crook, James. (1985). "Water Reuse in California". *Journal of the American Waterworks Association*, v.77, no.7. as seen in The Water Encyclopedia by van der Leeden et. al. (1990), Lewis Publishers, Chelsea, Michigan 48118.

**\* A wide range of compost analyses and tests for pathogens and other contaminants such as pesticides and herbicides are available from Woods End Research Laboratory, Inc., Route 2, Old Rome Road, Box 1850, Mt. Vernon, ME 04352; Phone (207) 293-2457. In 1995, a helminth ova test cost \$145.00, and required a one gallon sample of compost.**

**WE DO IT EVERY DAY. BUT DO WE EVER  
THINK ABOUT IT!**

I  
DEFECATE,  
THEREFORE I  
AM . . .





## THE TAO OF COMPOST

*"Always bear this in mind, that very little indeed is necessary for living a happy life."*

Marcus Aurelius

*"Aspire to simple living? That means, aspire to fulfill the highest human destiny."*

Charles Wagner



I will never forget the day I introduced my mother to my composting system. She came to visit me at my newly established homestead one spring day in 1980 and I gave her a tour of my garden, which was already quite vibrant. A fresh pile of finished compost had been dumped from a wheelbarrow onto one of the raised garden beds and, as we passed, I reached down and scooped up a big handful, thrusting it toward her. "Smell this," I said. So she put her nose right up to the black earth I held out before me and took a deep breath.

"Boy, that smells good!" she said, inhaling the rich, sweet-smelling aroma of fertile soil, and smiling.

"This is my alternative to a septic system!" I proudly informed her, still holding the compost out in front of me as I watched her smile suddenly freeze. I will always remember the look on her face when I caught her so completely by surprise in an unexpected, and perhaps awkward, situation. My dear mother, although very open-minded, had not, prior to that moment, had the experience of so intimately communing with composted humanure. But the compost did smell good, like a rich soil from the woods.

### **PRIMAL COMPOST**

Try to imagine yourself in an extremely primitive setting, maybe sometime around 10,000 B.C. Imagine that you're just slightly more enlightened than your brutish companions and it dawns on you one day that your feces should be disposed of properly. Everyone else is defecating in the back of the cave, creating a smelly mess, and you don't like it. You're going to improve on the system.

Your first revelation is that *smelly refuse should be deposited in one place*, not spread around for everyone to smell or to step in, and it should be deposited away from one's living area somehow. You watch the wild cats and see that they each go to a special spot to defecate. But the cats are still one step ahead of the humans, as you soon find out, because they cover their excrement.

When you've shat outside the cave on the ground in the same place several times you see that you've still created a foul smelling, fly-infested mess. Your second revelation is that *the refuse you're depositing on the ground should be covered after each deposit*. So you scrape up some leaves every time you defecate and throw them over the feces. Or you pull some tall grass out of the ground and use it for cover.

Soon your companions are also defecating in the same spot and covering their fecal material as well. They were encouraged to follow your example when they noticed that you had conveniently located the defecation spot between two large rocks, and positioned logs across the rocks to provide a convenient perch, allowing for care-free defecation above the collecting refuse underneath.

A pile of dead leaves is now being kept beside the toilet area in order to make the job of covering it more convenient. As a result, the offensive odor of human feces and urine no longer foul the air. Instead, it's food scraps that attract flies and smell bad. This is when you have your third revelation: *food scraps should be deposited on the same spot and covered as well*. Every stinky bit of refuse you create is now going to the same spot and is being covered with a natural material to eliminate odor. This hasn't been hard to figure out, it makes good sense and it's easy to do.

You've succeeded in solving three problems at once: no more humanure scattered around your living area, no more garbage, and no more offensive odors assaulting your keen sense of smell and generally ruining your day. You also begin to realize that the illnesses that were prone to spread through the group have subsided, a fact that you don't understand, but you suspect may be due to the group's new found hygienic practices.

Quite by accident, you've succeeded in doing one very revolutionary thing: *you've created a compost pile*. You begin to wonder what's going on when the pile gets so hot it's letting off steam. What you don't know is that you've done exactly what nature intended you to do by piling all your organic refuse together, layered with natural, biodegradable cover materials. In fact, nature has "seeded" your excrement with a breed of microscopic animal that proliferates in and digests the pile you've created, and, in the process, heats the compost to such an extent that any disease-causing pathogens resident in the humanure are destroyed. The invisible microscopic animals, otherwise known as thermophilic bacteria, would not multiply rapidly in the discarded refuse unless you created the pile, and thereby the conditions,

which favor their rapid proliferation. By daring to be different, you stumbled upon a miracle of nature.

Finally, you have one more revelation, a big one. You see that the pile, after it gets old, sprouts all kind of vibrant plant growth. You put two and two together and realize that *the stinking refuse you carefully disposed of has been transformed into rich earth, and ultimately into food*. Thanks to you, humankind has just climbed another step up the ladder of evolution.

Yet there is one basic problem with this scenario: *it didn't take place 12,000 years ago. It's taking place now.*

## ***THE EVOLUTION OF COMPOST***

The hypothetical discovery of compost in a primal situation would be most likely to occur in a group of humans who had settled into an agricultural lifestyle rather than a nomadic, hunter-gatherer one. Nomadic people can walk away from the trash they leave behind, allowing nature to deal with it. Settled peoples don't have that luxury. The development of rooted human settlements and the development of agriculture go hand in hand, for it is the working of the land to grow food crops that forces a people to stay put year after year. Unless, of course, they deplete the soil of nutrients and are then forced to move on to find a new patch of fertile ground.

More enlightened peoples will develop an understanding of the human nutrient cycle instinctively, and will strive to maintain that cycle intact on a day-to-day basis as if it were a natural and necessary part of their lives, as natural and necessary as growing or cooking their food, or bathing, or nursing their children. For settled, agricultural peoples, there is an abundance of organic refuse materials needing to be recycled on a regular or daily basis, these materials may include potato peels, apple cores, crop residues, humanure, garden refuse and on and on. In most cases, those organic materials would be recycled without question, day in and day out, year in and year out, not as a chore or a burden, but as a necessary responsibility for human life on the planet Earth. Such is the Tao of compost, the balanced way, the natural way, not the glamorous way, not the exciting way, not the get-rich-quick way of contemporary pop culture. The Tao is the endless way.

Although such recycling has apparently been a common practice in the East for thousands of years, it is a relatively unknown phenomenon in the West. In fact, compost itself is a relatively new phenomenon in the West and perhaps even in the East, a phenomenon that never gained recognition throughout the ages in Europe, despite its potentially valuable utility. Perhaps people in Europe who developed an instinctive understanding of natural phenomenon were simply rounded up and burned

at the stake by religious fanatics. One can only speculate as to why the West has been so slow to catch on to humanure recycling, and in view of the religious extremism of the past ages in Europe, such speculation can be both gruesome and saddening.

Much of compost's current popularity in the West can be attributed to the work of Sir Albert Howard, who wrote An Agricultural Testament (1943) and several other works on aspects of what has become known as *organic* agriculture. Sir Howard's discussions of composting techniques focus on the Indore process of composting, a process developed in Indore, India between the years of 1924 and 1931. The Indore process was first described in detail in Sir Howard's work (co-authored with Y. D. Wad), The Waste Products of Agriculture, in 1931.

The two main principles underlying the Indore composting process include 1) mixing animal and vegetable refuse with a neutralizing base, such as agricultural lime, and 2) managing the compost pile by physically turning it. These Indore process composting techniques subsequently became adopted and espoused by composting enthusiasts in the West, and today one still commonly sees people turning and liming compost piles. For example, Robert Rodale wrote in the February, 1972 issue of *Organic Gardening* concerning composting humanure, "*We recommend turning the pile at least three times in the first few months, and then once every three months thereafter for a year.*"

However, as composting becomes more deeply looked into over the years by us Westerners, new information is bound to be brought forth that challenges the conventional wisdom. For years I also believed that compost should be turned, and perhaps limed or treated with rock dusts. Yet, after monitoring my own compost, I've come to understand differently. Now, due to my own experiences, I contend that compost piles need not be limed, and need not be turned at all. Turning is unnecessary unless one is perhaps trying to accelerate the composting process, trying to compost piles of refuse that are exceedingly large, or trying to stir the outer areas of a batch of compost into the center in order to subject all parts of the batch to the high inner temperatures. I discussed the liming issue in chapter 2 of this book, and I'll discuss the turning (aerating and mixing) issue later in this chapter. I realize now that compost-making is really simpler than I could have imagined, and the arduous task of turning a compost pile may actually do more harm than good *if the pile is being continuously added to*. This is by no means an attempt by me to disparage the work of anyone, including Robert Rodale or Sir Albert Howard, who both very justifiably remain held in high regard by proponents of organic gardening and farming.

The Tao of compost, however, requires that *compost-making be an integral part of normal and daily life*. Such compost-making is a natural and *bio-regional* phenomenon. Organic refuse from a given population and geographic area is layered

together for the purpose of cultivating the microscopic organisms that convert the refuse into humus. As there are thousands of geographic areas on the earth each with its own unique human population, climatic conditions and available organic refuse materials, there will also be potentially thousands of composting methods and styles. What works in one place on the planet for one group of people may not work at all for another group in another geographic location. Where one group uses above-ground, continuous compost bins such as described in this book, another group will use below-ground pits sealed with clay. Where one group chooses to compost aerobically, as described in this book, another may choose to compost anaerobically such as in a sealed pit. Where a group only uses natural, organic materials in their compost, another may add chemical fertilizers or rock dusts. Where one group may compost each family's refuse separately, another group may compost the refuse of many people all together.

It is not my intention to unfairly promote certain methods of composting as superior over others. My intention is to describe my own experiences in the hope that others may benefit from such descriptions. I would hope that others with different experiences would also make their information available for the benefit of the general public. If I must insist upon anything, I would insist that the compost-maker be clear in understanding why s/he is making compost. If compost is being made in order to eliminate waste and pollution as well as recover resources, as it should be, then the compost-maker will strive to utilize local refuse resources in a wise and efficient manner. The availability of local, organic refuse materials in combination with local climatic conditions, and cultural predispositions toward the recycling of humanure, will determine the methods of composting for a given location, or bioregion.

When composting humanure, the additional factor of pathogen destruction must be taken into account and incorporated into the composting formula. The destruction of human pathogens occurs most readily under the conditions of aerobic, thermophilic composting, because of the heat generated by the process. This is the sort of composting in which I engage and which this book primarily entails. In short, humanure composting requires 1) a knowledge of accessible local refuse materials suitable for composting, 2) a sensitivity to and understanding of seasonal fluctuations in weather conditions, and 3) a willingness to combine the refuse materials in a manner that suits the climate and still promotes the growth of aerobic, thermophilic bacteria.

I would add to this formula one more thing: the technique one finally settles on for composting humanure should be sustainable. It should not be creating waste or pollution or squandering resources.

Bearing all this in mind, perhaps Sir Albert Howard's Indore process of com-

posting was the most appropriate for his purposes, in Indore, India in the 1920's. But that's no reason for anyone else to believe that the compost they are producing in their area of the world for their own purposes should utilize the same techniques that the Indore process calls for. This is especially important to understand when one realizes that if all compost required both liming and turning, many people would be unable to make compost. Agricultural lime is not available to everyone, everywhere, and turning compost can be quite an arduous task, especially for the frail or elderly. Whereas, *all people, everywhere, should be able to make compost.*

Additionally, people who recommend the frequent turning of humanure compost are people who have never engaged in humanure composting as a way of life. We simple humans of meager material resources who insist on recycling our daily refuse are aware of this one important fact: we produce organic refuse *continuously*, and therefore we must engage in *continuous composting*, which involves the continuous addition of organic refuse to a compost pile. Such a continuous compost pile requires the slow and constant upward movement of thermophilic organisms in the pile, which digest incoming refuse deposited on the pile above them, and abandon digested refuse below them. Such a pile of compost is always growing on top and always shrinking on the bottom, and does not need to be turned for aeration. In fact, such turning could be extremely disruptive.

This is in contrast to *experimental* composting, whereby large amounts of refuse are suddenly made available for the purpose of experimentation. Such experiments have a purpose and value all their own, but they may not reflect real situations in real life in the real world. When a person is suddenly faced with a large mass of raw organic material to be composted, perhaps turning the pile is a useful management technique. Certainly if the refuse is piled out in the open, the outer surfaces of the pile may remain unacceptably cool and will need to be turned into the center periodically. This can possibly be remedied by keeping the refuse in bins that hold in the heat, and covering the piles with insulating organic materials such as straw.

In other words, there is a big difference between the Tao of compost, which is composting *as a way of life*, and composting done for agricultural or academic experimentation. And although from an evolutionary standpoint we are slowly advancing our understanding of compost in the West, we are still back in the cave when it comes to incorporating composting into our daily lives.

In any case, I contend that not much has changed since ten thousand B.C. in the eyes of the compost pile. The thermophilic microorganisms that convert humanure into humus don't care what techniques we use today anymore than they cared what techniques were used eons ago, *so long as their needs are met.* And those needs haven't changed in human memory, nor are likely to change as long as humans roam

the earth. Those needs include: 1) *temperature* (compost microorganisms won't work if frozen); 2) *moisture* (they won't work if too dry or too wet); 3) *oxygen* (they won't work without it; and 4) *a balanced diet* (otherwise known as balanced carbon/nitrogen). In this sense, compost microorganisms are a lot like people, and, with a little imagination, we can think of compost microorganisms as a working army of microscopic people who need the right food, water, air and warmth.

The art of compost-making then, remains the simple and yet profound art of providing for the needs of these invisible workers so that they work as vigorously as possible, season after season. And although those needs may be the same worldwide, the techniques used to arrive at them may differ from time to time and from place to place.

### **THERMOPHILIC MICROORGANISMS**

Converting humanure back into soil requires microorganisms that produce and thrive at high temperatures - high enough to kill the human pathogens that may be found in the excrement. The beneficial microorganisms are primarily thermophilic (heat-loving) microscopic bacteria, and they're extremely valuable to humanity. They ask for very little and they give a lot in return, and, for the most part, we ignore them. However, people interested in composting humanure need to know something about the little buggers and how to keep them happily working.

Bacteria are usually divided into three classes based upon the temperatures in which they grow best. The low temperature bacteria are the *psychrophiles*, which can grow at temperatures down to  $-10^{\circ}\text{C}$ , but whose optimum temperature is above  $20^{\circ}\text{C}$  ( $68^{\circ}\text{F}$ ). The *mesophiles* live at medium temperatures,  $20^{\circ}\text{C}$  -  $37^{\circ}\text{C}$  ( $68^{\circ}\text{F}$ - $98.6^{\circ}\text{F}$ ).

#### **ESSENTIAL READING FOR INSOMNIACS**



*A number of thermophilic microorganisms may be found in the composting process including bacteria: *Bacillus stearothermophilus*, and *Clostridium thermocellum*; fungi: *Geotrichum candidum*, *Aspergillus fumigatus*, *Mucor pusillus*, *Chaetomium thermophile*, *Thermoascus auranticus*, *Torula thermophila*, and *Humicola insolens*; and actinomycetes (a cross between a bacterium and an imperfect fungus): *Thermoactinomyces*, *Actinomyces thermophilis*, *Talaromyces (Penicillium) duponfi*, and *Thermomonospora*.<sup>3</sup>*

*Thermophiles* thrive above 40°C (104°F), and the optimum temperature for some thermophilic strains may be as high as 65°C (149°F) or higher. These bacteria occur naturally in hot springs, tropical soils and compost heaps, to name a few places. Some thermophilic bacteria have been found at temperatures as high as 89°C (192°F), and perhaps higher.

Thermophiles are responsible for the spontaneous heating of hay stacks which can cause them to burst into flame. When growing on bread, they can raise the temperature of the bread to 74°C (165°F). Heat from bacteria also warms germinating seeds, as sterile seeds are found to remain cool while germinating.<sup>1</sup>

Thermophilic bacteria were first isolated in 1879 by Miquel, who found bacteria capable of developing at 72°C (162°F). He found these bacteria in soil, dust, *excrement*, sewage and river mud. It wasn't long afterward that a variety of thermophilic bacteria were discovered in soil - bacteria that readily thrived at high temperatures, but not at room temperature. These bacteria are said to be found in the sands of the Sahara Desert, but not in the soil of cool forests. Composted or manured garden soils may contain 1-10 percent thermophilic types of bacteria, while field soils may have only 0.25% or less. Uncultivated soils may be entirely free of thermophilic bacteria.<sup>2</sup>

The presence of thermophilic bacteria in garden soil to which compost has been added indicates that the use of garden weeds in one's compost pile, including soil clinging to roots, may help keep the pile inoculated with the necessary bacterial strains. However, it seems more likely that the bulk of the thermophilic bacteria enter the compost pile from the humanure itself. In which case, it would seem that mother nature has provided for the human race a built-in solution to the problem of getting rid of human excrement. The thermophilic bacteria are already in it; we just have to provide the conditions they need to do their thing, which is heating and digesting the manure sufficiently to render it hygienically safe. Nature provides us with seeds to grow our food too, but those seeds won't grow unless we create the right conditions for them. We've already figured *that* out.

Humanure is said to contain 100 *billion* bacteria per gram (there are 28.34 grams in an ounce).<sup>4</sup> This means that *one gram of humanure contains a bacterial population twenty times greater than the entire human population of the earth*, which seems unbelievable. If the average excrement weighs about 40 ounces, then each stool could contain 113 *trillion* bacteria, a figure totally beyond human comprehension.

When a pile of organic refuse begins to undergo the composting process, the mesophilic bacteria proliferate, raising the temperature of the composting mass up to 44°C (111°F). These mesophilic bacteria can include *E. Coli* and other bacteria from



the human intestinal tract, but these soon become increasingly inhibited by the temperature as the thermophilic bacteria take over in the transition range of 44°C-52°C (111°F-125.6°F). Thermophilic growth can then continue up to about 70°C (158°F).<sup>5</sup> These bacteria combine organic carbon with oxygen to produce carbon dioxide as well as to release energy. Some of the energy is used by the microorganisms to proliferate, the rest is given off as heat.

The heat produced by thermophilic bacteria kills the pathogenic microorganisms, viruses, bacteria, protozoa, worms and eggs that may inhabit humanure. A temperature of 122° F (approx. 50°C), if maintained for twenty-four hours, is sufficient to kill all of the pathogens. A lower temperature will take longer to kill pathogens (a temperature of 115°F may take nearly a week to kill pathogens completely), a higher temperature may only take minutes. For example, when Westerberg and Wiley composted sewage sludge which had been inoculated with polio virus, salmonella, roundworm eggs, and *Candida albicans*, they found that a temperature of 116°F to 130°F (46.66°C to 54.44°C) maintained for three days killed all of these pathogens (see *Applied Microbiology*, December 1969). This sort of phenomenon has been confirmed by many other researchers, not the least of which being Gotaas, who indicates that few organisms are able to survive temperatures of 120°F (48.88°C) for more than one hour. However, for safety's sake, a period of twenty-four hours at 122°F is generally recommended for the assurance of total pathogen destruction. Therefore, the first goal in composting humanure should be to create a compost pile that will heat sufficiently to kill all potential human pathogens that may be found in the manure (see figure 6F and table 6.14 on page 133, and table 6.11 on page 127).

It should be understood though, that *the heating process carried out by thermophilic bacteria occurs only in the initial stage of organic decomposition*. The heating stage takes place rather quickly and may only last a few days, weeks or months. The thorough decomposition of organic material, or the conversion of organic refuse into humus may take a year or two. After the initial thermophilic heating period, the humanure will appear to have been digested, but the coarser organic material will not. The fungi and macroorganisms that break the coarser elements down into humus wait for the heat to die down before they move in. Then they take their good old time, and I say "more power to them!" I only plant a garden once a year, so I only need compost once a year. No need to hurry the process.

## ***FOUR NECESSITIES FOR GOOD COMPOST***

### ***1. Moisture***

In order for the composting process to work properly, several conditions must be met. The first is proper moisture content. A correct moisture content is 50-60%. The pile should be quite moist, but not wet or water logged. How does one determine the moisture content of the compost? How does one regulate the moisture content? First, don't worry. Second, if the pile is getting too much moisture (not likely in an open topped pile with an earth bottom), add more dry materials such as hay, straw, weeds, leaves etc. These things soak up excess moisture.

In extreme cases, a roof over your compost pile may be needed to keep the rain out, or to keep the sun from drying the pile. You may want a roof over your pile so you can collect rain water to use for cleaning composting containers and utensils, then you can use the cleaning water to help keep your pile damp. In any case, the more you work with your compost, the easier you'll find the process to be.

I don't water my compost except to empty cleaning water on it after cleaning the toilet container, and I don't cover it to keep the rain out. Average annual rainfall where I live is about 35 inches per year. There is no apparent leaching from the compost pile into the surrounding environment, and no visible surrounding environmental deterioration whatsoever resulting from my humanure compost bin which has been situated in the same place for fifteen years. I do, however, have my compost bin under tree cover so it has protection from the pouring rain, and I keep the top of the pile flat to minimize water runoff. When monitoring the temperature of my compost pile during a period of drought, I found that the temperature rose dramatically after a heavy rain. This has led me to believe that rain water is good for compost, and provides a source of essential moisture. Compost tends to soak up rain water like a sponge, especially if the pile has a flat top.

On the other hand, much of the moisture in our compost pile comes from human urine. Urine not only provides needed moisture, but it also provides needed nutrients such as nitrogen, and it expedites the decomposition of the sawdust or other organic cover material used in the toilet. If one wants to use a cover material in one's toilet to eliminate odors (and one should), then one needs urine in the toilet to provide the extra moisture and nitrogen to balance the dry carbonaceous cover material so that it'll all compost together thermophilically. If one wants to compost urine as well as feces, then one will have to add a significant amount of relatively dry carbonaceous material to soak up the urine and balance its nitrogen. Cover materials and urine go hand in hand. You shouldn't have one without the other in a composting toi-

let system.

The segregation of urine from feces in composting systems has been promoted far and wide. I strongly disagree with this practice when applied to thermophilic composting systems, as the alternative of using a carbonaceous cover material is much more simple, pleasant and beneficial. People who segregate urine from feces claim that the urine creates foul odors and waterlogs the compost. However, it is a lack of cover material that allows for the creation of foul odors and waterlogging, not the existence of excess urine. Collecting urine (and feces) in a receptacle filled with sawdust or other organic and fairly dry material before depositing it on the compost pile will ensure that adequate carbonaceous material is added to the pile to balance the nitrogenous urine. The covering of such deposits again, *after application to a compost pile*, with additional organic cover materials such as grass or weeds will ensure an odor free system. This will be discussed in greater detail later in this chapter.

## 2. Oxygen

The second necessity for a good compost pile is oxygen. Thermophilic bacteria are aerobic bacteria, they need oxygen. One way to oxygenate your pile is by turning it, chopping it, running pipes through it with little holes in them, moving it on augers, blending, agitating, sweating, digging, etc. The belief that one must turn one's compost pile surely is the leading reason why many people don't have them. Especially little old ladies.

I also believed that turning was an essential step in the aeration of a pile and therefore essential in making good compost, and I turned my pile once a year for over a decade. It wasn't until I conducted the more detailed research for this publication when I discovered that turning the pile was not assisting the process of thermophilic decomposition. In fact, after I turned my pile, the bacterial activity slowed way down instead of speeding up as it was supposed to. The microorganisms continued to work, but not as earnestly, and the temperature of the compost dropped significantly (about 30°F) immediately after the pile was turned, then petered out altogether.

The reason this happened was a revelation to me at the time: The thermophilic bacteria in my compost were happily multiplying in the fresher, upper layers of the pile, which contained the proper conditions for vigorous microbial proliferation, namely fresh food, and that layer was around 120°F or 50°C. The lower, older layers of the pile had already been digested by the thermophilic bacteria and were "spent", or cool. When I turned the pile, I diluted the fresh, hot, upper half of the pile with the

spent lower half and left the thermophilic bacteria without enough food. Or, in other words, I disrupted their carbon/nitrogen balance. They had plenty of oxygen, but that wasn't good enough. So they quickly cooled down. Now I realize that if a compost pile is arriving at temperatures adequate for the destruction of human pathogens, the microorganisms are enjoying the proper conditions and should be left alone. Turning the pile after it has cooled down will reintroduce oxygen, but it won't refresh the food supply, so why bother? Now I don't turn my compost at all, and the process of compost-making has become that much more enjoyable.

It seems that the act of turning and artificially aerating compost piles is advocated for the purpose of accelerating the compost-making process so that it takes less time. There are many examples in the available literature showing compost piles finished and removed for agricultural application in a few weeks. This may be appropriate for the composting of large quantities of municipal refuse or something of that sort, but for individual families who produce compost for gardening purposes, such compost acceleration will provide little advantage. Furthermore, such tales of fast, hot, compost apply to situations where a sufficient quantity of organic refuse becomes immediately available for piling, turning, and composting. The reality for individual families is that compostable refuse is produced daily in small quantities, day after day, year after year, forever. Therefore, a sudden large heap of compost (a batch) cannot be readily created, and an alternative approach must be used. That approach requires the use of a continuous composting system (as mentioned earlier, but worthy of repeating), in which refuse is continuously added to a pile, and the thermophilic layer continually rises in the pile to digest the incoming refuse. This sort of system is not aided by manually turning the pile. Instead, the pile is aerated by providing it with a blend of ingredients which trap air space in the pile. For those of you who aren't in a hurry, turning or aerating compost manually will not be necessary. I produce compost to use in my food garden, which I plant annually. Therefore, I only need finished compost on an annual basis. An annual cycle works well in a temperate climate such as the one I live in, although shorter cycles may be useful in tropical climates with year-round growing seasons.

In many cases, batch composting piles (not continuous composting piles) are turned in order to insure that all parts of the pile are subjected to the high internal temperatures, thereby ensuring total pathogen destruction. However, small-scale composting by individual families, if done in wooden bins where the compost is kept covered by an insulating layer of organic refuse (such as straw), may be sufficient to retain the necessary temperatures throughout the pile, without turning.

Another reason why compost piles are manually turned or aerated is because they are just too big, and the inside of the pile is smothered. This can be remedied by

not making big compost piles. A workable bin size is 5'w x 5'd x 4'h (1.5m x 1.5m x 1.2m), or smaller. There are easy ways to oxygenate a pile this size sufficiently to allow for proper thermophilic decomposition to occur. The easiest way to get oxygen into your pile is by using coarse cover materials such as hay, straw, grasses, or weeds (a main crop in my garden) to cover over odorous compost deposits. These coarse materials trap air spaces in the pile, as well as trap odors. A pile constructed with layered materials including coarse cover materials would have to be under water to be starved of oxygen.

Finally, there is an abundance of evidence that the more compost piles are turned, the greater they suffer from a loss of nutrients, particularly nitrogen and organic matter. Unturned compost retains the highest nutrient value. It also costs much less to produce, as the need for equipment or labor is kept to a minimum.

### ***3. A Balanced Diet***

A good carbon-nitrogen balance (a good blend of materials) is required for a nice, hot compost pile (see page 38 to refresh your memory on the topic of carbon and nitrogen). Since most of the materials commonly added to a compost pile are very high in carbon, this means that a source of nitrogen must be incorporated into the blend of composting ingredients. This isn't as difficult as it may seem. You can carry bundles of weeds to your compost pile, add hay, straw, leaves and garbage, but you'll still need one thing: nitrogen. Of course the solution is simple - add manure. Where can you get manure? From an animal. Where can you find an animal? Look in a mirror.

And be sure to keep that kitchen garbage going into the compost. Variety is the spice of life, even for a microscopic critter.

### ***4. Temperature***

Compost ceases to be active when frozen, and may slow down considerably when the ambient air temperature is consistently below freezing. However, frozen compost can resume vigorous activity after thawing, providing that it has adequate moisture, oxygen and a balanced diet (see Figure 7.6 on page 164, and appendix 4 on page 187).

### ***DOING IT***

OK. You should know by now that anyone can compost humanure at little if any cost in money or resources. You know that, if done properly, the manure will be

rendered hygienically safe, no matter what pathogens were in it before composting. The next question is, *“How can I do it, considering our cultural predisposition against the idea, and my own personal circumstances?”* My guess is that if you’re living in downtown Pittsburgh, you won’t be composting humanure in the near future. On the other hand, if done properly, you could probably compost humanure almost anywhere else without causing a problem. Let me fill you in on my own experiences, and on some possibilities for adapting my experiences to different situations. Maybe this will give you some ideas.

In 1974, after graduating from a university, I set out to learn a thing or two. I soon learned that diet and lifestyle are keys to good health. I decided to experiment a little and eventually put money down on land for the purpose of establishing a homestead and growing my own food. My intentions were to proceed in a manner that was gentle on the Earth, so to speak, while maximizing my own self-reliance and independence.

I traded a wood-burning cookstove for a canvas tipi and set the tipi up on my newly acquired wooded land. I soon had an area cleared for a garden. The first obstacle I ran into was a lack of soil fertility. How was the soil to be built up? Obviously, I had to replace what I took from the land when I gardened. It occurred to me that I had to complete the human nutrient cycle by returning my manure to the soil in the form of compost. It was either that or truck in manure from nearby farms year after year, while my own manure collected underground in a septic tank as toxic waste, thereby threatening the quality of my spring water. So I started composting in a serious way.

I varied my techniques and methods of composting until I hit upon what seemed to work best for me, having now composted in the same bin since 1979. The system I use requires no electricity, running water or technology (although a little technology, such as a truck to haul sawdust, or a sawmill to create it, is useful). And it’s not very labor intensive. Most of the work involves regularly emptying organic materials into the compost bin (my sawdust toilet is usually used by four people and is usually emptied every three or four days), and occasionally (annually) removing finished compost from the bin. What’s important is that the system works well.

During the development of my composting experiences, I knew at least a dozen families who lived in my surrounding area and were also composting humanure. Today, half of them have converted to flush toilets and conventional septic systems. This is an indication of the obvious: that composting is not for everyone, even the well-intentioned. However, none of the families I knew had done their homework and understood the importance of thermophilic composting or its ability to destroy the pathogens in humanure. Perhaps they weren’t sure they were doing the right

thing, and in fact many of them were mouldering their compost rather than thermophilically composting it. One family who composts humanure by a mouldering process uses it to fertilize trees in a field, having banned it from their garden, which, of course, is better than shitting in drinking water. Ironically though, it is a simple matter to convert a mouldering system into a thermophilic one, thereby rendering the compost fit for food production.

I now have a house built primarily of bioregional and recycled materials. The tipi ended up at a local state-owned environmental center where it was used to teach kids environmental ethics until a wind storm blew it to shreds. I lived “off the grid”, without mainstream electricity, for the first ten years, eventually incorporating photovoltaics (solar electricity) into my home, then mainstream electricity, conservatively consumed. I added the mainstream electricity when I realized I would never want to pay for a photovoltaic system big enough to even light my house, not only because of the prohibitively high cost, but also because of the toxic lead-acid batteries I would have had to buy and eventually discard in order to store the solar power. Besides, the kerosene lamps we had to use were causing indoor air pollution and creating a fire hazard. I also married a woman who owned a freezer, which not only required electricity, but which proved itself to be very useful in preserving food for the winter. The woman’s pretty nice too.

In short, ideals carved in stone are eventually molded by the constant rain of reality, which transforms them into a practical wisdom.

On the other hand, my composting system has changed little. I’ve upgraded it by moving the original “outhouse” indoors, where it works much better and does not

### A Tip From Mr. Turdley



**Sawdust works best in compost when it comes from logs, not kiln-dried lumber.** Although kiln-dried sawdust (from a wood-working shop or retail lumber yard) will compost, it is a dehydrated material and will not decompose as quickly as sawdust from “green” logs, which is a byproduct of sawmills. Kiln-dried sawdust may also contain sawdust from pressure treated lumber, a dangerous addition to any compost pile. Sawdust from logs makes a better cover material in a sawdust toilet, as it prevents the escape of odor more effectively than the lighter, airier, kiln-dried material. Sawdust from logs is an inexpensive and plentiful local resource in forested areas, and can be found at local sawmills, usually free for the hauling. Sawdust should be stored outside where it will remain damp and continue to decompose, although during the winter special provisions must be made to ensure a supply of unfrozen sawdust. Some people will tell you that sawdust will make your soil or your compost acidic. That’s not true. A comprehensive study of sawdust done between 1949 and 1954 by the Connecticut Experiment Station showed no instance of it making the soil more acidic.<sup>6</sup> This is verified by the author’s experience.

create an odor problem at all. In fact, the most common remark visitors offer concerning the toilet is "*Gee, why doesn't it smell?*" The system itself is still the same model of simplicity that I've been employing all along, if not more so. People ask me when I'm going to get a septic system. They take one look at the compost toilet and say things like "*I respect the way you're living, but I could never do it.*" Well, I could install a septic system, as I have the running water and the electricity. However, in doing so I'd likely create environmental pollution and threaten the quality of my ground water, which I drink. That's what septic systems do. They're *waste disposal* systems. They collect and store waste, allowing the waste to slowly seep into the



**A SIMPLE, COMPACT, INDOOR SAWDUST TOILET IN A NEWLY CONSTRUCTED HOME.**

environment. I'd rather engage in resource recovery instead of waste disposal. My compost is my reward, and that's too valuable for me to be willing to sacrifice. It helps me to grow my food.

Finally, I don't understand humans. We line up and make a lot of noise about big environmental problems like incinerators, dumps, acid rain, and pollution. But we don't understand that when we add up all the tiny environmental problems each of us creates, we end up with those big environmental dilemmas. Humans are content to blame someone else, like government or corporations, for the messes we create, and yet we continue doing the same things ourselves day in and day out that have created the problems. Sure, corporations create pollution. If they do, don't buy their products. If you have to buy their products (gasoline for example), keep it to a minimum. Sure, municipal waste incinerators pollute the air. Stop throwing trash away. Minimize your production of waste. Recycle.



Buy food in bulk and avoid packaging waste. Simplify. Take a few months off work each year and don't spend money. Turn off your TV. Grow your own food. Plant a garden. Be part of the solution, not part of the problem. If you don't, who will?

## ***THE SAWDUST TOILET***

By now the reader should realize that the thermophilic composting of humanure will render it hygienically safe for garden use. However, thermophilic composting requires managing a compost pile by ensuring that the composting microorganisms have their basic needs of oxygen, food and moisture met. That management process simply entails heaping a mix of organic refuse in a constructed bin on bare soil, using some coarse (but not woody) material in the heap, and making sure the pile doesn't dry out. An additional important management practice involves occasionally raking the exposed outer edges of the compost pile onto the top of the pile to ensure that no material is escaping the thermophilic process.

In any case, when composting humanure one may ask, "*How does one get the humanure to the compost pile?*" There are two basic answers to that question. First, the compost pile may be situated under the toilet. I have never used such a toilet and therefore cannot discuss such a system with any authority. I don't see why this sort of collection system would not work as long as the compost pile is readily accessible and closely managed to ensure thermophilic decomposition and to prevent odor and waterlogging. Secondly, the humanure may be collected in one location, then moved to the compost pile in another location on a regular basis. This is the sort of system I am most familiar with, therefore, it is the system on which I focus my discussion.

### **Another TIP FROM MR. TURDLEY**



### ***THE SECRET***

**to composting humanure is  
to keep it covered.**

Always cover toilet deposits thoroughly with a clean, organic cover material such as rotting sawdust. When depositing humanure onto a compost pile always cover the deposit with another cover material, preferably a coarse one such as straw or weeds. Proper cover materials eliminate odors and flies, and balance the nitrogen in the humanure.

Figure 7.1

## The Tao of the Sawdust Toilet

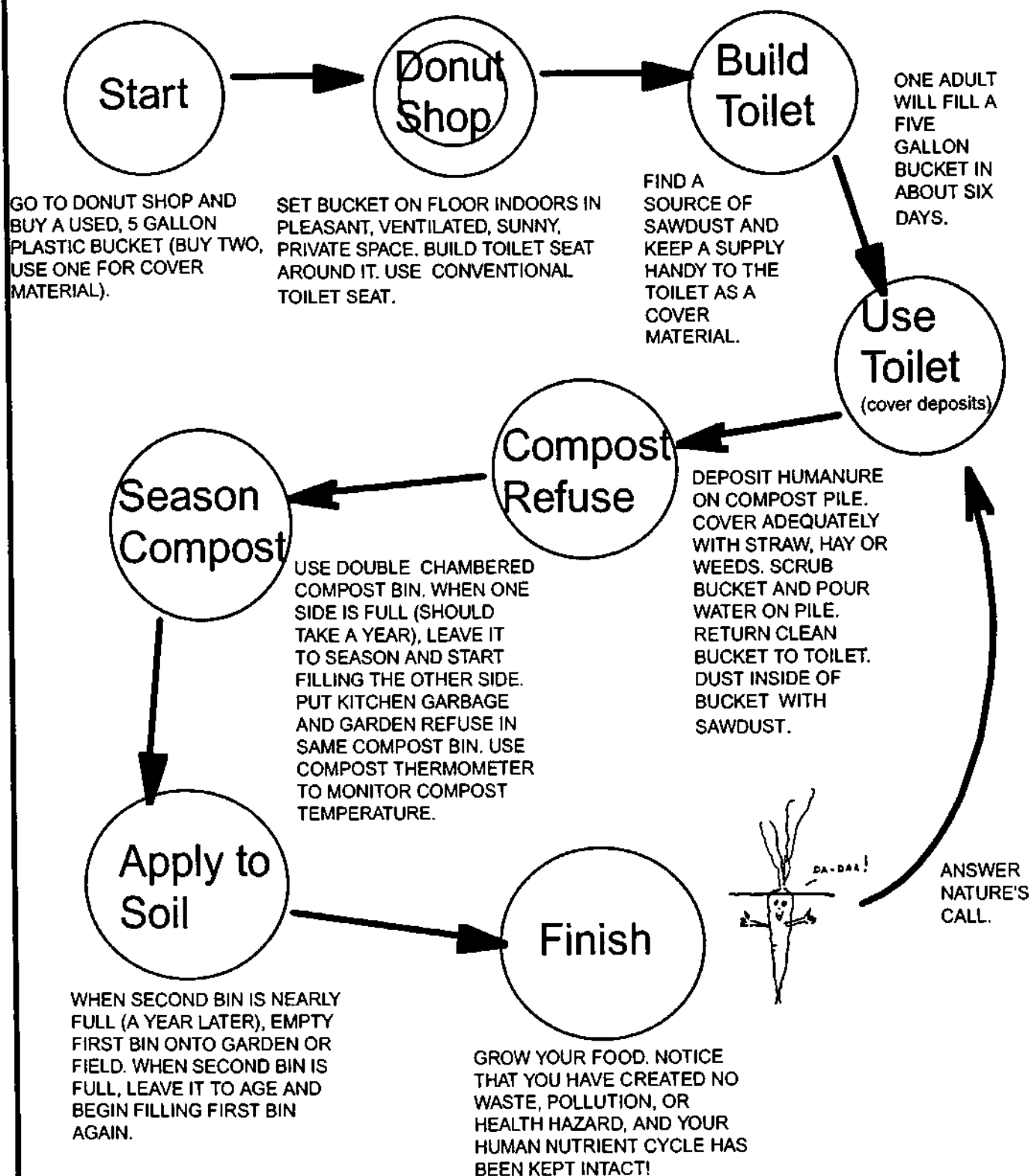
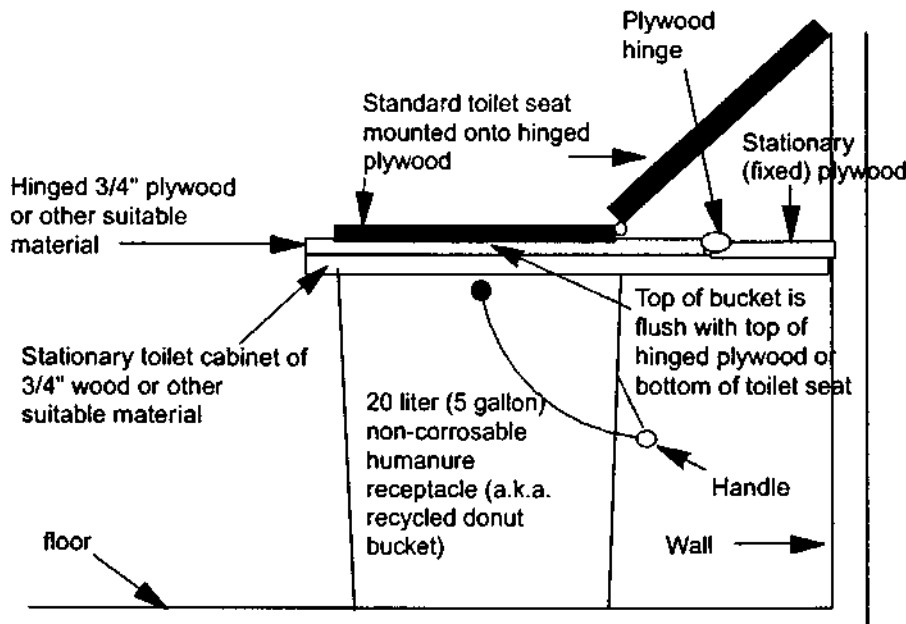


Figure 7.2

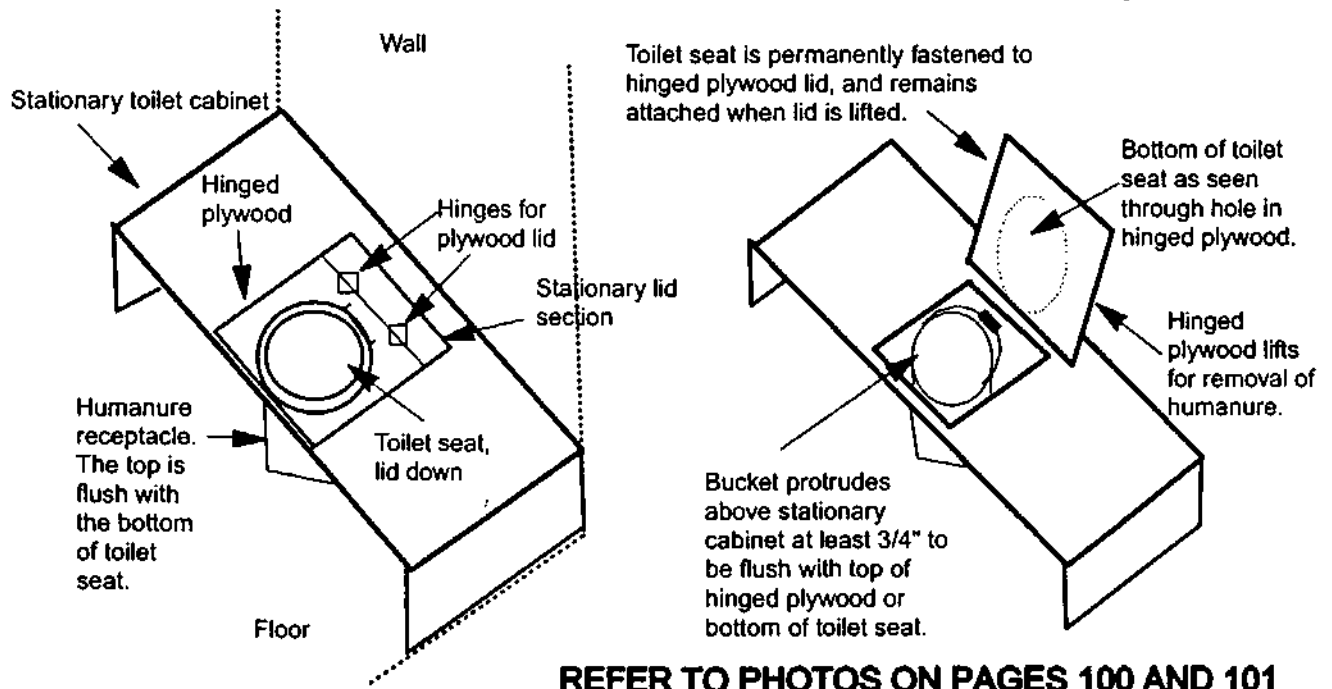
# CUTAWAY VIEW OF SAWDUST TOILET HUMANURE RECEPTACLE



## SAWDUST TOILET VITAL STATISTICS

100 pounds of human body weight will fill approx. 3 gallons (.4 cubic feet, or 693 cubic inches or approx. 11 liters) in a sawdust toilet *per week* - this volume includes the sawdust cover material. 100 pounds of human body weight will also require approximately 3 gallons of semi-dry, deciduous, rotting sawdust per week for use as a cover material in a toilet. This amounts to a requirement of approximately 20 cubic feet of sawdust cover material per 100 pounds of body weight per year for the proper functioning of a sawdust toilet. Human excrement tends to add weight rather than volume to a sawdust toilet as it is primarily liquid and fills the air spaces in the sawdust. Therefore, for every gallon of sawdust-covered excrement collected in a sawdust toilet, nearly a gallon of cover material will have been used.

## Diagram of Simple Humanure Sawdust Toilet Arrangement



REFER TO PHOTOS ON PAGES 100 AND 101

A simple collection system whereby humanure is collected regularly, then moved to a compost pile has its advantages and disadvantages. The advantages include:

1) A very low cost is required to initiate such a system. The lower the cost of a system, the more universally available it is to humans on planet earth. A collection receptacle that is non-corrosable with a 20 liter or five gallon capacity is ideal. A larger capacity receptacle would be too heavy when full. Plastic, five-gallon food grade buckets with handles are available in the United States for a very small cost as discarded from donut shops and other food establishments. Such a receptacle will withstand many years of constant use with little or no degradation.

2) The toilet can (and should) be comfortably indoors, with no odor. In order to prevent odors, a cover material *must* be used in the collection receptacle. Sawdust from logs is ideally suited for this purpose, although other organic materials would also work. Not only does the cover material trap odor in the collection receptacle, but it also completely eliminates any fly or insect problems. If sawdust from logs is not available, the compost-maker will have to find an alternative that is available in his or her locality. The cover material should be natural, organic, clean and not wet, although it may be damp, and a slight dampness may actually be preferred for odor prevention purposes. Some people use peat moss. Other possibilities would include leaves (preferably dead or dried), ground corncobs or stalks, plain dirt, grain chaff,

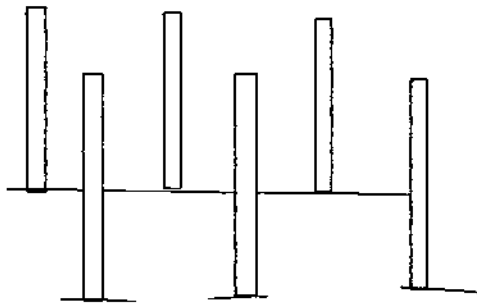
### Yet Another Tip from Mr. Turdley



**PRESSURE TREATED LUMBER SHOULD NEVER BE USED FOR CONSTRUCTING COMPOST BINS**, or for anything else. Pressure treated lumber is saturated with chromated copper arsenate. Both arsenic and chromium have been classified as human carcinogens (causing cancer) and are suspected mutagens (causing mutations). The poisons in pressure treated lumber will leach into your soil and into your compost, and may enter your food chain. You can't even safely burn pressure treated lumber to get rid of it - it produces highly toxic fumes and ash! When using sawdust in compost, don't use sawdust from a lumber yard as it may be made from pressure treated lumber! [See *Organic Gardening*, July/August, 1992. p. 8-10]

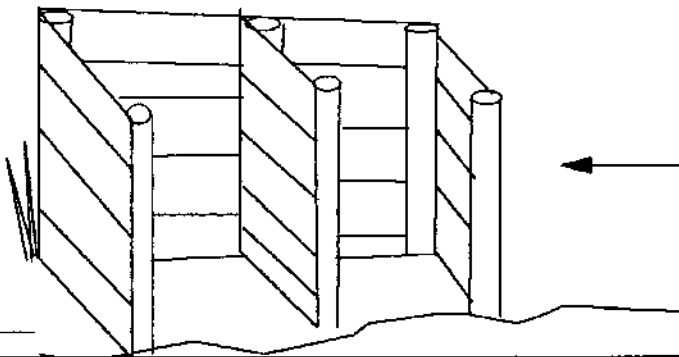
Figure 7.3

## CONSTRUCTING A SIMPLE COMPOST BIN



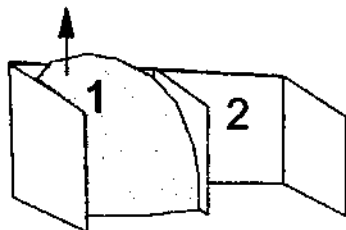
Set six posts into the ground. Use cedar, locust, redwood, or other wood resistant to rot. Do not use pressure treated lumber! Posts should be about five feet (1.5m) apart, about 40" (1m) out of the ground, and buried about two feet (.6m) deep.

(See photo, page 97.)

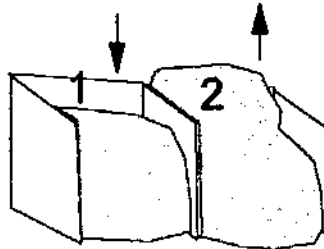


Close posts in so that two chambers are constructed, each about five feet square and 40" high. Recycled lumber without paint is ideal for this purpose. **Do not use pressure treated lumber.**

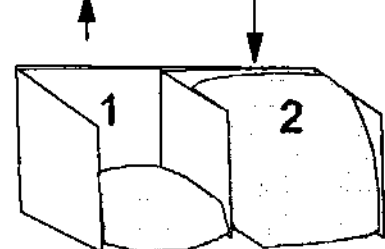
NOTE: A bin for only one or two people may need to have smaller chambers.



Fill one side to full (about a year), let it sit and age while the other side is filled. When filling the bin, layer the compost with weeds, hay, straw or similar coarse material.



Fill second side. Notice that first side has shrunk considerably. When second side is nearly full, empty first side onto garden or field.



Begin filling first side again, as second side shrinks and ages. When side one is full, empty side two and start over.

### THE CEASELESS CYCLE OF COMPOST MAKING

(Refer to page 159 for additional illustrations.)

possibly ground newsprint, perhaps even green leaves, etc. The cover material is an absolutely essential part of a thermophilic compost toilet - it not only eliminates odors and insects, but it also balances the nitrogen of the humanure by providing carbon, thereby setting the stage for the desired thermophilic decomposition.

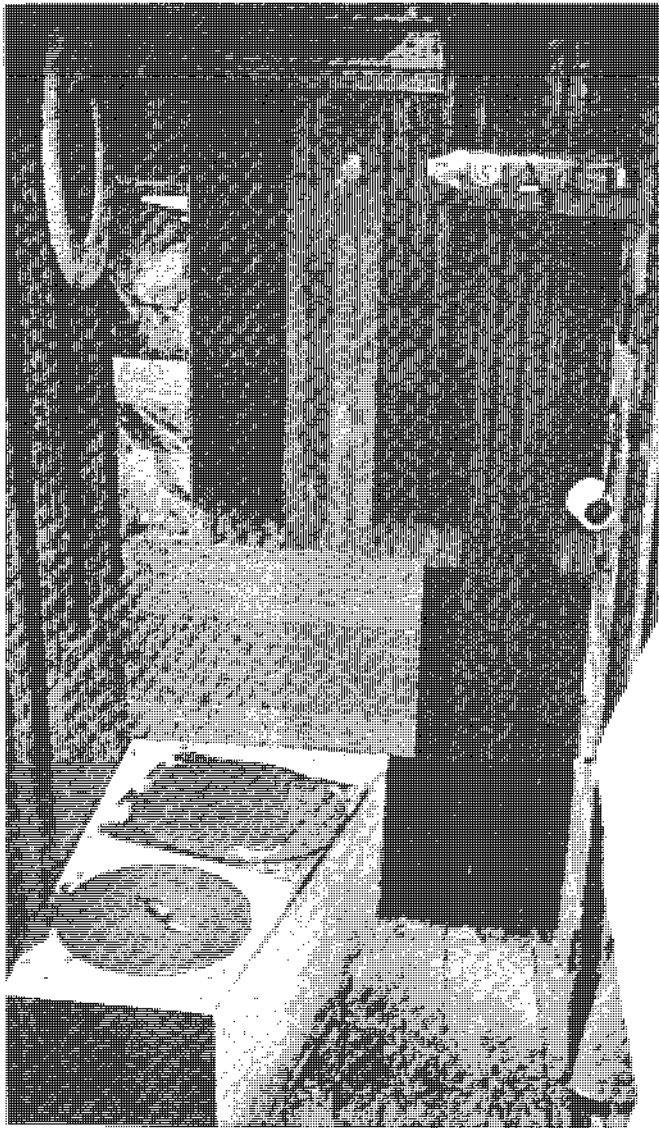
3) No energy is required to operate such a system. No ventilation is necessary if the composting does not take place inside one's home. In which case, no fans or electricity are needed, and no running water is needed, although a small quantity of water is needed (a minimum of 2 quarts or 2 liters) to wash out the collection receptacle after emptying, which is also essential for maintaining an odor free system. The

soiled wash water can be dumped on the compost pile, or at the base of a fenced-off bush or shrub which is inaccessible to people, especially children. Or the water can be deposited into a standard septic system, or into a natural wetland wastewater treatment system.

4) The thermophilically composted organic refuse is transformed into a hygienically safe, valuable resource. The process eliminates sewage, fecal contamination of the environment, and the spread of disease by human pathogens resident in human excrement.

The disadvantages of a collection system requiring the regular removal of humanure to a compost pile are obvious. They include: 1) the inconvenience of carrying the organic refuse to the compost pile; 2) the inconvenience of keeping a supply of organic cover material available and handy to the toilet; 3) and the inconvenience of maintaining and managing the compost pile itself.

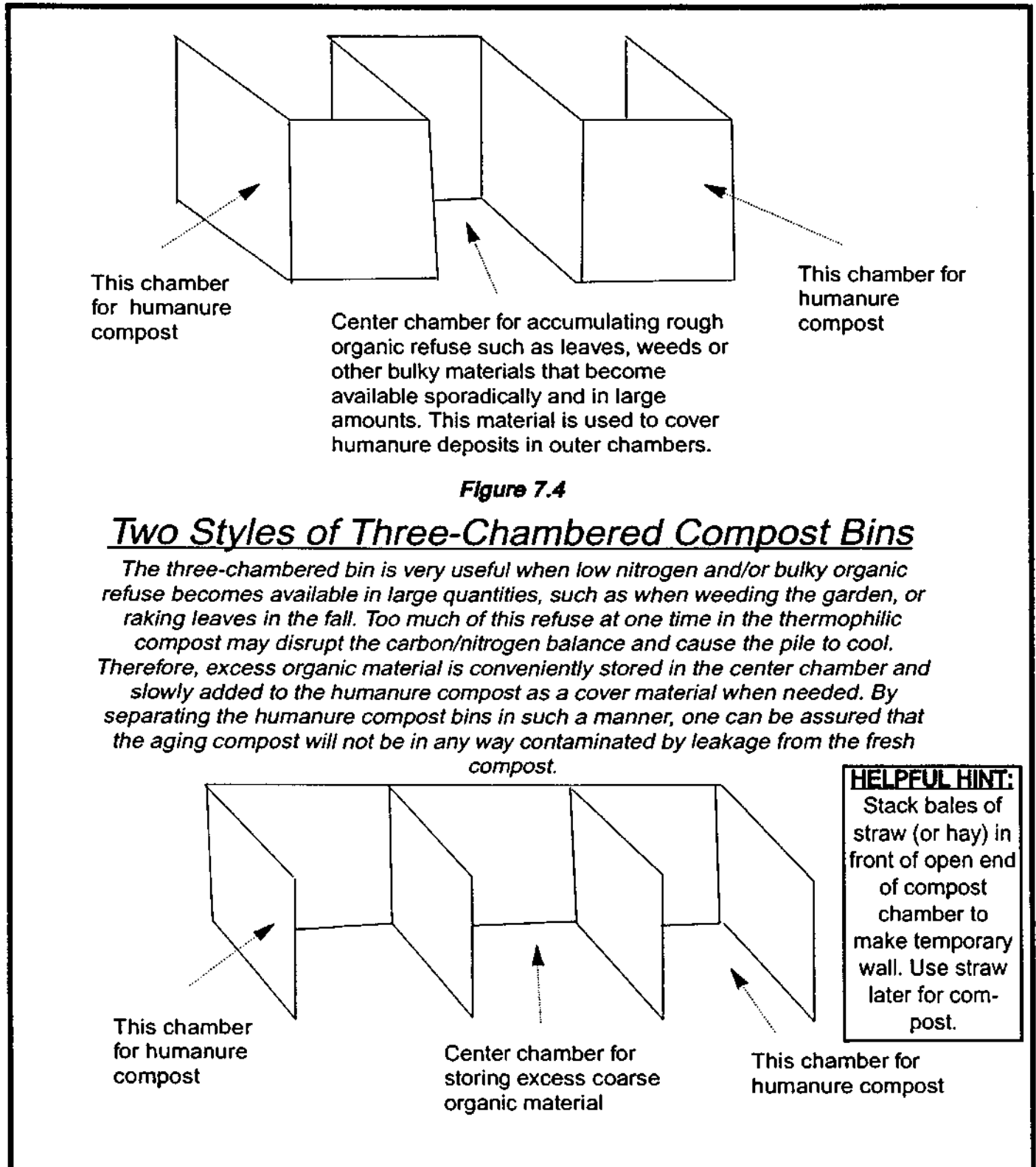
In researching the literature during the preparation of this book, I found it surprising that almost no mention is ever made of the thermophilic composting of humanure as a viable alternative to on-site sanitation. When “bucket” systems are mentioned, they are also called “cartage” systems, and are universally decried as being the least desirable sanitation alternative. For example, in A Guide to the Development of On-Site Sanitation by R. Franceys et. al., published by the World Health Organization in 1992, “bucket latrines” are described as *“malodorous, creating a fly nuisance, a danger to the health of those who collect or use the nightsoil, and the collection is environmentally and physically undesirable”*. This sentiment is echoed in Rybczynski’s (et. al.) World Bank funded work on low-cost sanitation options, where it is stated that *“the limitations of the bucket latrine*



A PEAT TOILET WITH A RECESSED CONTAINER HOLDING PEAT MOSS FOR USE AS A COVER MATERIAL.

include the frequent collection visits required to empty the small container of [humanure], as well as the difficulty of restricting the passage of flies and odors from the bucket.”

Now, I've personally used what could be called a bucket latrine (actually *sawdust toilet* or *biosolids toilet* would be more appropriate terms) for fifteen years and



it has never given me odor problems, fly problems, health problems, or environmental problems. Quite the contrary. Nevertheless, Franceys et. al. go on to say that "[humanure] collection should never be considered as an option for sanitation improvement programmes, and all existing bucket latrines should be replaced as soon as possible." Say what?

Obviously Franceys et. al. are referring to the practice of collecting humanure in buckets without a cover material (which would surely stink to high heaven and attract flies) and without any intention of composting the humanure. Such buckets of feces and urine are presumably dumped raw into the environment. Naturally, such a practice should be decried and strongly discouraged, if not outlawed. However, rather than forcing people who use such crude waste disposal methods to switch to other more prohibitively costly waste disposal methods, perhaps it would be better to edu-

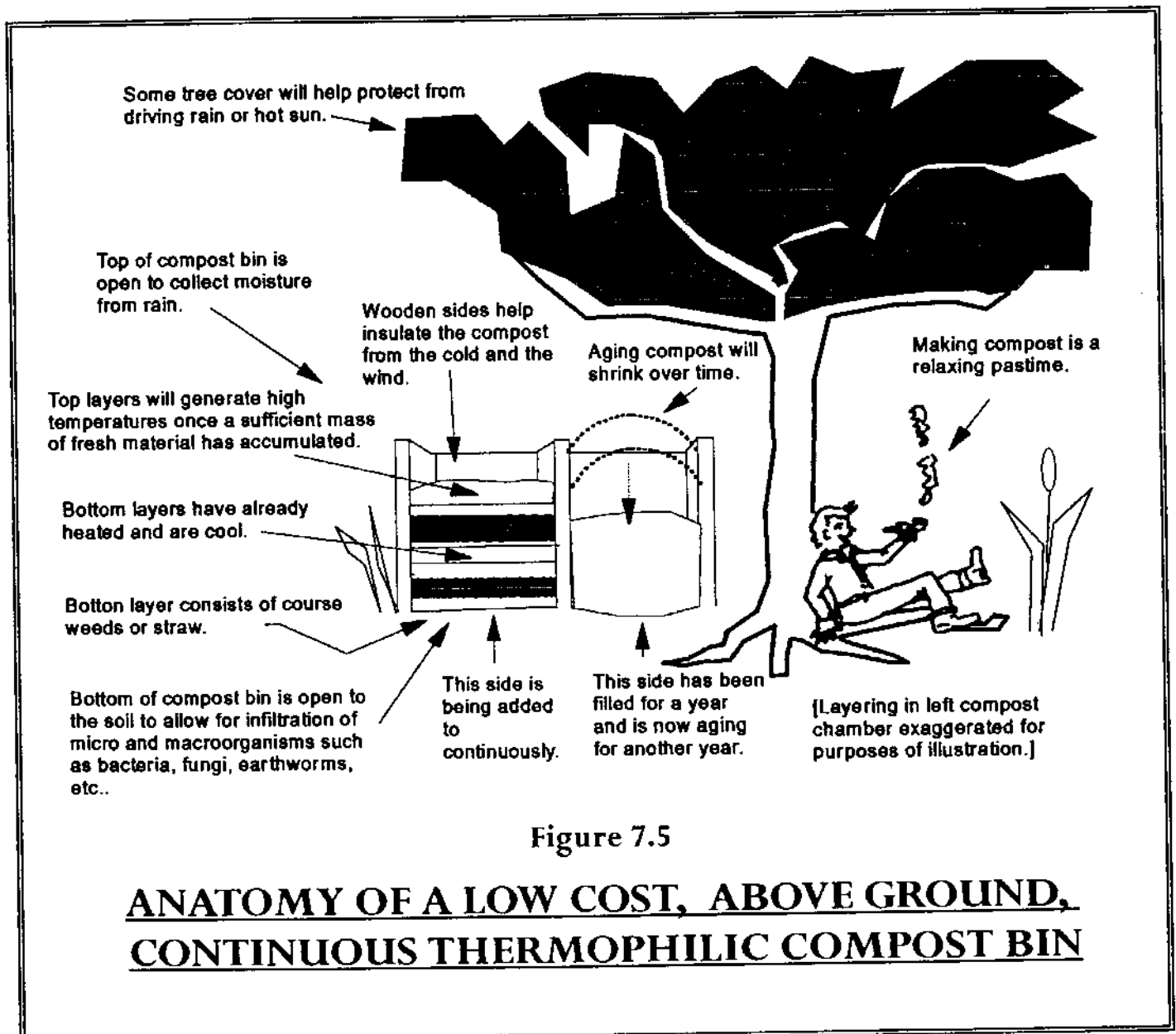


Figure 7.5

**ANATOMY OF A LOW COST, ABOVE GROUND, CONTINUOUS THERMOPHILIC COMPOST BIN**



cate those people about *resource recovery*, about the *human nutrient cycle*, and about *thermophilic composting*, and help them acquire adequate and appropriate *cover materials* for their toilets, assist them in constructing *compost bins*, and thereby eliminate waste, pollution, odor, flies and health hazards altogether. I find it inconceivable that intelligent, educated scientists who observe bucket latrines and the odors and flies associated with them do not see that the simple addition of a clean organic cover material to the system would solve the aforementioned problems. Plus balance the nitrogen of the human feces and urine with carbon.

Franceys, et. al. state, however, in their aforementioned book, that "*Apart from storage in double pit latrines, the most appropriate treatment for on-site sanitation is composting.*" I would agree that composting, when done properly, is the most appropriate method of on-site sanitation available to humans. I would not agree that double pit storage is more appropriate than thermophilic composting unless it could be proven that all human pathogens could be destroyed using such a double pit system, and that such a system would not require the segregation of urine from feces. According to Rybczynski, the double pit latrine shows a reduction of *Ascaris ova* of 85% after two months, a statistic which does not impress me. When my compost is finished, I don't want *any* pathogens in it.

Ironically, the work of Franceys et. al. further illustrates a "decision tree for selection of sanitation" that indicates that the use of a "compost latrine" as being one of the least desirable sanitation methods, and one which can only be used if the user is willing to collect urine separately. Unfortunately, contemporary professional literature is rife with this sort of inconsistent and incomplete information which would surely lead a reader to believe that composting humanure just isn't worth the trouble.

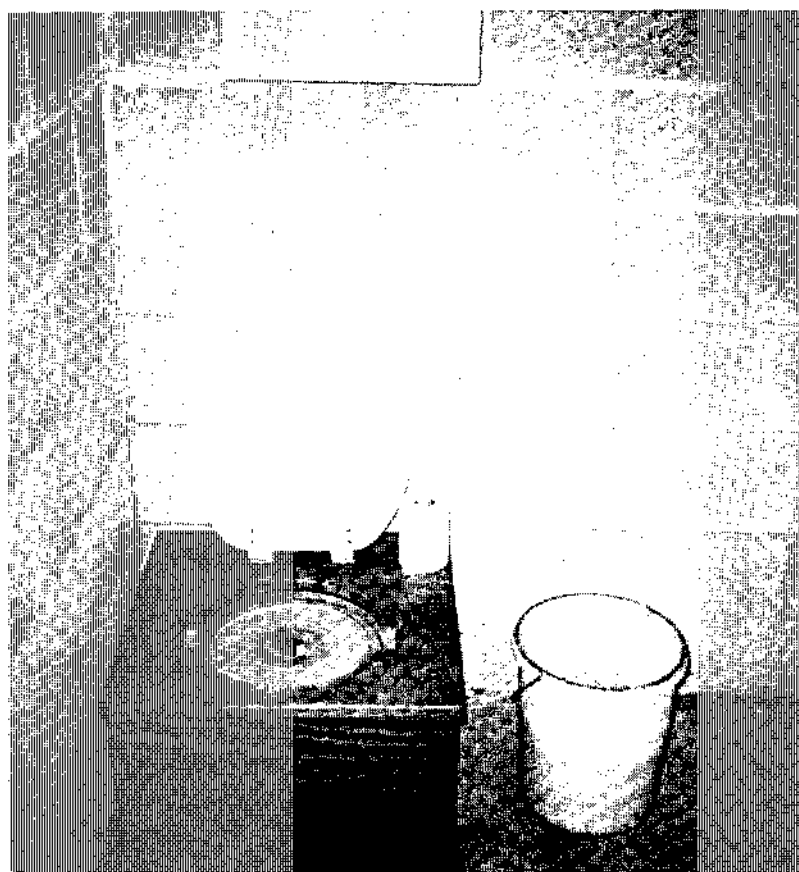
On the other hand, Hugh Flatt, who, I would guess, is a practitioner and not an academic, in Practical Self-sufficiency tells of a sawdust toilet system he had used. He lived on a farm for more than thirty years which made use of "bucket lavatories". The lavatories serviced a number of visitors during the year and often two families in the farmhouse, but they used no chemicals. They used sawdust, which Mr. Flatt described as "absorbent and sweet-smelling." The deciduous sawdust was added after each use of the toilet, and the toilet was emptied on the compost pile daily. The compost heap was located on a soil base, the deposits were covered each time they were added to the heap, and kitchen refuse was added to the pile (as was straw). The result was "*a fresh-smelling, friable, biologically active compost ready to be spread on the garden.*"

Perhaps the "experts" will one day understand, accept, and advocate simple humanure composting techniques such as the sawdust or biosolids toilet. However, we may have to wait until Composting 101 is taught at the university.

## ANALYSES

After nearly fourteen years of composting all of my family's and visitor's humanure on the same spot about fifty feet above my garden, and using all of the finished compost to grow the food in our single garden, I analyzed my garden soil, my yard soil (for comparison), and my compost, each for fertility and pH, using LaMotte test kits from the local university<sup>8</sup>. I also sent samples of my feces to a local hospital lab to be analyzed for indicator pathogenic ova or worms. The analyses are as follows:

The humanure compost proved to be adequate in nitrogen (N), and rich in phosphorus (P), and potassium (K), and higher than either the garden or the yard soil



A SAWDUST TOILET IN A BASEMENT.

THIS TOILET IS USED AS AN EMERGENCY BACKUP IN A HOUSE WITH A SEPTIC SYSTEM. NOTE THAT THE HUMANURE RECEPTACLE EMPLOYS AN INNER LID, WHICH IS NOT NECESSARY WHEN ROTTED DECIDUOUS SAWDUST IS USED AS A COVER MATERIAL AND THE REGULAR TOILET SEAT FITS SNUGLY AGAINST THE TOP OF THE HUMANURE RECEPTACLE. THE BUCKET TO THE RIGHT CONTAINS CLEAN SAWDUST, WHICH IS ADDED TO THE TOILET AFTER EACH USE.

in these constituents as well as in various beneficial minerals. The pH of the compost was 7.4 (slightly alkaline), and no lime or wood ashes had been added during the composting process. This is one reason why I don't recommend adding lime (which raises the pH) to a compost pile. A finished compost would ideally have a pH around 7 (neutral).

The garden soil was slightly lower in nutrients (N, P, K) than the compost, and the pH was also slightly lower at 7.2. I had added lime and wood ashes to my garden soil over the years, which may explain why it was slightly alkaline. The garden soil, however, was still significantly higher in nutrients and pH than the yard soil (pH of 6.2), which remained generally poor.

My stool sample was free of pathogenic ova or worms. I used my own stool for analysis purposes because I had been exposed to

the compost system and the garden soil longer than anyone else in my family by a number of years. I had freely handled the compost year after year with no reservations (my garden is mostly hand-worked). I repeated the stool analysis a year later (after fifteen years of composting humanure) again with negative results (no ova or parasites observed).

These results indicate that the compost is a good soil builder, and that no intestinal parasites were transmitted from the compost to the compost handler. This wasn't a laboratory experiment; it was a real life situation conducted over a somewhat lengthy period of time. The whole process, for me, has been a success.

### ***LOW-IMPACT COMPOSTING***

It's very important to understand that *two* factors are involved in destroying pathogens in humanure. Along with heat, the *time* factor is important. Once the organic material in a compost pile has been heated by thermophilic microorganisms, it should be left to age or "season". This part of the process allows for the final decomposition to take place, decomposition that may be dominated by fungi and macroorganisms such as earthworms. Therefore, a good compost system will utilize at least two sections or chambers in a single bin, or two separate bins, one to fill and leave to age, and another to fill while the first is aging. One may want to have two separate single-chambered compost bins, or a three-chambered compost bin, or any variation of the double-chambered bin that meets the individual's needs.

When using two compost chambers, fill them one at a time. Stop filling the first one when it's full, which may take a year, and leave it alone. Don't turn it unless you want some exercise, however it should still be heating on the top layer, and turning it now may put out the fire. At that time start filling the second chamber. Then, when the second chamber is nearly full (a year later?), the first one can begin to be emptied onto the garden. The object is to let the compost rest for about a year after the pile has been fully constructed. Pure simplicity (see figures 7.3, 7.4 and 7.5).

A compost pile can accept a huge amount of refuse, and even though the pile may seem to be full, as soon as you turn your back it will shrink down and leave room for more material. So when I say fill the first chamber before filling the second, I mean *FILL* it. You'll know when it's getting full when nothing else will fit on the pile without trying to roll out of the bin.

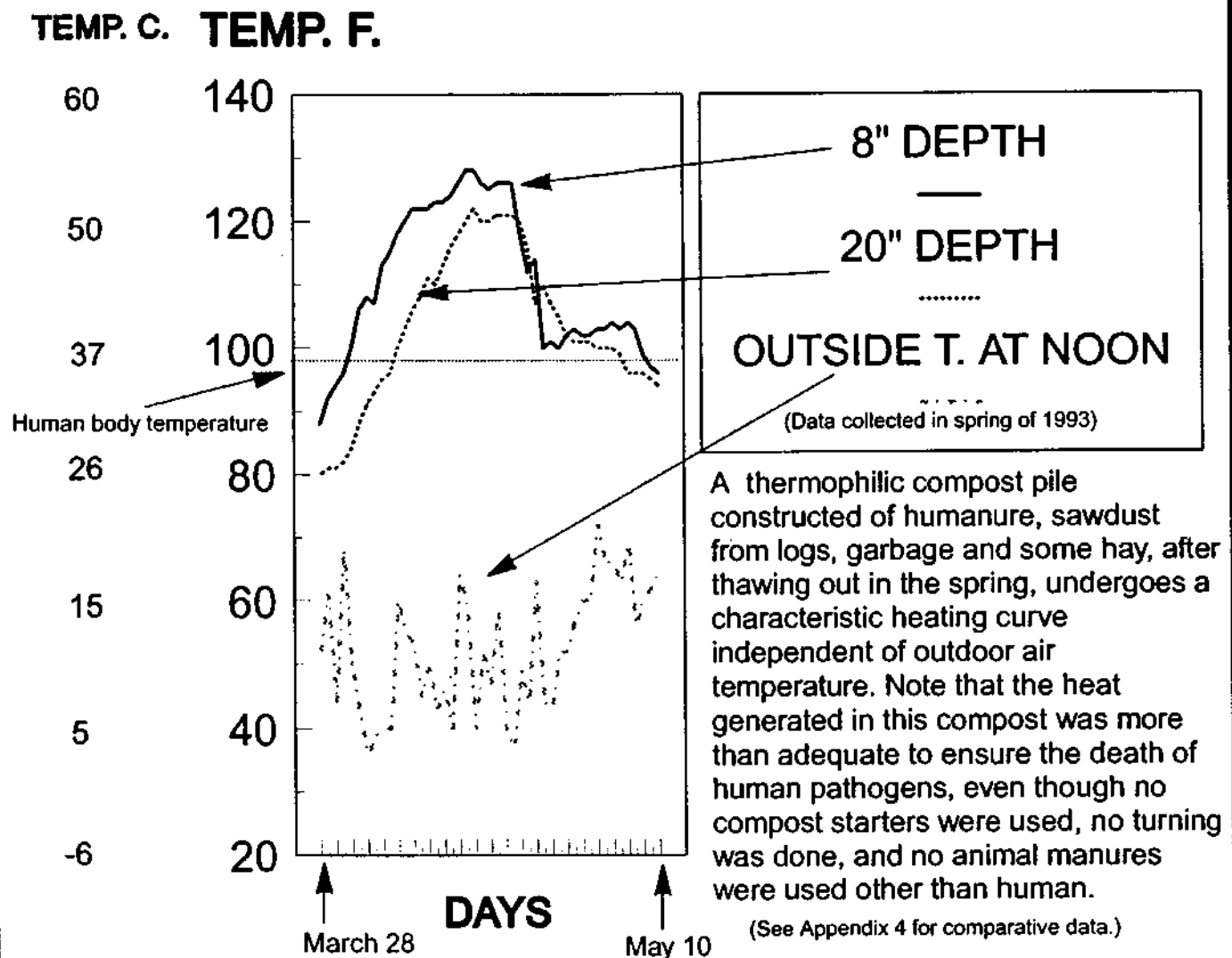
The timing cycle I follow for compost-making is natural. Natural cycles of time include daily cycles, or "circadian rhythms". For humans that usually involves a daily defecation, a daily sleeping period, etc. For the planet it involves the daily rotation. This cycle of time connects us, as humans, to the other life forms on the earth. It's something we all share in common.

Monthly cycles include the waxing and waning of the moon, the monthly new and full moons, or the monthly revolution of the moon around the earth. This involves tidal cycles, menstrual cycles, and probably a heck of a lot more that I'm not aware of.

Seasonal cycles break up the annual revolution of the Earth around the sun. They're marked by the spring and fall equinoxes and the winter and summer solstices, and by the weather changes of the seasons. All of these cycles are included in the yearly cycle, which involves gardening, farming, planting, harvesting, and anything else done on an annual schedule, including an annual period of rest.

Figure 7.6

## Temperature Curve of Frozen Humanure Compost Pile After Spring Thaw

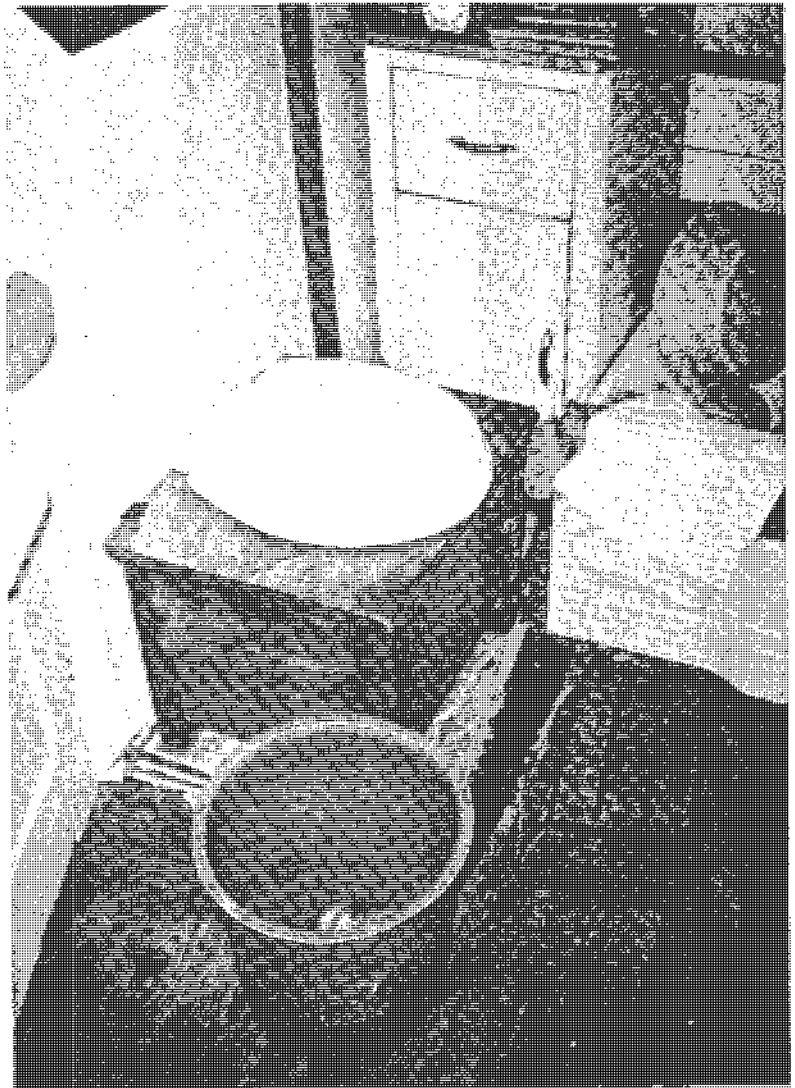


When working with natural cycles such as with the composting stage of the human-nutrient cycle, it's best, I believe, to follow natural cycles of time as well. They go hand in hand. Therefore, I've found a yearly cycle to work best for me in making compost. By late spring, the compost bin is full and it's time to leave it sit until the next spring, when the finished compost will be ready to be removed to the garden. The removal of the finished compost takes place in the spring prior to or during planting time.

### ***MONITORING COMPOST TEMPERATURE***

The preceding graph shows the rise in temperature of a humanure compost pile (feces, urine, and garbage) which had been frozen all winter. That particular spring was very cold, so the pile didn't thaw out until late March. Until then it was hard as a rock, a large pile of frozen mass, nearly filling a 5' x 5' x 4' bin.

The compost consisted primarily of deposits from the sawdust toilet, which contained raw hardwood sawdust (just enough to cover the material in the toilet), humanure including urine, and toilet paper. In addition to this material, kitchen garbage was added to the pile intermittently throughout the winter, and hay was used to cover the toilet deposits on the pile. Some weeds and whatnot may have been thrown in now and then, but garden material isn't available during the winter except in the form of



**THIS SAWDUST TOILET CONSISTS OF A WOODEN BOX SITUATED OVER A FIVE GALLON, PLASTIC HUMANURE RECEPTACLE (NOT VISIBLE). THE BOX IS LIFTED OFF THE RECEPTACLE WHEN IT IS FULL, AND THE ORGANIC REFUSE IS THEN REMOVED TO THE COMPOST BIN OUTDOORS.**

# DO's and DON'T's of a thermophilic toilet composting system:

**DO** - Collect urine in the toilet. Urine provides essential moisture and nitrogen.

**DO** - Have a supply of cover material for the toilet to eliminate odor, absorb excess moisture and urine, and balance the C/N ratio. Examples: rotting sawdust, peat moss.

**DO** - Have another supply of cover material to cover the compost pile itself, for odor prevention, air entrapment, and C/N balance. Examples: Hay, straw, weeds, leaves, grass.

**DO** - Occasionally rake exposed outer surfaces of the compost pile onto the top of the pile.

**DO** - Add a mix of organic material to the compost pile, including organic garbage.

**DO** - Keep top of compost pile somewhat flat. This allows rain to be absorbed, and added organic material to stay on top.

**DO** - Use a compost thermometer. If the temperature of your compost does not seem adequate to you, use finished compost for berries, fruit trees, and ornamentals, instead of garden crops.



**DON'T** - Segregate urine from feces.

**DON'T** - Turn the pile if it is being continuously added to.

**DON'T** - Cover fresh compost deposits with lime or wood ashes. Put lime and wood ashes directly on soil. Cover compost with clean organic materials that will benefit the composting process, such as mentioned at left.

**DON'T** - Deposit urine/feces/sawdust into a compost bin without cover

materials and other organic refuse and expect it to thermophilically compost. The layering of a wider mix of materials traps air and provides nutrients that stimulate thermophilic activity.

**DON'T** - Worry if your compost does not reach an extremely high temperature quickly. Temperatures above 110° F indicate thermophilic activity, which may peak periodically in a continuous compost pile when sufficient organic mass has accumulated.

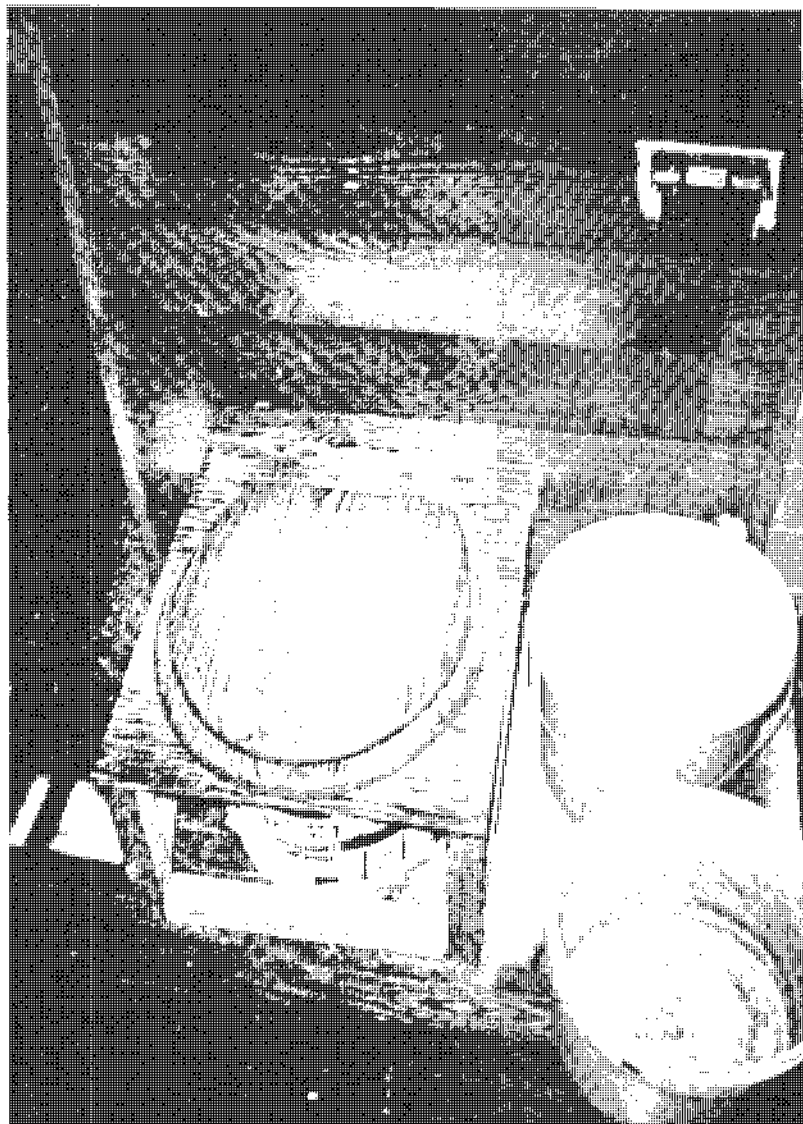
Temperatures above 104°F may be sufficient to kill pathogens (see page 99).

A compost bin may require some time to develop a resident thermophilic population. If your compost does not achieve thermophilic temperatures, after collecting it for a year and aging it for another year, use it to plant berries, fruit trees, or ornamental plants.

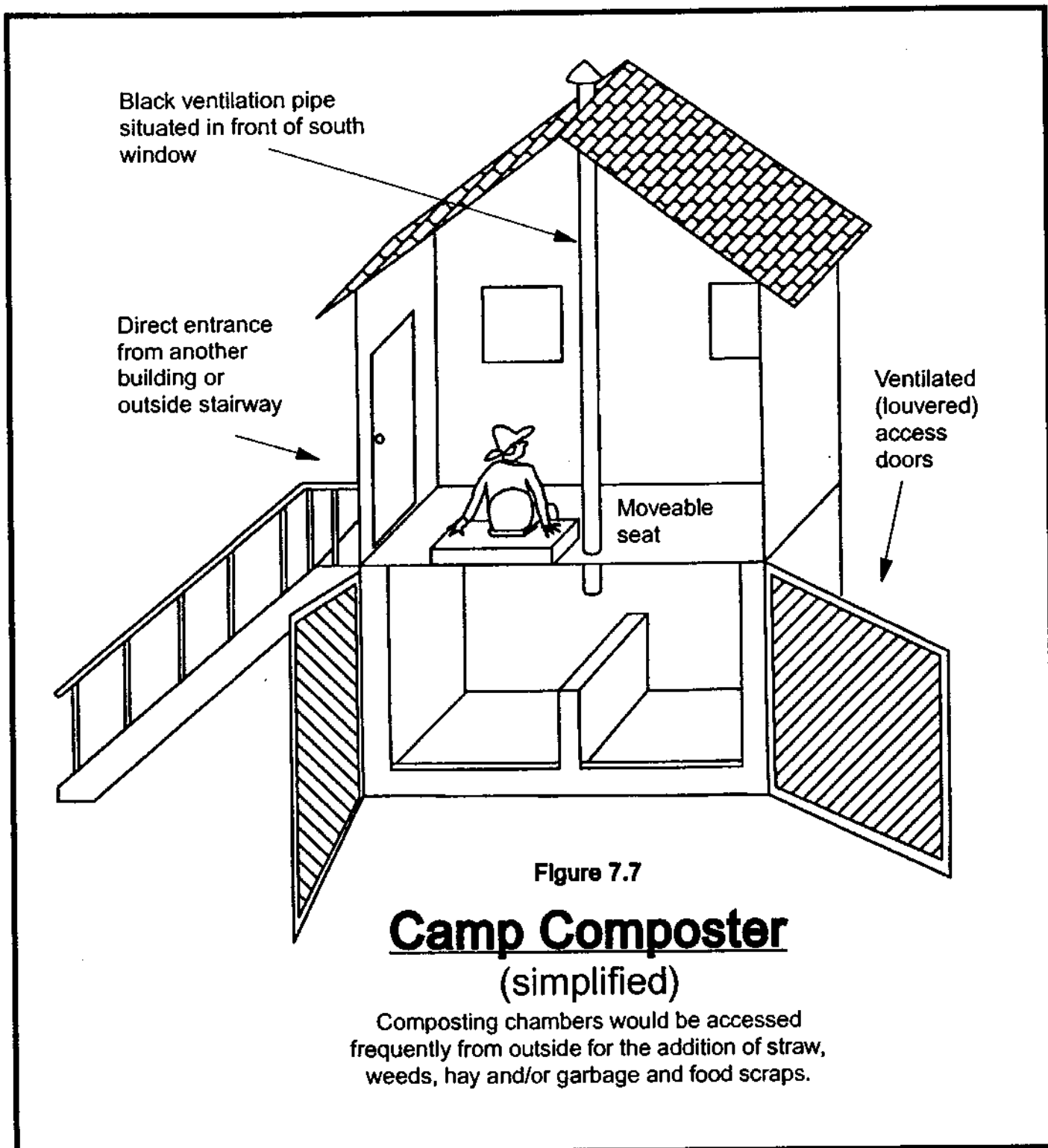
kitchen refuse, so not much in the way of garden weeds was in this pile.

The material was collected over a period of about four months from a family of four. Nothing special was done to the pile at any time. No unusual ingredients were added, no compost starters, no water, no animal manures other than human, and no turning whatsoever. The compost pile was situated in a three-sided, open-topped wooden bin on the dirt ground, outside. Only normal household organic refuse such as produced by any human being was added to the pile including human fecal material and urine. The only imported materials (not from the home) were sawdust, a locally abundant resource, and hay from a neighboring farm (one or two bales were used during the entire winter).

Notice that the outside of the pile was heated by thermophilic activity before the inside. The outside thawed first, so it started to heat first. Soon thereafter the inside thawed and also heated. By April 8th the outer part of the pile had reached 120°F (50°C) and the temperature remained at that level or above until April 22 (a two week period). The inside of the pile reached 120°F on April 16, over a week later than the outside, and remained there or above until April 23. The data suggest that the entire pile was at or above 120°F for a period of eight days before starting to cool. Two thermometers were used to monitor the temperature of this compost, one having an 8" probe, the other having a 20" probe. The 8" thermometer came from Edmund Scientific Co.; the 20" thermometer came from Real Goods, 966



**A SAWDUST TOILET IN A MOBILE HOME. THE FRAME IS HINGED TO THE WALL AND LIFTS UP OFF THE HUMANURE RECEPTACLE WHEN REMOVAL IS NECESSARY.**



Mazzoni St., Ukiah, CA 95482-9292. The Real Goods thermometer was the best buy (see appendix 1 on page 185 for sources of compost thermometers).

According to Dr. T. Gibson, Head of the Department of Agricultural Biology at the Edinburgh and East of Scotland College of Agriculture, *"All the evidence shows that a few hours at 120 degrees Fahrenheit would eliminate [pathogenic*



*microorganisms] completely. There should be a wide margin of safety if that temperature were maintained for 24 hours.”* (See The Complete Book of Composting, 1960, J. I. Rodale, p. 650, Rodale Books, Emmaus, PA).

This opinion is corroborated by Feachem et. al. and many others, and is illustrated in figure 6F, page 133, titled “Safety Zone for Pathogen Death”, which is a diagram adapted from Feachem’s work (Appropriate Technology for Water Supply and Sanitation) extensively used as a reference in chapter 6. That diagram indicates that one day at 122°F will kill the human pathogens that can be resident in humanure. A week at 115°F will do the same thing. Higher temperatures kill things faster, lower temperatures take more time. A combination of heating the compost then retaining the heated and cooled compost in storage for a period of months seems to be a good bet for making fine kitchen-garden compost from humanure. That’s the sawdust or biosolids toilet system in a nutshell.

The significance of the aforementioned graph is that it shows the humanure required no coaxing to heat up sufficiently to be rendered hygienically safe. It just did it on its own, having been provided the simple requirements a compost pile needs.

A comparative temperature curve monitored the following spring indicated that the addition of a small amount of chicken manure improved the thermophilic activity of the compost (see appendix 4, p. 187).



**AN OUTDOOR SAWDUST TOILET BUILT OF RECYCLED MATERIALS. A REMOVABLE BUCKET LINGERS UNDER THE TOILET SEAT, WAITING TO BE FILLED, EMPTIED AND COMPOSTED.**

## LEGALITIES

I knew of some local folks, Amish, who had a baby at home a couple of years ago. Babies born at home nowadays are no big deal; most of the Amish have a midwife deliver their babies. All of my six children were born at home. However, a local county health worker decided to put a stop to this practice and *charged the young Amish couple with child abuse for not having their baby born in a hospital.*

Here we have an otherwise happy young couple who just had a beautiful baby, and some poor, deluded authority figure was actually telling them he'd have their baby taken away and put in a foster home if they didn't tell him who delivered the kid. This is a true story. The couple gave him the name of their midwife, a highly respected and eminently qualified woman who has now delivered over one thousand babies. She was promptly arrested. To make a long story short, the local magistrate threw the charge (practicing medicine without a license) out, the authorities actually appealed, then the higher court threw the charges



THIS UNPRETENTIOUS STRUCTURE HOUSES A SAWDUST TOILET. ALTHOUGH CONSIDERED AN "OUT-HOUSE", THERE IS NO PIT UNDERNEATH AND NO LEACHING OF POLLUTION INTO THE GROUND. THE HUMANOURE IS INSTEAD COLLECTED AND COMPOSTED.

out.

What's that have to do with compost? Composting humanure, is like having babies where and how you want them, or educating your kids alternatively. It's behavior out of the mainstream of Western society. It may be something different, and different things can scare people when they don't know anything about them, especially

those people who have oatmeal for brains and have somehow gravitated into a position of authority. Whether it's legal or not often isn't the issue. The Amish story is one of many in which the basic rights of humans have been subverted by the ignorance and the misuse of authority by others.

Ideally, laws are made to protect society. Laws requiring septic, waste, and sewage disposal systems are supposedly designed to protect the environment, the health of the citizens and the water table. This is all to be commended,

and conscientiously carried out by those who produce *sewage*, a waste material. If you don't produce sewage, you have no need for a sewage disposal system, and laws pertaining to sewage disposal are not your concern. The number of people who produce compost instead of sewage is so minimal, that few, if any, laws have been enacted to regulate the practice. The thermophilic composting of humanure is not a threat to society, it produces no pollution, does not threaten the health of humans or contaminate the ground water or environment. Unfortunately, this fact is not understood by many people, and ignorance is a problem.

It would be hard to intelligently argue that a person who produces no sewage must have a costly sewage treatment system. What would they do with it? That would be like requiring someone who doesn't own a car to have a garage. And it would be very difficult to prove that composting humanure is threatening to society, especially given the facts as presented in this book. On the other hand, Galileo, the astronomer, was arrested as a heretic and forced to renounce his theory that the Earth revolves around the sun. Sure, that was three hundred years ago. But sometimes I think the consciousness of our society as it relates to human manure is still back in the middle

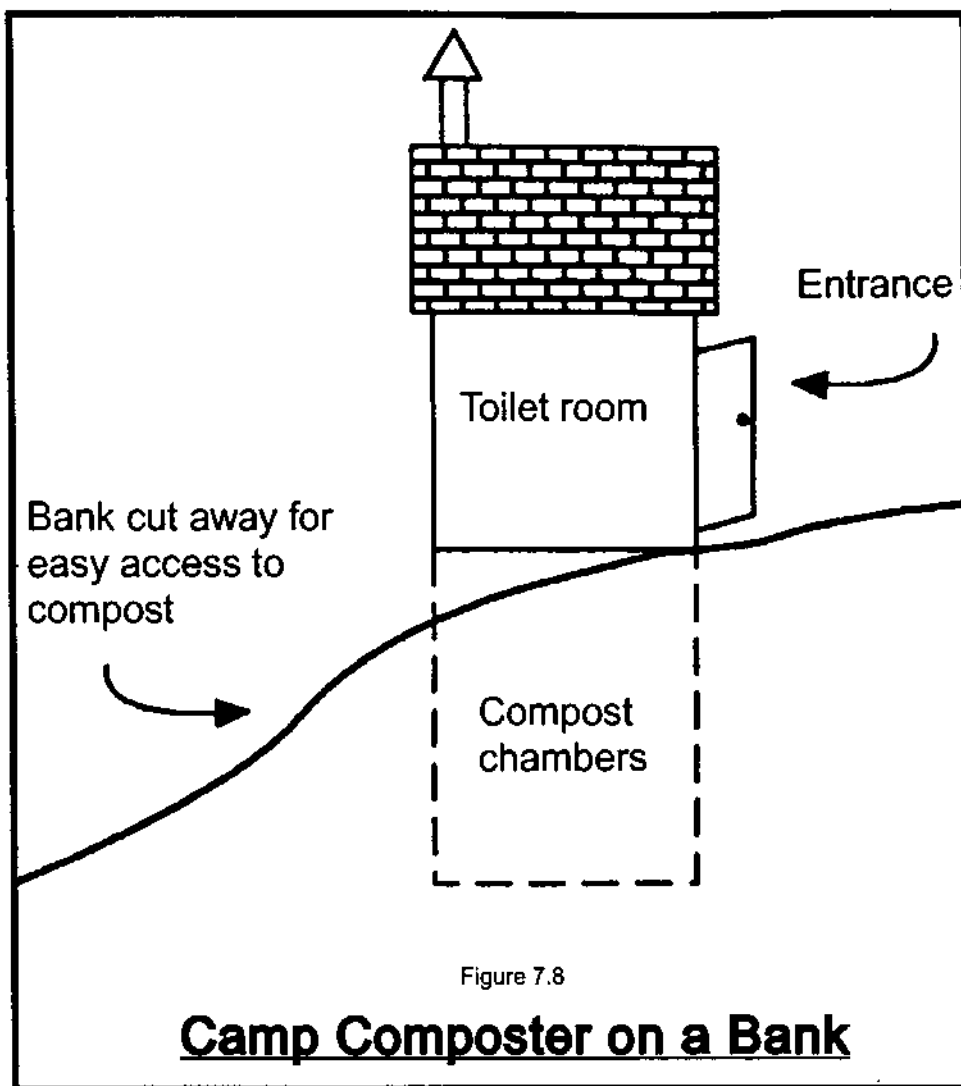


Figure 7.8

### **Camp Composter on a Bank**

ages.

One way to dispel the darkness of ignorance is with the light of knowledge. Knowledge is best gained by experience. Therefore, I'd like to hear from any of you readers about your composting experiences. You may be able to add to the body of knowledge, and I may someday revise and update this book to include the experiences of others. So don't hesitate at any time to write to the address at the front of this book and let me know how it's going for you. I'd welcome *any* feedback at all.

If you're concerned about your local laws, go to the library and see what you can find about regulations concerning compost. Or also inquire at your county seat or state agency as statutes, ordinances, and regulations vary from locality to locality.\* Where I live septic system permits aren't required for new home construction, but the next county is two properties over and people there are required to have septic system permits before they can build a new dwelling. This is largely due to the fact that the water table tends to be high in my area, and septic systems don't always work, so sand mounds are required by law for sewage disposal. Now, if you don't want to dispose of your manure but want to compost it instead (which will certainly keep it out of the water table, not to mention raise a few eyebrows at the local municipal office), you may have to stand up for your rights.

In Pennsylvania, the state legislature has enacted legislation "*encouraging the development of resources recovery as a means of managing solid waste, conserving resources, and supplying energy.*" Under such legislation the term "disposal" is defined as "*the incineration, dumping, spilling, leaking, or placing of solid waste into or on the land or water in a manner that the solid waste or a constituent of the solid waste enters the environment, is emitted into the air or is discharged to the waters of the Commonwealth*" (Pennsylvania Solid Waste Management Act, Title 35, Chapter 29A). Further legislation has been enacted in Pennsylvania stating that "*waste reduction and recycling are preferable to the processing or disposal of municipal waste,*" and further stating "*pollution is the contamination of any air, water, land or other natural resources of this Commonwealth that will create or is likely to create a public nuisance or to render the air, water, land, or other natural resources harmful, detrimental or injurious to public health, safety or welfare. . .*" (Pennsylvania Municipal Waste Planning, Recycling and Waste reduction Act (1988), Title 53, Chapter 17A). In view of the fact that the thermophilic composting of humanure involves recovering a resource, requires no disposal of waste, and creates no environmental pollution, it is unlikely that anyone who *conscientiously* engages in such an activity would be successfully convicted of criminal activity.

If there aren't any regulations concerning compost in your area, then be sure that when you're making your compost, you're doing a good job of it. It's not hard to do it right. The most likely problem you could have is an odor problem, and that's

simply due to not keeping your deposits adequately covered with clean organic material. If you keep it covered, it does not give off offensive odors. It's that simple. Perhaps shit stinks so people will be naturally compelled to cover it with something. That makes sense when you think that thermophilic bacteria are already in the feces waiting for the manure to be layered into a compost pile so they can get to work. Sometimes the simple ways of nature are really profound.

Few people understand that the composting of humanure is a benign method of recycling what would otherwise be a toxic waste material. For that reason, this book is recommended reading for people involved in municipal, county, or township waste treatment or permitting, or resource recovery.

What about gray water? You're still producing gray water and therefore you may still need a septic system or something of the sort as required by law, you may wonder. Maybe, maybe not. Gray water is relatively easy to deal with. A biological treatment system such as an artificial wetland, algae pond, or heck, a patch of woods can effectively absorb gray water, especially if you have sense enough to keep toxic materials and fecal material out of your drains. However, now we're getting beyond the scope of this book. Low-impact gray water treatment systems could involve another whole publication.

And what about flies, could they create a public nuisance? I have never had problems with flies on my compost. Perhaps the compost heats up so fast that flies don't have a chance to enjoy it. And rats? I've never seen one on my homestead. I guess steaming compost doesn't appeal to them. Nor does it appeal to raccoons, dogs or cats.

Concerning flies, F. H. King, who traveled through China, Korea and Japan in the early 1900's when organic material, especially humanure, was the only source of soil fertilizer, stated, *"One fact which we do not fully understand is that, wherever we went, house flies were very few. We never spent a summer with so little annoyance from them as this one in China, Korea and Japan. If the scrupulous husbanding of waste [sic] refuse so universally practiced in these countries reduces the fly nuisance and this menace to health to the extent which our experience suggests, here is one great gain."* He added, *"We have adverted to the very small number of flies observed anywhere in the course of our travel, but its significance we did not realize until near the end of our stay. Indeed, for some reason, flies were more in evidence during the first two days on the steamship out from Yokohama on our return trip to America, then at any time before on our journey."*<sup>9</sup>

If an entire country the size of the United States, but with twice the population (at that time), could recycle all of its organic refuse without the benefit of electricity or automobiles and not have a fly problem, surely we in the United States can recycle a greater portion of our own organic refuse with similar success today.

## REFERENCES - CHAPTER SEVEN

- 1 - Thimann, K.V. (1955). The Life of Bacteria: Their Growth, Metabolism, and Relationships. The Macmillan Co., New York. (p.177).
  - 2 - Waksman, S.A. (1952). Soil Microbiology. John Wiley and Sons, Inc., New York. (p.70).
  - 3 - Atlas, R.M. and Bartha, R. (1981). Microbial Ecology: Fundamentals and Applications. Addison-Wesley Publishing Co., Reading, Mass. (p.392)
- also:
- Cooney, D.G. and Emerson, R. (1964). Thermophilic Fungi. W.H. Freeman and Company, San Francisco. (pp.129,142).
- also
- Waksman, Soil Microbiology, (p.71).
- 4 - Lewis, Ricki. (1992). FDA Consumer, September 1992 (p.37)
  - 5 - Lynch, J.M. and Poole, N.L. (Eds.). (1979). Microbial Ecology: A Conceptual Approach. Blackwell Scientific Publications, London. (p.238).
  - 6 - Rodale, R. I. (1960). The Complete Book of Composting. Rodale Books Inc.: Emmaus, PA. (p.192).
  - 7 - Kitto, Dick. (1988). Composting: The Organic Natural Way. Thorsons Publishers Ltd.: Wellingborough, England. (p. 103).
  - 8 - LaMotte Chemical Products Co., Chestertown, MD 21620
  - 9 - King, F.H. (1911). Farmers of Forty Centuries. Rodale Press, Inc., Emmaus, PA 18049. (pp.78, 202).

**\*Maryland residents (or anyone else) can obtain: "A Farmers' Guide to Maryland Compost Regulations", from Pickering Creek Environmental Center, 27370 Sharp Road, Easton, Maryland 21601.**

**"The On-Farm Composting Handbook" is available from The Northeast Agricultural Engineering Service, 152 Riley-Robb Hall, Cooperative Extension, Ithaca, NY 14853-5701.**

**Two information packages on Farm Scale Composting and Yard Waste Composting are available free from the Appropriate Technology Transfer for Rural Areas, PO Box 3657, Fayetteville, AR 72702, phone: (800) 346-9140.**

**A journal of composting and recycling which may contain pertinent information is: Biocycle, JG Press, Inc., 419 State Ave., Emmaus, PA 18049.**

**The Agricultural Composter Newsletter is available from: The Agricultural Composting Association, PO Box 608, Belchertown, MA 01007.**

## THE END IS NEAR

*"If you want to be free, learn to live simply. Use what you have and be content where you are."*

J. Heider



Ladies and gentlemen, allow me to introduce you to a new and revolutionary literary device: the *Self-Interview!* [Applause heard in background. Someone whoops.] Today I'll be interviewing myself. In fact here I am now. [Myself walks in.]

Me: Good morning sir. Haven't I seen you somewhere before?

Myself: Cut the crap. It's too early in the morning for this. You see me every time you look in the mirror, which isn't very often, thank God. What, for crying out loud, would possess you to interview yourself anyway?

M: If I don't, who will?

MS: You do have a point there. In fact, that may be a point worthy of contemplation.

M: Well, let's not get off the track. The topic of discussion today is a material substance near and dear to us all. Shall we step right into it?

MS: What the hell are you talking about?

M: I'll give you a hint. It often can be seen with corn or peanuts on its back.

MS: Elephants?

M: Close, but no cigar. In fact, cigar would have been a better guess. We're going to talk about *humanure*.

MS: You dragged me out of bed and forced me to sit here in front of all these people to talk about CRAP?!

M: You wrote a book on it, didn't you?

MS: So what? OK, OK. Let's get on with it. I've had enough of your theatrics.

M: Well first off, do you expect anyone to take your *Humanure Handbook* seriously?

MS: Why wouldn't they?

M: Because nobody gives a damn about humanure. The last thing anyone

wants to think about is a turd, especially their own. Don't you think that by bringing the subject to the fore you're risking something?

MS: You mean like mass constipation? Not quite. I'm not going to put any toilet bowl manufacturers out of business. Like I said, I'd estimate that one in a million people have any interest at all in the topic of resource recovery in relation to human excrement. Nobody thinks of shit as a resource, it's just too bizarre a concept. When I've printed and distributed the 250th copy of the *Humanure Handbook* in the USA, I'll probably consider that market saturated.

M: Then what's the point?

MS: The point is that long-standing cultural prejudices and phobias need to be challenged once in a while by somebody, anybody, or they'll never change. Fecophobia is a deeply rooted fear in the American, and perhaps Western, psyche. But you can't run from what scares you. It just pops up somewhere else where you least expect it. We've adopted the policy of defecating in our drinking water and then piping it off somewhere to let someone else, if anyone, deal with it. So now we're finding that our drinking water sources are becoming increasingly contaminated. What goes around comes around.

M: Oh, come on. I drink water everyday and it's never contaminated. We Americans probably have the most abundant supply of safe drinking water of any country on the planet.

MS: Yes and no. Your water may suffer from no fecal contamination, true, and when I say fecal contamination I mean intestinal bacteria in water. But how much chlorine do you drink instead? Then there's beach pollution. But I don't want to get into all this again. I've already discussed human waste pollution in chapter one.

M: Then you'll admit that American water supplies are pretty safe?

MS: Yes, they are. Even though we defecate in our water, we go to great lengths and expense to clean the pollutants back out of it. We do a good enough job to keep most of our drinking water safe, albeit with chemical additives. However, drinking water supplies are dwindling all over the world, water tables are sinking, and water consumption is on the increase with no end in sight. That seems to be a good reason to not pollute water with our daily bowel movements. And still, that's only *half* the equation.

M: What do you mean?

MS: Well, we're still throwing away the agricultural resources that humanure should be providing us. We're not maintaining an intact human nutrient cycle. By piping sewage into the sea we're essentially dumping grain into the sea. By burying sludge, we're burying a source of food. That's a cultural practice that should be challenged. It's a practice that's not going to change overnight, but will change incremen-



tally if we begin acknowledging it now.

M: So what're you saying? You think everybody should shit in donut buckets?

MS: God forbid. Then you would see mass constipation!

M: Well then, I don't understand. Where do we go from here?

MS: I'm not suggesting a mass cultural revolutionary change in toilet habits. I'm suggesting a change in the way we *understand* our habits. Most people never heard of such a thing as a nutrient cycle. Recycling humanure is just not something anyone ever thinks about. I'm simply suggesting that we begin thinking about new approaches to the age-old problem of what to do with human excrement.

M: That's a beginning, but that's probably all we'll ever see in our lifetime, don't you think?

MS: Don't be so sure about that. Things are changing. I predict that compost toilets and toilet systems will be designed and redesigned in our lifetimes. Eventually, entire housing developments will utilize compost toilet systems. Some municipalities will someday install compost toilet systems in all new homes.

M: You think so? What would that be like?

MS: Well, each home might have a removable container made of recycled plastic that would act as both a toilet receptacle and a garbage disposal.

M: How big a container?

MS: You'd need about five gallons of capacity per person per week. A container the size of a fifty gallon drum should fill in two to three weeks for an average family. Every household will deposit all of its organic refuse except gray water into this glorified donut bucket, including maybe grass clippings and yard leaves. The municipality will provide a cover material for odor prevention of something like ground leaves or rotted sawdust, neatly packaged for each household and possibly dispensed automatically into the toilet after each use. *This would eliminate the production of all garbage and all sewage by human households*, as it would all be collected without water and composted at a municipal compost yard away from town.

M: Who'd collect it?

MS: Once every couple of weeks or so the *Resource Recovery Team* would stop by and take the compost receptacle from your house, sliding it out a side wall in a manner similar to the old coal chutes, using a hand-operated fork lift type machine specially suited for this purpose. A new compost receptacle would then be slid back in to replace the old, and the air-tight gasket joining it to the toilet seat and ventilation pipe would be locked into place. Your manure and your garbage, mixed together with ground leaves and other organic refuse or crop residues would be collected regularly just like your garbage is collected now. Except the destination would not be a landfill, it'd be the compost yard where the organic material would be converted, through

thermophilic composting, into an agricultural resource, and sold to farmers who'd use it to grow food. The natural cycle would be complete, immense amounts of landfill space would be saved, a valuable resource would be recovered, pollution would be reduced, and soil fertility would be enhanced. So would our long-term survival as human beings on this planet.

M: I don't know. . . , how long before Americans will be ready for that?

MS: In Japan today, a similar system is in use, except that, rather than removing the container and replacing it with a clean one, the truck that comes to pick up the humanure suctions it out of the container it's in. Sort of like a truck sucking the contents out of a septic tank. What they do with it after that I don't know. I also don't know whether they mix their garbage with it at home or not. (I need to travel to Asia.)

Such a truck system involves a capital outlay about a third of that for sewers. One study which compares the cost between manual humanure removal and waterborne sewage in Taiwan estimates the manual collection costs to be less than one fifth the cost of waterborne sewage treated by oxidation ponds. That takes into account the pasteurization of the humanure as well as the market value of the resultant agricultural soil additive.<sup>1</sup>

We Americans have a long way to go. The biggest obstacle is in understanding and accepting humanure and other organic materials as resource materials rather than waste materials. We have to stop thinking of human excrement and garbage as waste. When we do, then we'll stop defecating in our drinking water and sending our garbage to landfills.

It's critical that we separate water from humanure. As long as we keep defecating in water we'll have a problem that we can't solve. The solution is to stop fouling our water, not to find new ways to clean it up. Don't use water as a vehicle for transporting human excrement or other waste. Humanure must be collected along with other solid (and liquid) organic refuse produced by human beings and composted. We won't be able to do this as long as we insist upon defecating into water. Granted, we can dehydrate the water-borne sewage sludge and compost that. However, this is a complicated, energy-intensive process, and then the sludge is contaminated with all sorts of bad stuff from our sewers which becomes concentrated in the compost.<sup>2</sup>

M: It'll never happen. Face it. Americans, Westerners, will never stop shitting in water. They'll never, as a society, compost their manure. It's unrealistic. It's against our cultural upbringing. We're a society of Howdy-Doody, hotdogs, hairsprays and Ho-Hos, not composted humanure fer christsake. We don't *believe* in balancing human nutrient cycles! We just don't give a damn. Compost making is unglamorous and you can't get rich doing it. So why bother?!

MS: You're right on one point - Americans will never stop shitting. But don't be so hasty. In 1988 in the United States alone, there were 49 operating municipal sludge composting facilities.<sup>3</sup> In Duisberg, Germany, a decades-old plant composts 100 tons of domestic refuse daily. Another plant at Bad Kreuznach handles twice that amount. Many European composting plants compost a mixture of refuse and sewage sludge. A solid waste composting plant in Oregon is designed to handle 800 tons of refuse daily. There are at least three composting plants in Egypt. In Munich, a scheme was being developed in 1990 to provide 40,000 households with "biobins" for the collection of compostable refuse.<sup>4</sup>

It's only a matter of time before the biobin concept is advanced to collect humanure as well. As it is today, much of the compost being produced by the big plants is contaminated with such things as batteries, metal shards, wine bottle caps, paints, heavy metals and the like. As a result, much of it isn't useful for agriculture and has to be used for filler or for other non-agricultural applications, which, to me, is absurd. The way to keep the junk out of the compost is to value the compostable organic refuse enough to collect it separately from the other trash, and to keep the humanure out of the sewers. A household biobin would do the trick. The biobin could be collected regularly, emptied, its contents composted, and the compost sold to farmers and gardeners as a financially self-supporting service provided by independent businesses.

Some entrepreneurs have already got into the sewage composting business in the United States. In 1989, the town of Fairfield, Connecticut contracted to have its yard refuse and sewage sludge composted. The town is said to have saved at least \$100,000 in waste disposal costs in its first year of composting alone. The Fairfield operation, which is just one quarter mile from half million dollar houses, is reported to smell no worse than wet leaves from only a few yards away.<sup>5</sup>

Some say that as much as 50% of all municipal refuse could be converted into compost. However, the problem remains the same: contamination of the compost, largely due to sewage sludge contamination and inadequate or improper collection systems for organic refuse. Americans put someone on the moon in 1969, surely we can figure out the solution to making good compost today.

M: But still, there's the fear of humanure and its capability of causing disease and harboring parasites.

MS: That's right. But y'know, according to the literature, a temperature of 122°F for a period of twenty-four hours is sufficient to kill all of the human pathogens potentially in humanure. When my humanure compost pile thawed out last spring, I put two thermometers in it, one with a long (20") probe and one with a short (8") probe to see what happened with the temperature. Now this was a pile of human

manure, urine, sawdust, kitchen food scraps, and some weeds and hay. This was a pile that I never turned or worked manually in any way, except to occasionally rake the exposed outer surfaces of the pile on to the top of the pile to ensure inclusion of all the compost in the thermophilic process. I also occasionally raked the top of the pile flat, but I never manually aerated the compost. Nor did I add any compost starters or anything else. The pile was outside, exposed to the air and rain in a three sided wooden bin with an earth bottom. As soon as the pile thawed it began to heat. In a few weeks, the entire pile reached and maintained a temperature of over 120°F and stayed there for eight days. Parts of the pile stayed over 120°F for over two weeks. This spring I monitored my compost pile temperature again, after it thawed. This time it stayed above 122° for 25 days. I'm not worried about diseases or parasites in my compost at all. It doesn't seem to me that creating thermophilic compost is difficult or complicated, and that's what we need to do in order to sanitize human excrement without excessive technology and energy consumption. Thermophilic composting is something simple humans all over the world can do whether they have money or technology or not.

M: Why would the heat of a compost pile kill human pathogens anyway? I don't understand that.

MS: Human disease-causing organisms thrive in the human body, which has a temperature of about 98.6°F. They like this temperature. The natural way the body tries to destroy the pathogens is by elevating its own body temperature. That's called a fever, and the temperature rarely exceeds 104°F. Now I understand that the body raises its temperature not only to retard the growth of pathogens, but also to accelerate the growth of disease fighting components of the human bloodstream, such as white blood cells. However, the higher the temperature, the harder it is for human pathogens to survive. Not only does a high compost temperature destroy the pathogens, but it also indicates prolific microbial activity in the compost, and thereby a level of microbial competition that thwarts the growth and reproduction of microscopic animals that would rather be in someone's body than in an over-populated compost pile. When the temperature climbs to 110 or 120°F, the pathogens start rapidly dying off. Our bodies can't achieve that kind of temperature elevation, but thermophilic microorganisms can. A compost pile is like a mass of life that is having a huge fever. Pathogens are comfortable in the human body, but they can't take the heat of the compost. It's a harsh and unnatural environment for them. A killer.

Furthermore, just leaving a compost pile sit for a year will kill off almost all pathogens, *Ascaris* (roundworm) eggs being the exception. They're tough buggers, but heat will do them in. That's why I recommend letting compost heat, like a fever, then letting it sit and age. That's the one-two punch.

M: But how do you know that *all* parts of the compost pile are being subjected to temperatures sufficient to kill potential pathogens? If the pathogens are microscopic and a little piece of fecal material rolls off the pile, why wouldn't billions of pathogens in that little piece then escape the thermophilic process and live on to cause trouble another day?

MS: That's one of the most common questions I'm asked. Frankly, you *don't* know that *all* parts of the compost pile have elevated in temperature sufficiently to kill all pathogens. And you will never know for sure that every cubic centimeter of your finished compost is pathogen-free unless you analyze every cubic centimeter in a laboratory. Which few people can afford to do, and even fewer want to do. There will always be people who will not be convinced that thermophilically composted humanure is pathogen-free unless every tiny scrap of it is analyzed in a laboratory first, with negative results. On the other hand, there will always be people, like myself, who conscientiously compost humanure by maintaining a well-managed compost pile, and who feel that their compost has been rendered hygienically safe as a result. A layer of straw covering the finished compost pile, for example, will insulate the pile and help keep the outer surfaces from cooling prematurely. It's common sense, really. The true test comes with living with the thermophilic composting system for long periods of time. I don't know anyone who has done so besides myself, but after fifteen years I've found that the simple system I use works quite well for me. And I don't do anything special or go to any great lengths to make thermophilic compost other than the simple things I've outlined in this book.\*

Perhaps Gotaas (*Composting*, 1956, p.101) hits the nail on the head when he says, "*The farm, the garden, or the small village compost operator usually will not be concerned with detailed tests other than those to confirm that the material is safe from a health standpoint, which will be judged from the temperature, and that it is satisfactory for the soil, which will be judged by appearance. The temperature of the compost can be checked by: a) digging into the stack and feeling the temperature of the material; b) feeling the temperature of a rod after insertion into the material; or c) using a thermometer. Digging into the stack will give an approximate idea of the temperature. The material should feel very hot to the hand and be too hot to permit holding the hand in the pile for very long. Steam should emerge from the pile when opened. A metal or wooden rod inserted two feet (.5 m) into the pile for a period of five to ten minutes for metal and 10-15 minutes for wood should be quite hot to the touch, in fact, too hot to hold. These temperature testing techniques are satisfactory for the smaller village and farm composting operations.*" [Emphasis mine.] In other words, humanure composting can remain a simple process achievable by anyone, and need not become a complicated, hi-tech, expensive process controlled and regulated

by nervous, bespectacled academics in white coats bending over your compost pile shaking their heads and wringing their hands while making nerdy clucking sounds.

I want to make it clear though, that I can't be responsible for what other people do with their compost. If someone who reads this book decides that s/he wants to compost humanure, but wants to go about it in an irresponsible manner, then s/he could run into problems. My guess is that the worst thing that could happen is that the person would end up with a mouldered compost pile instead of a thermophilic one (I see this happen a lot), and the remedy to that would be to let the mouldered pile age for a few years before using it agriculturally, or to use the mouldered compost horticulturally instead.

I can't fault someone for being fecophobic, and I believe that fecophobia lies at the root of most of the concerns about composting humanure. What fecophobes may not understand is that those of us who aren't fecophobes understand the human nutrient cycle and the importance of recycling organic refuse materials. We recycle organic refuse because we know it's the right thing to do, and we aren't hampered by irrational fears. We also make compost because we need it for fortifying our food-producing soil, and we consequently exercise a high degree of responsibility when making the compost. It's for our own good.

Then, of course, there's the composter's challenge to fecophobes: *show me a better way to deal with human excrement.*

M: Sounds to me like you have the final word on the topic of humanure.

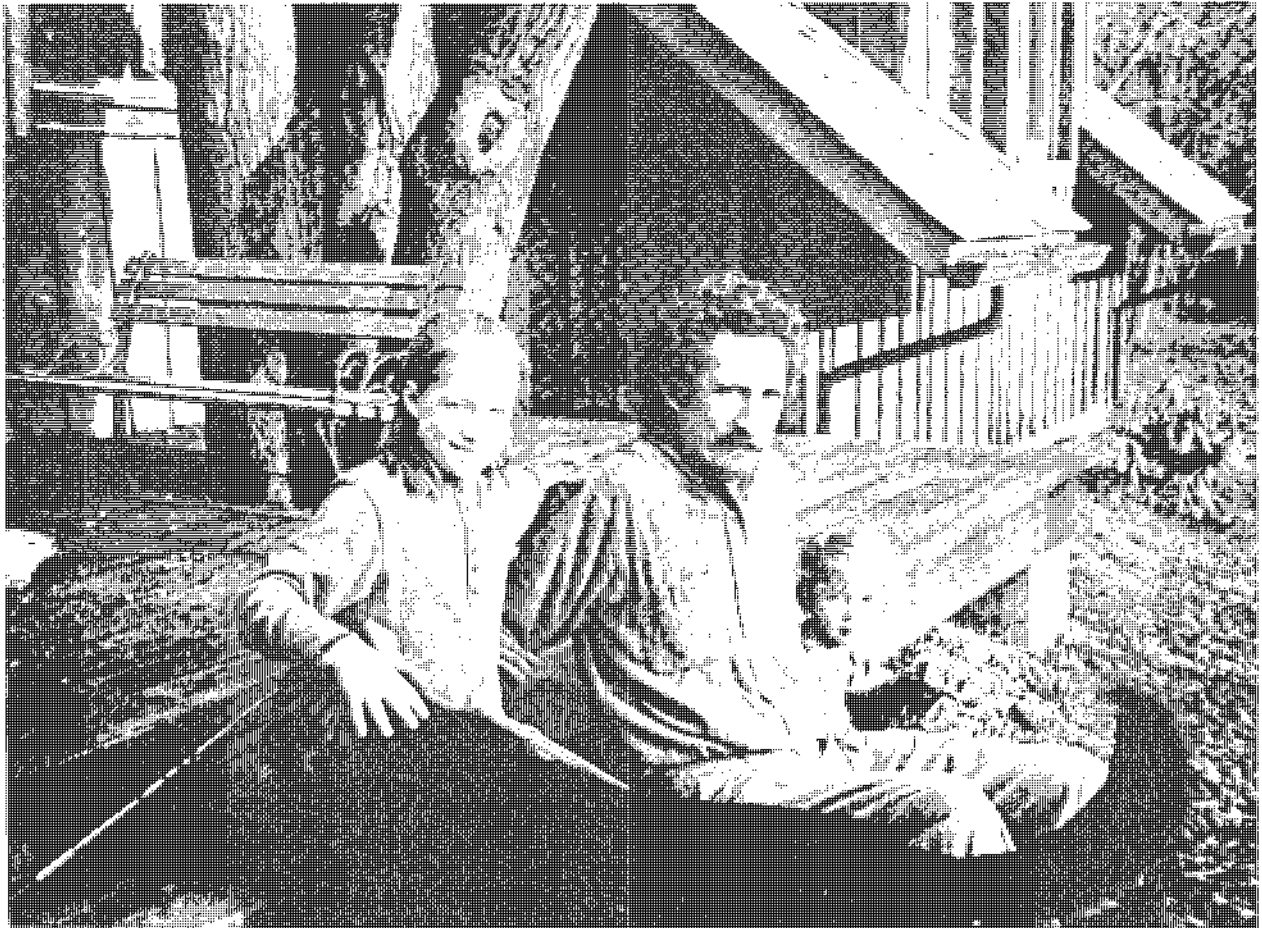
MS: Hardly. The *Humanure Handbook* is only a tiny beginning in the dialogue about human nutrient recycling.

M: Well sir, this is starting to get boring and our time is running out so we'll have to wrap up this interview. Besides, I've heard enough talk about the world's most notorious "end" product. So let's focus a little on the end itself, which has now arrived.

MS: And this is it. This is the end?

M: "*This is the end,*" (sung like Jim Morrison). Whatd'ya say folks? [Wild applause, stamping of feet, frenzied whistling, audience members jumping up and down, yanking at their hair, rolls of toilet paper thrown confetti-like through the air, clothes being torn off, cheering and screaming. What's this!?! The audience is charging the stage! The interviewee is being carried out over the heads of the crowd! Hot dang and hallelujah!]

THE END

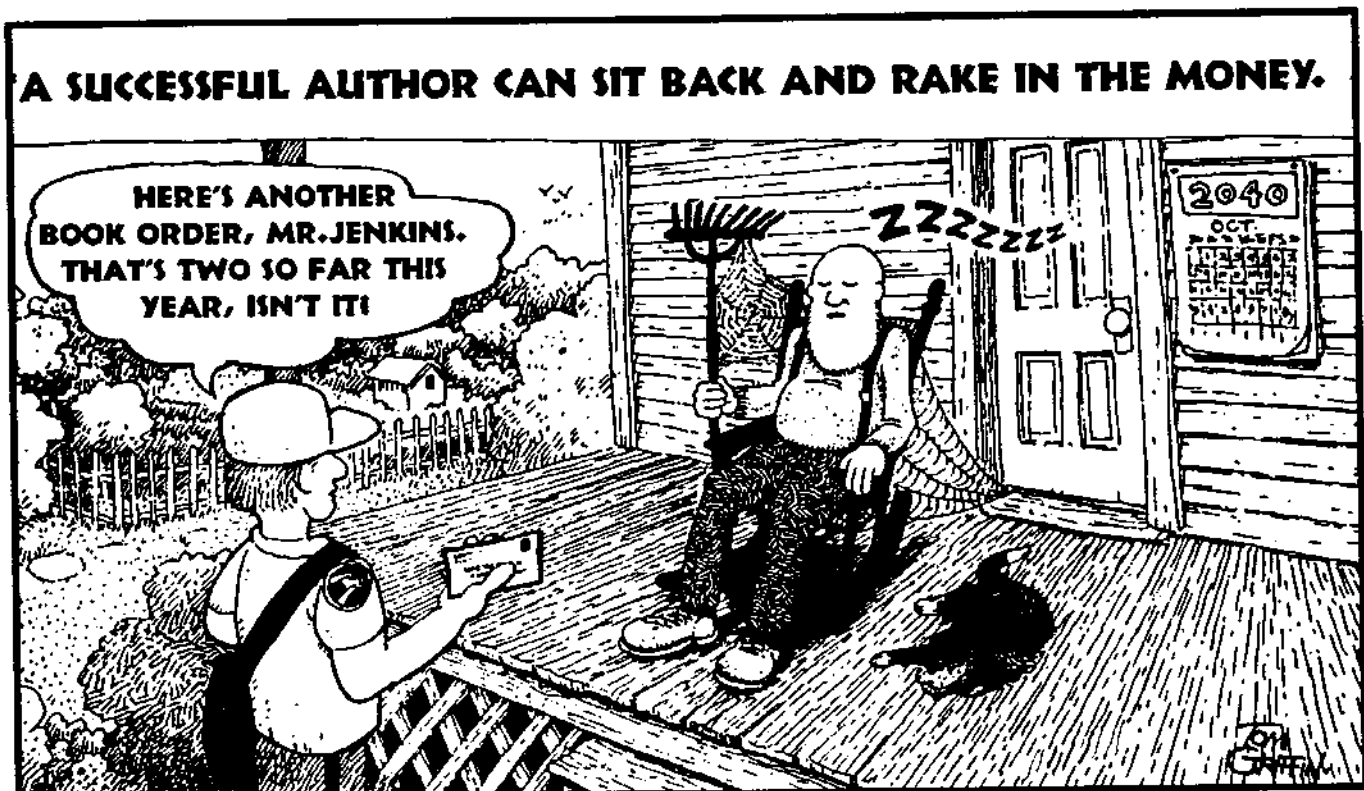


**THE AUTHOR RELAXING AT THE END OF THE DAY WITH TWO  
OF HIS CHILDREN (AND A DOG).**

*Photo by Jeanine Jenkins*

## REFERENCES - CHAPTER 8

- 1 - Rybczynski, W. et. al. (1982). Appropriate Technology for Water Supply and Sanitation - Low Cost Technology Options for Sanitation. A State of the Art Review and Annotated Bibliography. World Bank, Geneva. (p. 20).
  - 2 - Johnson, Julie. (1990). "Waste That No One Wants". *New Scientist*. 9/8/90, Vol. 127, Issue 1733. (p.50).
  - 3 - Benedict, Arthur H. et. al. (1988). "Composting Municipal Sludge: A Technology Evaluation". Appendix A. Noyes Data Corporation.
  - 4 - Johnson, Julie. (1990). "Waste That No One Wants". (p. 53) see above.
  - 5 - Simon, Ruth. (1990). "The Whole Earth Compost Pile?" *Forbes*. 5/28/90, Vol. 145, Issue 11. (p. 136).
- \* For laboratory analyses of compost contact Woods End Research Laboratory, Inc., Old Rome Road, Rt. #2, Box 1850, Mt. Vernon, Maine 04352; Phone: (207) 293-2457.





## Appendix 1: Sources of Compost Thermometers

**Real Goods** - 966 Mazzoni St., Ukiah, CA 95482-9486 USA, (800)762-7325. [They offer a thermometer with a 20" probe.]

**Pinetree Garden Seeds** - Box 300, New Gloucester, ME 04260 USA, (207)926-3400. [20" probe.]

**The Natural Gardening Co.** - 217 San Anselmo Ave., San Anselmo, CA 94960 USA. (707)766-9303. [20" probe.]

**Harris Seeds** - 60 Saginaw Drive, P.O. Box 22960, Rochester, NY 14692-2960, USA, (716)442-0100. [12 1/2" long probe.]

**Johnny's Selected Seeds** - Foss Hill Road, Albion, Maine 04910-9731 USA, (207)437-4301. [12" probe.]

**W. Atlee Burpee Co.** - Warminster, PA 18974 USA, (800)888-1447. [5" probe.]

**Edmund Scientific Co.** - 101 East Gloucester Pike, Barrington, NJ 08007-1380 USA, (609)547-8880. [8" and 5" probes.]

**A. M. Leonard Co.** - 241 Fox Dr., P.O. Box 816, Piqua, Ohio 45356 USA. (800)543-8955. [13 1/2" probe.]

## Appendix 2: Table of Linear Measures

1 meter = .....39.37 inches = .....3.2808 feet

1 foot (12 inches) = .....0.3048 meter

1 centimeter = .....1/100 (or  $10^{-2}$ ) meters = ....0.3937 inch

1 millimeter = .....1/1000 ( $10^{-3}$ ) meters = .....0.03937 inch

1 micrometer = .....1/1,000,000 ( $10^{-6}$ ) meters

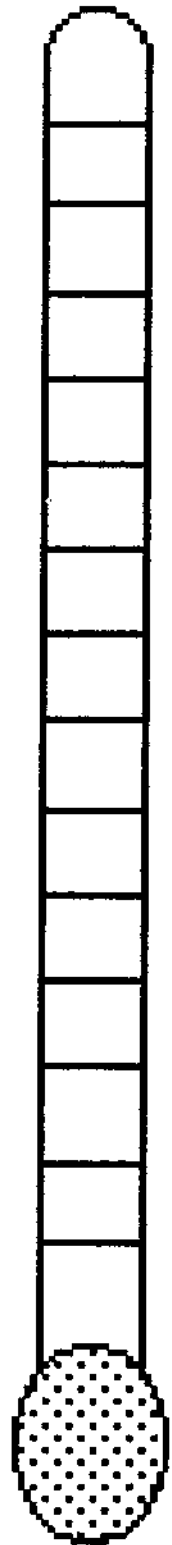
1 mil = .....001 inch = .....0.0254 millimeters

1 inch = .....2.54 centimeters

1 yard (3 feet) = .....0.9144 meter

## Appendix 3: Temperature Conversions

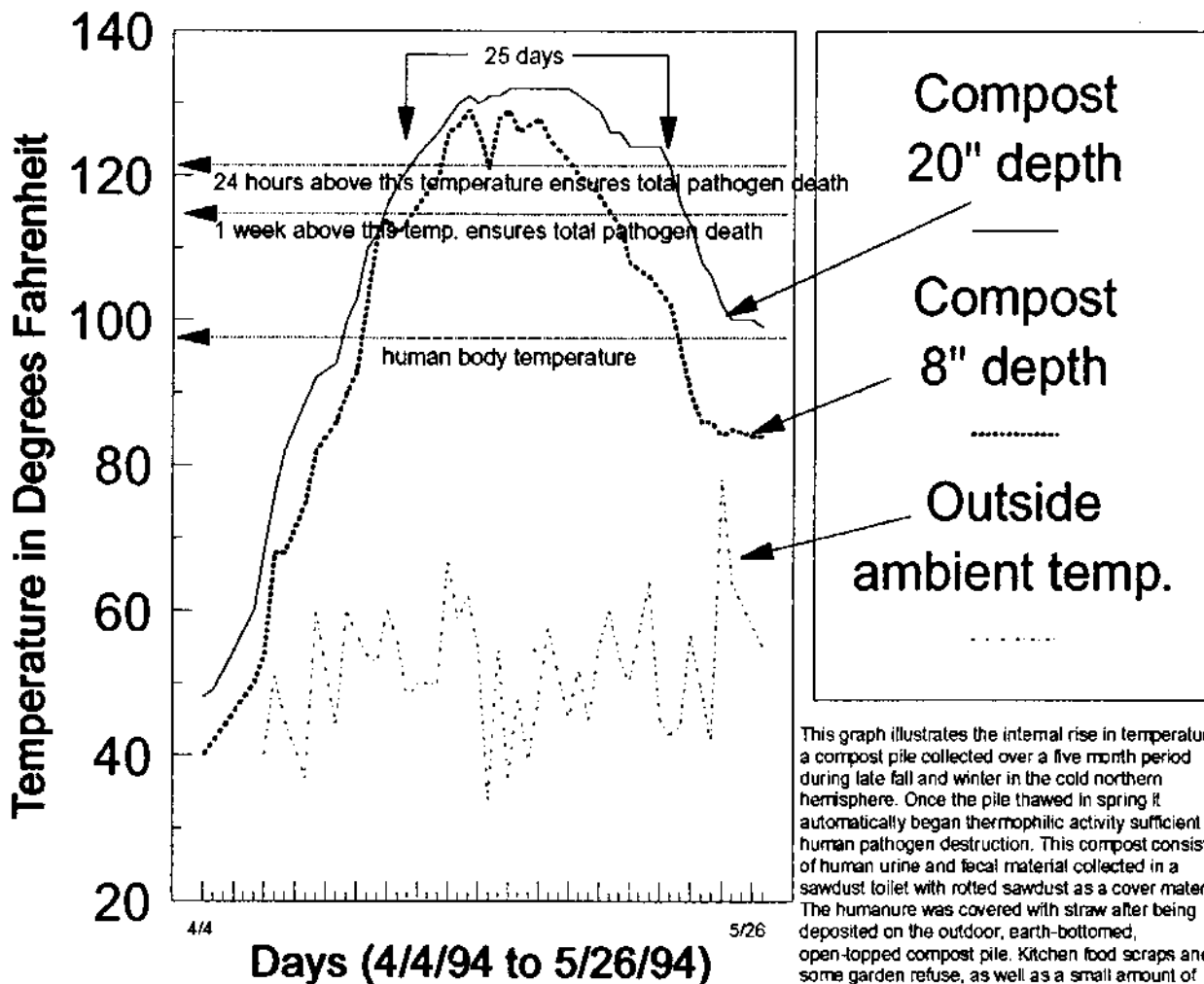
Fahrenheit	Celsius	F°	C°	Celsius	Fahrenheit
-40.....	-40	150	65.55	0 .....	32.00°
-30.....	-34.44	140	60.00	5 .....	41.00°
-20.....	-28.88	130	54.44	10 .....	50.00°
-10.....	-23.33	120	48.8	15 .....	59.00°
0.....	-17.77	110	43.33	20 .....	68.00°
5.....	-15.00	100	37.77	25 .....	77.00°
10.....	-12.22	90	32.22	30 .....	86.00°
15.....	-9.44	80	26.66	35 .....	95.00°
20.....	-6.66	70	21.11	40 .....	104.00°
25.....	-3.88	60	15.55	45 .....	113.00°
30.....	-1.11	50	10.00	50 .....	122.00°
35.....	1.66	40	4.44	55 .....	131.00°
40.....	4.44	30	-1.11	60 .....	140.00°
45.....	7.22	20	-6.66	65 .....	149.00°
50.....	10.00			70 .....	158.00°
55.....	12.77			75 .....	167.00°
60.....	15.55			80 .....	176.00°
65.....	18.33			85 .....	185.00°
70.....	21.11			90 .....	194.00°
75.....	23.88			95 .....	203.00°
80.....	26.66			100 .....	212.00°
85.....	29.44				
90.....	32.22				
95.....	35.00				
98.6.....	36.99				
100.....	37.77				
105.....	40.55				
110.....	43.33				
115.....	46.11				
120.....	48.88				
125.....	51.66				
130.....	54.44				
135.....	57.22				
140.....	60.00				
145.....	62.77				
150.....	65.55				
155.....	68.33				
160.....	71.11				
165.....	73.88				



$$F = \frac{9}{5} C + 32$$

## APPENDIX 4

### Temperature Curve of Humanure Compost After Spring Thaw



This graph illustrates the internal rise in temperature of a compost pile collected over a five month period during late fall and winter in the cold northern hemisphere. Once the pile thawed in spring it automatically began thermophilic activity sufficient for human pathogen destruction. This compost consisted of human urine and fecal material collected in a sawdust toilet with rotted sawdust as a cover material. The humanure was covered with straw after being deposited on the outdoor, earth-bottomed, open-topped compost pile. Kitchen food scraps and some garden refuse, as well as a small amount of chicken manure were also added to this compost. This pile was not turned or manually aerated in any way. No compost starters whatsoever were used.

The above graph provides an illustration that human fecal material and urine when collected in a sawdust toilet and layered on an outdoor, earth-bottomed, wooden compost bin open to the rain, covered with straw and additional food scraps, a small amount of garden refuse, and a small amount of chicken manure, will undergo thermophilic composting automatically, even after being frozen for months. No turning is necessary, although the pile should be covered with a layer of insulating material after it has thawed, such as straw, animal manures, or earth, to hold in heat. According to Gotaas (*Composting*, 1956, p. 20), disease causing bacteria are unable to survive temperatures of 55-60 degrees C (130-140F) for longer than thirty minutes to one hour. Dr. T. Gibson (*Complete Book of Composting*, J. I. Rodale, 1960, p. 650) states, "All the evidence shows that a few hours at 120 degrees Fahrenheit [approx. 50C] would eliminate [disease causing microorganisms] completely. There should be a wide margin of safety if that temperature were maintained for 24 hours." Franceys, et. al. (*A Guide to the Development of On-site Sanitation*, 1992, p.214) state, "All fecal [pathogenic] microorganisms, including enteric viruses and roundworm eggs, will die if the temperature exceeds 46 degrees C [115F] for one week. Fly eggs, larvae and pupae are also killed at these temperatures." According to Feachem, et. al. (*Appropriate Technology for Water Supply and Sanitation*, 1980), complete pathogen destruction is guaranteed by arriving at a temperature of 62 degrees C [144F] for one hour, 50 degrees C [122F] for one day, 46 degrees C [115F] for one week, or 43 degrees C [110 F] for one month. Westerberg and Wiley (*Applied Microbiology*, December, 1969) found that three days at 116 to 130 degrees Fahrenheit killed all of the polio virus, salmonella, roundworm eggs and *Candida albicans* in infected compost.

# THE HUMANURE HANDBOOK PRODUCTION STAFF



## **GLOSSARY OF TERMS**

### ***activated sludge***

Sewage sludge that is treated by forcing air through it in order to activate the beneficial microbial populations resident in the sludge.

### ***aerobic***

Able to live, grow, or take place only where free oxygen is present, such as *aerobic* bacteria.

### ***anaerobic***

Able to live and grow where there is no oxygen.

### ***Ascaris***

A genus of round-worm parasitic to humans.

### ***bacteria***

One-celled microscopic organisms. Some are capable of causing disease in humans, others are capable of elevating

the temperature of a pile of decomposing refuse sufficiently to destroy human pathogens.

### ***carbonaceous***

Consisting of or containing carbon.

### ***C/N ratio***

The ratio of carbon to nitrogen in an organic material.

### ***combined sewers***

Sewers that collect both sewage and rain water runoff.

### ***compost***

A mixture of decomposing vegetable refuse, manure, etc., for fertilizing and conditioning soil.

### ***continuous composting***

A system of composting in which organic refuse material is continuously or daily added to the

compost bin or pit.

### ***cryptosporidia***

A pathogenic protozoa which causes diarrhea in humans.

### ***enteric***

Intestinal

### ***fecophobia***

Fear of fecal material, especially in regard to the use of human fecal material for agricultural purposes.

### ***green manure***

Vegetation grown to be used as fertilizer for the soil, either by direct application of the vegetation to the soil, by composting it before soil application, or by the leguminous fixing of nitrogen in the root nodules of the vegetation.

**heavy metal**

Metals such as gold, platinum, lead, mercury, cadmium, etc., having more than five times the weight of water. Some heavy metals, when unnaturally concentrated in the environment, pose a significant health risk to humans.

**helminth**

A worm or worm-like animal, especially parasitic worms of the human digestive system, such as the roundworm or hookworm.

**human nutrient cycle**

The endlessly repeating cyclical movement of nutrients from soil to plants and animals, to humans, and back to soil.

**humanure**

Human feces and urine used for agriculture purposes.

**humus**

A dark, loamy, organic material resulting from the decay of plant and animal refuse.

**hygiene**

Sanitary practices, cleanliness.

**indicator pathogen**

A pathogen whose occurrence serves as evidence that certain environmental conditions, such as pollution, exist.

**latrine**

A toilet, often for the use of a large number of people.

**macroorganism**

An organism which, unlike a microorganism, can be seen by the naked eye, such as an earthworm.

**mesophile**

Microorganisms which thrive at medium temperatures (20-37C or 68-98.6F).

**metric ton**

A measure of weight equal to 1,000 kilograms or 2,204.62 pounds.

**microhusbandry**

The cultivation of microscopic organisms for the purpose of benefiting humanity, such as in the production of fermented foods, or in the decomposition of organic refuse materials.

**moulder (also molder)**

To slowly decay, generally at temperatures below that of the human body.

**mulch**

Organic material such as leaves or straw spread on the ground around plants to hold in moisture, smother weeds, and feed the soil.

**naturalchemy**

The transformation of seemingly value-

less materials into materials of high value using only natural processes, such as the conversion of humanure into humus by means of microbial activity.

**night soil**

Human excrement used raw as a soil fertilizer.

**nitrates**

A salt or ester of nitric acid, such as potassium nitrate or sodium nitrate, both used as fertilizers, and which show up in water supplies as pollution.

**organic**

Referring to a material from an animal or vegetable source, such as refuse in the form of manure or food scraps; also a form of agriculture which employs fertilizers and soil conditioners that are primarily derived from animal or vegetable

sources as opposed to mineral or petrochemical sources.

**pathogen**

A disease-causing microorganism.

**pH**

A symbol for the degree of acidity or alkalinity in a solution, ranging in value from 1 to 14, below 7 is acidic, above 7 is alkaline, 7 is neutral.

**pit latrine**

A latrine consisting of a hole or pit in the ground, into which human excrement is deposited. Known as an outhouse or privy when sheltered by a small building.

**protozoa**

Tiny, mostly microscopic animals each consisting of a single cell or a group of more or less identical cells, and living primarily in water. Some are human

pathogens.

**psychrophile**

Microorganism which thrives at low temperatures [as low as -10°C (14°F), but optimally above 20°C (68°F)]

**schistosome**

Any of a genus of flukes that live as parasites in the blood vessels of mammals, including humans.

**septic**

Causing or resulting from putrefaction (foul-smelling decomposition).

**shigella**

Rod shaped bacteria, certain species of which cause dysentery.

**sludge**

The heavy sediment in a sewage or septic tank.

**sustainable**

Able to be continued

indefinitely without a significant negative impact on the environment or its inhabitants.

***thermophilic***

Characterized by having an affinity for high temperatures, or for being able to generate high temperatures, such as in regard to thermophilic microorganisms.

***virus***

Any of a group of submicroscopic pathogens which multiply only in connection with living cells.

***waste***

A substance or material with no inherent value or usefulness, or a substance or material discarded despite its inherent value or usefulness.

***wastewater***

Water discarded as

waste, often polluted with human excrements or other human pollutants, and discharged into any of various wastewater treatment systems, if not directly into the environment.

***Western***

Of or pertaining to the Western hemisphere (which includes North and South America and Europe) or its human inhabitants.



**I N D E X****a**

- acid precipitation, 22
- activated sludge, 72-73, 189
- adenovirus, 113
- AlasCan toilet, 107
- aquaculture, 25
- Ascaris lumbricoides*, (see also roundworm, pathogenic worms) 89-90, 105, 114-116, 131, 161, 189
  - Survival in soil, 123, 132
  - Viability of eggs, 116, 118

**b**

- bacteria, 32, 33, 113, 189
  - Aerobic, 37, 141, 189
  - Anaerobic, 37, 189
  - Fecal, 113-114
  - Indicator, 117, 118, 121
  - Survival in humanure, 122
  - Survival in soil, 118, 120
  - Survival on crops, 118
  - Thermophilic, 138
- BHT, 45
- bins, 36, 99, 148, 157
  - Three-chambered, 159
- biobins, in Germany, 179
- bioregionalism, 140
- Black Death, 59
- BOTVIP latrine, 67
- Brown, Lester, 22
- Buddhism, 56

**c**

- camp composter, 168, 171
- carbon dioxide, atmospheric, 21
- carbon/nitrogen ratio, 38, 40, 87
  - and Nitrogen loss, 39
- cartage systems, 157
- Celsius/Fahrenheit conversions, 186
- China, 51, 79, 96, 97, 98, 112, 116, 173
- chloramines, 75
- chlorine, 18, 73-74
- cholera, 59, 61, 114, 127
- Christianity, 58, 59
- circadian rhythm, 163
- Clivus Multrum, 87, 93-95, 107
  - Analysis of finished compost, 95
  - Quantity of compost produced, 93
  - Water conserved by, 93
- C/N ratio, 38, 40, 87, 104, 105, 149, 189
- coliforms
  - Fecal, 117, 118
  - Total, 117
- combined sewers, 72, 189
- compost, 32, 33, 189
  - Aeration, 105, 147
  - Asian, 96-99
  - Benefits of, 32-35
  - Bins, 36, 99, 148, 157
  - Capacity to hold water, 32
    - and Chernobyl, 35
  - Continuous, 104, 140, 142, 148, 160, 189
  - Control of plant diseases, 33, 34
  - Covering, 37, 138, 153, 173
  - Defined, 31, 189
    - and Diesel oil, 34
  - Flat-topped, 37, 166
  - Frozen, 37, 164, 187
  - Heavy metals, 79
  - Laboratory analysis of, 181, 184

Layering, 38  
Management of, 104, 152, 166  
Materials to avoid in, 45  
Moisture content of, 35-37, 146-147  
Mouldering, 87, 88-95, 150  
Necessities for, 146-149  
Nitrogen loss, 39  
Oxygen, 104, 105, 147-149  
Piling of, 35  
Pits, 36, 98, 99  
Shrinkage, 44  
Temperatures, 37, 89, 98, 125, 131,  
133, 145, 164-169, 180-81, 187  
Thermometers, 46  
Thermophilic, 85, 87, 88, 104, 127, 141,  
143-145  
Time factor, 131, 133, 163  
and TNT, 35  
Turning of, 104, 140, 142, 148  
and Uranium, 35  
Urine in, 105, 146  
Watering, 146  
**composting** (see also compost), 24  
Active, 85  
Aeration, 105, 147  
Asian, 96-99  
Basement, 103  
Bin construction, 99, 148, 157, 159  
Cartage systems, 158  
Continuous, 104, 140, 142, 148, 160  
Experimental, 142  
Mouldering, 87, 88-95, 150  
and Oxygen, 104, 147-148  
Passive, 85, 90, 92  
Sources of information, 174  
Thermophilic, 85, 87, 88, 104, 112,  
127, 131, 138, 141, 143-145  
Time factor, 131, 133, 163  
**composting toilets**,  
Aerobic, 98-99, 104  
Anaerobic, 98, 105  
Cartage systems, 158  
Low-tech, 100  
Pathogen transmission through, 125, 127  
Plans for, 107-108

Sawdust toilet, 100, 101, 152, 153, 154,  
155, 161, 162, 165, 167, 169, 170  
Sources of, 107-108

**Confucius**, 57  
**cover material**, 87, 92, 101, 138, 146,  
148, 153, 173  
**coxsackievirus**, 113  
**cryptosporidia**, 189

## d

**deforestation**, 22  
**diarrhea**, 20, 113, 114  
**dioxin**, 74  
**disposable diapers**, 45  
**dysentery**, 114

## e

**earthworms**, 163  
**echovirus**, 113  
**Egypt**, composting of sludge in, 179  
***Escherichia coli***, 114, 117, 144  
**Europe**  
Diseases of the middle ages, 59  
**extinction of plants and animals**, 21

## f

**Fahm, Lattee**, 80  
**Fahrenheit/Celsius conversions**, 186  
**farmland**, loss of, 22  
**feces and urine**  
Raw use of, 53, 86, 112, 131  
Separation of, 41-42, 86, 91, 147  
Weight of, 52  
**fecophobia**, 41, 43, 86, 109, 189  
**fertilizers**  
Chemical, 18, 19  
Pollution from, 19

**Flatt, Hugh**, 161  
**flies**, 173  
**food**  
    Exports, 51  
    Refuse generated by American cities, 15  
**fossil fuels**, 22  
**fungi**, 143, 145, 163  
**fusarium**, 34

## **g**

**Germany**, municipal composting,  
    179  
    Biobins, 179  
**Giardia lamblia**, 114  
**Gibson, Dr. T.**, 168  
**global warming**, 21-22  
**Gotaas**, 43, 181  
**greenbelt** around Asian cities, 112  
**green manure**, 189  
**Guatemalan mouldering toilet**, 91

## **h**

**heavy metals**, 71, 77, 79-81, 190  
    transmutation, 80  
**helminths**, 113, 190  
**hepatitis A**, 113  
**hepatitis B**, 112  
**Hinduism**, 56  
**hookworms**, 121, 127, 129, 131  
**Horvath, Joseph C.**, 79-80  
**Howard, Sir Albert**, 35, 36, 48, 140, 141  
**human nutrient cycle**, 11, 12, 13, 88, 190  
**humanure**, 7, 8, 14, 190  
    C/N ratio of, 39  
    Composition of, 39  
    Dollar value, 16  
    Per square mile of arable land, 15  
**human waste**, 7, 14, 21, 24, 25, 53-54  
**humus**, 31, 32, 145, 190  
**Hunzas**, 35, 110

## **i**

**India**, 99, 140, 142  
**indicator bacteria**, 117, 118  
    Survival in humanure, 121  
**indicator pathogens**, 116, 190  
**Indore process**, 140, 141  
**inks**, 46, 50

## **j**

**jail fever**, 59-60  
**Japan**, 51, 173, 178  
**Jews**, torture of, 59

## **k**

**Kervran-Effect**, 80  
**King, Dr. F. H.**, 52, 173  
**Korea**, 51, 65, 173

## **l**

**landfills**, 15, 78-79  
**latrine**, 190  
    double pit, 161  
    (see also Vietnamese double vault)  
**legalities**, 170  
**Leptospire**s, 120, 127  
**lime**, 38, 47-48, 140, 142, 162  
**Lovley, Derek**, 35  
**Lubke, Sigfried**, 35

## **m**

**macroorganisms**, 145, 190  
**Marino toilet**, 42

**mesophile**, 143, 144, 190  
**metric conversions**, 185  
    ton, 190  
**microwave toilet**, 81  
**microhusbandry**, 29, 190  
**Miquel**, 144  
**moulder**, 190  
**mouldering toilets**, 29, 86-95  
    Commercial, 86, 92, 95  
    Guatemalan, 91  
    Non-commercial, 86, 88-90  
    Transmission of pathogens through, 125, 127  
**mulch**, 30, 190  
**Multrum toilet**, 92-94  
    Transmission of pathogens through, 125, 127

## **n**

**Native Americans**, 60  
**naturalchemy**, 31, 190  
**newspapers**, 45  
**night soil**, 7, 25, 29, 51, 53, 58, 112, 158, 191  
**nitrates**, 18-19, 123, 191  
**nitrogen**, 52, 95, 162  
    loss, 39  
**Norway**, 92

## **O**

**odor elimination**, 37, 87, 101, 151, 156, 172  
**oil reserves**, 51  
**organic**, 191  
**organic refuse**, 31  
**outhouse**, 66  
    Pathogen transfer through, 123  
**oxygen**, 38, 104, 105, 125, 147, 148  
**ozone**, 21

## **p**

**Pakistan**, 110  
**parasites** (see pathogenic worms)  
**paratyphoid**, 113  
**pathogen**, 191  
**pathogenic worms**, 113, 114-116, 118, 126-131, 161  
    Eggs, 116, 118, 131  
    Fecal, 114, 115  
    Survival in humanure, 122  
    Survival in soil, 118, 121  
**pathogens**, 29, 111  
    Defined, 87  
    Eliminating from humanure, 122  
    Indicator, 116  
    Persistence in crops and humanure, 117  
    Persistence in soil, 118  
    Survival in thermophilic compost, 127  
**pH**, 33, 47-48, 162, 191  
**phosphorous**, 19, 53, 95, 162  
**phytophthora**, 34  
**pinworms**, 127, 128  
    Eggs in feces, 128  
**pit latrine**, 66, 191  
    Ventilated improved, 67  
    Pollution from, 66, 68  
    Pathogen transfer through, 123  
**Plague**, 59  
**poliovirus**, 113, 120  
**population growth**, 22  
**Postel, Sandra**, 21  
**potassium**, 19, 53, 95, 162  
**pour flush latrine**, 67  
**pressure treated lumber**, 156  
**protozoa**, 113, 191  
    Fecal, 114  
    Survival in humanure, 122  
    Survival in soil, 118, 119  
    Survival on crops, 118  
**psychrophile**, 143, 191  
**pythium**, 34

# r

**recycling**, 15  
**reovirus**, 113  
**Rodale, J. I.**, 48  
**Rodale, Robert**, 140  
**rotavirus**, 113  
**roundworm**, (see also *Ascaris*, pathogenic worms) 89-90, 98, 105, 121, 127, 130, 131, 161  
**Rumpelstiltskin**, 31

# s

**Salmonella**, 113, 114, 118, 127  
**sand mound**, 69  
**sanitary napkins**, 45  
**sawdust**, 40, 41, 44, 151, 155, 156  
**sawdust toilet**, 100-102, 153, 154, 155, 161, 162, 164-165, 167, 169, 170  
Quantity of sawdust required for, 155  
**Scandinavia**, 92  
**schistosome**, 131, 191  
**septic**, defined, 70  
**septic systems**, 68-71, 171  
Pollution from, 70  
and Population density, 71  
**septic**, 70, 191  
**septic tank**  
Capacity, 68  
Cross-section, 68  
Distribution system, 69  
Pathogen transfer through, 123  
**sewage pollution**, 16, 17  
Beaches, 16  
Ocean dumping, 17-18  
**sewers**, (see also wastewater treatment)  
Combined, 72  
Pollutants in, 77  
Cost comparison to manual collection, 178  
**shigella**, 113, 114, 127, 191  
**Sides, S.**, 33

**sludge**, 73, 191  
Activated, 72-73  
Agricultural use of, 76-78, 83  
Bacteria resistant to antibiotics in, 78  
Composting in Egypt, 179  
Composting in U.S., 178, 179  
Forest disposal of, 78-79  
Heavy metals in, 77, 79-80  
Incineration of, 81  
**solar greenhouse wastewater treatment**, 76  
**stool analysis**, 116-117, 122, 129, 130, 162-163  
**Streptococci**, 120  
**Sun Mar toilet**, 107  
**sweating sickness**, 59  
**sustainability**, 9, 23, 55, 191  
**synthetic organic compounds**, 70, 71

# t

**Tao**, 57  
of Compost, 139, 140  
**temperature conversions**, 186  
**temperature of compost**, 37, 89, 98, 125, 131, 133, 145, 164, 168, 169, 180, 181, 187  
Required for pathogen death, 145, 125, 133, 187  
**Tester, Cecil**, 48  
**thermometer**  
Compost, 46  
Sources of, 185  
**thermophilic**, 192  
**thermophilic bacteria**, 138  
In humanure, 144  
**thermophilic composting**, 29, 38, 43-44, 58, 138, 143  
Conditions required for, 142  
Transfer of pathogens through, 125, 127  
**thermophilic microorganisms**, 143, 144  
Number in humanure, 144  
**time factor** in compost, 131, 133, 162-163  
**toilets (see also multrum, mouldering)**  
Botvip latrine, 67  
Double pit, 161

Guatemalan mouldering toilet, 91  
Microwave, 81  
Marino, 42  
Multrum, 92-94  
Outhouses (see pit latrines)  
Pit Latrines, 66-68 (see also separate list  
-ing)  
Pour-flush latrines, 67  
Sawdust, 100-102, **153**, 154, 155, 161,  
162, 164-165, 167, 169, 170  
Transmission of pathogens through  
composting toilets, 127  
Water consumption of, 18  
**toilet paper**, 44, 73  
**topsoil**, 33  
Loss, 22, 51  
**Tsu, Lao**, 57  
**turning of compost**, 140, 142, 147, 148  
**typhoid**, 59, 113, 120

## U

**urine** (see also feces/urine)  
Pathogens in, 112  
In compost, 105, 146

## V

**vaults**, 98  
**vibrios**, 114  
**Vietnam**, 96, 98-99  
**Vietnamese double vault**, 99, 161  
**viruses**, 113, 127, 192  
Fecal, 113  
Survival in humanure, 121  
Survival in soil, 118-120  
Survival on crops, 128

## W

**Ward, Barbara**, 80

**waste**, 7, 21, 192  
Reduction, 23, 54  
Solid waste generated in U.S., 14, 21, 23  
**waste stabilization ponds**, 124-125  
Transmission of pathogens through, 125  
**wastewater**, 192  
**wastewater treatment plants**, 72, 73, 123,  
124  
and Chlorine, 73  
Solar greenhouse, 76  
Transfer of pathogens through, 124  
**water**  
Consumption, **20**  
Pollution, deaths from, 20  
Testing, 117  
**wetlands**, constructed or artificial, 75, 76  
**whipworms**, 130  
**White, Andrew D.**, 59  
**winemaking**, 30-31  
**witches**, 59, 109  
**wood ashes**, 47, 162  
**Wood's End Laboratory**, 46, 135, 184  
**worms** (see pathogenic worms, also  
*Ascaris lumbricoides*, hookworm,  
roundworm, whipworm, pinworm,  
helminths)

## y

**yeasts**, 32  
**yersinia**, 114  
**Yucatan**, 65

## Z

**Zen**, 57

# **THE ORGANIC WAY TO MULCHING**

**by the Editors of  
ORGANIC GARDENING and FARMING**

*ROBERT RODALE, Editor*

*JEROME OLDS, Executive Editor*

*M. C. GOLDMAN, Managing Editor*

*MAURICE FRANZ, Managing Editor*

*Compilation Supervised by*

**GLENN F. JOHNS**

*The paper in this book has been made from waste paper that normally winds up at the city dump. This reclaimed paper is an example of how today's wastes can be converted into a worthwhile resource, thereby helping to solve the solid waste disposal crisis and preserving the quality of our environment.*

---

**RODALE PRESS, INC.**

**Emmaus, Pa.**

---

# CONTENTS

*Introduction: There's More To Mulch Than Meets The Eye! . . .*

## CHAPTER

1. Mulch— Tool of the Best Doggone Organic Gardeners . . . . .	1
2. Mulch and Your Soil . . . . .	14
3. Mulch and Your Garden . . . . .	34
4. Mulching Materials . . . . .	52
5. Stone Mulching . . . . .	81
6. Why We Reject One of the Most Common Mulches	101
7. There's Method in This Mulching . . . . .	115
Appendix I . . . . .	138
Appendix II . . . . .	144
Index . . . . .	187

Standard Book Number 0-87857-009-8

Library of Congress Catalog Card Number 70-170280

Copyright 1971 by Rodale Press, Inc.

All Rights Reserved

Printed in the United States

OB-50

First Printing 1972



# INTRODUCTION

There's More To Mulch Than Meets The Eye!

Mulch is a layer of material, preferably organic material, that is placed on the soil surface to conserve moisture, hold down weeds, and ultimately improve soil structure and fertility.

There's more to mulch than meets the eye. Be it a fluffy blanket of hay, a rich brown carpet of cocoa bean shells, or a mantle of sawdust, that "topping" for the vegetable patch and flower bed serves as much more than frosting on the garden cake.

**Mulch acts.** It performs in several wondrous ways. It fills a role as protector of the topsoil, conservator of moisture, guardian against weather extremes and comfortable, bruise-saving cushioner under ripening produce. It prevents weed growth while enriching the soil and all but eliminates a lot of those time-consuming, back-aching jobs like plowing and cultivating always consid-

ered necessary for a productive garden.

Another important advantage of mulching is regulating the temperature of the soil. The mulch tends to be an insulator, which means that during many periods of the year it moderates the temperature of the soil beneath. In winter a mulched soil can be warmer than other ground, and in summer it can be cooler.

Mulching around trees prevents competition by grass for moisture and nutrients. Trees, and in fact most plants, need a tremendous amount of moisture during hot weather, especially. If grass and other plants are growing right up to the trunk, they will take the moisture first and leave less for the tree. Mulching is the easiest and most attractive way for the average gardener to keep that from happening.

If you're serious about your garden, you've long ago thrown away your bags of commercial fertilizer and have started to build real productivity into your soil. And the fertility of your soil depends upon how you're able to get humus into it. That's really what mulching is all about.

Most mulching benefits can be obtained by any kind of ground cover—even the plastic sheets which are such a detriment to the welfare of our environment. But when it comes to improving the soil, nothing can do it like an organic mulch—not aluminum foil, not plastic, not polyethylene film. Organic mulches have a plus—they decompose into the essential life-giving elements of a rich, dark humus.

Plants themselves literally demand to be mulched because that's the way they've been able to survive repeated disasters through the ages. Spontaneous mulch-

ing has been going on for a long time—millions of years—by the time man first began to raise a few favored crops about 15,000 years ago.

Snow is not the only mulch that Nature has been using for all those centuries. We also know that leaves cover forest and woodland areas to protect the soil and feed its inhabitants. As the leaves fall to the forest floor, forming the basis of nature's mulch protection, they also decompose into a compost that makes up a rich soil-rebuilding program of nature. Out in the open fields, dead tops and foliage of the annual plants fall over to cover the ground and protect it from the rigors of winter.

This fact is important: composting and mulching go hand-in-hand and are, in many instances inseparable. Remember that in dealing with your soil. The aim is to build and maintain nature's complete soil pattern as far as possible. That demands a good organic mulch. The soil in your garden, whether you know it or not, is a world teaming with living things, whose combined activity enables the soil to grow plants.

In nature's scheme of things, as the dead remains of once living things gradually decompose, they return to the earth to be used again in a continuous cycle of life. Our soil will find itself undergoing conservation much more extensively and will be used more efficiently when we see Nature's pattern of natural mulching with its benefits according to the levels of soil fertility concerned. Mulching alone, as a mechanical ministrations, cannot offset completely the shortage of fertility in the soil. Conversely, building up the fertility can be all the more reason for mulching also, a combination with dou-

bled benefits because of the more efficient use of both the soil and the mulch that covers it. Of course, Mother Nature doesn't till or disturb her soil, except by using earthworms, insects and plant roots.

So, it's pretty apparent today that you're missing out on a lot of good gardening if you don't mulch—and mulch with whatever is cheap and handy. Leaves contain twice as much plant food as barnyard manure—pound for pound. Buckwheat hulls are fine, but so is hay. Sawdust will keep the weeds down and the soil moist, but be sure you add some form of nitrogen if you're going to raise a crop right away.

Our cumulative experience—and we already have well over a quarter of a century of it—and the experience of our readers has taught us to use whatever is cheap and abundant locally, to use it to get practical results and to solve our own gardening problems. We have learned to be our own “experts” and to think for ourselves.

And we've learned to mulch!

So, keep on mulching with whatever comes to hand—leaves, straw, hay, grass clippings, weeds, crop residues. Remember that the more humus you get into your soil, the better the crops you grow—while you're knocking the pesticides and herbicides out of your soil that somebody else put there.

Better break out the organic covering and start mulching—*now!*

## Chapter One

# MULCH—TOOL of the BEST DOGGONE ORGANIC GARDENERS

Constant correspondence with people who garden the organic way tells us they all agree that mulch is a must—and each for his own reasons. A Michigan gardener discovered it prevents weed takeovers. Another likes the hardiness it gives her plants against storms, while a desert-dweller lauds its ability to retain moisture for his garden.

Harold Fleck, the Michigan resident, found he could leave his garden unattended for periods of time during the summer without adverse effect. His mulch prevented weeds from crowding out his plants.

He was fortunate in that his garden area lay adjoining a field that was combined for clover seed the previous fall. After passing through the combine, the hay lay on the ground over winter. Fleck decided to use this handy supply of material for mulching. Early in the spring the

garden was plowed as usual. Then it was worked with a rotary tiller. As the various seeds were planted, the hay was placed between the rows of planted seeds. When the small seedlings came up, the hay was moved nearer to them. Finally, the whole garden was covered with hay.

"This new type of gardening has restored my once flagging interest in gardening," Fleck said, "The benefits were far more numerous than I had dreamed. The following are a few of the advantages I discovered:

*"Neatness.* It was always a problem to have a neat borderline between the grass of the lawn and the garden. Mulching solved this. Running the rotary mower right up to the mulch leaves no line of unmowed grass between the grass and the mulch. That narrow line of unmowed grass was always a problem before mulching.

*"No drought effects.* Although we had some very dry weather last summer our mulched garden did not show the effects of it. Our sweet corn did not 'roll' during the hottest days of the dry-weather period.

*"Pests subdued.* Before mulching, the beetles would ruin our lima and string beans. Last summer it was different. There were a few beetles, but they were too few to damage our production. No chemicals were used.

"It is wonderful to be able to walk out into the garden without getting dirt and dust in your shoes. The mulch is a soft and clean carpet to walk on. It is also a blessed relief to be free from the battle with weeds."

Fleck's experience also taught him that his mulch offered protection for his plants during bad weather and frost. When he feared an early frost was in the offing, he merely covered his plants with some straw in the

evening, removing it in the morning. But Dorothy Schroeder's experience with mulch as a plant saver was more extensive. Hers involved a heavy storm.

"We should have known that it would happen after a completely rainless spring and early summer," she explained.

"Well, the day arrived when the rain came, a cloud-burst pouring down four inches of water in a little over an hour. It roared down the canyon east of the house in a white curtain, egged on by a 70-mile wind. During the worst of it, hail pelted the garden. Cracking branches of the old cottonwood trees were inaudible in the greater noise of the storm, so that we were surprised to find tree-sized limbs blocking both exits when the tempest stopped," she continued.

"After we had sawed a path through, we found what looked like complete devastation. The corn was flattened to the ground; the beautiful big crisp leaves of the summer squash and zucchini we'd been so proud of were broken and mud covered, soaked into the ground. The tomato supports had been broken or pulled out, and many tomato branches were broken off. Pepper plants were bent in the middle, their blooms stuck in the mud. The crisp green lettuce was reduced to mush.

"The first comfort I found in this devastation was that no water had run off my garden," Mrs. Schroeder said.

"Although our home is on a fairly steep hillside, the rain soaked into the mulch-covered soil while my neighbors's topsoil ran away in brown streams, clogging the drains and making extra work for the street department, and pointing out a valuable lesson. My neighbors

complained that the rain was like the pounding of hammers on their soil; nothing soaked in and the ground was left like asphalt. My soil was cushioned by the mulch and there was no pounding.

“In general I learned from that storm that what seemed like complete devastation could be only a few days’ setback if I moved in quickly”, she continued. “I learned, too, that the plants growing in the best soil, richest in compost and most heavily covered with mulch, suffered least. That was brought home to me by the two potato patches. I planted one in the ‘new’ part of the garden, not yet prepared organically. For the other I used decayed leaf mold, planting the potatoes in a heap of it 18 inches above the level of the garden, between two thick layers. These potato plants weren’t injured at all, but stood straight and tall after the storm. The others were beaten down to the ground,” Mrs. Schroeder said.

“I also learned a lesson from a stone-mulched tomato. I had set the plant in a slight depression in the ground, and instead of staking it I had killed two birds with one stone by piling around it the rocks that I would have otherwise had to cart away, both to mulch it and to keep the branches off the ground. That was the first of the tomatoes to recover, with more of its leaves returning to their former healthy condition than I’d have thought possible. I was surprised, too, at how little the injured leaves affected the fruit bearing. Fruit bore better with their leaves whole, it’s true, but production went on when they were ragged and full of holes,” she explained.

Even more telling, Mrs. Schroeder said, was something that didn’t immediately occur to her. “The roots weren’t hurt at all. That, of course, accounted for the quick recovery of so many of our injured plants.”

Ruth Tirell, a longtime organic gardener from Massachusetts, found through experience that a mulch works its wonders as well in the opposite extreme of weather—drought. Although the drought she experienced was unusually long and severe, no crop was a total loss. But the contrast between the plants that grew in bare, exposed soil and those that had been mulched was revealing. The favored crops which were mulched—tomatoes, summer squash, cucumbers and melons—all flourished and grew as if there were no drought.

The beans were another story. Compared to tomatoes, they have simple requirements—moderately good soil, some extra nourishment like compost in the furrow. She planted beans in late May. A little of the winter mulch was still visible; she didn’t add to it—her beans had always done well enough.

June that year brought scant rain, only sprinkles. While, for various reasons, Mrs. Tirell didn’t have much time for the garden, she did notice that the beans weren’t growing fast. Still, she didn’t water them. At maturity in July, the bean plants were stunted and the yield small, so she pulled them up. Usually her beans go into a second—and sometimes a third—blossoming and bearing.

Beets and carrots planted early in May were another example. Getting some quick growth before the drought

started, they then seemed literally to stand still in the dry, baked, unmulched ground. All she got at harvest time were stunted, tough beets.

By contrast, the tomato patch was lush and green. Under the permanent mulch, the soil actually felt moist. The beans, the beets and carrots had all been planted in the same small garden, got the same treatment as the tomatoes—up to a point. All her crops, when planted, were given compost in the hole or furrow. But to nourish a plant, compost must be made soluble. During that long period when there were practically no rains, only the few crops she had kept mulched were really being fed.

In mid-July Mrs. Tirell made a test planting with summer squash, which she always starts at that time to take over in September when the early-planted crop is pulled up. She has found the new plants bear better fruit. She made two hills, treating both alike at first, digging in plenty of dried manure and compost, soaking the hills thoroughly on the day before and again on planting day.

Sowing the Seneca Buttercrunch hybrid, she left one hill bare but mulched the other with grass clippings. The next day she watered again, lifting the mulch on the second hill. She continued to water until the seeds sprouted at about the same time for both hills.

The mulched hill got no water from then on, except when she added to the mulch, while the bare-soil hill was watered every other day. Despite this neglect, the mulched plant grew faster during a period of practically no rain than the unmulched-but-watered-hill. It matured sooner, was bigger, leafier and more prolific—7 to

8 little squashes forming at one time and growing into healthy, big but tender, maturity. By contrast, the fruit from the unmulched hill were rather small and stringy.

At the height of the drought, about August 1, she made another test planting, this time with lettuce seedlings. While all were dressed with compost and the soil was soaked, half the seedlings were mulched and half were not.

When the unmulched lettuce was watered every day, the encrusted soil had to be broken with a hoe—which meant lots more work—so it would absorb the water. But the mulched lettuce was practically no trouble. Grass clippings were added once or twice, first soaking the old mulch which was dry on top but moist underneath. The unmulched lettuce succeeded—after all the care it had received—but the mulched plants succeeded even more, forming bigger, thicker, and more tender hearts to live up to Buttercrunch's reputation.

Like other organic gardeners, Ruth Tirell had known that mulches conserve moisture, but until that summer of abnormal drought, she hadn't seen with her own eyes the difference mulches do make at harvest time. From now on, she's joining other converts, like Arizona dweller Harold Rawson, and keeping her garden mulched year-round. Rawson joined the corps of converts when he found a combination of composting and mulching to be the best solution to the problem of gardening in a desert.

"Our mulch performs best when moist," Rawson said. "Evaporation cools the soil and plants just as our inexpensive evaporators cool many homes. But the mulch loses its moisture quickly in the desert sun, and

this beneficial effect is lost. I've found that a screen wire held above smaller plants with a simple frame makes an excellent sun filter. The screen also offers considerable protection from the hot winds that blow in from the desert. Its only drawback is that it is not very attractive. Most of our garden takes a needed rest during the summer. Otherwise, we have no problems with our annual beds or the vegetable garden. During the enforced



A mulch of lawn clippings decomposes, converts to humus and enriches soil.

siesta, we thoroughly soak the soil to a depth of two or three feet, and then add compost, spading it in deeply and watering it. Anything that will add humus to the rather sparse earth is used—table scraps, composted crop residues and manure which we also use as a mulch. Thanks to our soil rebuilding program, the rows and beds are alive with earthworms most of the year," he added.

"With this preparation we have magnificent displays of flowers during March, April and May," Rawson continued, "And we do have delicious vegetables during the winter, plus some tomatoes and sweet corn in early summer.

"Growing roses and some shrubs creates perplexing problems here. Considerable composted material is used in the planting hole as a soil conditioner. Plants do very well for a couple years, then trouble starts. The acid reaction is lost as time passes, drainage may be impaired, and the leaves show salt damage. How do we restore healthy soil balance and functioning?

"We apply new mulch in liberal amounts, removing the old and spreading it around the garden," Rawson said. "Then we water deeply to wash the harmful salts down and out of the root zone. Since the bushes need more fertilizers to replace lost nutrients, I add manure and liquid fish solutions.

"When we came here five years ago, I was a bit confused by the problems confronting the desert gardener. While I may still be confused, one thing I'm firm about is this—mulching and composting combined is the surest way to gardening success in this hardpan country."

The grand old lady of mulching is without a doubt Ruth Stout. Ever since she moved to Redding, Connecticut back in 1929, Miss Stout has been dazzling her neighbors with her gardening technique. It's a unique one, because it succeeds despite the fact that she doesn't plow, harrow, spade, hoe, weed or cultivate.

Just what is this gal's secret? Very briefly, it's an over-all year-round mulch, and a thick one at that. Six to eight inches of hay, weeds, paper and garden wastes placed around every flower and vegetable, shrub and tree. It is never turned under, never disturbed; it is, in effect, a constantly decomposing compost pile spread over all the places where rich earth should abound.

"Right under the mulch you'll find earthworms crawling around in the moist earth in the driest weather," she said. "It defeats the drought; it does away with all the heavy work of gardening. And it can improve your garden's appearance.

"Now let's say you want to start a garden in a spot which is now sod, or full of perennial weeds," she explained. "If you mulch it heavily in early fall it will be rotted sufficiently by spring so that you can put in a garden without bothering to plow. It's possible that for small seeds you may have to do a bit of sod-shaking but nothing like what has to be done if one plows sod in spring and then tries to plant.

"For tomatoes, or any other crop which calls for putting in plants instead of seeds, nothing could be simpler," she said. "Pull back the mulch a bit and stick the plant in the ground. And for things grown from seed but which should be thinned to 12 or 18 inches apart, such as the cabbage family—well, you can plant these

in hills, a few seeds in each spot, thinning them later to one plant.

"Onion sets may just be scattered around on last year's mulch, then covered with a few inches of loose hay; by this method you can 'plant' a pound of them in a few minutes, and you may do it, if you like, before the ground thaws. Lettuce seeds, too, will germinate if merely thrown on frozen earth—but not on top of mulch. And this, of course, can't be done if you plow before planting.

"Many people," Miss Stout said, "have discovered that they can lay seed potatoes on last year's mulch, or on the ground or even on sod, cover them with about a foot of loose hay, and later simply pull back the mulch and pick up the new potatoes.

"A few weeds may come through your mulch here and there; this will be because you didn't apply it thickly enough to defeat them. They are easy to pull if you want to take the trouble, but the simplest thing is to just toss a bit of hay on top of them," she said. "And if a row of something needs thinning, this can be done effectively by simply covering the plants you want to get rid of with a little mulch."

There are other benefits, too. She hasn't sprayed her garden for years but hasn't had pest problems. The crows, she said, are nonplussed by the heavy layer of mulch over her corn. And she hasn't used fertilizer for years, either. "After you have mulched for a year to two," she said, "you will need no fertilizer of any kind except perhaps for a little meal (cottonseed, soybean—whatever you can buy) for nitrogen. The rotting mulch supplies all the nourishment your plants should have.



“A word of caution: after your soil has become so nearly perfect because of so much rotting mulch in it, you may be swamped with the quantity of your crops.”

It was just this sort of Ruth Stout warning that got Dorothy Anderson, a Wisconsinite, moving. She decided that if Ruth Stout could garden from her couch, so could she. At any rate, she had nothing to lose by giving it a try.

“In our garden, head lettuce was tennis-ball size; cucumbers, exhausted fending off the cucumber beetles, stretched only to fountain-pen length. And strawberries—well, it might take 50 to fill one English teacup,” Mrs. Anderson explained. But after she and her family started mulching, it seemed that she was merely replacing one evil with another.

“Pleasure driving through the country ceased to exist,” she explained. “My eye spied any spoiled hay within a block of the highway. After hectic dickering with the owner, we loaded the car with mulch. It’s heavy, dirty and scratchy—but what does that matter compared to salvaging two whole bales of spoiled hay?”

“The first two bales spread in the middle of the garden looked as lonesome as a fly in the middle of a duck pond. When we tried to cover our 30-by-80 foot garden with mulch, it suddenly expanded to city-park size.

“Mulching took on the attributes of a nightmare. The garden opened its jaws and gulped down mulch far faster than we could provide it. When we walked down the rows of mulch it snapped, crackled and shrank. When it rained, the mulch became soft and gushy and shrank. When the sun dried it, it shriveled and shrank. Under the winter snow it all but disappeared,” she said.

“In the spring the need for more mulch to cover the garden’s nakedness was renewed. The old nightmare chugged and chased our heels. If Ruth Stout could do it, why couldn’t we? We hauled in sawdust, spoiled hay, more sawdust, marshgrass, wood chips, spoiled hay. We salvaged the cut grass along the roadside. Every leaf that blew in the wind was gathered and added to the mulch. Every blade of grass, every weed, was pounced on for mulch.

“After 5 years of constant mulching my temperature has subsided to normal. I, too, lie on my couch by the window and anticipate the first head of lettuce sprouting a blue ribbon from its leaves, and I picture a new garden cart sturdy enough to haul to the house the 30-pound Blue Hubbard squash,” she continued.

“My anticipation of a beautiful garden has truly been realized. The giant heads of Boston lettuce actually did bring in a blue ribbon. With the drought we’ve had in Wisconsin for the last 7 summers, this would have been impossible without mulching.”

Dorothy spoke for all mulchers when she concluded, “The proof of its value is under the mulch. The earth is soft, moist and full of earthworms (just as Ruth Stout said). I have longed for a garden soil so soft that I could scoop out a trench for seeds with my hands.

“My dream has come true; *the mulch made it possible.*”

## Chapter Two

# MULCH and YOUR SOIL

Mulching will improve any type of soil, generally speaking. But before using fertilizers you should know something about the make-up of *your* soil.

What kind of soil do you have? That's an easy question to ask, a difficult one to answer. Replies could vary from "hard as a rock" or "a sandy loam with a pH of 6.5" to "a deep soil of podzolic origin."

To some people, soil is nothing more than dirt that's perfectly okay as long as it allows flowers and most of the lawn to grow, and when muddy, doesn't get the house or patio too messed up.

Fortunately, to the majority of us, our soil represents a great deal more than that. Unscientific as it may be, we still regard soil as a living, breathing organism with definite likes and dislikes. It has a personality all its own

—depending upon its past history, treatment and present environment.

In the *Yearbook of Agriculture*, published by the U.S. Department of Agriculture, Roy Simonson writes:

"Soil is related to the earth much as the rind is related to an orange. But this rind of the earth is far less uniform than the rind of an orange. It is deep in some places and shallow in others. It may be red, as soils are in Hawaii, or it may be black, as they are in North Dakota.

"Be it deep or shallow, red or black, sand or clay, the soil is the link between the rock core of the earth and the living things on its surface. It is the foothold for the plants we grow. Therein lies the main reason for our interest in soil.

"Every soil consists of mineral and organic matter, water and air. The proportions vary, but the major components remain the same."

All soils have a profile—a succession of layers in a vertical section down into loose, weathered rock. The individual layers are called horizons. The upper layers of the soil profile, known as the "A" horizon, generally contain the most organic matter, bacteria and fungi, and are darkened as a result. This upper layer is the surface soil with which we are most familiar.

The subsoil, or "B" horizon, lies directly below, and is also markedly weathered but usually contains little or no organic matter. In temperate-region soils, the subsoil layers average between three and four feet deep.

The layers where the subsoil merges into the original soil material is known as the "C" horizon. It's usually

weathered, and the upper portion is about to become a part of the lower subsoil.

Soil is a natural body; its formation depends mostly on climate, living organisms, parent rocks, topography and time. Because of the variations in these five factors, soils in any one region are far from identical.

Although soil composition is complex, regard it—and the entire process of soil formation—as a marvelous work of nature rather than saying: “It’s a mystery to

me, so let’s get on with the actual gardening work.” Once we have the attitude that we *can* learn more about our soils, we’ll be going a long way to finding out its needs, and what should be done to improve it.

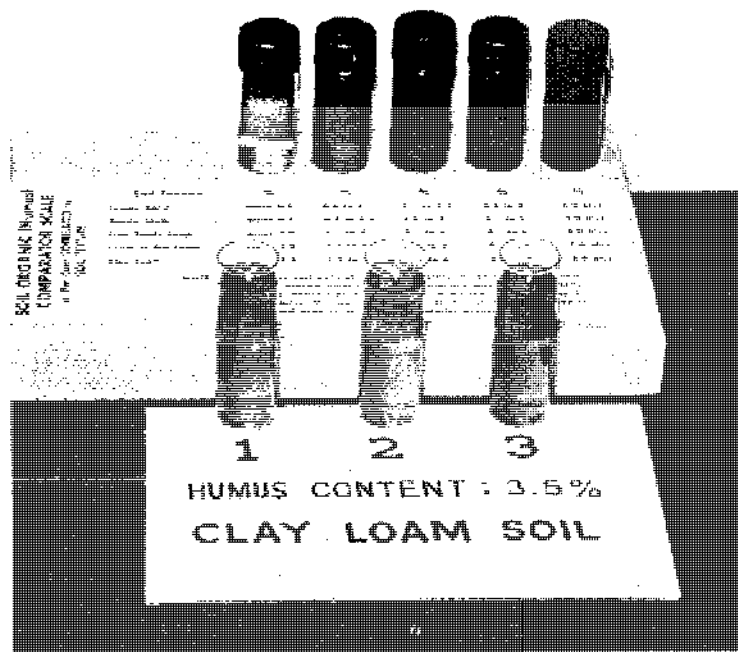
Your home grounds probably consist of a lawn, shrubs, trees, flowers and vegetables—all supported by the soil beneath them. The goal is to learn what general type of soil you have, if it has enough of the major nutrient elements and whether it’s acid or alkaline. The answers to these questions will tell you how to plant an effective soil build-up program and what plants will grow best in it.

There are two ways to find out the nutritional deficiencies of the soil. A soil sample may be sent to a commercial laboratory or to a state agricultural experiment station. Or a home testing kit may be acquired and the necessary tests made on the spot.

A home test kit is particularly valuable since it makes periodic testing of the soil practical. Indeed, the more it is used, the less costly it becomes on a per-test cost basis. Most of the kits are simple to use and require no knowledge of chemistry or laboratory procedure. And they’ll quickly reveal the deficiencies of the soil.

All soils are composed of particles varying greatly in size and shape. In order to classify them by texture as well as physical properties, four fundamental soil groups are recognized: gravels, sands, loams and clays. (The last three make up most of the world’s arable lands.)

The sand group includes all soils of which the silt and clay make up less than 20 percent by weight. Its mineral particles are visible to the naked eye and are irregular



Soil type must be determined according to information provided in kits before the test for humus content is made.

in shape. Because of this, their water-holding capacity is low, but they possess good drainage and aeration and are usually in a loose, friable condition.

In contrast, particles in a clay soil are very fine (invisible under ordinary microscope) and become sticky and cement-like.

Texture of the loam class cannot be as clearly defined, since its mechanical composition is about midway between sand and clay. Professors T. Lyon and Harry Buckman in their excellent book, *The Nature and Properties of Soils*, describe loams “as such a mixture of sand, silt and clay particles as to exhibit light and heavy properties in about equal proportions . . . Because of this intermixture of coarse, medium and fine particles, usually they possess the desirable qualities both of sand and clay without exhibiting those undesirable properties, as extreme looseness and low water capacity on the one hand and stickiness, compactness, and very slow air and water movement on the other.”

Fortunately for the gardeners and farmers in the United States, most soils are in the loam classification. The majority of soils are mixtures; the more common class names appear below: (Combinations are given when one size of particles is evident enough to affect the texture of the loam. For example, a loam in which sand is dominant will be classified as a sandy loam of some kind.)

#### Sandy Soils

Gravelly sands  
Coarse sands

Medium sands  
Fine sands  
Loamy sands

#### Loamy Soils

Coarse sandy loams  
Medium sandy loams  
Fine sandy loams  
Silty loams and stony silt loams  
Clay loams

#### Clayey Soils

Stony clays  
Gravelly clays  
Sandy clays  
Silty clays  
Clays

You can get a good idea of your soil’s texture and class by merely rubbing it between the thumb and the fingers or in the palm of the hand. Sand particles are gritty; silt has a floury or talcum-powder feel when dry, and is only moderately plastic when moist, while the clayey material is harsh when dry and very plastic and sticky when wet.

Professors Lyon and Buckman observe: “This method is used in all field operations, especially in soil survey, land classification and the like. Accuracy . . . can be acquired by the careful study of known samples.” If you’re interested in developing an ability to classify soils, we suggest your contacting the local

county agent for soil samples that are correctly classified.

While on the subject of soil characteristics, let's take a look at how the structure of your soil influences gardening results. Structure refers to the arrangements or groupings of the soil particles. The two extremes are "single-grained", as loose sand, and "massive", where the soil masses are very large, irregular and featureless.

The ideal structure is granular, where the rounded aggregates (or clusters) of soil lie loosely and readily shake apart. When the granules are especially porous, the term crumb is applied.

How can you change your soil's structure to a granular condition? The answer is clearly given by Lyon and Buckman:

"The major agency in the encouragement of granulation probably is organic matter, especially as it undergoes decay and is synthesized into humus. Not only does it bind but it lightens and expands, making possible the tremendous porosity so characteristic of individual soil crumbs. Plant roots probably promote granulation as much or more by the decay of the distributed organic matter as by the disruptive actions of the root material. The electrochemical properties of humus, no doubt, are fully effective in the organization and the later stabilization of the aggregates.

". . . At the same time organic matter promotes ready air and water movement and, not only does it lower the plasticity and cohesion of the soil mass, but it also localizes the influence of clay, since this constituent seems to be concentrated in the newly formed aggregates. . . . In fact, the granulation of a clay soil cannot

be promoted adequately without the presence of a certain amount of humus. The maintenance of organic matter, therefore, is of great practical concern . . ."

Of course, the two soil experts were speaking chiefly in terms of the physical characteristics of soil. But maintenance of organic matter in soil is beneficial chemically and biologically as well as physically. Soil scientists working for the U.S. Department of Agriculture have tested the effects of organic matter in soil. They tried it on rotation. They tried it on tillage. They tried it on fertility. In every case, they found that organic matter improves the soil and helps plants to grow fat and nutritious.

A number of interesting concepts on the value of organic matter in soil were suggested to the Nebraska Crop Improvement Association by T. M. McCalla, a bacteriologist with the agriculture department's Soil Conservation Service in Lincoln, Nebraska.

McCalla said that organic matter is indispensable to plant growth. However, he said most of our food is produced by plants grown on soils with organic matter in them. And soils with more organic matter in them produce higher yields than soils with less organic matter.

This is about the same as saying that humans don't have to have solid food to live on. We don't! But who wants to live on soup and milk for the rest of their lives, when such things as steak, mashed potatoes, gravy, and fresh fruit are available? And don't you feel like you can do a better day's work when you have a good meal in your stomach? The same way with plants. They have been found to do better when raised on soils with plenty

of organic matter present. Even such plants as tomatoes and gardenias which have been raised on nutrient solutions have been found to do better on a good soil.

Organic matter benefits the soil in numerous ways, McCalla pointed out, through its biological, chemical, and physical effects. One important benefit, he said, comes from its influence on the activities of soil microorganisms which release plant nutrients. Other benefits come from soil nitrogen tied up in organic matter, and the ability of organic matter to stabilize soil structure, increase aggregation, aeration, water-holding capacity, and decrease soil erosion and runoff. All of these increase crop yields.

Soil organic matter, he said, is that part of the soil which originates from plants, animals and microbes. Humus is the dark organic matter of the soil that has undergone decomposition until it can no longer be recognized as the original organic material. Mix any plant residue with soil and it becomes a part of the soil organic matter. When it decomposes it becomes humus.

This is the miracle substance that makes life possible. Without it there would be little or no plant life on earth. Proper use of humus can make soil more fertile, yields more abundant, and foods more nutritious.

One way humus builds up soil and brings abundant yields of healthy, nourishing vegetables and fruits to your dinner table is by making minerals available. Humus does this primarily by chelation, solvation, and storage.

Chelation is the word scientists use to describe the claw-like action of the organic compounds in humus. Some of these compounds stretch out like an earth-

worm. As they swim around in the soil water they come into contact with minerals in rocks. When they do, both ends swing close together and grab hold of the mineral. The claw that is formed is so strong that it can yank an atom of mineral right out of a piece of rock. This gets the mineral out in the open where plants can use it for food. Soil scientists in the University of Illinois' agronomy department have explained that "the availability of plant nutrients may be greatly affected by the chelating ability of organic matter."

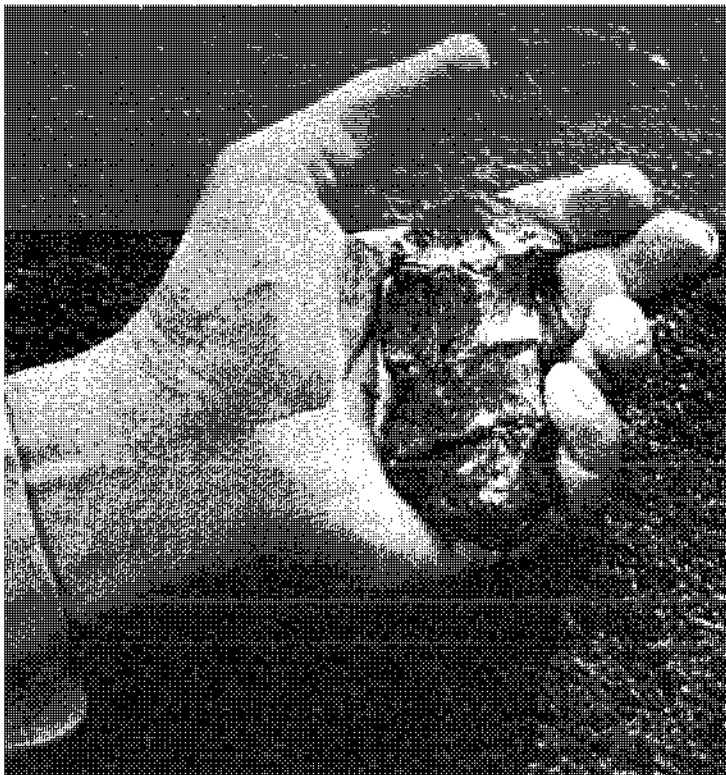
They also explained another trick humus has for making soil minerals available to plants. It is called solvation. "During the decomposition of plant residues," the scientists explained, "certain acids, particularly carbonic acid, are formed that dissolve soil minerals and make the nutrients more available to the plant."

One of the most important properties of humus is its ability to store mineral nutrients. Department of Agriculture soil scientists have said that "humus is like a sponge in absorbing water and helps hold mineral elements in the upper soil layers. It is the seat of the greatest microbiological activity and acts as a nutrient reservoir." Agricultural experiments have shown that humus supplies plants with 95 per cent of the nitrogen they need, up to 60 per cent of the phosphorus, up to 80 per cent of the sulphur and similar amounts of other minerals. These minerals are supplied to the plant as the plant needs them for food.

But is it organic matter in itself or its decay that is important to soils?

As soon as organic matter is incorporated with soil

or applied to the surface of it, it is immediately attacked by a host of microbes of every kind and description. These are the microorganisms that cause the organic matter to decay and be dissipated in a short time under normal garden or field conditions. These microorganisms are so active that any average soil is able to handle easily many times the amount of organic matter usually applied to it.



A "packed", mud-pie soil can be made workable with mulch.

Since the microorganisms readily attack the organic matter and soon convert it into humus and other decay products, the question comes up of whether it is desirable to have at least some undecomposed organic matter in the soil. "Yes," is the answer to that. The undecomposed organic matter continues to furnish food for the microorganisms. It also acts as a rough conditioner to open up and aerate the soil. It allows rain to



Soil mulched consistently is well aerated, easily worked and full of nutrients.

soak down into the soil and helps to prevent wind and rain erosion. Hence, it is necessary to keep applying organic matter to soils, regardless of whether they are garden or farmland. And regardless of whether the organic matter is available or not, it is still needed by soil microorganisms.

But what about the benefits other than from the rough organic matter? There is no question about benefits. The principal benefit is the release of plant nutrients caused by the microbial action and the chelating action of the organic matter. Of particular importance are the nitrogen and phosphorous released during the decomposition of the organic matter. These help dissolve minerals in the soil such as phosphorous, potash, calcium, magnesium and other essential plant nutrients. Chelation occurring when decomposing organic matter comes into contact with the minerals in the soil make iron, copper and other metals available to plants.

Since microorganisms are most active during the period of plant growth due to warmer temperatures, essential plant nutrients are also made most available during this period. In other words, the dynamic life of the soil is most active when it is most needed.

Another little considered effect of the decomposition of organic materials in soil is the production of "auximones" and other growth-promoting substances. There is also the production of toxic or antibiotic substances when green manures are added to the soil. Strangely enough, these toxic substances do not harm the growing plants. They appear to help in controlling root-rot and damping-off fungi.

The benefits from organic matter, then, are due

primarily to the activity of the microorganisms which decompose the organic matter and to the products they form. But the organic matter is also important to the chemical composition of the soil.

"Soil organic matter contains the things that plants have taken from the soil, air and water, as well as products resulting from the decomposition of plants and animal materials by soil microorganisms," McCalla noted in his report. "It contains generally about 56 per cent carbon, 5 per cent nitrogen, and oxygen, hydrogen, phosphorus, sulphur, calcium, magnesium, potassium, iron, zinc, manganese, copper and boron. Organic matter also contains numerous organic compounds. A ton of wheat straw will produce about one and one-half tons of carbon dioxide. Decomposition of soil organic matter results in the gradual production of mineral elements in forms that are available to plants. A storehouse of plant nutrients, organic matter is almost a fool-proof fertilizer.

How much organic matter do good farm soils contain? The better farm soils, McCalla said, contain from four to five per cent organic matter. How to maintain this is the big problem. Continuous cropping to cultivated plants reduces the organic matter content of the soil. However, organic matter was maintained at about the same level or higher in experiments by the liberal use of manure, sod crops, and wise crop rotations, McCalla said.

Soil scientists recommend adding a generous supply of organic matter to soil at frequent intervals. This keeps biodynamic activity at its peak. Compost may be added any time. Undecomposed materials such as grass



clippings, leaves, shredded corn stalks, alfalfa, clover and so on are best turned under after the fall harvest. If you do three things—give plants plenty of sunshine, plenty of water and add generous amounts of compost—you will be sure of supplying the basic nutritional requirements of plants. The net result will be a better soil more capable of growing larger crops of more nutritious fruits and vegetables.

But how does mulch fit into the picture?

Well, most obviously, it is a constant supply of organic matter for the soil. As it decomposes, it provides the important microbiological activity. And as it decomposes, it becomes humus.

An important benefit of mulch is its improvement of soil structure and tilth. As the decaying organic matter works down into the soil, it becomes more friable, is better penetrated by water and its aeration is improved, thus stimulating root and biological activity. If organic mulch is mixed into the upper soil layer, it will dilute the soil and usually increase root growth. When mulches such as crushed corn cobs, sphagnum peat moss, or sawdust are used, the effect of the addition of this material to the soil is almost immediate. On clay soils, aeration is increased. Water holding capacity is increased in a sandy soil, an important function of mulch which is often overlooked. A mulch of leaves, grass or dead plant residues cuts down evaporation, helps to hold moisture in the soil and lowers the soil temperature. Sandy soils mulched with grass and leaves in November have shown 2 to 3 per cent more moisture the following May than unmulched soil. While this is a small amount, it is sufficient to make the difference

between good plant growth and little or no growth.

Plant roots extend down into the soil in search of moisture. In so doing, ordinarily, they grow away from the highest concentration of the mineral plant food elements. With a good mulch of organic matter the surface soil is kept moist, promoting the development of feeder roots near the surface of the soil, the zone of highest fertility. The improved moisture condition and increased plant food constituents result in increased vigor and better plant growth. A mulch will prove beneficial on heavy textured soils as well as on light textured ones, but the benefit from improved moisture conditions will be greatest on sandy soils.

Mulches improve and stabilize soil structure or the arrangement of soil articles. Because of the mulch layer, the soil structure is not disturbed by pelting rain, or coarse streams or drops of water from irrigation devices. Some gardeners do not realize that cultivation of the soil when it is too wet destroys good soil structure. When mulches are used, the danger of cultivation at the wrong time is eliminated since very little, if any, cultivation is necessary. Another way to harm the soil structure is walking on the soil when it is wet. If there is a mulch on the soil, this will serve as a cushion and the compaction of the soil is reduced.

If the mulch is not well-decomposed but is a decomposable material, it will promote granulation of soil particles just as Lyon and Buckman said. During decomposition of the organic material, soil microorganisms secrete a sticky material which promotes the granulation of the soil. This is especially true of heavy soil types. Materials like sphagnum peat moss, which

decompose slowly, have little effect on granulation. Straw, hay, fresh leaves, or manure, which decompose rather rapidly, do have an effect on granulation.

A valuable organic matter is formed during the decomposition or rotting of a mulch cover. Decomposition is not an undesirable process, but rather one that recirculates necessary plant food elements for additional crops. In addition to the release of mineral elements such as nitrogen, phosphorus, iron, carbon dioxide and water are released.

All mulch covers do not decompose at the same rate. More resistant substances in the mulch cover, such as lignin, undergo relatively slow change because of their complex nature. Lignin, together with cellulose, forms the chief part of woody tissue. Carbohydrates, such as plant sugars and cellulose, on the other hand, are rapidly attacked yielding carbon dioxide and water. The resistant materials like lignin are not wholly inert nor are they readily identified in the soil. If this were not so, organic mulch would accumulate until ultimately the surface of the earth would be covered by it.

When an organic mulch decomposes, it is similar to a wood fire which dies down from a bright blaze to smoldering embers, glowing for a long time.

The composition of organic matter from different locations is surprisingly uniform despite the wide variations in type of plants and microorganisms that are responsible for its formation. Recent investigations indicate that three classes of compounds dominate soil organic matter. They are substances produced by the alteration of lignin of plants, compounds related to carbohydrates (bacterial gums, slimes and molds) and

material probably derived from proteins. The last is probably the principal carrier of nitrogen.

The lignin of the organic mulch undergoes change when first mixed in the soil. After the initial attack a resistant portion remains that is so greatly altered as not to be properly spoken of as lignin. This portion is usually resistant to further degradation.

The carbohydrate-like materials in an organic mulch are largely substances of microbial origin, as, slimes, gums and organic salts of uronic, teichoic, muramic fulvic and humic acids.

There are, of course, many other benefits derived from mulching. Not all are as complex as those involving chelation and solvation and other processes in the soil. But they are vital to growth of nutritious fruits and vegetables. They are vital to the maintenance of a good, fertile soil. They can be stated briefly.

—Mulching conserves soil moisture by reducing the evaporation of water from the soil.

—Mulching prevents crusting of the soil surface, thus improving absorption and percolation of water to the soil areas where the roots are growing.

—Mulching maintains a more uniform soil temperature by acting as an insulator that keeps the soil warm during cool spells and cooler during the warm months of the year.

—Mulching reduces weed problems when the mulch material itself is weed-free and is applied thickly enough to prevent weed seed germination or smother existing smaller weeds. Mulching thus considerably reduces the time and labor expended in weeding garden areas.

—Mulching adds to the beauty of the landscape by

providing a cover of uniform color which can be neutral or non-detracting and may add an interesting texture to an otherwise drab surface.

—Mulching can prevent fruit and plants from becoming mud-splashed and reduce losses to soil-borne diseases.

—Mulching can prevent freezing injuries caused by late spring or early fall frosts if a light layer of mulch material is placed on top of the plants in the evening and removed in the morning.

It is important to remember that mulching should be done only with natural, organic materials. And for good reason. The soil, basically, is made up of weathered rock particles and organic matter, closely associated and intermixed.

In the organic method of gardening, we attempt to feed the soil so its natural constitution is not disturbed, basing our procedures and techniques on the study of the makeup of the soil. Knowing how it was originally formed, we can better understand what kind of food will suit it.

The soil's basic elements—inorganic minerals from rock fragments, organic matter, water and air—logically lead us to the best formula for its sustenance. If we restore the used-up mineral and organic matter, and if we see to it that there is an adequacy of water and air, the fertility of the soil will continue to maintain itself. The great forests, the huge groves of trees and masses of vegetation which we know exist unaided by man, are all growing within the scope of this simple formula—straight, unadulterated mineral matter, organic matter, water and air. The great redwood trees of the western

coast which tower into the clouds depend on nothing more than these four things.

Therefore, when we mulch the earth with only the elements of which it is naturally constituted, we are not gambling. And since the gardener will soon discover that he can secure a greater harvest of vegetables by following the organic system, he will realize how wrong the chemical method is.

## Chapter Three

# MULCH and YOUR GARDEN

Mulching will do as much for your garden as it will for your soil, for there are as many benefits of mulching above-ground as there are in-ground.

While the mulch is stimulating and feeding aeration, microbiological activity and granulation in your soil, it will be preserving moisture and soil structure, maintaining a fairly constant temperature, quelling weeds, disease and insects, making your garden something worth looking at and its produce worth eating.

Mrs. Robert Smith of Fort Wayne, Indiana, praises the mulch system. She and her husband, both practitioners of the organic way of gardening, tried the mulch system for the first time several years ago when they were planning a four-week vacation far from the vegetable patch. Mrs. Smith planted the garden to coincide

with their return and thoroughly mulched about three-quarters of the plot.

"My husband was rather disgruntled that I spent money for the mulch," she said, "but on our return he had to admit I had been wise. Needless to say, the area I did not mulch was stunted in growth although there was a great harvest of weeds. The rest of the garden was a veritable jungle of beans, corn, cucumbers, and a dozen other vegetables, with few weeds showing. Our yields were fantastic—the best year we'd ever had in growing a garden!" she continued.

"Later, in talking to my neighbors, they said not one drop of rain had fallen during our month's absence, and they couldn't understand why my garden had survived and was so luxurious and rich in color as well as crops while their gardens either dried up or were badly stunted.

"This year we plan to be gone again for 4 to 5 weeks, so we'll again be mulching heavily and expect a bumper crop waiting our return. It's really been a pleasure gardening organically and seeing our production outdo itself each year," she concluded.

Mrs. Smith's testimonial is typical for the mulch-it-and-virtually-forget-it way of gardening. Ruth Stout has been practicing it for years. And mulching has been around for many more years than Ruth Stout—and that's a lot of years.

The fact that the effects of mulching are seldom simple complicates the search for precise information. Certain patterns of behavior of soils and plants under mulch, however, have been observed in studies conducted in the United States and abroad. These studies

have determined the effects of mulch on the soil, as outlined in the previous chapter. They have determined that mulching affects such gardening conditions as moisture, soil structure, temperature, weed growth, plant disease and insect infestation. Further, mulch can be a factor in the appearance of a garden, although appearance isn't the sort of thing you pin down with a scientific test or study.

Temperature and moisture or a combination of the two frequently appear to be the most critical factors in determining the effect of mulch on crop yield. For Mrs. Smith, for example, the moisture holding qualities of a good mulch were critical not just to a good yield, but to the simple survival of her garden.

Farmers who use mulches generally do because it is the best way to make most efficient use of the available moisture in producing crops. In most cases, the moisture content of the surface soil under mulch is higher than when soil is clean-cultivated.

But where does this moisture come from if—as in Mrs. Smith's case—there is no rainfall for a substantial period of time? The moisture comes from the dew. Dew is the condensation of moisture from the air in the soil. Most of the dew is a complete waste as far as plant growth is concerned—unless there is something on the surface to catch it and prevent it from evaporating. A mulch is a wonderful dew-catcher. A mulch of rocks or wooden boards catches more dew than any other because no air or moisture can pass through it.

While much of the Northeast was enduring its fourth consecutive summer of searing drought several seasons ago, and worried communities began placing more re-

strictions on water use, the helpful role that a mulch can play became increasingly apparent. A notable instance was the attractive Brooklyn Botanical Gardens, where regular irrigation was curtailed completely in the midst of New York's drive to conserve water. Instead, mulching was employed around the many gardens and plantings. The dampness underneath could be felt as well as seen and an increase of earthworms resulted in the soil where areas were mulched.

Experiments in a number of states have shown the efficiency of mulch in holding down evaporation. The amount of moisture savings attributable to reduced evaporation under a straw mulch varied widely with climate and other varying test conditions. In experiments in Tennessee and Michigan, for example, indirect measurements showed that, in humid areas, evaporation losses may be reduced by the use of mulch. The reductions ranged from around 12 or 16 per cent to as much as 50 per cent or more.

Other experiments in North Carolina showed that wheat straw mulch at three tons per acre increased moisture in the soil and markedly increased corn yields during drought conditions. The increases averaged 21 bushels per acre in eight experiments, with a close ratio between corn yields and moisture content of the soil. In 10 experiments conducted under good moisture conditions, mulching did not greatly affect yields.

Similarly with tobacco, there is a close correlation between drought conditions and the effect of mulching on crop yields. Agricultural researchers working in Maryland found that tobacco grown under four to six tons of straw mulch per acre gave yields as good as

those from cultivated fields during five years when rain was normal or less than normal—but crop values were reduced during two years of above normal rainfall.

On land where excess moisture is a problem because of poor drainage and heavy rainfall, mulching could obviously have an adverse effect.

The second most critical factor appears to be temperature. A mulched plant is not subjected to the extremes of temperature that an exposed plant is. Unmulched roots are damaged by the heaving of soil brought on by sudden thaws and frosts. The mulch acts as an insulating blanket, keeping the soil warmer in winter and cooler in summer.

Soil heaving damage, brought on by a winter of sudden, deep freezes alternated with abrupt thaws, should be no threat. Safe under a protective mulch, plants and topsoil can wait out the severest winter weather with an absolute minimum of injury.

The penalty for not mulching can be high at any time. But the advent of winter can bring real trouble to the thinly mulched or unmulched flower beds and vegetable patch. Winter-hardy perennials can be lifted literally out of the ground by frost action and their roots exposed. Wheat plants are frequently completely heaved out of the soil, taprooted legumes such as alfalfa can be badly injured, while entire fall-planted beds of strawberries may be found dead or dying above the ground.

It generally is not known that the type of soil has more to do with soil heaving than the prevailing climate. Sandy soils rarely heave because they are well-drained and the free water is below the three-foot mark—which is as deep as the soil freezes. Soil heaving is not

caused by the expansion of water freezing in the soil but by the formation of more ice from water moving up through the soil.

Heaving occurs when the surface layer of the soil freezes and is pushed upward by pure ice columns of “lenses” which develop just below the layer of frozen earth. The pillars of ice are formed by water that swells upward from below to the lower side of the frozen layer, moving by capillary action through pores or voids in the soil structure.

Control of heaving may not be possible under really severe circumstances, but the place of mulching in maintaining control is nevertheless secure. Good drainage reduces the chances of heaving injury by removing free water near the surface. A good blanket of mulch further reduces the possibility of heaving by controlling the action of the water in the soil—preventing it from alternately freezing and thawing and freezing again.

A good mulch has a similarly tempering effect on the soil's reaction to the change of seasons. It soothes the swing into spring and blunts the first bitter blows of fall and winter weather.

In experiments using mulches on vegetables, researchers of the Pennsylvania State Agricultural Experiment Station concluded that reduced temperatures under mulches in the early spring might partly explain smaller early yields and greater total yields in midsummer when lower soil temperatures would have a favorable result. The mulch tempers day-to-day temperature changes and even the rise and fall of the temperature in the course of the day.

There are a number of factors which enter into the

mulch's ability to temper temperature, one of which is the color of the mulch material. Light-colored materials tend to reflect heat rays while dark-colored mulches tend to absorb them.

This was brought out in a Kansas study which showed that the darkening of a straw mulch by humification influenced the effect the mulch had on the soil's summer temperature. Under a light-colored, fresh mulch the soil temperature was 2.8° C. lower than in bare soil, while soil under a dark gray, partially decomposed mulch was only 0.2° C. lower than bare soil. Reflection from the fresh, light-colored mulch was about three times as great as from the dark, partially decomposed mulch: 32 candles of light per square foot as compared to 11 candles.

To a degree, the moisture preserving and temperature controlling characteristics of mulches are tied to their ability to maintain good soil structure. A mulch prevents—largely by preserving the moisture in the ground—crusting of the earth. A crusted earth is more subject to erosion by wind and rain and is less capable of absorbing the moisture of a brief shower. Indeed, such showers even contribute to the crusting of the earth by compacting it.

Mulches protect the soil from the direct impact of rainfall. Raindrops fall with tremendous force. When this force strikes on bare ground, much of the energy is expended by breaking up soil aggregates and sealing and compacting the surface soil. This decreases the infiltration capacity of the soil and increases runoff and erosion. By breaking the force and size of the falling

raindrops, surface mulches maintain soil porosity and conserve soil and water.

The preservation of porosity was demonstrated in U. S. Department of Agriculture tests in Ohio. The results of the tests indicated that the greater penetration of water generally occurring in mulched soils was primarily due to the protection that the cover affords to an existing favorable soil structure. But when the soil wasn't permeable to begin with, putting mulch on the surface did not cause the water to penetrate. After cultivating the soil to a one-inch depth to break surface crust, however, the infiltration rate under mulching after 60 minutes was 2.10 inches an hour as compared to 0.28 inches an hour on similar unmulched plots.

Similarly, the value of mulches in controlling erosion is widely recognized and has been test proven. Mulches do this by reducing runoff, by maintaining the porosity of the soil and by providing conditions favorable to the activity of organisms which can result in more stable soil aggregates. These all interrelate and all contribute to the soil-saving effect of the mulch.

The extent of this effect has been measured in numerous studies. In Illinois tests, for example, soil losses after an hour's rain of 1-3/4 inches were 3,225 pounds per acre from bare ground as compared to 205 pounds from ground mulched with cornstalks.

In studies recently conducted in cooperation with the Georgia Agricultural Experiment Station, researchers found that a mulch of pine needles, straw, or any other cheap mulching material applied at the rate of around two tons per acre could be used successfully to prevent

erosion on steep road banks until a cover of vegetation could be established. The chief landscape architect for the Ohio Department of Highways has said that mulch is a primary part of his state's successful seeding operation. He said that straw mulch was first used on highway seeding to protect sloping areas from erosion. Its use has been continued because the straw successfully extended the seeding season. As a result, seeding is done at any time of the year that a proper seed bed can be secured. Usually a thicker amount of straw is required if the project is to go through a dormant seeding period, he noted.



Soybeans on the right, grown with an oat straw mulch, are almost weed-free, in marked contrast to unmulched beans at left.

*Public Works* magazine observed that "the best thinking has found that mulch is of great benefit because it reduces erosion; it reduces the force of rain-drops; it reduces evaporation; it keeps the seed bed loose and at a more even soil temperature; and it eventually adds organic matter to the soil. Mulch shades the seedlings, allowing some sunlight to penetrate and air to circulate, and it encourages and hastens native growth in areas that have not been seeded."

But there's even more of a case for mulching than that, because mulching protects plants from weeds, insects and soil-borne diseases.

Ruth Stout is most outspoken on the value of mulches for weed-control. In her recent book *The Ruth Stout No-Work Garden Book*, she explained why mulches are good for controlling weed growth.

"If the mulch is thick enough, the weeds can't come through," she wrote. "When I say this, people then invariably ask why it is that the vegetable seeds come through and weed seeds don't; this is because heavy mulch is on top of the latter, but not the former . . .

"A few weeds may come through your mulch here and there; this will be because you didn't apply it thickly enough to defeat them," she continued. "They are easy to pull if you want to take the trouble, but the simplest thing is to just toss a bit of hay on top of them."

A good mulch will also deter garden pests. Ruth Stout has reported that corn-hungry crows are "non-plussed" by her mulch. She and other mulchers, like Harold Fleck, have lauded the freedom from insects that a thick mulch brings. "Before mulching", Fleck said, "the beetles would ruin our lima and string beans.



Last summer it was different." He had mulched for the first time. "There were a few beetles, but they were too few to damage our production."

Or as Ruth Stout puts it, "I haven't sprayed for 18 years and have no bug problems at all except for a few Japanese beetles which go for soybeans and raspberries. No bean beetles, no aphids, not a potato bug, no corn worms."

Plants, fruits and vegetables are also protected from soil-borne diseases. Mud is less of a problem when walking on mulched rows. Low-growing plants aren't splashed with mud. Free from this, they are also apt to be free from diseases that mud splashed on them might carry.

At harvest time, vegetables which sprawl on the ground, such as cucumbers, squash or strawberries, often become mildewed, moldy or even develop rot. A mulch prevents this damage by keeping the vegetables clean and dry.

Tests have shown that mulches sometimes support microbiological life which fights organisms deleterious to plants. Several scientists made a study of a lemon grove which almost quadrupled its yield after being mulched with wood shavings.

Since healthy root systems are associated with high citrus yields, they tried to determine what factors were involved in bringing about such an improved yield. Their approach to the problem included a study of the soil flora to determine whether there was a build-up in the mulch of some organism known to be antagonistic or parasitic to citrus root pathogens.

They found there was a fungus in the wood shavings

that parasitized two other fungi, which together or separately can cause citrus root rot, crown rot and fruit rot. Following this lead, repeated attempts were made to recover the harmful fungi from roots and soil in this mulched grove. Although the grove had a history of brown rot, the fungus was difficult to locate, indicating that it did not prosper there.

During this study of the flora in the shavings mulch, the researchers encountered other fungi which were capturing, killing and digesting free-living nematodes. Since citrus nematodes are a serious problem in many groves, the men tried to determine if these helpful fungi were capable of attacking the citrus nematode. They found that the fungi, when grown in culture and fed the larvae of the citrus nematode, readily captured and killed these root parasites.

Studies like this one have demonstrated time and again the disease fighting qualities of mulches. But a tree, shrub or plant won't get sick in the first place if it is vigorously healthy. It is most susceptible to disease when it is poorly nourished and lacking in vigor.

Avid organic orchardist Alden Stahr has demonstrated this by saving nine of the last 10 orchards he's dealt with. Stahr has moved from farm to farm, and at many of his different homes he's struggled "with remnants of old orchards, given up in past seasons as being past bearing age. But because of sentimentality, or from sheer determination," he said, "I experimented with the old trees until at last I came upon what I believe is a fountain of youth for fruit trees."

He found his discovery was similar to that of researchers at the Beltsville (Md.) Agriculture Plant In-

dustry Station of the Department of Agriculture. In experiments there, 18-year-old apple trees with injured roots and in very poor condition made a phenomenal recovery after being mulched for two to three years with nitrogen-rich orchard hay grass.

Each tree received about 20 pounds of air dried hay, applied in June, which provided sufficient mulch to extend a foot or two beyond the spread of the branches and was about six inches in depth after being packed down by rain. No supplementary fertilizer of any kind was added to the hay-mulched trees.

High nitrogen hay mulches decompose rapidly, releasing nutrients to the roots and carbohydrates to the soil. Under these mulches, many tree roots grow in immediate contact with the decomposing hay and receive a continuous supply of nutrients. This is a dynamic process and although the mulch almost disappears each year the desirable changes have been effected.

Improvement in growth and foliage color in the Beltsville experiment was evident the year after the first application was made. Marked improvement was evident the second season; and during the third growing season after the experiment's beginning, the trees were outstandingly vigorous and productive. Unmulched trees in the same orchard location remained in poor vigor irrespective of fertilizer treatment. Trees receiving supplementary nitrogen in quantity equivalent to that supplied by the orchard grass were more vigorous than unmulched trees, but in no instance did they compare in vigor with those mulched with high-nitrogen orchard grass hay. The response to hay mulch was characterized

by luxuriant dark green foliage, increased terminal and spur growths, and heavy set of fruit.

"In conjunction with our studies on tree response," the Beltsville researchers noted, "chemical analyses were made to determine the rate and total amount of the various nutrient elements released by the orchard grass mulch during the process of decomposition. These analyses showed that this mulch will provide a complete supply of nutrients for ideal growth and production, if the nitrogen content of the hay is relatively high and the rainfall adequate for decomposition and extraction."

They were orchards that were saved, but they could easily have been rose gardens or vegetable patches. Mulching makes the difference.

But mulches are more than practical—they're like frosting on the cake. While they're keeping everything beneath them cool and moist and in the proper structural relationships they're providing taste and visual appeal. Without the frosting, you still have a cake, but it isn't as good as it could be. It doesn't look as good and it doesn't taste as good. So it is with mulches. There are gardens and orchards without them, but they don't look as good as they could. Nor does the produce of unmulched orchards and gardens taste as good as it could.

Several years ago, Lewis Hill tried some experiments in hopes of coming up with a method of producing cultivated raspberries with flavor comparable to wild ones. Initially, he believed that fertilizers and soils were the keys to flavor. The principal experiment lasted several years, Hill said. It consisted, he continued, "of a dozen or so of large established Latham raspberry

clumps, each of which was fertilized or mulched in a different way, to find how the different types of culture affected plant growth, and principally their influence on variances in flavor.

"In the spring, 6 clumps were treated with fertilizer as follows: (a) fresh cow manure, (b) well-age cow and horse manure, (c) finished compost, (d) dirt gathered from maple woods, (e) 5-10-10 chemical fertilizer, (f) liquid chemical fertilizer.

"Six clumps received various mulches: (g) coarse wood chips (maple), (h) sawdust (fir and spruce), (i) old hay, (j) green grass clippings, (k) maple leaves, and (l) paper mulch consisting of ordinary newspapers and magazines. The final clump, (m) received no mulch or fertilizer. None of the plants were irrigated or given additional plant food, organic or otherwise. Soil was ordinary, unimproved field soil not particularly high in humus or fertility," Hill continued.

"Results were quicker than we expected. Even the first summer there was a noticeable difference in fruit flavor, and subsequent years increased it. Since flavor cannot be measured like size or weight, and is only a matter of opinion, we called on numerous customers and visitors to our nursery to sample our berries, and compare flavor. Without knowing the details of our tests, nearly all confirmed our findings.

"The berries grown with fresh manure had a strong taste, and a handful of them together had an unpleasant smell. This was not too surprising. More than once, we had checked out complaints from customers concerning bad-flavored apples, only to find the trees had been planted near their septic tank drains!

"Berries grown with chemical fertilizers, both granular and liquid, had less fragrance, and a flat, duller taste. Well-rotted manure, woods dirt, and compost all had much better flavor and odor; but quite surprisingly ran second, in our opinion, to the mulch-grown ones," he said.

"Since the soil was not especially fertile, the quicker-rotting mulches—hay, grass, maple leaves, and paper—came closest to producing the flavor we were seeking. Soil under these mulches improved in texture much faster than in any of the other treatments, too; though in following years, those with the slower-rotting sawdust and wood chip mulch did well, falling only a little short of the others in producing vigorous plants with highly flavored fruit.

"For uniform comparison in all tests, berries were picked only when completely ripe, and nearly ready to fall off.

"The result? Mulches went on the currants, gooseberries, apples, cherries, plums, strawberries, and the rest of the raspberries. Our compost pile collected mostly garbage from then on; all else went into mulch material—like garden waste on the bottom, better-looking hay on top. Soil tilth improved vastly, staying loose and moist even during the driest part of the summer. All the trees and plants showed impressive increase in growth. Some of the young trees grew nearly twice as much in a year as before mulching, since they kept growing all season, not just after rains. Quality of fruit was much improved, too. Furthermore, now we never feel the large cultivated berries are playing second violin to any wild ones in flavor," he said.

“We found that mulching saves hard work, also. Applying mulch is certainly much easier than making and turning large compost piles, keeping them moist, and later having to work them into the soil. Now we let Nature, her bacteria, and earthworms do the job right on the spot!

“When we started our experiments, we fully expected to prove how compost produces superior flavor in berries. Instead we became convinced that to all the other arguments in favor of garden mulch, another may be added: mulching means better flavor.”

Mulch means better looks, too. A mulch is visually appealing.

Picture a garden section devoted to shrub roses or other flowering perennials. In bare, uncovered soil their appeal is limited to upper levels alone. But add a layer of auburn cocoa bean hulls nestling around them, and a whole new outlook comes into view—a vista of rich color, of eye-pleasing textures and tones. Then, too, a dimension of depth completes the comfortable “carpeted” look. In bloom and out, your plants—and garden—look better right from the ground up.

Or shift the scene to the vegetable patch, where backyard eye-appeal and practical benefits go hand in hand with a cushion of thick hay or straw. Glance over to the fruit trees, which cast a far more attractive spell on the homeground horizon when they’re circled with things like rough-grained bark and wood chips or ringed by a deep bed of crushed rock. And look at plantings set around the foundation of your home; invariably they fit more naturally and invitingly when a layer of pine needles, shells or leaves makes them snug.

Given a variety of mulches to work with, a gardener eager to do some “outdoor decorating” has a tool for being as creative as the fussiest of the indoor breed. At every turn of the yard and garden, mulch can help contrast the shapes and hues of plants or blossoms, highlighting backgrounds and vertical lines, or simply blending neatly with them where desirable. From a distance, the effect of certain mulches can be one that dramatically enhances any size or form of growing area. Up close, they easily perk up the mood of plant sites, transforming drab or detractive ground into handsome settings for every sort of growth.

Best of all, they prepare that handsome setting for some of the best growing you’ve ever seen. For while a mulch is working in the soil, sparking microbiological activity, promoting better aeration and granulation, it’s working atop the soil, too. It’s providing a cover to prevent the sun from baking out the moisture, creating a crust and making the land privy to runoff and erosion. It’s preventing the growth of weeds and other ground cover which would compete for the moisture and nutrients in the soil. It’s tempering the temperature, limiting the radical range of temperatures which beset plants.

“There is the secret”, said Alden Stahr. “Mulch will do the trick. Drainage and feeding are important, but mulch is the real fountain of youth.”

Or, as Mrs. Smith put it: “Our yields were fantastic. . . . so we’ll again be mulching heavily . . .”

## Chapter 4

# MULCHING MATERIALS

When you set out to mulch a home garden of any size, the first thing you ask is, what should I use?

There are almost as many different kinds of mulching materials as there are gardeners to use them. Mulch is a personal thing—if you ask 20 gardeners what their favorite material is and why, you may get 20 different answers. There is no one perfect mulch, but many good materials are suitable for mulching your garden. Perhaps the best way to start is to use what's easily available. There's not much sense spending hard-earned money for exotic mulches if easily found leaves will do the job you want done. Most gardeners solve their own individual gardening problems by using what is cheap and abundant locally and gets practical results for them. They have learned by experimenting to think for themselves.

Take Bob Wandzell, for example. He's a resident of Alaska where growing seasons are short and wet. Wandzell solved his gardening problems by tapping the ocean's resources. Seaweed combined with sawdust brought satisfying results in an otherwise marginal growing area.

Not long after moving to Wrangell, Alaska, Bob yearned for the fresh fruits and vegetables he had enjoyed so much in the continental United States. He decided to start his own garden. Upon checking around, he discovered that others had unsuccessfully attempted to garden in Alaska. They attributed their failure to heavy rainfall, short growing seasons, high-acid soils, non-existent local supplies of animal fertilizers, and high commercial fertilizer costs.

How did Wandzell overcome these problems to become the most successful berry and vegetable grower in southeast Alaska? Well, the first thing he did was to plot his garden on a hill, in hopes the sloped runoff would solve the excess moisture trouble. (Wrangell averages over 150 inches of rain every year.) His first garden did poorly, though—just as others had predicted. But pictures of ripe vegetables on the seed boxes, the sweat spent in preparing the patch, and the sight of weak plants struggling to mature fired up Wandell's determination and whetted his appetite for fresh produce.

The moisture problem licked, he tackled the soil deficiencies. There were no barnyard animals around Wrangell, so manure was out. He tried several commercial fertilizers without success. Then he thought waste materials from the fish canneries might do the job, but the canneries seemed to have a can for everything the

fish had to offer, and there was no waste.

Finally one spring, lacking anything else to try, Wandzell mixed some seaweed—found on the beach across the street from the garden—in with his soil and planted strawberries. Late that summer the family enjoyed their fill of fresh strawberries. For some reason unknown to him, the seaweed had given the soil what it needed.

He collected five soil samples from around the garden—one of which had a high seaweed content—and sent them to the Alaska Division of Agriculture to be tested for fertilizer needs. He soon received word that four of the samples were low in phosphorus and had too high an acid content. The fifth sample, he was informed, contained everything necessary for ordinary gardening!

That fall the Wandzells gathered a large crop of seaweed that had washed ashore above the high-tide mark and dried in the sun. Wet seaweed contains 70 to 80% water—which they didn't need—so they harvested in the fall when dry weed is abundant on the beaches. They stored their ocean "crop" like hay all winter, then added it to the soil in the spring. That summer the Wandzells' garden produced the best vegetables ever grown in Wrangell.

Their rhubarb is first-class evidence of how kelp influences green leafy plants. It grows like it's trying to push back the whole Alaskan rain forest. From one short row Wandzell sold 30 to 40 pounds before the first of June last year, which is something to brag about when one considers Alaska's late springs and short growing seasons.

Even without the seaweed, sawdust makes real good

mulch, if that's what is cheap and abundant locally. Such was the case for Morton Binder. He estimated the cost of manure, peat or beanstraw and mixed the wholesale use of it in his gardening program. But he needed something to aid his rock-hard soil.

Located on a coastal plain, his soil is an extremely compacted, very fine sand over an impervious yellow clay subsoil. When he started on the yard, he began to dig a post-hole and thought he had hit a rock. Even a pick refused to chip off more than bite-sized chunks. He filled the hole with water and the next day had to bail it out to continue digging.

Then he remembered that in a nursery where he had worked a lot of old shavings from the sawdust bins had been used. "A lumber mill is close by," Binder explained. "I went up to look over the situation. There were literally thousands of yards of coarse mill sawdust chips free for the taking. I carried sufficient back with me in a few trips to heap a foot deep over the entire future garden area. The deep surface mulch held the irrigation water without runoff, and within two or three days the fine sand was ready to spade. It took three times over to get a good mix. This could have been done much more simply with a hand tractor, but it was in an inaccessible position," he explained.

The upshot of his labors was a better soil. He said it became "increasingly friable and plants are responding well." He continued, "I ran a pH on the sawdust and found it to be 4.5, or about that of peat moss. In an alkaline soil this would be fine, but in my 5.5–6 soil I had to add lime.

"Weeds pull readily when the soil is mulched with

sawdust. The water bill has been negligible, even though our water rates are high. Humidity is maintained at all times. The ground looks and feels good, and caking is a thing of the past. Cultivation has been reduced to minimum and the angleworms are becoming more prevalent," he said.

"The amount of manure, organic matter, and lime used was no greater than if I had been working with a friable soil in the first place. I estimate my total soil-



Sawdust, available free from the lumber yard, is one of the most inexpensive soil builders.

building cost at two gallons of gas, although it did take a lot of hard work," he concluded.

Another sawdust mulcher, Mary Leister, reaped similar benefits with a similar outlay. She was able to get sawdust to mulch her garden "at the expenditure only of time and physical effort." Unlike the variety Binder used, however, Mrs. Leister's sawdust was well rotted from having spent 20 years lying in a shady woods.

"This sawdust was," she explained, "moist and very heavy to handle, but its dark color was most pleasing to the eye. Even the lightest of rains seemed to go directly through to the garden soil and very little additional water was needed throughout the summer by the herbaceous annuals and perennials protected by it, nor did they show any overt need for additional fertilizers during the growing season. The vegetable garden grew lushly, and strawberries, raspberries and rhubarb all produced prodigiously surrounded and protected by this sawdust mulch.

"No replenishing of the mulch was necessary from spring to fall," she continued. "Not one garden weed penetrated the three inches of sawdust, and only an amazing few of the broken roots of the creeping woods plants gave rise to new growth that had to be pulled from the loose, unresisting medium.

"On the same July day when the soil beneath the dried grass registered 94 degrees F., that beneath the rotted sawdust registered only 82 degrees. These temperature readings were taken in the same test bed, in the same direct rays of the sun, and within four feet of each other.

"In early November, checking the decomposition

and/or loss of the sawdust, I found approximately two inches of loose mulching material, while the first inch or so of soil immediately beneath was so mixed with the sawdust as to be inseparable one from the other. It was, in effect, a rich, black, moist soil, brought about, probably, by the action of rain water, soil bacteria, and little earth animals," she said.

Mrs. Leister, in the course of her gardening, has had the opportunity to try some other mulch materials. She approached her mulching endeavors with these other materials with the same observant care she applied to her test of rotten sawdust. The others she tried were grass clippings, a material available to anyone with a lawn; shredded pine bark, a commercially-available mulch, and ground cork, a relatively little-used mulch. Each was spread on the Leister garden and "checked for its desirability as a mulch."

"Our lawn, green, healthy and practically devoid of weeds, has always provided a more than abundant supply of clippings to cover, thin layer by thin layer, every bed and border in our garden," she said. The pale gray-green color of the drying grass deepens to brown and is not unpleasant. It readily permits raindrops to penetrate to the soil beneath, while its decomposition enriches the soil, and its shady protection keeps the earth beneath it both cooler and damper than cultivated soil exposed to the elements. On a day in July when the air temperature was 98 degrees F. and the temperature, in direct sunlight, at the surface of the mulch registered 120, the surface of the soil beneath the dried grass mulch was 94 degrees.

"These grass clippings, however, require almost

weekly replenishment in order to keep the mulching depth a preferred 3 inches. This rapid decomposition necessitates the constant addition of organic fertilizers rich in nitrogen, to the soil; and the protected plants, even in a season of fairly normal rainfall, are very often in need of additional moisture. Furthermore, by freeze-up time very little dried grass is ever left for use as a winter mulch," she continued.

"One of the most striking things about shredded pine bark," she explained, "is the woody fragrance that rises when the bark is spread. It is," she said, "so heavenly that the gardener is apt to feel that even if its mulching capabilities are nil it is worth its price in nostril-tingling value alone. But, fortunately for the garden, it is an excellent mulch. Its pine-woods aroma vanishes after a few weeks' exposure to the elements, but its dark color remains pleasing to the eye for at least the two years I have used it," she reported.

"It does not rob the soil of moisture but instead appears to allow every falling drop to penetrate to the earth. Its fine, dusty particles are, of course, quickly absorbed by the soil, but this is such an extremely small percentage of the mulch that its disappearance is scarcely noted, either in the depth of the mulch on the ground or in the bulk recovered if it is raked up for storage during the winter months. The dust absorbed presumably increases, to a slight degree, the acidity of the soil, but does not noticeably increase the demand for nitrogen.

"Possibly because the larger pieces and consequent greater unevenness of the shredded pine bark mulch allow some moisture to escape, but more likely because



the foundation planting suffers from being in the rain shadow of the house, a considerable amount of additional moisture was required by these large evergreens. So, too, the smaller-rooted cuttings in the test bed required a great deal of additional water, but this need not necessarily be laid at the door of the pine bark mulch."

She continued, "When the surface temperature of this mulch was 120 degrees F., the temperature of the soil directly beneath it was 86 degrees, while a temperature of 90 degrees was registered in medium shade with the soil beneath it registering 82 degrees F.

"The other mulching material tested was ground cork—not yet, to my knowledge, on the open market.

"This material was so light and so easy to handle that a 90-pound woman could spread it with ease. It was also so light that I feared the first breeze would blow it across the countryside and that even the moderate force of an ordinary raindrop would dislodge it from place. But I was wrong.

"Scarcely had we spread this mulch when an early-summer thunderstorm raced across the land," she said. "Preceded by violent winds, it let loose a volley of pounding, outsize raindrops, and then sluiced down veritable waterfalls upon the earth. The storm passed, the sun shone, and we went out to view the end of the mulch test that had not yet fairly begun; and there lay the ground cork, smoothly and evenly spread upon the ground, completely unruffled by either wind or water. The cork itself was damp, the ground beneath it soaked, and from that moment through the entire growing season that section of the test garden relied solely on nature for its watering.

"This ground cork is reported, authoritatively, to test one per cent nitrogen, a fairly negligible amount; but its deterioration is so unbelievably slow that it appears almost to be an inert material and its effect for good or ill on the nitrogen content of the soil is not observable except probably by highly scientific testing methods. Measured by bulk, there appears to be exactly as much cork in November as there was in May.

"Well known for its insulating qualities, there should be no surprise that where its surface registered the same 120 degrees F. mentioned before, the temperature of the surface of the soil directly beneath was 82 degrees; and in light shade where the mulch surface showed 94 degrees, the soil beneath showed 78 degrees F.," she said.

"Dry or wet it is completely odorless. Its only drawback—and it is no doubt quibbling to mention it in view of its other excellences—is its pale-tan color which does not enhance the beauty of a planting as a darker color would do."

If a pale tan color is a drawback, you'd never know from listening to hay mulchers. These gardeners spread that pale tan substance over, around and through their gardens with nary a thought that it should be darker to best enhance the garden. For Fred Eaton, for example, hay mulching has too many practical advantages for him to be concerned about whether its color appeals to him. He's been using a hay-mulch for years and finds it a fine labor-saver.

"Make the right start in hay-mulch gardening by making the best choice of the hay itself," he recommended. "*Make every effort to get baled hay.* It's neater, and is much easier to manage than loose hay. It's a

better weed smotherer, and stays in place even in high spring winds.

“Don’t depend on a mulch for a complete soil nutrient provider” he continued. “It’s main value, after decomposition, is as a soil conditioner. It does contain some nutrient value, however, so try to get it organically-grown, if possible. Well-fed hay will return a greater percentage of nutrients to your soil and crops. A rich and early-cut grass hay often contains more nutrient value than a starved clover or alfalfa.

“Before you start to mulch, apply fertilizer in the usual way as you always do. Compost, manures, rock powders, and other organic materials will tend to decompose more quickly under a cooling, moisture-holding hay mulch, so even if you’ve never tried surface fertilizing (or sheet composting) before, don’t be afraid to try it now. We don’t hesitate to use lots of phosphate rock, granite stone meal (good for potash and mineral supply), and a magnesium limestone (only when needed to raise pH.) This general fertilizing program is far from scientific, but it works wonders with plants, probably because, unlike chemicals, it is ‘nature-balanced’ in its original form. All the many trace minerals lacking in straight chemical formulas are present in almost every organic and rock fertilizer,” Eaton continued.

It should be pointed out that such a program of fertilizing is the best, regardless of the nature of mulch you use. But there are some pitfalls in using unrotted organic materials and planting at the same time. These are explained in chapter seven.

“Fertilizing over and done, let’s start to plant. Again, there is nothing special here, and you may proceed to

plant as you have always done,” he explained. “First drop in or sow your first row of seeds. Then go to your bale of hay, and peel off a two-inch layer ‘book.’ Place it alongside of the seed row. Continue peeling off books, until the entire row is flanked by straw. Then repeat this process on the other side of the row. A medium to large field-baled bale should cover about 40 feet of row. Now, if you’ll stand back and look at the results of your efforts, you’ll see a newly-planted row of seed running parallel in between hay books, laid end to end. Who said mulching is untidy?

“Your second seed row should be placed just outside of the second row of books you laid for the first row. Confused? Just lay out seed rows and place one row of books between each seed row.

“By midsummer, the hay should be pretty well on the way to decomposition, and the books should have been compressed to half their original thickness. By this time, some weeds and grass will have fought their way through the hay. There’s no need to hand-weed, however. This is the time to apply a second layer right on top of the first. In late autumn, while closing out the garden season, you should re-cover any bare or thin spots in the mulch rows.

“Next year, you’ll really reap all the benefits of this system. Take a rake or a potato hook, and pull the remaining mulch to one side for a distance of half a book width, so that you expose the ground for a planting row right in the middle of where the path or row of hay was before. Get it? You are now to plant in the richest area, that was the middle of your mulch strip last year. And you are covering last year’s row space to

kill weeds and grass, and make rich soil for a third year," Eaton said.

"You'll find it unnecessary to dig or cultivate this ground before seeding. It will be loose, rich, humus-full, and abounding with earthworms. Just loosen enough ground with the corner of a hoe to get your seed in to proper depth, cover, and tamp. From now on, Mother Nature takes over many of your former duties.

"With this system," Eaton said, "we don't have to cultivate any more. We don't water, except in extreme drought; we do no weeding except at the first thinning or transplanting of the seedlings. Because we applied our minerals (granite dust and phosphate rock) liberally at first, we haven't been adding any fertilizing materials either.

"Only two and a half years of the book system has converted our depleted, packed, humus-lacking soil into a rich, soft, mellow garden that certainly does grow good vegetables. And this land has probably been used and abused for over 250 years.

"In only three years, we have seen our soil consistently in tilth and productivity. The hay mulch, constantly in contact with the soil, not only gives us the usual advantages of a mulch (which would be reason enough to use it), but actually conditions the soil with practically no effort on our part," Eaton said.

Another gardener who believes in a good hay mulch is John Krill. His garden is constantly covered with a mulch of old hay, weeds, straw and leaves. The mulch must be constantly renewed, however, because decomposition reduces its depth quickly. The Ohioan decided

that the best way to handle the renewal was "to grow my mulch right where I wanted it. That would be right over the mulch already spread out over the garden. I bought a bushel of oats and sowed them by broadcasting over the brown mulch," he explained. "Oats are cheap and a bushel sows one heck of a big area. I scattered the oats thickly because I wanted a good and heavy stand.

"What happened? I noticed next day that a few sparrows were gorging on the oats. So what? What could a few tiny birds do to all those oats scattered out there? Next day there were more, and on each succeeding day their numbers increased until I felt sure there were more birds than oats in the garden. I looked skyward for some signs of rain. A good wetting would cause the oats to sprout quickly with the sprouts preventing the birds from eating them. No rain. And very quickly there were no oats," he continued.

"When the rains came much later, the few handfuls of oats that had worked down out of reach deep in the mulch sprouted. They grew lushly, relishing the cool weather. But as I had planned, they never matured. Winter stormed over the land and the tender oats were killed by continuing freezing temperatures.

"The blades that had stood up so erectly were now flat on the surface of the mulch. Snow came and buried them. When spring arrived and the snow had vanished, I found a thick layer of flattened oat blades. This much of my idea had worked. I was determined to beat the birds the following fall. I used two methods, both of them good. Both are practical and may be used almost

anywhere that oats will grow. Oats like cool weather, hence for this purpose must be seeded in the fall.

“The following autumn turned out to be nearly as dry. It seemed to me the birds were already gathering in anticipation of more free oats. I did broadcast the oats, but the birds did not disturb them. There was one prime difference in them this time.

“I had emptied the oats into a tub. Then I poured enough water over them to give them a good soaking. The tub was covered with burlap and placed in a cool, shady place. A garage or cellar provides ideal conditions for this purpose. Everyday I would stir the damp oats, adding water if they appeared to be drying out,” Krill said.

“Then the oats showed signs of sprouting. I kept watering and stirring them to keep rot from setting in. Finally the tub was a tangle of greenish-white oat sprouts. When they were two or more inches long, I waited until evening and then broadcast them over the garden. True, the birds did come down and searched out every grain that they could swallow. But these were grains that had not sprouted for some reason. Those with the sprouts they left alone.

“The sprouts fell in every nook and cranny in the not yet compacted mulch. The blades turned a healthy green and shot upward rapidly. Late September became late October and the sprouts thickly covered the garden with a sturdy growth. But before the blades could set their heads of seed, the constantly intensifying cold slowly withered them.

“Snow buried the fallen oats. The weight of the snow, plus the hard beating of a number of rains flattened

them flush with the mulch out of which they grew. Spring found my garden already mulched with mulch right in place.

“I seeded oats by a second method without going through the process of sprouting them. It is equally good and equally simple to use. I had quite a quantity of old hay which was to be spread in the garden as mulch. Again you must wait until late September or the early weeks of October to use oats.

“I broadcast the oats thickly over the garden. (I must add that sprouting the oats will not interfere with gathering any vegetables which may be growing up until a killing frost arrives.) Over the scattered oats I spread the hay. It makes little difference how thickly the mulch is applied, for by the time it has compacted, the oats will have sprouted through it,” he continued.

“This method also defied the birds, for they could not poke deep enough in the protective mulch cover to reach the grains. A rain soaked the garden thoroughly and in a few days spears of green wove a mosaic over the brown mulch. Once started, the oats grew with a gratifying abandon. Soon they were so thick that the mulch could scarcely be seen.

“Before they could head, winter destroyed them and they fell wilted to the mulch, adding themselves to it. Again snows and rains beat the blades flat. Spring came and the garden was a mat of flattened and dense oat grasses that covered the original mulch,” Krill concluded.

Krill liked the results of his experiment. Years later, he's still using the method. But one man's passion is another's poison, or at least not his passion. Lee Shields,

an Indiana resident, uses another material for his mulch, a material abundant locally, and one he doesn't have to plant. Shields uses old leaves. He gets them from the city during each year's fall cleanup.

The city street department dumps from two to four truckloads on his garden each year when they are removing them from the streets in his neighborhood—all free. This may sound like a tremendous amount of leaves, but since they are wet when dumped by the trucks they immediately start to “heat” and break down. By the following summer, the “mountains” of leaves have been reduced to about one-third of the original bulk. He does not “turn” the piles—they are only handled once. (Other gardeners find that wet leaves tend to “wad” up into layers and resist bacterial action unless stirred and turned occasionally.)

Each year he takes leaves directly from the piles that were heaped up the previous fall, and works them into the soil to steadily improve its tilth and structure. Such application is usually made before the dry, hot summer days set in, preserving valuable growing moisture.

Shields likes to cultivate at least once before applying mulch, and give the soil a chance to warm up well. Then, a heavy application is made right up close to the plants, which will also help prevent them from blowing over during wind and rainstorms. By the following spring, most of the leaves are decayed enough so the rotary tiller effectively incorporates them with the soil.

Using leaf mulches is practical for the gardener since the supply is generally boundless in most communities. And it's practical for the community, which usually doesn't know what to do with its boundless supply of

leaves. In most areas, the leaves are simply burned, which wastes good mulch and puts more smoke into air which doesn't need it.

Waste is the key. Most mulches are waste, to everyone but the mulcher. Dave Shaw uses wood chips, for example. Wood chips would be a waste material to most people, but to Shaw they're nutrients in his soil.

Like Shields, Shaw, a southern New Jersey resident, likes to thoroughly turn his old mulch and sod into the soil each spring.

When first planting a new section of his garden that formerly was sod, Shaw goes back and forth with the



Wood chip mulch retains moisture, controls weeds and creates handsome background for rhododendron plant.

tiller about four times, working it down to about eight inches deep. He then applies a new four-inch layer of chips, adding cottonseed meal and dried chicken manure at the same time. Shaw tried mulching without tilling to break up new ground prior to planting, but discovered it took longer to eliminate weeds and grasses.

At spring planting time, Shaw moves the chips aside, makes a furrow with the hoe, drops in the seed, covers and tamps. As the plants grow, the chips are replaced around them. After crops are harvested in fall, the entire garden area gets several truckloads of chips to maintain the 4-inch depth.

When growing potatoes, Shaw plants them in about 12 inches of chips and straw, pressing the seed into the soil surface. Clean potatoes are picked merely by separating chips and breaking them off plants.

Although for most plants it makes no difference what kind of wood is used, Shaw does apply only pine chips and pine needles to his strawberry rows because of their acid reaction. Ordinary chips are close enough to neutral to cause no problem. The only potential problem with the constant chip mulch is an occasional nitrogen deficiency, evident when foliage begins to yellow. When this happens, Shaw applies cottonseed or bone meal, but, he said, "As long as you keep the chips above ground and don't mix them with the soil, you don't have nitrogen deficiency."

Shaw is proud of the lawn-building job he did at his Godparents' home along the Jersey shore. The soil there was just sand and gravel when he applied 3 inches of chips and 2 inches of old chicken manure. He worked

the mixture in well before planting. "Now that lawn is one of few in the area to have done so well with so little extra care."

He actually has sold so many people on the advantages of chips that "there's almost not enough to go around for everybody who wants to use the chips." In fact, he's glad to have his own chopper. Whenever his supply from tree-trimming crews gets low, he can always make his own chips from his farm's timber supply.

Shaw's primary source of the wood chips is a good source of mulching material for anyone: tree trimming operations. Utility companies and many cities have crews which annually trim branches which overhang their wires and other overhead facilities.

Ohio Edison Company, for example, does this. Instead of burning tree limbs that have been cut down, the Ohio Edison crews put them into chipping machines that shred leaves and limbs alike into small bits of material. This matter, when it decomposes, makes excellent mulch and top dressing. And Ohio Edison gives it away.

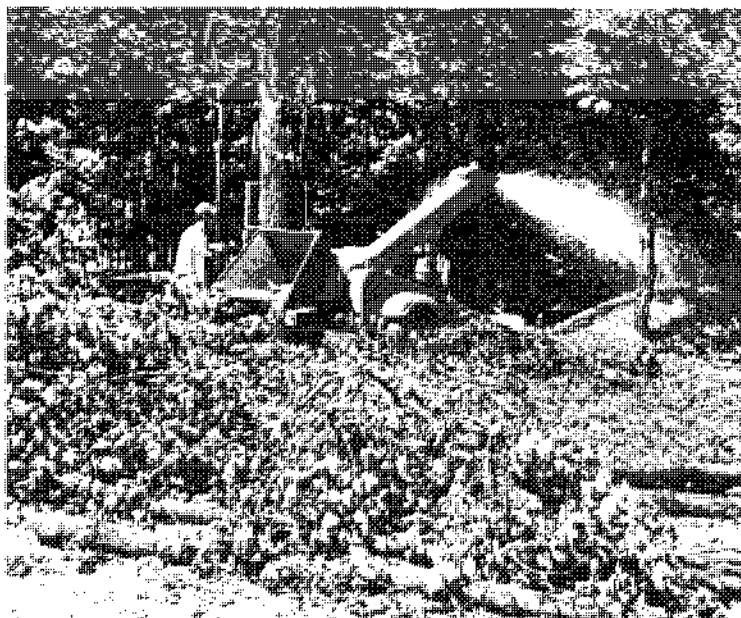
The leaves in the material contribute the most to its decomposition. They break down first and help to decompose the bits of wood, a process that does not occur quickly.

Archer Martin got a pile of the material in July. For several weeks it smelled like new ensilage and continued to be warm for two and a half months, showing that decomposition still was occurring. He expected that by the next summer they would be broken down completely and would do much to improve the consistency of the soil. Meanwhile, he used some of the material to

protect his roses and other perennials over the winter.

“I did not give the chips any special treatment,” Martin explained, “merely piling them in a mound with a depression at the top to catch rainfall. I wet down the pile frequently during dry periods and added wood ashes and grass cuttings atop it for no other reason than that the pile was a convenient place to put them. (To be truly effective, the ashes should have been mixed through the pile when I built it. I shall do that before I use it.)”

Ervin Steinmetz, an Ohio Edison tree foreman, has used the shredded material for winter protection of his



Utility company shredders quickly convert sawed-off limbs and leaves into free-for-the-asking mulch.

roses. He applied it after frost, though, and then spaded it into the soil early the next spring. The mulch shouldn't be put down while still green during the growing season, for it will rob the plants of nitrogen during its decomposition.

A farmer who lives near Steinmetz has been allowing the Ohio Edison Company to dump as many chips as it wants into an old gravel pit on his farm, with the idea in mind that he eventually will use the decomposed material for top dressing his fields.

Ohio Edison considers the use of chippers to be more economical than the old practice of piling whole limbs on trucks to be hauled away.

The utility firm almost always has men clearing limbs away from its lines during the growing season. If they are working in particularly heavy growth, they will fill a truck with shredded matter every hour or so. They haul the stuff to dumps, or to nurserymen and farmers who can use it in unlimited quantities.

The hauling, however, takes time and costs money, so Ohio Edison people are pleased when someone—usually a gardener—comes with truck or trailer to where the men are working and asks for the material. If your utility firm, whether electric or telephone, does not use chippers, a suggestion to the management might open up a new supply of free mulch for your community's gardeners.

And while you're checking the utilities, try calling other local industries, such as lumberyards, milling firms or food processing firms. Mulch is where you find it, and a little scouting around is generally worth the effort.

According to Robert Mead, thousands of tons of sawdust and shavings are used each year as bedding for the booming dairy industry in Vermont, for example. In addition to the natural fertilizer value of the sawdust and shavings, they absorb much of the fertilizer value from the cow manure that would otherwise be lost. Some mills gladly give this away to get it out of their way. At others there is a charge, a common cost being one cent a bushel. Some shavings are baled, with the usual price being 50 to 75 cents a bale.

Many other wood by-products are freely or cheaply available for use as mulch. In addition to the sawdust and wood chips and shavings that have already been mentioned, one can use bark and packing materials; such as shredded paper or excelsior. Peat moss, too, is good mulch.

The by-products of your own or others' gardening activities can be used as mulch. Use those weeds for mulch. And the grass clippings, pine needles, rotted pine wood, corn cobs and stalks and tobacco stems.

In Kentucky, for example, the tobacco remedy is the first thing people think of when their lawns are doing poorly. If it works for them, it should for anyone who has access to the tobacco stems. The remedy is really a mulch of tobacco stems. After the last leaves are raked in the fall, the Kentuckians spread a thick layer of tobacco stems over the lawn. Winter rains and snows leach the nutrients from the stalks into the soil. In the spring, the stalks are raked up. The tobacco farmers themselves use the stalks in some areas, usually tilling them into the soil.

In corn country, widely-used mulches are corn cobs

and corn stalks. Ground into one-inch bits, the cobs have many uses. The sugar content of them will benefit the microorganisms in the soil and will promote better soil granulation. Shredded corn stalks—provided the stalks weren't infested with borers—make a well-aerated winter mulch.

In the southern states, rice hulls, cotton burrs and hulls and pecan and peanut shells are readily available as mulch materials. Most of these materials are rich in nitrogen and potash. They are unusually attractive as a mulch, too. If you happen to live in the northern areas of the country, you may find the nut shells available commercially.

If you live near a brewery, check the availability of spent hops and grain used in the beer-making process. These are good as mulch.

Gardeners in Florida and Georgia often use excess hyacinth plants as mulch. The plants abound in these states. They can be used as is or ground to a pulp.

It all depends, again, on what is cheaply and abundantly available locally. In the Canary Islands, to use a far off example, an old custom, dating back 100 years or more, is to mulch with picon, which are small volcanic pebbles. Picon farming, as it is called, is a variation on stone mulching, which is covered more fully in the next chapter. Its biggest advantage, according to practitioners, is that it conserves, as do most mulches, fertilizer and water, both in short supply on the barren islands.

The custom dates back to the last major volcanic eruption in the islands. When they could get back to their homes, the farmers found their fields covered with



volcanic rock. But it was planting time, and they could do nothing else but dig holes through the pebbles and plant. To their amazement, they had record crops that year and in subsequent years developed the following procedure of protecting the ground with the small pebbles left by the lava flow.

First, furrows are cleared away, and animal manure placed in the soil is covered over, and a top layer of from one to three inches of picon is put on. The row is watered, and when it seasons well, it is planted through holes made in the picon for insertion of seeds or seedlings.

Farmers say a picon covering can be left undisturbed for 20 to 30 years, with only small additions of fertilizer needed from time to time, put in through the holes in the picon at planting time. Watering is unnecessary, for the picon not only holds in what moisture there is, but collects additional moisture from the atmosphere during the short rainy and foggy seasons, and stores it in the ground below. Weeding is minimal, another saving in time and labor.

Chief beneficiaries of the picon treatment are cactus farms, which produce sisal fibers for rope and cochineal insects for carmine and like dyes. But without picon, home gardeners would find it impossible to grow tomatoes, corn, melons, cucumbers, squash or potatoes.

Without a somewhat similar material, Ruth Bixler would have found it impossible to keep her flowers growing. Mrs. Bixler had had tremendous problems keeping anything growing in the shaley soil at her Pennsylvania home. An intensive mulch program saved her vegetable patch and stone mulches—explained in the

next chapter—saved her trees. Nothing worked for her flowers, however, until she discovered and tried a picon-like material.

“One Saturday,” she explained, “I stopped at the feed store to get some feed for our pet rabbit, and right in front of me I saw the answer—bags of ground oyster shell. I bought bag after bag and started shaking it over the beds. I really put it on thick and it was beautiful for the summer; not even a heavy shower disturbed it.

“To my surprise the few weeds that came up pulled right out as if the ground underneath was wet. It cut my weeding time down to once a month (before that every week). The roses were never more beautiful and bloomed until the first snow. I also used it thick on my Mimosa trees and they got through the severe winter without a single loss.”

What this all means is that to succeed in the mulching system of gardening, you have to be what Owen M. Voigt calls a “pack rat.” He figures that’s what he is. Voigt has toured and explored Virginia’s Shenandoah Valley countless times in search of mulch materials for his garden.

“I have become an expert in our county’s various industries, have memorized hundreds of miles of scenic back roads, and have made the acquaintance of many interesting people,” he said. “I now feel I am truly a citizen—almost a native—of the area to which we migrated several years ago.

“Luckily, mulching poses the need for more common sense than funds, so we were able to utilize our limited resources to good advantage. The nooks and corners where our search for material took us were fascinating,

and in the long run as educational and rewarding as the improvement wrought by our horticultural endeavors.

“People everywhere were considerate of our needs. They recognized the basic common sense behind our methods, and were always ready to give us what we needed.

“When I visited a furniture factory for sawdust, the manager took me on a tour of inspection and showed me the sawdust pile which loomed imposingly in an



Shredded pine bark mulch around fruit trees holds in moisture, promotes new root growth.

adjacent field. But he pointed out that it was an overfine residue of many woodworking operations and was prone to cake. He suggested a local sawmill which cuts logs and rough lumber—much better for my uses. I located the mill which was operated part-time by a genial farmer. Here, for just a few cents, I was able to acquire large amounts of good red oak sawdust—enough to mulch my lengthy 500-foot hedge, and to add to my compost heap.

“However, my farmer-sawmill operator passed me on to another and larger mill which uses a debarker system on their logs. They gave me a very generous amount of shredded bark, which I found to be the most successful evergreen mulch I have tried,” Voigt said.

“The soil beneath an inch or slightly more of this shredded bark never showed signs of extreme drying, although we had some very hot suns during the severe droughts. Through it all, the shrubs retained a healthy deep green, while the soil, unrobbed of nutrients and nitrogen, was alive with beneficial insects, fungi and earth worms. I would also like to add that it gives a very professional finish to your vegetable rows and ornamental beds and borders, very pleasing to the eye, while it keeps the weeds down rigorously.

“In the fall of the year, trucks of the sanitation department roam the streets collecting huge piles of leaves with a suction pump. I contacted the chief engineer of the town waste disposal system who told me they were dumped on a public fill project, and were available to all who chose to collect them. Here indeed was a bonanza overlooked by almost all of the local horticulturists, many of whom still burn their leaves. The action

of the pump in sucking up the leaves grinds them up into a powder, so I was able to collect close to a ton easily. Last year when I made the mistake of spreading them in the spring, the ground was very slow in heating up. So this year I plowed them under in the fall, letting the now-abundant worms and bacteria consume them through the winter.”

As Voigt toured the valley looking for mulch materials, he also kept his eyes open for organic fertilizers. “I consider a large supply of burlap bags in the car’s trunk an absolute necessity,” he said. “It’s also advantageous, I find, to keep a small notebook which lists places and areas cited by friendly advisers as possible sources for more and different organic complements.

“Trouble, and time-consuming? Yes, I guess it is if you mark down each moment to drudgery. But what are adventures into the back roads and bypassed nooks of your community? And what is that pioneer’s satisfaction that comes with building a really fine garden from a square of waste soil? Is this trouble, is it pleasure, or is it achievement?

“Two years ago, local gardeners considered my methods a little nutty—to say the least. But this fall I caught my neighbor quietly sneaking in a load of leaves to cover his garden.

“It looks as if being a pack rat is contagious!”

## Chapter Five

# STONE MULCHING

When “Pack rat” Owen Voigt first started roaming the Shenandoah Valley in search of mulching materials, one of his first specific desires was stones—big ones, little ones, round ones, jagged ones—just stones.

“If you have never used a rock mulch,” he said, “I heartily recommend it.” For Voigt, a big factor was that rocks aren’t too hard to find and are used just as they are found. All he had to do was find a rock, plunk it in place and he had mulch. Moreover, rocks are free.

Rock mulching is pretty much like every other kind of mulching. Rocks do everything that other mulches do. In some instances, they do it better. They are, for example, exceptionally good for conserving moisture and moderating daily temperature fluctuations and particularly good at maintaining soil structure. And when

was the last time you saw a weed sprout through a stone?

Most any vegetation can be stone mulched, but it works particularly well for trees and it looks particularly good with flowers and other decorative vegetation. L. T. Servais, a Green Bay, Wisconsin, gardener and rock collector, uses his functional stone mulches to show off his collection.

"I have been using rock mulches around fruit trees for 20 years now with good results," he said. "As a rock collector, I at first kept my collection of specimens from a dozen states and Canada in the house. But when they really began to get in the way, cluttering up closets,



A mulch of rocks combines neatness with moisture conservation while it discourages weeds.

shelves and cabinets, I moved them outdoors and put them to work around my trees. I have replaced the more drab stones now with rose quartz, gleaming obsidian, and shining feldspar to add a bit of glamour to my tree plantings while helping them to grow better."

While a rock mulch's ability to make a garden look better might be a matter of opinion, its ability to make plants grow better appears to be a historical fact. Evidence of stone mulching in ancient Rome has been found in the writings of Virgil, the great Roman poet. His agricultural directives included the following instructions:

"Finally, put your rooted grape cuttings firmly down in the ground, be sure to add sufficient earth and sprinkle rich manure over it. Also dig in some stones, perhaps pumice, perhaps rounded sea shells; for, between these, water will seep down and the air will gently penetrate and inspire growth in your plants. I have even found some who loaded heavy fieldstones on top or considerable weights of broken pots; this is protection against cloudbursts and against the hot summer heat which cracks the thirsty fields."

Columella, who was the best prose writer on agriculture in Roman times, related that stones were placed even between the roots. Similar practices prevailed in olive groves. The olives like lime stones particularly. The olive was planted in trenches four feet deep into which it was the custom to deposit stones for encouraging moisture around the roots.

Stone mulching has been used to great advantage on the Organic Gardening Experimental Farm. Author

and publisher J. I. Rodale did quite a bit of successful experimenting with stone mulches.

"Somewhere in the 1940's," he wrote some years ago, "I got the idea of growing vegetables in a stone garden, with alternate layers of soil and stone . . . For almost 20 years we have planted vegetables in this garden with excellent results. It seems that something about the stones communicates itself into the plants to make them grow faster and be healthy . . .

"The one bad feature of this kind of a garden was that the weeds would grow between the stones and could not be cleaned out as with a weeding tool in a conventional garden. They would have to hand-picked. So one day . . . while my wife Anna and I stood looking at a stone section overgrown with weeds, she observed, 'Perhaps if we would put another layer of stones over the existing ones, it would be more difficult for the weeds to poke their way through them.' No sooner said than done."

That experiment turned out to be as successful as the original test of the stone-mulched garden itself. Rodale reported some of the more unusual and unexpected benefits of rock mulching. It is, for example, a good method of plowless farming, that is, farming in which the upper layer of soil isn't disturbed. He reported that plowing can be used, but that it isn't necessary to plow deeply. In the spring, the upper four or five inches of soil is merely stirred about a bit before seeding. This stirring is easy because the earth is soft and moist between the stones. If some organic fertilizer is being used, the shallow plowing keeps it close to the surface where it will be more accessible to oxygen and will decay faster.

"A stone mulch causes the earth under it to be well-aerated, usually more so than exposed soil, strange as it may seem," he wrote. "You can verify this by merely looking at a stone resting above the soil. The rain causes a shallow channel to form in the soil under the outer rim of each rock, permitting air to enter, whereas the baking action of the sun on exposed soil and blowing of wind over it harden the surface into crusts that can be lifted up bodily.

"The conditions under stones are ideal for bacteria, earthworms and other burrowing insects," he continued. "A dampened darkness prevails that is favorable for the working of bacteria and beneficial insects.

"Groves of sickly limes, citrus trees and other fruits have been revived when rocks were piled high around the trunks to help keep the bark from scorching and the roots from becoming dry and hot. The vigor and growth of both ornamental and fruit orchard trees is increased by rock mulching when teamed with sound organic care. Consistently better yields and quality of plums, peaches, apples and cherries have been reported by many gardeners and farmers using the rock-mulch system. Young fruit trees have been especially benefited in getting a strong start," he wrote.

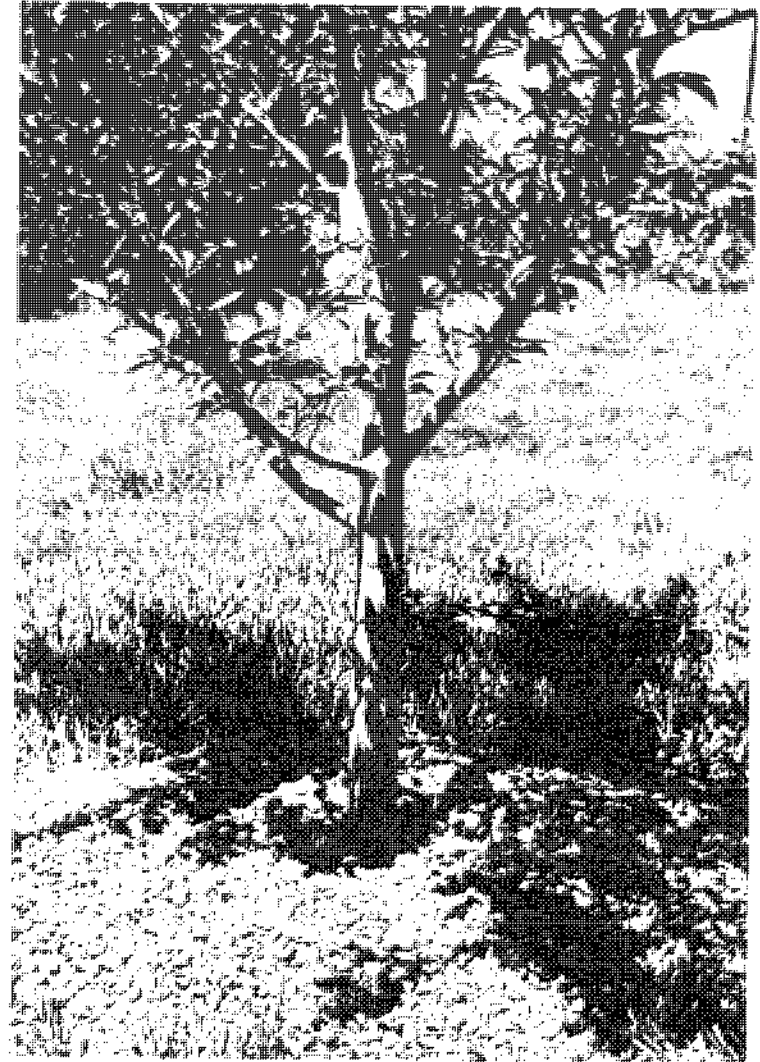
Margaret L. Wood is a stone mulcher whose experience with the system tested it to an extreme. She had read about the system and its results at the Organic Gardening Experimental Farm and elsewhere. She viewed it as something of a last resort. Mrs. Wood and her family live in Arizona's Mojave Desert. Since every drop of water used by the Woods, their dogs and cats, horse, cattle and sheep and their plants must be trucked

in, the moisture conserving qualities of a good rock mulch were on the line.

“We took possession of our new home in a July following an unusually wet period in May and June,” Mrs. Wood explained. “The trees and shrubs were green and lovely. Then the weather returned to normal. In Arizona that means *hot* and *dry*. The ground baked until a hoe just bounced off it, and you couldn’t dig a hole without first soaking it for an hour or so. Hauling water became a daily, not weekly chore, but even so the shrubs and shade trees drooped and shed most of their leaves. The tips of branches on the fruit trees died back. The evergreens looked limp and actually seemed to shrink. Everything wilted, including us. The situation looked hopeless,” she said.

Then she remembered Rodale’s stone mulch. “If there was any one thing we had lots of on our desert land it was rocks—big rocks, little rocks, granite, quartz, turquoise, sandstone, limestone—we had them all. From then on, every morning and evening, and even some afternoons, found the children and me out hauling rocks in a wheelbarrow and garden cart. Judging by the expressions on their faces as they drove by, the neighbors must have been pretty certain that the sun had gone to our heads.

“The first thing we tackled was the shrubs and bedding plants against the west side of the house. Afternoons they were broiling and mornings, when it was shady, the seven kittens were literally tearing them to bits. We gave the whole bed a quick overall cover of fist-sized rocks which the contractor had obligingly left pushed up nearby, soaked the covered bed for a couple



Stones in a rainbow of colors prove mulch can be decorative as well as protective.

of hours with a sprinkler hose turned upside down, and as simply as that the flowers and bushes stopped dying and actually began to grow. A few even bloomed. Now don't misunderstand me. I didn't say that suddenly we had a lovely flower bed. This was still the desert in July and the soil in the spot was hard and barren, but these plants were now at least holding their own, and they continued to do so if watered lightly with the sprinkler hose once a week," she continued.

"By now it was obvious that the foundation planting in the front (the east side) was losing its battle with the dogs and the heat, so we worked on it next. We were now able to scrape up a few wheelbarrow loads of manure in the corral, so we could do a more thorough rescue job here.

"First we made a manure dike a foot high, a foot across, and 18 inches from the plants the full length of the beds and across the ends. This was then shored up on both sides with the biggest rocks we could manage to get into the wheelbarrow. The top of the dike was covered with smaller rocks to keep it from weathering away.

"When we had finished, the two beds in front had become, in effect, two rock-bottomed reservoirs bounded on two sides by the manure-rock dikes and on the other two by the foundation and the cement steps," she explained. "We filled them with water to a depth of eight to 10 inches and let it soak into the ground, and these bushes grew and flowered and the little pyracantha set a full crop of large, well-colored berries.

"Again, this was no lovely flower bed. These were small shrubs two to three feet apart, and partially hid-

den this first year by the big rocks—but they grew, despite the heat, on only one watering a month from then on.

"Our next project was the rhubarb and shrubs along the north side of the house. They received the same treatment, and the rhubarb continued to send up new growth all summer," Mrs. Wood continued.

"By this time our backs were stronger and our manure pile bigger, and we decided to see what we could do for the trees, grapevines, and rose bushes which were too widely separated for that sort of treatment. Since we had finally run out of readily available rocks, we began by building circular manure dikes two to three feet from the tree trunks, wetting them down with the hose and letting them "bake" in the hot sun. These were then filled to the top with water every 10-14 days and the trees began to grow. Some of the Scotch pines grew more than a foot through August and September, and later the fruit trees began forming blossom buds for spring. The roses appeared blighted or diseased, so they were pruned back almost to the ground after diking, then responded with fresh, healthy new growth and a few perfect blossoms for Christmas.

"Meanwhile, we hauled in rocks whenever we could. As each tree was rocked up, a six to eight inch layer of trash from around the hay stack was placed between the tree trunk and the dike to make it easier to tuck in sprigs of myrtle and sweet alyssum and a few bulbs here and there," she said.

It took muscle, some perseverance and lots of a cheap and locally abundant material—rock—but the Woods finally got their little chunk of the desert blooming like

an oasis. And it wasn't a mirage, either.

Another stone mulcher is Georgia Montfort. She didn't find herself in a do-or-die situation such as the Woods. For her it was a matter of developing a rock garden for show and watching—somewhat amazed—as her plants slowly gravitated to the areas best suited to their health. Those areas happened to be on a 50-foot sandstone terrace located between the rock garden and the lawn.

“First, drifts of my favorite wild red poppy appeared in two or three places, blooming more vigorously and colorfully than they had before. Next, portulaca—normally quite difficult to establish in beds—put in a surprise appearance on the sunniest part of the terrace. Then alyssum cascaded onto the sunny terrace,” she said.

“By now the floral migration was on, and the penstemon, which had been unhappy in a well-tended bed, marched boldly out into the flat sandstone to flourish brilliantly. Evening primrose appeared, growing to fantastic proportions and far excelling anything found in its normal habitat, while another wild specimen—the little blue violet—became a permanent resident, cropping out between the cracks in blue masses.

“Since the development of the first terrace-dwellers far exceeded anything that had been planted in the nearby beds, I soon began to plan and regulate flower growth on the terrace, obtaining added beauty and color with practically no extra effort, and without interfering too much with what was going on. I also began to realize with increasing clarity the numerous advantages offered by the stone-mulched terrace and why my

plants were seeking them out without being particularly invited or encouraged.

“Contrary to my expectations, the terrace newcomers did not wither for lack of moisture, nor was their growth stunted during the hot season. Because the porous sandstone seems to reduce evaporation, I found it necessary to water only when flower growth was dense and tall. Sometimes, when a stone broke or chipped, I lifted it to find the soil moist and pliant, well-aerated and teeming with active angleworms beneath. Capillary root growth became so pronounced that, in many instances, the tiny but vigorous root systems penetrated the stones themselves. Another growth-promoting factor came from the slow disintegration of the rocks which deposited rich minerals in the soil. In addition, most of the wild flowers prefer the slightly acid condition created by the sandstone,” Mrs. Montfort said.

“Although I had long been aware of the many advantages of rock gardening, I now realized that a flat sandstone terrace offers the same benefits but on a much wider scale. Besides moisture storage and weed control, the stones moderate extremes of temperature, keeping the soil below them cool against the heat of the sun. Root growth is steady and vigorous, low foliage is protected against spattering when it rains, and a clean, attractive background is provided for creeping, low-lying blooms.

“It wasn't necessary to plant seeds deliberately on the terrace because other flower combinations occurred quite spontaneously as highly welcome additions. Among these, the delphiniums established themselves in thick profusion—their curled green crowns appear-



ing consistently between the cracks long before my regular beds even thawed.

“Such are the advantages of terrace gardening—however unintentional!—that early germination is now counted upon with confidence. Long before the frost was out of the ground in the garden, my poppies and portulaca put in a startlingly early appearance. Despite the freezing nights, cold winds and even intermittent snows, they continued to develop—hardy wild pioneers who know what’s best for them and where to find it. Anyway, the snow melted quickly on the sunheated terrace before it could do any lasting harm.

“So,” said Mrs. Montfort, “don’t be dismayed if some of your favorite plants insist on wandering through your garden, away from the spots you have prepared so carefully and lovingly for them. They know what they’re doing and what they’re looking for, so don’t fight ’em—encourage them. That’s what I did, and the entire garden benefitted when my wild flowers insisted on moving over to my stone-mulched terrace.”

Ruth Bixler’s trees benefitted when she turned to stone mulching. It was for her—like for the Woods—something of a last hope. After she and her husband acquired a small tract near Allentown, Pennsylvania, and constructed a home, she discovered their proposed garden plot was shale. A period of composting and mulching cured the gardening problems. But her flowers failed and her trees started to follow suit.

“When all my spruce trees died but one,” she said, “I decided to do something about it. My fruit trees had a struggle to get rooted, too. A Chinese walnut tree gave

up and died. I also realized then that the sprinkling system was not the answer.

“Why, I asked myself, does a tree grow high and handsome in the woods under the same sun, with no surplus water, and in my yard refuse to grow? Finally, I made a trip to the woods and the first thing I noticed was the stones under the trees. And then I knew that it was the stones that helped hold the moisture.

“In July of that year we spent our vacation along Lake Erie. The grade going down to the beach was full of round, flat stones. The day we started home, our car trunk was half full of these. That week I laid the last spruce thick with stone. In a month the tree started growing and stayed green all summer in spite of the hot, dry weather and few showers,” she continued. “It never stopped growing and is now a beautiful specimen. The next year I brought more stones home and started putting them around the fruit trees. A Yellow Transparent apple tree grew quickly after the stones were put around, and has been bearing very heavily ever since.”

Without realizing it, Mrs. Bixler may have been doing more for her trees than merely providing a handy reservoir. A. P. Thompson, a Shenandoah Valley orchardist, has been growing apples the organic way for years. Part and parcel of his method is mulching, with a generous number of stones included in the mulch. He cites not only the moisture conserving qualities of the stones as a reason, but others as well.

Thompson uses what he calls the “fortress method” of stone mulching, claiming it has four benefits. It gives the trees greater anchorage in strong winds. Further, it

acts as a heat sink by absorbing a great deal of the sun's heat during the day. On frosty nights, this heat sets off minor convection currents that provide some protection to bud and bloom. The fortress also provides protection for the tree's roots from burrowing mice, which oftentimes damage or kill trees. And finally, the rocks provide calcium and magnesium for the tree as they weather.

The fortress method, one of the most unusual of Thompson's many offbeat orchard management practices, involved erecting a six-inch high wall of half-inch dolomitic rock around the base of each tree. About 500 pounds of stone goes into each five or six foot diameter wall.

Servais, the Wisconsin rock collector, developed a similar technique for nurturing young trees. He explained his mulch, saying, "Last year I placed 100 pounds of rocks around two young pear trees and a blue plum as soon as I planted them, and then gave them a heavy soaking. I didn't want to lose them because of air pockets around their tender young roots—which has happened in the past.

"My trees all came through the summer in good, healthy condition, justifying my theory that the weight of the rocks gradually squeezes the air out of the newly worked, dampened soil," he said.

The experience of John S. MacManes with sick trees offers further evidence in support of J. I. Rodale's conclusion that rock mulches greatly benefit trees. Even the fertile ground of the Finger Lakes region of upstate New York couldn't do much for MacManes' sick peach tree.

"If we were going to save it all," MacManes decided, "we would have to rock-mulch it, we agreed, at the same time giving it plenty of compost, leaf mold and wood ashes in order to sustain its will to live. Otherwise, the tree looked bad on the following counts:

"1) It was too old, well past its prime;

"2) Leaf curl had blighted its foliage almost completely;

"3) It was suffering from gummosis, was ill-shaped and worm infested;

"4) The northwest wind hit it full blast throughout the winter.

" 'Cut it down,' the neighbors said, but we were stubborn. We had noted some timid and sparse new growth and felt that 'where there's life, there's hope.' So we pitched in, and I began my own private battle to save our tree," he continued.

"First I applied a booster dose of finely pulverized limestone right under the tree, and then added a generous top-dressing of good wood ashes. Next, starting at the drip line and working to within a few inches of the trunk, I heaped poultry droppings, leaf mold and compost. And finally, I worked over the entire area, setting a good ground cover of rock mulch to regulate soil temperature and moisture, to encourage extra bacterial growth in the soil, and also to supply the trace minerals which our tree obviously lacked. Then we sat back, eager with expectation, to see the results and reap our reward.

"Nothing happened. The tree didn't die and it didn't seem to be getting any better.

“But the spring and summer of the following year told a much different story, as the magic in stone mulching began to assert itself.

“The season came on extremely dry, which tended to slow up growth everywhere—what our tree needed was rain. But, despite the baking sun and drying winds, new growth took place before our eyes, and we were agreeably surprised and pleased with the richly vibrant bloom at blossom time. A beautiful green again enfolded our tree, leaf curl was reduced drastically, gummosis practically ceased.

“That harvest time we picked bushels of lusciously big peaches—each a handful in its own right—from our once-dying tree,” he concluded.

Michigan planter Walter J. Muilenberg discovered that even the frail Canadian Hemlock tree can survive out of its element with a good rock mulch. In Muilenberg’s area, the tree is never found in pure stands. It’s always mixed in with hardwoods which protect it from wind and sun.

It seems impossible to transplant them and make them grow under ordinary conditions. Muilenberg was clearing land and pulling out stumps when he came upon three hemlocks. He decided to let them grow and cleaned out everything else around them. A lot of stones accumulated and by sheer accident they were piled under one of the hemlocks. That is the only one that lived. The other two died in a few years. The peculiar thing is that the one with the stone mulch became a wonderful specimen, far superior to the twisted and scraggly hemlocks usually seen in the forest.

“It is my guess that the third hemlock survived be-

cause of the rock, a weight of several tons, which had been piled around it,” Muilenberg said. “It had grown up in heavy woods, which consequently helped to make it more shallow-rooted, and in heavy shade, which helped to keep the soil cool and moist. Later, when the rest of the trees were removed, rock gave the tree a good grip on the soil and made for a cool, moist root-run, as rock always does. It would seem that the top of the tree will get along in good shape so long as the roots have protection.”

Stone mulches, of course, needn’t be accidental, haphazard or last resorts. They can be tremendous additions to an existing garden or the center of a new one. A stone mulch can be exactly what you want it to be, because you can make the stones, as Robert Rodale once explained.

“My father, J. I. Rodale, has had the idea for many years that mulches don’t have to be dull, and they don’t have to be just organic either. Many a day in my youth was spent hauling rocks from quarry and fence row to make stone mulches for around trees, and even for lining the rows in a special vegetable garden. A stone mulch has certain advantages over any other kind. It lasts, for one thing. As the stone ‘decays’, it also adds minerals to the soil. But stone mulches have disadvantages, too. Their biggest problem is the odd sizes of stones, which make them difficult to fit together into a neat, flat surface. It can be done by an expert mason—but a person who isn’t a mason might have trouble making a geometric pattern out of rock.

“The idea of making different-shaped concrete segments that would fit together into unusual stone mul-

ches came to my father several years ago. He had some concrete molds made in square and rectangular shapes, and cast enough of the blocks to make several different beds. One of his concrete mulch variations is now an herb garden. The most-noticed one, though, is the round 'target' garden along the highway in front of my house.

"These concrete mulch gardens have turned out to be one of those unusual garden features which attract attention year after year. They are something you can make yourself, if you are handy with tools and can make the molds. The concrete work is simplicity itself, because no fine finishing is required. You can even make them in different colors by adding dye to the mix," he said.

The most commonly used shape in the Rodale garden is a triangle. In the mixture for the cement slabs are included some crushed rock and some mineral fertilizer powders like phosphate rock, granite dust and dolomite. These minerals slowly leach out into the soil. The recipe for the cement includes one part cement, one and a half part sand, one and a half part stone, a half part dolomite and a half part phosphate rock.

"We also add finely powdered coal dust to the mixture, not only for its minerals, especially sulphur, but also to darken the triangles, in order to make them retain heat better," J. I. explained.

"There are three different sizes of triangles, so that they can be made to fit together in a circular pattern. The sizes are 12 by 12 by 12 inches, 10 by 10 by 12 inches and 10 by 10 by 14 inches. The larger one is made with a pool-table billiard ball rack triangle. This was the

idea of John Keck, our farmer-technician, who went at this project with great enthusiasm and who practically worked the whole thing out by himself. He made the slabs a few at a time, in his spare time, but it's surprising how little by little things add up.

"One of the advantages of this method is that once a year the slabs can easily be taken up and the soil given a complete working over," J.I. continued. "The most interesting thing about it is its beauty, and the fact that a person with some imagination can vary the designs. Almost any shape of metal form for the molds can be made by a welder or blacksmith."

"A lot of people get in a mulch rut," said the younger Rodale. "Perhaps they have one kind of mulch material available to them, and use it year after year. While that is the easy way, it can't be counted on to give the maximum in beauty to a garden. We should think more that the mulch around trees, shrubs and flowers is a dynamic feature of the garden, and not just something to hold down weeds, preserve moisture and feed the soil. Of course, those are the big reasons for mulching, but we shouldn't forget beauty as well.

"Mulches of small stones and gravel are becoming more popular lately, spurred perhaps by the Japanese school of landscape architecture which features such things as raked areas of sand and boulders artistically scattered throughout a garden," he said. "One of the most popular of these mulches is river gravel, the small stones collected from stream beds, where they have been washed and rolled by the waters for perhaps hundreds of years. Those stones all have rounded edges and are of a variety of colors. Best application for them is

along a building or near areas of concrete such as walks or patios. They provide a welcome visual relief from flat, uninteresting pavement or big walls.”

A stone mulch is, as Servais the rock collector said, adding “a bit of glamour” to your plants, “while helping them to grow better.”

## Chapter Six

# WHY WE REJECT ONE of the MOST COMMON MULCHES

Extensive experimentation has shown marked increases in vegetable yields resulting from the use of black, polyethylene plastic mulches. Many gardeners have enthusiastically adopted the use of such mulches. It seems like such a good idea. But it's not.

Most people overlook one important fact. They see that plastic mulches are cheap, effectively control weeds and efficiently conserve moisture. And they fail to see that a plastic mulch contributes nothing to the fertility of the soil. It's only shelter, not food, too. An organic mulch is both.

When you stop to think about it, what could be more unnatural than a product like plastic mulch? Plastics are non-organic substances which add nothing to the soil except trouble if you try to grow crops where they

have been buried. There is, in fact, some reason to believe that the formaldehyde given off in small amounts by some plastics can actually kill soil bacteria and thus interfere with plant growth.

The durability of plastic, at first counted as its prime virtue, has become instead a monumental pollution problem, for unless it is burned, plastic is virtually indestructible. Since burning certain kinds of plastic, particularly polyvinyl chloride, gives off toxic fumes such as hydrochloric acid—labeled by the New York City Commissioner of Air Resources as a “serious environmental hazard”—burning is not a safe disposal method. Even the DuPont Company, famed for creating “Better Living Through Chemistry,” and a leading plastics manufacturer, has found no more satisfactory method of disposing of plastics than to bury them. Should we continue at our present pace, there will hardly be a square inch of land on the continent in which some form of plastic doesn’t lurk six inches beneath the surface.

Studies into methods of degrading plastics have been conducted in the United States, Sweden, Great Britain and the Netherlands. No answer has been found, and many authorities are beginning to recognize that we are coming face to face with a very serious problem.

Ironically, organic gardeners, dedicated to preserving a healthful and attractive environment, are nevertheless unwittingly contributing their share to the nation’s reputation as a plastic society. Without giving it a thought, most of us end up with at least half a dozen disposable but indestructible plastic packages every

time we go to the supermarket. But more than that, some actually use plastics deliberately in their gardening!

Plastics are convenient, quick and durable. That they are a labor-saving mulch is plausible. After all, they don’t have to be replaced periodically as do those organic mulches which keep disappearing into the soil. But the fact that the non-organic plastic mulch doesn’t disappear—ever—is its prime drawback.

It should be noted that another increasingly popular non-organic mulch—if handled properly—doesn’t have this drawback. That mulch is aluminum foil, which can be recycled. Aluminum foil mulch has many of the advantages of plastic mulch, plus some it doesn’t have—such as an insect-repelling, photosynthesis-boosting reflectivity. But, like plastic, it won’t ever boost the fertility or tone up the condition of your soil. If you must use a non-organic mulch, use aluminum foil. And when you’re through with it, recycle it.

But before you do, read what Ruth Stout, that mulching pioneer, has to say about plastic mulches. Most of what she says will apply to aluminum foil mulches as well. Despite the plausibility of claims that plastic mulches cut the labor in mulch gardening, Miss Stout plans to stick with her tried and true methods.

“A month or so after my first book about year-round mulch was published in 1955, I got a letter from a business firm in New Jersey, asking permission to send me a gift of black plastic, which was, of course, to be used for mulching my garden,” she said. “My reply was, in effect, as follows: ‘Thank you very much for your offer, and since I never refuse a present, I will

accept the plastic. However, I think it only fair to add that I may never use it. And if I do (just to try it out), I will almost certainly write about it and speak of it, not for it, but against it, comparing it unfavorably with the kind of mulch I use.'

"Needless to say, that New Jersey firm didn't send me any plastic.

"In writing about gardening, and giving talks on the subject, I try very hard to stick to my own experiences. However, all one needs, in my opinion, in order to be able to figure out what's wrong with plastic mulching is a little imagination and a little common sense.

"Let's say that a person who was rather short-changed when imagination was being passed around decides to use a plastic mulch instead of hay on a garden the size of mine (45 x 50); he figures that, for one thing, the plastic will cost less, since it lasts forever. Well, here's news for him. Plastic won't be cheaper because, since it doesn't supply the nourishment needed to keep a garden producing, he will also have to buy fertilizer each year to make sure that his plants get what a mulch of hay gives them; the hay rots and provides the soil with all the required nutrients" she continued.

"And of course all other vegetable and organic matter that rots—straw, leaves, corncobs, wood chips, kitchen garbage—will nourish your soil; cornstalks and the tomato, bean, asparagus plants should all be left on your plot, in order to do their share of providing nutrients.

"I have heard it said that there is less to do in a garden if you use a plastic mulch rather than an organic one, and I wonder how growers operate when using the

former. Since it seems to be less work, I suppose they just spread the plastic on their plot in strips, then ignore the whole thing.

"For the moment I am going to pretend that for some odd reason I've decided to use plastic for mulch on my 45-by-50 plot. Let's say that I put down strips of plastic, leaving a small space between, and I drop the seeds in the exposed area. But first I must do something about enriching the soil, and maybe buy some organic fertilizer. But what? Manure? And do I make a compost pile? I'll certainly skip that, for it's quite a lot of work to get the materials together. Then, when the pile has become rich soil, I'd have to load a wheelbarrow with it and distribute it all around. Well, that whole routine is 'out of bounds' as far as I'm concerned," she continued.

"Now I go ahead and put in the seeds in my plastic-mulched garden and the plants show up and so do the weeds—in the spaces between the plants right in the rows which have to be made rather far apart. That is, the corn does, and potatoes, and squash, and tomatoes and, in fact, almost all the plantings. The question of weeds isn't a problem, of course, if you use an organic mulch. The hay, or whatever you use, is lying there in the row, as well as alongside it, and will keep just about all weeds from getting anywhere.

"At last, the first summer of plastic-mulching my plot is over, and finally another spring shows up—time to plant early crops. But when I go out to the garden, I'm nonplussed; I can't get rid of the idea that the plastic which was supposed to save me a lot of work, should certainly be moved to other areas. Why do I feel that? Well, I keep thinking of that good earth under the

plastic, and it seems absurd not to make any use of it. And the small open space, which I used for planting last season, doesn't seem to be adequate now, so the only thing to do is to move those black strips to other spots, and that would certainly be a tedious job. (I will admit that maybe I am being unreasonable, and that it may be quite all right to cover up a lot of your soil with plastic and never produce anything in those areas, but the whole idea sounds goofy to me.)

"However, if a person is wise enough to use organic matter for mulch, all he has to do in early spring if he wants to plant some lettuce and parsley in whatever spot he may choose, is just pull the hay aside (if he hasn't already done that in the fall) and put in the seeds.

"About asparagus, I just can't believe that anyone at all familiar with how this vegetable operates would use plastic in that bed. Asparagus likes to wander around and come up wherever it pleases. And it likes a rich soil—just as weeds do, unfortunately. But an organic mulch will, as I said, dispose almost entirely of the latter. As you may know, asparagus stalks can, and will, push up through a hay mulch, which they could of course never be able to do if your plot is mulched with plastic.

"You also may know that air, rain, dew and sun reach the soil right through organic mulch. A plastic covering keeps all of these beneficial things from reaching the earth, although it's true that plastic will keep the ground damper than it would be if the soil stayed bare. But hay and leaves not only keep the earth moist, but also let dew and rain enter the soil, and help to hold the moisture in.

"Since I started to use organic mulch, we have had several seasons with long droughts—one summer no rain at all for three consecutive months. Although I can't water any plants in dry weather because my well is very shallow, yet I didn't lose one vegetable through those dry spells. Squash needs lots of water but despite that season with a three-months drought, I had an over-supply—one of the Blue Hubbards weighed 51 pounds," she said.

"When one of my neighbors (a confirmed organic gardener and mulcher) dropped in, I spoke of this plastic. Although I knew she didn't use it, I asked her if she could think of anything at all in favor of it as a mulch.

"My neighbor said that plastic is supposed to warm up the soil more quickly than hay. When I asked why she thought this, she hesitated for a moment then said that someone must have told her it did. 'Well, even if it does, what's so important about that?' I asked. 'You can, for instance, plant lettuce on frozen ground, and it doesn't seem to mind. After all, it's only early plantings that need warmed-up soil; the sun does the job for later crops. So for parsley, lettuce, peas, all you need do is take the hay off those areas in the fall and, in my experience, the ground is then never too cold to interfere with desired results.'

"She had one more suggestion which she thought might be favorable, and that was that since squash plants take up so much room in a garden, black plastic might make it easier to keep down weeds between the hills. However, I plant squash between my two rows of asparagus, and I've already said why I wouldn't use



plastic for the latter, even if I went a little haywire and wanted to do so," she concluded.

If you are concerned about producing those abundant, nutritional crops next year and next decade and next generation, you, like Ruth Stout, won't mulch with plastic. You'll find it cheaper to spend once—if at all—for a good organic mulch which will rot and fertilize your soil in time. You'll find you can do as well or better without plastic, the indestructible, non-nutritional mulch.

#### ... AN ALTERNATIVE TO PLASTIC MULCH

So now the whole mulch idea has been ruined for you. Plastic mulch was all you were looking for in a mulch. Using it, you didn't have to scour the world for lumberyards with excess sawdust or farmers with spoiled hay or harrass your neighbors for leaves and grass clippings—they were beginning to think you daft, right?—or even continually spend money for more, since that organic stuff *did* keep disappearing. You could be completely respectable and order some from your local plastic mulch store, put it down in the garden and forget it. Well, maybe those shiny black indestructible strips in your garden lacked the visual appeal of a variety of rocks mulching away, or the warm richness of a layer of cocoa bean shells, some other natural mulch. But it could be acquired without people giving you funny looks and it didn't mess up the inside of the car and . . .

But it's ruined, right? Okay, try this. Use newspapers.

After you've read all the news, go out and throw it on the ground. It's one of the most effective ground coverings around. And it's organic. Even the ink provides trace elements vital to healthy plant life. Chances are, you have stacks of newspapers in your basement, just sitting there gathering dust and creating a fire hazard when they could be in the garden decomposing busily and creating good, rich soil.

Environmentally-minded mulchers have found that mulching with newspapers not only provides a great way to safely recycle as much as 50 per cent of our refuse but also to control weeds, improve soil texture and regulate moisture and temperature in the garden. They have been using newspapers for years to create a humus which is readily incorporated into the soil.

Here are some of the ways they've been doing it.

1) Laying them out in varying thicknesses of unfolded sheets, leaving space for rows or planting in holes punched through the paper;

2) Shredding or tearing the sheets into a fine aggregate which can be easily handled in beds and borders, also around trees and shrubs;

3) Using them as a liner under materials to conserve moisture;

4) Burying them with the family garbage in selected areas after tearing them into very small fragments;

5) Converting them into a highly mobile, flowing slurry by combining them with water in a pulping machine.

Mrs. Sherrelle Ault slides unfolded newspapers under "poultry netting" one foot wide. Number 9 wire or

coat-hanger wire cut about eight inches long, is bent into a "U" which goes on each side about three feet apart, and is pushed into the soil.



Newspapers eight layers thick keep trees and shrubs free from weeds.

"To renew the newspapers each year—and you must as they decompose underneath," the Missourian said, "take out the wire U's on one side, slide fresh newspapers under the wire, and replace the U's. I don't try to do the whole garden at once, but just go along—150 feet of wire costs \$5 here. But I don't need to buy it again because it lasts and lasts.

"The appearance is fine," she said. She also explained how she used newspaper and waste pulp to tame her stubborn hardpan garden soil.

"I have gumbo cement for a garden, and lots of luck to anyone who tries to plow on that site—no telling what else was buried there by a bulldozer. This was the only way to go ahead. Not being able to dig down deeper than one inch, and being on low ground which stands in water, the only thing to do was to build on top.

"This is also a great way to dispose of all your paper trash. Fold everything to about the size of a folded newspaper. This goes for cereal boxes and containers of all sizes (tear them open), wrappings—everything—because the wire holds them down and keeps them from blowing all over the landscape. Paper egg cartons—practically wood pulp—should be torn up and worked into the soil."

"I hope that mulching your garden with newspapers will be a continuing and growing movement," said Mrs. Margaret Hunter of Lake Worth, Florida. "I have been doing it for years, with more than one good result, the re-use of newspapers," she continued. She asserted that, "newspapers control some of the garden pests.

"I tried it with very good results on some pests including white fly, some scales and aphids. At first I just

put down three-or-four-inch-thick piles of folded papers, held down with just a piece of wood or rock around shrubs. With time, I began tearing the paper into strips, and covering the ground with them which permitted more uniform watering from the hose or the rain. I also found that the torn strips stayed put better and didn't blow around.

"As horticulture chairman of the garden club, I talked about the advantages of paper mulch to the members. After they came and saw my torn paper borders, many of them followed my example and I later received reports that they had obtained good results from using newspaper as a mulch."

Newspapers, dampened and torn into 30-inch long strips, will "tangle good when stirred lightly," Mrs. Hunter said. Method of dampening is not important just as long as the paper "flutters down in limp strips and no longer clings together in clumps.

"My garden is quite small," she reported. "I put the paper around the 'up' squash hills and along the newly planted okra row. When the okra was up and large enough to thin, I pulled the paper together with the plants. Considering the poor soil in this place, the okra is doing quite well as are most of the other vegetables and herbs. I am building up a good organic soil and the paper mulch is proving a big help."

Robert F. DeVoe, Sr., has followed organic gardening methods in eight different homesteads since he got started back in 1923. Today, he lives in Meadowvale, "a small town east of Louisville, Kentucky," where he mulches his vegetable garden and his strawberries with newspapers.

"I spread newspapers three to six thicknesses with

three-inch overlaps on all four sides over my vegetable garden," he said. "I covered this with the mulch pile which consisted of kitchen refuse, wood bark, weeds, grass clippings, flower and bush trimmings and cottonseed meal. I wet this down for several days before planting.

"I started with a few bush beans, and corn in peat pots, and placed them in rows. But at the east end I dug holes in the mulch and newspaper and placed the plants and seeds in the soil. Along the fence, I set out strawberry plants in newspapers with grass clippings on top and brick edging to make everything look neat and keep the papers from blowing."

Still another newspaper mulcher is Paul Graybill, who gathers grass cuttings, wood chips, fallen leaves, hay, weeds and vegetable refuse—garbage included—and then returns them to the soil together with a paper mulch.

"Without all the nutrients that organic materials add to the soil, my fruit and vegetables would have very little taste and practically no food value," said the Connecticut homesteader.

The surface mulching Graybill worked out overcomes many problems he's encountered in other methods. When plants reach a height of two or three inches and the ground is thoroughly warmed, he scatters fine organic material such as heap-prepared compost, grass clippings, shredded leaves or fine hay between the rows.

Next, he folds newspapers about four papers thick, places them in the rows and between or against the plants on each side, then scatters an inch or so of grass clippings, hay or other organic material on top to hold them in place. This type of mulch lasts through the

season—without further work. Additional fine material may be added during the growing period. Very few weeds come up, Graybill said, except a few now and then directly in the plant row, which can be easily pulled because the soil stays so moist and friable. Another advantage: the fruit and leaves of plants are kept clean, and the compost below the papers disintegrates fast. The paper itself decomposes by fall, ahead of preparations for the cover crop seeding.

When setting out young plants like tomatoes and cabbage, Graybill tears a slot in the paper, making it fit snugly around the stem, then covers the entire area about the plant before adding compost over the paper. He says he likes the paper-mulched method much better than plastic sheets, since it allows free moisture passage during rains and also allows some “breathing”, where plastic—unless perforated—allows no passage of water or air.

The paper-mulch plan is effective in the strawberry patch, Graybill said. Runners can be controlled by placing folded papers of 10 or more thicknesses between the rows in spring and covering this with hay. This leaves exposed a bed of strawberries about eight inches to a foot wide in the row itself. And it kills the runners which are covered, holds moisture, and keeps the strawberries clean during the bearing season. He thins these narrow beds by pulling out plants after picking season.

Newspaper mulching works two-fold wonders. It is a good organic mulch in the garden. It relieves the community of a portion of its increasingly heavy burden of solid waste. So send that plastic back to its maker and mulch instead with newspapers.

## Chapter Seven

# THERE'S METHOD in THIS MULCHING

Hopefully, you've been convinced. And you've run out and gathered up all the mulching materials you could lay your hands on. Now you're standing beside the garden, hay in hand, with a slightly quizzical expression. There're a couple of questions. . . . .

“When do I mulch? How much do I use? How often should I mulch?” you're asking. “What about fertilizers? Don't I need fertilizers at all? Are you sure this is as easy as it sounds? I'm going to goof it up, right? Because there's something you forgot to tell me, right?”

Just relax. Mulching is as easy as it sounds. You won't goof it up as long as you are careful and follow a few guidelines. We won't give you the steps of the perfect way to mulch your garden, because such a way doesn't exist. We will point out mulching guidelines and a few of the most common pitfalls. A good organic

gardener, of course, always likes to experiment a bit and develop a specially-adapted method. Thus the variations on when and how to mulch are as numerous as the materials you can use. We'll give you the maps. You'll have to select your own route.

The answer that Ruth Stout always gives to the first question—when should the mulching begin?—is “NOW, whatever the date may be.” That's as good an answer as you can expect. There are, basically, three kinds of mulching—summer, winter and continuous. Miss Stout is of the continuous school of mulching. Other experienced mulchers find fault with a continuous covering and opt for covering their garden soil only a part of the year.

The chief reason for a mulch in winter is to prevent damage to plants from alternate freezing and thawing which causes soil to heave and expose and break roots. Winter mulches, too, protect the more tender plants not perfectly suited to rougher climates. And they protect plants against rapid changes of temperature. In many sections the temperature often ranges from 15 to 20 degrees in 24 hours. Under a mulch the temperature remains more constant.

The mulch should be applied *after* the first hard frost to prevent alternate thaws and freezes from heaving soil, roots or bulbs. Its purpose once winter sets in is to hold the lower temperature *in* the soil, avoiding thaw and subsequent refreezing which shifts the earth and plants, often exposing enough roots to cause winter-killing. To protect young shrubs, and particularly roses, mound several inches of earth around them early in autumn, then mulch after the first freeze with several

more inches of leaves, straw, yard trimmings, or other mulch materials.

The winter carpet of organic matter also helps condition the whole garden area for the next spring.

A summer mulch, applied as soon as plants are established, allows the temperature under it to rise and fall gradually, to remain uniform and about 10 to 15 degrees cooler than that of unmulched areas close by during normal air temperatures.

The more even, cooler temperature under a mulch helps to maintain a better balance between the plant's loss of water (transpiration) and its absorption of water. It does this even during hot, dry days when transpiration exceeds absorption and causes unmulched plants to wilt. A mulch acts as a reservoir. It conserves water by providing a greater area for absorption and an uneven textured surface which prevents water from running off.

After you've planted most of your vegetables your primary concern will be how to protect these plants from the coming summer's hot, dry weather. What should you do? Mulch.

The third kind of mulch, the continuous mulch, serves the dual purpose of both the summer and winter mulch. It protects whatever plants are in the ground and steadily works to condition the soil. A mulch used the year around serves to control weeds, conserve moisture and provide plants with protection against the extremes of weather. If it is one of the coarse materials with rough, irritating surfaces, it will discourage slugs and snails from crawling over plants and damaging them.

A continuous mulch around thick-stemmed perenni-

als, shrubs, trees, evergreens should be of a coarse, heavy material not subject to rapid decay. Straw, hay or cotton bolls may not appeal to you for this purpose because they break down fast and must be replenished regularly.

Woody materials and coarsely ground cobs are ideal. They last from three to five years, when applied to a depth of three to four inches, and relieve the gardener of the chore of cultivation and worries concerning drought and heaving of soil. The only maintenance such mulches need is a nitrogenous fertilizer in spring and midsummer and a raking, when necessary, to open them up to air and water.

Most of the hard-core mulchers—like those whose experiences with mulching have been related—use a continuous mulch. But they generally have some reservations about the continuousness of the cover.

There *can* be too much of a good thing. There can be advantages to pulling back the mulch on certain occasions to allow the ground to warm. And while a year-round mulch does the job on sandy soil, it can defeat the purpose on heavy clay.

Most gardeners agree that mulch timing is important to produce bumper crops and have learned by their own mistakes or experiences to abide by a few general rules.

Seedlings planted in very moist soil should not be mulched immediately. The addition of any organic matter which keeps the soil at a high humidity encourages damping-off of young plants. Damping-off is a disease caused by a fungus inhabiting moist, poorly ventilated soil, and can be 90 per cent fatal. Allow seedlings to become established then, before mulching.

It is wise, too, to consider the danger of crown-rot in perennials. This disease is also caused by a fungus. If there have been especially heavy rains, postpone mulching until the soil is no longer water-logged. Do not allow mulches composed of peat moss, manure, compost, or ground corn cobs to touch the base of these plants. Leave a circle several inches in diameter. The idea here is to permit the soil to remain dry and open to the air around the immediate area of the plant.

Do not mulch a wet, low-lying soil, or at most, use only a dry, light type of material, such as salt hay or buckwheat hulls. Leaves are definitely to be avoided as they may mat down and add to the sogginess.

The heavy mulching method described by Ruth Stout stands a better chance of success if the soil contains some humus (well-decayed organic matter) and is fairly high in nitrogen content.

Where the soil is poor and mostly clay in composition, it is well to test the soil and apply the needed elements, as nitrogen, phosphate and potash, according to test results. Then spread the mulch in thin layers without packing, so as to permit air and moisture to start breaking down the raw materials. When the first layer of mulch shows signs of decay, sprinkle some cottonseed meal, blood meal or other nitrogen-rich material and apply another thin layer of mulch. By this method, any danger of the heavy mulch taking too much nitrogen from the soil is avoided.

Some vegetables, like tomatoes and corn, need a thoroughly warmed soil to encourage ideal growth. A mulch applied too early in the spring, before ground temperatures have had a chance to climb a little in

frost-zone areas, may slow up such crops. Once plants are well started, though, and the weather levels off, mulch is definitely in order to conserve needed water, stimulate topsoil microorganisms and generally condition the soil.

Author-gardener John Krill pinpointed the importance of logical mulch timing for tomatoes, for example. His experiments—and the experiences of others—show that early ripening of tomatoes cannot be expected if the spring-thawing ground is cloaked too soon.

“Mulch can be a hindrance instead of a benefit under certain conditions. The deeper the mulch, the greater the drawback,” he said. “I’m a mulch addict for more years than I care to name. If I named how many people would say ‘He’s too old to know better’. Yet I will venture that many mulch enthusiasts have undergone the same experiences I have.

“With the coming of the true spring weather, I’d be in the garden planting tomatoes. The plants were set properly and lovingly in their holes. Then I’d carefully mulch them with any suitable substance available,” he said. “The plants never failed to respond and grow sturdily. Their color was a green to delight the eye of the most critical gardener. As the mulch would compact itself, I would busily add more. There wasn’t a weed to be found because the mulch prevented them from coming up.

“Ah! That part of growing tomatoes was simply unbeatable. But guess who had the first *ripe* tomatoes? None other than the people across the street. They didn’t mulch because they had not yet learned of its tremendous value. They weren’t the only ones. Friends

living miles away and scattered in every direction also had ripe tomatoes sooner than I.

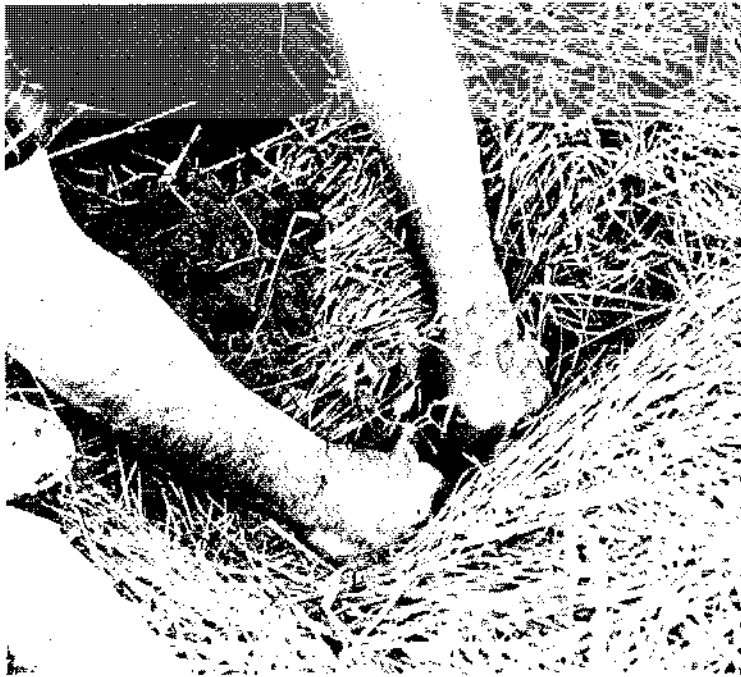
“What hurt me the worst was that I had given tomato plants to them from my hotbeds. Why did their tomatoes ripen ahead of mine since they were of the same identical stock? Sure, I couldn’t help noting that their unmulched plants did not produce as much. Nor did they last until frost finally destroyed them, as was the case with my own mulched plants. Hot and dry weather withered and destroyed their plants long before a frost came, while mine were just coming into heavy production of ripe fruit.

“There had to be a connection between mulched and non-mulched plants. A little serious thinking prompted me to conduct a simple, but extremely illuminating experiment. When spring once more arrived, I had my experiment ready to try. I set out three rows of tomatoes. All the plants came from the same hot-bed. The first row I covered with mulch as I had always done. I left the second row bare. No mulch was applied. And during the growing season I kept this row well cultivated. I did not water these unmulched plants because I had never watered those I did mulch. The only thing I did was keep the soil loose and weed-free. It turned out that it was a season of ample rains and watering would have been totally unnecessary. The natural moisture was a definite help in the experiment.

“The third row was also left unmulched—up to a point. As soon as the tomato blossoms appeared, I gave up clean cultivation of this row and covered it with a straw mulch. The other row which I had left clean and without mulch also showed a good set of blossom. But

the mulched row was just showing signs of developing buds. It would take 10 to 15 days to produce the blossoms that were already in bloom on the two unmulched rows.

“The mystery was clearing up. Sure enough, the unmulched row produced the first ripe fruit. Almost neck-and-neck with it ripened the fruit in the row I had mulched after flowers had appeared. The fruit was heavier, juicier and far better shaped than in the row which had been left unmulched. The mulched row? It was the same old story. The plants were beautifully



Mulching of tomato plants too early in the season can slow ripening.

green and just loaded with fine-shaped green tomatoes. There wasn't a single ripe tomato among them. It would be two weeks or more before there would be any ripe ones," he said.

“But I had the key to the whole thing. By mulching the tomatoes when I had set them out in the spring, I had slowed down their growth. It takes a lot of heat to warm the soil in the spring to where it will stay warm. The mulch I had applied so soon had simply insulated the soil against absorbing warmth from the sun and air. Tomatoes like plenty of warmth. With the mulch keeping the soil from warming thoroughly, the plants were late in setting their blossoms. Consequently the fruit developed and ripened tardily. That this was so was easily proved. I laid my hand on the bare ground. It felt warm. I thrust my hand under the mulch. The sensation was one of soft coolness, something that the plants would tolerate, but which would not accelerate rapid development.

“How about the row I had mulched after the blossoms appeared? It was a dandy. By the time the flowers had developed, the soil was thoroughly warmed by the advancing heat of summer. The thin mulch now acted to prevent the warmth from leaving if sudden cool days and nights arrived. With heat under the mulch and more heat beaming on top of the mulch, these plants set heavy and well-shaped fruit that ripened practically as soon as that of the unmulched row,” he said.

“About the middle of August the unmulched row began to shrivel and dry from a prolonged spell of heat and drought. The plants soon died. But the remaining two rows with their mulch coverings seemed to wax



even more vigorously, with the row that had been mulched from the very start now coming into full ripening. Both of these rows produced good tomatoes until frost.

"I have learned this lesson: that if mulch is applied before the earth is thoroughly warmed, it will delay the ripening of tomatoes. I apply mulch now only when flowers are profuse, or even wait until the fruit sets before mulching the plants. Then the mulch seals the heat in instead of sealing it out. Thus it pays to know when to mulch.

"For late-ripening tomatoes I mulch my plants heavily when I set them out. For the earliest possible I set out enough to get ripe fruit in unmulched soil until the juicier and better-flavored tomatoes are ripened in the mulched rows. By the wise use of mulch you can prevent tomatoes ripening all at one time.

Bart Burdick confirmed Krill's conclusion.

"My garden was located approximately four miles south of Cornucopia, Wisconsin, which is Wisconsin's northernmost village," he said. "Temperatures drop to 20 to 30 degrees below zero—and occasionally to 40 below in midwinter. In spring the ground is slow to warm up.

"I set out my tomato plants in peat pots. My brother-in-law set out his plants a week later, minus peat pots. I mulched mine; he didn't. His tomatoes ripened seven to 10 days before mine. His ran out faster due to frost. Mine kept ripening for another week," Burdick explained.

"My conclusion as to the difference in time of

maturity: the same as John Krill. I should have left the mulch off *until* the soil had warmed sufficiently, then applied my mulch" he said.

In North Carolina Vernon Ward plowed and harrowed, then mulched the ground with about six to eight inches of wheat straw. Then, using Rutgers plants, he set his tomato plants through the mulch at a distance of four feet apart each way. To set the plants he pulled the mulch apart and set the roots in the prepared ground, then pushed the mulch back together around the stems. This was the end of his work. He did nothing else the entire season but pick tomatoes. Dark green vines soon completely covered and obliterated the mulch. No weeds grew. There was an immense set of fine tomatoes which remained large, with hardly any culls throughout the growing season, and the vines were still full of tomatoes at frost.

Ruth Stout mulches continuously and heavily. Unlike some gardeners, she doesn't differentiate between summer and winter mulches. She doesn't plow under the winter covering in spring, although many gardeners do this successfully. She doesn't plow at all. She is a strong believer in the continuous mulch, but she doesn't quarrel with the likes of John Krill and even admits to pulling back the mulch from ground slated to receive certain plants—like tomatoes—in spring. She has advice on the best ways to use mulches around your plants at spring planting time.

For spinach, lettuce and peas you should place six to eight inches of mulch. Shade the lettuce if you can. For beets, carrots, parsnips and kohlrabi: first thin the

plants; then water thoroughly and put mulch all around them at once, six inches deep between rows. If the mulch is wet, so much the better. For bush beans: if already planted, thin, water and mulch. If you haven't planted them already, make a drill four inches deep; plant the beans sparsely; cover with two inches of soil; water; cover with a board or cardboard and mulch. Remove the board as soon as beans sprout. For corn: if planted already, thin to two plants in a hill instead of customary three. Water and put down six inches of mulch. (If you're running out of mulch, use as many layers of wet cardboard as you can collect. The cardboard is only an emergency measure; it is not as satisfactory as hay or leaves, because the latter provide more valuable nutrients to the soil as they decompose.) Each time you plant corn soak the seed overnight, make four-inch drills and cover the seed with two inches of soil. Water thoroughly, put a board over the seed and mulch immediately.

For late cabbage, broccoli, cauliflower, peppers, and tomatoes: if not planted yet, put very deep and four feet apart, mulching heavily. If peppers and tomatoes aren't in, put them very deep and farther apart than customary. If already planted, water and mulch heavily (six to eight inches).

For flowers: "All flower beds should be under a constant mulch, drought or no drought." Miss Stout said that you can easily do this without making them look ugly. Peonies can be mulched with dead leaves and their own tops. Well-rotted hay, mixed with crushed leaves, makes an excellent cover for roses. Put it on six inches deep and then scatter soil on top. It all looks like soil

then, but the mulch is so deep that weeds can't sprout. The same method works well for large annuals, such as zinnias.

For small, low-growing annuals, Miss Stout used a fine mulch. "Since I keep my whole vegetable garden mulched constantly, there is always material there, not quite rotted enough to be rich soil, but rotted enough to look like it. I put this round my small annuals. If you don't have such material, you can use crushed leaves mixed with a little soil and wood ashes. This may sound like quite a job, but you have to do it just once a season."

The catch in mulching—if really there is one—lies in deciding on the amount of mulch to use. Should a good mulch always be the same depth? Must it be measured to slide-rule accuracy to function right? Do any other considerations influence the proper quantity? In other words, how much mulch is enough?

Generally, gardeners mulch crops that are in the garden for most of the summer. How much? During the growing season, the thickness of the mulch should be sufficient to prevent the growth of weeds. A thin layer of finely shredded plant materials is more effective than unshredded loose material. For example, a four to six-inch layer of sawdust will hold down weeds as well as eight or more inches of hay, straw or a similar loose, "open" material. So will one or two inches of buckwheat or cocoa bean hulls, or a two-to-four inch depth of pine needles. Leaves and corn stalks should be shredded or mixed with a light material like straw to prevent packing into a soggy mass. In a mixture, unshredded leaves can be spread eight to 12 inches deep for the winter. To offset the nitrogen shortage in sawdust and

other low-nitrogen materials, add some compost, soybean or cottonseed meal.

Ground corncobs are highly recommended. Light and bulky, they help to “fluff up” the soil, thus preventing crust formation. Peat moss, an old stand-by, can be spread an inch or more in vegetable gardens and flower beds or used as a half-inch top-dressing twice a year on established lawns. Other good materials which can be used in the same manner include cotton gin wastes shredded cotton burrs, oat, rice and cottonseed shells and sphagnum moss.

How much mulch do you need? For her system of year-round mulching, Miss Stout says, you should put down, “more than you would think. You should start with a good eight inches of it. Then I’m asked: ‘How can tiny plants survive between eight-inch walls?’ And the answer to that is: the mulch is trampled on, rained on and packed down by the time you are ready to plant. It doesn’t stay eight inches high.”

Once you’ve put the basic mulch down, it is going to start decomposing and it will need replenishing periodically. How often do you replenish? That’s something you will have to determine by observing the breakdown and compaction of your mulch. According to Miss Stout, the time to add to the cover is “whenever you see a spot that needs it. If weeds begin to peep through, don’t bother to pull them; just toss an armful of hay on them.”

Speaking simply, the amount of mulch to use is the amount that does the best job for you, your soil and your plants. Working out an ideal mulch program takes some experimenting, some trials with various materials

and depths. It’s only common sense to check on the most plentiful free and reasonable sources, to test the effects of different mulches in your climate locale, your own soil type and timing.

Are mistakes ever made in mulching? Of course. But with simple precautions you can avoid them. Before tossing armfuls of hay around, remember to use a partly rotted mulching material. New mulch will sometimes rob the soil of nitrogen. If you have only a small amount of decomposed material, put just a thin layer of it on the ground, then sprinkle some nitrogen-rich fertilizer such as bone meal, manure, cottonseed meal or tankage on the topsoil first. Another important thing is that mulch will be more effective if put on after a good rain—for it is difficult for water to penetrate a thick covering. If the ground is dry to start with, it will stay dry the rest of the summer unless the skies really open up.

“As wonderful as mulching is, it must be done right or the results may be disappointing,” said Lucille Shade. “During my first few years I made many mistakes. For instance, I mulched corn with bright new hay and wondered why it didn’t do well—without realizing that this brought a temporary nitrogen shortage as the hay started to decompose. I mulched other crops with oat straw and got a fine but unwanted crop of green oats between the rows of vegetables. I used timothy hay as a winter mulch for strawberries—and the following spring I had timothy coming up all over the strawberry bed. Nothing is harder to discourage when it’s up close around the plants. I finally gave up and started a new strawberry patch,” explained the Ohioan.

“Over the years I’ve learned some techniques that

make for successful mulching every time.

“First, if it is at all possible, use partly rotted mulching material. New mulch will rob your soil of nitrogen, which explains why my corn did so poorly under a mulch the first time I tried it. If you have only a small amount of partly decomposed material, put just a thin layer of it on the ground, then cover it with a thick layer of new stuff. If you must use all new mulch, then sprinkle some nitrogen-rich fertilizer such as blood meal, manure, cottonseed meal or tankage on the topsoil first. The only place I use new mulch without extra nitrogen is in covering large areas of ground—such as in the melon, cucumber and tomato patches—with rotted mulch up close around the plants.

“To age baled hay or straw in a hurry, soak it thoroughly with water, then give it six to eight weeks to start decaying,” she said.

“A second important thing I’ve learned is that mulch will be much more effective if I wait until we’ve had a good rain, and then put it on—for it is difficult for water to penetrate a thick covering. If the ground is dry to start with, it will stay dry the rest of the summer unless the skies really open up. My spring gardening season is divided into dry and wet days. On wet days I concentrate on mulching, leaving all other chores for dry days.

“I’ve also discovered that simply pulling the mulch apart in the spring and planting my seed doesn’t work on my heavy clay soil. I must open up a space about a foot wide in order to let the sun warm up the soil. I’m especially careful not to hurry mulching of such warm-weather lovers as tomatoes and melons. I start at the outer edges of my melon patch, for instance, and keep

covering the ground until I get within about a foot of the vines. Then—once the weather is good and warm and the melons are off to a good start—I finish the job, mulching in close around the vines. In my climate, I’ve



Best time to mulch is after a shower. Small weeds are smothered out with hay.

found it's best to hold off close-up mulching of tomatoes until they have started to set fruit," she said.

"If your mulch starts sprouting—as my oat straw did—simply turn it over. It takes only a few minutes to walk down a row flipping it upside down.

"I am more careful now in selecting hay for a winter covering on strawberries. The trick is to use hay that was cut early, before the timothy became ripe enough to shed its seed. You can do this by opening up a bale and shaking it. If fine, chaff-like seed falls out, don't use it for this purpose.

"Nothing you can do to your garden will benefit it more than mulching," Mrs. Shade concluded. "It can substitute for the chemical gardener's watering, fertilizing, soil conditioning, and hours of weeding. What else can do so much for you?"

Morton Binder ran into nitrogen problems similar to those of Mrs. Shade. Binder, you may recall, turned to a mulching program to solve his soil problems. While still in the soil conditioning stage of his program, Binder wanted to set out some canned fuchsia without waiting.

"I dug the holes," he said, "and added two shovels of leaf mold from the woods to the sawdust soil mixture. As soon as the fuchsias were set out, I mulched them with manure to begin to offset the lack of available nitrogen during the rotting-down process of the sawdust. The results were as follows—and, I think the moral of the story and the lessons learned may prove valuable to others attempting the same trick:

"In spite of the manure, the fuchsias rather quickly developed nitrogen starvation symptoms. I gave them a handful of processed sewage and a tablespoon of blood

meal, but it wasn't until three months had elapsed that the color returned and the results became satisfactory.

"The other portion of the bed was not planted until four months after the first. These plants developed no chlorosis, and normal feeding brought out good color. Four months later both groups of plants appeared quite healthy, and no different in final results," Binder said.

"It proves again what has often been said. 'Don't plant immediately in freshly prepared soil where unrotted organic material has been used in large quantities. Wait until the breakdown process has had time to work.'"

The reason for these gardeners' woes is that substantial amounts of nitrogen are required for decomposing plant residues. When an organic mulching material does not contain all the nitrogen required for decomposition, the mulch tends to "borrow" nitrogen from the soil or fertilizer applied to the soil, leaving less nitrogen available for plant growth during the decomposition process. Consequently, signs of nitrogen deficiency are frequently observed in plants grown under heavy mulches, unless sufficient nitrogen fertilizer is added to compensate for the soil or fertilizer nitrogen required in the decomposition process. The amount of additional nitrogen fertilizer needed to compensate for the nitrogen tieup varies with the type of mulch and its state of decomposition.

Duration and severity of the nitrogen depression sometimes observed following application of organic mulches is affected by a number of factors in addition to the kind of mulching material used and its nitrogen content. Soil fertility—particularly the amount of nitro-

gen in the soil—is a significant factor in determining whether or not crop yields will be affected adversely under mulching. This is illustrated by studies of wheat grown in various sections of the west. Although yields grown under a system of mulch farming tended to be less than under moldboard plowing in most areas studied, no depressing effect on grain yields was observed in areas where the nitrate content of the soil was high.

Increases in the amount of soil nitrate following application of mulch occur under some conditions. In fact, such an increase has been reported in the majority of studies in which “inert” mulches such as plastic were used.

When decomposable mulches such as straw or hay or manure are used, the rate of decomposition and the proportion of carbon to nitrogen are significant factors in determining whether mulching will increase or decrease the nitrate content of the soil.

The point is that mulched crops must have an abundant nitrogen fertilizer supply, else the crop will show temporary nitrogen starvation. This is true because soil bacteria stimulated by the better growth conditions under the mulch tend to gobble up available soil nitrogen. Of course, these tiny motes of vegetable life soon die and decay, and give back to the soil quickly available higher-plant food. But there is a lag when you first mulch during which they need to be fed extra nitrogen.

This is why experienced mulchers like Ruth Stout sprinkle a bit of cottonseed meal or blood meal on the soil before planting. The soil can be treated with compost or manure, but Miss Stout doesn't go in for the

extra work and doesn't recommend the process unless the soil is deficient and really needs conditioning. The soil in her garden, for example, is in proper condition and is kept that way continually by her mulch. A soil test is a good way of determining whether or not your soil has deficiencies.

Another deficiency that'll do in your plants is a lack of water. As Mrs. Shade learned, the best time to mulch is after a rain. Or, failing that, after the soil has been watered. A mulch is a good moisture conserver, but it can't conserve what isn't there.

By the same token, however, too much water isn't good either. This is why good drainage is important. A too-wet soil is trouble for a garden, and mulching a too-wet garden is just compounding the problem. If you can't solve the problem of an overabundance of water naturally—as Bob Wandzell did by selecting a slope for his garden to promote runoff—a few drainage ditches might help. This is the solution Cynthia Williamson chose.

“Ruth Stout had been talking about mulching humus-rich sandy land,” said the Michigan mulcher, “and I was going to mulch humus-poor, heavy soil. Although I realized it would take two or three years for the mulch to condition the earth, I failed to realize that my heavily compacted soil was badly in need of drainage ditches in the lower end.

“Our part of Michigan has had extremely heavy rainfall. After a 4-inch downfall, when the water stood in pools around my transplants of lettuce, tomatoes, peppers and cabbages, it dawned on me I had problems. At

the site of an old compost pile, the soil crumbled like moist, light cake; but in the lower end of my 50-by-100-foot garden, the soil was extremely heavy and fell off the spade in tight, wet clods.

“This lower area of the garden had grown tomatoes for two years. The vines had been beautiful and lush with fruit, but frost had hit before a majority could ripen. Previously I had blamed their late maturity on a heavy layer of mulch, but after reading that tomatoes ripen faster on a light, humusy soil I began to wonder. Green peppers had the same trouble. There was plenty of fruit on the vines, but they just didn’t grow or ripen rapidly. Perhaps I was too hasty in mulching the entire garden without first enriching the soil’s humus content.

“Although tomatoes and peppers had plagued me, other vegetables did well in this area surrounded by mulch. Green peas planted in mid-July stretched up and bore heavily. Late cabbages did well, even though I fed them nothing but a little compost at the start. Now that the area is well-drained, my head lettuce and leaf lettuce grow in abundance, unaffected by the heavy soil, and mulched thickly,” she said.

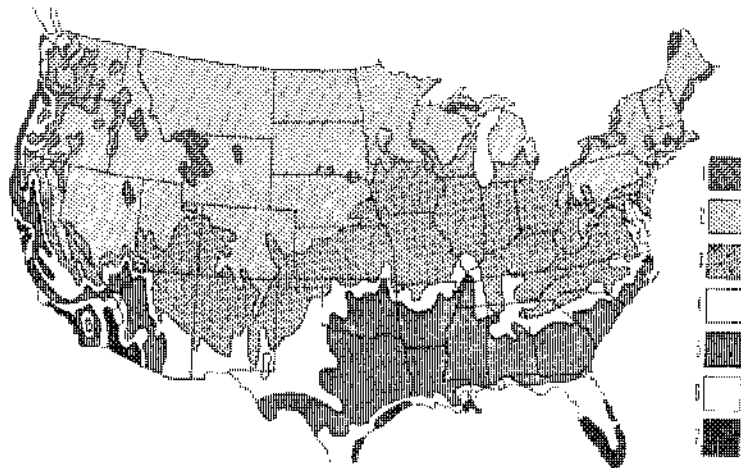
Are there mistakes you can make? Sure there are. But the biggest one you can make is to refuse or to neglect to mulch your garden—or to give up on mulching after one less than abundantly successful try. There’s more to mulch than meets the eye. A successful mulch garden may not come overnight. Humus-poor soil won’t be rejuvenated in one growing season, so don’t expect too much that first year, or the second, for that matter.

Rather, weigh the experiences of others. Test your soil, study its strengths and weaknesses. Consider your climate. Investigate the various mulch material available to you locally in abundance. Then, observing the guidelines and existing conditions, set up a program.

Then get out there and mulch!!!

Appendix I

# CALENDAR GUIDE for SEASONAL MULCHING



*Average date of last expected spring frosts: Zone 1, June; zone 2, May 10-30; zone 3, April 10 to May 10; zone 4, March 20 to April 10; zone 5, February 28 to March 10; zone 6, February 8-23; zone 7, January 30 to February 8.*

**FEBRUARY:** Turn over cover crops and spring weeds and cover the soil with mulch immediately if you are in an arid or drought area. In all other areas the spring

crop will grow faster if you leave the soil uncovered for a week or two to warm up before you apply the spring mulch.

After the snow melts in the northern areas, check the mulch in your flower gardens and loosen it where it has become packed down during the winter.

In Zones 2 and 3, start removing the mulch from spring-flowered bulb beds.

In Zone 6, remove mulch from roses, and allow the soil to bake for a couple of weeks before you apply a mulch of new materials. Use the old mulch to enrich the compost pile.

**MARCH:** In Zone 4 and northward, shred old asparagus plants with either the lawn mower or shredder and return them as a mulch. Mulch half the asparagus bed heavily with a fine material such as cocoa bean shells, well ground corncobs or partly broken down leaf mold. Let the other half of the bed unmulched until shoots begin to break through the mulched half. This extends the asparagus season, because the unmulched part of the bed will begin to bear one to two weeks earlier than the mulched part.

In orchards, pulverized rock fertilizers can be spread below the trees and berry bushes. Work the materials into the top layer of soil before covering it with the summer mulch.

In northern perennial beds, loosen the leaf mulch as soon as the snow has melted, but don't remove this winter mulch too soon. One of its purposes is to keep the ground frozen until it will remain permanently thawed. In Zone 4, work into the soil any manure that remains on the surface around roses, and allow the sun



to bake the soil for a couple of weeks before you apply the summer mulch.

**APRIL:** The winter mulch should be off your planting rows by now, even if you had a dry, snowless winter. Give the spring sun a chance to warm the soil and bring it to life. Later, as the season advances, pull this rather thin mulch back to the row, and add to it as much as you can.

Be shrewd about your mulching. Delay it as long as you safely can in order to warm the soil, without losing too much moisture.

Mulch is more important in the hot Southwest than possibly elsewhere. Residents there should mulch their azaleas and camellias thoroughly with compost or leaf mold, keeping them well watered, especially while they are putting forth new growth after flowering.

In Zone 3, when tomatoes can safely be set out without protection, draw a hay mulch up to the stem of each plant.

In all sections of the country, use the early grass clippings for mulch. These are very rich in nitrogen in this season.

In the orchard spread nitrogen-rich fertilizers around fruit trees and berry bushes if you have not already done so. Cover the fertilizer with a thick mulch of hay, preferably alfalfa.

**MAY:** Planting will be underway by now and your mulching should be, too. In Zones 4–7, planting must be done immediately for summer crops. When plants are four to five inches high, apply a mulch at least three inches deep. Use old sawdust, hay, leaves, pine needles, or rocks to hold moisture, lessen weed growth and cut

down on labor. For these zones, the importance of mulching cannot be overstressed. Continue to gather mulching materials to replenish the ground cover.

In Zones 1 and 2, the winter mulch will have come off a bit later, but the spring soil conditioning program should be nearing completion and some hardier plants should be planted by mid-month. Almost all planting should be done by the beginning of June.

**JUNE:** Vegetables should be mulched heavily before the dry summer days arrive. You can speed growth for hardier plants by sprinkling cottonseed meal before the new mulch goes on.

**JULY:** If weeds are starting to push up through your spring mulch, the time has come to spread a few extra bales of hay. The best time to do this is right after a thundershower, when you have fresh moisture to protect. Tiny weeds can be smothered out with hay—no need to pull them first. Draw the mulch up close to the stems of plants like tomatoes, peppers, eggplant and corn. When spreading it next to lettuce, cover the ground first with newspaper and save yourself an extra-difficult washing job later.

**AUGUST:** Even if you started with newspaper, you may find it pays now to tuck straw and hay around the plants in the row. As for the paths and middles, you can use whatever comes handy to keep the soil from crusting and becoming trodden.

In the vegetable garden, check the mulch in the planting rows and patches to make sure it is not running too thin. Shade the compost pile this month with a thick layer of straw mulch.

Tomatoes may need a fresh layer of mulch at this

time. In the orchard, if a thick mulch has been maintained under the trees all season, it might help the pest situation to rake it away and supply a fresh mulch.

**SEPTEMBER:** Start now to collect organic materials for winter mulching or for sheet composting. As fast as garden rows are emptied, cover them with layers of materials that will break down during the winter, and that can be turned under in spring. Shredded leaves, fresh manure, hops, apple and castor bean pomace, ground corn cobs, bean and peanut shells are among the materials obtainable in the fall.

**OCTOBER:** In the North, azaleas and rhododendrons should be mulched with leaves. Central states gardeners should haul back the mulch six to eight inches from the trunks of fruit trees and grapevines.

Mulch Jerusalem artichokes with a thick layer of leaves as soon as soil has a frozen crust. The leaves will prevent hard freezing, and you should be able to push back any snow and to dig tubers at any time during the coming winter. Fall carrot plantings may be treated the same way in all but the very coldest areas.

New strawberry beds can be started at any time from now until midwinter in Zones 5, 6, and 7. Mulch the rows with clean, new straw after planting.

In Zones 1 and 2, mulch peonies with rich manure as soon as the ground freezes. Also cover the rock garden with evergreen boughs as soon as cold weather arrives to stay. This will anchor the snow, so essential to the health of Alpines.

In the orchard, push back mulch six to eight inches from the bases of the fruit trees to discourage rodents that plan to build their winter nests there.

**NOVEMBER:** Mulch heeled-in fruit trees that have arrived too late from the nursery to be planted. Mulch with straw after the soil is frozen ringing hard, so that the mulch does not harbor field mice.

Clear up all fallen fruit and old leaves, before applying a new fall mulch of leaves. Allow the ground cover to extend beyond the drip-line, but leave a bare area one foot wide around the trunk of each tree to foil the mice. Weigh down the new mulch with large, flat rocks. This procedure is particularly recommended for stone fruits suffering from gummosis.

Otherwise, spread rich manure under the trees and shrubs when they are dormant, covering it immediately with straw, hay or wood-chip mulch. This prevents ammonia from escaping, and will also give winter rains or melting snow a chance to leach it down to the plant roots. Again, leave a one-foot center well open around each tree trunk to prevent damage.

Give the berry bushes a good layer of wood chips, manure, sawdust, or shredded leaves. Blueberries must have an acid mulch—oak leaves are fine—but the others are not so particular.

Compost piles in Zones 4 and 5 can be kept active all winter by mulching them heavily with hay or straw.

For roses whose hardiness may be doubtful, build an overcoat of burlap stretched around 4 posts to surround each bush, and fill the enclosure with a mulch of chopped corn cobs.

Be sure to inspect winter mulches after each heavy windstorm.

## Appendix II

# MULCHING SOME SPECIFIC PLANTS

## Vegetables

### ARTICHOKE

Artichokes, Jerusalem or otherwise, thrive under a good light mulch with lots of nitrogen and a moist, well-drained soil. Any nitrogen-rich mulch material will do. Its thickness should be increased as the growing season progresses. The tops can be used as a winter mulch after the vegetables are harvested.

### ASPARAGUS

Like most garden plants, asparagus thrives when properly mulched. In the spring you might want to take your nitrogen-rich grass clippings and save them for the asparagus bed. Sometimes it's a good idea to divide your asparagus bed in half. Mulch half the bed heavily with a fine material such as cocoa bean shells, ground corn

cobs or partly decomposed leaf mold. Leave the other half unmulched until shoots begin to break through the mulched half. This technique will extend the asparagus season, because the unmulched part of the bed will begin to bear one or two weeks earlier than the mulched part.

At any rate, mulching your asparagus bed will keep it weed free if you use available organic material such as old hay, leaves, straw, salt hay and dried grass clippings—about eight inches for a season. If you want a steady, yearly supply of thick, delicious spears, you repeat that practice every spring.

When you finish your asparagus planting, sometime in late spring or early summer, weed the bed thoroughly, feed it and give it a thick mulch blanket. For the winter, mulch asparagus thickly with fresh manure or compost and allow the top to stand until spring.

One organic gardener, Brownson Malsch of Texas, tried experimenting with cotton-burr mulch on his asparagus beds. It's a material that's handy there and, like most natural materials, it breaks down readily and turns to a mellow compost. The material's obtained directly from the cotton gin, spread several inches deep making for easier maintenance of the planting site. It's rich brown appearance gives an attraction to the planting area while it controls weed growth at the same time.

### BEANS

Like most plants in the garden, beans will respond favorably when mulched. Perhaps the most serious cultivating problem in growing beans is the control of weeds. The bean roots are often close to the surface and

any deep or extensive cultivation to halt the weeds will result in undesirable root pruning. But a heavy mulch will work for you in keeping down the weeds and give you an added plus in preserving moisture in times of drought. Gardeners have mulched beans successfully with grass clippings and oat straw. The result will be some healthy looking plants and some mighty good eating.

#### BEETS

Beets are alkaline soil plants, and won't grow in acid soil. It is wise, then, to load your mulch with alkaline materials or use some ground limestone. A light mulch should be applied immediately after planting to conserve moisture and prevent the sun from baking the soil. When sprouts appear, pull the mulch back somewhat. As the growing season progresses, increase the thickness of the mulch and tuck it in close to the maturing plants. Beets thrive in a humus-rich soil, and a continuous mulch will contribute to this condition in your soil.

#### BROCCOLI

Broccoli should be well-mulched to preserve moisture. Organic gardener Joan Pierson used matted leaves with excellent results. She applied forkfuls of the leaves between the rows of plants, checked a substantial weed and insect problem and produced superb broccoli. Another Joan—Lindeman in this case—uses hay mulch with similar results.

#### CABBAGE

Spread some mulch on your cabbage bed and watch the cabbage respond. Near the Grand River in Eaton

Rapids, Michigan, Charles Carter grew 18 jumbo heads of cabbage—one of them a real tape measure gem. Carter used rabbit manure as fertilizer and irrigated with river water he brought to his garden with a small electric pump. The mulching was supplied by a nearby sawmill which gave out sawdust just for the asking. When the Carters began harvesting their cabbages, they discovered one head measured 52 inches around and tipped the scale at 35 pounds.

Others have used grass clippings and hay on cabbages with good results.

One of the most surprising mulches that's good for cabbages is aluminum foil. Investigation at Connecticut and other university experimental stations indicated that cabbage mulched with strips of aluminum foil were able to repel disease-carrying aphids and return the increased yields over unprotected plants.

If you live in a warm climate location and one that normally experiences mild winters you might like to plant seeds of cabbages and cover the beds with a coarse mulch during the early winter months like November or early December. Recover the bed with a coarse mulch such as twigs or pine boughs as soon as seedlings appear. In spring when you uncover them, you will have some hardy babies for early transplanting.

#### CARROTS

When you sow carrots you will probably want to place some mulch over the beds to prevent the soil surface from crusting so that sprouting seeds can't break through. Cover the soil with a little loose hay or other mulch (not so deep as you might normally use it), and water it carefully so that the fine seeds will not wash

away. When the slender seedlings come up be certain the mulch doesn't interfere with them.

If you're tired of the pesky brown worm that spoils your carrots you might be able to foil it with a coffee break. Mix your package of carrot seed with one cup of fresh unused coffee grounds. Plant the coffee with your seeds. It percolates enough coffee odor during the growing season to foil the noisiest of carrot flies. And it won't flavor the carrots as sprays and other poisonous substances do. Because coffee grounds are acid, they are good for plants that like that kind of treatment. Often it is best to mix ground limestone with the grounds before using it as a mulch or top-dressing. They seem to have a remarkable effect on stimulating the growth and health of certain plants. Chemical analyses show that the grounds contain small amounts of all sorts of minerals—including trace elements—plus carbohydrates, sugars and even some vitamins, as well as caffeine.

One gardener has found that he likes to leave carrots in the ground during the winter months. By covering them well with a thick mulch he finds that the carrots may be kept that way. At any rate, he prefers it to the frozen or canned carrots that are available in most supermarkets.

#### CELERY

Ohio gardener Lucille Eisman reports that leaf celery protected with a deep mulch almost covering the plants, will produce crisp, tender hearts until Thanksgiving time or later. Recently she took eight or ten celery plants, complete with roots and a clump of soil and

stacked them upright in an unused cold frame. Dried leaves were packed around and between the big plants and gave full protection from the cold.

#### CORN

When it comes to planting delicious sweet corn, organic gardeners are of one accord—mulching is important. Often it may be best to mulch sparingly—if at all—early, because it's best to let the corn get a good start and allow the soil to warm up. However, if the weather is very dry at planting time you might want to mulch each hill with a handful of old hay or dry grass clippings and remove it as soon as there are signs of germination. Another reason for early mulching could be an abundance of crows in your vicinity. Crows will pull small corn plants nearly as fast as they show above ground. The solution is a thorough mulch that will give the plants a chance to get well started before the crows can spot them. By that time, any plant pulled will yield disappointing results to the average crow, who is after the tender young kernels below the plants.

C. E. Chamberlain of Tacoma, Washington is one of the advocates of mulching growing corn. Chamberlain uses grass clippings that have rotted all winter and mixes them with peat moss and foil. After planting the corn he tops the bed by filling it with a ring of fresh, green grass clippings. He surrounds the plants with 24" circles of inexpensive aluminum grass edging. Edward P. Morris uses a more standard technique of hilling the corn six to eight inches high. Then he uses baled or old spoiled hay which he has shaken out in the area to make a continuous mulch five to six inches deep. He claims

it is always wise to work with the wind at your back to keep the dust and seeds away. Sometimes the hay separates quickly and easily into one inch pads or slates which are equal to five or six inches of shaken hay.

#### CUCUMBERS

Leaves, grass clippings, old hay, leaf mold or other organic mulch all rank high in controlling cucumbers, as does aluminum foil. In fact, mulch could be the way to control the old cucumber nemesis, the cucumber beetle. E. M. Watson of Chardon, Ohio, knows the difference that mulching makes in that regard. "One year I was setting watermelon plants and was driven in by the rain before I could finish," he said. "I had all but one hill mulched with compost. I didn't get back for two days and the unmulched hill was literally destroyed by striped cucumber beetles. The others were not bothered. I had this experience with other things I have mulched; they appeared to be less susceptible to pests."

Down in Houston, Texas, Pat Patterson has found that cucumbers benefit greatly from an organic mulch. When the cucumbers are about three inches in height, Patterson spreads a reservoir of leaves around the tiny plants. Every few days he will add another thin layer of leaves until the mulch is about four inches thick. When an occasional indomitable weed pokes through the mulch, it is easily plucked from the loose soil. If you use lawn clippings as a mulch, let them dry a few days, then apply a four-inch thick layer down the whole row of cucumbers. Actually, any organic mulch will serve as well. It is a good idea to provide mulch wherever cucumber roots might extend, even on the other side of

a fence or tree. Look for big improvements in your cucumber patch after you begin to use an organic mulch.

#### EGGPLANT

Mulches are valuable to the eggplant because it cannot be disturbed if it is to have proper development. Besides smothering the weeds, a good organic mulch will help to conserve a uniform supply of moisture which in turn will enable the roots to feed in the top, moist two inches of soil with which they are surrounded.

#### GARLIC

Add garlic to the list of plants that get a boost from mulch. Harry Scoth of Corvallis, Oregon grows giant garlic, and he knows the value of using organic material. Scoth welcomes all the grass clippings, weeds and leaves his neighbors care to donate in the fall. Then he maintains two big piles of grass clippings available as mulch during the dry August months. When his garlic is six to eight inches high, Scoth works compost into the soil and mulches with grass clippings between the rows.

#### KOHLRABI

Moisture is of the greatest importance in feeding kohlrabi for the best growth. A thick mulch should be drawn up to the seedlings as soon as they are tall enough, and the soil beneath the mulch should be kept moist. One experienced kohlrabi grower, Dexter Raymond, uses hay, grass clippings and pulled weeds to

mulch his plants. Ruth Stout uses hay rather successfully.

#### LEEKS

Leeks profit from mulches of all sorts, including peat, straw, compost, wood shavings and autumn leaves. Be certain that when mulching young seedlings the mulch doesn't interfere with them as they sometimes come up rather thick in the seed bed.

#### LETTUCE

Lettuce is a plant which needs a coarse mulch material such as twigs or pine burrows in the seedling bed. If you already have a planting area that has seen the mulch break down a bit in early summer, scatter some lettuce seed there. The lettuce appreciates the semi-shade as well as the rich, rotting mulch.

If you have to plant your lettuce after the chill of early spring, apply a thin straw mulch around and right up underneath the lettuce leaves. This does three things: holds soil moisture; keeps the large leaves off damp soil to prevent rot; maintains the cool root run that many plants (especially cool season vegetables) require for best production. Aluminum foil also has been used successfully as a lettuce mulch.

#### OKRA

In growing okra, a good mulch is important if your soil is heavy and rain abundant. Before the plants bloom, work the aisles. Hill the growing plants and mulch between the rows heavily with straw, old hay or

well-rotted cow manure. Mulch the rows themselves lightly—just enough to discourage weeds but not the okra—since this plant needs plenty of warmth. Grass clippings are ideal for this light mulch. Other gardeners have found that leaves—even oak leaves—are good for mulching okra.

#### ONIONS

Mulch will aid the first stages of onion growth and maintain the plants during cold weather. Don't put much stock in the rumors that onions don't appreciate mulching. Mrs. Paul Gillette of Shelton, Washington reports that she put several inches of fresh fir sawdust on her onions and had the biggest and best she ever saw. Gordon Snyder of Glidden, Wisconsin plants his onions in spring—plowed ground under a two-inch mulch of kiln-dried hardwood shavings. That's all the work he does and he has been taking first prize for onions at the local country fair for several years. Ruth Stout has always claimed that her hay mulched onions are extremely mild and good eating. Walter Starns of Bethel, New York, echoes Mr. Snyder's statement on kiln-dried sawdust and shavings with Spanish onions. "It will", he says, "definitely produce larger winter onions."

#### PARSNIPS

To prolong the use of fresh garden parsnips, heap leaves high over the rows as cold weather moves in. These leaves will prevent the soil from freezing, and enable you to pull fresh vegetables from the ground long after the rest of the garden freezes solid.

## PEAS

Trying to grow peas all summer is a rather hopeless gamble unless the most important growing principle is observed—mulch early and mulch deeply. Use straw or any material that's handy but be sure it is put on as soon as the seeds are sown—rather thin at first, then more heavily as the plants get started. Provide a deep buffer of mulch between the heat of the atmosphere and the soil. The cool, moist root run is the important difference between success or failure of summer-long peas.

Ruth Tirrell knows that peas must go in early, and the soil has to be ready to receive them. That's why an early mulching program includes plenty of organic material that gets incorporated into the soil usually the autumn before. Leaves or other clean debris are dug in and a mulch of similar material is put down for the winter. The result is enriched, productive soil that yields high quality vegetables. After the peas are planted she draws back the winter mulch to the furrow. It could cover the latter loosely. Because peas are a coarse plant they will come up through it. By the time the peas are pulled up the winter mulch will have just about disappeared. If you can, renew the mulch. Use grass clippings, hay, straw, weeds or the nitrogen-rich pea vines themselves. The mulch of organic material will prevent root rot, a disease to which peas on poorly drained land are susceptible.

## PEPPERS

Peppers respond well to mulching. Most any good organic material, such as hay or grass clippings will do. But if you want early-ripening peppers, use a tar-paper

mulch in conjunction with glass cloches to permit planting the peppers two to three weeks earlier than you normally would. Use a good-quality tar paper since this will be a mulch to use and reuse for years. Cut 18-inch squares of the tar paper and put a five inch hole in the center of each. Place the tar paper over the ground with the plant growing through the hole. Cover the plant with the cloche, which can be made by cutting the bottoms of one-gallon clear glass jugs.

The tar paper mulch will collect the heat of the day and help maintain it through the night. It will keep the ground moist, although it won't contribute anything nutritional to the soil. The individual greenhouses will allow the peppers to get the sunlight and still be protected from late spring frosts.

When the pepper plant fills the cloche, remove it and the tar paper and put down an organic mulch.

## POTATOES

Probably no other garden plant is more synonymous with mulching than potatoes. You can grow potatoes under mulch, in mulch, on top of mulch—almost any way in fact—and get satisfactory results.

Generally, planting potatoes on top of any mulch remaining from last season is effective. After they are set in rows, cover the eyed pieces with at least 6 to 8 inches of hay, straw or other loose material. If soil stays cold in your area during early spring, try a delayed mulch. To harvest early potatoes, remove hay or straw carefully when blossoms start falling, separate small potatoes from stems, and generally replace mulch. One organic gardener planted potatoes on top of the ground



in a cover of leaves. The leaves are piled over the potato patch the previous fall to a depth of three feet and left there for the winter. By spring they are packed down and earthworms are working through them. Potatoes are planted by laying the pieces directly on the leaves in rows where they are to grow. The seed is then covered with 12 to 14 inches of hay or straw. More mulch is added later, if tubers appear through the first. When harvest time comes, the mulch is pulled back and



Early potatoes are harvested from their thick bed of mulch, then covering is replaced.

potatoes are picked and put into their sacks with no digging necessary.

Don Tillung of Deerfield, Wisconsin, uses a method of raising potatoes on top of the ground which eliminates a lot of labor. His mulch cover is eight inches of marsh hay—usually the cheapest type. If the soil is high in nitrogen content, the hay on the bottom of the mulch will tend to decay rapidly which may require more to maintain a minimum of eight inches. Advantages are that you don't have to cultivate and you don't have bothersome potato bugs.

Edith Sarwell of Lake Forest, Illinois uses a straw mulch to plant her potatoes. The mulch keeps the soil cold and could cause a late maturity—if that's what you are after. Or, why not try two plantings—a very early one for a good head start and another in July for winter and spring harvesting. If hay or leaves are not available in your locality, try to cover each potato row with an eight-inch layer of pine needles. It makes a light, airy mulch and keeps moisture down under the needles. That will make the earthworms mighty happy and the potatoes mighty good eating.

There's one sure mulching method that controls the potato bug. It was conceived and tested at the Organic Gardening Experimental Farm. The potato seeds must be planted and the soil covered with a one-foot layer of hay or straw mulch. Through experiments it was determined that the hay is the better of the two. The plants, of course, will grow through this mulch, but the potato bug, whose egg winters in the soil, cannot climb up on the potato stem through the heavy mulch. This method of heavy mulching proved so effective that not a single

potato bug could be found on the potato plant. At the end of the season the mulch is plowed under, thus enriching the soil with valuable organic matter and giving it a better structure. The plants also benefit from this highly successful method, for they obtain a greater health and resistance to insects and disease.

Kenneth Polscer discovered that potatoes planted in soil and mulched with hay give better results than potatoes mulched with plastic. The hay keeps down the weeds, and can be turned under to decompose in the soil and provide added nutrients, something plastic can never do.

#### PUMPKINS

Pumpkins will profit from hay from a newly-mowed field. Mulch around each hill. Before laying down the mulch, work in a feeding of cow manure.

In Troy, New York a group of youngsters discovered that composted leaves, old hay, straw, cow manure and bone meal gave forth insect-free pumpkins that had no trouble from dryness. "From now on," says Joe Miller, "we're growing everything in the garden in organic compost."

#### RADISHES

Donald Shaw of Colona, Illinois planted white winter radishes on the Fourth of July, and mulched them with chopped, partly-decayed clover hay as soon as they were high enough. The results more than pleased Shaw, as one of the radishes scaled 6 pounds and measured 28 inches long.

"We ate the smaller ones—those that weighed only a pound or two each!" Shaw said.

#### RHUBARB

Thick stalks of rhubarb result from continuous heavy feeding. To keep the soil up to the standard necessary, spread a thick mulch of strawy manure over the bed after the ground freezes in winter. Nutrients will be leached into the soil during the winter. In spring, rake the residue aside to allow the ground to warm and the plants to sprout. Then draw the residue together with a thick new blanket of straw mulch up around the plants. Hay, leaves or sawdust also make excellent mulches for rhubarb. A side benefit of the sawdust and leaves is that they contribute to the acidity of the soil, and rhubarb thrives in an acid soil.

#### SPINACH

Spinach can be mulched with grass clippings, hay or ground corncobs and it will be the better for it. Inez Grant of Columbia, Maine has used hay successfully. Since spinach doesn't grow well in acid soil, acidic mulches such as sawdust or leaves shouldn't be used. Summer mulches shouldn't be applied until the leaves have made a good growth.

#### SQUASH

Squash needs an extra special dose of mulch, particularly during hot, dry summers. Try a heavy dousing of compost and rotted sawdust. Make your mulch as much

as four inches deep. Aluminum foil mulch has been found to repel aphids from squash plants.

#### SWEET POTATOES

Sweet potatoes are heavy feeders, and they grow well when they have sufficient moisture. A good mulch cover with compost will fill both of those requirements. Old leaves and grass clippings on the sides of the rows make an adequate mulch, as do the old standbys—hay and straw. If you make a hill for your sweet potatoes, be sure you mulch them well, allowing plenty of room for them to develop. At season's end, work the mulch deeply into the soil to build up humus content.

#### TOMATOES

Deep mulching and delicious tomatoes go hand in hand. Organic gardeners have been experiencing great results for years with mulching. Take the case of Robert E. English of Baltimore, Maryland. He mulches his plants when they reach sufficient size. If leaves are handy, they are used to a height of four inches or more, but with grass clippings or sawdust the plants may be somewhat smaller. Much of his mulching is done following a storm, using leaves, since they are not shredded. Either grass, sawdust or old rugs are used to hold the leaves in place. With every passing year English has found his soil easier to spade and the number of earthworms on the increase. He believes his use of mulch has contributed greatly to the soil fertility. Frank and Cecile Fiederlein of Cape Cod have found success in mulching their tomato plants with leaves and pine needles. "The tomatoes were the envy of the neighborhood. Besides having enough for our family and friends, my

wife put up fifty-five quarts for the winter," Fiederlein said.

## Fruits

#### BANANAS

Oliver R. Franklin of Fort Myer, Florida, showed his neighbors that organic mulch methods could revive banana growing. "They told me that bananas did poorly here," he said, "and from the looks of those growing in nearby yards, it appears believable. However, I planted mine in the same kind of soil, but shocked the neighbors by capturing islands of water hyacinths floating by in the river, and pitching them ashore with a hay fork and mulching the bananas a foot deep with them. I figured that the rains had washed a lot of soluble minerals and trace elements into the river to be captured by the weeds, and I wanted some of it back.

"When the hyacinths decayed around the bananas, I mulched them deeply with the most aged shavings and sawdust I could find. The plants responded by growing twice as tall as their parent stock, with none of the usual root rot and no insect pests."

#### BLUEBERRIES

Although blueberry plants, like most other harborages of the garden, profit from mulch, it's best to be a bit wary about how much and what you use. When setting out blueberries, the soil pH should be between 4.5 and 5.0. By applying organic mulches—never any lime—you'll be able to keep it that way. Peat moss, hard wood, leaves, pine needles, and similar materials decompose into an acid compost-mulch. Also good is sphagnum moss or shredded oak leaves. If the pH is

unusually low, the mulch may be composed of shredded corn cob. Use saw dust as a mulch only if it has been composted with manure for at least a year.

Don't go hog wild mulching blueberries. When plants are first set out, a three to four inch mulch around the plant or about one inch over the whole plot is adequate. Increase the depth as the plants grow to a maximum of six to eight inches. Although mulching may prevent many bacterial and fungus diseases, over-mulching could open a Pandora's box of problems, particularly if the soil is poorly drained, making blueberries more susceptible to disease.

Frank Fiederlein of Cape Cod is a blueberry mulcher who has had success using pine needles, sawdust, some decayed leaves and sand. Around the roots he uses a mixture of sand, loam and peat moss. Each year he adds a two inch layer of pine needles. He reports that his yields are getting bigger all the time.

#### BOYSENBERRIES

Ethel M. Stephens of California has found that boysenberries profit from organic mulch. Because boysenberries are terrific feeders, a mulch of well rotted compost or leaves does a good job. Ethel has found that after many years of that treatment, her soil has become a deep, soft mass of organic material that holds moisture like a sponge. In hot, dry weather she mulches partially rotted sawdust to further conserve moisture and humus surrounding the roots.

#### CANTALOUPE

Cantaloupes and other melons need lots of moisture from the time they come up until they are nearly full-

grown. For this reason, they'll do better under a thick mulch. The best materials to use include hay, grass clippings, shells and hulls and newspapers. Stay away from sawdust and leaves, since these materials may add too much acid to the soil for the alkaline-loving melons.

The mulch should be put down before the fruit develops, since handling may damage the tender melons. Once the melons do develop, they'll be resting on a clean carpet of mulch and won't be prone to rot.

#### CITRUS TREES

Mulch under a citrus tree should be kept at least eight inches from the base of the tree so it doesn't foster root rot. Keep the mulch pulled well back and don't allow any irrigation water to stand at the foot of the tree.

Bearing this caution in mind, there are few things more beneficial for a citrus tree than a good mulch. One California orchardist allows the trees to mulch themselves. He just never rakes up the leaves that fall from the trees. Other orchardists grow the mulch material within the orchard itself. Summer cover crops that may be planted in the orchard and cut for mulching material include soybeans, cowpeas, millet, sudan grass and buckwheat. Winter cover crops that can be cut for mulching include rye, wheat, vetch, clover, alfalfa and kudzu beans.

Growing the mulching material in the orchard is a practice which stemmed from the large amount of material needed to properly mulch such an area. An orchardist thus doesn't have to reserve areas free of trees for cultivating mulching materials, nor does he have to purchase materials. Both of these practices con-

tinue, however. Besides the various grasses that may be used for mulching materials, you can use sawdust, weeds, peat, corncobs, brewery and canning wastes, rotten wood and leaves and, of course, stones.

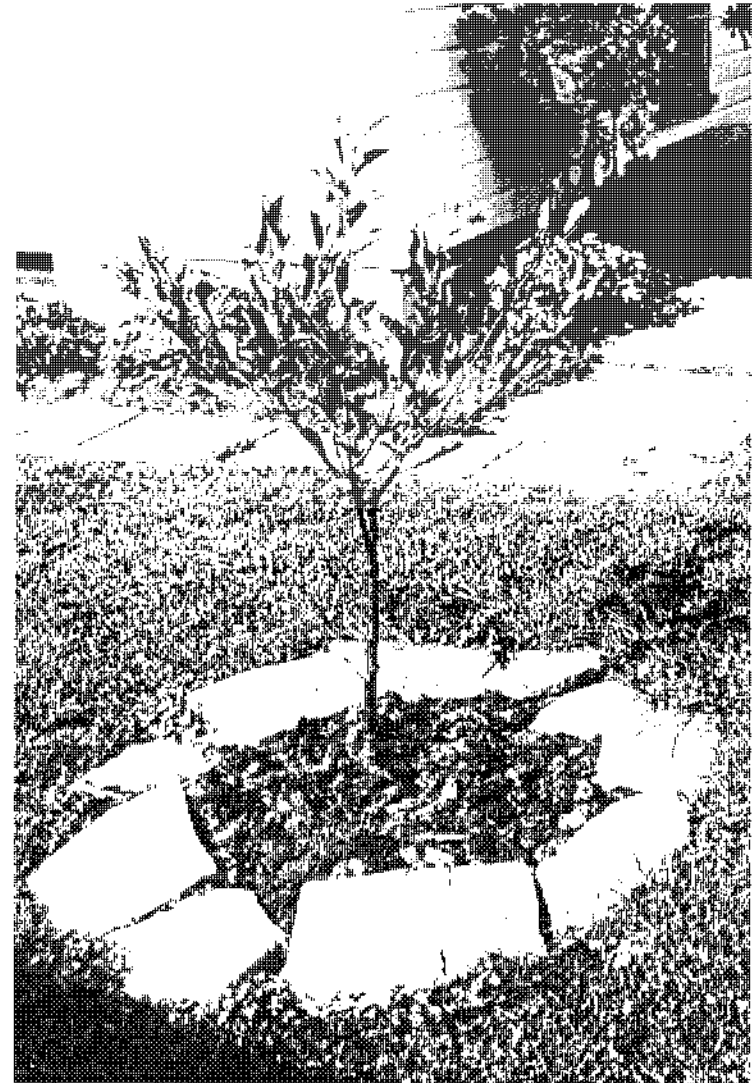
Tests in New Zealand have indicated that citrus trees under mulch are healthier and produce better fruit than those not mulched. In addition, the mulched trees need only half as much fertilizer as unmulched ones. Similar tests in the United States have demonstrated that mulched trees come into bearing sooner than trees under clean cultivation. Mulches are particularly beneficial for trees between one and four years old, since these trees are most sensitive to competition from other vegetation.

#### FIGS

Like all fast-growing tropical plants, the fig responds quickly to a good mulch. A heavy mulch in summer to retain moisture, and in the winter to protect against the weather, plus a spring application of good compost, will usually guarantee even growth. A tree so treated needs no cultivation.

#### FRUIT TREES

Organic mulches are highly recommended in starting and growing fruit trees, particularly the dwarf variety. After the trees begin to grow, add a shovelful of well-rotted manure around each tree. Then mulch thoroughly. Apply the mulch to conserve moisture and aid new root growth. If you use straw, apply one half to one bale per tree. Other materials that can be used include compost and leaf mold or hay. Keep all mulches



Flat stones should be used to anchor mulch around young fruit trees.

away from the base of the trunk to discourage rodents which can damage trees severely. Stone or stone chips might make an effective mulch, keep weeds down and deter animal pests. If your fruit trees are growing in a bare, recently pulled orchard, spread a mulch over the root area in late fall before temperatures tumble. You may not be able to regulate the winter blasts that sweep the branches and kill the bugs, but you can preserve your orchard for another year.

Keep in mind that your soil needs to be kept moist (not wet). A soil kept wet invites stagnation which leads to root rot. Water once, then get down to the business of mulching. The mulch is especially important during the first growing season, whether transplanting is done in autumn or spring. The mulch conserves soil moisture, but it also keeps the soil cool under the hot summer sun. Moisture and coolness are equally important in promoting vigorous root growth. Whenever rainfall is scant (naturally or unusually) a thorough soaking of the soil every two or three weeks will keep the trees growing as if there were no drought.

And if you have summer showers, you can make better use of them by mulching. This prevents thorough drying for a time. If you have scattered large rocks on top of the soil under the mulch, they act as condensers to return rising moisture to the depths. But the greatest soil moisture loss is through transpiration of the leaves, and this is one thing that you do not want to prevent, because it is necessary for their growth.

Mrs. C. F. Brock of Jay, Oklahoma has found that mulching her peach trees with maple leaves was just what they needed. "In the fall two years ago, I carried

six sacks of maple leaves and dumped them into the place I had spaded out along the peach trees, (mixing several spadefuls of rotted manure in the soil), and since I did not have rocks to cover the leaves, I used old brick on top and around the edges.

"My husband laughed at me—but when the peaches were ripe, he didn't laugh any more. He never saw such large well formed peaches and the nice part about it was there were no webs. Those mouth-watering luscious peaches made a believer out of him. He mulched all his fruit trees this fall."

#### GRAPES

Grapes deserve mulching, even the first year. Alfalfa hay and sand-straw-steer manure mixture rank high on the list of mulch-fertilizer combinations. Before the rainy season is the best time for the overall spread of mulches and various manures. If you choose hay or shredded leaves, work additional nutriment into the soil. It might be best to use compost, wood ashes or granite dust as fertilizer.

#### LOGANBERRIES

Sawdust mulching greatly increases cane growth and yields as compared to clean cultivation.

#### MOCK ORANGE

During the hot days of summer, it is well to use a mulch three to four inches thick for the mock orange tree. Put it on after a thorough watering and use different materials. Whether it be composed of vegetable matter from a compost pile, manure or leaf mold, all would

be suitable. Although some mulches are at the same time top dressings, they also prevent over-rapid evaporation, and enrich the soil by furnishing new food to the shrub.

#### PAPAYA

Edwin H. Avrimis saved an untreated papaya tree by using a large quantity of mulch. The tree had been uprooted by a heavy wind and it was decided to destroy the tree as its roots were largely out of the ground. But instead, the tree was propped up at an angle of some 30 or 40 degrees and loads of compost and garden soil placed over the roots until it was well covered. When it was found that the tree was still alive and even putting out new branches while burring heavily, more and more mulch was added from time to time, and it made a surprising comeback. It not only matured a large crop of food that it carried when overthrown, but actually put out several tree limbs and grew a large crop of good-sized fruit on these in addition.

#### RASPBERRIES

Sawdust and wood chips make an excellent mulch for raspberries and have increased production in Canadian tests as much as 50 per cent. Apply a sawdust or chip mulch about three or four inches thick to the base of the plants. The mulch will save moisture, cut down weeds and raise yields. Browned corn stalks and poultry litter also make a good raspberry mulch as do decomposed leaves when used as deep as five inches.

Jean Bowman of Pennsylvania says that she hasn't needed direct fertilizer applications in many years.

“But,” she writes, “we have mulched at one time or another with pine needles, sawdust, grass clippings, oak leaves and wood chips. These have decomposed and have enriched the soil, conserved moisture, shaded the ground and smothered most of the weeds. Beth Criteser of Roseburg, Oregon uses grass clippings and leaves as a mulch and fertilizes all of her garden that way. She had berries more than nine feet up the vine and managed to pick enough for dessert on Thanksgiving Day.

#### STRAWBERRIES

The very nature of a strawberry makes it both responsive to organic methods and most sadly vulnerable to poisonous sprays. The root system fans out below the crown in a perpendicular pattern rather than a horizontal as so many other plants do. Tiny hair roots scatter in all directions from the main roots in search of nutrition and moisture. Mulch should be well dug in to keep the bottom leaves clear so air can circulate around the plants, otherwise berries will mold on the stem.

If the mulch is allowed to remain fairly late in the spring, the plants will be protected from starting into growth so soon that their blossoms may be frosted. When the weather starts to warm up, watch the plants under the mulch. They will show definite signs of wanting to grow, and the leaves will begin to yellow when they need the sun. This is the time when the mulch should be pulled back, leaving enough straw around the plants to cover the bare soil. Leaves will grow up through this light mulch, which will help to smother the weeds and to keep the berries clean. If a late frost threat-

ens after blossoms have begun to develop, draw the winter mulch back over the plants for the night and remove it in the morning.

The best materials for mulching strawberries are wheat straw, cotton hulls, crushed corncobs, peat moss, wood shavings, pine needles or spoiled hay. Leaves make a good mulching material, particularly if corn stalks or tomato vines are applied first to prevent matting.

Although a good thick mulch will prolong the growing season, all good things have to end sometime. When the pickings dwindle down, spread an inch of young, rich compost around the remaining plants and mulch the beds heavily with clean straw. Draw the mulch up to the plants and, as new runners develop, tuck the most promising under the mulch. When the ground is frozen in fall, recheck your mulch and be sure it is thick enough. If you are using straw or hay, a depth of six inches is not too much, particularly in north central states.

#### WATERMELON

Watermelon vines may be mulched to keep down the weeds and retain the large amounts of moisture needed by the maturing plants. The mulch shouldn't be applied before the soil has warmed, however. Hoeing will keep the weeds down until the soil is warmed sufficiently to permit mulching. Using straw, hay or chopped leaves, spread a six-inch mulch over the entire watermelon patch, drawing the covering up to the bases of the vines. This should be done before the fruit is formed, since it is tender and easily damaged. The best time to apply the

mulch is when the soil is thoroughly dampened. As the watermelons develop, they'll be kept dirt-free by the mulch and won't be prone to rot on the vines.

## Ornamentals

#### ARBORVITAE

As every arborvitae lover knows, winter injury can be a real nemesis. It causes a browning of the previous season's growth in late winter or early spring due to drying winds or hot sun. Trees in exposed locations are more severely affected. This discoloration is due to evaporation of moisture from the leaves or needles faster than the roots can pick up water and it is very apt to occur on newly transplanted trees. A thorough mulching of some heavy material like straw or hay will maintain moisture in the ground and help prevent this disease.

#### AZALEAS

The importance of mulching azaleas cannot be over-emphasized. The roots are extremely shallow—most of them lie within three or four inches of the surface—and they must be kept moist at all times. Thus a mulch of at least four inches is necessary.

Pine needles, oak leaves and sawdust from oak, cypress or hemlock make excellent mulches. A mixture of materials is preferable since the mulch in decaying continually adds food to the soil. Many growers find that a combination of pine needles and oak leaves is especially good. The needles keep the leaves from blowing and are high in acidity but slow in decaying. The oak



leaves decay more rapidly and, while lower in acidity, are higher in food value. Seaweed added to the mulch from time to time adds trace minerals. Manure is not recommended for azaleas because of its alkaline reaction.

Some gardeners have found they're able to bring their azaleas through the winter with much less loss by applying winter mulch early in the fall. One gardener uses four inches of bark dust or sawdust and tills it under every spring. By adding mulch before freezing, he has found most of his plants come up from the roots even if peripheral ones are killed.

Victor A. Carley of Berryville, Arkansas, uses mold or shredded leaves—mostly oak—to revitalize his otherwise hard to handle azaleas and wild orchards. The finely shredded leaves keep the soil conditioned if they are packed around the roots. Robert Couldwig reports that azaleas can be transplanted after being mulched like that, "and you would hardly know they had been moved." The leaves are neat, have no weed seeds, and hold moisture like a sponge, keeping the growth zone cooler in hot weather.

Mulching can be a plus if you are stricken by azalea petal blight, a disease that produces small pale spots on the inner surfaces of the petals of the colored flowers and brown spots on the white flowers. The spots rapidly enlarge until the whole flower collapses. A good preventative technique is covering the azalea beds with several inches of mulching material. That helps keep the arresting structures free of the spores. Avoid overhead watering while the plants are in flower and rely upon the deep mulching instead.

#### BEGONIAS

Buckwheat hulls are an especially good mulch for tuberous begonias when these moisture-lovers are put into the open ground rather than pots. Tuberous begonias are tender, naturally cool-weather plants, and are heavy feeders. The soil should be cool and moist to make nutrition constantly available, but the soil should not be soggy, which may cause rotting of the tubers. Buckwheat hulls improve the appearance of the begonia bed, and prevent the blossoms from becoming mud-splattered.

#### BOXWOOD

Boxwood profits from mulching particularly in the fall. Like most evergreens, boxwoods prefer a straw, leaf mold or rotted manure mulch. Such mulches prevent wide fluctuation in soil temperature and help the soil hold moisture. The mulch can be left on all winter, and then worked into the soil in the spring. A newly-planted bush should be mulched to the same depth that prevailed in the nursery or woods.

#### CHRYSANTHEMUMS

If your winters are not too severe and your mums are hearty, you may want to mulch heavily with straw or hay and leave them out over the winter. The object of this protection is prevention of soil heaving and the resulting root damage. If you leave your mums outdoors over winter, do not confine them to pots, but allow them to bloom naturally in October and November.

## DAHLIAS

Dahlias will profit from a mulch of dried grass clippings or old hay about six inches deep. Buds form quickly after mulch is applied, so keep that in mind for planting your garden color.

## DAISIES

Some nurserymen claim you can carry daisies through the coldest winter if you mulch them with eight inches of straw after the ground freezes. It might be a good technique particularly for gardeners up north who have a tendency to lose these vibrant flowers.

## DELPHINIUMS

Delphiniums need a thick mulch of straw and clipped grass to keep the roots cool through the hot summer and to conserve moisture. You might also like to apply a generous amount of wood ashes, particularly if slugs or snails seem overly fond of your new delphinium shoots.

## DOGWOODS

Dogwoods profit from a pine straw or leaf mulch three or four inches thick. Avoid making a mound of mulch or soil around the plant, which will shed water away from it, as dogwoods can often use a good drink during dry summer months.

## EVERGREENS

Small evergreens, like any other planting, benefit from regular watering, frequent cultivation, or most

important, a mulch to help control weeds. You probably will find a heavy mulch between the trees of either compost or rotted manure to be effective. Even as seedlings, evergreens are tough, but the first winter it might be a good idea to tuck a deep layer of straw around each tree. If the straw is sufficiently moist in the fall, they should come through the first winter in fine shape. One organic gardener has found that a heavy mulch of equal parts of leaf mold and cow manure does a good job of preventing deep freezing and also supplies adequate and continuous water. Normally, a heavy leaf mulch, preferably oak leaves which last longer and contribute more to an acid condition, will give your evergreen trees the shot in the arm they need.

## FERN

A woody location, with shade, moisture, and an organic soil high in leaf mold is perfect for the majority of the ferns. Oak leaves and compost are good substitutes for the leaf mold. Peat moss is also an excellent choice because it contributes to the neatness of the beds and ferns just love its acidity.

## FLOWERS

Flowers make up a big category, but generally you may use a mulch to alter the soil texture to suit specific plants. Bulbs like Alpines which require a gritty soil may be accommodated by spreading a fine rock chip mulch over the soil surface. Damp meadow conditions may be simulated by laying perforated water pipes below the surface of the soil. A chopped leaf compost mixed with plenty of rotted manure or cottonseed meal

has approximately the texture and nutrients of rich wood soil. If acid spring water is available on the site, a planting of sphagnum moss in it will bring a fine bed for picture plants or bogged orchids. During the June growing months you want to be certain that all your flowers are under mulch. Ground corn cobs are fine for roses, while coffee grounds mixed with about an inch of sawdust make a handsome flower bed mulch. The coarser screenings from the compost heap can also be spread evenly around the flowers.

Texas gardeners have found that cotton burr mulching makes the difference between success and failure. Of course, in that region the material is plentiful as well as effective and it produces humus on the spot. Spread the dried burrs several inches deep around the base of the plants. Cotton burr mulch is light in weight and sufficiently porous so that it will not smother. When spread on flowering plants, the rich brown composted burrs give a neat, attractive appearance to the beds, and control weed growth at the same time.

Most annuals like a late fall planting, even though they are particularly hardy. After the first thaw in your area has penetrated the ground about an inch or so, try a mulch three to six inches thick depending on the severity of your winters. It's probably best to make it a light mulch, such as compost, straw, manure, pine needles, fresh or partly decayed leaves, peat moss or salt hay.

In early spring give consideration to mulching your perennials. If there is plenty of spring rainfall in your area, rake back the mulch to allow the furrow to warm up. But if you are in an area of skimpy rainfall, leave

the mulch in place and content yourself with later warming. Before it gets too hot be sure to mulch your perennials with compost and rock fertilizers. To keep the weeds out you might use peat moss—a material which contributes to flower bed neatness as well as making the soil on the acid side.

#### GLADIOLUS

Do you want to experiment with materials to mulch gladiolus? Florence M. Chase has found that hay is the most satisfactory mulch material since it does not mat and allows the spikes to push through easily, eliminating their chance of being deformed. Normally she mulches to a depth of about five inches, and has had excellent results with discouraging thrip infestation. Cornell University experimenters at Farmingdale, New York have discovered that aluminum foil protects gladiolus from attack by aphids. The researchers have found it highly effective in combating the cucumber mosaic virus, a disease carried from plant to plant by aphids which cause "color break" in flowers and streaking of leaves.

#### HEATHS

Heaths demand an acid material mulch and will thrive in it. That means you probably should choose an oak leaf mold, sawdust or pine needle mulch and apply it during the early growing season.

#### HOLLY

Because hollies love water and moisture, be certain to apply a yearly surface mulch of well rotted oak leaf

compost or wood leaf mold. Hollies also benefit from a tobacco stem mulch placed over the root area underneath the entire branch spread of the tree. The tobacco stems are rich in nutrients and perhaps detrimental to insects. When fed with a mulch of tobacco stems, hollies respond with darker green leaves and more berries.

In New Jersey, Earl Dilatush reports that oak leaf mulches are essential in growing the bright red-berried holiday greenery. He reports many cases where a heavy mulch of oak leaves has revived and restored failing holly trees.

#### HYDRANGEA

Pearl Wright has found that plenty of mulch—enough to protect the entire root system of a hydrangea—will get even the most pampered house pet safely through the rigors of a Mid-Illinois winter. She first mulched her hydrangea heavily with straw, working it well along the stem and adding a heavy layer of cow manure. Figuring the manure would act “just as it does in a hot bed”, she then covered the whole thing with sacks. When her straw-mulched plant survived, she added potato, apple, pear and banana peelings—in fact, all the kitchen left-overs including meat and egg scraps. It was no wonder that hordes of earthworms could be seen in her hydrangea beds digging around the plant and aerating the soil. If you want to grow good hydrangeas, especially in an area where the temperatures drop to twenty below and stay there, put enough mulch around your plant so that you protect the entire root system. The results of Pearl Wright’s growings can’t be topped—one fabulous shrub bore 240 blossoms at once.

#### IRIS

Iris mulch should be applied to the base of the plant where it can control weeds growing in the flower beds. Use any organic matter on hand—sometimes strawberry plants from the old bed or just dry grass clippings. Ruth Stout disproved the old theory that bearded iris can’t be mulched. She mulched her iris with loose hay and had profuse blooms as beautiful as any around. If the sun’s rays can get through a layer of loose hay to make potatoes green, she concluded, it can obviously penetrate the same mulch on a bed of iris and give the rhizomes the needed treatment. It may be best not to use anything heavy—such as peat moss—she admits, but loose hay is a natural.

#### LAWNS

There seems to be little doubt that grass seed newly sown will benefit from a cover of mulch. Often straw or old hay maintains enough moisture to allow the seed to germinate. The covering shouldn’t be so thick as to prevent the grass from sprouting through as seedlings. Even a light covering of green grass clippings will help grass seed germinate.

The mulching status of already established lawns becomes more controversial, however, because a lawn can mulch itself as it is mowed and there is a great temptation to allow the grass clippings to deteriorate and turn into humus. The theory is that letting the grass clippings remain uncollected will provide for a more fertile soil and a more luxuriant bed of sod. Some gardeners argue, however, that the practice of not collect-

ing grass clippings produces a sick thatch that inhibits grass growth and development.

Actually, both schools of thought bear the seeds of truth. If you do the same thing with your grass clippings all the time, you're wrong. Occasionally allow your grass clippings to go back into the soil for added enrichment. But never allow them to accumulate so thickly as to form the underlying thatch.

#### LILACS

When spring rolls around, spread a six-inch layer of well rotted compost around the lilac bush and out far enough to take in most of the branch spread. Dig that in well, being careful not to injure the root, and cover with a mulch of hay or leaves with ashes, or pine needles if the soil is not acid enough. The lilacs, like most shrubs, grow best in slightly acid soil. If it is too acid, an application of agricultural lime is recommended. In the late fall work that mulch into the soil and remulch with leaves or grass clippings for the winter. That will prevent heaving of roots when the ground freezes and thaws.

#### LILIES

Lily bulbs must be kept well drained, and yet remain cool and moist. That condition demands a good mulch. Manure may be used over the top of the soil, if it is sufficiently decayed. A deep mulch of leaf mold over the lily bed will be appreciated during the hot weather, although the lilies may be planted among low growing annuals or bushes that will keep the soil shaded. After the first frost, cut your lily plants back to the ground

and cover with a light mulch of sawdust to protect new bulbs that are growing on the stem. Later, when the ground is frozen hard, cover with a very thick mulch of hay to pull them through the winter.

#### PANSY

Pansies want a cool, moist soil and a rich mulch, for they are gluttons. Use manure, compost, woods soil, leaf mold, or sawdust and shavings mixed with sheep or poultry manure. The mulch feeds them richly—they are surface feeders—and keeps the roots cool in summer and warm in winter.

#### PEONIES

Peonies can profit from a mulch of seaweed if it is available. If not, you might want to use a pine-bark mulch which will leave a nice, red-brown appearance. The pine bark will provide added nutrients to the soil and if you add pigeon manure over the winter you should have all the ingredients necessary for productive peonies.

#### POINSETTIAS

If you're transferring poinsettias out of doors, be sure you mulch them heavily. Be sure to keep them well mulched with lawn clippings or other good organic mulching material.

#### ORIENTAL POPPIES

Oriental poppies must be mulched in the fall. However, remove that mulch in the spring and stake them. By removing the mulch in springtime, you allow the soil

to warm up and the poppies to provide rich early blooms that will dot your spring garden.

#### RHODODENDRONS

Leaves and sawdust make excellent mulches for the rhododendron bed, chiefly because these plants need an acidic soil. These plants are subject to chlorosis, which stems from too basic a soil condition. The leaves will turn yellow or brown. An acidic mulch is an excellent preventative for this condition, or a good cure, should it occur.

It's usually best to add a winter mulch to rhododendrons before the temperature drops too far. By adding the mulch before freezing, you will help your plants to come up from the roots in spring. Rhododendron roots are fairly delicate and sensitive to soil heaving in winter. Add about four inches of sawdust or leaves in the fall and turn them under in spring.

#### ROSES

How important is mulch for roses? Frankly, it probably is rather foolhardy to attempt to grow roses without mulching. Horticulturist H. P. Rosen of Wright University in Arkansas says, "One cannot overemphasize the importance of a thick mulch, applied anew each spring as a sanitary measure. Such a mulch acts as an insulating layer that prevents soil-born infectious material from reaching new growth. Perhaps the best mulch is a thick layer of rotted cow manure."

Most roses will probably do twice as well with a mulch as without it, and often with roses a mulch may mean the difference between life and death.

Think about your mulching campaign early in the spring. Perhaps you will want to remove some of the old mulch that has been left to lie from last season. If you buried the top of the roses for winter protection under the mulch, resurrect them gradually. Then tear off the



Mulch can often mean the difference between life or death for roses, here being covered with a blanket of sugar cane.

old mulch entirely and work the tired old straw, leaves or whatever you used after it is half decayed into new compost heaps along with the winter's kitchen wastes and some fresh manure. Or if your rose soil is workable, turn the old mulch under right there. It will break down quickly, worked over by all the awakening and newly hatched soil animals, insects and bacteria. Earthworms begin to stir, slugs and snails chew up and break down any coarse mulch, and the spring cleaning of the rose bed is under way. When everything is operating efficiently, blanket the roses with a layer of fresh mulch, and the life of the soil continues to percolate under its brand new cover. Grass clippings from the earliest spring mowings will provide a nitrogen-rich cover. Freshly ground corncobs are fine for roses, while coffee grounds, mixed with about an inch of sawdust, make a handsome flower bed mulch. Shredded pine bark or cocoa bean hull, applied to approximately a two-inch level after spring pruning and seeding have produced excellent results. Even newspaper or sawdust on the rose beds has given excellent results.

Leaves are an excellent mulch for the rose beds, as they prevent alternate thawing and freezing that can destroy delicate root systems. But be careful they do not mat over the crowns, or crown rot will result. When leaves are used, the plants should be four or more inches in height; when using grass clippings or sawdust, the plants can be somewhat smaller. It's a good idea to mulch following a storm, using leaves, unless they are shredded. Use either grass, sawdust, or even old rugs to hold the leaves in place. Where sawdust is placed directly on the soil, pigeon manure should be put down

first to alleviate any nitrogen robbery by the sawdust. Some gardeners have experimented with mushroom compost and redwood sawdust. Others have used shredded pine bark or cocoa bean hull not more than two inches in depth. Put the mulch on after the soil has warmed up in the spring and keep it piled high during the growing season.

Gardeners have found that a well mulched bush doesn't invite predators. A good thick mulch and adequate ventilation are also the best preventative for the old nemesis, black spot.

When winter finally rolls around, you can prevent winter injury of roses from heaving and thawing. A proper application of a good mulch around the plants prevents the soil from freezing too deep and acts as an insulator. You might like to try a four to five inch mulch of ground corn cobs, manure, straw or peat moss. Put it on in the fall after the ground has been partially frozen, or not later than December. If your roses have been mulched during the summer, simply add two or three inches more of mulch material. That will keep the soil temperature more constant and prevent damage. Some rose growers prefer to mound their plants with soil to a depth of six to eight inches, but this is hard work and unnecessary.

#### SHRUBBERY

Established shrubs, like most other plants, should receive a good mulch during the growing season. Strawy manure makes an excellent mulching material during the early summer months. A leaf mulch under most shrubs will also replenish organic matter in the

soil. Unless fungus disease is a problem, leaves should be left where they fall and should be supplemented by liberal mulching with grass clippings, peat, corn cobs, straw, composted sawdust, or leaf mold. Leaves are an excellent mulch for shrubbery, and you might want to use it as a winter covering. Be sure to keep it well away from the trunk and apply only after the ground freezes to prevent the nesting of rodents.

# INDEX

## A

Acid, 17, 159, 161, 177  
 Acid reaction, 9, 148  
 Acids,  
     carbonic, 23  
     fulvic, 31  
     humic, 31  
     muramic, 31  
     teichoic, 31  
     uronic, 31  
 Aeration, 18, 22, 25, 28, 34  
 Aggregates, 20, 22, 40  
 Alaska Division of Agriculture, 54  
 Alfalfa, 28, 38, 140, 163, 167  
 Alkaline, 17  
 Aluminum foil, viii, 147, 149, 150, 152, 160, 177  
 Anderson, Dorothy, 12-13  
 Antibiotic substances, 26  
 Apples, 46, 49, 85, 93  
 Apple pomace, 142  
 Arborvitae, 171  
 Artichoke, 142, 144  
 Asparagus, 104, 106, 139, 144-145  
 Ault, Mrs. Sherreille, 109  
 Auximones, 26  
 Avrims, Edwin H., 168  
 Azaleas, 140, 142, 172-172

## B

Baterial gums, 30  
 Bananas, 161  
 Beans, 5, 35, 104, 113, 125, 145-146  
     lima, 2, 43  
     string, 2, 43  
 Beets, 5, 6, 125, 146  
 Begonias, 173

Beltsville, (Md.) Agriculture Plant Industry Station, 45-46  
 Binder, Morton, 55, 132  
 Biodynamic activity, 27  
 Bixler, Ruth, 76, 92  
 Blood meal, 119, 130, 132-133, 134  
 Blueberries, 143, 161-162  
 Bone meal, 70, 129, 158  
 Boron, 27  
 Bowman, Jean, 168-169  
 Boxwood, 173  
 Boysenberries, 162  
 Broccoli, 126, 146  
 Brock, Mrs. C.F., 166-167  
 Brooklyn Botanical Gardens, 37  
 Buckman, Professor Harry, 18-20, 29  
 Buckwheat hulls, x, 119, 127, 173  
 Burdick, Bart, 124

## C

Cabbage, 126, 135, 136, 146-147  
 Calcium, 26, 27  
 Camellias, 140  
 Canary Islands, 75  
 Cantaloupe, 162-163  
 Carbohydrates, 30  
 Carbon, 27  
 Carley, Victor A., 172  
 Carter, Charles, 147  
 Carrots, 5, 125, 147-148  
 Carter, Charles, 147  
 Castor bean pomace, 142  
 Cauliflower, 126  
 Celery, 148  
 Cellulose, 30  
 Chamberlain, C.E., 149  
 Chase, Florence M., 177  
 Chelation, 22, 26, 31



Cherries, 49, 85  
 Chrysanthemums, 173  
 Citrus trees, 44, 85, 163  
 Clover, 28  
 Cocoa bean shells, viii, 50, 139, 144  
 Coffee grounds, 148, 176  
 Columella, 83  
 Commercial fertilizer, viii, 48, 49, 53  
 Compost, ix, 6, 7, 9, 27, 28, 48, 49, 62, 95, 127, 135, 140, 141, 143, 150, 151, 152, 158, 162, 168, 176, 178, 180, 181, 184, 185, 186  
 Copper, 26, 27  
 Corn, 3, 9, 11, 35, 37, 113, 119, 125, 129, 130, 141, 147, 150  
   cobs, 28, 74, 104, 118, 128, 139, 143, 144, 162, 164, 170, 176, 184, 185, 186  
   shredded stalks, 28, 41, 74, 75, 127, 176  
 Cotton burrs, 75, 128, 176  
 Cottonseed meal, 11, 70, 119, 127, 129, 130, 134, 141, 175  
 Couldwig, Robert, 172  
 Criteser, Beth, 169  
 Crop residues, 9  
 Crows, 11, 43, 149  
 Cucumbers, 5, 35, 130, 150-151  
 Cultivation, 10, 29, 56, 118, 174  
 Currants, 49

## D

Dahlias, 174  
 Daisies, 174  
 Damping-off, 118  
 Decay, 20, 23, 24, 28  
 Decayed leaf mold, 4  
 Decomposition, ix, 22, 23, 26, 27, 29, 30, 47, 57, 59, 62, 64, 71, 128, 133, 161  
 Delphiniums, 174  
 DeVoc, Robert F., 112  
 Dew, 36, 106  
 Dogwoods, 174  
 Drainage, 18, 38, 39  
 Drought, 2, 5, 7, 10, 13, 36, 37, 118, 123  
 DuPont Company, 102

## E

Earthworms, x, 9, 13, 22-23, 37, 50, 64, 79, 85, 157, 178, 184  
 Eaton, Fred, 61  
 Eggplant, 141, 151  
 Eisman, Lucille, 148  
 English, Robert E., 160  
 Erosion, 22, 26, 41, 42, 43, 51  
 Evergreens, 60, 86, 118, 142, 174-175

## F

Fern, 175  
 Fiederlein, Frank and Cecile, 160-161, 162  
 Figs, 164  
 Fleck, Harold, 1, 43-44  
 Flowers, 9, 175-176  
 Franklin, Oliver R., 161  
 Frost, 2, 38, 67, 116, 119, 120, 136, 169, 180  
 Fruits, 161-171  
 Fruit trees, 50, 82, 85, 86, 92, 142, 143, 164-165  
 Fungi, 15, 26, 44-45, 79, 118  
 Fuschias, 132

## G

Garlic, 151  
 Georgia Agricultural Experiment Station, 41  
 Gillette, Mrs. Paul, 153  
 Gladiolus, 177  
 Gooseberries, 49  
 Grapes, 167  
 Grass clippings, x, 7, 27-28, 48, 49, 58, 74, 144, 145, 147, 151, 153, 154, 160, 163  
 Graybill, Paul, 113  
 Ground cork, 58, 60, 61  
 Gums, 31

## H

Hay, vii, x, 10, 11, 12, 30, 46, 48, 49, 54, 61, 63, 67, 104, 125, 126, 128, 129, 130, 134, 140, 141, 143, 145, 146,

147, 150, 152, 158, 160, 163, 171, 174, 179

Heaths, 177  
 Heaving, 38-39  
 Hemlocks, 96-97, 171  
 Herbaceous annuals, 57  
 Herbicides, x  
 Hill, Lewis, 47  
 Holly, 177  
 Hops, 75, 142  
 Humus, viii, 20, 21, 25, 28, 48, 64, 135, 136, 146, 179  
 Hunter, Mrs. Margaret, 111-112  
 Hyacinth plants, 75, 161  
 Hydrangea, 178  
 Hydrogen, 27

## I

Iris, 179  
 Iron, 26, 27, 30

## K

Keck, John, 99  
 Kohlrabi, 125, 151-152  
 Krill, John, 64-67, 120, 125

## L

Lawns, 179  
 Leaves, x, 9, 28, 30, 48, 49, 50, 64, 68, 71, 79, 80, 95, 117, 119, 125, 126, 127, 140, 142, 143, 145, 149, 150, 151, 152, 153, 154, 156, 158, 160, 162, 163, 164, 167, 169, 171, 173, 178, 182, 184, 186  
 Leeks, 152  
 Leister, Mary, 57  
 Lettuce, 3, 7, 11, 12, 13, 107, 125, 135, 136, 141, 152  
 Lignin, 30, 31  
 Lilacs, 180  
 Lilies, 180-181  
 Lime, 56  
 Lindeman, Joan, 146  
 Liquid fish solutions, 9  
 Loganberries, 167  
 Lyon, Professor T., 18-20, 29

## M

MacManes, John S., 94  
 Magnesium, 26, 27, 62  
 Malsch, Brownson, 145  
 Manganese, 27  
 Manure, 9, 26, 27, 30, 48, 49, 53, 55, 56, 62, 70, 76, 88, 89, 105, 129, 130, 134, 139, 142, 143, 147, 153, 159, 167, 172, 173, 175, 176, 180, 181, 182, 184, 185  
 Marshgrass, 13  
 Martin, Archer, 71  
 McCalla, T.M., 21, 27  
 Mead, Robert, 74  
 Melons, 5, 130, 163  
 Microbes, 22, 24  
 Microbial action, 26, 34  
 Microbiological life, 23, 44, 51  
 Miller, Joe, 158  
 Minerals, 17, 22, 23, 26, 30, 32, 62, 98  
 Mock Orange, 167-168  
 Molds, 30  
 Montfort, Georgia, 90-92  
 Morris, Edward P., 149  
 Mulenberg, Walter J., 96-97  
 Mulch,  
   amount of to use, 127  
   continuous, 10, 116, 117, 149  
   dark, 40  
   light, 40  
   nature's, ix  
   organic, viii, 23-33  
   permanent, 6, 10  
   spring, 139  
   summer, 116, 117  
   when to, 115-117, 130-132  
   winter, 116, 140, 141, 143  
 Mulching,  
   benefits, of, 28-29, 31-33, 34, 43, 45  
   book system of, 63-64  
   materials, 52-80  
   mistakes, 129, 136  
   questions about, 115  
   spontaneous, viii-ix  
 Mulching specific plants, 144 (see plant name)

## N

Nature and Properties of Soils, The, 18  
 Nebraska Crop Improvement Association, 21  
 Nematodes, Citrus, 45  
 Newspapers, 48, 109-114, 141, 163, 184  
 ways to use, 109  
 New York City Commission of Air Resources, 102  
 Nitrogen, x, 11, 22, 26, 27, 30, 31, 59,  
 61, 75, 79, 119, 129, 130, 132, 140,  
 144, 157, 185  
 deficiency, 127-128, 133  
 Nutrients, 9, 17, 22, 23, 26, 47, 62, 79,  
 176

## O

Oats, 65, 128, 129  
 Ohio Department of Highways, 42  
 Ohio Edison Company, 71, 73  
 Okra, 152-153  
 Onions, 11, 153  
 Organic Gardening Experimental  
 Farm, 83, 85, 157  
 Organic material, vii, 20-24, 26, 27, 29,  
 30, 32, 43, 56  
 Organic salts, 31  
 Oriental poppies, 181  
 Ornamentals, 171-186  
 Oxygen, 27  
 Oyster shell, 77

## P

Pansy, 181  
 Papaya, 168  
 Paper, 10, 48, 49  
 Parsnip, 125, 153  
 Patterson, Pat, 150  
 Peaches, 85, 94, 95  
 Peanut shells, 75, 142  
 Peas, 125, 136, 154  
 Peat moss, 55, 74, 128, 149, 152, 161,  
 162, 164, 170, 175, 176, 179, 185,  
 186  
 Pennsylvania State Agricultural Ex-  
 periment Station, 39  
 Peonies, 126, 142, 181

Peppers, 3, 125, 135, 136, 141, 154-  
 155  
 Perennials, 50, 57, 72, 117-118, 119,  
 139, 177  
 Pesticides, x  
 pH, 14, 55, 62, 161  
 Phosphorous, 26, 27, 30  
 Picon, 75-76  
 Pierson, Joan, 146  
 Pine chips, 58-59, 70  
 Pine needles, 41, 50, 74, 127, 140, 157,  
 161, 162, 169, 171, 176, 177  
 Plant roots, x, 20, 29  
 Plastic mulch, 101-108, 158  
 drawbacks, viii, 101  
 Ruth Stout on, 103-108  
 toxic fumes from, 102  
 Podzolic, 14  
 Poinsettias, 181  
 Polscer, Kenneth, 158  
 Potash, 26, 62, 75, 119  
 Potassium, 27  
 Potatoes, 4, 11, 70, 155-158  
*Public Works*, 43  
 Pumpkins, 158

## R

Radishes, 158-159  
 Raspberries, 44, 47-48, 49, 57, 168-  
 169  
 Rawson, Harold, 7-9  
 Raymond, Dexter, 151  
 Rhododendrons, 142, 182  
 Rhubarb, 54, 57, 89, 159  
 Rice hulls, 75, 128  
 Rodale, J.I., 84, 94, 98, 99  
 Rodale, Robert, 97-99  
 Root zone, 9  
 Rosen, H.P., 182  
 Roses, 9, 50, 72, 77, 89, 139, 143, 176,  
 182-185  
 Rot, 152  
 brown, 45  
 crown, 45, 119  
 fruit, 45  
 root, 26, 45  
 Rotation, 21, 27  
 Ruth Stout No-Work Garden Book,  
 The, 43

## S

Salt damage, 9  
 Sarwell, Edith, 157  
 Sawdust, viii, 13, 28, 48, 49, 53, 54, 55-  
 56, 57, 58, 74, 78, 127, 132, 140,  
 143, 147, 153, 159, 160, 161, 162,  
 163, 164, 167, 168, 169, 171, 177,  
 181, 182, 184, 186  
 Schoth, Harry, 151  
 Schroeder, Dorothy, 3  
 Seasonal mulching calendar, 138  
 Seaweed, 53, 54, 172  
 Seneca Buttercrunch, 6  
 Servais, L.T., 82, 94, 100  
 Shade, Lucille, 129-130, 135  
 Shaw, Dave, 69  
 Shaw, Donald, 158  
 Shields, Lee, 67  
 Shrubbery, 9, 185-186  
 Simonson, Roy, 15  
 Slimes, 30, 31  
 Smith, Mrs. Robert, 34-36, 51  
 Snyder, Gordon, 153  
 Sod, 10, 27  
 Soil,  
 balance, 9  
 clays, 17, 18, 20, 28, 119  
 composition of, 16-18  
 crumb, 20  
 flora, 44  
 friability of, 18, 28, 55  
 granular, 20, 29  
 gravels, 17  
 heaving, 38, 116, 118  
 home testing kit for, 17  
 horizons, 15  
 loams, 17, 18  
 microorganisms, 22, 24-25, 26, 27, 29  
 nutritional deficiencies in, 17  
 pattern, ix  
 porosity, 41  
 profile, 15  
 sample, 17, 20  
 sands, 17-19, 28, 38  
 structure, vii, 20, 22, 29, 36, 81  
 temperature, viii, 28, 34, 36, 38-40,  
 43, 51, 57, 61, 81  
 Soil Conservation Service, 21  
 Solvation, 22, 23, 31

Soybean meal, 11, 128  
 Soybeans, 44, 163  
 Sphagnum peat moss, 28, 29, 128, 161  
 Spinach, 125, 159  
 Spoiled hay, 12, 13  
 Squash, 3, 7, 13, 107, 159-160  
 Stahr, Alden, 45, 51  
 Starns, Walter, 153  
 Steinmetz, Ervin, 72, 73  
 Stephens, Ethel M., 162  
 Stone mulching, 81-100  
 as decoration, 83, 99-100  
 concrete molds for, 98  
 disadvantages of, 97  
 fortress method, 93-94  
 for sick trees, 85, 94  
 Stout, Ruth, 10-13, 35, 43-44, 103-108,  
 116, 119, 125, 134, 135, 153, 159,  
 179  
 Straw, x, 27, 41, 104, 117, 127, 129, 130,  
 132, 134, 141, 143, 145, 151, 152,  
 154, 155, 158, 160, 170, 171, 173,  
 174, 175, 176, 178, 185, 186  
 Strawberries, 49, 54, 57, 114, 129, 169-  
 170  
 Sulphur, 23, 27  
 Sweet Potatoes, 160

## T

Terrace gardening, 92  
 Thompson, A.P., 93  
 Tillage, 21  
 Tilling, Don, 157  
 Tilth, 28, 49, 64, 68  
 Tirell, Ruth, 5-7, 154  
 Tobacco, 37, 74, 178  
 Tomatoes, 3-6, 9, 10, 22, 104, 119, 120-  
 125, 126, 130, 132, 135, 136, 141,  
 160-161

## U

University of Illinois, 23  
 U.S. Department of Agriculture, 15, 21,  
 23, 41

## V

Vegetables, 144-161

## INDEX

Virgil, 83  
Voigt, Owen M., 77-81

### W

Wandzell, Bob, 53  
Ward, Vernon, 125  
Watermelon, 150, 170-171  
Watson, E.M., 150  
Wood, Margaret L., 85-90  
Wood chips, 13, 44-45, 48, 49, 69-74,  
143, 152, 168, 169, 170

Wright, Pearl, 178  
Wright University, 182  
Williamson, Cynthia, 135-136

### Y

*Yearbook of Agriculture*, 15

### Z

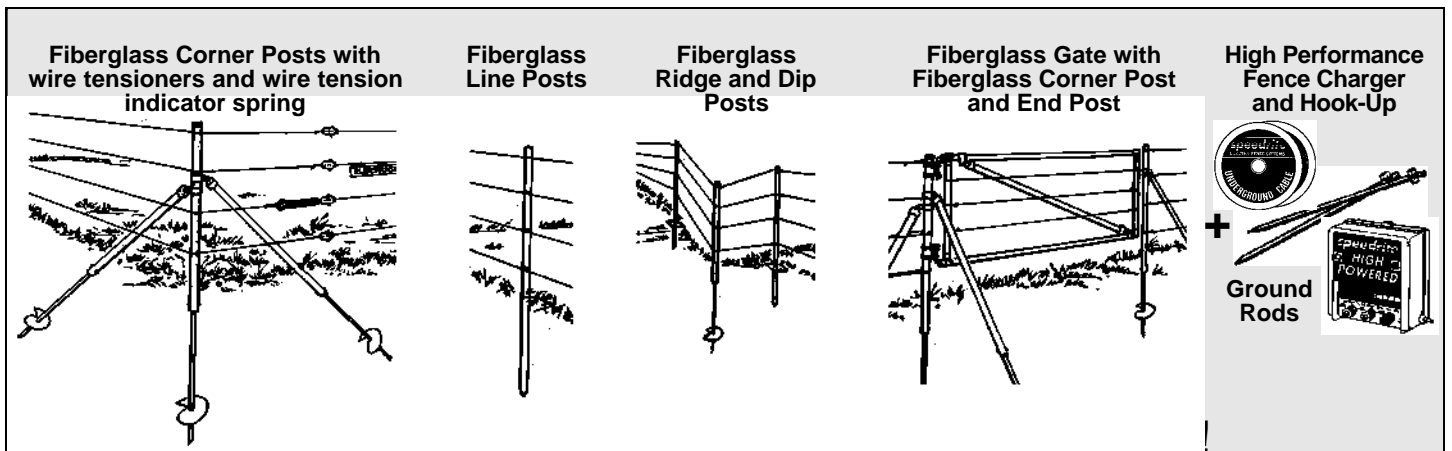
Zinc, 27  
Zinnias, 127

# FENCE PLANNER

## for the COMMON SENSE FENCE<sup>TM</sup>

Fencing technology in the U.S. has evolved from the first use of barbed wire in the late 1800's and woven wire soon after. This, along with steel and wood posts were the main means of animal control until electric fencing was introduced in the 1940's. Electric fencing was a wonderful invention in that it kept livestock both contained and away from the fence. Unfortunately, steel and wood posts continued to be used and insulators needed to be added. The cost of the insulator was always an important consideration and in an effort to keep insulators for farm fences affordable materials were chosen that typically had a short life span plus if dirt and moisture collected

on the surfaces, shorts occurred. Thus electric fencing was only used for temporary fencing. In another development in the 1970's, high-tensile wire was developed to get away from barbed wire. This wire needed to be installed close together and at high tension which required both extremely strong corners and line posts spaced close together, thus high cost. In the 1980's, the "COMMON SENSE FENCE" product line was introduced which combined the advantages of high tensile wire and electricity with "never to short out" Fiberglass Posts that could now be spaced at greater intervals. THIS IS THE PRODUCT WE ARE PRESENTING HERE.



***The easiest to install, safest, most dependable, longest lasting and most cost effective fence you can build, PERIOD!***

**TAKE TIME TO PLAN.** The installation of any fencing system begins long before the first post is driven or wire is strung. The secret of getting the most from each dollar spent on fencing is to take the time to thoroughly plan, and then construct carefully. Any time that may be saved by incomplete planning, construction shortcuts or poor safety practices will only reduce the efficiency and life of the fence and will ultimately cost much more than is saved. NO ONE is better suited to plan the "Common Sense Fence" and construct it than the person who will use it...you. You know which animals are to be controlled and the lay of the land.

**CHECK LOCAL LAWS AND ORDINANCES.** Laws governing placement of fences and electric fencing vary from county to county. It is important to understand what your local ordinances have to say about electric fencing BEFORE you start. Questions such as: "How far must a fence be from a roadway?", "Can electric

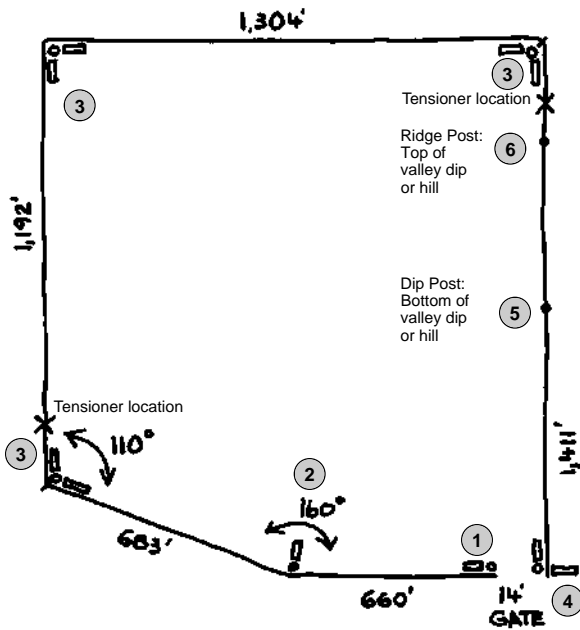
fencing be used in suburban areas?" and "Are warning signs required?" must be answered. If in a rural area, check with your County Extension Office and if in town, check with the City Clerk's Office.

**CHECK YOUR PROPERTY LINES.** The first step in planning any fence is to check your property survey. In rural areas, adjoining fences are generally built on the property line with each owner paying half the cost. Within city limits, fences must generally be entirely on your own property and you pay all the costs. Again, check your local laws.

**TALK WITH YOUR NEIGHBORS.** It is a good idea to talk over fencing plans with the neighbor whose property will be next to the fence. Your neighbors may have questions about the "Common Sense Fence".

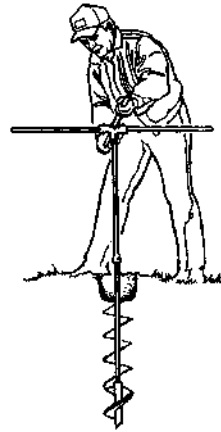
# A. Sketch a Map and Choose your End, Corner, Dip and Ridge Posts

Begin by drawing a map of your property including all major features such as: buildings, roads, fields, swamps, woods, hills, gullies, streams and other features that might require special consideration during construction. Be sure to include: power and telephone lines, gas and oil pipelines and underground cables.



## STEP 1.

Screw in anchors.

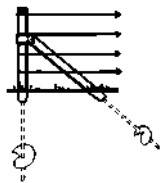


## STEP 2.

Secure fiberglass corner posts and braces to anchors.



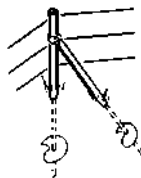
## 4, 5 & 6 FOOT HIGH MULE



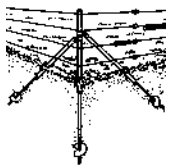
End Post - 1 Post, 1 brace and 2 augers to be used in two situations:

1. Where the fence will end and a gate will not be hung on that post.

2. For slight changes in wire direction and where a full corner is not required. Generally less than 60° and more than 120°.



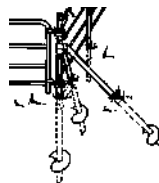
## Corner and Gate Posts - 1 Post, 2 Braces and 3 Augers



3. For all corners near 90° or

4. Where the fence will end and a gate will be hung on that post.

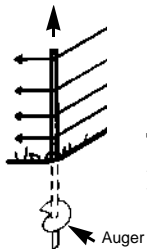
**Note: Be sure to measure gate opening correctly to allow for gate hinges and latch.**



## DIP AND RIDGE POSTS

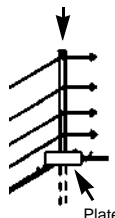
### 5. Dip Post

To be used where the ground rises causing a lot of upward pull on the post. Use at the bottom of a valley dip or hill.

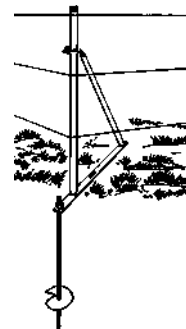


### 6. Ridge Post

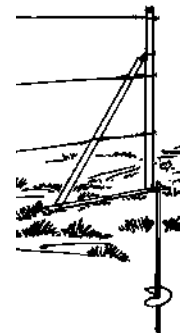
To be used where the ground slopes down and tension on the wires will want to force the post into the ground. Use at the top of a valley dip or hill.



## 3 FOOT HIGH MULE



Single brace can be used as an end or a corner.

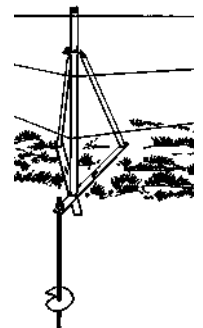


Install tool is built into bottom metal strap.



Double brace can be used for all ends and corners.

When pulling sideways on a gate post, you may prefer to use the double brace for more side stability.



## ANCHOR OPTIONS:

The 6" x 36" auger anchor is the standard and works in over 80 percent of the situations. However, for very hard, rocky ground, we have the 4" x 24" auger and for soft, deep sand, peat and swampy soils we have the 10" x 36" auger. In addition, 12" and 24" extensions are available to handle unexpected conditions that may require deeper penetration into the ground. We have not uncovered conditions to date that one of our Mule™ anchors can't handle. If one has solid rock, one can drill a 1¼" hole in the rock, insert the ¾" x 12"

extension, add grout, let it harden and install the corner system.



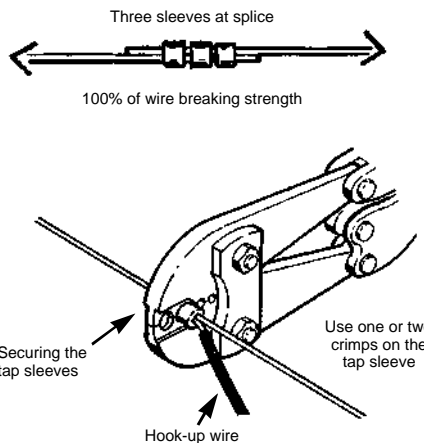
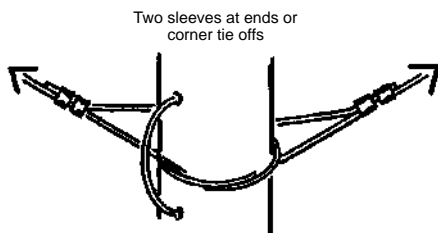
## B. Wire, Tensioners and Crimp Sleeves

12½ gauge, 200,000 min. psi, high tensile, class III galvanized steel wire should be used. Its strength and elasticity will assure you of a fence that lasts for years. Care must be taken when uncoiling high tensile wire as it acts like a coiled spring and can easily become entangled. A "spinning jenny", as shown in the photo should be used to hold the wire in place as it's being uncoiled. Install in-line wire tensioners and secure wire as shown in illustrations below. Secure just ONE wire prior to driving line posts in. This should be the second wire up from the ground. Tighten wire with in-line wire tensioners so it stays straight and provides a guide for installing the line posts.



### CRIMP SLEEVES

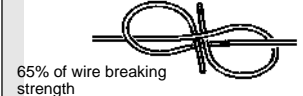
It is recommended that all wire connections be made using crimp splice sleeves and the special crimp tool. Use of the crimp sleeves will result in a splice equal to the strength of the wire.



12½ gauge high tensile wire can be tied off as illustrated below. However, it is difficult to do and one does not achieve a splice strength equal to the strength of the wire.

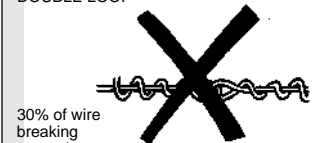
### SPLICE KNOTS

#### FIGURE EIGHT



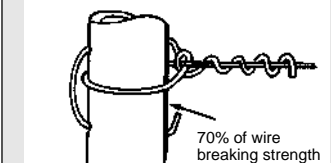
65% of wire breaking strength

#### DOUBLE LOOP



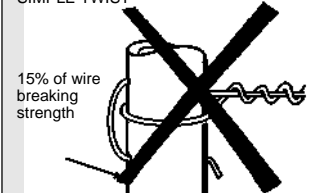
30% of wire breaking strength

#### THREADED THROUGH



70% of wire breaking strength

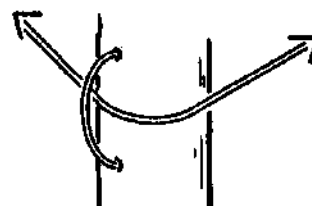
#### SIMPLE TWIST



15% of wire breaking strength

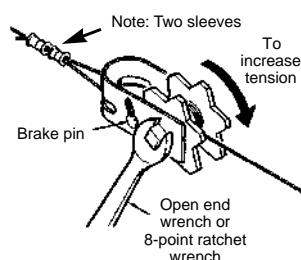
### IN-LINE WIRE TENSIONER

(X) shows location of wire tensioner	Maximum feet of wire per wire tensioner
<b>STRAIGHT LINE</b> 	5,000 ft. max. Additional wire tensioners per wire are required if braced ends are over 5,000 ft. apart.
<b>ONE CORNER</b> 	5,000 ft. max. each Use two wire tensioners for angles less than 45° (one on each straight line)
<b>TWO CORNERS</b> 	3,000 ft. max. You can pull around one corner in each direction.

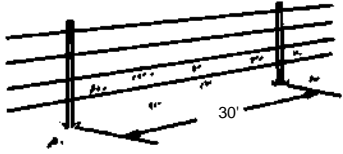


NOTE: Fence line wires may "flow" around corners allowing longer runs and the use of fewer tensioners. See chart.

### (X) WIRE TENSIONER



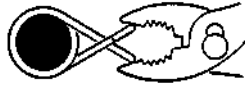
## C. Drive in Line Posts and Install Clips



Suggested spacing for line posts is 30 feet.

See pages 6 and 7 for suggested wire spacing.

### SECURE WIRE TO POSTS

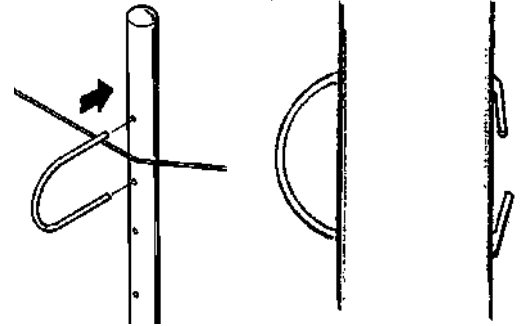


Squeeze hooks together. Slip clip onto post with longer hook down, release.



Pull wire up into bottom hook – rotate wire up and around until it is inside the upper hook. Release.

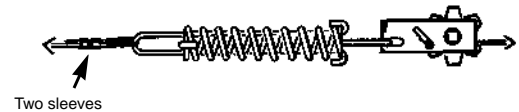
### WIRE U-CLIPS



Push u-clip through two holes and use hammer for 2" posts to bend wires and pliers for other posts.

## D. Tension Indicator Spring

Recommended wire tension is between 100 and 150 pounds for 12½ gauge wire. The springs are marked to show load. Generally, the wires need to be tightened so they do not have excessive sag and thus not likely to touch the wire above or below. Remember, ***ITS THE ELECTRICITY THAT IS CONTROLLING THE ANIMALS***, not the wire tension.



Two sleeves

## Gates

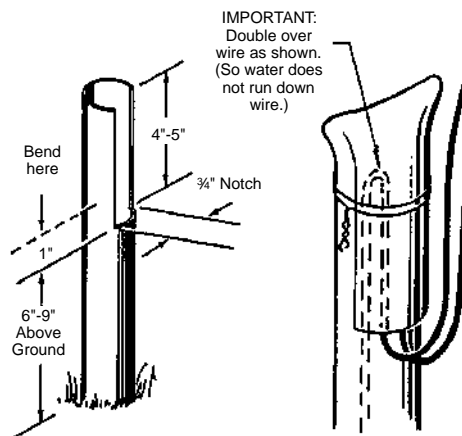
### POLYETHYLENE TUBING

The "Common Sense Fence"™ System uses insulated hook-up wire inserted through polyethylene tubing to conduct fence line current underground. Polyethylene tubing provides additional insulation from the soil as well as protecting the insulation from the soil as well as protecting the insulation on the wires. The use of overhead wires is not recommended. Transfer wires that run overhead (conventional electric fencing) from controllers to fence lines and across gateways, are "high targets" for lightning strikes or may be damaged by farm equipment.

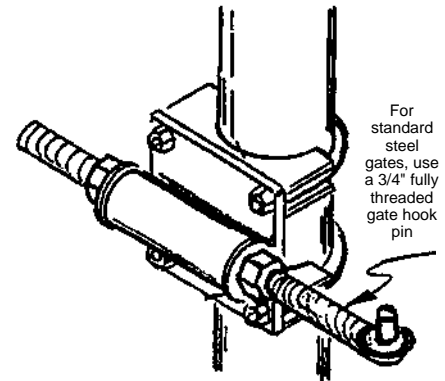
Underground use of insulated hook-up wire requires proper installation:

- Never have spliced insulated hook-up wires inside the polyethylene tubing.
- The ends of the polyethylene tubing must be made water resistant.
- Maximum distance recommended for underground wires is 200 feet. For longer distances, run a fence above the ground or install the controller closer to the fence. Spliced joints in the polyethylene tubing are not recommended.

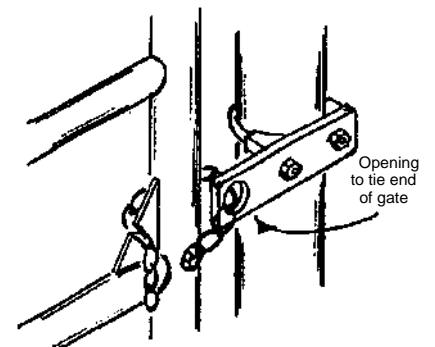
### WATER RESISTANT END FOR POLYETHYLENE TUBING



### GATE BRACKET AND GATE HOOK PIN

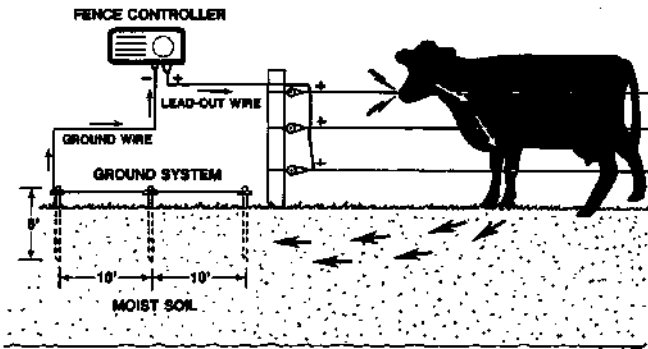


### GATE LATCH BRACKET



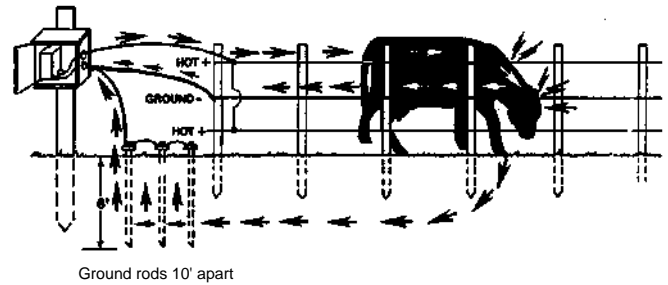
## E. Fence Controller and Ground System

### ALL HOT SYSTEM



In an all hot system, the animal receives a shock by touching a hot wire which transfers the electrical charge through the animal, through the earth to the ground rods and back to the controller which completes the circuit. **This system relies on good ground rods and moist, unfrozen earth conditions.**

### HOT/GROUND SYSTEM



In the hot/ground system, the animal can receive a shock the same as the All Hot System and also by touching a hot (+) and ground (-) wire at the same time to complete the circuit. **For best results in all soil conditions, use a hot/ground system.**

DO NOT install ground rods within 50 feet of a utility ground rod, buried telephone line, or buried water-line (they may pick up stray voltage).

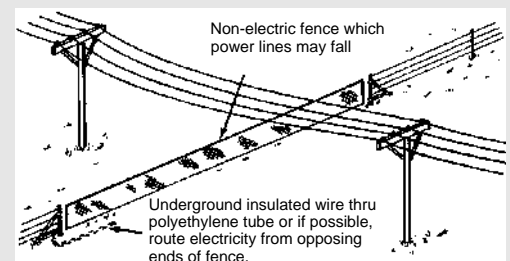
## WARNINGS

**SAFETY: Although modern fence controllers approved by recognized safety standard organizations pose no direct safety concern, indirect accidents can happen so it's important to be aware of the following WARNINGS before constructing your fence.**

- WARN ALL PERSONS, ESPECIALLY CHILDREN, ABOUT YOUR ELECTRIC FENCE AND SHOW THEM HOW TO DISCONNECT THE CONTROLLER IN CASE OF EMERGENCY. If you permit hunters or other visitors to use your land, be sure they have been warned and that all of your electric fences are marked.
- USE AMPLE WARNING SIGNS. This is especially true around buildings or locations where you expect people to be. Warning signs should be used every 300 feet or less. In some states warning signs are required by law.
- ONLY USE CONTROLLERS WHICH HAVE BEEN APPROVED BY NATIONALLY KNOWN AND RECOGNIZED SAFETY STANDARD ORGANIZATIONS.
- BEFORE THUNDER OR ELECTRICAL STORMS, IT IS BEST TO DISCONNECT A CONTROLLER FROM THE FENCE WIRES AND REMOVE THE PLUG FROM THE LINE OUTLET.
- DO NOT FENCE DURING ELECTRICAL STORMS.
- NEVER GRASP A SUSPECTED LIVE FENCE WIRE.
- DO NOT TAMPER WITH OR ATTEMPT TO REPAIR CONTROLLERS. Controllers must be sent back to the factory or an authorized service shop for repairs.
- DO NOT USE MORE THAN ONE CONTROLLER FOR THE SAME SECTION OF FENCE.
- ALWAYS DISCONNECT THE CONTROLLER BEFORE HANDLING FENCE WIRES.
- WHEN WORKING NEAR OR TESTING ELECTRIC FENCES, KEEP FEET AND HANDS DRY.



- DO NOT USE BARBED WIRE WITH ELECTRIC FENCING.
- DO NOT STRING ELECTRIC FENCE WIRES OVER OR CLOSE TO WATER TANKS OR ANY WATER THAT MIGHT BE USED FOR SWIMMING.
- DO NOT ERECT AN ELECTRIC FENCE UNDER OR NEAR OVERHEAD POWER LINES. Because electric fence lines are well insulated from the ground, fallen power lines can send lethal amounts of electrical power for much greater distances than can non-electric fences. Check with your local power authority so see if this is a potential problem. The following illustration shows one method of safely passing under a power line with an electric fence.
- BE SURE THAT YOUR ELECTRIC FENCE WIRES (both wire return and hot) DO NOT COME IN CONTACT WITH YOUR BUILDING.
- NEVER USE YOUR POWER LINE GROUND RODS OR YOUR PLUMBING SYSTEM AS A GROUND FOR YOUR ELECTRIC FENCE.
- KEEP GROUND RODS FOR THE ELECTRIC FENCE AT LEAST 20 FEET AWAY FROM ANY:
  - Utility company rods.
  - Telephone company ground rods.
  - Underground metal pipes
  - Metal supports for structures which lie upon, or have been driven into, the earth.





# Suggested Wire Spacings:

The designs shown are for general reference and may be modified for your own specific containment needs.

## 3 Foot High MULE

HORSES, CATTLE

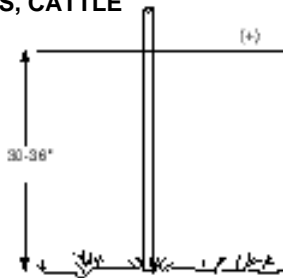


Figure 1

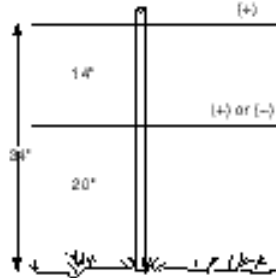


Figure 2

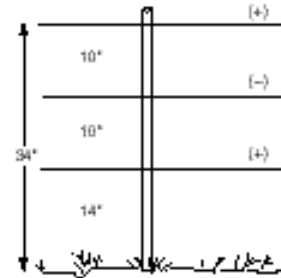


Figure 3

SHEEP, GOATS, HOGS

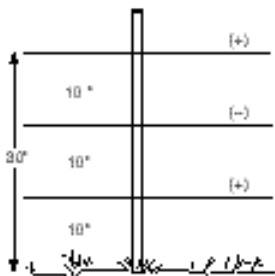


Figure 4

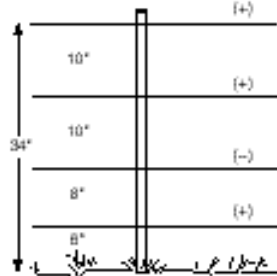


Figure 5

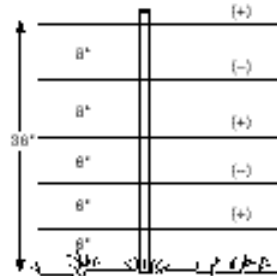


Figure 6

RABBITS, RACCOONS

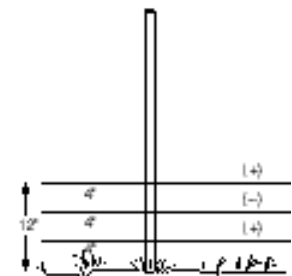


Figure 7

## 4 Foot High Heavy Duty MULE

HORSES, BEEF, DAIRY

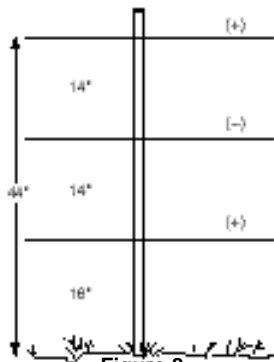


Figure 8

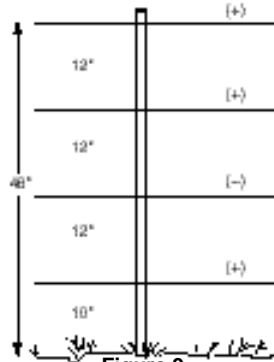


Figure 9

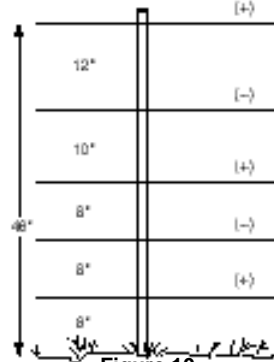


Figure 10

SHEEP, GOATS, HOGS

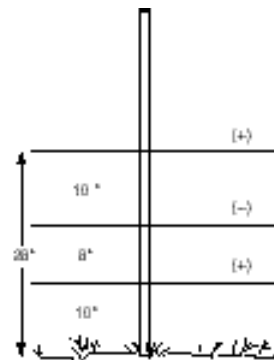


Figure 11

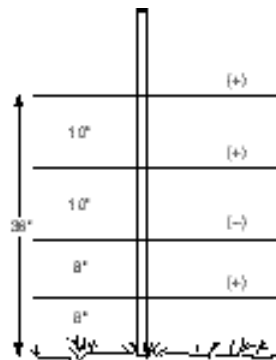


Figure 12

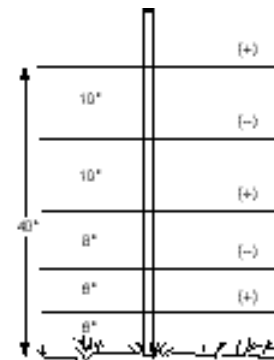


Figure 13

## 5 Foot High Heavy Duty MULE

BUFFALO, DEER, DAIRY, HORSES, BEEF, PREDATORS, LLAMA

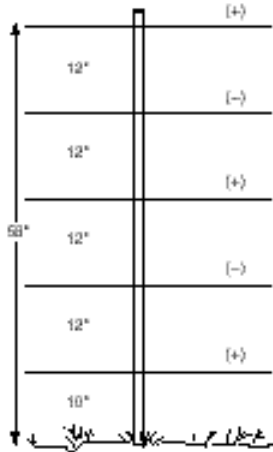


Figure 14

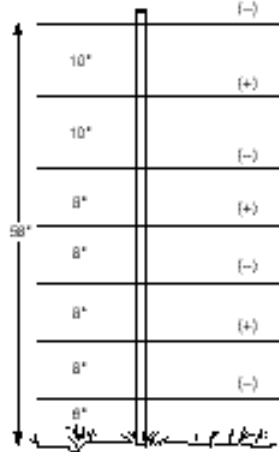


Figure 15

## PREDATOR CONTROL – COYOTES, DOGS, WOLVES, ETC.

Fencing requirements are generally greater for the control of wild animals. This is because of their more aggressive behavior towards fences and barriers. Just as with livestock, it is important to consider the physical and behavioral characteristics of the wild animals which you are going to control. Dogs and their relatives are of particular interest because they have no sweat glands. This greatly reduces the moisture on their skins, making electrical flow more difficult and thus a less effective shock. A fence for these predators must be high enough to keep them from jumping over, wire spacing close enough to keep them from squeezing through. The 9-wire general-purpose predator fence shown in Figure 17 forces the predator to climb the fence. This insures simultaneous contact by two or more of its padded paws between the (+) hot and the (-) wire return producing the most effective shock to control these predators.

## 6 Foot High Heavy Duty MULE

BUFFALO, DEER, PREDATORS, BEAR

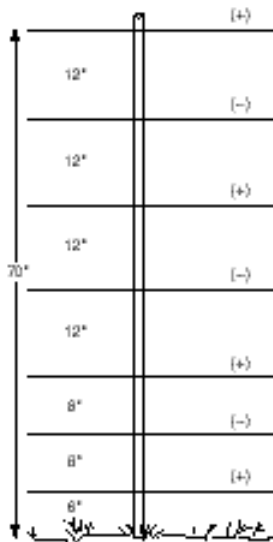


Figure 16

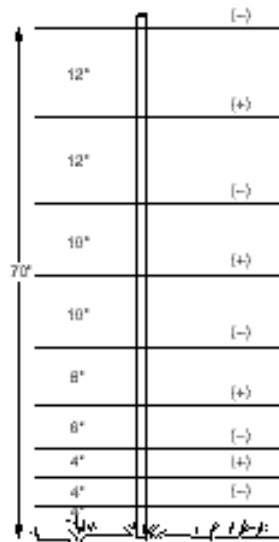


Figure 17

## 4 Foot High Electric Rail MULE

1 1/4" RAIL, 2" POST



Figure 18

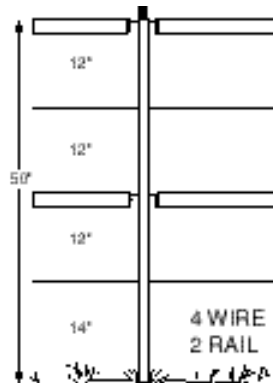


Figure 19

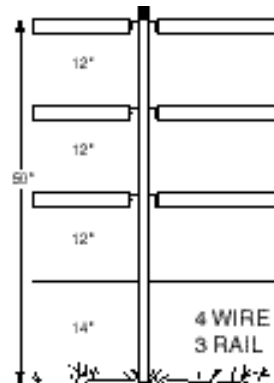


Figure 20

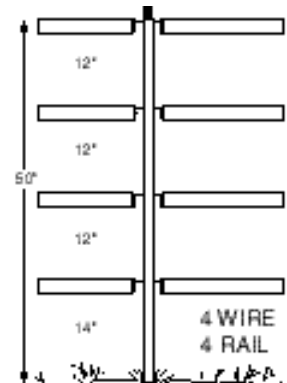
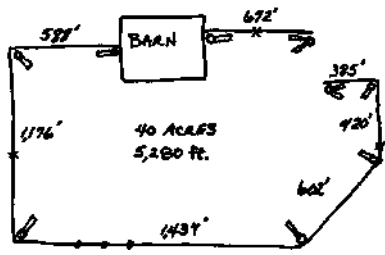


Figure 21

# 3 Foot High Fence

YOUR FENCE

SAMPLE FENCE

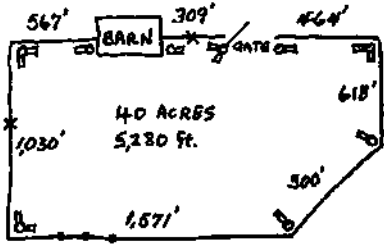


























ITEM NO.	ITEM DESCRIPTION	QUANTITY TO USE	QUANTITY SAMPLE JOB 2-Wire Fence 12 1/2 Ga.	QUANTITY YOUR JOB	PRICE EACH	TOTAL PRICE
<b>CORNERS AND ENDS</b>						
A2C	MULE, Double Brace	Can be used for every end, and every corner, and every gate.	2		\$49.00	
A2E	MULE, Single Brace	Can be used for every end, and every corner, and every change in direction. For some wire gate installations an A2C Double Brace may be desired to give more side stability.	7		\$35.00	
<b>DIP AND RIDGE POSTS</b>						
A1D48	Fiberglass Dip Post, 7/8" x 48" with Mule Anchor	Use at bottom of a valley, dip or hill	1		\$16.95	
A1R60	Fiberglass Ridge Post, 7/8" x 60" with plate and pin	Use at the top of a valley, dip or hill	2		\$6.95	
<b>1/2" LINE POSTS</b>						
A28	Fiberglass line post 1/2" x 48"	Divide total footage by 20 and round down.	176		\$1.45	
A38	1/2" Clips (20/pkg.)	Multiply the number of wires by the number of A28 Line Posts, divide by 20 and round up.	18		\$3.20	
<b>3/8" LINE POSTS</b>						
A33	Fiberglass line post 3/8" x 48"	Divide total footage by 20 and round down.			\$1.15	
A39	3/8" Clips (20/pkg.)	Multiply the number of wires by the number of A33 Line Posts and divide by 20 and round up.			\$3.00	
A39P	3/8" Plastic Clips (20/pkg.)	Multiply the number of wires by the number of A33 Line Posts and divide by 20 and round up.			\$2.95	
<b>STEP-IN POST</b>						
A33-SI-3	Fiberglass Step-in Line Post 3/8" x 48" with 3 Plastic Clips	Divide total footage by 20 and round down.			\$1.95	
<b>12-1/2 GAUGE WIRE</b>						
A43-2	Wire, 12 1/2 ga., 200,000+psi High-tensile (coil of 2,000 ft.)	Multiply the total footage of the fence by the number of wires, divide by 2,000 and round up.	6		\$29.95	
A44	Wire Tensioner	Use one per run of wire. Consult drawings/information.	6		\$2.25	
A46	Crimp Sleeve (25/pkg.)	6 per tensioner, and 6 per coil of wire for splices. Divide the total by 25 and round up.	2		\$4.25	
A56	Tap Sleeves (25/pkg.)	Use 1 sleeve per wire connection. On most fences is sufficient.	1		\$5.85	
<b>TOOLS FOR 12-1/2 GAUGE WIRE</b>						
A71	Spinning Jenny Tool	Used to uncoil the 12 1/2 ga. (A43-2) high tensile wire.	1		\$69.50	
A74	Crimp Tool	Used to crimp the splice and the tap sleeves.	1		\$49.50	
<b>WIRE AND TAPE</b>						
A42	Wire, 15 1/2 ga., 170,000psi High-tensile (coil of 2,640 ft.)	Multiply the total footage of the fence by the number of wires, divide by 2,640 and round up.			\$19.95	
A134	Polytape, White, 5-strand Woven 1/2" wide, (1,320 ft.)	Multiply the total footage of the fence by the number of wires then divide by 1,320 and round up.			\$47.95	
A136	Polywire, White, 6-strand Woven (1,620 ft.)	Multiply the total footage of the fence by the number of wires then divide by 1,620 and round up.			\$36.75	
<b>CHARGER</b>						
A118	Electric Fence Charger Speedrite SM-1200	Battery, Solar and other size Chargers also available.	1		\$130.00	
A55	Ground Rod with clamp	The number of Ground Rods used depends on the type of soil and size of Fence Charger. Generally never less than 2 for the fence and 2 for the Lightning Arrestor.	4		\$13.00	
A131	Lightning Arrestor	Minimum of one per electric fence charger	1		\$8.95	
A131-S	110V Surge Protector	One per electric fence charger	1		\$9.95	
A57-50	Insulated hook-up wire, (165 ft. roll)	Add the length of all gates. Multiply by the number of wires, then by 2, and then add 2 times the distance from the fence charger to the fence. Divide the total by 165 ft. and round up.	1		\$29.95	
A62	ELECTRIC FENCE Electric Fence Warning Sign	Some states require 1 Electric Fence Warning sign every 300 ft. You may want to check with your county or city officials.	6		\$1.30	
<b>OTHER ITEMS</b>						
						<b>TOTAL PRICE</b>

# 4 Foot High Fence

YOUR FENCE

SAMPLE FENCE



ITEM NO.	ITEM DESCRIPTION	QUANTITY TO USE	QUANTITY SAMPLE JOB 4-Wire Fence	QUANTITY YOUR JOB	PRICE EACH	TOTAL PRICE
<b>CORNERS AND ENDS</b>						
A4C	 MULE Corner	Count every gate post and every 90 degree corner.	4		\$109.95	
A4E	 MULE End	Use wherever the fence changes direction or stops and an A4C Mule Corner is not used.	5		\$74.95	
AH43	 Fiberglass Horizontal Brace	When using 5 or more wires, use two with each A4C Mule Corner and one with each A4E Mule End.	0		\$5.95	
<b>DIP AND RIDGE POSTS</b>						
A1D54	 Fiberglass Dip Post, 7/8" x 54" with Mule Anchor	Use at bottom of a valley, dip or hill	1		\$22.95	
A1R72	 Fiberglass Ridge Post, 7/8" x 72" with plate and pin.	Use at the top of a valley, dip or hill	2		\$7.95	
<b>LINE POSTS</b>						
A24	 Fiberglass line post 1 1/16"x72"	Divide total footage by 30 and round down.	176		\$4.20	
A37	 1 1/16" Clips (20/pkg.)	Multiply the number of wires by the number of line posts, divide by 20 and round up.	36		\$4.70	
<b>WIRE</b>						
A43-2	 Wire, 12 1/2 ga., 200,000+psi High-tensile coil of 2,000 ft.	Multiply the total footage of the fence by the number of wires, divide by 2,000 and round up.	11		\$29.95	
A44	 Wire Tensioner	Use one per run of wire. Consult drawings/information.	12		\$2.25	
A45	 Wire Tensioner Indicator Spring	Optional. Use 1 per set of tensioners to set tension at 150-200 lbs. per wire. Set other wires by feel.	3		\$5.50	
A46	 Crimp Sleeve (25/pkg.)	6 per tensioner, and 6 per coil of wire for splices. Divide the total by 25 and round up.	6		\$4.25	
<b>FIBERGLASS GATES</b>						
AG12	 Fiberglass Gate, 42" x 12'	Fiberglass Gates 4, 6, 8, 10 and 12 ft. lengths	1		\$150.00	
A65	 Gate Bracket, pair for 3/4" gate bolt	One A65 per gate	1		\$20.95	
A67	 Gate Latch	One A67 per gate	1		\$6.50	
<b>CHARGER</b>						
A119	 Electric Fence Charger Speedrite SM-2400	Battery, Solar and other size Chargers also available	1		\$178.00	
A55	 Ground Rod with clamp	The number of Ground Rods used depends on the type of soil and size of Fence Charger. Generally never less than 2 for the fence and 2 for the Lightening Arrestor.	4		\$13.00	
A131	 Lightening Arrestor	Minimum of one per electric fence charger	1		\$8.95	
A131-S	 110V Surge Protector	One per electric fence charger	1		\$9.95	
A57-50	 Insulated hook-up wire, (165 ft. roll)	Add the length of all gates. Multiply by the number of wires, then by 2, and then add 2 times the distance from the fence charger to the fence. Divide the total by 165 ft. and round up.	1		\$29.95	
A56	 Tap Sleeves (25/pkg.)	1 sleeve per hook-up connection. 1 pkg. is usually enough.	1		\$5.85	
A62	 <b>ELECTRIC FENCE</b> Electric Fence Warning Sign	Some states require 1 Electric Fence Warning sign every 300 ft. You may want to check with your county or city officials.	6		\$1.30	
<b>TOOLS</b>						
A1TL	 Tool, MULE screw-in anchor, Handle and 2 ft. extension	Used to install the MULE screw-in auger anchors and save it to remove the anchors if you ever decide to move the fence.	1		\$29.95	
A71	 Spinning Jenny Tool	Used to uncoil the high-tensile wire	1		\$69.50	
A74	 Crimp Tool	Used to crimp the splice and the tap sleeves.	1		\$49.50	
<b>OTHER ITEMS</b>						
					<b>TOTAL PRICE</b>	







# Embedded Secure Document

The file *file:///E:/PROPHECYKEEPERS/data/POST-NUCLEAR-WAR/b\_recovery/2\_farm\_recovery/ftpfiles/oilseed.pdf* is a secure document that has been embedded in this document. Double click the pushpin to view.





# Alternate Energy

## Table of Contents:

### [Overview: On Alternate Energy.](#)

The problems of producing your own.

### [Electricity: Make your own](#)

We have built many of our own generators. Here we tell you how to do it - using wind, water, bicycles and other means.

### [Bikes: Not just for riding](#)

Bikes are a very much overlooked energy source. They can be used to operate all sorts of machines and they can be used to generate electricity.

### [Smokemobile: Woodgas](#)

Detailed plans for running your tractor, truck, car or bus on wood. This is a tried and proven method used in Europe during the Second World War when there was a gasoline shortage. Much improved design since then. [There is also a copy of the old method available in .pdf](#)  
(for which you need a pdf reader)

### [Biofuel: Grow it on the farm](#)

Biofuels are used as a substitute for diesel. They can be grown and processed on the farm. They do not require a still.

### [Stills: Make your own fuel from potatoes, corn, etc.](#)

These are a bit trickier and at the present generally illegal, or at the very minimum you can get into a lot of legal hassle.

### [Solar: Using the sun for energy.](#)

While it is impractical to home build solar cells for generating electricity, solar is great for cooking and

other applications like heating water.

Click here to return to the  
[Individual Agricultural Recovery  
After Nuclear Holocaust](#)

---

## The Problem of Producing Your Own

There are many problems in developing and installing independent power systems. For one thing the government is not helpful. To say the least. It is not just our project that finds these hurdles but many others have been stopped also. In the second previous century our local water courses were used for power but in the last hundred years everything possible has been done to prevent their use, including dynamiting what was the main local power producing dam. The government centralized production for economies of scale and did not want competition. Then during the depression when costs were such that the farmers could not afford the electricity from the monopoly the farmers again started a generator at the dam and this is when the system was taken back over by the government and the dam dynamited.

With all the surplus rotting potatoes in the area we might also make a still and produce fuel for our diesel generators. But, presently, there is a \$100,000 annual fine for doing so. We will simply have to wait for a more propitious time.

Click here to return to the  
[Table of Contents](#)

**MENU: [HOME](#) » [Reconstruction](#) » [Recovery](#) » [Renewal](#) » [Energy Types](#)**

---

---

# Electricity

## Make Your Own

### Table of Contents:

#### [Overview: On Making Your Own Electricity.](#)

An overview of the efficiency of different methods of electrical energy generation and the key to comprehending just how much power you are making.

#### [Bike: Pedal Power](#)

DON'T plan to hook it up to a car generator. You just can't pedal fast enough. Here are several designs. We have built ten pedal power generators for use in the Ark Two shelter. You will see a picture of me actually pedaling one of them and lighting ten 12v florescent trouble lights. Nice trick. Good for exercise. But worse than the old galley ship oars for effort. And I don't know where you are going to get that many slaves. Still there are some applications for bike generators and key to their success are the low RPM generators that I discuss next.

#### [Low RPM: How to make low RPM generators!](#)

The difficulty with most generators is that you have to turn them too fast before they start generating power. These generators are neat because they put out power at low rpm and so will work with a bicycle, a low head water source, or lower wind power.

#### [Lawnmower: Turn your lawnmower into a generator](#)

Yep, turn your old gas lawnmower into a generator. This is also where you can use a car generator / alternator. Now if you can just find some gasoline to run the lawnmower.

#### [Wind: If you have a good windy location.](#)

We have built eight of these wind powered electrical generators. In fact at this writing we are still making the blades. Can't put them up, however, because the neighbors think the sound of the wind on the blades might be too noisy. Have gone to lots of other sites and looked at ones that others have built.

#### [Waterpower: You should be so lucky](#)

Same problem with waterpower today. We have designed systems for our two generation sites and would like to put them in the water - but the government won't let us. It is not just us - lots of people presently run into that problem, but anyway you can look at our system and we will discuss some aspects of water power. We are very fortunate to have two good water sources and although we can't use them today - things may be different when the time comes.

### **Motors: Running it backwards**

Surprise! Surprise! Yep motors take electricity to run - BUT if you run them BACKWARDS, they put out electricity. The trick is to find something that will run them backwards. Wind or water can do it- for example.

### **Diesel: Lets not forget the big guys.**

Probably the best we have got - if we can keep them running for parts and such - and can get or make fuel for them.

### **Batteries: Saving energy for future use.**

Usually a key component with alternative energy systems is battery storage. Because the alternative energy systems often do not generate high volume it is usually essential to store energy generated during low usage periods for use during high usage periods.

---

## Overview Making Your Own Electricity The Relative Efficiency of Methods

### What Watts?

One measure that you want to have clearly in your mind when you start considering electrical generating systems is that of watts. Just take a few minutes to this through if it is not something with which you are already familiar.

It is easiest to think in terms of light bulbs. A one hundred watt light bulb uses uses 100 watts of electricity per hour. A thousand watt generator would puts out a thousand watts in an hour and would therefore light 10 of these light bulbs. A four thousand (which is to say a 4K) generator would light 40 of them. Keep that in mind as you read through the following descriptions.

### Alternative Sources of Electricity

There are numbers of ways of building your own electrical generators.

Let me explain briefly my concepts about power generation, in order of efficiency.

- a. The most efficient way to get electric power, is to buy it from the power company. Economies of scale make them by far the lowest cost source. The only reasons to have your own power generation are (1) you are too far from the grid (2) you need a back-up in case the grid is down (3) you are very dedicated to some other purpose such as survival, conservation, or innovation. These latter are definitely going to cost you money.
- b. The second most efficient way to get electric power, for most people, will likely be to have a diesel or gasoline generator. A diesel combined with a battery storage unit can be relatively efficient in providing reliable power but it takes considerably more commitment than simply paying a bill to the electric company each month. The cost of putting in a substantial system for full off grid use will run between 20K and 40K. We have two diesel generators at the Ark. One is a 75KW and the other a 25KW. With the cost of diesel fuel and maintenace it costs about ten times as much to generate power with them as to buy it from the power company. Still they are main emergency mainstay. The 75KW will light about 750 (100 watt) light bulbs. Do the math. 75KW means 75,000 watts which divided by 100 watts per bulb gives us 750 bulbs which can be lit. In practice, we of course do lots of other things other than light bulbs. We run water and sewage pumps, big air fans, stoves and microwaves, and charge batteries, whenever we are running it.
- c. The third most efficient way is with water power. In fact this might be the preferred way but most people will not have an adequate water source. The operative words are HEAD and FLOW. Head is the height that the water falls from and 100 feet is considered reasonable. The higher the better. Flow, the amount of water, is the other factor. Low head systems have been problematical but some people feel they have found a solution. I am no exception. I think the solution is low RPM (Revolutions Per Minute) generators with nozzles on the driving waterwheel to efficiently direct the water force. Unfortunately, the government won't let me try out my theory - but I have everything together ready to try when circumstances change. A useful system for complete household use is probably going to cost over 40K to install. A system on our big falls might produce 40KW and this would be 24 hours per day - without any additional cost of fuel. So yes, because we have such an excellent water source, it would pay for itself. However, when you add in the cost of trying to battle the government to put it in - then it becomes useless.
- d. The fourth most efficient way to generate electricity is with wind. Wind is much less efficient than water because in most places it does not blow that constantly. Our little wind generators will produce about 400+ watts each (think in terms of four 100 watt bulbs) and since I am planning to put up 8 of them I will get in the neighborhood of what we would get from our one little 5KW gasoline generator. Most people would not have room for such a windmill farm such as we do, and fortuitously located on the highest hill around. Still the installation of the eight windmills will be around 15K to 20K. You can buy a good 5KW generator for one tenth the price - so you can see what I mean by putting this down as the

fourth most (actually less) efficient way of generating electricity. But if the power company isn't working and you can't get gasoline then this may be the way to go.

e. The fifth most efficient way is with solar cells. This technology has come a long, long way in the last few years but still remains so inefficient that it would take over 100 years for a system to pay for itself, and in fact it undoubtedly never would if you included what the investment would earn elsewhere in interest and take into consideration that the system will physically depreciate before that length of time. One great draw back to solar cells is that the sun only shines half the day, and because of annual position of the earth and blockage by clouds, in many places your are lucky to get power 20% of the time. Unless you are out in space with sunlight 24/7 or have some very low power need at a remote location - forget it.

f. There are a great many other ways to generate electricity. Waves, thermal heat, animal power (the bicycles), chemical methods, nuclear, hydrogen generators, steam boilers, a great variety of fuels and so on and on. But none of these, and most of the above, are not practical for most individuals. Completely forget the many cons that are going around about getting free electricity from machines being suppressed by the oil companies, the government, and giant corporations. I have looked into these extensively for many years - and there is nothing to them as great as the stories sound. If there were a cheaper way to generate electricity the Japanese or the Russians or the Chinese would do it and no US companies would be able to stop them. Engineers in other countries are not dummies and would greatly love to have the electrical power in order to keep up with American productivity.

Click here to return to the  
[Table of Contents](#)

**MENU: [HOME](#) » [Reconstruction](#) » [Recovery](#) » [Renewal](#) » [Energy Types](#)**

---

---

# Low RPM Generators

This is the main page on this site regarding the construction of generators. While many of the examples are regarding wind driven generators, the principles regarding the generators themselves apply equally to other motive sources. Anyone contemplating building a low rpm generator should look through all the sources on this page. Those persons specifically building a wind generator should also look at our "WIND" page which has on it many things specific to wind generators such as towers, blades, tails and testing them.

## Comparison of Generators and Alternators

Most generators and alternators (like off of a car) need to revolve at around 1800 rpm (that is they have to make 1800 revolutions per minute in order to generate power) and it is often difficult to get a third of that speed with most homemade wind, water or other sources.

[Overview: Comparison of Alternators and Generators](#)

[SEALED: Comparison of Alternators and Generators](#)

This is the SEALED mirrored version of this site that won't be opened until after The Great Catastrophe.

## Low RPM Generators and Alternators

Since the difficulty with most generators is that you have to turn them too fast before they start generating power these low RPM ones are neat because they put out power at low rpm and so will work with a bicycle, a low head water source, or lower wind power.

The low RPM generators will start generating power at around 100 rpm and remain efficient up to about 600 rpm. Their "sweet spot" is often around 400 rpm but it will vary from generator to generator.

[SEALED: Wooden Low RPM Alternators](#) (SEALED)

This is a SEALED mirrored site that won't be opened until after The Great Catastrophe. This and the link following give more information about building wooden generators. Much of the information is available through the open links.

[SEALED: Alternator from Scratch](#) (SEALED)

This is a SEALED mirrored site that won't be opened until after The Great Catastrophe. The reason that they are mirrored here is that hopefully this way the information will be available later - even if the open links no longer are. Special plans are being made to protect to protect these pages and to distribute them afterwards.

## **Brakedrum Generators and Alternators**

**[Brakedrum: Use the brakedrum off an old pickup truck to make a low RPM generator!](#)**

Although the literature says these brakedrum generators are easy to make, we made ten of them and found it a considerable challenge. Nevertheless, they all worked reliably and are very durable.

**[SEALED: brakedrum\\_update](#)**

This is the SEALED mirrored version of this site that won't be opened until after The Great Catastrophe.

## **Front Disk Generators and Alternators**

There seems to be a trend away from brakedrums to disks. Talking with Hugh Piggot, he tells me that he is writing a new book on this subject.

**[Disk 1: Forcefield Low RPM Disk Alternator](#)**

**[SEALED: Forcefield Low RPM Disk Alternator](#)**

This is the SEALED mirrored version of this site that won't be opened until after The Great Catastrophe.

**[Disk 2: Making a Volvo Front Brake Disk into a Generator](#)**

More details from the same source - on the same idea.

**[SEALED: Making a Volvo Front Brake Disk into a Generator](#)**

This is the SEALED mirrored version of this site that won't be opened until after The Great Catastrophe.

## **Wooden Generators and Alternators**

Some wind generator designs can be put together very quickly. You can carve less elegant blade designs in an hour or two. Some motors can be used as generators. People have gone out and stuck their wind



generators up on top of a hydro pole that is not being used. Hopefully the need is only temporary anyhow, until a more permanent source of electricity is re-established.

These may not produce so much electricity as a metal based generator and may be not as durable but they may be more accessible for one of the main components.

### [Simplest: Wood Axe](#)

This one is particularly fast to build. Even if you don't build it you should study this one because the pictures and explanation by Force Field are so excellent.

### [SEALED: Wood Axe](#) (SEALED)

This is this SEALED mirrored site that won't be opened until after The Great Catastrophe. This and the two sealed links following give more information about building wooden generators. Much of the information is available through other open links.

### [SEALED: Homebrew Windgenerator](#) (SEALED)

This is a SEALED mirrored site that won't be opened until after The Great Catastrophe. Much of the information is available through other open links.

### [Wooden 2: all the plans and information for another wooden one](#)

BUT these are 9 pages of plans mirrored in .pdf format from Home Power Issue #88 are ones that you can download and print off NOW.

### [Wooden 3: A key set of plans to study](#)

These are 49 mirrored pages of plans in .pdf format are ones that you can download and print off NOW. While you may not build this unit - you should definitely study these plans from Hugh Piggot because they give you details on many subjects such as how to build a coiler, the winding of a coil and how to wire the coils together.

### [SEALED: Additional Info on Coils](#) (SEALED)

This is a SEALED mirrored site that won't be opened until after The Great Catastrophe. Much of the information is available through other open links.

*On-line Info:* [Lots of info on build it yourself windmills](#)

This is a link to Hugh Piggot's website. Hugh lives in Scotland. This is probably the world's most authoritative source for build it yourself windmills. For those who look into it ahead of time they can get Hugh's book. We also have a .pdf file from Hugh (available on our low rpm generators page) - that gives LOTS of details.

*On-line Info:* [North American Source for Hugh's info.](#)

This is a link to Bob Budd's website. Bob has built lots of Hugh Piggot's brakedrum windmills, and he has put out a superb video on how to do it. I have watched the video many, many times with many people and have talked with Bob tens of times, and have gone to visit him and see his windmills in the process of our building ten generators ourselves.

### **Other Generators and Alternators**

*Microwave Oven:* [Making a Microwave Oven into a Generator](#)

This is a particularly neat idea and there are lots of neat ideas at the Windstuff Now site.

*SEALED:* [Making a Microwave Oven into a Generator](#)

This is the SEALED mirrored version of this site that won't be opened until after The Great Catastrophe.

### **Testing**

*Experiment:* [Testing your theories](#)

Here are some experiments done by another individual developing a low rpm generator. It is an example of the kind of approach that you may wish to take.

*Sealed:* [Testing your theories](#)

Same as above but sealed until after the Holocaust.

**MENU:** [HOME](#) » [Reconstruction](#) » [Recovery](#) » [Renewal](#) » [Energy Types](#)



# Discover How To Easily Build a Portable Low Budget Power Generator

**" Using an old Lawn Mower and materials you can pick up locally and cheap"**

*This is from another webpage which says that it is copyrighted but the links to Gemini didn't work and I will be happy to link them if I can find the source but a search on the Internet didn't turn it up.*

Here's an easy and inexpensive way to build your own personal power generator. It's a handy little back up system to protect your family from black outs, storms, Y2K, etc. Or, maybe you simply want to get away from it all for a while. It's always nice to know that you can produce your own power whenever and wherever you are.

The following is a step by step tutorial. It shows you the parts you will need, the cost and the best places to get them. We then assemble the whole unit and wire it up, yes, we even include the wiring diagrams. The nice part about this unit is that the generator is built right into the lawn mower deck. You can even strap 2 or 3 batteries on the deck and steer the whole thing wherever you want to go.

Aside from showing you how to build the "Low Budget Power Generator", we are also going to show you how to easily expand your system by using a couple of extra items that will let you maximize your power producing potential. We kept the explanations as clear as possible so that you can keep your time and labor to a minimum. Quite frankly, we wanted to have some fun putting these systems together and hopefully you will too.



We'll be the first ones to admit, these homemade units do have their limitations and they aren't pretty, but they are practical. If you want pretty, go out and spend a pile of your hard earned money on a generator. If you can find one.

We have come up with 4 different ways to build these homemade

generators depending on your preference of items, or the availability of parts in your area. We will use the complete lawn mower version for this tutorial.

First off let's discuss using the vertical shaft lawn mower engine, complete with the mower deck, handle and the works. It's a great idea to build this generator on its own mower deck because you then have an instant transportation system built in. We'll also show you a neat little device you can use to help your generator operate under heavy loads a lot smoother. Mount this on the handle next to your throttle and you will have full control of your generator right at your finger tips.

---

## The Basic Parts You Will Need

### The Motor



To drive our project we are going to use what is probably the most common lawn mower engine around, the Briggs & Stratton vertical shaft four-stroke gas engine, in the 3 to 3.5 horsepower range. You will have to remove the cutting blade and replace it with a drive pulley. It's important that the motor shaft extend at least 1 ¼" out of the bottom of the motor, as you will want your pulley to clear any obstacles like the motor mounting bolts.

Take a good look at the motor shaft, in most cases you have a 9/16" mounting bolt holding the cutting blade to a hub that's attached to the end of the motor shaft. The hub has a 3/16" key built in it to match the slot on the motor shaft, which is normally 7/8" in diameter. Make sure the motor shaft is keyed so that your pulley can be fastened securely. This will be the easiest set up you can find. If you run into a motor with a shaft that has only a threaded end and no key way, then walk away from this type of set up as it's way to much work and aggravation to attach a pulley to this type of shaft.

## The Alternator

Automotive alternators are little power producing jewels that will be the heart of our systems. When driven by a lawn mower engine, we can produce a steady supply of quick, cheap and reliable power whenever we want. You can purchase alternators from Auto wreckers rebuilt or as is with a warranty for about \$ 25.

While shopping around for all the different makes of alternators, Ford, Chrysler etc. We found the GM alternator the most favorable for our systems. There are two types of GM alternators, one with a built in voltage regulator and the other with an external voltage regulator. **Use only a GM style alternator with a Built in Voltage Regulator**, as they are easier to wire up and work with. We had three main goals in mind when we built our generators. Build em' cheap, safe and simple.





We built our projects using two different alternators with a 40 and 65 amp output. You may also run into different size casings of GM alternators, we stuck with the most common sized casing which measures slightly over 6 ½ " at the mounting hole openings. Your alternator should come with a two-wire molded connector/harness that plugs into the casing. You need this connector to hook up your alternator properly later on. Make sure you have it when you purchase or salvage your alternator. If not, you can pick one up at an automotive supply shop for a couple of dollars (more on this later).

## The Power Inverter



The inverter is an electronic device that converts low voltage DC (direct current) electricity from a power source into a standard 120 volt AC (alternating current) that we use in our homes. The power generated from our alternator is a low voltage DC usually around 14 volts. In order to maximize our power capabilities we are going to add an inverter to the system. Inverters are sized by the amount of wattage they can output.

In the case of an emergency you will no doubt want to power some 120volt AC devices in and around your home. You will need to decide what you think is absolutely necessary to run during a power interruption and then calculate how much wattage (power) each device consumes.

You can do this by finding the manufactures rating plate on the appliance you wish to operate. Take the amperage rating of the device and multiply this by the household voltage. Example: An appliance drawing 5 amps of current multiplied by the household voltage. (5 amps x 120 volts = 600 watts). Inverters start as small as 50 watts, and an average household would use an inverter anywhere between 2500 to 4000 watts for "normal everyday operation". Their price tags start at about \$40 to approximately \$1000 to \$2000 for the average home. So the choice is up to you as to which size inverter is right for you. Just remember, your planning for an emergency. If you use good power management you can keep your power consumption to lower levels.

## Batteries

When we plan for emergencies, we normally store food, water and extra supplies.....why not power? With your home built systems you have the better of both worlds. You can use the generator to charge a battery or bank of batteries then switch over to directly powering a DC to AC inverter for 120 volt purposes. Then you can use your batteries to power up a selection of 12 volt lights and gadgets. You did buy some 12 volt back up lights didn't you? Or you can reverse the process and run your power inverter off the batteries, the choice is yours.



In an emergency you have a readily available supply of batteries around the house to store power. They can be found in your automobile, your motor boat, your spouse's car, your neighbor's, even your mother in law's car. All can be charged quickly and cheaply with your generator.

## The Lawn Mower Deck



Here are a few tips for selecting a desirable lawn mower that will keep your time and labor to a minimum. The simpler the design of the lawn mower the better. You will need to bolt a set of mounting brackets and an alternator to the back of the deck, so choose one that is as flat as possible. We are also going to cut a slot in the



backside of the deck so make sure this part is as flat up and down as possible too. Now take a look underneath. Some mowers have a shroud circling the cutting blade, try to avoid this on the rear side of the mower deck, as we want to keep our cutting to a minimum. And make sure your deck is made of metal, stay away from the plastic ones.

## Motor Pulleys





We have used two different styles of pulley's, aluminum and cast iron. A strange thing happens when you remove the cutting blade and hub off your lawn mower engine..... It will not start! The flywheel on your motor is most likely made of lightweight aluminum and it needs the extra weight and momentum of the cutting blade assembly to rotate it through a complete revolution. A flywheel's main purpose is to store energy so it can carry the crankshaft through the 3 non-power strokes of a 4-stroke engine. So, the flywheel must shoulder the burden of the rotation for 75 % of the time. If you take away some of it's mass on the motor shaft, it will not run smoothly, heck, it won't even start. So if you have a lightweight flywheel you're going to need a pulley with some weight on it.

So, how do you tell if you have a cast iron or a lighter aluminum flywheel? Take your blade and hub assembly off your motor shaft and start pulling the cord. If after 4 hour's you haven't started the engine, well.... it's a pretty good bet that your flywheel is aluminum and you will have to use a heavier cast iron pulley. Or you can remove the top motor shroud that reveals the flywheel area, put a magnet near the flywheel fins. If the magnet doesn't stick, it's aluminum, if it does stick then you have a heavy cast iron flywheel and you can get away with using an aluminum pulley.



Our motor shaft was 7/8 " in diameter. It seems that as soon as you look for a pulley with a bore bigger than 3/4 ", they are very difficult to find in the normal "Retail" stores. So we went to a bearing and transmission shop to buy our pulleys. We found aluminum pulleys gave good service but they didn't stand up to the long hours and wear and tear, as did the cast iron pulleys. So we opted for a cast iron pulley from a company called TB Woods. It uses a system with two parts, an inner bushing and a main pulley. The inner bushing has a split in it. When you tighten these two items together with the mounting bolts supplied, the split bushing closes onto the shaft with a tremendous grip. The pulley was also keyed, so once it's installed, it stays put. We used 1/2" wide pulleys on all our projects, with diameters ranging between 3" and 6". We'll discuss the proper pulley diameters later on.

## Belts

We stuck with half-inch wide belts to simplify things. We also found out that not all belts are the same. Our alternator is designed to work best with an automotive type belt and our motor pulleys were designed to work best with utility/industrial belts. So, what's a fellow to do?

An automotive belt has a sharper angle or "pitch" on the side of its surface, so it will ride deeper in the motor pulleys. And if you are using a cheap pulley, it will start wearing a groove in the side of the pulley.

The better choice is the industrial belts, but we have differences here too. The half-inch industrial belt is covered by two different styles, the "L" series and the "A" series. The "L" series belt is designed for fractional horsepower applications....light duty. On the other hand the "A" series belt was designed for full horsepower applications, heavy duty. It has more polyester cords built into it for more strength and durability.

We tried all 3 different types of belts and they all worked fine. For short-term use you can get away with using the "L" series fractional horsepower belts or the automotive belts. For heavy work loads and long term use we found the "A" series industrial belts gave us the best service. We purchased our industrial belts at the same place we got our heavy-duty pulleys, a commercial bearing and transmission shop. The general all-purpose belts can be found in the furnace sections of your hardware and building supply shops. And of course the automotive belts are available at your local garage or auto supply shop.

## In Our Next Section We Will Show You How To...

- Find a good used lawn mower the cheap and easy way
- Easily modify your mower deck to install the items
- Assemble the mower and items into a working generator

To Continue .....[Click Here](#)

**MENU:** [HOME](#) » [Reconstruction](#) » [Recovery](#) » [Renewal](#) » [Energy Types](#)

---

---

---

# How to Modify Your Lawn Mower

You're going to have to modify the deck of the lawn mower somewhat, so you might not want to use the family's mower unless you're in a pinch. And don't use the one you borrowed from your neighbor either. You can pick up good used lawn mowers for a song, try garage sales, your local penny saver and newspaper classifieds. We put an ad in the newspaper stating " Wanted good used Lawn Mower" we then pleaded poverty and we got a dozen phone calls with great results spending only \$25 dollars for a good mower with all the features we needed.

Okay lets get started, but first a word from our friend "Larry the Lawyer". **If you build this generator or something similar, you must build it at Your Own Risk, and assume all risks related to it's construction and subsequent use. This tutorial is intended for educational purposes only. No guarantees are expressed or implied as to the accuracy of the information presented here. If you have any doubts consult with the experts you purchase your parts from, before attempting to carry out any of the procedures mentioned here.**

Okay, lets get started tearing this baby apart. First remove the handles and cables. The removal is pretty straight forward with just a screwdriver. You can re-attach the throttle cable later or you can control the engine speed at the throttle control near the carburetor. You will most likely have a second cable coming off the handle to the flywheel brake, a safety feature introduced onto walk behind mowers in the early 80's.

Remove the cable at the handle and the brake lever next to the flywheel, you can leave the brake lever as is just flopping around ( it may create some drag on your motor ) or you can easily secure it off to the side. If you're not sure which side the lever should be positioned, just pull the starting cord. If it's difficult to pull, the brake is on, if it's easy, the brake is off, now tie the lever off with a twist tie or wire in this position.

## Removing the Blade Assembly

Some of these blade hubs can get seized onto the shaft pretty bad after many years and acres of cutting grass. Spray some kind of rust loosening compound onto the area (WD40, RustBuster) if this doesn't work, you will have to use a pulley puller to remove the hub. We schmoozed our local machine shop proprietor into lending out his puller for free, we just left a deposit so he knew it would come back. Now, while your underneath and have the WD40 handy, spray the 3 or 4 mounting bolts you will find holding the motor to the deck. Spin the bolts out and remove your motor for the next couple of steps.



## Cutting the Slot

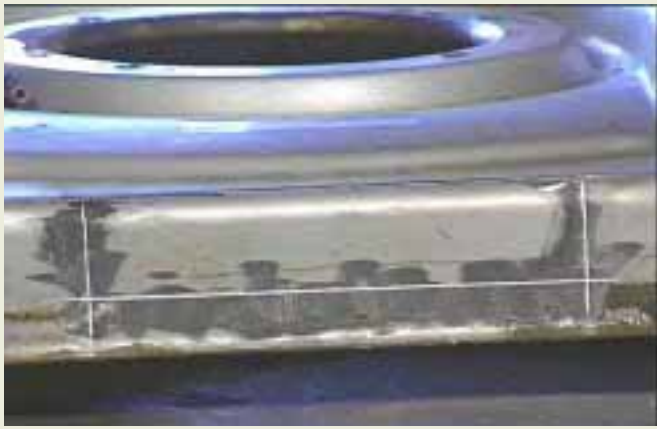


The rear end of the lawn mower deck is a very convenient spot to mount our alternator with a couple of simple metal brackets. But you have to cut a slot in the back of the mower in order for the belt to reach from the motor pulley to the alternator.

You need to cut the slot 6" wide by 1" to 1 ½" tall on the rear vertical side of the lawn mower deck. You can cut this slot quite easily by using an Oxy/Acetylene cutting torch or you can use a grinder with a cutting wheel. And if you're in a really

energetic mood, you can cut it by using a hacksaw.

We need to know exactly where the belt will come through the back off the mower deck, so we know where to cut our slot. So, let's install our motor pulley briefly so we can line up where our belt is going to come out the back. Place the motor pulley as far up the engine shaft as possible and yet still give it enough room to clear all obstacles such as mounting bolts. Now, look through the grass discharge chute. Place a straight edge on the bottom of the motor pulley and determine where the path of the drive belt will end up coming out of the back plate. Mark this spot. Now make this spot the exact center of your 6" by 1 ½" slot. Remember your belt is only ½ " thick so you will have plenty of clearance in case the spot you marked is not exactly centered.



Make sure to remove your motor once again before you



start your cutting. Now cut your slot using the methods described earlier. If you decide to use a hacksaw, you might not be able to cut a "slot." Instead you will have to cut an entire 6" wide piece out from top to bottom. No problem, just bolt a strip of metal or angle iron for a crosspiece along the bottom of the mower deck, to give it some strength again.

## Assembling The Project

### Mounting the Alternator

In order to mount our alternator we are going to use brackets made from a slotted steel material commonly referred to as angle iron. The dimensions of the angle iron were 1 ½" wide and 1/16" thick. The pre cut slots in this material made it very convenient to make an adjustable bracket for the alternator. The 90 ° angling of the metal gives it a lot of added strength, but it was also very easy to cut by hand using a hacksaw.



On the left hand side is our pivot bracket which we cut to a 7" length. On the right is the adjustable bracket, cut it to a 9" length. The pre-cut slots on this angle iron will allow you to move the bracket front to back so you can have the belt tension adjustment you need. On both brackets we want about 5" contacting the mower deck.

Now drill mounting holes on your mower deck 6 ½ " apart width wise and 2" to 3" inches along the length of the bracket depending on the pattern of the slots on your angled bracket

material. Drill your holes 3/8" thick with the first set of holes 1/2" from the back edge of the mower deck.

We extended the slots in the right hand adjustable bracket by cutting the metal with a hacksaw so we could have a wider range of belt adjustment. Use 5/16" bolts with lock washers, now fasten the ends closest to the motor. Even though we selected a relatively flat mower deck, we still have some uneven contouring to deal with. No problem, we just use spacers on the two mounting bolts closest to the edge. Use whatever you have lying around your house, in our case thick washers and a couple of 1/2" nuts worked perfectly.



Now take your alternator and mount it with the pulley facing down. One side of your alternator has a longer molded mounting hole in its casing, this side will become our pivot side and is mounted with a 3" bolt. The right side of our alternator now becomes the adjustable side. You will need a shorter 1 1/2" bolt to fasten it to the bracket. Use lock washers with your nuts and bolts as well.

## Attaching the Pulley and Belt

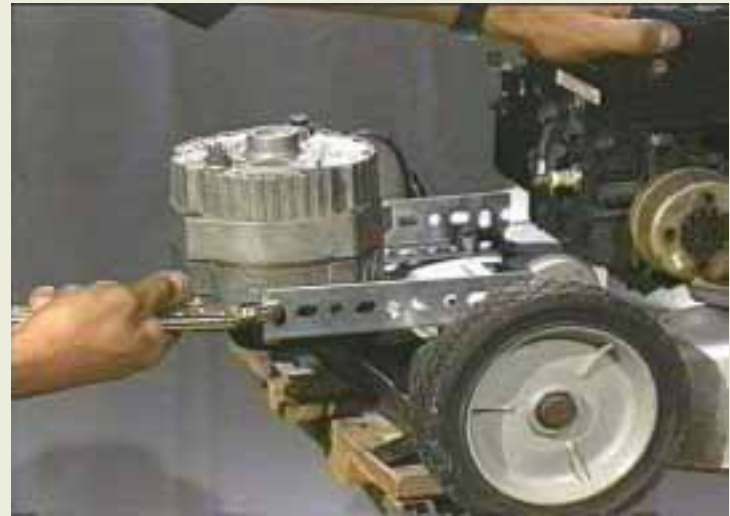
Position your alternator so that the fan blade clears the mower deck between 1/4" to 1/2". If it's too far away from the deck, you will notice more vibration. Now flip the whole unit over and attach your motor pulley, we used a 5" diameter pulley (more on this later). Next, we need a drive belt, but what length? Here's a tip for getting the right size belt on your first trip to the store. Measure the distance between the two outer edges of the alternator and motor pulleys in their final position. Mark this measurement down. Decide ahead of time if you want the lighter duty "L" series or the heavy duty "A" series. Now head down to your local building supply or commercial bearing store to buy a belt.



When you get there take 2 pulleys off the shelf with the same diameter as your alternator and motor pulleys. Next place a 1/2" belt around them and stretch the belt out. Do this until you find a length of belt that matches the measurement you marked down from your project at home. Don't do what I did. I drove down to the store with my whole project in the trunk of

my car, then ran back and forth into the store exchanging belts until I found one that fit, all the while looking like a complete dork!

Now, place your belt onto the pulleys, grab the right side adjustable bracket with a pair of Vise-grip pliers, pull toward you until you've reached a desired belt tension and then tighten the mounting bolts. Your next step is a simple wiring of the project.



## In The Next Section You Will Discover...

- A simple way to wire up your alternator, battery and accessories
- Some neat electrical gadgets you can use in your project
- Some electrical tricks to get the most out of your generator

To Continue...[Click Here](#)





# Hooking Up Your Electrical Connections For The Alternator

As was mentioned before, because of safety and ease of hook up, stick with the GM style alternator with a Built in Voltage Regulator. If you are not sure, ask the people you are buying the alternator from, if they can't answer your question consult an automotive parts professional. **"No guarantees are expressed or implied as to the accuracy of the information presented here. If in doubt consult an automotive wiring professional before you attempt any wiring."** If you make a mistake wiring the alternator you run the risk of damaging your batteries, electronic gear and worst of all causing personal injury. We set out to make this project safe and simple, so we are going to concentrate on the easiest hook up.

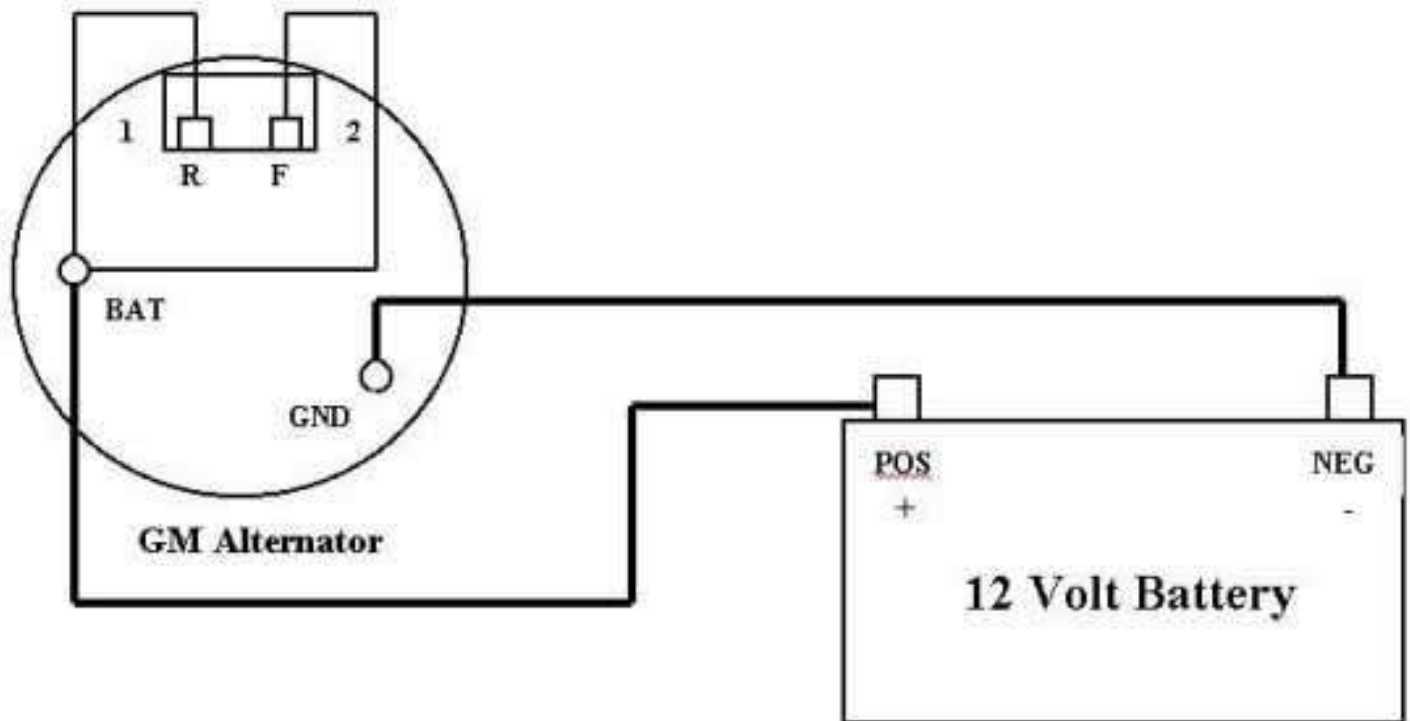


The electrical connections for your alternator are a simple but important 4-wire hook up. It was mentioned earlier that the GM alternator should come equipped with a 2 wire molded connector/harness. If not, ask for it at the point of sale or you can purchase one at an auto supply store. Ask for a 2-wire harness plug for the GM style alternator with built in regulator. They only cost a couple of bucks.

Attach your harness into the connector slot on the alternator casing. The molded harness only fits one way and ensures you don't get your wires mixed up, so Make Sure You Use It ! You might also want to attach eyelet connectors to the end of the two wires on for your convenience.

Different molded connectors may have different colored wires. We are going to ignore the color of the wires and instead concentrate on the wire identification numbers and letters on the alternator casing. Here are your basic hook ups.

## Basic Hook Up

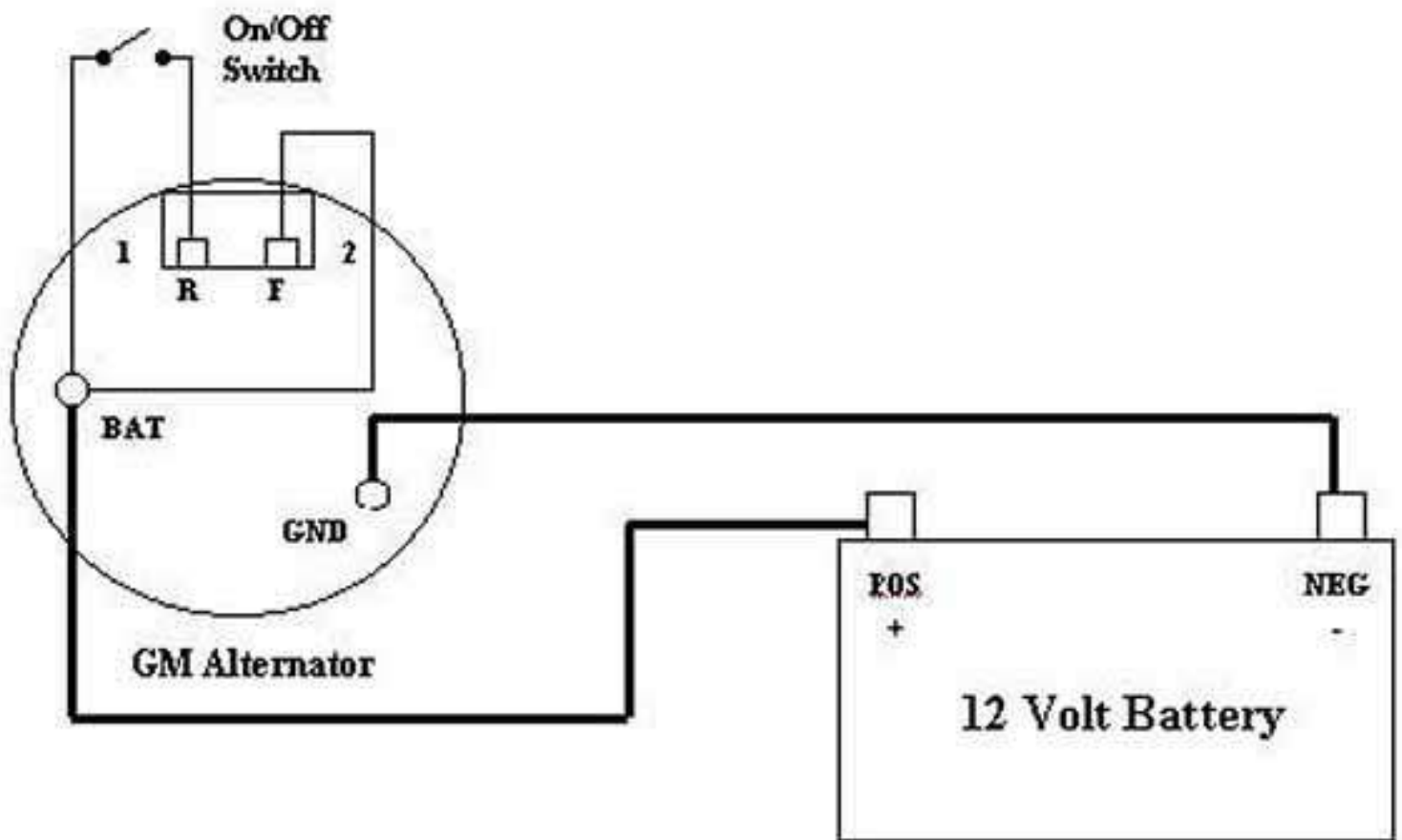


**Consult a parts professional for additional wiring information.**

# 1 or R Terminal is the lead that supplies power to the rotor field of the alternator. Connect this to the "BAT" terminal of the alternator or the POSITIVE terminal of your battery. NOTE: when you are not using your system you have to disconnect this lead as it is now drawing power from your battery and will continue until it's completely discharged.

# 2 or F Terminal is the voltage sensing line for the alternator. Connect this directly to the "BAT" terminal on the alternator or to the POSITIVE terminal of the battery as well.

## On/Off Switch



Consult a parts professional for additional wiring information.

# 1 or R For safety and convenience reasons we have installed a simple on/off switch in the # 1 circuit. When we are not using our generator we can simply turn the switch off and it will preserve the charge in our battery. Another important note is that when this terminal is energized, so is the rotor field inside the alternator.

You will now notice a lot of drag when you try to turn the alternator. Go ahead and try to start the motor, you will pull that cord until your tongue hangs out. You will need to start the motor with the switch "off" then throttle up to your desired speed. You can then turn your switch "on" and introduce the electrical load to the alternator and motor.

This switch also allows us to avoid "sparks" during the unsafe practice of hooking up wires to the battery and alternator while the generator is running. In the presence of vapors coming off the batteries and gas tank, it's a good idea, so PLEASE USE IT !!!

# Some Testing Results

## What is the ideal size pulley to use?

I hear the subject debated at great lengths. Actually any size pulley between 3" and 8" will work, but there are some differences. An 8" pulley will spin your alternator at a high r.p.m. but will give you very little torque. When it comes time to engage your alternator, it will drag your motor down until it stalls. A 3" pulley on the other hand will give you lots of torque, but a lower r.p.m. at the alternator pulley.

We have discovered that if we try to duplicate what goes on underneath the hood of a car and apply this to our home built generators, we will come up with some favorable results. A quick peek under the hood of a car tells us the motor pulley should be about 5" to 6" in diameter. We found this diameter of pulley gives us an ideal r.p.m for the alternator, with an adequate amount of torque too....But.

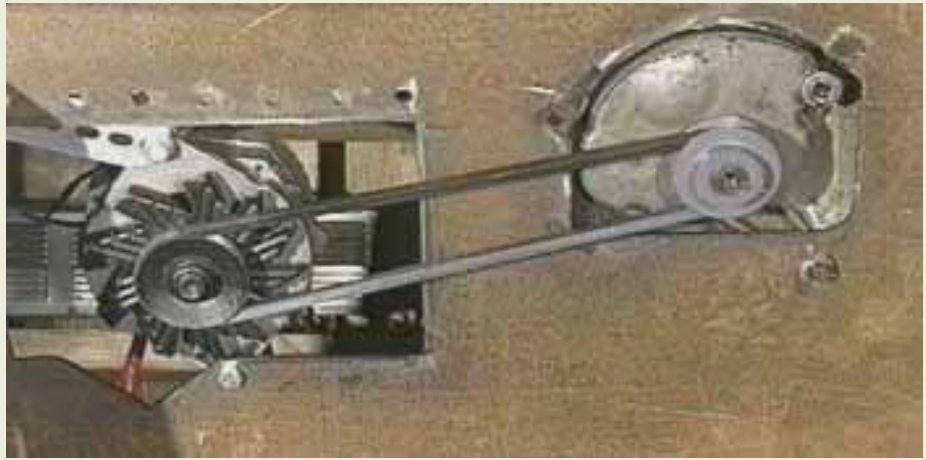
## Motors With The Same Horsepower Do Not Have The Same Output

We discovered another neat characteristic of the Briggs & Stratton **Vertical** shaft lawn mower engine. We have a **Horizontal** shaft Briggs & Stratton motor of the same horsepower. And we consistently get higher revs from the horizontal shaft motor. We couldn't figure this out at first. Both the motors were in good shape well tuned etc, but? So, I searched through the motor technical manuals for the answer.

According to manufacturer specs, they set the throttle on the vertical shaft mower to approximately 80% of its maximum output. This gives the motor a nice little feature when a schlep like me starts cutting into foot tall **wet** grass. When the motor bogs down, a device on the engine called a "governor" senses the drastic drop in RPM's and immediately allows the engine to throttle up to overcome the extra load, so the motor will not stall. When the patch of wet grass passes by, the engine then throttles back to its normally set speed.

So if you come along and decide to attach a belt and an alternator to this motor (like we just did) fire it up, engage your alternator and dump the load on the motor. Guess what? The motor is gonna think it's in wet grass Heaven. So, if you're using a 5" pulley on your project like we did, you may find that the motor will be dragged down to a stall even with a moderate load applied to it. So, how do we solve this? Well there are a couple different ways. One is to reduce the size of your pulley.

We experimented with a 3" pulley and got some good results. The smaller pulley lets the alternator produce its voltage at significantly lower throttle settings, the trade off of course is a lower amount of current (power) coming out of the alternator.



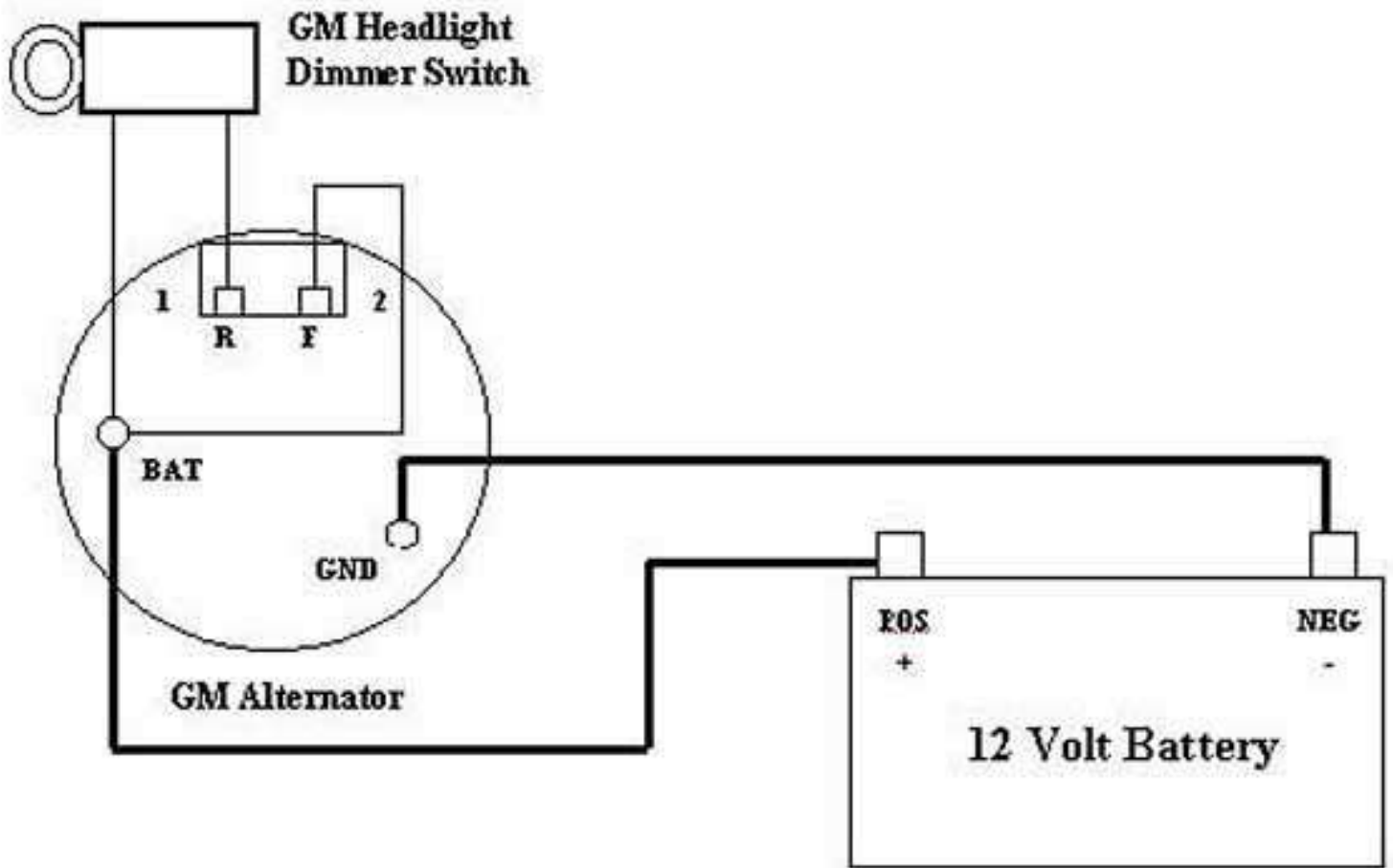
Or,...there is another option. We discovered a handy little gadget that helps us solve the problem of engine stalling when you engage the alternator. It's a GM style headlight/dimmer switch. We installed this into the #1 (R) circuit of the alternator harness. The adjustable dimmer in the switch is actually a variable resistor or otherwise known as a rheostat. It works by using resistance to adjust the flow of current to the alternator's rotor field. The more resistance you have, the less current will flow. This in turn creates a weaker or stronger magnetic field in the alternator, which will then give us more or less power off the alternator. Huh?



Let me explain it in a more practical sense. Let's say you have a generator like we just built operating at normal running speed spinning a 40 Amp alternator. You decide to charge a very low battery. Even if you rev up the motor, when you go to attach your lead from the alternator to the battery, the alternator is going to sense a low battery charge and will try to output a large amount of current. This creates a huge drag on the alternator which in turn bogs down the motor usually until it stalls.

But, this is what happens when you have the dimmer switch in the #1 circuit. You set the switch at its highest resistance level. Now start turning the knob slowly counter-clockwise. As you keep turning the knob to the left, the resistance level in the switch drops allowing more current into the alternator's rotor field, which in turn allows more alternator output. You will notice at this point the alternator is now starting to "load" the motor. The beauty of this method is while you slowly turn the switch and load the motor, you can now offset the load with a higher throttle setting on your motor. You can then adjust the switch some more, then increase the motor revs some more until you get a desired speed, without stalling. This system allows a nice gradual smooth adjustment of the alternator's output. It works really slick, try it. And the switches are cheap too, we picked up ours at an auto wrecker for 5 bucks.

## Variable Resistance Dimmer Switch Hook Up



Consult a parts professional for additional wiring information.

Which one of these two methods will work better for you? It's hard to say, depending on the type of motor you will use. How old is it? Is it tuned up? What kind of parts you installed on your project? No two set ups are the same, but at least you have some options. Try what works best for you and stick with it.

## Some Final Notes



You can now re-attach your handles. A really handy option is to hook up your throttle cable again and then mount your GM dimmer switch next to your throttle control on the handle. You now have complete control of your generator right at your finger tips.

So, there you have it. You are now armed with the information to be electrically independent should the need ever arise. Stay healthy and stay powered.

---

Copyright © 1999 Gemini Media Productions Inc All Rights Reserved

**MENU: [HOME](#) » [Reconstruction](#) » [Recovery](#) » [Renewal](#) » [Energy Types](#)**

---

---

## Wind Powered Generators

Many more people will have wind as a resource than will have water as a resource. The principles of building a generator remain very much the same for both but wind has a number of special considerations and anyone considering this as a resource should look at the pages linked below:

*Towers:* [You have to get them up in the air](#)

*Blades:* [Or what some people call propellers](#)

*Tails:* [And mounting the generator](#)

*Overview:* [Forcefield Overview of Windmill Design.](#)

This is a good overview on Windmill generating systems from Forcefield.

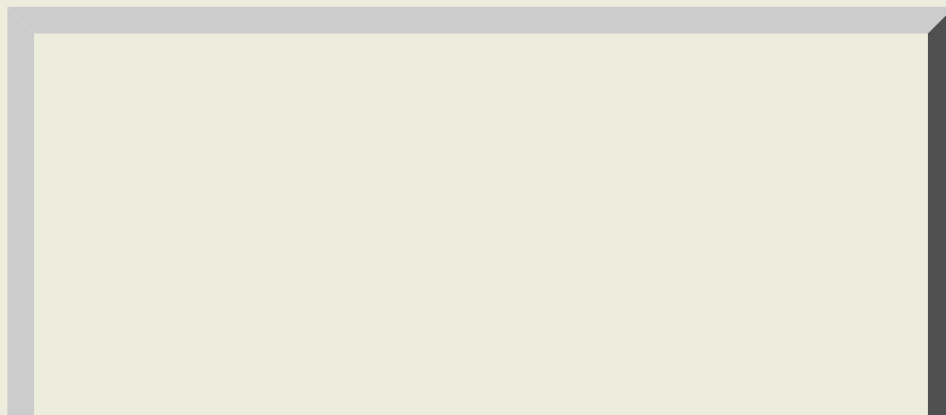
*SEALED:* [Forcefield Overview of Windmill Design.](#)

This is the SEALED mirrored version of this site from Forcefield that won't be opened until after The Great Catastrophe.

*Designs:* [Designs for complete wind generating units](#)

Most homemade windmill generator systems need a LOW RPM generator and you will find under our above linked webpage many designs applicable to windmill generators.

*Testing:* [An important step](#)





## Batteries

Another essential subject to wind generator systems is batteries to store excess power in times of high generation and to make power available when there is no wind. Batteries are discussed on another one of our other web pages.

**MENU:** [HOME](#) » [Reconstruction](#) » [Recovery](#) » [Renewal](#) » [Energy Types](#)

---

---

## Towers

### Towers

Wind is wonderful. Sometimes. What we are talking about here is more than a gentle breeze. If you live where there is a fairly steady breeze you may have more than you imagine - forty feet up. No matter where you are you want to build a tower at least 40 feet high to get away from ground effect. The wind blows much smoother and steadier (and often times stronger) higher above the ground.

This one is at a nearby friend's home who actually has a half dozen. He is in his eighties and his father built them when he was a boy. Sort of "grandfathered" because it is something we couldn't do today. The point here is that towers can be complicated and dangerous. Can you imagine climbing up and down one with a heavy generator that needs repair.





The towers that I have been admiring (like this one at Bob Budd's) are poles built out of Schedule 40 pipe. (Schedule 80 is too heavy to handle and anything less than Schedule 40 gets pretty weak. Schedule 40/80 measures the wall thickness of the pipe.) Guy wires should be well below the blades so a blade doesn't get chipped.

The bottom of the pipe pole is hinged between a couple of well planted (concreted) H beams and a pipe extends 15 feet out horizontally from the bottom of the tower pole with a diagonal pole to a spot 20 feet up the tower pole to strengthen it. This pipe triangle is then anchored out at the front and released (along with a front guy wire) in order to winch the pole down backwards or back up again. This arrangement makes repairs and periodic maintenance much simpler and one could get the wind generator down and protect it if they had enough warning about a big storm.

### [Overview: Forcefield on Tower Design.](#)

Forcefield also gives a good explanation here about tower design.

### [SEALED: Forcefield on Tower Design.](#)

This is the SEALED mirrored version of this site from Forcefield that won't be opened until after The Great Catastrophe.

**MENU: [HOME](#) » [Reconstruction](#) » [Recovery](#) » [Renewal](#) » [Energy Types](#)**

## Blades or Propellers

There are volumes of books about blade design. It is one of the most discussed and theoretical aspects of wind generators. However, there seems to also be a body of thought that many simple designs will work relatively well. One can spend many days (as we have for ours) in making a set of blades or there are blades described here that people say that they have put together in a matter of just a few hours.

My thought is that in a nuclear recovery situation the idea may well be to get something up and working as quickly as possible and then once one has the opportunity to do so there is much information here that one can use to experiment and make up their own mind about the trade-off between the efficiency gain from blades that take much longer to build and those that work less well or don't last as long but are quicker to make.

*Propellers:* [Technical info on how to build blades](#)

This is a 13 page .pdf file from Hugh Pigott and it is chuck full of very technical diagrams and charts.

*Propellers:* [And still more info on how to build blades](#)

This is a 27 page .pdf file from Hugh Pigott with many more diagrams and pictures that may be even more helpful.

*Blade Design:* [Some neat diagrams on blade design.](#)

This is the Windstuff Now site.

*SEALED:* [Some neat diagrams on blade design.](#)

This is the SEALED mirrored version of this site that won't be opened until after The Great Catastrophe.

*Blade Design:* [A blade in one hour.](#)

This is a Windstuff Now site on how to make a blade in one hour.

*SEALED:* [A blade in one hour.](#)

This is the SEALED mirrored version of this site that won't be opened until after The Great Catastrophe.



The blades for windmills are designed and work just opposite of those for airplanes.

We are carving ours out of basswood because the wood is "clear" (that is to say the wood has no knots). Other kinds of wood will do, but there is a real art to carving the blades. On my right is a block that we start with and on my left the almost finished propeller blade.

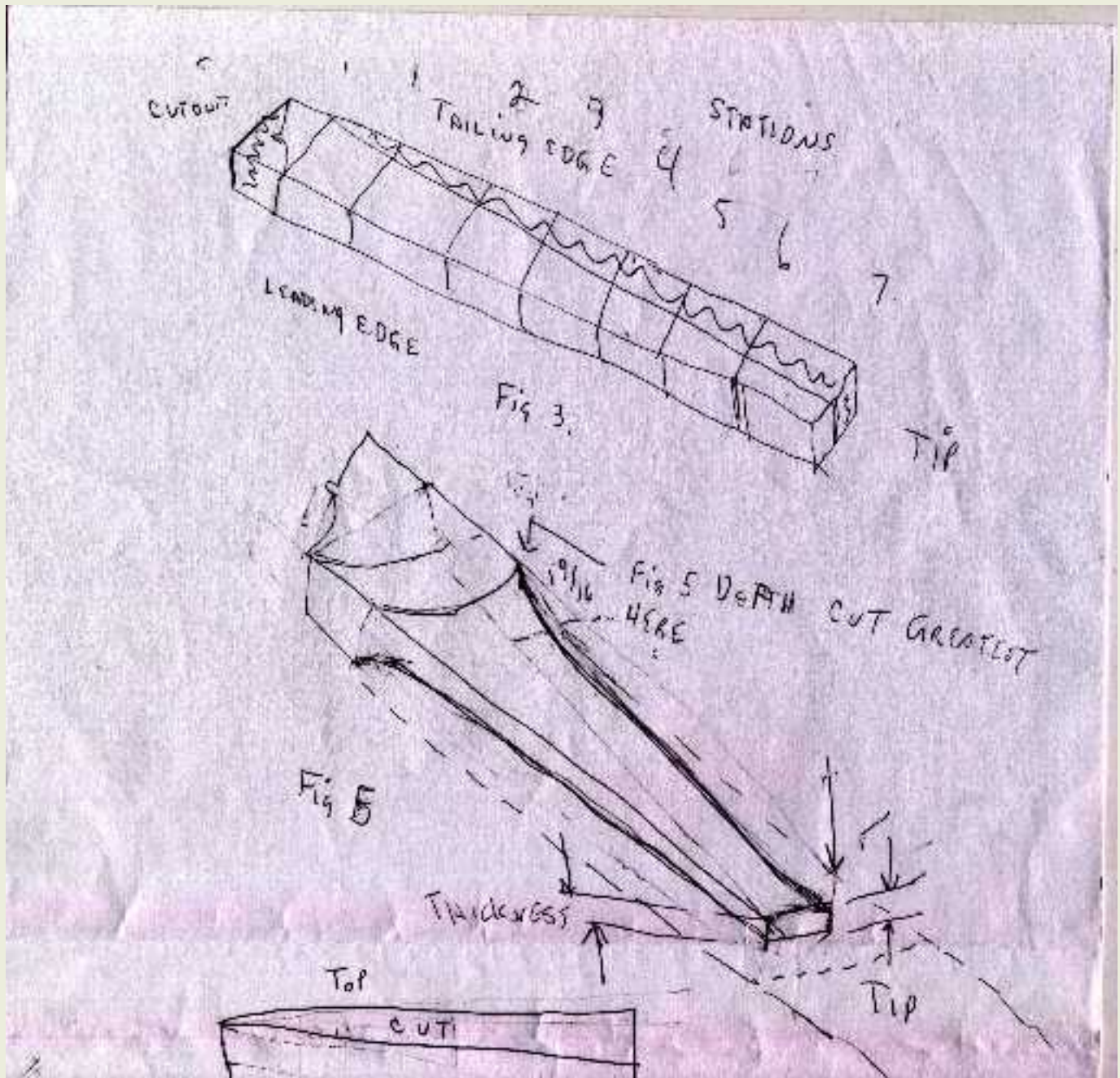
Immediately following are the drawings that Ed drew for our blades.

## Ed's Blade Drawings

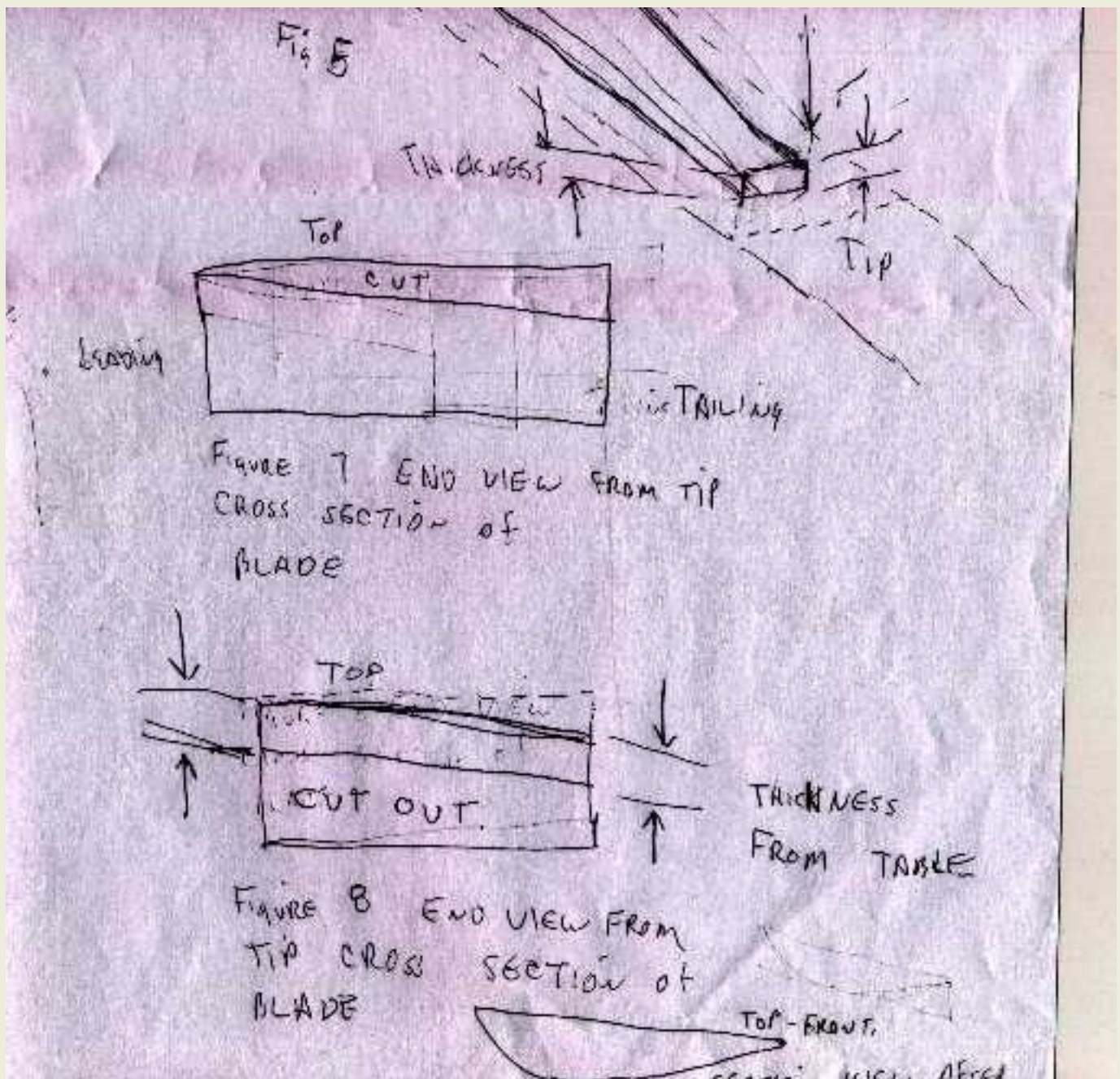
In this first drawing you see the rough shaped block of wood and how it is marked out into "stations".

Take note that there is a **leading** edge and a **trailing** edge.

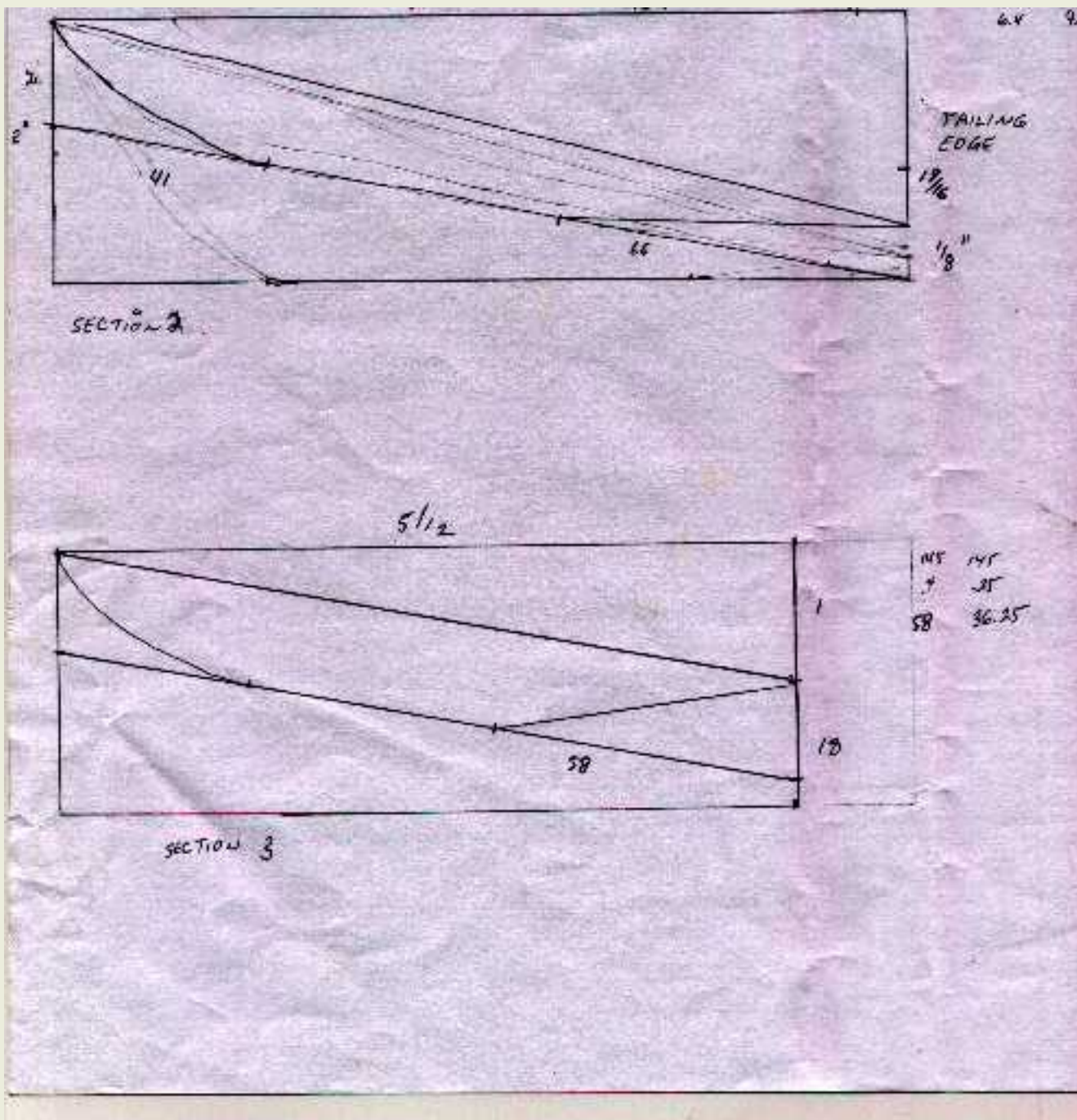
The leading edge is wider and blunt. The area behind the trailing edge is what is being cut away.



The trailing edge will be cut to a thin knife edge, but in the drawings immediately above and below it is still blunt. This shows a cross view of section 7 which is the very tip of the blade.

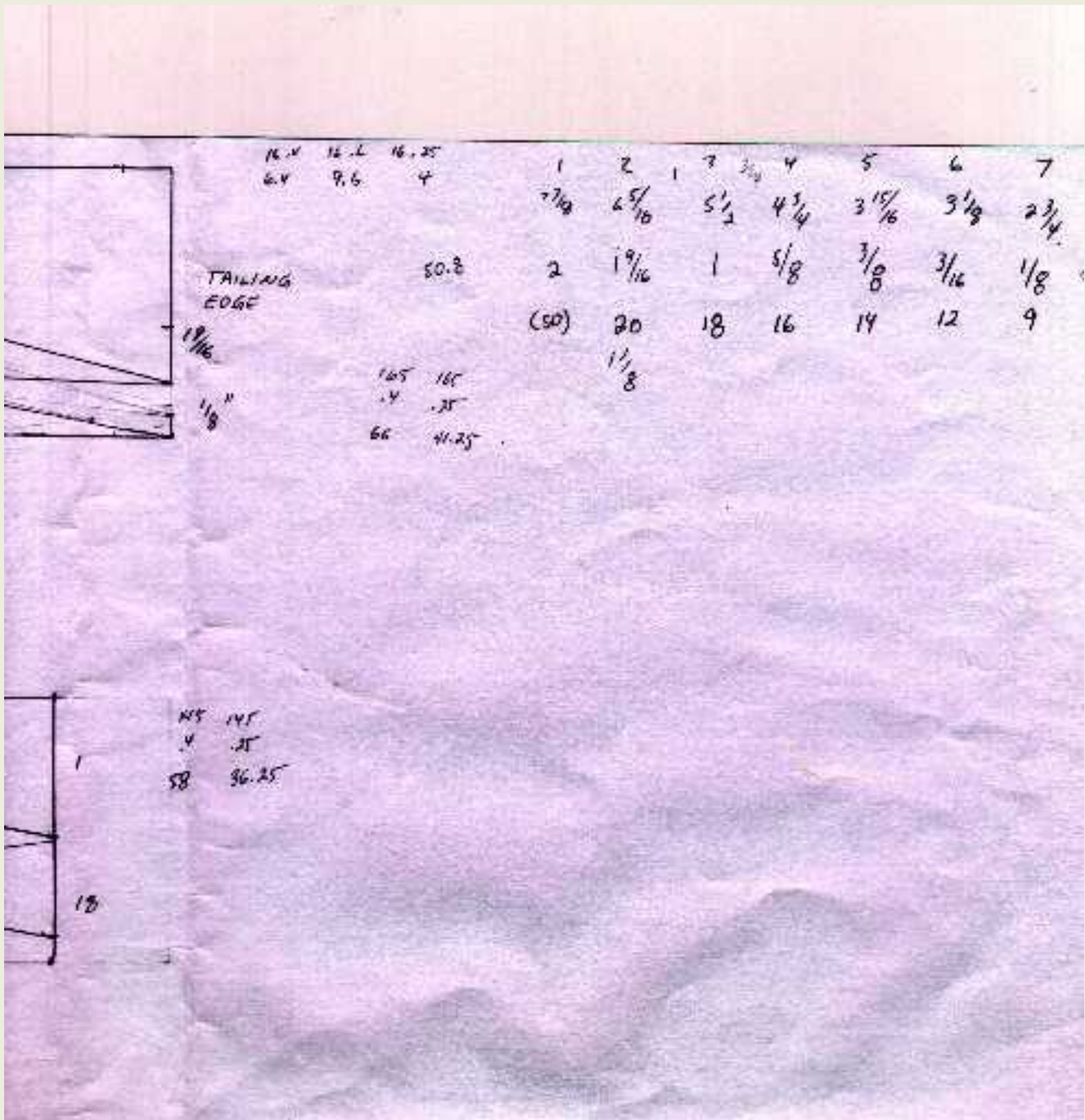


Each of the following drawings, starting at section 2 immediately below and going through each drawing up to section 7, show a cross-section through the wood as to where the finished blade will lay at that point. The depths change at each station because the blade has a twist to it.

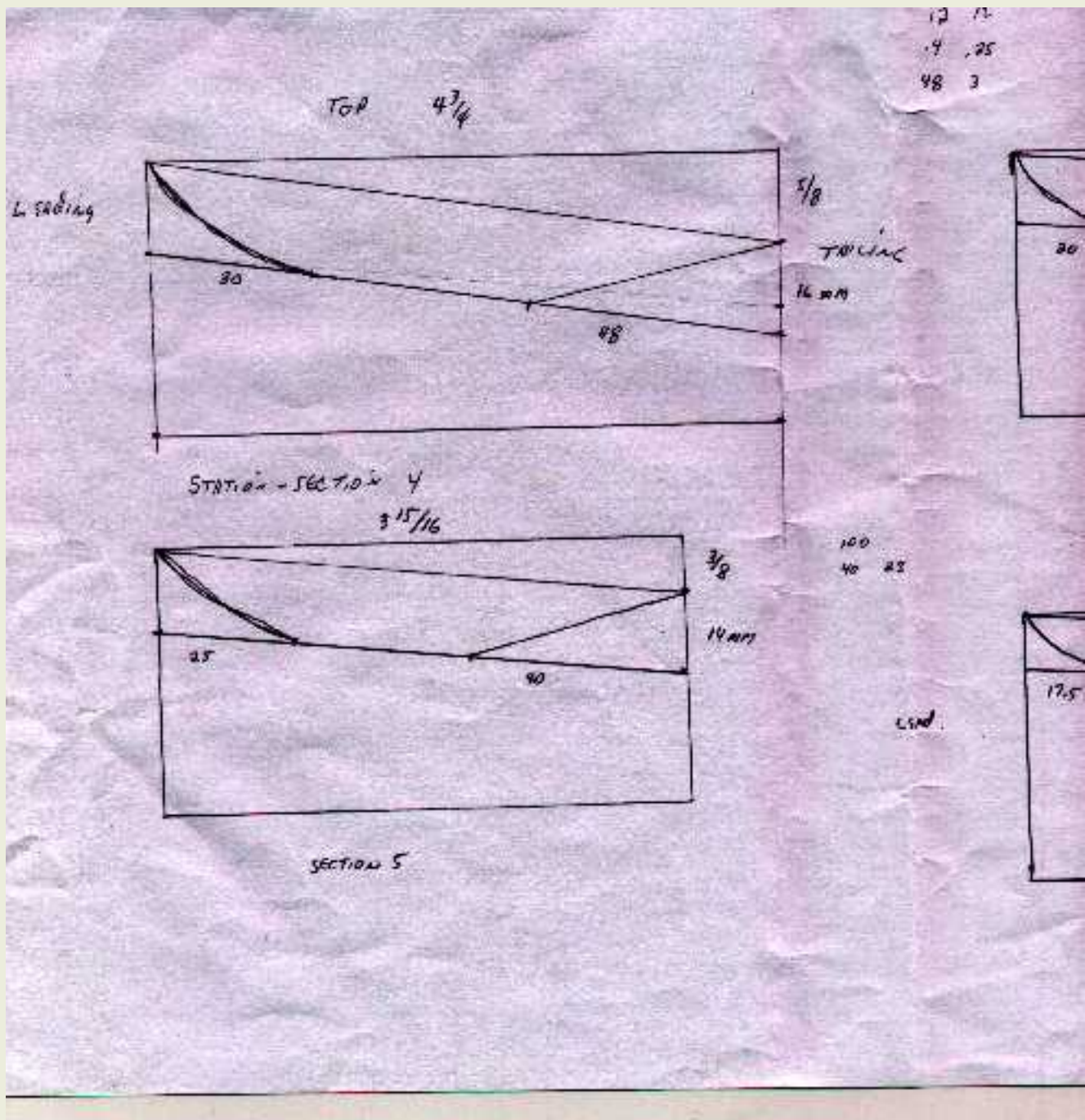


The table on this next drawing shows the thicknesses - at each station.

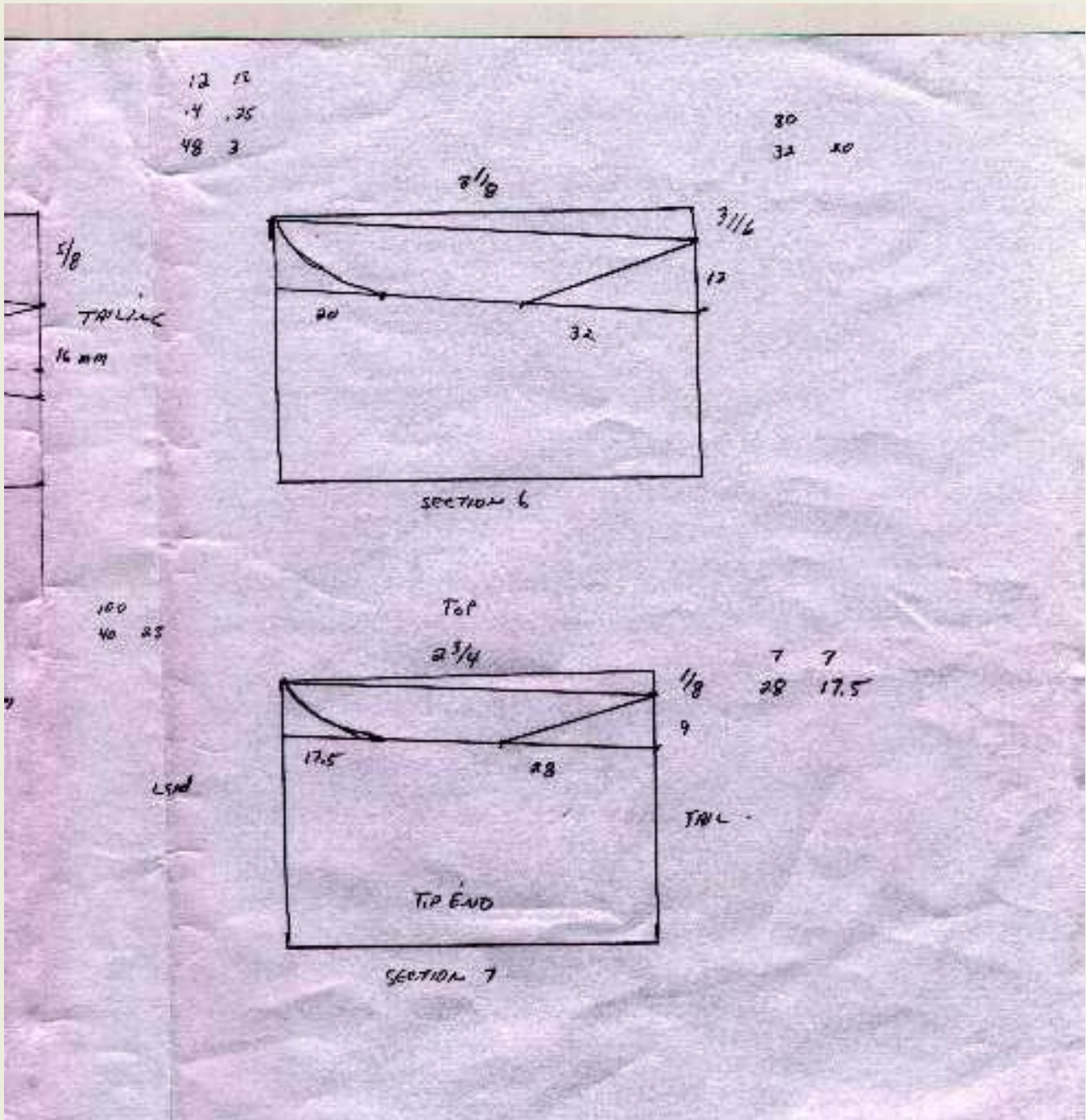




It can be seen from the end view of the block - that about 80% of the wood is cut away in making a blade.



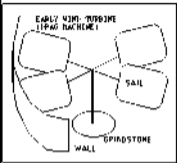
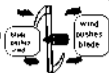
After the blade is sanded and finished it is a good idea to armor the leading edge that bites into the wind - otherwise it will quickly wear down. Armoring can be done with a heavy epoxy or resin - laid on an eighth or more on an inch thick. Periodic maintenance and re-armoring will preserve the blade - and greatly increase its longevity.



**MENU: [HOME](#) » [Reconstruction](#) » [Recovery](#) » [Renewal](#) » [Energy Types](#)**

Wind turbine rotor blades take power from the wind by slowing it down

This is done by applying a force to the wind, and the wind applies the same force to the blades



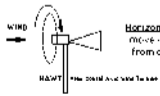
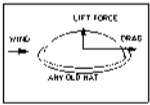
Objects in the path of a stream of air experience a 'downwind' force called drag.



The drag force was used by the earliest wind turbines. It is easy to understand how this force causes the blades to turn, but such rotors are very slow and the blades which are moving with actually slow the rotor down.

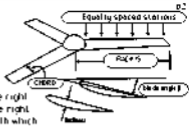
Drag is the force of wind pushing straight downwind.

But there is another force called lift which always works at right angles to the wind direction.

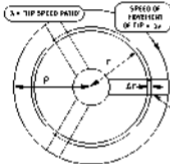


Horizontal axis wind turbine blades never move downwind, so they can get no help from drag forces. Instead they use lift.

To create a blade design we need to specify the chord width and blade setting angle  $\beta$  at each of a series of stations along the span of the blade



At each station we will create the right shape of the blade to produce the right loading (lift) for the bit of wing with which it will have to deal



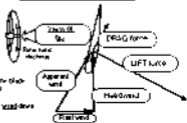
The process of calculating the best (design) and therefore the best shape is known as 'finite element analysis', and it looks at what each bit of the blade needs to do

THE BIT OF THE BLADE AT RADIUS  $r$  SWEEPS A FRACTION OF THE TOTAL SWEEP AREA AND HAS THE JOB OF SLOWING THE BIT OF WIND DOWN BY THE RIGHT AMOUNT TO SATISFY THE BETZ CRITERION

THE AREA OF WIND IT SWEEPS WILL BE  $\Delta r v_t \phi$   
ITS HEADWIND WILL BE  $(v - v_t \phi) / \lambda$   
WHERE  $v$  IS THE TIP SPEED RATIO  $\lambda$  WHICH WE WOULD LIKE IT TO WORK

The apparent wind which a blade 'sees' is altered by its own speed through the air

This headwind adds to the real wind to give the apparent wind, which creates the lift and drag forces



The drag and lift forces are the forces on the blades as they spin  
The drag force opposes the blade's movement  
The lift force opposes the blade's movement  
Both forces also push the blade downwards and slow the spin down

The mathematics of lift and drag

$$LIFT = C_L \rho v^2 \frac{A}{2}$$

$$DRAG = C_D \rho v^2 \frac{A}{2}$$

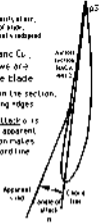
where  $\rho$  is the density of air,  
 $v$  is the speed of flow,  
 and  $A$  is the apparent wing area

Lift and Drag forces depend on the Coefficients  $C_L$  and  $C_D$ , which in turn depend on the cross section of blade we are using, and on the angle  $\alpha$  at which the wind strikes the blade

The chord line is the longest line in the section, joining the leading and trailing edges



The angle of attack  $\alpha$  is the angle the apparent wind direction makes with the chord line

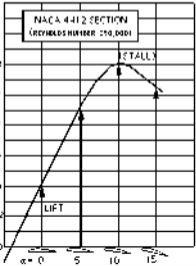


You cannot calculate the lift and drag coefficients

They are measured experimentally in wind tunnels, and recorded in tables

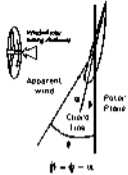
Here is a typical graph of lift vs. angle of attack

As  $\alpha$  increases, so does the lift, until a point is reached where the blade stalls



Most flat-ish objects will give a similar sort of LIFT  $\alpha$  curve. But cambered, streamlined sections yield better LIFT/drag

When designing a wind turbine rotor, the angle  $\alpha$  will depend on the angle of the apparent wind  $\phi$ , and the blade angle  $\beta$



So we have control over  $\alpha$ , and thus control over the lift and drag produced by the blade

We shall need to optimise the lift force, to satisfy the Betz criterion, but the blade will not work well unless the drag is minimised

So we have to choose a section and an angle of attack, where the lift/drag ratio is high

Finding the exact best angle  $\alpha$  can be an involved process, because the lift and drag coefficients depend on both the section and the Reynolds number (a measure of the size and speed of the blade)

THE REYNOLDS NUMBER IS 68500X (MCP) x 111 x APPARENT WIND SPEED (111.5) IF D=2m AND X=5 AND u=5m/s THEN REYNOLDS NO IS ABOUT 120,000

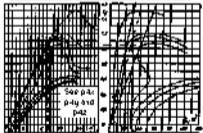
On the left is a pair of graphs which refer to the NACA 4412 section for several different Reynolds numbers

The left hand graph shows lift. The right hand one shows lift/drag

The straight lines through each, represent particular lift/drag ratios. Best lift/drag ratio for a given Reynolds number is 4.75 and the lift to drag line is rotated as far as possible anticlockwise so that it just touches the curve at a tangent

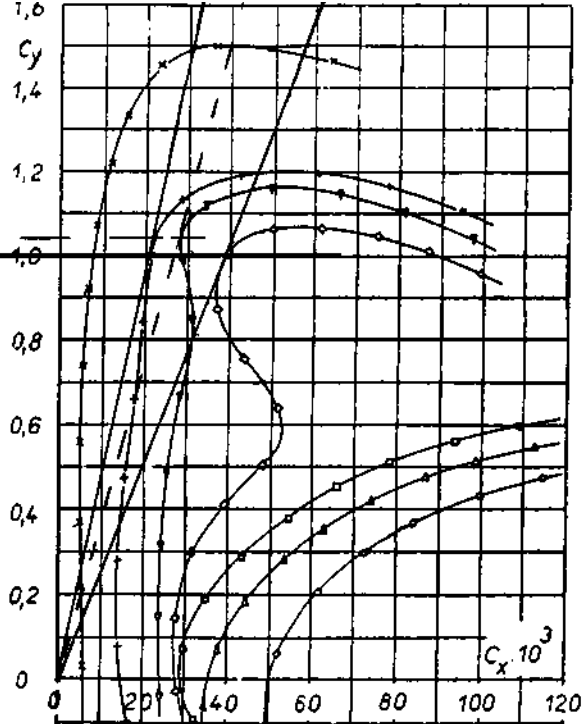
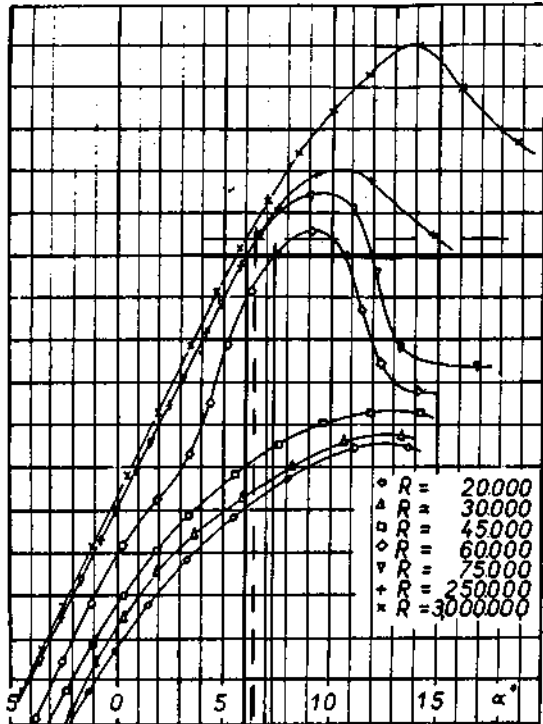
For the NACA 4412, this point of contact is where  $C_L$  is about 1 and  $C_D$  is about 0.2

Note that low Reynolds number leads to poor lift and low lift/drag ratio, which can be explained for rotors with narrow chord widths in low wind. They are often vertical too (to  $\alpha = 90 > 2$ ) which has better performance than the NACA 4412 at low Reynolds number



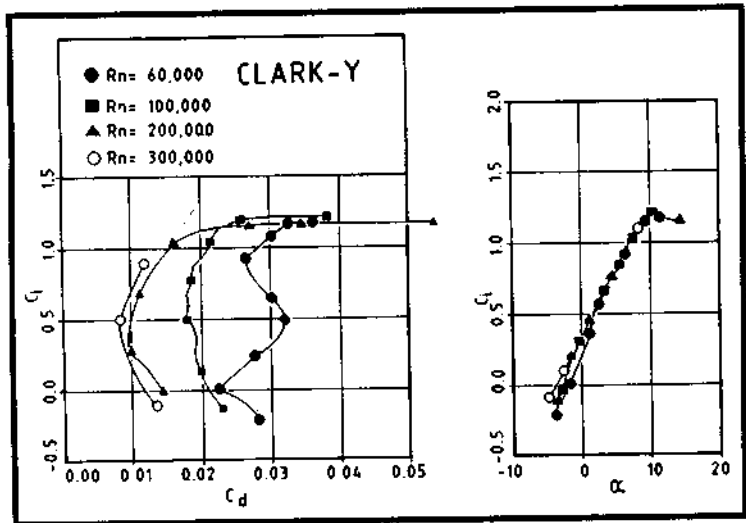
In practice, most sections will produce their best lift/drag at an angle of attack around 5 degrees, so as a general rule where detailed data is not available, we can say that the blade angle  $\beta$  should be set to give this angle of attack, thus

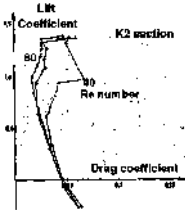
$$\beta = \phi - 5$$



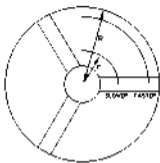


# WIND TUNNEL TEST POLARS



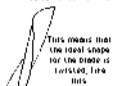


To specify blade angle  $\beta$  we need to know the angle  $\phi$  at which the apparent wind strikes the rotor plane



BLADE VIEWED FROM THE TIP

Headwind is greater near the tip (where  $r=P$ ) than it is near the root, so the angle  $\phi$  changes



**CALCULATING THE CORRECT BLADE SETTING ANGLE  $\beta$**

$\beta = \phi - \alpha$

WHERE  $\tan(\phi) = (C_T/2) / (C_P/RSVP) = (2P) / (3r)$

SO THE BLADE ANGLE  $\beta$  IS

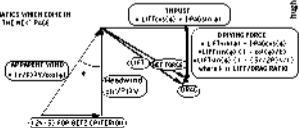
$\beta = \arctan(2P/3r) - \alpha$

WHERE  $\alpha$  IS USUALLY AROUND 5 DEGREES



WIND THROUGH THE ROTOR =  $(2/3)P$  (FOLLOWING BETZ'S THEOREM)

HERE IS A TRIANGLE WHICH COMES IN USEFUL ON THE NEXT PAGE

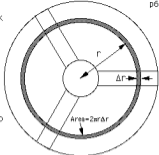


Having worked out  $\beta$  we still need to work out the Chord width. Here is the logic:

Each blade element has a certain band of wind to process.

As radius  $r$  grows smaller near the centre, the amount of wind in the band gets smaller too.

The outer parts of the blade therefore do the most work. The inner part is less important but needs a different shape.



To satisfy Betz, the wind in each part of the swept area of the rotor must be slowed down to 1/3 of its upstream velocity, and this slowing is done by the THRUST force, which is very closely related to the LIFT force.



NEGLECTING DRAG (very small error), THRUST = LIFT  $\cos(\phi)$

FOR BETZ, THRUST =  $(4/9)\rho A V^2 = (4/9)\rho (2\pi r \Delta r) V^2$

AND WE KNOW THAT LIFT =  $CL(\rho/2)BC\Delta r(\text{APPARENT WIND})^2$   
 $= CL(\rho/2)BC\Delta r(\lambda V(r/R) / \cos(\phi))^2$

THIS LEADS TO A ROUGH EXPRESSION FOR THE CHORD WIDTH C WHICH WILL PRODUCE THE RIGHT AMOUNT OF THRUST TO MEET THE BETZ CONDITION

$$C = \frac{16\pi R (R/r)}{9\lambda^2 B}$$

where B is the number of blades,  
 CL is the lift coefficient,  
 C is the chord width, at radius r,  
 and V is the free wind speed.  
 BCΔr is the area of blade used to produce lift at radius r.

WARNING: FOR SIMPLICITY, WE HAVE ASSUMED THAT CL AND  $\cos(\phi)$  ARE BOTH ABOUT = 1. THIS EQUATION WORKS BEST FOR THE OUTER PART OF THE BLADE ONLY.



CONCLUSIONS

C IS INVERSELY PROPORTIONAL TO RADIUS r.  
 so the blade shape should be tapered

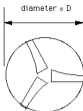
C IS INVERSELY PROPORTIONAL TO BLADE NUMBER B  
 so fewer blades will be wider blades

C IS INVERSELY PROPORTIONAL TO TIP SPEED RATIO SQUARED  
 so doubling speed means cutting blade width down to 1/4

Back of envelope blade design:-

1. Choose rotor diameter D to suit your power requirements

Diameter (m)	(Watts) Power
1	50-100
2	250-500
3	500-1000
4	1000-2000
5	2000-3000



2. Choose a tip speed ratio λ.  
You are free to use is trial and error here.  
I suggest you opt for a tip speed ratio between 5 and 8.

Tip speed ratio will affect rpm.  
shaft speed =  $60\lambda V / (\pi D)$  rpm

3. Decide how many blades B to use  
(B=3 is the best.  
Or try  $B=80/\lambda^2$ )

4. The width of the blade C in the outer portion, will be :  
 $C = 4D / (\lambda^2 B)$

for example if  $D=2m$ , and tip speed ratio = 7 and  $B=2$ , then  $C = 4 \times 2 / 49 \times 2 = 0.08m$  (or 8cm).

The outer part is the most important, but the inner part should be made wider, to help with starting torque.

5. To find the best blade setting angle β, read it from this graph:-

THIS IS BASED ON THE IDEAL ANGLE FOR A POINT NEAR THE TIP.

STRAIGHT, UNTAPERED, UNTWISTED BLADES  
IN PRACTICE MANY WIND TURBINE BLADES ARE BUILT WITH CONSTANT WIDTH AND CONSTANT BLADE ANGLE, LIKE THIS. THERE IS SURPRISINGLY LITTLE LOSS OF EFFICIENCY BY MAKING THIS COMPROMISE.



BUT THERE ARE OTHER GOOD REASONS TO USE A TWIST AND A TAPER:

- BETTER STARTING
- STRONGER BLADE ROOT

IF YOU HAVE A GENERATOR WITH KNOWN POWER OUTPUT AND KNOWN RPM, AND YOU WANT TO BUILD A WINDMILL TO FIT THAT, THEN YOU MAY FIND THIS FORMULA USEFUL:

$$DIAMETER = (POWER / (47\lambda / RPM)^3)^{0.2}$$

(“0.2” MEANS THE FIFTH ROOT)

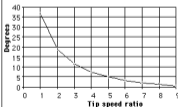
FOR EXAMPLE IF POWER = 500 W  
AND RPM = 300 RPM  
AND CHOSEN TIP SPEED RATIO = 5  
THEN BEST DIAMETER WILL BE

$$DIAMETER = (500 \times (47 \times 5 / 300)^3)^{0.2}$$

$$= (500 \times (0.783)^3)^{0.2}$$

$$= 2.40 \times 0.2 = 3 \text{ metres}$$

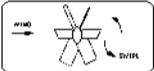
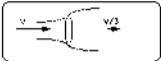
**blade angle at  $r=3R/4$**



**Factors affecting the power coefficient**

(Where the lost energy goes?)

**Loss 1** is the wind which escapes around the side of the rotor. Betz figures out that the best we can do is catch 0.593 of the power and that to catch even that much we need to slow the wind down to 1/3 of its upstream, free velocity  $V$ .



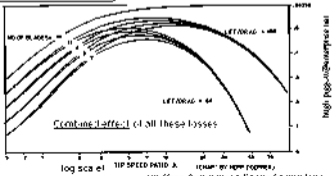
**Loss 2** is the lost power in the swirl created by high torque rotors. Glauert figured out that this is worst at low tip speed ratios.



**Loss 3** is due to the fact that we are not able to be everywhere at once. Wider = there are a finite number of blades, the thrust loading is higher, and some wind prefers to go around the tips. This is known as tip loss.

**LIFTING FORCE**  
 $= \text{LIFT} \cdot \sin(\alpha) \cdot C1 = C2 \cdot \text{TIP} \cdot \text{RATIO}$   
 $\text{TORQUE} = \text{LIFT} \cdot (\text{RATIO})^2 \cdot C2 \cdot \text{RPS}$   
 SO LIFT:TORQUE MUST INCREASE WITH INCREASING TIP SPEED RATIO OR TORQUE FACTOR AS HUB TOLL.

**Loss 4** is drag loss, which depends on LIFT:DRAG ratio. It gets worse for high tip-speed-ratio rotors, where the lift force is rotated furthest from the direction of blade movement.



5) what is the best design for a wind turbine rotor?

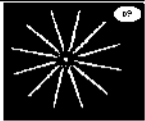
From the graphs it looks as if a tip speed ratio around 5 is ideal with as many blades as possible. The trouble with having lots of blades is that they have to be very narrow or run at very low tip speed ratio for both, to satisfy the Betz condition.

The perfect wind turbine rotor has an infinite number of infinitely narrow blades.

The wind-tower type of rotor (right), created by Claus Fugère at windvision, follows this logic.

Due to the low Re-numbers the blade profile must be carefully selected and rather thin. To obtain strength and torsional stiffness, this requires a composite structure and skilled workmanship.

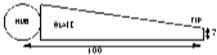
Here is a less ambitious planform shape for a blade.



Source: Windvision

HERE IS A 12-BLADED WIND-TOWER ROTOR DESIGNED FOR TIP SPEED RATIO  $\lambda = 5.6$ . PROBABLY THIS IS THE MOST EFFICIENT SHAPE OF ROTOR.

IN PRACTICE THIS APPROACH IS RARELY USED BECAUSE THE ROTOR IS TOO SLOW. AT HIGHER TIP SPEED RATIOS, 5 BLADES WOULD BE BETTER IN SPITE OF THE LOSSES.



Once you have chosen a blade planform, then the number of blades is dictated by the tip speed ratio  $\lambda$  -

$$C_T = \frac{16\pi^3 P/r^3}{4\lambda^2 B}$$

$$T_{max} B = \frac{16\pi^3 P/r^3}{4\lambda^2}$$

AT THE TIP,  $C = 1/1000$  SO

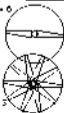
$$B = \frac{90}{\lambda^2}$$

RULE OF THUMB ONLY FOR THE BLADE LENGTH



1 blade,  $\lambda = 9$

THE BLADE ANGLES ARE DIFFERENT IN EACH CASE ONLY THE PLANFORM IS THE SAME



10 blades,  $\lambda = 5$

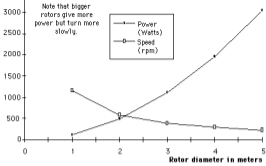
2 blades,  $\lambda = 5$

High speed blades  
(pros and cons)

The graph to the right shows the speeds and electrical power outputs of windmills with a range of rotor sizes, running at tip speed ratio of 5, in a 12m/s rated windspeed.

For this graph, power is calculated on the basis of rotor  $C_p=0.25$  and other losses=40% overall, which is easily possible for small wind turbines. (Other losses are friction, iron, copper and rectifier losses to produce the electricity output.)

Good machines will exceed this performance.



Choice of rotor size (diameter) depends on power required.

Choice of tip speed ratio  $\lambda$  depends on many factors. High tip speed ratio results in higher shaft speed is more efficient for generating electricity, which often outweighs these disadvantages:-

1. Noise from the blades is higher
2. Vibration in case of 2-bladed (or 1-bladed).
3. Blades edges, at high air-speeds suffer erosion.
4. Reduced rotor efficiency, due to drag, and tip loss.
5. Starting difficulties, if the shaft is stiff to turn.

STARTING TORQUE CAN BE ESTIMATED FROM THE FORMULA

$$\text{TORQUE} = \frac{v^2 R^3}{(\text{DESIGN TIP SPEED RATIO})^2}$$

FOR EXAMPLE A 2m DIAMETER WITH TIPS SPEED RATIO  $\lambda = 5$  ROTOR IN A 4m/s WINDSPEED WILL HAVE STARTING TORQUE

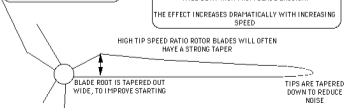
$$\text{TORQUE} = \frac{4^2 \cdot 1^3}{5^2} = 0.64 \text{ Nm}$$

N.B. THIS IS ONLY AN APPROXIMATION!

BLADE TIPS TRAVELLING AT SPEEDS IN EXCESS OF 80m/s WILL SUFFER FROM EROSION OF THE LEADING EDGES DUE TO IMPACT OF SMALL PARTICLES BORN BY THE WIND. THIS CAN BE COUNTERED TO SOME DEGREE, BY THE USE OF SPECIAL TOUGH COATINGS.

A ROTOR WITH TIP SPEED RATIO 7 IN A 12m/s WIND OR A 5m DIAMETER ROTOR RUNNING AT 350rpm WILL BE AT RISK FROM BLADE EROSION.

THE EFFECT INCREASES DRAMATICALLY WITH INCREASING SPEED





Department for International Development, UK



---

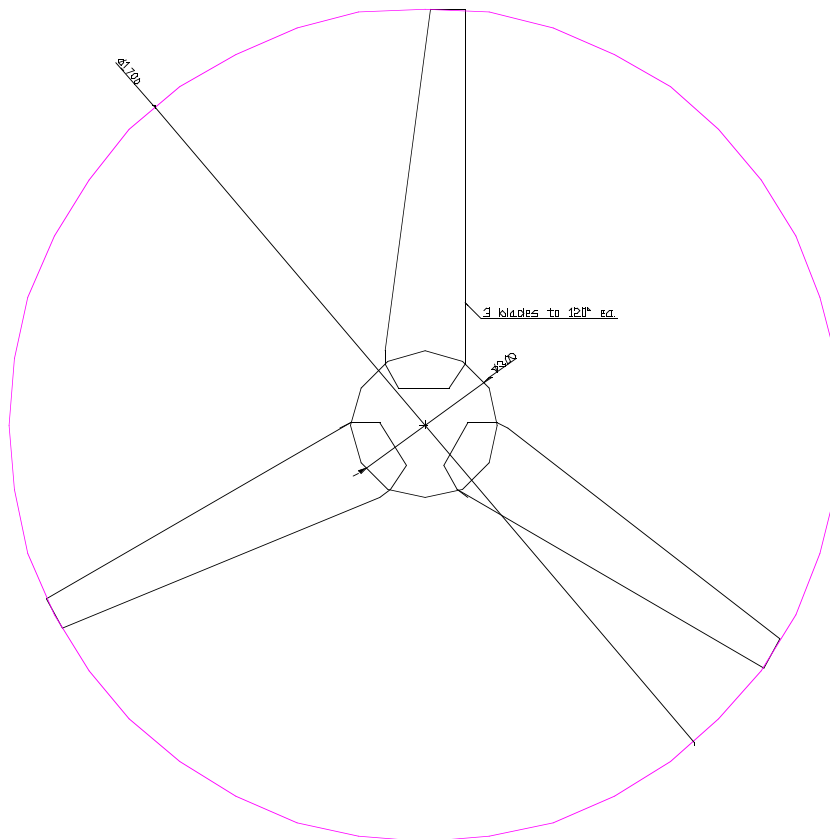
## Wind rotor blade construction

Small Wind Systems for Battery Charging

Contract R 7105

---

By Teodoro Sanchez Campos ITDG,  
Sunith Fernando and  
Hugh Piggott



In association with : ITDG-UK; ITDG Peru and ITDG South Asia

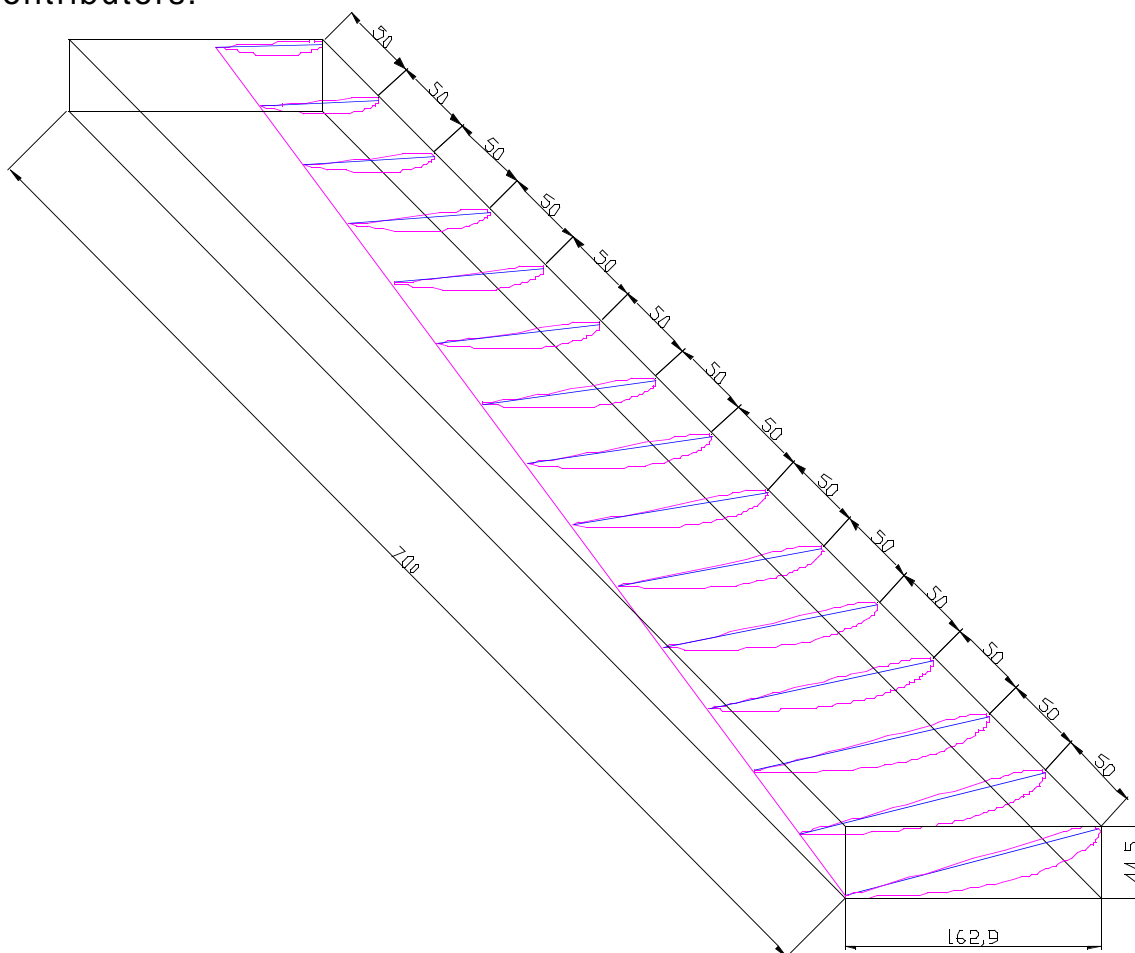
This research on small wind energy systems for battery charging is the result of a collaborative effort involving numerous contributors.

The project was managed by Intermediate Technology (known as The Intermediate Technology Development Group or ITDG) under a contract to the UK Department for International Development.

The overall international project was co-ordinated by **Dr Smail Khennas**, Senior Energy Specialist from ITDG with support from Simon Dunnett. The field work in Peru and Sri Lanka were respectively managed by Teodoro Sanchez and Rohan Senerath.

Teodoro Sanchez Campos (ITDG Peru), Sunith Fernando (Sri Lanka) and Hugh Piggott (a UK technical consultant for the project), are the authors of this booklet on the rotor blade manufacture.

The views expressed in this report are those of the authors and do not necessarily represent the views of the sponsoring organisations, the reviewers or the other contributors.



This diagram shows the shape of a blade pattern.

---

# Wind rotor blade construction

Small Wind Systems for Battery Charging

---

## CONTENTS

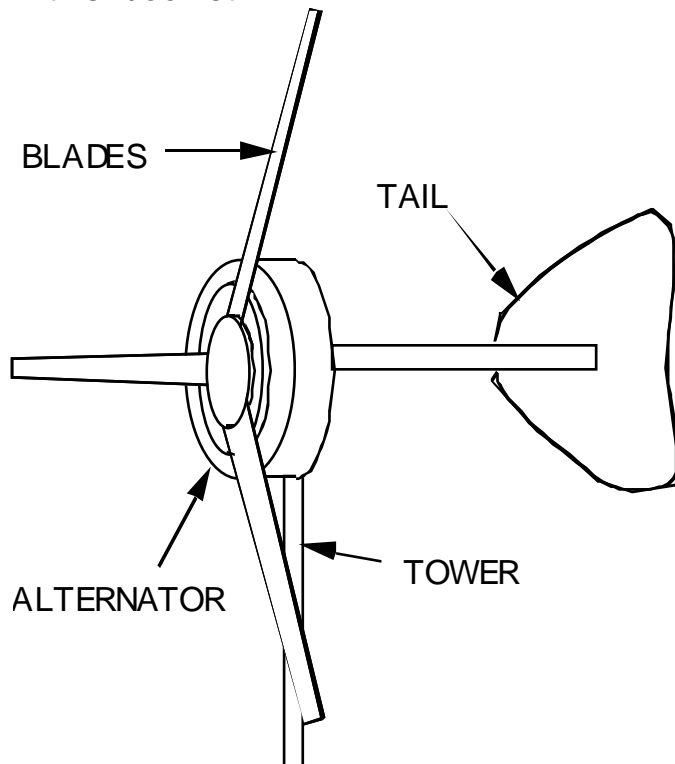
1. Introduction.....	4
The wind generator	4
Steps in the wind rotor construction procedure	4
The two rotor designs	5
The shapes of the blades	7
2. Templates, Patterns and Moulds .....	8
Templates	8
Patterns	8
Making two separate patterns	9
Finishing of the surface.	10
An alternative idea : making patterns from metal	10
Making the moulds	11
3. Blade construction.....	13
The procedure in Peru is as follows.	13
4. Testing for strength.....	15
5. Balancing and mounting.....	16
Balancing the rotor	16
Mounting the rotor blades	17
Appendix I :Blade design details .....	18
Sri Lanka K2 blade design by Sunith Fernando	18
Peru NACA4412 blade designed by Teodoro Sanchez	18

# 1. Introduction

## **The wind generator**

This booklet is to assist manufacturers in make the blades, or 'wind rotor' for a small wind generator. Another booklet tells how to build the permanent magnet generator (PMG). The wind rotor will be fitted to the PMG. It turns the PMG, and the PMG charges a battery.

The PMG and rotor blades have to be mounted on a 'yaw bearing' at the top of a tower (usually made from steel pipe). The wind generator also needs a tail to make it face the wind. The tail must also automatically turn the wind generator away from strong winds to protect it from damage. The yaw bearing, tail and tower are not described further in this booklet.

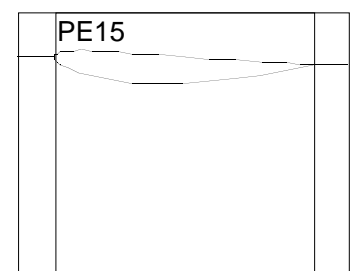


The wind generator is suitable for family needs such as lighting and radio, powered by a 12-volt battery. It is for low and medium windspeeds, common in Peru and Sri Lanka, where the wind turbine is being built.

The blades described in this book are made from fibreglass, (although would also be possible to make them from wood.)

## **Steps in the wind rotor construction procedure**

1. Choose a design for the blades, and make templates from paper or thin aluminium sheet. Copy the drawings



in Appendix II for the templates. The templates will fit the outside of the blades exactly.

2. Use these templates to make a three dimensional pattern in the shape of the actual blade. One can carve a pattern from wood. Or metal sheet or foam could be used instead.
3. Around the pattern, cast fibreglass moulds. We might make enough moulds for a full set of blades for one rotor (three moulds for a three bladed rotor).
4. Use the moulds to make the blades.
5. Make a hub for the blades and assemble the rotor.

If the production team have no experience with fibreglass resin, they may need to ask an expert for help.

We will need to test the strength of the blades, and balance them, so they will be safe and run smoothly.

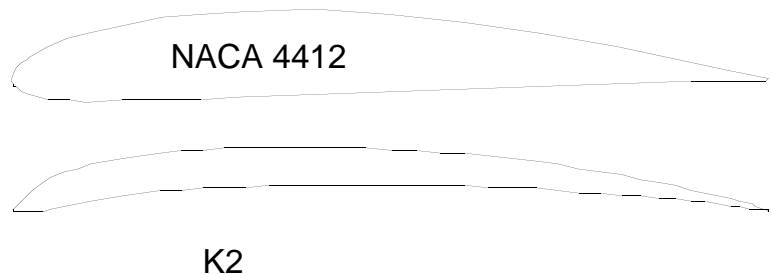
### **The two rotor designs**

Here are the main features of the two rotor designs described in this booklet:-

Country of origin	Peru	Sri Lanka
Designer	Teodoro Sanchez	Sunith Fernando
Blade section	NACA 4412	K2
Diameter	1.7metres	2.0metres
Tip speed ratio	5	6
Number of blades	3	2

#### **SECTION**

The 'blade section' is the shape of the blade in cross-section (cut at 90 degrees). The NACA4412 section is made from two skins with space between. The K2 section can be solid fibreglass resin.



#### **DIAMETER**

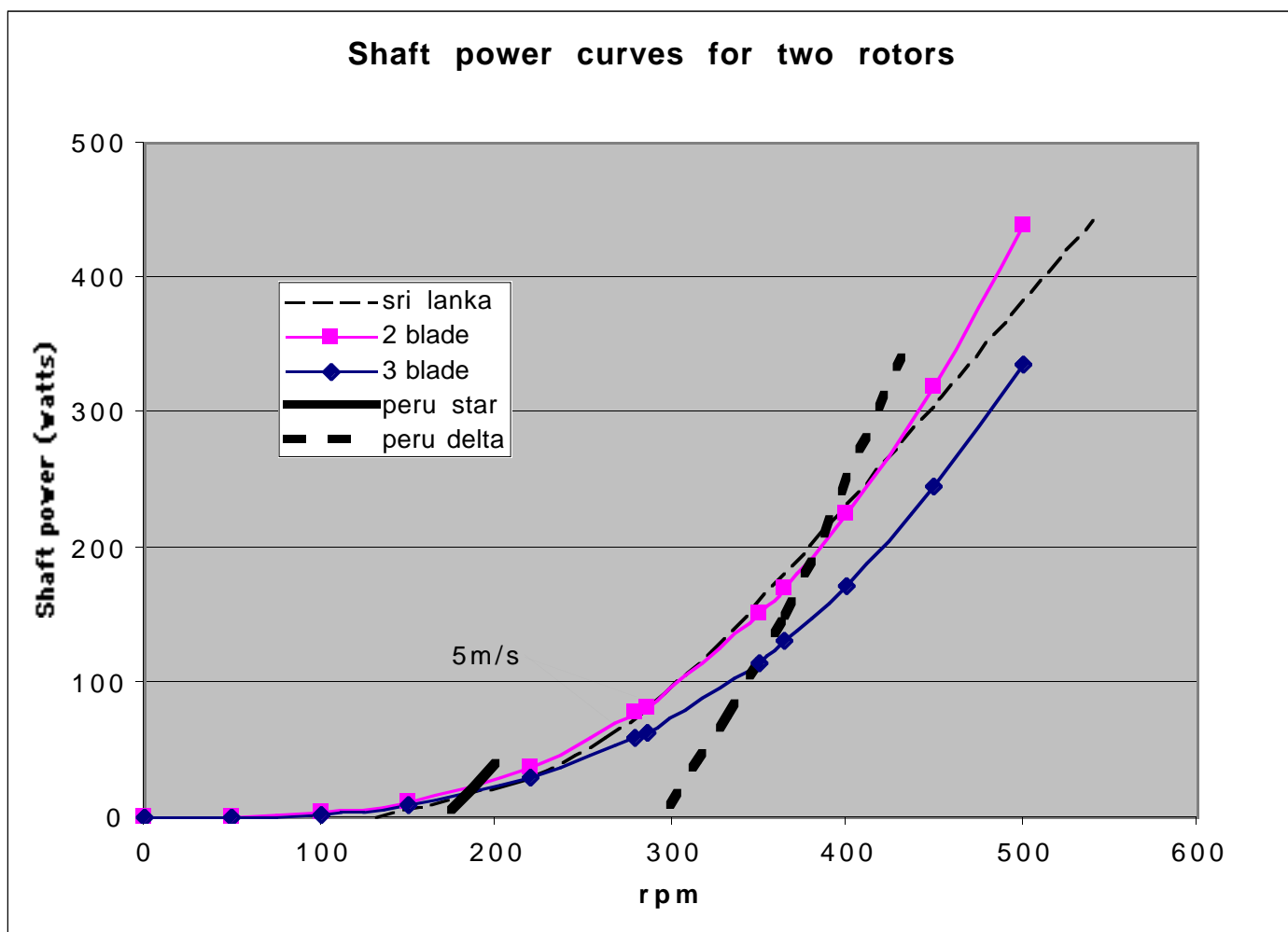
The larger, 2.0 metre diameter rotor will sweep across more wind, and therefore it can produce more power, in a given windspeed.

#### **TIP SPEED RATIO**

The 'tip-speed-ratio' is the speed at which the blade tip should run compared to the windspeed. The shaft speed in revolutions per minute (rpm) depends on the tip speed and the diameter.

$$\text{Rpm} = \text{windspeed} \times \text{tip-speed-ratio} \times 60 / (\text{diameter} \times \Pi)$$

The main reason why the two blade rotor can work at higher tip-speed-ratio is that it only has two blades. The smaller, three bladed rotor will have a slower tip-speed, but will run more smoothly because it has three blades.



Each rotor is carefully designed to work well with the PMG used in each country. The PMG used in Peru has thicker magnets and a different way to connect the windings. Above is a chart of the power produced by the two rotors over a range of speeds (based on the theory). The chart also shows how much power is needed to drive the alternators in Sri Lanka (dotted) and Peru (two curves for two connections). The 2-bladed rotor (purple) designed in Sri Lanka produces exactly the power required for the alternator used in Sri Lanka. The 3-bladed rotor (blue) from Peru is designed to match the two different cases for the Peru alternator : star connected and delta connected.

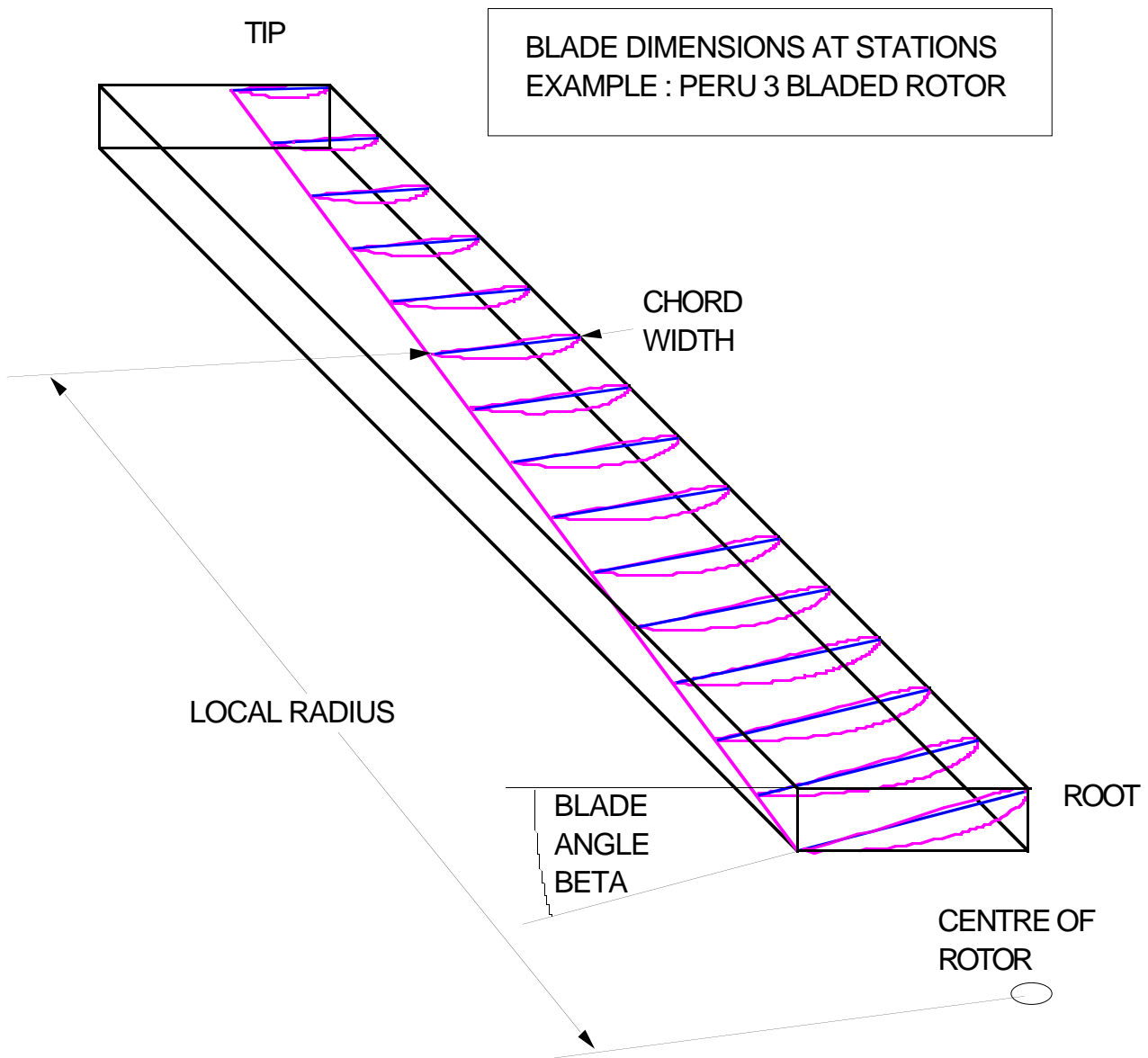
At a windspeed 5 metres/second, the two rotors will produce 80 watts and 60 watts of mechanical (shaft) power respectively at 286 and 280 rpm respectively. This point is marked on each curve.

The speed of the wind rotor depends on how it is loaded. If the PMG is disconnected from the battery, the rotor will become unloaded and will run much faster. We try to avoid running the wind rotor unloaded, because it is noisy and stressful.

## The shapes of the blades

The dimensions of the blades are listed in Appendix I. The blades are defined at a number of 'stations'. SEE FIGURE 'BLADE DIMENSIONS AT STATIONS' BELOW. Each station has a 'local radius', which is the distance of the station from the centre of the rotor. For each station there is a 'chord width', which is the width of the blade, from one edge to the other.

The 'chord line' is defined as the longest line within the blade section, and it joins the leading edge to the trailing edge. The 'blade angle' (beta) is the angle between the chord line and the plane in which the rotor spins. Given the local radius, chord width and blade angle at each station, we can construct the shape of the whole blade. This is done in Appendix II.



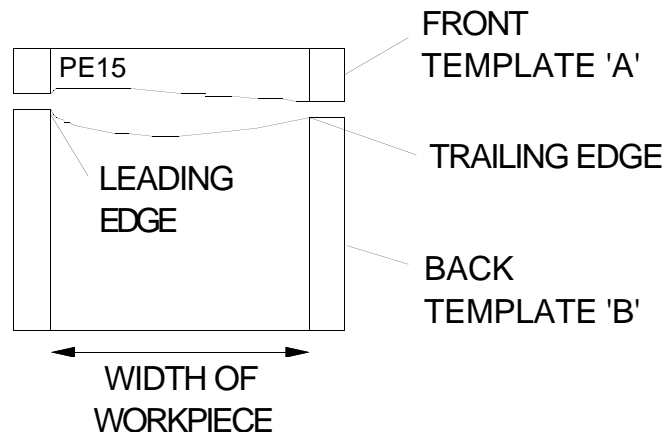
At the root, the shape of the blade changes from an airfoil section into a shape which is suitable for the hub assembly

## 2. Templates, Patterns and Moulds

### Templates

Choose a blade design and make photocopies of the templates in Appendix II. Either cut out these copies and use paper templates to make the pattern, or alternatively use thin aluminium sheet for the templates.

Transfer the shape to the aluminium sheet using carbon paper to trace it, and/or using a punch through the paper to mark the aluminium with the lines.



Each template drawing has 3 areas within it:

1. A blade section (remove this)
2. A front template A
3. A back template B (turn it over and use it when carving the back of the pattern)

The vertical lines on the template show the width of the workpiece for the pattern after it has been tapered. The angle of the blade section is the exact blade angle. The top edge of template A is exactly 10mm from the top surface of the blade. The bottom of template 'B' is 60mm below the top surface.

### Patterns

The pattern is an object which is exactly the shape of the blade. Use it to make moulds for the blades. There are various ways to make a pattern. It can be made from wood. This is normal. However, wood can warp, and change its shape. It is important to choose a very stable wood. In Peru they have used Coava, which is a hard wood with good stability.

Sunith Fernando in Sri Lanka tried a wooden pattern initially but warping became a problem. "For K2, which is a slender profile, I made the pattern out of two materials. First I got a steel sheet (~ 0.8 mm thick) rolled into K2 outer profile – more or less, and then filled the inside with a paste that we use to fill up dents of automobile bodywork (we call it Cataloy paste). I used the paste to fill up the outer profile also as a thin layer. Then I filed the hardened cataloy paste to the required profile. Thereafter, I got the blade pattern cast in aluminium. It is the aluminium pattern that I gave for fibreglass work."

For the construction of the wooden pattern follow this procedure:

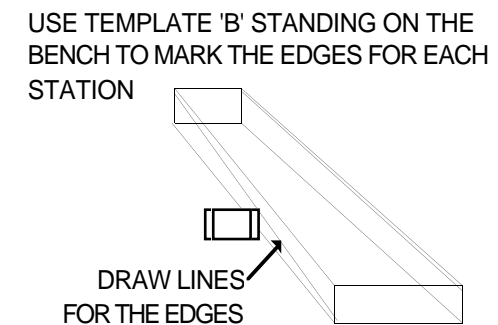
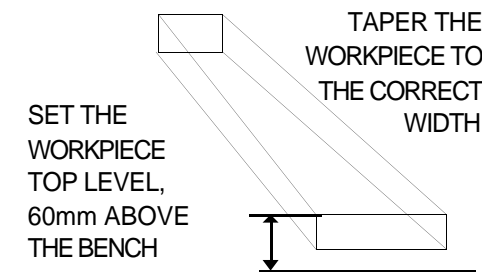
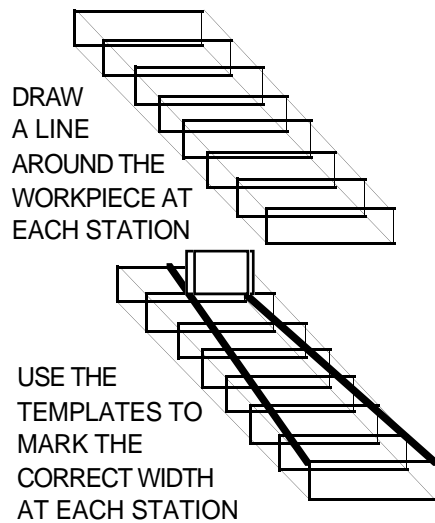
- a). - Buy a rectangular block of wood 45mm x 165mm x 700 mm. The wood should be dry enough before starting the work of carving.



b)- Mark the position of each station. Then draw two lines along the wider faces using the 'workpiece width' on the templates, and cut the wood to the correct width at each station.

c)- Use the templates to mark a leading edge line and a trailing edge line. These are the lines where the two moulds will meet. Here is how to mark these lines: The top of the workpiece should be 60mm above the level of the bench. The right hand side of each template 'B' is the trailing edge. Place it on the bench, against the left hand side of the workpiece as shown, and mark the trailing edge. Do this at each station and then do the same for the leading edge.

d)-Then carve the curved shape of the blade pattern, checking very carefully with the templates at each station.



The templates in Appendix II are printed in such a way that one should look at them from the tip of the blade inward. Place the template over the workpiece at its

station. When the pattern is finished, the top edge of the template should be exactly level, and the leading and trailing edge lines should meet the lines drawn earlier on the sides of the workpiece.

### **Making two separate patterns**

The moulds for the blades will be made in two pieces: one for each side of the blade. It is possible therefore to use two patterns instead of one, one for each mould. If there are two patterns, they do not have to be thin, like the blade itself. They can be made from big thick pieces of wood, which will not easily warp.



The photo (last page) shows a pattern being carved from a wooden workpiece which has been built up out of three pieces of wood glued together.

### **Finishing of the surface.**

The finishing of the surface is an important feature because the quality of the surface of the blades will depend on that, therefore it is recommended to use some substance to feel tiny imperfections of wood, and later polish the surface until it looks as regular as possible, paint the pattern and polish again until it is soft enough or good enough to be used as a pattern.

### **An alternative idea : making patterns from metal**

First I must state that this idea has not been tried at the time of writing. It is possible to make patterns for the blades using sheet metal wrapped over metal formers (support pieces). Make two patterns - one for each mould. One is for the back of the blade, and one is for the front.

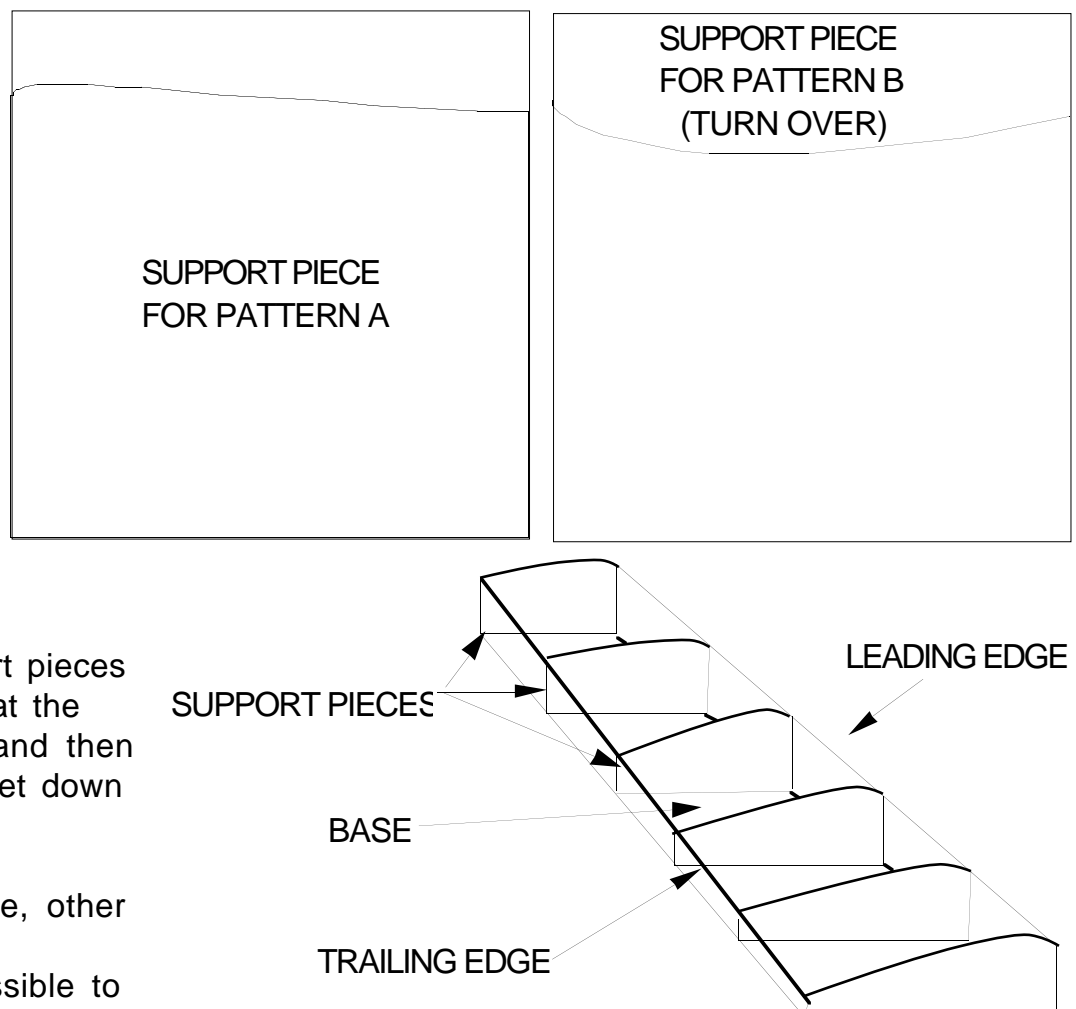
Cut out the support pieces using the template shapes in Appendix II.

They will be used to support the pattern surface sheet, rather than just to check its shape.

Glue all the support pieces onto a level base at the correct spacings, and then glue a surface sheet down onto them tightly.

There are yet more, other ways to make the patterns. It is possible to make them from foam, cut with a hot wire. This method is popular with model makers.

Probably the simplest method is to carve them from wood, as described above.



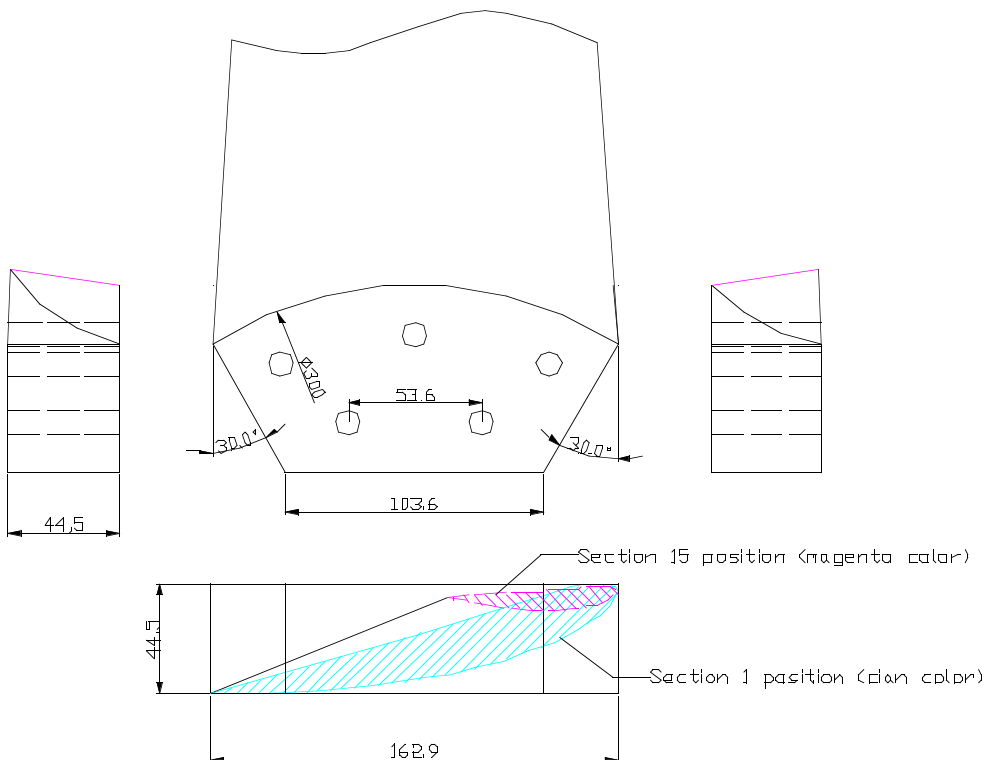
## Making the moulds

In Peru, the moulds were manufactured in fibreglass. “The mould is done in two pieces, therefore it is convenient to be careful with splitting the blade into two parts, (or with the splitting line)

“The moulds can be of different materials, resin and fibreglass is always a good option, however it does not have a long life, it is expected that each mould can be useful to produce up to 50 or 60 units of blades.



“Therefore in some cases it would be preferable to use metal ones. Aluminium is a good alternative and it is widely used for fibreglass products.”



The blade root needs to be shaped to mount easily onto the wind generator. In Peru the root shape is as shown above. All three blade roots are clamped between two steel plates. The transition between the root (mounting portion) and the blade (airfoil

section portion) is to be made smoothly. Avoid using sharp curves which would weaken the fibreglass.

The moulds for the Sri Lankan blades are shown to the right. They were made in fibreglass on an aluminium pattern. One side of the K2 mould is convex, because the upwind side of the blade is to be concave.

### **The two halves of the mould**

When making the first half of the mould, use only one face of the pattern. Make a flat surface around the edges of the pattern which will later become the faces where the two moulds will meet. This can be done with fibreglass resin, wood or plasticene or any material which is easy to work. Take care to follow the edges of the pattern very exactly. When the first half mould has been made one can destroy this flat surface.

It is a good idea to make two holes in the flat surface at the edge of the first half, so that the second half will have two lumps. Later, we will fit the two halves of the blade together inside the moulds. If the lumps are in the holes then the two halves are correctly lined up.

When making the second half of the mould, place the first half against the other side of the pattern. Polish the flat surface around the edges, in the same way as the pattern, so that the fibreglass resin will not stick to it. Make the second half of the mould cover the pattern and also the flat surface, so that the two moulds fit each other perfectly.

If there will be two separate patterns for the two halves of the mould, take great care that the final blade will be the correct shape when the halves are put together. It would be easy to alter the thickness of the blade by inaccurate patterns.

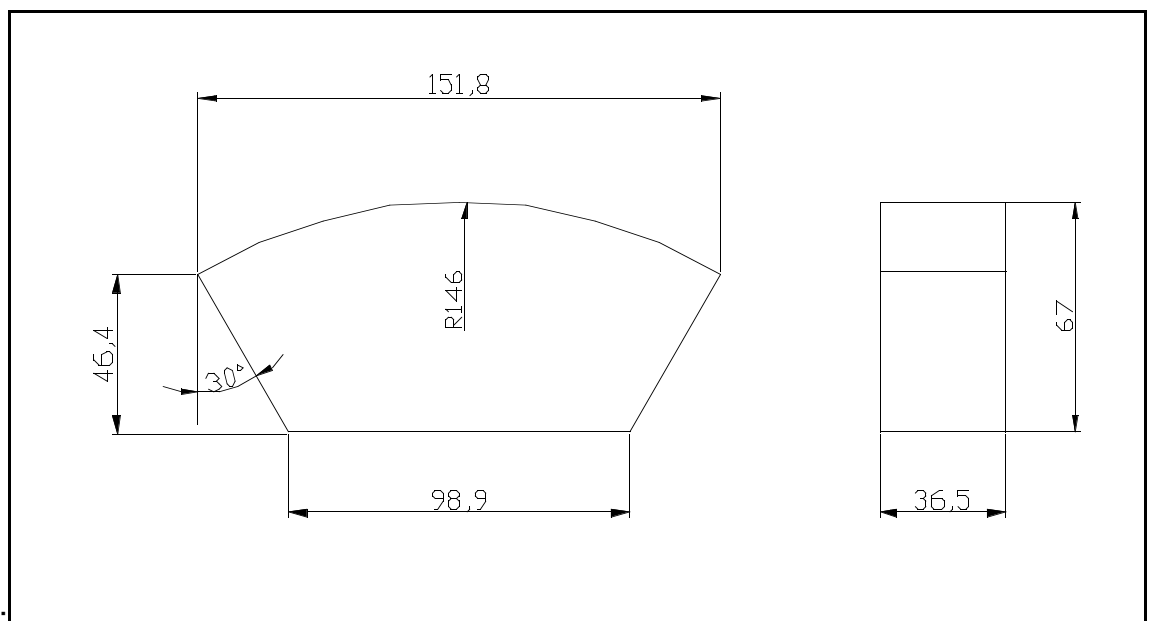


### 3. Blade construction



**The procedure in Peru is as follows.**

- a) The mould should very clean before using the resin and fibreglass. Use alcohol or other solvent to clean it.
- b) Use some substance to facilitate the mould separation from the blade when it is ready.
- c) Paint a thin layer of resin in each side of the mould, then a layer of fibreglass (approximately 1mm).
- d) Again a layer of resin on top of the fibreglass, and so on until there is approximately 3 to 4 mm thickness
- e) In the root end of the blade it is possible to use a piece of wood (see diagram below) in on top of one of the sides in order to lower the quantity of fibreglass and resin.
- f) Also in the root of the blade there should be holes in order to assemble the blades to the central hub.



Wood:

g) Once the 3 to 4 mm of fibreglass have been placed each side of the mould, the next step is to join the halves and tie them together. It is advisable to put some resin in the borders of the moulds in order to fill all the small gaps.



h) Finally, after joining the two pieces of the moulds, it is necessary to use bolts to clamp it. Leave it to set for about 12 to 15 hours.



On the right is a picture of the finished blades.

The outer portion of each blade is hollow. The Sri Lankan rotor has solid blades.

Another option is to use a foam core inside the blade. This can make it stronger if the bending stress causes problems (see section 4).

The outer layer of the blade (gel coat) must be waterproof, with no cracks or fibres on the surface. If water enters the blade, it degrades the strength and changes the balance. If the piece of wood in the blade root becomes wet and then dry, then the blade root will work loose in the hub mounting.

If the blades run for long periods in strong winds, then the leading edges will be eroded. A special adhesive tape is available for protecting the leading edges. Or they can be repaired with cataloy resin, and re-balanced as part of routine maintenance work.

## 4. Testing for strength

It would be wise to ask an engineer to check the structural design strength of the blades one is building. It is possible to calculate whether the stresses in the fibreglass skin are safe or not. We need to have a safety margin to allow for unexpected events, and for fatigue.

The main stresses on small wind turbine blades arise from centrifugal and gyroscopic forces. The centrifugal force on the blades when they are running at full speed (around 500 rpm) will be approximately 100 times the weight of the blade. If a blade weighs 1.5kg, then the centrifugal force will be around 1.5kN (equivalent to 150kg weight) at this speed. At 1000 rpm the force will be equivalent to 600 kg. This speed could arise if the tail furling system does not work correctly for example.

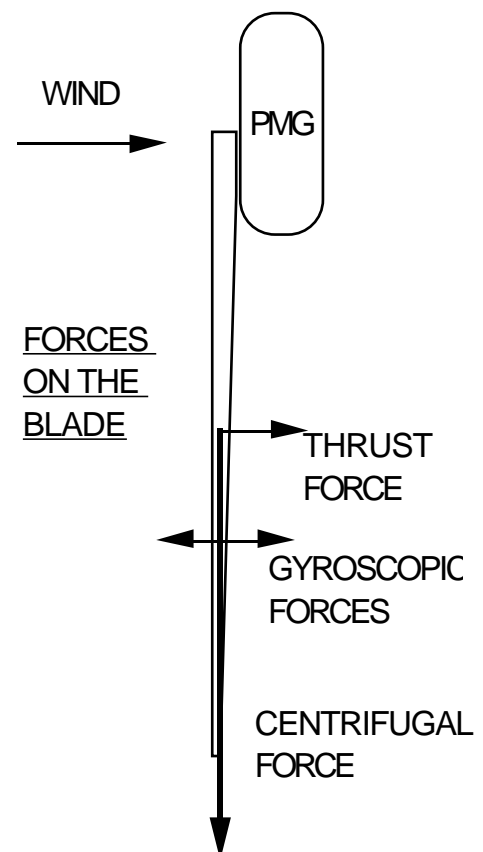
Wind thrust on each blade is only 50-100N (5-10kg). Thrust force imposes a bending stress on the blade, which adds to the stress from the centrifugal force. Gyroscopic bending moments could also be of that order of size (but rapidly alternating).

For peace of mind and safety it would be wise to test a sample blade by hanging and swinging weights on it until it breaks. This will indicate how large the factor of safety is (if there is one).

If there is a problem with inadequate strength in the blades, then increase the amount of fibreglass, especially in the root area. The resin has no real strength except to bond the glass fibres. If possible, use 'uni-directional' fibreglass mat. It may not be easy to find, but it has double the tensile strength for the same weight. This is a big advantage where the main forces are inertial (centrifugal, and gyroscopic).

Blades will tend to crack at 'stress concentrations' where the skin undergoes sharp changes in shape. Try to keep the blade skin smooth and straight in its transition from the airfoil portion to the root portion.

Blade failures are dangerous and very discouraging. When they occur, it may be necessary to recall and reinforce or replace a large number of blades. It is better by far to ensure that the blades are sufficiently strong at the start of manufacture.

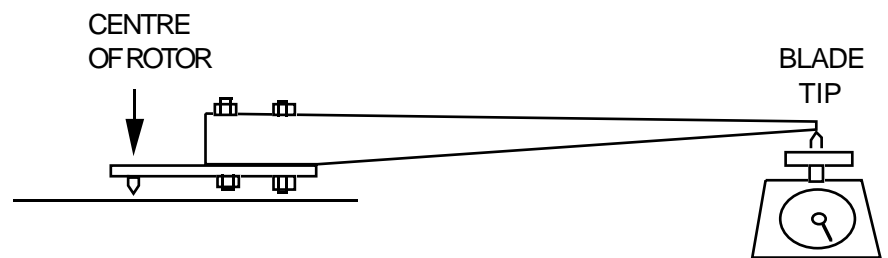


## 5. Balancing and mounting

### Balancing the rotor

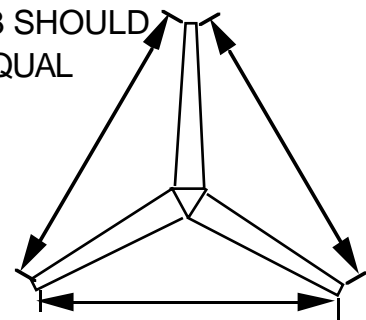
If the wind rotor is not balanced then the wind generator will shake as it spins. After hours and days of shaking, parts will begin to drop off. Usually the tail is first to go. It is important to balance the wind rotor carefully. Here are some steps to balance the rotor blades:

1. Support each blade at the root, and weigh the tip. Each blade should have the same tip weight. In order to do this test accurately we support all of the blade roots in exactly the same way. Make a jig which supports the blade root at the centre of the rotor.



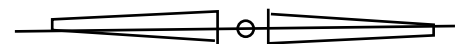
2. Mount the blades on the rotor hub accurately. If there are three blades, then the distance between the blade tips must be the same for each pair. If there are two blades then the line between the tips must pass exactly through the centre of the rotor.

ALL 3 SHOULD  
BE EQUAL



3. When the blades are mounted on the wind generator, check that the tips pass through exactly the same space as they turn. One blade tip should not be in front or behind the others.

LINE PASSES THROUGH CENTRE



4. Use the balancing techniques described in the PMG manual to check the balance of the whole assembly before using it.

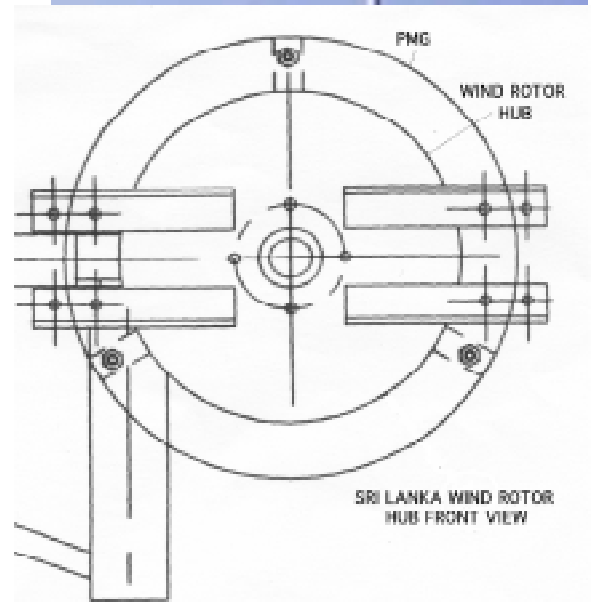
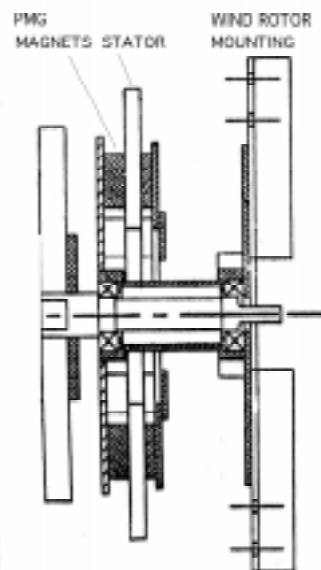


## Mounting the rotor blades

The blades must be securely bolted to a central hub which fits on the PMG. Do not bolt the blades directly to the front magnet-rotor, because the gyroscopic forces on the blades will stress the magnet rotor and cause the magnets to hit the stator.

In Peru, the blades are 'sandwiched' between two steel plates. This makes a simple, strong hub. See also the diagram on the cover of this booklet.

In Sri Lanka, the two blades are bolted into a hub which is constructed as a part of the PMG. The rotor hub is an extra plate welded to the front of the PMG bearing-housing tube. Each blade is cradled between two pieces of steel angle which are welded to the plate.



## Appendix I :Blade design details

### **Sri Lanka K2 blade design by Sunith Fernando**

Blade station	Local radius	Local speed ratio	Flow angle	Actual chord - m	Re Number	Recalc $C_l$	Recalc alpha	Recalc Blade angle beta	Actual beta degrees
1	0.2	1.2	29.1	0.180	7.72E+04	1.76	22.9	6.1	11
2	0.3	1.8	20.3	0.170	1.02E+05	1.38	11.0	9.3	10
3	0.4	2.4	15.5	0.160	1.25E+05	1.15	6.6	8.9	9
4	0.5	3.0	12.5	0.150	1.44E+05	1.00	4.7	7.8	8
5	0.6	3.6	10.5	0.140	1.60E+05	0.90	3.7	6.8	7
6	0.7	4.2	9.0	0.130	1.73E+05	0.84	3.2	5.8	6
7	0.8	4.8	7.9	0.120	1.82E+05	0.80	2.9	5.0	5
8	0.9	5.4	7.0	0.110	1.87E+05	0.77	2.7	4.3	4
9	1.0	6.0	6.3	0.100	1.89E+05	0.77	2.7	3.7	3

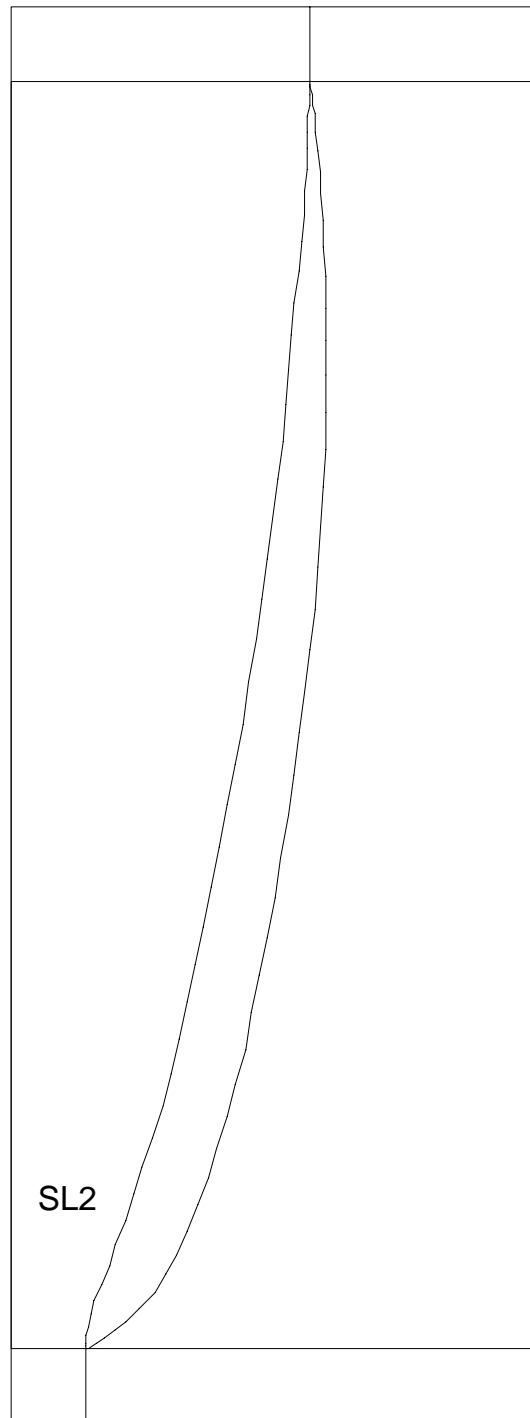
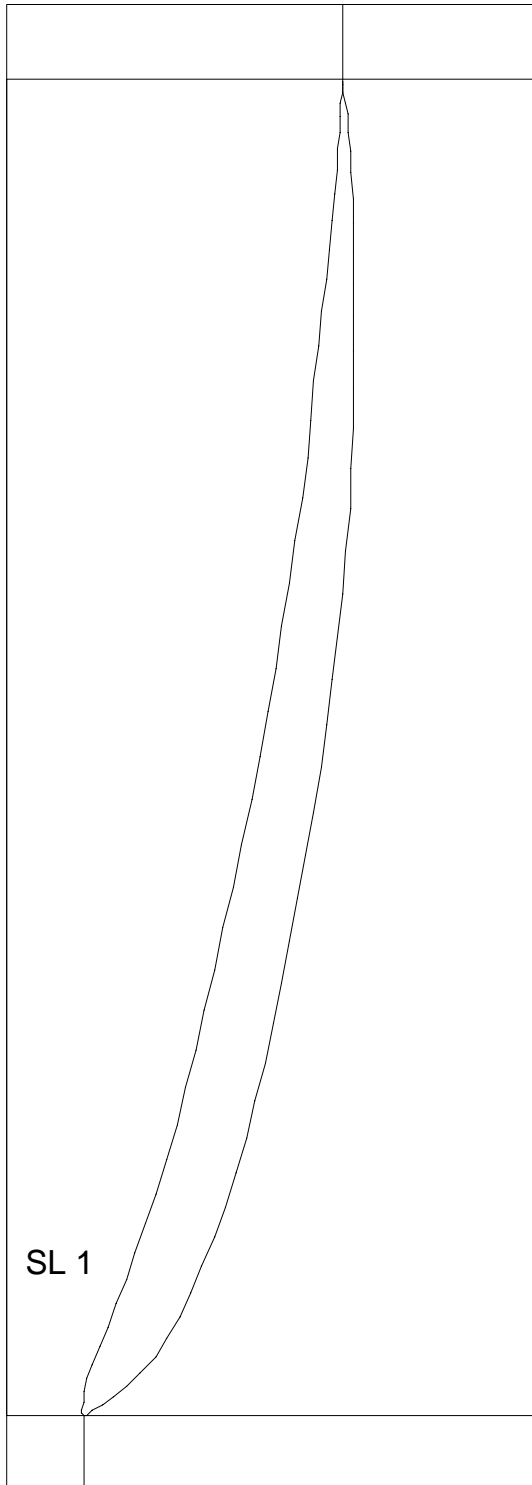
### **Peru NACA4412 blade designed by Teodoro Sanchez**

Blade station	Local radius metres	Chord width metres	Blade angle beta degrees
1	.15	.1679	14.5
2	.2	.1608	13.6
3	.25	.1537	12.7
4	.3	.1466	11.8
5	.35	.1395	10.9
6	.4	.1324	9.9
7	.45	.1253	9.1
8	.5	.1182	8.2
9	.55	.1111	7.3
10	.6	.104	6.3
11	.65	.0969	5.4
12	.7	.0898	4.5
13	.75	.0827	3.6
14	.8	.0756	2.7
15	.85	.0685	1.8

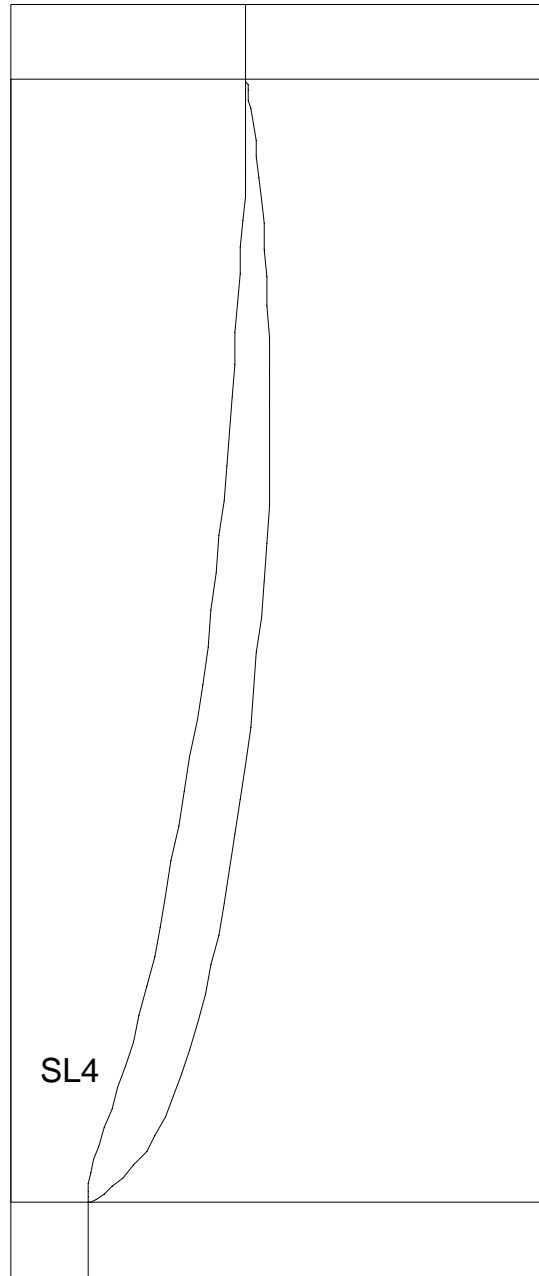
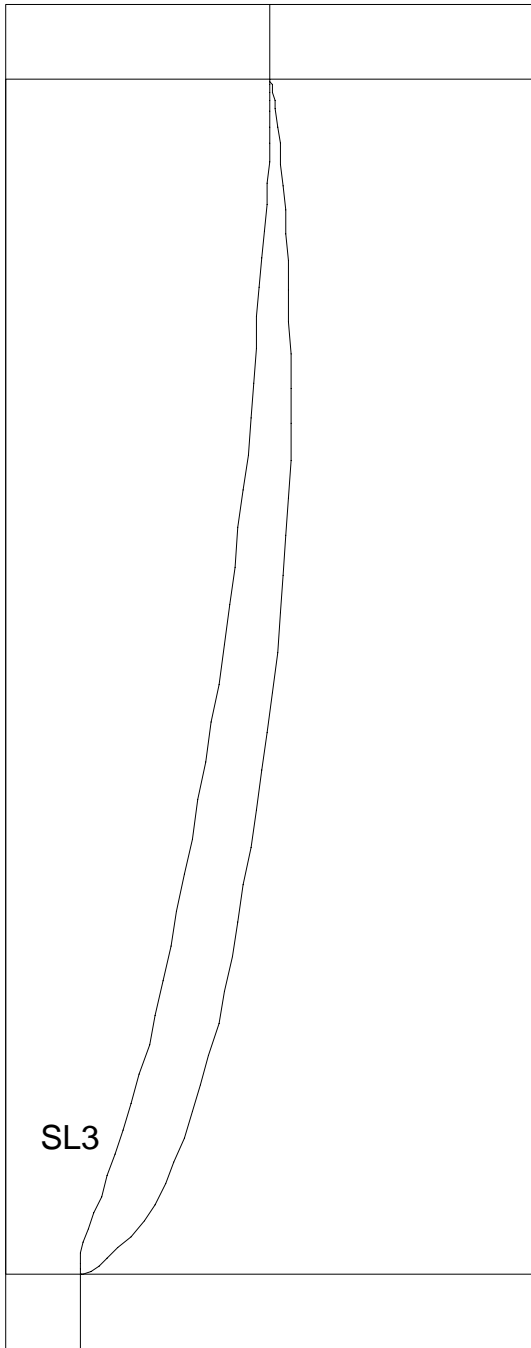
APPENDIX II : BLADE TEMPLATES ACTUAL SIZE

*THESE TEMPLATES ARE VIEWED FROM THE TIP  
LOOKING TOWARD THE CENTRE OF THE ROTOR*

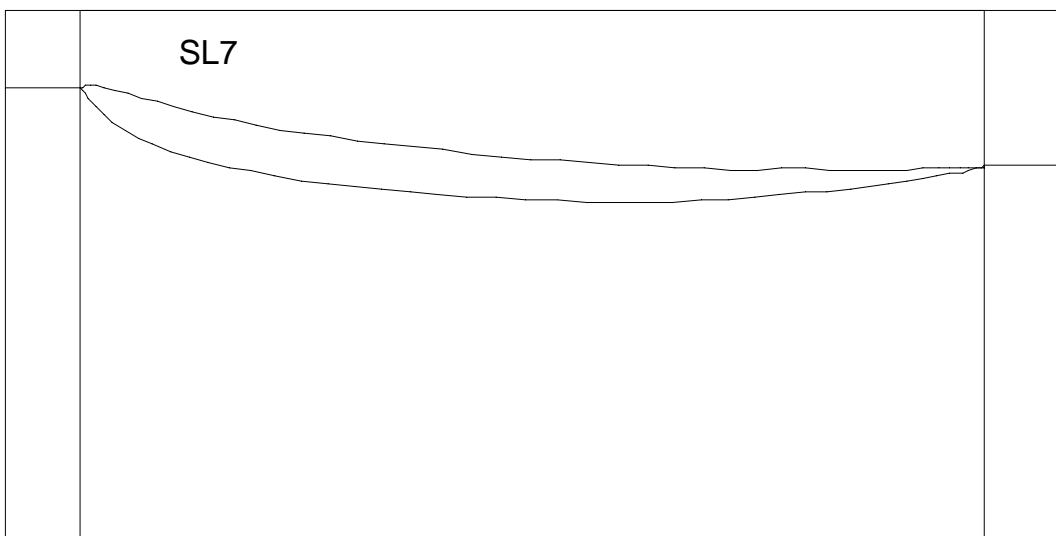
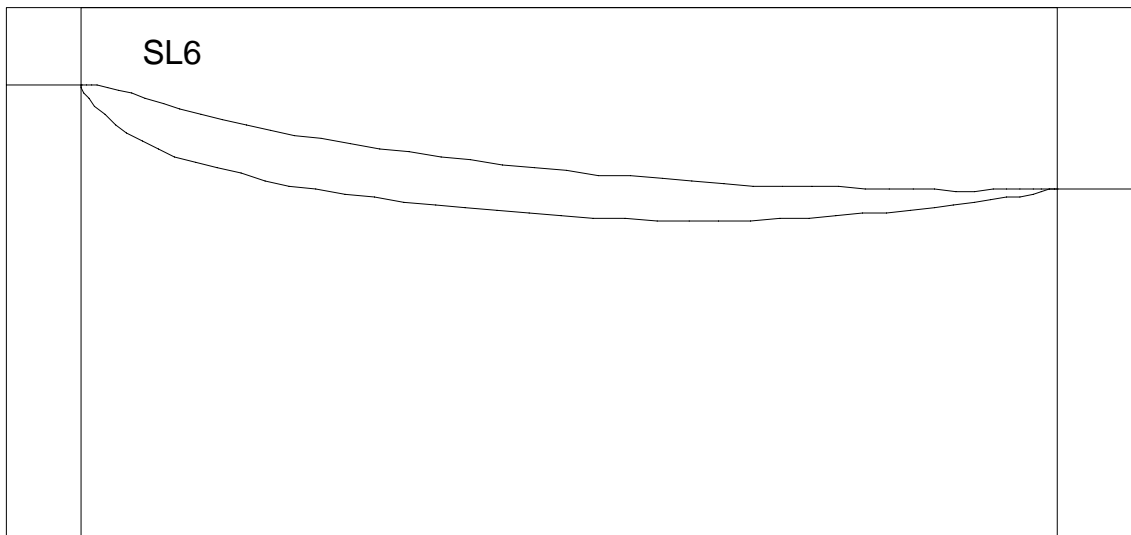
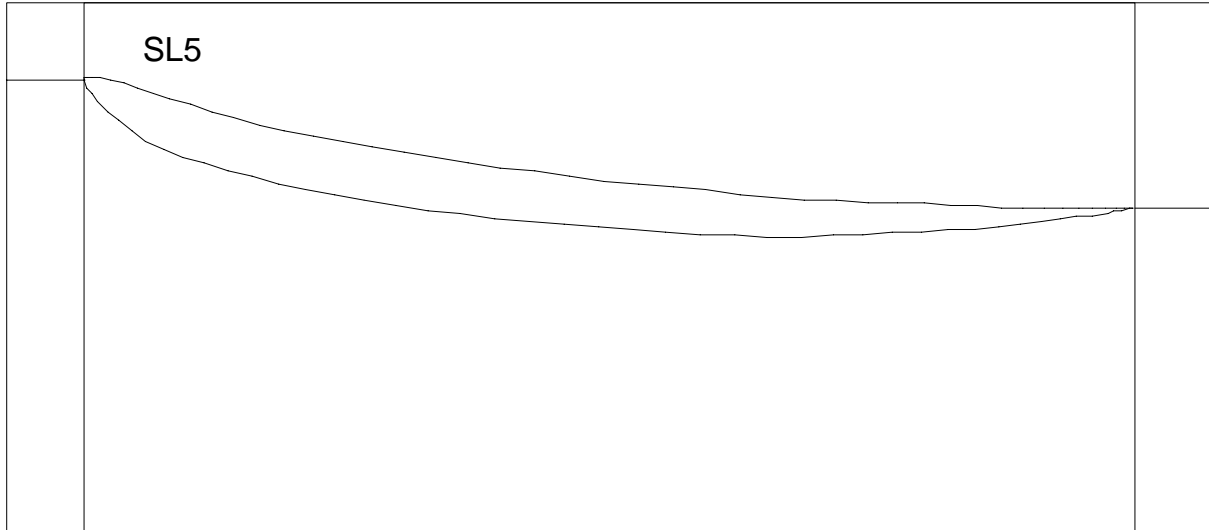
TEMPLATES FOR SRI LANKA 2-BLADE DESIGN USING K2 PROFILE  
- 9 STATIONS -



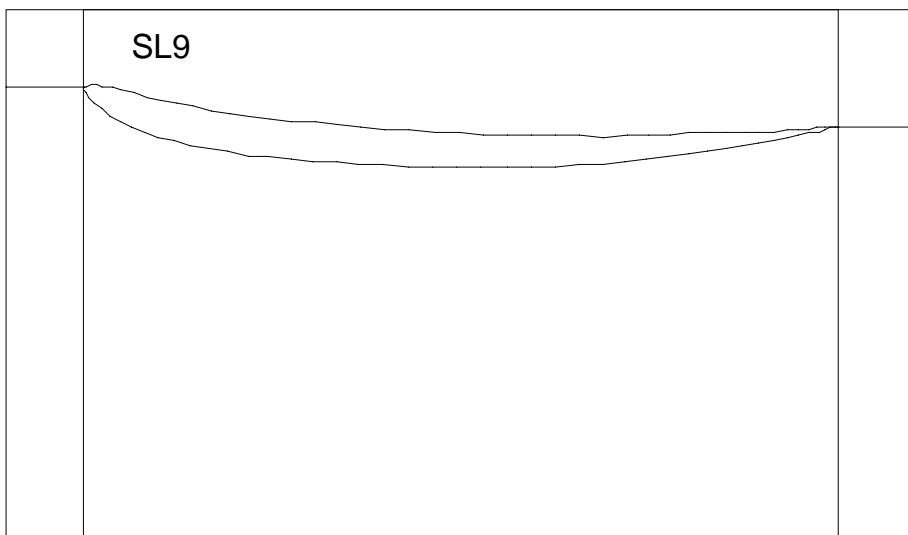
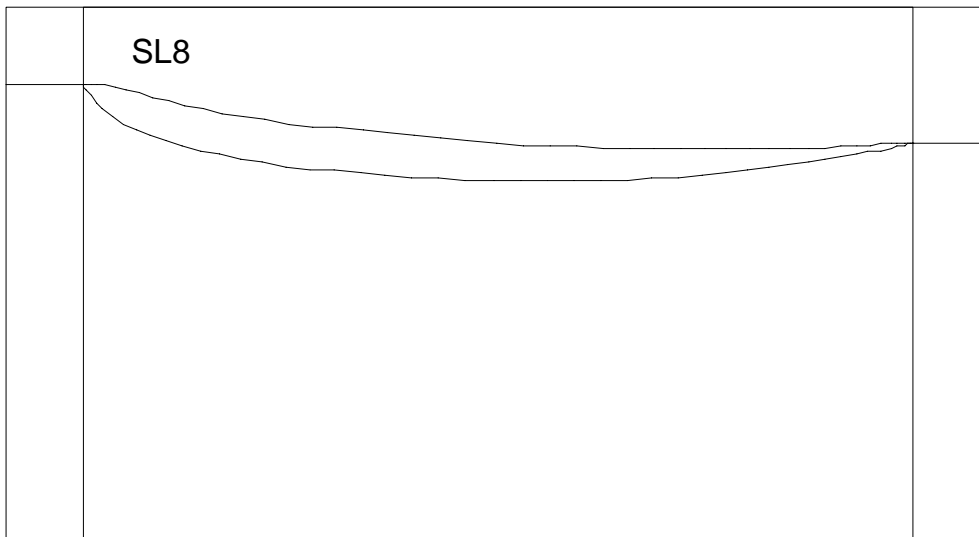
TEMPLATES FOR SRI LANKA 2-BLADE DESIGN USING K2 PROFILE  
- 9 STATIONS -



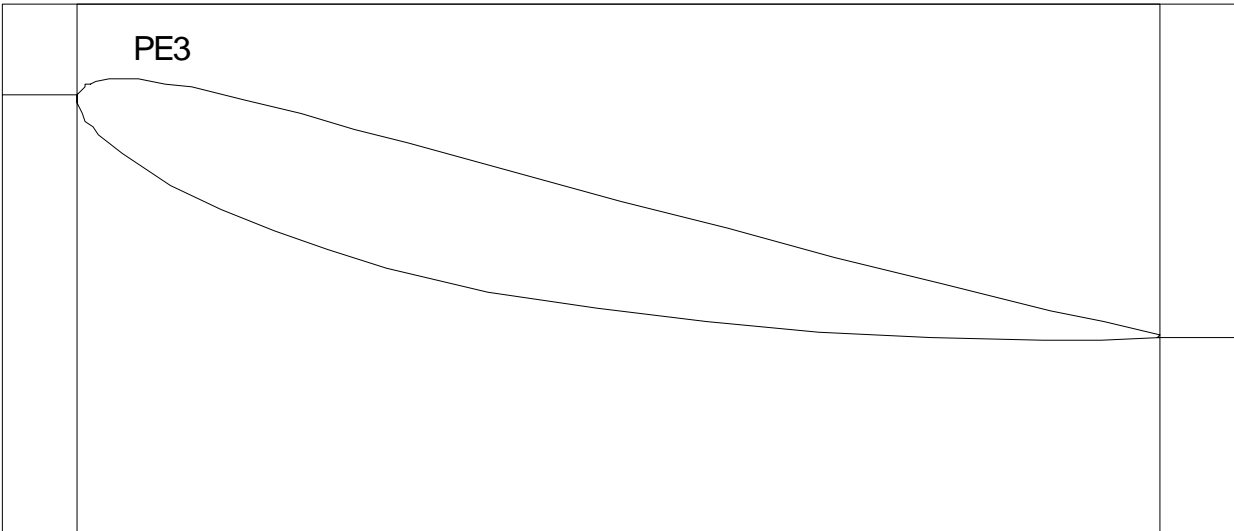
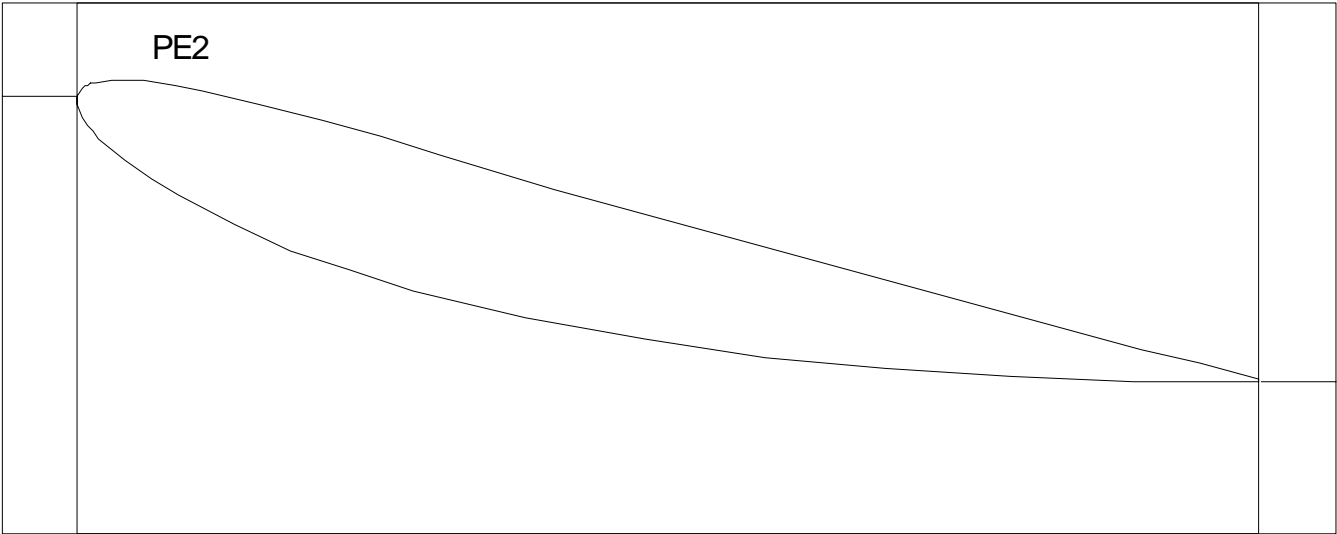
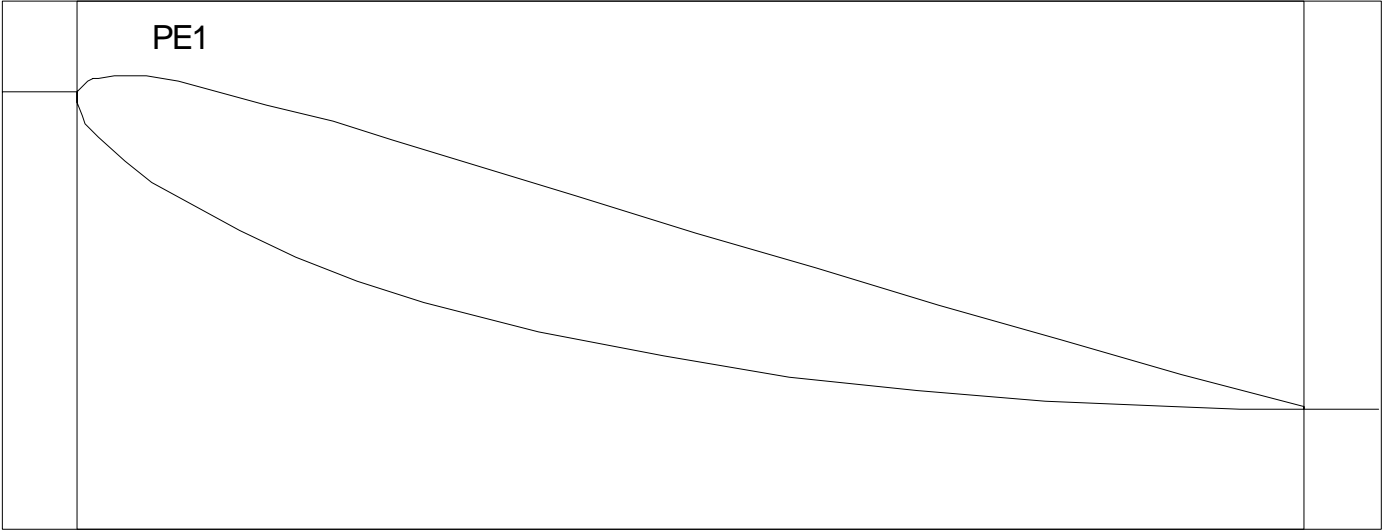
TEMPLATES FOR SRI LANKA 2-BLADE DESIGN USING K2 PROFILE  
- 9 STATIONS -



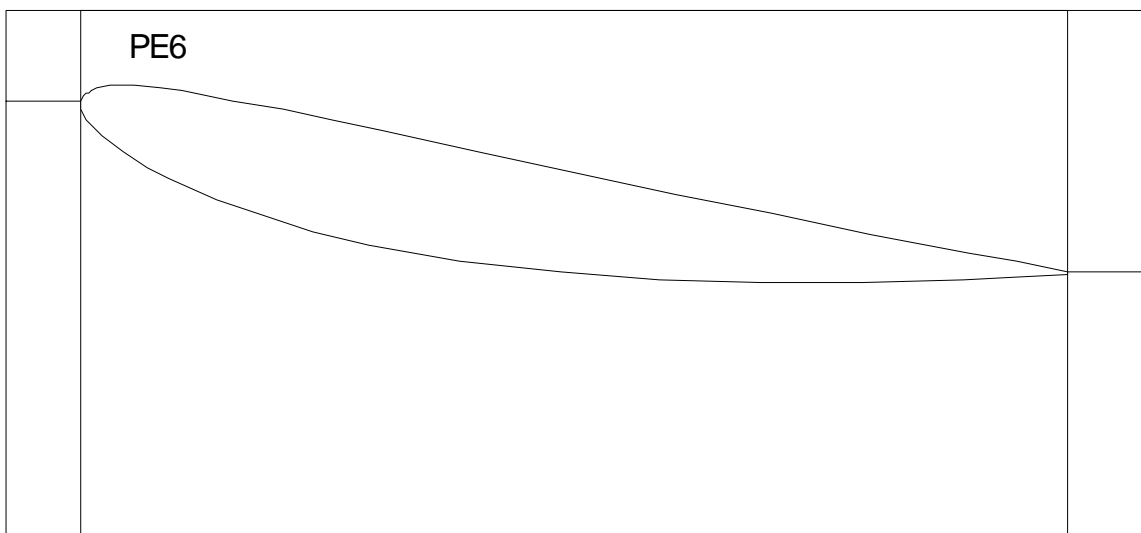
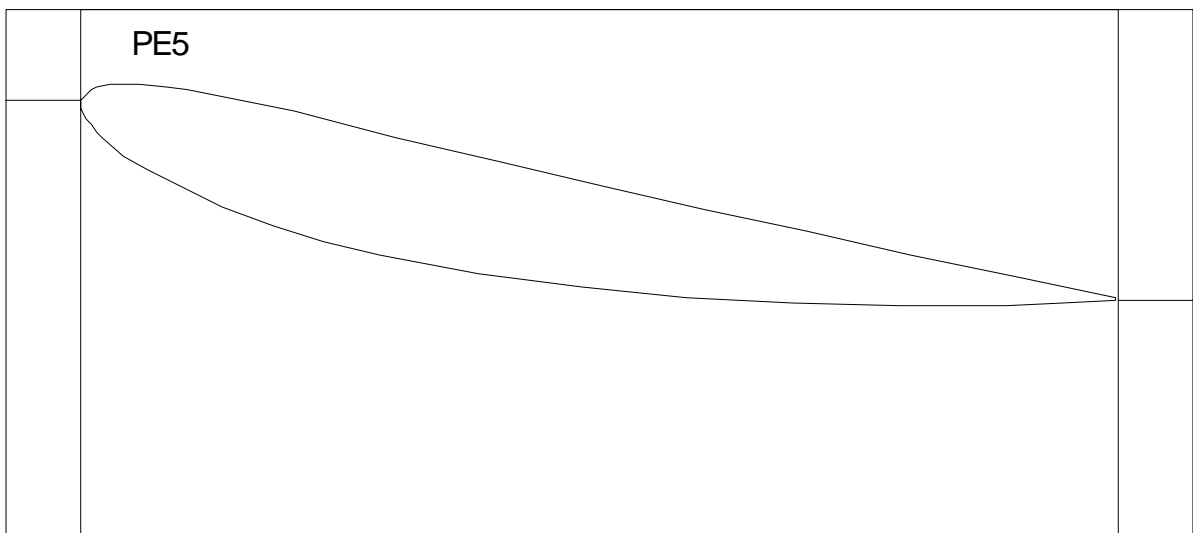
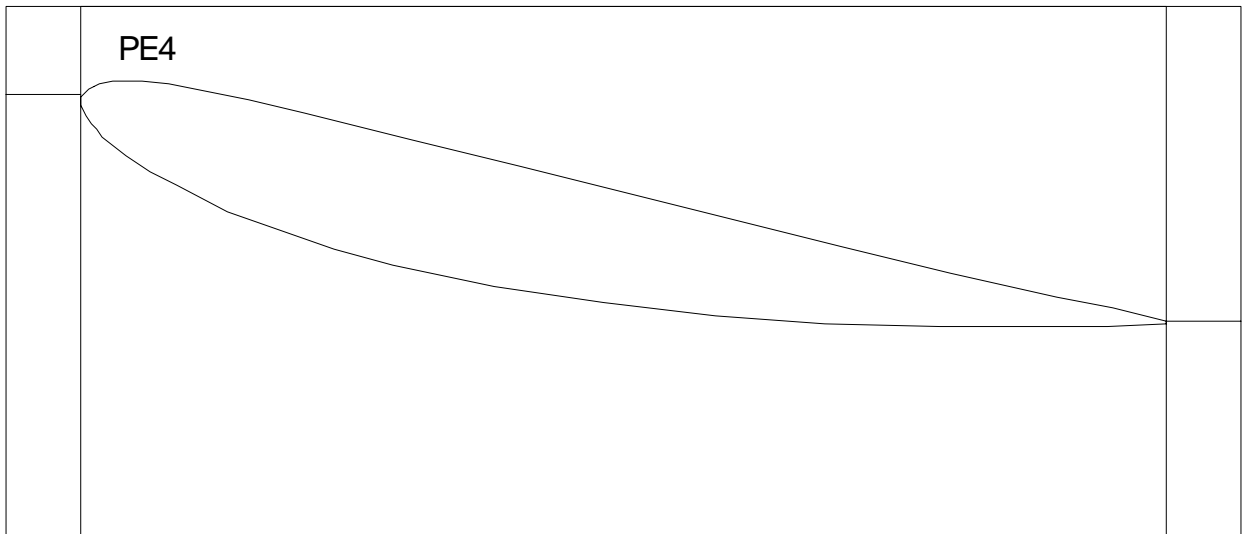
TEMPLATES FOR SRI LANKA 2-BLADE DESIGN USING K2 PROFILE  
- 9 STATIONS -



TEMPLATES FOR PERU 3-BLADE DESIGN USING NACA 4415 PROFILE  
- 15 STATIONS -

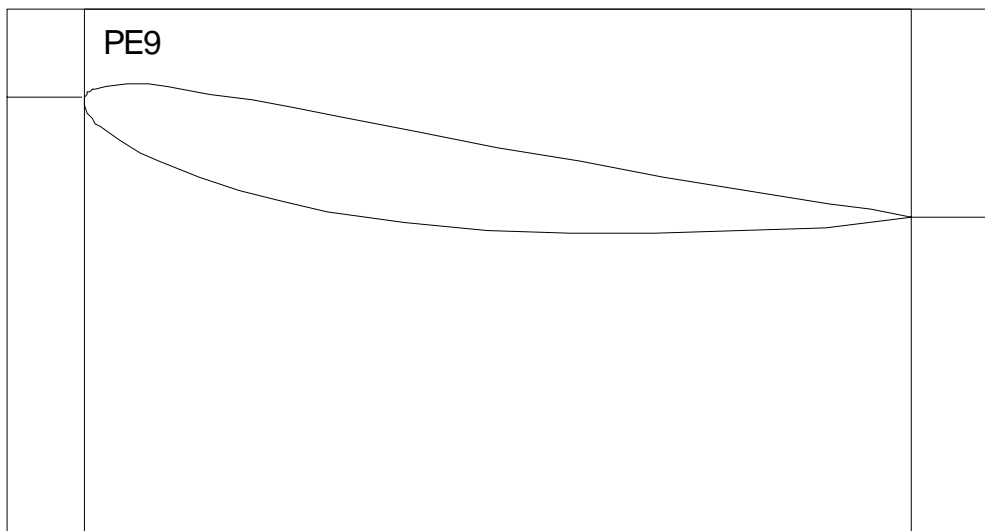
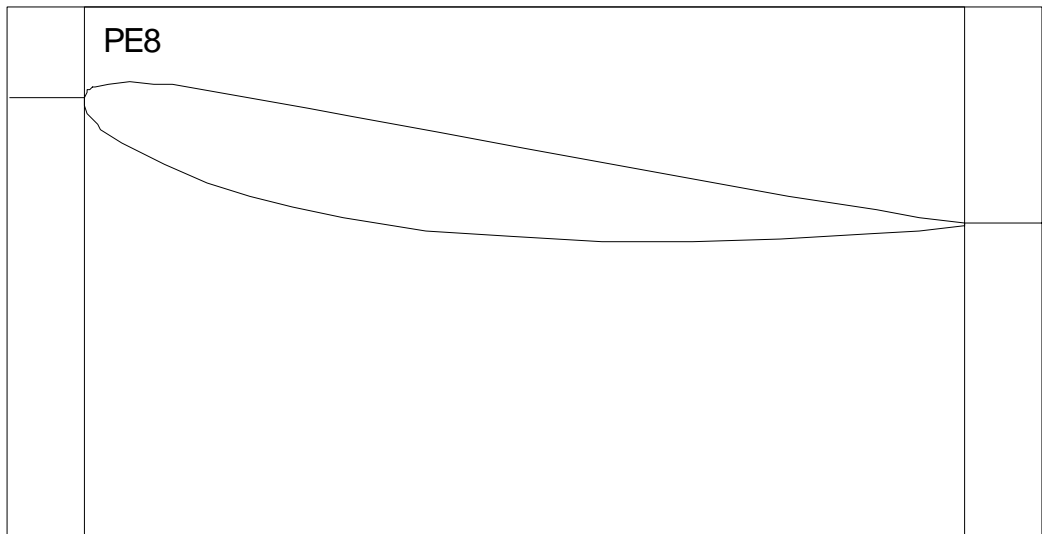
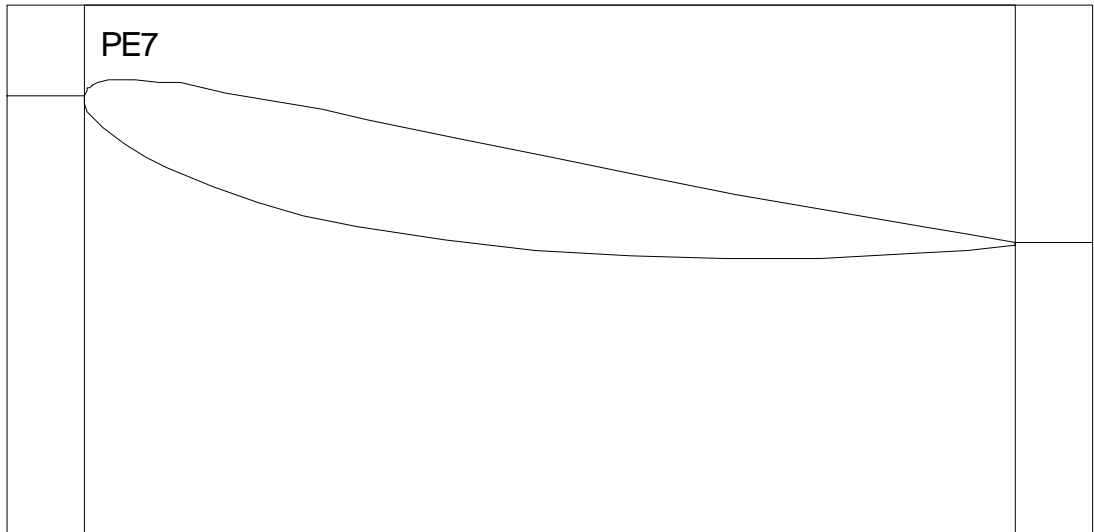


TEMPLATES FOR PERU 3-BLADE DESIGN USING NACA 4415 PROFILE  
- 15 STATIONS -

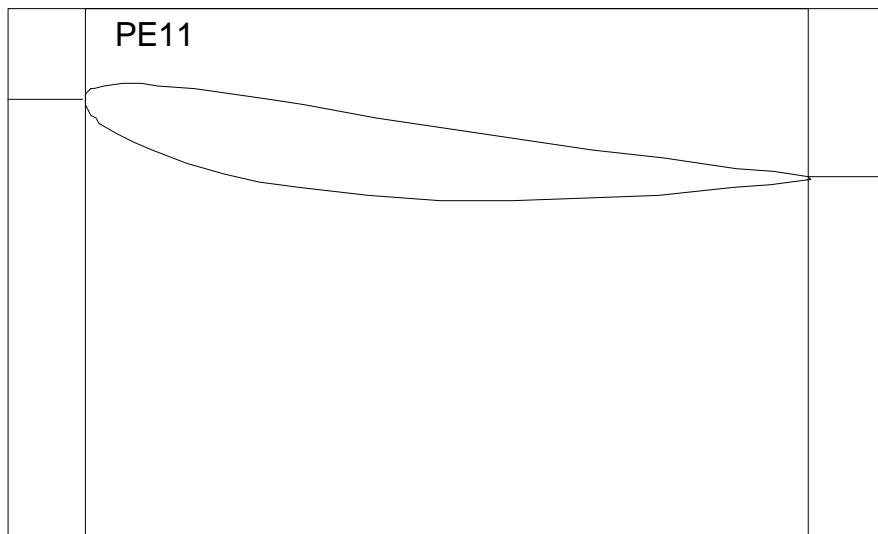
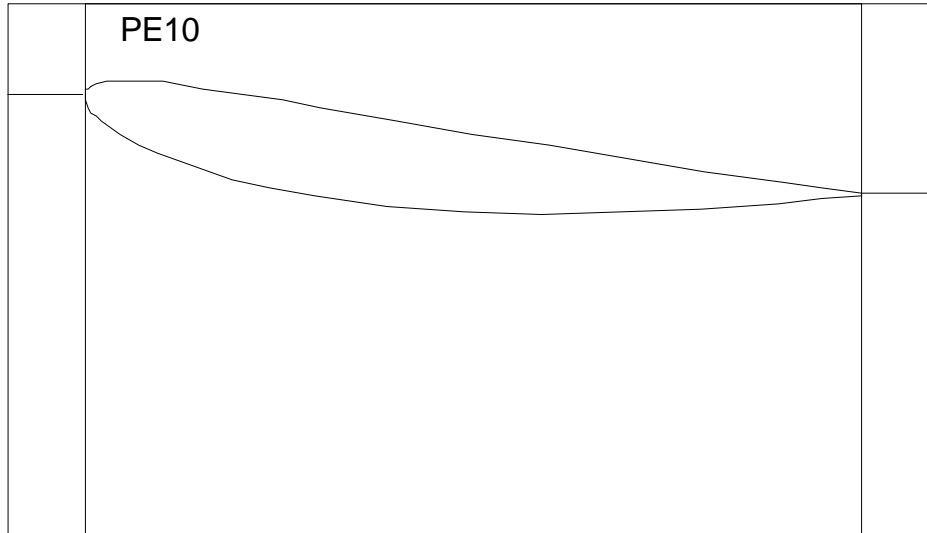




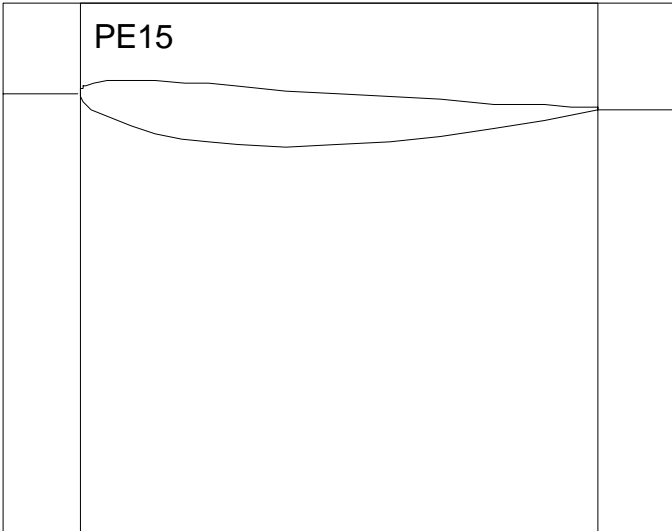
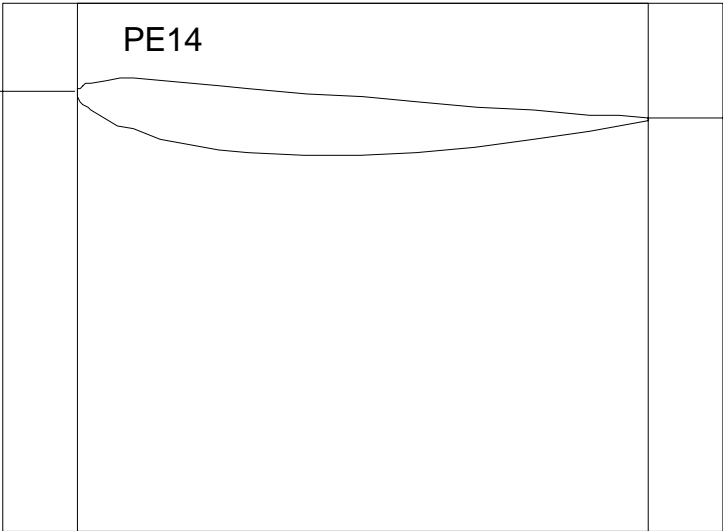
TEMPLATES FOR PERU 3-BLADE DESIGN USING NACA 4415 PROFILE  
- 15 STATIONS -



TEMPLATES FOR PERU 3-BLADE DESIGN USING NACA 4415 PROFILE  
- 15 STATIONS -



TEMPLATES FOR PERU 3-BLADE DESIGN USING NACA 4415 PROFILE  
- 15 STATIONS -



## Tails

I hope that I will find time to get more onto this page about tails. They are a very undertreated subject on the web but both Bob Budd and Hugh Piggott give a lot of information in their books.

The purpose of the tail is to keep the propeller facing into the wind in low winds and to turn it from the wind (feather it) when the speed exceeds the windmill's design for either the propeller or the speed of the generator. There are some designers that don't bother but you will have to judge the wisdom of that for yourself.

The mechanism that causes the tail to feather the blades is based upon speed and lift. The greater the speed the more lift and the tail swings to the side. At what speed this should occur depends upon the performance of the individual components of the unit. Units vary in weight, blades vary in performance and every generator has its own sweet spot for performance.

The only way to accurately determine the placement of a tail so that it will do its job is to test it with all the assembled components of its unit. I treat more of that subject on the page dealing with "testing".

### [Tail Mounting: Some pictures of a tail mounting.](#)

This is the windstuff now site. It also shows another concept for windgenerators in that it has a chain driven motor as the generator.

### [SEALED: Some pictures of a tail mounting.](#)

This is the SEALED mirrored version of this site that won't be opened until after The Great Catastrophe.

### [Overview: Forcefield Overview of Windmill Design.](#)

This is a good overview on Windmill generating systems from Forcefield. It does in fact also cover in considerable depth different concepts about "furling" but while I personally have excellent instructions in a video from Bob Budd, I have not been able to find a good source on the Web.

### [SEALED: Forcefield Overview of Windmill Design.](#)

This is the SEALED mirrored version of this site from Forcefield that won't be opened until after The Great Catastrophe.

**MENU: [HOME](#) » [Reconstruction](#) » [Recovery](#) » [Renewal](#) » [Energy Types](#)**

---

---

## Testing

### Propeller Testing

Because every set of handmade propellers is different and because there are probably substantial differences between each homemade generator, both as to performance and weight, the propellers and the completed system need to be tested and the associated tail vane customized so that the unit will feather (turn out of the wind) at its optimal performance speed.

A wind tunnel would be one solution for testing but this is another very clever one from Force Field. In the future I hope to mount ours on a Smokemobile - but that is another story, found elsewhere among our web pages.



#### [Windspeed: Homemade Easter Egg Anemometer](#)

This is a REALLY neat build it yourself device. Haven't done it ourselves - yet. But we are getting the components together. Pretty important to have one if you are going to be serious about wind generation.

And you shouldn't be surprised that the design is from Force Field. It is presently available at:  
<http://www.otherpower.com/otherpowerfront.shtml>

**MENU: [HOME](#) » [Reconstruction](#) » [Recovery](#) » [Renewal](#) » [Energy Types](#)**

---

---

## Water Powered Generators

Water is Wonderful. Usually even more wonderful than wind because it is usually more constant. What will be more wonderful still - is if you have a suitable source because very few people are so blessed. We have been double blessed at Ark Two because both of our properties sit upon each of one of the twin headwaters of the Pine River.

Below are links to pictures of the sites and on the web page I present details about the power systems designs and how you could apply the principles to other potential waterpower sites in a nuclear recovery situation. Between the two cases you will find an approach for either of the two opportunities you may find - either a low-head or a high-head situation.

### [Waterfall 1: The Large Waterfall at Ark Two](#)

While we cannot implement this system under the present government bureaucratic situation you can still see its potential for use in a recovery situation and under the link below about pumps you can see the studies we have done in preparation and the materials to which we might have access.

### [Waterfall 2: The Smaller Waterfall at our Home](#)

Although we are also forbidden to implement this system at this time you can again see the preparations that we have made. More particularly you will find here a presentation of how to build, out of materials salvageable after a nuclear war, a low head waterwheel system for use with a low rpm generator.

### [Waterfall 3: Micro Generating with Water.](#)

Here is a micro generating system using water. Its big advantage is that it is constant, so over time one or several could add a significant amount to a battery storage system. It uses a blower out of an old house furnace so that the waterwheel part is very simple to build.

### [SEALED: Micro Generating with Water.](#)

This is the SEALED mirrored version of this site from Forcefield that won't be opened until after The Great Catastrophe.

### [Pumps: Pumping out power](#)

Surprise! Surprise! Pumps are used to move a liquid (like water) but - if you run the liquid BACKWARDS through them, then they will turn a generator (like that motor described on an earlier page



- maybe even the motor that was used to run them originally). How do you run the liquid backwards - why you use something like a waterfall. This page contains the engineering studies for application to our big waterfall.

**MENU: [HOME](#) » [Reconstruction](#) » [Recovery](#) » [Renewal](#) » [Energy Types](#)**

---

---

## Water Power Potential at Ark Two



This is Little Wonder Falls  
so named by the Pioneers two centuries prior - because of its wonder and power.  
It is at the main Ark site.



At one time there were over fifteen mills in the village. The water would be captured at one dam and then released down to another. There was more water year round in those days because the forests held snow to melt for much longer seasons, and truly there was much more snow in the winters. But this is still the water above our dam.



The way the system would work is that the water would be allowed to build up behind the dam above the falls and then it was let out through the flume in a great rush for a few hours until the water pressure was exhausted. Then the system was shut down and the water was allowed to rise up behind the dam again before the machinery could be started again. In this way the water flowed and stopped in the stream - on again and off again on its way down to the next dam - something that would not be permitted today.

From  
the  
dam,  
under



the  
road  
and  
then  
on to  
and  
over  
the  
falls  
there  
is a  
flume.

Here you  
can see the  
flume that



brought the water from the dam on the other side of the road and over the cliff.

Down below the cliff there is still the old water turbine that was used to power the



machinery by driving belts.

The first mill produced what was called Little Wonder Flour. The flour industry, however, was eliminated by the arrival of the railroad which brought hard wheat flour from the western provinces. Hard wheat flour was much preferred over the soft wheat flour produced locally.



Today with much improved electrical generation technology and the significant fall of the property on downstream from the present turbine location the falls could produce a substantial amount of electricity. Certainly enough to power the village. However, under the current bureaucratic situation, at the time of this writing, such an effort would be completely impractical to undertake. Perhaps in the future there will be different circumstances.

The battle with bureaucracy has been immense over the years - and certainly preceding my generation. Two large power generating systems were about three miles further downstream from us. One supplied power to several communities for about 20 miles around. The government, in order to gain economies of scale for larger projects purchased and shut down these and many other smaller producers in the early 1900s. There was a revival in the 1930s during the Great Depression when the farmers could not afford to buy the government power and started a new power house at one of the dams. Once again the government bought it out and then dynamited the dam - so that wouldn't happen again.

At the time of this writing there is much lip service given to environmental concerns and the encouragement of "green" energy. But it is only lip service. The costs of getting through the bureaucratic hoops are so immense that it is totally impractical to try. But, in another time the need for these power sources may come into existence.

We continue to study the systems and gather the materials for that possible future time. On other pages, while explaining about different waterpower electricity generating approaches, I show the figures that engineers have given in our technical studies and some of the equipment we have identified that we could assemble after a nuclear war to make this site operational.



**MENU:** [HOME](#) » [Reconstruction](#) » [Recovery](#) » [Renewal](#) » [Energy Types](#)

---

---

## Our Home Water Power Site

In the mystical beauty just outside our back door is our home waterpower site. In the 1800's, because it is located at the main intersection of the village, this was the most prominent (although it was certainly not the largest) watermill site in the village.

At one time there were over fifteen mills on the two headwater streams of the Pine River in the village. The water would be captured at one dam and then released down to another. There was more water year round in those days because the forests held snow to melt for much longer seasons, and truly there was much more snow in the winters.



This is how the village still looks, which is probably about 80 years after this picture taken. Standing at this spot one would see that most of the buildings in the picture are still standing and those are still the only buildings they would see. The only difference I can see is that the street has been paved and the building where the arrow points is where our house is now. The big building behind it was a hotel.





This is our house today at the bottom of the same hill and still looking back up the hill. In the forefront of the picture is the bank of the stream that comes from under the house across the road and runs around behind our house. The big building that was the hotel is barely visible through the big weeping willow in our front yard. There were also two other hotels and a couple of general stores across the street, the buildings for which are still there.

This is where the water starts downward on our property - as it turns away from the road. We have a little over a ten foot drop to the bottom of the dam at the other end of the property which was the first mill on the stream. This stream flows year round and the volume is fairly constant although once or twice I have seen three or four times the volume during times of extended rain.



Standing on the  
first bridge behind



our house and looking downstream towards the second.

This is what is left of the old dam at the other end of our property. This doesn't make any difference to our new design using the pipe because all we need is the drop - not the water behind the dam. The dam is now only half as high as it was when we bought the house a quarter century ago and it used to be higher still. In the olden days they would allow the water to fill up behind the dam, a process that I would estimate to take between 45 minutes and a hour and fifteen minutes and then there would be power to mechanically run the saw to cut planks for maybe twenty minutes. As the water went down the saw would get slower and slower and then they would eventually stop and let the water build up again. The dam is now all silted in. I had it cleaned out about twenty five years ago but it silts back in, in about five years.



Here you see myself and my grandson helping my son build a cedar crib to capture the water up near the road.



Here is Capt. Bill in command of the little ark as we sail it into the stream. Bill started as assistant foreman over 20 years ago in the building of Ark Two. Since Percy passed on he has been our foreman.



This was the cedar box down in the stream. We planned to pack dirt along one side and to provide a fish ladder on the other. The box itself strained out sand so that it would not go down the pipe and into our power generating system.





On the back of the cedar box we would have attached this pipe.

And then these new pipes would have been buried in the bottom of the stream so as to not destroy the scenic view. In the face of pressing need for energy after a nuclear war we may not have for a long time the luxury of burying them. Originally the stream was a mosquito marsh but years ago I had it lined with giant boulders and put the bridges from both sides of our property across it. Even this would not be permitted today under current government bureaucracy.



And this is the cedar box back up on the bank after ENFORCEMENT



(that is what the 10 inch high letters say on the front of their truck) made us take it back out.

I have told you this whole story so that you can know the degree that we have worked on this system. We think we have a concept that will work exceptionally well on lowhead water sources. In the following paragraphs I will explain the technological concept of the system so that hopefully others will be able to apply the principles elsewhere.

## Every system is unique

Every waterpowered electrical generation system has to be tailor made to:

- the volume of flow
- the height of the head
- the layout of the land
- the climate
- the generation goals
- the materials available
- environmental concerns

There are many sub-subjects consideration such as:

- dam construction
- flume construction
- power house construction

transmission line construction  
power distribution  
power sharing or restrictions

## Varieties of Approaches

There are a variety of technological approaches to meeting each of the requirements but it will be of little benefit to list all that is available today when the real issues will be what is available at the time of nuclear recovery construction when one will have to make do with what they can find then. A concrete dam might be better than an earthen one but you may have to make do with an earthen or even log and stone dam. A higher dam might be better than a lower. But you will have to do what you can safely do with the materials that you have.

## Waterwheels

In the olden days the main mechanical power technology used was the water wheel. These fell into two categories of the overshot wheel and the undershot wheel. The advantage of the overshot is that it can be made of "buckets" and the weight of the water as it goes down will greatly add to the wheel's momentum. The larger the wheel the more sustained momentum. The disadvantage of the overshot wheel is that its height takes away from the available head. However, if the head is very high, then this may make little difference. Unfortunately most situations will have the problem of a low head rather than the advantage of a high head.

The undershot wheel only captures the water flowing through and therefore does not gain from the benefit of the weight of the water but is more suitable to lowhead situations. There is actually a third choice, not often seen, and that is the sideshot wheel in which the wheel lies on its side at the lowest level and the water is directed from the side by a nozzle towards the propellers. In this configuration it is possible that the wheel can still be quite large. Indeed this is the design that we have chosen for the house system at the smaller falls.

## Turbines

For those who go out and buy waterpower generating systems - the preferred systems are usually turbines. These are finned devices (of a variety of types) some that fit directly into the flume. The design specific to a system needs to meet two factors - the diameter of the pipe and the volume of the water. The volume and diameter will determine the speed of the turbine. For seventy-five thousand dollars, one engineering firm offered to run their computer program for us that would give an optimal design for a turbine on our smaller stream. We declined. But, you can see how technical this could get.

The main designs of small capacity turbines are called the Pelton, Turgo, Francis and Crossflow. Each have their advantages in certain situations and disadvantages in others. However, this is not a proper subject for a

web page dealing with the development of systems in a nuclear recovery situation. Those who have the luxury of building a system ahead of time, when they have the option of obtaining various designs, can research the sources elsewhere on the web.

## A Unique Approach for use in Post Nuclear Recovery

Days of touring salvage yards to see what may be applied found that there are often large paddle devices that were industrial air blowers, churning devices, or what were in effect large low volume pumps. By directing the water through nozzels at these paddles or blades we feel that some sustained momentum may be achieved. One of the major considerations is to design the water exit in such a manner that you are not losing the energy in pushing the water out. The idea is not to move the water (although that may have been the original idea behind the device) but instead for our purpose the idea is to get as much energy as possible from the force of the water. For this reason one good approach may be to simply lay the wheel and cabinet on its side (although it was not originally designed to work that way) and cut some holes in the cabinet so that the water will just fall away.

### Scientific Principle

There are two considerations or concepts that one must keep in mind with any waterwheel and these are momentum and torque.

### Momentum / RPM

Momentum is the speed at which the wheel moves. We measure it in RPM (Revolutions Per Minute). Some people have trouble in thinking in RPM, so I will try to help clarify the concept. The earth has a relatively low rpm. Not even ONE rpm. Not even one revolution per hour. It takes it 24 hours to make one turn. Admittedly - its outer edge is moving at hundreds of miles per hour. And if you think that is big and slow - think of the galaxy. Billions of years to make a revolution although again - its outer edge is moving at thousands of miles per hour. It is just a long way around. Generators (like those on a car) generally need 1800 rpm or more. That is to say they need to make 1800 revolutions per minute. An average speed for our low rpm generators is 400 rpm but to help think this through let us say that it was 300 rpm. At 300 revolutions per minute **it is making 5 revolutions every second**. (60 seconds in a minute times 5 revolutions per second equals 300 rpm (revolutions per minute)). Not terribly fast. Something you can see.

### Torque

Torque is a function of BOTH speed and mass. Think of the earth in our example above. While it is moving relatively slowly because of its mass - think of what it would take to stop it. Or the galaxy. The Mass!!

Billions upon billions of stars and planets. Big - slow - although the outer edge is moving at thousands of miles per hour - but the torque!! It may seem that rotation speed is a function of size - because for example the electrons of atoms spin VERY fast - so fast that we speak of their rpm as frequency. But torque is a function of both speed and mass. A very large body with low speed has lots of torque. So does a small body with lots of speed. But it is the total combined that gives the ultimate measure of torque. Closer to the size of things we observe everyday let us take the example of a big truck wheel that is moving very fast. Once it is up to speed even if then just freewheeling it would take a lot of energy to stop it - because it is big and heavy and moving fast.

## **Conversion of the Mass component of Torque to Momentum**

Torque is made up both momentum and mass. The momentum/speed component of torque can be converted to mass/weight and the mass/weight component of torque can be converted to speed/momentum. Let us first look at converting the mass component of torque to momentum. We can do this through the use of gears or pulleys. Chain driven gears may work better around water than belt/pulley driven devices but the principle remains the same. We go from a larger wheel with its torque consisting of a large slow moving mass/weight to a smaller wheel which will then turn faster.

Picture the belt/chain around the large wheel that is turning slowly and then the belt/chain extending down to the smaller wheel which then must turn quickly to keep up with the speed of the belt. The shaft of the smaller wheel can have on it another somewhat larger wheel that will then be turning at the same faster speed of the smaller wheel and a chain/belt from that larger wheel to still another smaller wheel on another shaft will repeat the principle with this second smaller wheel going faster still. The process can be repeated a number of times so that while the first wheel may have been turning only a few revolutions per minute - we can arrive at a wheel turning thousands of revolutions per minute - if that is our goal and PROVIDING that the first wheel has enough torque (combination of weight/mass and energy/momentum) to sustain the drag of the added gears or pulleys.

The reverse principles can be used to make a fast moving small wheel turn more slowly a large wheel, but it is more likely that in our application we are going to need to use the method given in the example. Adding the weight or drag of the belt/chain slows down the big wheel and our problem is that usually we cannot make it go fast enough to overcome the drag that we wish to add to it.

## **Using a slow waterwheel to run a faster generator**

In our above horizontal waterwheel we would have the water hitting the paddles of the the wheel from several sides of the wheel. As an analogy, think of the old playground merry-go-round. Children stand around the outside adding to the speed of the spin. Each one pushing on a bar as it goes by. Eventually they cannot push very much on the merry-go-round because it comes by too fast for them to get a hold on it. Each child is not adding much energy to the wheel as it goes past. Each child's energy potential is being

wasted.

The same thing happens when our waterwheel is coming past the nozzels too fast. The water from the nozzel does not get to hit the blade for very long - so its energy is wasted. The thing to do is to slow down the wheel. We do this by putting more weight on it. Now more energy will go into the wheel at each nozzel. With the merry-go-round there would be more children on the wheel and those standing and pushing would have longer to push the bar in front of them. We use the same principle to capture more of the speed of the water in our nozzels and to change it to torque in the waterwheel. We simply add weight and that slows down the wheel and allows us to capture more energy from the speed and force of the water.

A merry-go-round with few children on it is much easier to stop than another one moving at the same speed with many children on it. That is the effect of mass on torque. A body in motion tends to stay in motion and the heavier the body in motion - the harder it is to stop. This is one of the reasons why we like heavy flywheels in our system.

## The Drawback to Flywheels

The DRAWBACK to flywheels is that there is ALWAYS a loss of energy in conversion so ideally we would instead like for our initial wheel to be moving at the end desired speed with the maximum torque it that can master. Because it is difficult, with low head sources, to actually get up to 1800 rpm it is more optimal to use low rpm generators and so consequently our target is more in the area of 400 rpm. The question then becomes one of how much torque (mass/weight - moving at 400 rpm) can we develop from our blade/paddle and nozzel system. We are not wanting to just keep adding weight to the wheel until it slows down to 400 rpm because while it would have good momentum and torque - that is to say it would be difficult to slow down - that weight we added would be just dead weight and the energy (work) that we were using to move it around would be just useless work.

The weight that we want to add as directly as we can to the waterwheel is the weight or energy requirement of turning our generator at 400 rpm. If the waterwheel has the capacity to turn our generator at twice that speed then that is great because we can then let it turn two generators at the same time and we will get twice the electrical output. Conversely, if our waterwheel while initially turning at 400 rpm slows down to half that speed when we add the weight of turning the generator - then perhaps we need a smaller generator or two waterwheels to turn the generator, or a bigger faster waterwheel, or some other combination.

## Waterwheel Variables

There are many variables that we can perhaps adjust. The size and weight of the waterwheel, the gear/pulley ratio of the drive to the generator, the number, angle and closeness of the nozzels shooting water onto the paddle/blades and the volume and speed of the water coming through the nozzels. There will undoubtedly be much skill involved in maximizing the adjustments. But no matter - with some reasonable application of the principles involved and some reasonable resources as to waterhead and volume and the components I have described - one should be able to produce some amount of electrical energy. Hopefully

an amount that will make the effort worthwhile.

I would liked to have carried this idea beyond theory, but The Powers That Be would not let me proceed with my experiments. We will have to make do with what we have available but we would particularly have liked to have worked further on the design of the nozzels - an art in itself.



## Nozzels

I called around North America and talked with a number of nozzle design engineers and went and visited a couple. Basically what we concluded was that the antique fire hose nozzle of old was the best that we could do. It is long tapered and pointy (at least on the inside). This is somewhat difficult to machine but that is the ideal. One starts with a long bar of steel, (or plastic - if that is what you have and can handle), cut it up into appropriate nozzle lengths and then mill down into the inside.

We have bought all the components for the number (twenty-four) that we think that we will need at our two sites. Connectors, valves, makings for the nozzels, and lots of hose.

In the picture I am holding one of the assembled nozzels. We have also gone ahead and put in place the power house and have acquired the big batteries for the system but we have gone as far as the government will permit us to go.



As I have said - it would have been much better to get our home waterpower system working ahead of time and to prove out the design - but we have gone about as far as the government will permit us to go. We are also considering an altogether different approach for the large waterfall and that is a large pump which we would use as a turbine. But that subject is covered in its own place.

**MENU:** [HOME](#) » [Reconstruction](#) » [Recovery](#) » [Renewal](#) » [Energy Types](#)

---

---

## Making Pumps into Electrical Generators

It is unlikely that after a nuclear holocaust you will be able to find a suitable turbine even if you do find a high head water source but here is a solution that has been tried and said to work even in pre-holocaust time.

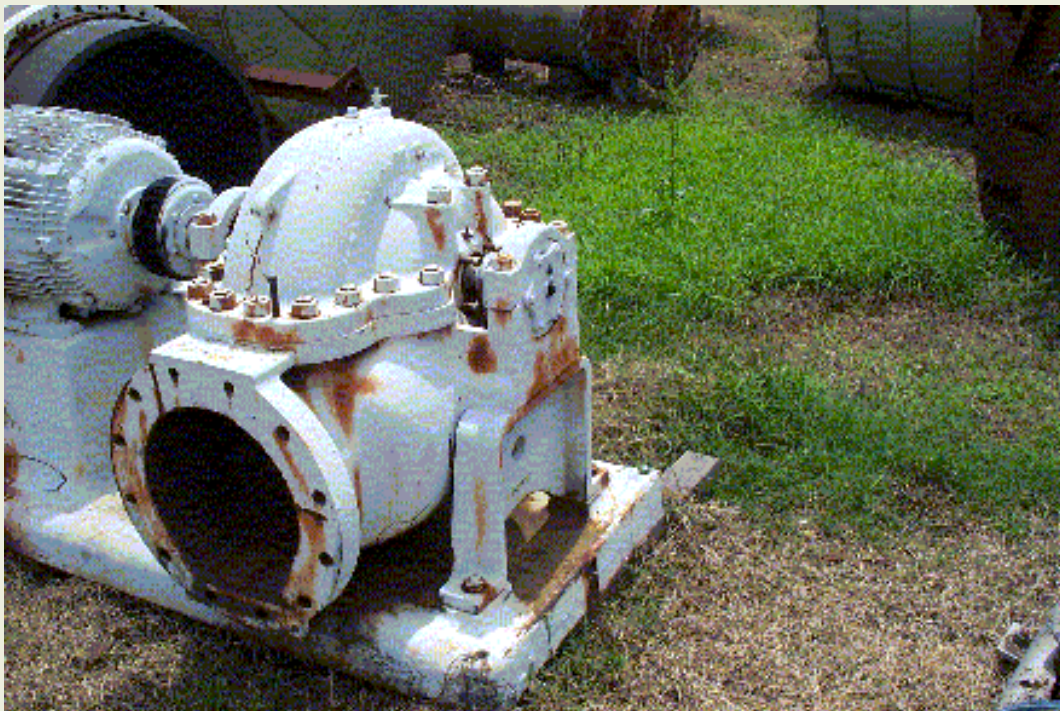
### [How to do it: Using a pump as a turbine](#)

This 38 page .pdf file gives you a lot information about the process. It is however copyrighted and will have to remain locked until after the nuclear war.

Unfortunately, because of government bureaucray we were not able to go ahead and do a demonstration implementation of the solution - still we did do the the engineering studies.

Large pumps are to be found, even now, in ship and oil field salvage yards. They may have been used to pump oil or some chemical so that you would not want to use them to pump drinking water - but that is okay because you are just using them to create power.

Here is a picture of the type of pump that we are talking about:



It is big (stands about 3 and a half feet high), heavy, and dirty - but once it is cleaned up it will probably work just fine. Moreover, you can very possibly use the attached motor, as explained in an earlier webpage, to run backwards and be the generator.

If you don't have a single large enough volume of water - or sufficient pressure in the water to run the pump then

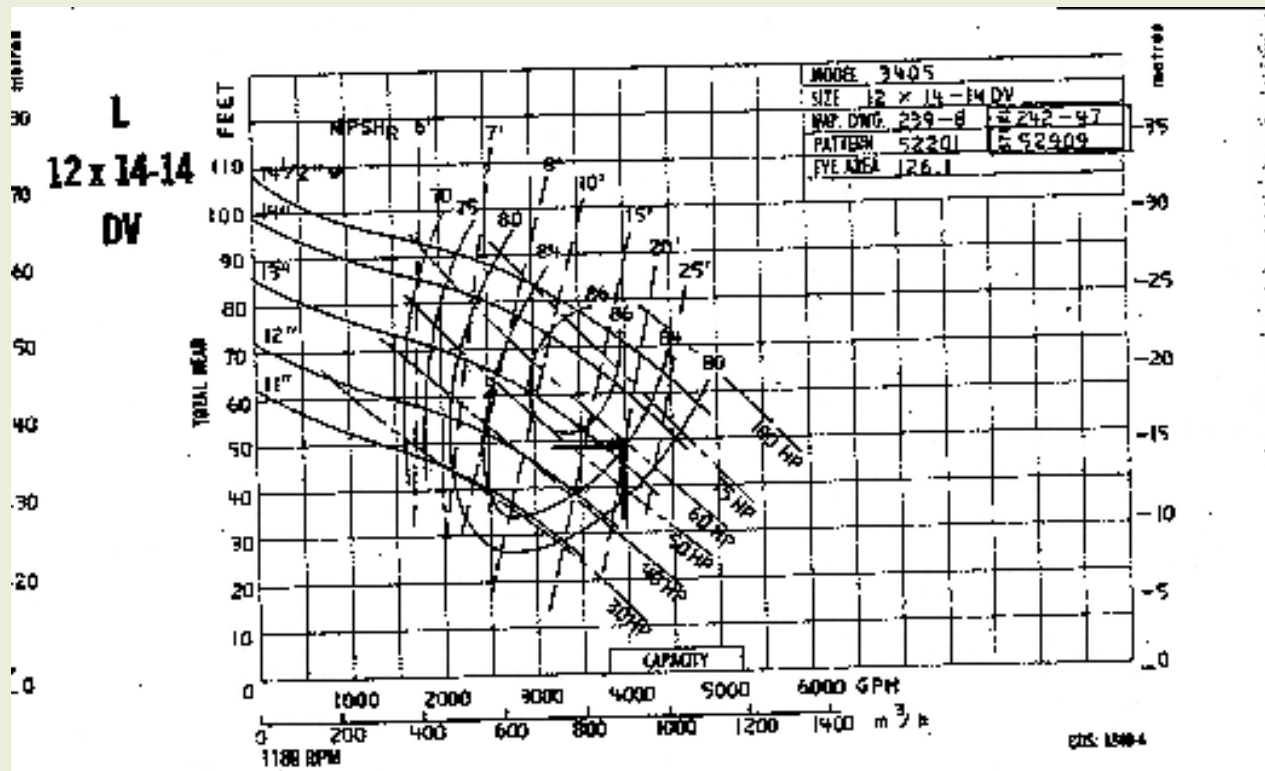
you may be able to use the approach that I suggest on our home waterfall website and that is to cut holes in the casing and aim nozzels in at the blades, so that you are striking them at more than one location.

Don't forget - your goal is not to move the water (which is the original design purpose of the pump) but rather to take the energy out of the flowing water and transfer it to the wheel inside the pump. For this reason - once you have received the energy, the water is really just in the way and you are now having to use energy to get rid of it. Therefore, what you can do is cut other holes in the casing for the water to escape through - because you just want it to leave.

Another point. If you aren't getting enough energy from the wheel to run the motor backward at a sufficient speed to generate electricity you can also substitute a low rpm generator for the motor.

Overall the concepts here should have application for numbers of potential situations. And don't forget the idea of possibly adding a heavy flywheel to add to the torque and smooth out the operation, but also consider the disadvantage of flywheels as discussed under our home falls generating system.

Below is an engineering study on the expected performance of the pump at our large falls location.:

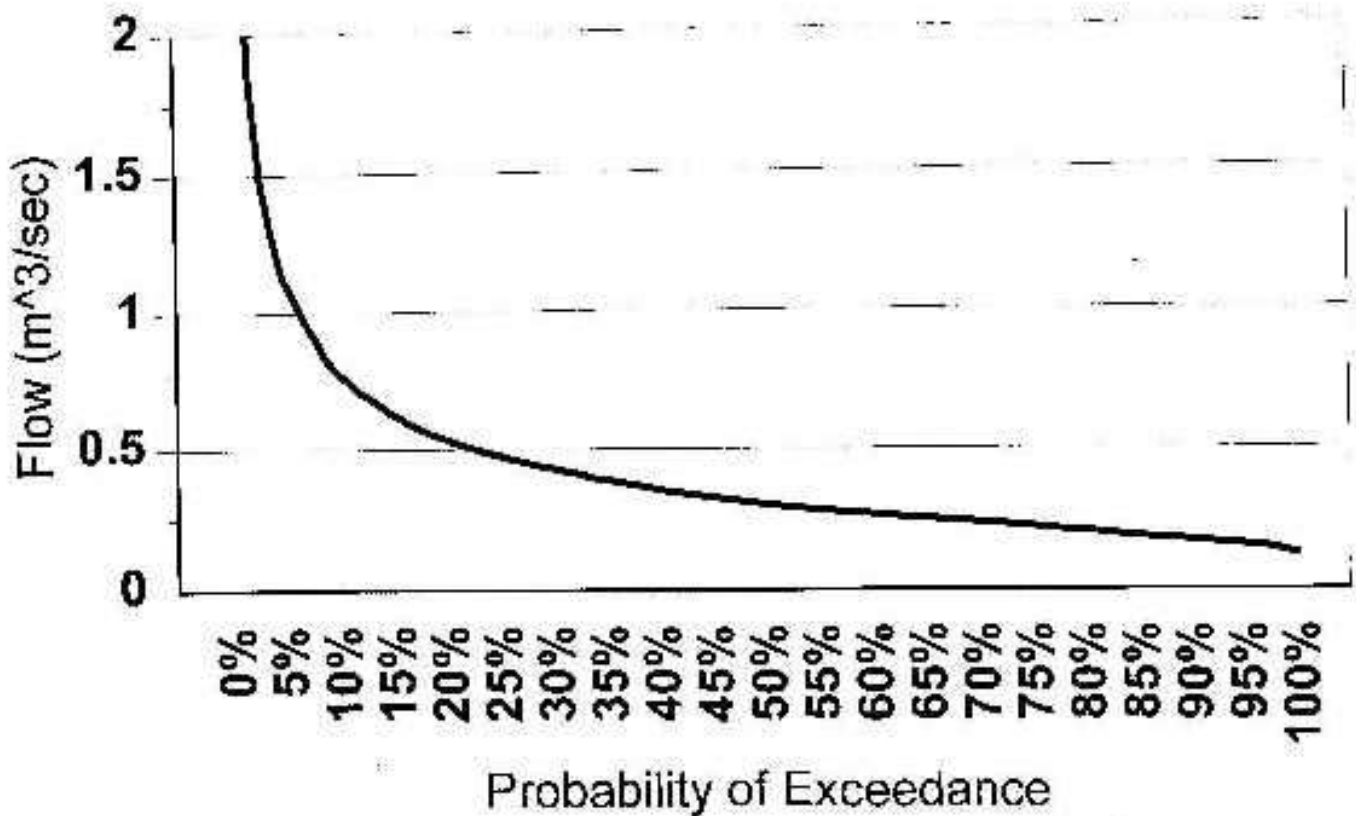


L  
 12 x 14-14  
 DV  
 4000 / 51' @ 1200 RPM  $\equiv$  3933 / 49.3' @ 1180 RPM  
 IMPELLER SHOULD BE TRIMMED TO  
 APPROXIMATELY 13 1/4"  $\phi$   
 AT THIS SIZE, THIS PUMP WILL FLOW  
 4756 GPM @ 60' AND PRODUCE 45.7 KW  
 1200 RPM GENERATOR REQ'D

From the above chart, done by US engineers, you can see that it was expected that we would get over 45KW given a flow of 4756 gallons per minute and using a 1200 rpm generator. Twenty four hours per day with no additional energy input it would be the neatest thing we would have going. Then or now.

The following chart, done by Canadian Engineers, shows the site flow expectations in cubed meters per second. I have not yet been able to convert between American gallons per minute and Canadian cubed meters per second to reconcile the two sets of numbers.

## Figure No. 1 Flow Duration Curve Horning's Mills



The following chart shows revenue expectations assuming that we could sell the electricity back to the grid under the "green program" which was legislated many years ago and has been talked about endlessly but I know of no one who has personally made it through the bureaucratic hoops. This chart shows a substantial seasonal difference in water flow and while I have seen BIG differences as the result of a storm - I haven't personally noted there to be that kind of seasonal difference. It makes me wonder if the engineers took some seasonal charts rather than considering the actual underground source from which our stream is fed.

**Table No. 3**  
**Horning's Mills Fully Developed Site**  
**Revenue Stream - Best Case Scenario**

\$0.04 per kWh in off peak periods  
 \$0.06 per kWh for winter peak periods  
 \$0.07 per kWh for summer peak periods

Month	Net Head (metres)	Usuable Flow (m <sup>3</sup> /sec)	Power kW	kWh	Peak \$	Off Peak \$
Jan	20	0.3	47	35,000	\$933	\$933
Feb	20	0.3	47	35,000	\$933	\$933
March	20	0.3	47	35,000	\$817	\$933
April	20	0.3	47	35,000	\$817	\$933
May	20	0.3	47	35,000	\$817	\$933
June	20	0.3	47	35,000	\$817	\$933
July	20	0.2	24	17,500	\$408	\$467
August	20	0.2	24	17,500	\$408	\$467
September	20	0.2	24	17,500	\$408	\$467
October	20	0.2	24	17,500	\$408	\$467
November	20	0.3	47	35,000	\$817	\$933
December	20	0.3	47	35,000	\$933	\$933
				350,000	\$8,517	\$9,333

Below is the summary engineering study showing, that given the terms of the current "green power" legislation, that the project is financially feasible. Electricity prices have increased since the study was done and as they continue to increase - the case justification of course just gets better and better.

However, the PTB have frustrated all attempts for implementation - not just for us, but also for many others. There has been talk, talk, talk about "green power" and the environment - but it is just talk and impossible hurdles by very antagonistic low level bureaucrats are placed in anyone's way who tries to do anything about it. When my wife and I showed our case to my attorney - he simply replied, "Ah! You are planning to put my children through college!"

**Table No. 4**  
**Horning's Mills Fully Developed Site**  
**Revenue Stream - Worst Case Scenario**

\$0.028 per kWh in off peak periods  
 \$0.06 per kWh for winter peak periods  
 \$0.05 per kWh for summer peak periods

Month	Net Head (metres)	Usuable Flow (m <sup>3</sup> /sec)	Power kW	kWh	Peak \$	Off Peak \$
January	20	0.3	47	35,000	\$700	\$653
February	20	0.3	47	35,000	\$700	\$653
March	20	0.3	47	35,000	\$583	\$653
April	20	0.3	47	35,000	\$583	\$653
May	20	0.3	47	35,000	\$583	\$653
June	20	0.3	47	35,000	\$583	\$653
July	20	0.2	24	17,500	\$292	\$327
August	20	0.2	24	17,500	\$292	\$327
September	20	0.2	24	17,500	\$292	\$327
October	20	0.2	24	17,500	\$292	\$327
November	20	0.3	47	35,000	\$583	\$653
December	20	0.3	47	35,000	\$700	\$653
				350,000	\$6,183	\$6,533

After a

nuclear war the practicality - nay the dire necessity of such sources as this will become apparent and so I continue to study and prepare for that eventuality.

**MENU: [HOME](#) » [Reconstruction](#) » [Recovery](#) » [Renewal](#) » [Energy Types](#)**

## Making Motors into Electrical Generators

Here is another interesting idea for generating electricity. Using an electrical motor and running it backwards. There will probably be lots of good motors with their bearings and windings intact, after a nuclear war. It will be just a matter of matching it up to a wind, water, bicycle, small engine or other driving source.

### [How to do it: Using motors as generators](#)

This 49 page .pdf file gives you a lot information about the process. It is however copyrighted and will have to remain locked until after the nuclear war.

Below is another method of getting electricity out of motors, but one that requires magnets. Finding the magnets to make the modifications will probably be the greater challenge. Still, there will be magnets out there also. One good source would be old speakers. Another is computer harddrives. The magnets can be taken from them and sawed into the shapes desired. I have sawed some magnets, and that can be a bit tricky too, without a diamond saw or disk. However, there will be all sorts of challenges - and ingenuity can overcome many of them. In sawing magnets you don't want to overheat them or they will splinter and crack. They need to be kept cool by water during the process. Odd shaped magnets can be cut into smaller shapes and then reassembled into the desired shape. They will self-adhere but a glue or adhesive can be used for integrity.

A magnet sawed in half cannot have the two part joined back together - the way they came apart. They will then repel each other. Amazing! And I am not sure that even physicists understand why. I have asked several. There is SO much that I DON'T understand about magnets. I spent many bucks and hours developing a lathe to shape magnets. Unsuccessfully. Had the input and assistance of a number of capable tool makers, and still couldn't get it to work.

Not all our experiments are succesful. Indeed, many (most) are not - or certainly have to be greatly modified from our original design plans. We have had GREAT failures with many things that we have tried - all the way from hydroponics, to ships, submarines and robots. With inputs of enough time, money and engineering many things can be accomplished. The problem is that as individuals we are often very limited in all those inputs. The limitations will probably only increase after a nuclear war. That is why I so greatly appreciate hearing about designs that have been tested and proven.

We have also had some exceptional successes, as evidenced by my marketing of my patents and some other, what I think are, notable accomplishments. What I try try to share in many of these pages is not so much "how to do" as an attitude about "trying to do" because I think it is the latter that is going to be very important during nuclear recovery.

## [Motor 2: Supplementing motors with magnets to make generators](#)

This idea from Force Field seems to be relatively simply done - if you can find the magnets.

### [SEALED: Supplementing motors with magnets to make generators](#)

This is this SEALED mirrored site that won't be opened until after The Great Catastrophe.

## [Motor 3: Tape Drive Motors as Generators](#)

Force Field has lots of experience with low rpm generators. Here is an example from them of a motor being used as a generator without any modification.

### [SEALED: Supplementing motors with magnets to make generators](#)

This is this SEALED mirrored site that won't be opened until after The Great Catastrophe.

**MENU: [HOME](#) » [Reconstruction](#) » [Recovery](#) » [Renewal](#) » [Energy Types](#)**

---

---



**MENU:** [HOME](#) » [Reconstruction](#) » [Recovery](#) » [Renewal](#) » [Energy Types](#)

## Diesel and Gasoline Generators

Diesel and gasoline powered generators are an excellent source of electrical power, but of course the problem is finding fuel for them. Every drop of fuel will undoubtedly be scavenged from abandoned vehicles and old storage tanks. Diesels run equally well on furnace heating oil. It is really nothing other than diesel sold under a different taxing system and perhaps with a coloring added to it.

A longer term solution for diesels is the growing and distilling of one's own biofuels. This subject is covered elsewhere in our series of web pages.

It is very beneficial to have storage battery systems associated with diesel and gasoline generating systems. These very often are larger generators that put out way more power than one wishes to consume at the moment that they are running, so it is by far more fuel efficient to store the excess power.

HOWEVER, it is more efficient still to use the power directly without first storing it because about 20% of the energy is lost in the conversion process. For this reason, where it is possible, it is best to bunch up or save up the tasks that require a lot of power until such time as the generator will be running, so that the power can be used directly.

[The Diesels at Ark Two](#)

**MENU:** [HOME](#) » [Reconstruction](#) » [Recovery](#) » [Renewal](#) » [Energy Types](#)

## Batteries and Inverters

Batteries are an important part of alternative electrical systems for two reasons.

First, because the systems often produce so little power, it is important to capture all the power they do produce so that one can have it available at a later time if it is not needed at the moment it is produced.

Secondly, so little power is sometimes produced it is necessary to store it up until one has sufficient to use for the task they wish to undertake.

Banks of large batteries may be difficult to come by but there may be large quantities of automobile batteries about.

### [SEALED: The Complete Battery Book](#)

This 98 page .pdf document gives essential information about the care and usage of these batteries and may be very useful information to have. Automobile Batteries will perhaps be the most available.

### [Testing: Ammeter.](#)

Forcefield explains how to build and use an ammeter.

### [SEALED: Forcefield Ammeter design.](#)

The SEALED version of the Forcefield explanation of how to build and use an ammeter. This file will not be opened until after the nuclear war.

Below is a friend's large battery bank. In actuality he has a half dozen storage sheds with battery banks like this. The batteries require considerable maintenance, the water and acid levels needing to be checked and their charge needing to be replenished, even if they are just kept on standby.

A friend's large battery bank

## Inverters

Batteries can be configured for different voltages depending on how they are wired together. It is possible to string out enough to get 110 volts off of them but generally they are used to run 12 volt systems. There are many twelve volt appliances about. They can be found in camping trailers and elsewhere. Also automobiles have a variety of twelve volt motors and devices that can be gotten out of them. The headlights, radios and so forth in automobiles can be used with any sufficiently large twelve volt battery system.

When it is absolutely necessary to convert from 12 to another voltage the device used is called an "inverter". The most common ones convert the power to 110 volts. The problem is that most of the smaller ones, the ones that are most available, and which are relatively inexpensive - costing presently in the one to two hundred dollar range, cannot deliver enough wattage to start pumps or run many household appliances.

Still, if one is fortunate to have an inverter they will probably find many uses that they can put it to. Otherwise, it is best to try to develop things like lighting systems by cannibalizing vehicles for twelve volt sockets and bulbs that one can string together.

**MENU:** [HOME](#) » [Reconstruction](#) » [Recovery](#) » [Renewal](#) » [Energy Types](#)

---

---

## Bicycle Power

Bicycles are an important source of transportation that is largely overlooked in North America. I used to oftentime see Mormon Missionaries riding them, and in some areas the Amish. Bicycle paths are becoming more common in many large cities but still it was in China that I realized how under-utilized they are in North America. There in China I traveled through a sea of thousands, more like tens of thousands of them, perhaps even hundreds of thousands while on auto trips. I could see them moving like a mighty river from my high hotel room window.

Bikes were/are used to transport things there that I would have thought unimaginable. I have literally seen a rider with a piano strapped on his back although I do not know if it contained all its guts. Nevertheless, bikes piled high with cabbages, several feet higher than the rider - were a common sight. Bike (or really trike) rick-a-shaws were another common sight. We just don't use the bike anywhere near to that extent in North America. Or we didn't. After the war we may change our attitude about it.

We have used bicycles at Ark Two for many purposes. We use them to mechanically run air blowers, grind wheat, and they can be used for many mechanical purposes such as running a small printing press. Below you see pictures of a bicycle attached to a blower. And we use them for generating electricity.



**[Bike 1: Not just for riding \(SEALED\)](#)**

This SEALED 144 page .pdf document gives a great amount of valuable information on how to apply bike power to many different kinds of machines. It is a copyrighted document and won't be opened here until after the nuclear war.

## Bicycle Power for Generation of Electricity

While I have read lots of articles by people theorizing about using bicycles for electric power generation and I have actually pedaled several ones in the Science Museum and at science demonstrations the three presented here are the best actual bicycle experiments that I am aware of.



Here I am in our garage workshop, pedaling away on our first bike powered generator. Hung around behind me are 8 twelve volt florescent lights which I am lighting by pedaling on the bike.

This generator is hooked to one of several old exercise bikes we have but we also have ten old multispeed bikes waiting down at the shelter. We also have air blowers and wheat grinding mills that we can hook up to them.



We have the system set up so that the florescent lights come on only if the bike is being pedaled. I am lighting all eight lights that you see (plus one more 50 watt Halogen that you can't see) to take the picture. The only light used for the picture was that which I was pedaling. No, I wasn't lighting the heater! That is on a separate circuit.

Ed fixed up a neat system so that any extra power that I pump will go into a battery and not blow up the florescent lights. But the battery doesn't light the lamps.



This is Ed in our garage. Ed has been a major expert on getting all this going.

In the background are the clear basswood boards that I had cut and kilned this summer in preparation for making the blades for windmill propellers. And behind the bike you can see stacked up a number of the brakedrums we were working on.



After we got all ten of the brakedrum generators completed and tested we took one of them to the WLP Picnic to run the sound system amplifiers. The best way to work any of these systems is to pump the power into the batteries so that it will be available whenever you want it - but sometimes we ran the sound system directly off the bike just to show that we could do it.

On the previous low RPM generator web page I link to other pages with more detail about building the brakedrum generators and other low RPM generators and there are lots more detailed pictures of the generators themselves.

### [Bike 2: The David Butcher Pedal Powered Generator](#)

The central idea that you want to get from this presentation is the value of a heavy flywheel to smooth out the generation and ease the operation. David also gives a lot of other good information about expected performance.

### [SEALED The David Butcher Pedal Powered Generator](#)

This is the SEALED mirrored version of this site that won't be opened until after The Great Catastrophe.

### [Bike 3: A Quick and Dirty Bike Generator System](#)



Forcefield has lots of experience with low rpm generators.

**[SEALED: A Quick and Dirty Bike Generator System](#)**

This is the SEALED mirrored version of this site that won't be opened until after the End of Armaggedon.

**MENU: [HOME](#) » [Reconstruction](#) » [Recovery](#) » [Renewal](#) » [Energy Types](#)**

---

---

# Construction of a Simplified Wood Gas Generator for Fueling Internal Combustion Engines in a Petroleum emergency



[Introduction](#)

[Contents](#)

Modified by Bruce Beach  
from html written by Markus Almroth  
<http://www.gengas.nu/byggbes/index.shtml>

From a version developed by:  
THE BIOMASS ENERGY FOUNDATION PRESS  
1820 Smith Rd., Golden, CO 80401

written by:  
H. LaFontaine, Biomass Energy Foundation, Inc. Miami, Florida and F. P. Zimmerman, Oak Ridge National laboratory, Energy Division  
FEMA interagency Agreement Number: EMW-84-E-1737 Work Unit: 3521 D

for:  
Federal Emergency Management Agency Washington, D.C. 20472 "This report has been reviewed in the Federal Emergency Management Agency and approved for publication. Approval does not signify that the contents necessarily reflect the views and policies of the Federal Emergency Management Agency." Date Published: March 1989 APPROVED FOR PUBLIC RELEASE:

DISTRIBUTION UNLIMITED

Prepared by:

Oak Ridge National laboratory Oak Ridge, Tennessee 37831-6285 for the U.S. Department of Energy

**MENU: [HOME](#) » [Reconstruction](#) » [Recovery](#) » [Renewal](#) » [Energy Types](#)**

---

---

# 1. WHAT IS A WOOD GAS GENERATOR AND HOW DOES IT WORK?

This report is one in a series of emergency technology assessments sponsored by the Federal Emergency Management Agency (FEMA). The purpose of this report is to develop detailed, illustrated instructions for the fabrication, installation, and operation of a biomass gasifier unit (i.e., a "producer gas" generator, also called a 'wood gas' generator) that is capable of providing emergency fuel for vehicles, such as tractors and trucks, in the event that normal petroleum sources were severely disrupted for an extended period of time. These instructions have been prepared as a manual for use by any mechanic who is reasonably proficient in metal fabrication or engine repair.

## 1.1 INTRODUCTION

Fuel gas, produced by the reduction of coal and peat, was used for heating, as early as 1840 in Europe, and by 1884 it had been adapted to fuel engines in England. Before 1940, gas generator units were a familiar, but not extensively utilized, technology. However, petroleum shortages during World War II led to widespread gas generator applications in the transportation industries of Western Europe. (Charcoal-burning taxis, a related application, were still common in Korea as late as 1970.) The United States, never faced with such prolonged or severe oil shortages, has lagged far behind Europe and the Orient in familiarity with and application of this technology; however, a catastrophe could so severely disrupt the supply of petroleum in this country that this technology might be critical in meeting the energy needs of some essential economic activities, such as the production and distribution of food.

This report attempts to preserve the knowledge about wood gasification as put into practical use during World War II. Detailed, step-by-step procedures are presented in this report for constructing a simplified version of the World War II, Imbert wood gas generator. This simple, stratified, downdraft gasifier unit can be constructed from materials that would be widely available in the United States in a prolonged petroleum crisis. For example, the body of the unit consists of a galvanized metal garbage can atop a small metal drum; common plumbing fittings throughout; and a large, stainless steel mixing bowl for the grate. A prototype gasifier unit was fabricated from these instructions. This unit was then mounted onto the front of a gasoline-engine farm tractor and successfully field tested, using wood chips as the only fuel; see [Fig. 1-1](#) (all figures and tables are presented at the end of their respective sections).

Photographic documentation of the actual assembly of the unit, as well as its operational field test, is included in this report.

The use of wood gas generators need not be limited to transportation applications. Stationary engines can also be fueled by wood gasifiers to run electric generators, pumps, and industrial equipment. In fact, the use of wood gas as a fuel is not even restricted to gasoline engines; if a small amount of diesel fuel is

used for ignition, a properly adjusted diesel engine can be operated primarily on wood gas introduced through the intake manifold. However, this report is concerned with the operation of four-cylinder gasoline engines rated from 10 to 150 horsepower. If more information is needed about operating gasifiers on other fuels (such as coal, charcoal, peat, sawdust or seaweed), a list of relevant literature is contained in the Bibliography at the end of this report.

The goal of this report is to furnish information for building a homemade wood gas generator made out of ordinary, available hardware, in order to get tractors, trucks, and other vehicles operating without delay, if a severe liquid fuel emergency should arise. Section 1 describes gasification principles and wood gas generators, in general, and gives some historical background about their operation and effectiveness. Section 2 contains detailed step-by-step instructions for constructing your own wood gas generator unit; illustrations and photographs are included to prevent confusion. Section 3 contains information on operating, maintaining, and trouble-shooting your wood gas generator; also included are some very important guidelines on safety when using your gasifier system.

The wood gasifier design presented in this report has as its origin the proven technology used in World War II during actual shortages of gasoline and diesel fuel. It should be acknowledged that there are alternate technologies (such as methane production or use of alcohol fuels) for keeping internal combustion engines in operation during a prolonged petroleum crisis; the wood gasifier unit described in this report represents only one solution to the problem.

## 1.2 PRINCIPLES OF SOLID FUEL GASIFICATION

All internal combustion engines actually run on vapor, not liquid. The liquid fuels used in gasoline engines are vaporized before they enter the combustion chamber above the pistons. In diesel engines, the fuel is sprayed into the combustion chamber as fine droplets which burn as they vaporize. The purpose of a gasifier, then, is to transform solid fuels into gaseous ones and to keep the gas free of harmful constituents. A gas generator unit is, simultaneously, an energy converter and a filter. In these twin tasks lie its advantages and its difficulties.

The first question many people ask about gasifiers is, 'Where does the combustible gas come from?' Light a wooden match; hold it in a horizontal position; and notice that while the wood becomes charcoal, it is not actually burning but is releasing a gas that begins to burn brightly a short distance away from the matchstick. Notice the gap between the matchstick and the luminous flame; this gap contains the wood gas which starts burning only when properly mixed with air (which contains oxygen). By weight, this gas (wood gas) from the charring wood contains approximately 20% hydrogen ( $H_2$ ), 20% carbon monoxide ( $CO$ ), and small amounts of methane, all of which are combustible, plus 50 to 60% nitrogen ( $N_2$ ). The nitrogen is not combustible; however, it does occupy volume and dilutes the wood gas as it enters and burns in an engine. As the wood gas burns, the products of combustion are carbon dioxide ( $CO_2$ ) and water vapor ( $H_2O$ ).

The same chemical laws which govern combustion processes also apply to gasification. The solid, biomass fuels suitable for gasification cover a wide range, from wood and paper to peat, lignite, and coal, including coke derived from coal. All of these solid fuels are composed primarily of carbon with varying amounts of hydrogen, oxygen, and impurities, such as sulfur, ash, and moisture. Thus, the aim of gasification is the almost complete transformation of these constituents into gaseous form so that only the ashes and inert materials remain.

In a sense, gasification is a form of incomplete combustion; heat from the burning solid fuel creates gases which are unable to burn completely, due to insufficient amounts of oxygen from the available supply of air. In the matchstick example above, as the wood was burned and pyrolyzed into charcoal, wood gas was created, but the gas was also consumed by combustion (since there was an enormous supply of air in the room). In creating wood gas for fueling internal combustion engines, it is important that the gas not only be properly produced, but also preserved and not consumed until it is introduced into the engine where it may be appropriately burned.

Gasification is a physiochemical process in which chemical transformations occur along with the conversion of energy. The chemical reactions and thermochemical conversions which occur inside a wood gas generator are too long and too complicated to be covered here. Such knowledge is not necessary for constructing and operating a wood gasifier. Books with such information are listed in the Reference Section (see, for example, Reed 1979, Vol. II; or Reed and Das 1988).

## 1.3 BACKGROUND INFORMATION

The use of wood to provide heat is as old as mankind; but by burning the wood we only utilize about one-third of its energy. Two-thirds is lost into the environment with the smoke. Gasification is a method of collecting the smoke and its combustible components. Making a combustible gas from coal and wood began around 1790 in Europe. Such manufactured gas was used for street lights and was piped into houses for heating, lighting, and cooking. Factories used it for steam boilers, and farmers operated their machinery on wood gas and coal gas. After the discovery of large petroleum reserves in Pennsylvania in 1859, the entire world changed to oil - a cheaper and more convenient fuel. Thousands of gas works all over the world were eventually dismantled.

Wood gas generators are not technological marvels that can totally eliminate our current dependence on oil, reduce the impacts of an energy crunch, or produce long-term economic relief from high fossil fuel prices, but they are a proven emergency solution when such fuels become unobtainable in case of war, civil upheaval, or natural disaster. In fact, many people can recall a widespread use of wood gas generators during World War II, when petroleum products were not available for the civilian populations in many countries. Naturally, the people most affected by oil and petroleum scarcity made the greatest advancements in wood gas generator technology.

In occupied Denmark during World War II, 95% of all mobile farm machinery, tractors, trucks, stationary engines, fishing and ferry boats were powered by wood gas generators. Even in neutral

Sweden, 40% of all motor traffic operated on gas derived from wood or charcoal (Reed and Jantzen 1979). All over Europe, Asia, and Australia, millions of gas generators were in operation between 1940 and 1946. Because of the wood gasifier's somewhat low efficiency, the inconvenience of operation, and the potential health risks from toxic fumes, most of such units were abandoned when oil again became available in 1945. Except for the technology of producing alternate fuels, such as methane or alcohol, the only solution for operating existing internal combustion engines, when oil and petroleum products are not available, has been these simple, inexpensive gasifier units.

### 1.3.1 The World War II, Imbert Gasifier

The basic operation of two gasifiers is described in this and the following section. Their operating advantages and disadvantages will also be discussed. This information is included for the technically interested reader only; it is intended to give the reader more insight into the subtleties of the operating principles of the wood gas generator described in this manual. Those readers who are anxious to begin construction of their own wood gas generator may skip the material below and proceed directly to [Sect. 2](#) without any loss of continuity.

The constricted hearth, downdraft gasifier shown in [Fig. 1-2](#) is sometimes called the 'Imbert' gasifier after its inventor, Jacques Imbert; although, it has been commercially manufactured under various names. Such units were mass produced during World War II by many European automotive companies, including General Motors, Ford, and Mercedes-Benz. These units cost about \$1500 (1985 evaluation) each. However, after World War II began in 1939, it took six to eight months before factory-made gasifiers were generally available. Thousands of Europeans were saved from certain starvation by home-built, simple gasifier units made from washing machine tubs, old water heaters, and metal gas or oxygen cylinders. Surprisingly, the operation of these units was nearly as efficient as the factory-made units; however, the homemade units lasted for only about 20000 miles with many repairs, while the factory-made units operated, with few repairs, up to 100,000 miles.

In [Fig. 1-2](#), the upper cylindrical portion of the gasifier unit is simply a storage bin or hopper for wood chips or other biomass fuel. During operation, this chamber is filled every few hours as needed. The spring-loaded, airtight cover must be opened to refill the fuel hopper; it must remain closed and sealed during gasifier operation. The spring permits the cover to function as a safety valve because it will pop open in case of any excessive internal gas pressure.

About one-third of the way up from the bottom of the gasifier unit, there is a set of radically directed air nozzles; these allow air to be injected into the wood as it moves downward to be gasified. In a gas generator for vehicle use, the downstroke of the engine's pistons creates the suction force which moves the air into and through the gasifier unit; during startup of the gasifier, a blower is used to create the proper airflow. The gas is introduced into the engine and consumed a few seconds after it is made. This gasification method is called "producer gas generation," because no storage system is used; only that amount of gas demanded by the engine is produced. When the engine is shut off, the production of gas stops.

During normal operation, the incoming air burns and pyrolyzes some of the wood, most of the tars and oils, and some of the charcoal that fills the constricted area below the nozzles. Most of the fuel mass is converted to gas within this combustion zone. The Imbert gasifier is, in many ways, self-adjusting. If there is insufficient charcoal at the air nozzles, more wood is burned and pyrolyzed to make more charcoal. If too much charcoal forms, then the charcoal level rises above the nozzles, and the incoming air burns the charcoal. Thus, the combustion zone is maintained very close to the nozzles.

Below this combustion zone, the resulting hot combustion gases - carbon dioxide ( $\text{CO}_2$ ) and water vapor ( $\text{H}_2\text{O}$ ) - pass into the hot charcoal where they are chemically reduced to combustible fuel gases: carbon monoxide ( $\text{CO}$ ) and hydrogen ( $\text{H}_2$ ). The hearth constriction causes all gases to pass through the reaction zone, thus giving maximum mixing and minimum heat loss. The highest temperatures are reached in this region.

Fine char and ash dust can eventually clog the charcoal bed and will reduce the gas flow unless the dust is removed. The charcoal is supported by a movable grate which can be shaken at intervals. Ash buildup below the grate can be removed during cleaning operations. Usually, wood contains less than 1% ash (by weight). However, as the charcoal is consumed, it eventually collapses to form a powdery charcoal/ash mixture which may represent 2 to 10% (by weight) of the total fuel mass.

The cooling unit required for the Imbert gasifier consists of a water filled precipitating tank and an automotive radiator type gas cooler. The precipitating tank removes all unacceptable tars and most of the fine ash from the gas flow, while the radiator further cools the gas. A second filter unit, containing a fine mesh filtration material, is used to remove the last traces of any ash or dust that may have survived passage through the cooling unit. Once out of the filter unit, the wood gas is mixed with air in the vehicle's carburetor and is then introduced directly into the engine's intake manifold.

The World War II, Imbert gasifier requires wood with a low moisture content (less than 20% by weight) and a uniform, blocky fuel in order to allow easy gravity feed through the constricted hearth. Twigs, sticks, and bark shreds cannot be used. The constriction at the hearth and the protruding air nozzles present obstructions to the passage of the fuel and may create bridging and channeling followed by poor quality gas output, as unpyrolyzed fuel falls into the reaction zone. The vehicle units of the World War II era had ample vibration to jar the carefully sized wood blocks through the gasifier. In fact, an entire industry emerged for preparing wood for use in vehicles at that time (Reed and Jantzen 1979). However, the constricted hearth design seriously limits the range of wood fuel shapes that can be successfully gasified without expensive cubing or pelletizing pretreatment. It is this limitation that makes the Imbert gasifier less flexible for emergency use.

In summary, the World War II Imbert gasifier design has stood the test of time and has successfully been mass produced. It is relatively inexpensive, uses simple construction materials, is easy to fabricate, and can be operated by motorists with a minimum amount of training.



### 1.3.2 The Stratified, Downdraft Gasifier

Until the early 1980's, wood gasifiers all over the world (including the World War II designs) operated on the principle that both the fuel hopper and the combustion unit be airtight; the hopper was sealed with a top or lid that had to be opened every time wood was added. Smoke and gas vented into the atmosphere while new wood was being loaded; the operator had to be careful not to breathe the unpleasant smoke and toxic fumes.

Over the last few years, a new gasifier design has been developed through cooperative efforts among researchers at the Solar Energy Research Institute in Colorado, the University of California in Davis, the Open University in London, the Buck Rogers Company in Kansas, and the Biomass Energy Foundation, Inc., in Florida (Reed and Das 1988). This simplified design employs a balanced, negative-pressure concept in which the old type of sealed fuel hopper is no longer necessary. A closure is only used to preserve the fuel when the engine is stopped. This new technology has several popular names, including 'stratified, downdraft gasification' and 'open top gasification.' Two years of laboratory and field testing have indicated that such simple, inexpensive gasifiers can be built from existing hardware and will perform very well as emergency units.

A schematic diagram of the stratified, downdraft gasifier is shown in [Fig. 1-3](#). During operation of this gasifier, air passes uniformly downward through four zones, hence the name 'stratified:'

1. The uppermost zone contains unreacted fuel through which air and oxygen enter. This region serves the same function as the fuel hopper in the Imbert design.
2. In the second zone, the wood fuel reacts with oxygen during pyrolysis. Most of the volatile components of the fuel are burned in this zone and provide heat for continued pyrolysis reactions. At the bottom of this zone, all of the available oxygen from the air has completely reacted. The open top design ensures uniform access of air to the pyrolysis region.
3. The third zone is made up of charcoal from the second zone. Hot combustion gases from the pyrolysis region react with the charcoal to convert the carbon dioxide and water vapor into carbon monoxide and hydrogen.
4. The inert char and ash, which constitute the fourth zone, are normally too cool to cause further reactions; however, since the fourth zone is available to absorb heat or oxygen as conditions change, it serves both as a buffer and as a charcoal storage region. Below this zone is the grate. The presence of char and ash serves to protect the grate from excessive temperatures.

The stratified, downdraft design has a number of advantages over the World War II, Imbert gasifier. The open top permits fuel to be fed more easily and allows easy access. The cylindrical shape is easy to fabricate and permits continuous flow of fuel. No special fuel shape or pretreatment is necessary; any blocky fuel can be used.

The foremost question about the operation of the stratified, downdraft gasifier concerns char and ash removal. As the charcoal reacts with the combustion gases, it eventually reaches a very low density and

breaks up into a dust containing all of the ash as well as a percentage of the original carbon. This dust may be partially carried away by the gas; however, it might eventually begin to plug the gasifier, and so it must be removed by shaking or agitation. Both the Imbert gasifiers and the stratified concept have a provision for shaking the grate; when they are used to power vehicles, they are automatically shaken by the vehicle's motion.

An important issue in the design of the stratified, downdraft gasifier is the prevention of fuel bridging and channeling. High-grade biomass fuels such as wood blocks or chips will flow down through the gasifier under the influence of gravity, and downdraft air flow. However, other fuels (such as shredded wood, sawdust, and bark) can form a bridge that will prevent continuous flow and cause very high temperatures. Obviously, it is desirable to use these widely available biomass residues. Bridging can be prevented by stirring, shaking, or by agitating the grate or by having it agitated by the vehicle's movement. For prolonged idling, a hand-operated shaker has been included in the design.

A prototype design of the stratified, downdraft gasifier design has been developed. The detailed but simple design is described and illustrated in Section 2 (see Table of Contents), however, it has not been widely tested at this time. The reader is urged to use his ingenuity and initiative in constructing his own wood gas generator. As long as the principle of airtightness in the combustion regions, in the connecting piping, and in the filter units is followed, the form, shape, and method of assembly is not important.

[Back to Table of Contents](#)

**MENU: [HOME](#) » [Reconstruction](#) » [Recovery](#) » [Renewal](#) » [Energy Types](#)**

---

---

# Table of Contents

## [INTRODUCTION](#)

### [2nd Edition Introduction](#)

## [EXECUTIVE SUMMARY](#)

### [S.1. PRINCIPLES OF SOLID FUEL GASIFICATION](#)

### [S.2. THE STRATIFIED, DOWNDRAFT GASIFIER](#)

## [CONVERSION FACTORS FOR SI UNITS](#)

## [LIST OF FIGURES](#)

## [LIST OF TABLES](#)

## [ABSTRACT](#)

### [1. WHAT IS A WOOD GAS GENERATOR AND HOW DOES IT WORK?](#)

#### [1.1. PRINCIPLES](#)

#### [1.2. PRINCIPLES OF SOLID FUEL GASIFICATION](#)

#### [1.3. BACKGROUND INFORMATION](#)

##### [1.3.1. The World War II, Imbert Gasifier](#)

##### [1.3.2. The Stratified, Downdraft Gasifier](#)

### [2. BUILDING YOUR OWN WOOD GAS GENERATOR](#)

#### [2.1. BUILDING THE GAS GENERATOR UNIT AND THE FUEL HOPPER](#)

#### [2.2. BUILDING THE PRIMARY FILTER UNIT.](#)

#### [2.3. BUILDING THE CARBURETING UNIT WITH THE AIR AND THROTTLE CONTROLS](#)

### [3. OPERATING AND MAINTAINING YOUR WOOD GAS GENERATOR](#)

#### [3.1. USING WOOD AS A FUEL](#)

- 3.2. [SPECIAL CONSIDERATIONS AND ENGINE MODIFICATIONS](#)
- 3.3. [INITIAL START-UP PROCEDURE](#)
- 3.4. [ROUTINE START-UP PROCEDURE](#)
- 3.5. [DRIVING AND NORMAL OPERATION](#)
- 3.6. [SHUTTING DOWN THE GASIFIER UNIT](#)
- 3.7. [ROUTINE MAINTENANCE](#)
  - 3.7.1 [Daily Maintenance](#)
  - 3.7.2 [Weekly Maintenance \(or every 15 hours of operation\)](#)
  - 3.7.3 [Biweekly Maintenance \(or every 30 hours of operation\)](#)
- 3.8. [OPERATING PROBLEMS AND TROUBLE-SHOOTING](#)
- 3.9. [HAZARDS ASSOCIATED WITH GASIFIER OPERATION](#)
  - 3.9.1. [Toxic Hazards](#)
  - 3.9.2. [Technical Aspects of "Generator Gas, Poisoning"](#)
  - 3.9.3. [Fire Hazard](#)

## [BIBLIOGRAPHY](#)

**MENU: [HOME](#) » [Reconstruction](#) » [Recovery](#) » [Renewal](#) » [Energy Types](#)**

---

---

**MENU:** [HOME](#) » [Reconstruction](#) » [Recovery](#) » [Renewal](#) » [Energy Types](#)

# INTRODUCTION TO 2<sup>nd</sup> EDITION

This construction manual was prepared by my friend and colleague, Harry LaFontaine for the Federal Emergency Management Agency, FEMA, assisted by F.P. Zimmerman at the Oak Ridge national Laboratory. The justification for writing this report was that in the event of a war or natural emergency, when liquid fuel supplies were interrupted, individuals could build gasifiers to run engines for transport and power. The manual was originally distributed by FEMA. This edition is the first edition by the Biomass Energy Foundation Press.

Harry was uniquely qualified to write this manual because he built and operated gasifiers during World War II during the daytime as a cover for his Danish Underground activities at night. Harry was also very ingenious in working with the people and materials at hand, so that this is a very practical manual. However, in the intervening years he also came to appreciate the fundamentals of gasification and he also explains these here.

It has been a pleasure to know and work with Harry. He was the founder of the Biomass Energy Foundation in 1983. The BEF is a 501 3C not for profit organization established to promote the use of Biomass.

It grieves me to say that Harry died (while still in the midst of many projects) on April 12, 1994. However, this report lives on as a very useful memorial to his life and experience.

Thomas B. Reed

The Biomass Energy Foundation Press 1810 Smith Rd. Golden, CO.

[Back to Table of Contents](#)

**MENU:** [HOME](#) » [Reconstruction](#) » [Recovery](#) » [Renewal](#) » [Energy Types](#)

---

---

# Executive summary

This report is one in a series of emergency technology assessments sponsored by the Federal Emergency Management Agency (FEMA). The purpose of this report is to develop detailed, illustrated instructions for the fabrication, installation, and operation of a biomass gasifier unit (i.e. a "producer gas" generator, also called a "wood gas" generator) which is capable of providing emergency fuel for vehicles, such as tractors and trucks, should normal petroleum sources be severely disrupted for an extended period of time. These instructions have been prepared as a manual for use by any mechanic who is reasonably proficient in metal fabrication or engine repair.

Fuel gas, produced by the reduction of coal and peat, was used for heating as early as 1840 in Europe and by 1884 had been adapted to fuel engines in England. Prior to 1940, gas generator units were a familiar, but not extensively utilized, technology. However, petroleum shortages during World War II led to widespread gas generator applications in the transportation industries of Western Europe. (Charcoal burning taxis, a related application, were still common in Korea as late as 1970.) The United States, never faced with such prolonged or severe oil shortages, has lagged far behind Europe and the Orient in familiarity with and application of this technology. However, a catastrophic event could disrupt the supply of petroleum in this country so severely that this technology might be critical in meeting the energy needs of some essential economic activities, such as the production and distribution of food.

In occupied Denmark during World War II, 95% of all mobile farm machinery, tractors, trucks, stationary engines, and fishing and ferry boats were powered by wood gas generator units. Even in neutral Sweden, 40% of all motor traffic operated on gas derived from wood or charcoal. All over Europe, Asia, and Australia, millions of gas generators were in operation between 1940f and 1946. Because of the wood gasifier's health risks from toxic fumes, most of such units were abandoned when it again became available in 1945. Except for the technology of producing alternate fuels, such as methane or alcohol, the only solution for operating existing internal combustion engines, when oil and petroleum products are not available, has been these simple, inexpensive gasifiers units.

This report attempts to preserve the knowledge about wood gasification that was put into practical use during World War II. In this report, detailed step-by-step procedures are presented for constructing a simplified version of the WWII wood gas generator; this simple, stratified, downdraft gasifier unit (shown schematically in [Fig. S-1](#)) can be constructed from materials which would be widely available in the United States in a prolonged petroleum crisis. For example, the body of the unit consists of a galvanized metal garbage can atop a small metal drum; common plumbing fittings are used throughout; and a large, stainless steel mixing bowl is used for the grate. A prototype gasifier unit was fabricated from these instructions (see [Fig. S-2](#)); this unit was then mounted onto the front of a farm tractor and successfully field tested, using wood chips as the only fuel (see [Fig. S-3](#)). Photographic documentation of the actual assembly of the unit, as well as its operational field test, is included in the body of this report.

The use of wood gas generators need not be limited to transportation applications. Stationary engines can also be fueled by wood gasifiers to run electric generators, pumps, and industrial equipment. In fact, the use of wood gas as a fuel is not even restricted to gasoline engines; if a small amount of diesel fuel is used for ignition, a properly adjusted diesel engine can be operated primarily on wood gas introduced through the intake manifold.

## S.1 Principles of solid fuel gasification

All internal combustion engines actually run on vapor, not liquid. The liquid fuels used by gasoline engines are vaporized before they enter the combustion chamber above the pistons. In diesel engines, the fuel is sprayed into the combustion chamber as fine droplets which burn as they vaporize. The purpose of a gasifier, then, is to transform solid fuels into gaseous ones and to keep the gas free of harmful constituents. A gas generator unit is simultaneously an energy converter and a filter. In these twin tasks lie its advantages and its difficulties.

In a sense, gasification is a form of incomplete combustion-heat from the burning solid fuel creates gases which are unable to burn completely because of the insufficient amounts of oxygen from the available supply of air. The same chemical laws which govern combustion processes also apply to gasification. There are many solid biomass fuels suitable for gasification - from wood and paper to peat, lignite, and coal, including coke derived from coal. All of these solid fuels are composed primarily of carbon with varying amounts of hydrogen, oxygen, and impurities, such as sulfur, ash, and moisture. Thus, the aim of gasification is the almost complete transformation of these constituents into gaseous form so that only the ashes and inert materials remain. In creating wood gas for fueling internal combustion engines, it is important that the gas not only be properly produced, but also preserved and not consumed until it is introduced into the engine where it may be appropriately burned.

Gasification is a physiochemical process in which chemical transformations occur along with the conversion of energy. The chemical reactions and thermochemical conversions which occur inside a wood gas generator are too long and too complicated to be covered here; however, such knowledge is not necessary for constructing and operating a wood gasifier. By weight, gas (wood gas) produced in a gasifier unit contains approximately 20% hydrogen ( $H_2$ ), 20% carbon monoxide ( $CO$ ), and small amounts of methane, all of which are combustible, plus 50 to 60% nitrogen ( $N_2$ ). The nitrogen is not combustible; however, it does occupy volume and dilutes the wood gas as it enters and burns in an engine. As the wood gas burns, the products of combustion are carbon dioxide ( $CO_2$ ) and water vapor ( $H_2O$ ).

One of the by-products of wood gasification is carbon monoxide, a poisonous gas. The toxic hazards associated with breathing this gas should be avoided during refueling operations or prolonged idling, particularly in inadequately ventilated areas. Except for the obvious fire hazard resulting from the combustion processes inside the unit, carbon monoxide poisoning is the major potential hazard during

normal operation of these simplified gasifier units.

## S.2. THE STRATIFIED DOWNDRAFT GASIFIER

Until the early 1980s, wood gasifiers all over the world (including the World War II designs) operated on the principle that both the fuel hopper and the combustion unit be absolutely airtight; the hopper was sealed with a top or lid which had to be opened every time wood was added. Smoke and gas vented into the atmosphere while wood was being loaded; the operator had to be careful not to breathe the unpleasant smoke and toxic fumes.

Over the last few years, a new gasifier design has been developed through cooperative efforts among researchers at the Solar Energy Research Institute in Colorado, the University of California in Davis, the Open University in London, the Buck Rogers Company in Kansas, and the Biomass Energy Foundation, Inc., in Florida. This simplified design employs a balanced, negative-pressure concept in which the old type of sealed fuel hopper is no longer necessary. A closure is only used to preserve the fuel when the engine is stopped. This new technology has several popular names, including "stratified, downdraft gasification" and "open top gasification." Several years of laboratory and field testing have indicated that such simple, inexpensive gasifiers can be built from existing hardware and will perform very well as emergency units.

A schematic diagram of the stratified, downdraft gasifier is shown in [Fig. S-1](#). During operation of this gasifier, air passes uniformly downward through four zones, hence the name stratified:

1. The uppermost zone contains unreacted fuel through which air and oxygen enter. This region serves the same function as the fuel hopper in the older, World War II designs.
2. In the second zone, the wood fuel reacts with oxygen during pyrolysis. Most of the volatile components of the fuel are burned in this zone and provide heat for continued pyrolysis reactions. At the bottom of this zone, all of the available oxygen from the air should be completely reacted. The open top design ensures uniform access of air to the pyrolysis region.
3. The third zone is made up of charcoal from the second zone. Hot combustion gases from the pyrolysis region react with the charcoal to convert the carbon dioxide and water vapor into carbon monoxide and hydrogen.
4. The inert char and ash, which constitute the fourth zone, are normally too cool to cause further reactions; however, because the fourth zone is available to absorb heat or oxygen as conditions change, it serves both as a buffer and as a charcoal storage region. Below this zone is the grate. The presence of char and ash serves to protect the grate from excessive temperatures.

The stratified, downdraft design has a number of advantages over the World War II gasifier designs. The



open top permits fuel to be fed more easily and allows easy access. The cylindrical shape is easy to fabricate and permits continuous flow of fuel. No special fuel shape or pretreatment is necessary; any blocky fuel can be used.

The foremost question about the operation of the stratified, downdraft gasifier concerns char and ash removal. As the charcoal reacts with the combustion gases, it eventually reaches a very low density and breaks up into a dust containing all of the ash as well as a percentage of the original carbon. This dust may be partially carried away by the gas and might eventually begin to plug the gasifier. Hence, it must be removed by shaking or agitation. When the stratified gasifier unit is used to power vehicles, it is automatically shaken by the vehicle's motion.

An important issue in the design of the stratified, downdraft gasifier is the prevention of fuel bridging and channeling. High grade biomass fuels, such as wood blocks or chips, will flow down through the gasifier because of gravity and downdraft air flow. However, other fuels (such as shredded chips, sawdust, and bark) can form a bridge, which will obstruct continuous flow and cause very high temperatures. Bridging can be prevented by stirring, shaking, or by agitating the grate or by having it agitated by the vehicle's movement. For prolonged idling, a hand-operated shaker has been included in the design in this report.

A prototype unit of the stratified, downdraft gasifier design (se Figs. [S-2](#) and [S-3](#)) has been fabricated according to the instructions in this report; however, it has not been widely tested at this time. The reader is urged to use his ingenuity and initiative in the construction of his own wood gas generator. As long as the principle of airtightness in the combustion regions, in the connecting piping, and in the filter units is followed, the form, shape, and method of assembly is not important.

The wood gasifier design presented in this report has as its origin the proven technology used in World War II during actual shortages of gasoline and diesel fuel. It should be acknowledged that there are alternate technologies (such as methane production or use of alcohol fuels) for keeping internal combustion engines in operation during a prolonged petroleum crisis; the wood gasifier unit described in this report represents only one solution to the problem.

[Back to Table of Contents](#)

**MENU: [HOME](#) » [Reconstruction](#) » [Recovery](#) » [Renewal](#) » [Energy Types](#)**

---

---

## CONVERSION FACTORS FOR SI UNITS

English units have been retained in the body of this report. The report refers to commercially available materials and sizes which are commonly expressed in English units. The conversion factors for SI (Standard International - metric) units are given below:

<b>To convert from</b>	<b>TO</b>	<b>Multiply by</b>
cubic feet (ft.)	cubic meters (m <sup>3</sup> )	0.0283
cubic yards (yd.)	cubic meters (m <sup>3</sup> )	0.7646
Fahrenheit degrees (OF)	Kelvin degrees (K)	(see Note 1)
foot (ft)	meter (m)	0.3048
gallon (gal)	cubic meters (m <sup>3</sup> )	3.785 * 10 <sup>-3</sup>
horsepower (hp)	watt (W)	745.7
inch (in.)	meter (m)	0.0254
pound (lb.)	kilogram (kg)	0.4536
quart (qt.)	cubic meters (m <sup>3</sup> )	9.464 * 10 <sup>-4</sup>

Note I: To convert temperatures, use the following equation,

$$K = 273 + 0.5556 X (F - 32),$$

where F is the temperature in Fahrenheit degrees, and K is the temperature in Kelvin degrees.

[Back to Table of Contents](#)

# LIST OF FIGURES

[Fig. S-1.](#) Schematic view of the stratified, downdraft gasifier

[Fig. S-2.](#) The prototype wood gas generator unit mounted onto a tractor

[Fig. S-3.](#) Wood gas generator unit in operation during field testing

[Fig. 1-1.](#) Wood gas generator unit in operation during field testing

[Fig. 1-2.](#) Schematic view of the World War II, Imbert gasifier

[Fig. 1-3.](#) Schematic view of the stratified, downdraft gasifier

[Fig. 2-1.](#) The prototype wood gas generator unit mounted onto a tractor

[Fig. 2-2.](#) Exploded, schematic diagram of the wood gas generator unit and the fuel hopper

[Fig. 2-3.](#) The fire tube and circular top plate of the gasifier unit

[Fig. 2-4.](#) Drilling holes into the stainless steel mixing bowl to be used for the grate

[Fig. 2-5.](#) Chains attached to the lip of the stainless steel mixing bowl

[Fig. 2-6.](#) Connect the mixing bowl to the top plate with chains

[Fig. 2-7.](#) Braze, do not weld, the plumbing fittings to the, thin walled drums

[Fig. 2-8.](#) Exploded, schematic diagram of the grate shaking mechanism

[Fig. 2-9.](#) Parts for the shaker assembly

[Fig. 2-10.](#) The support frame can be brazed or bolted to the side of the gasifier unit

[Fig. 2-11.](#) Containers used in constructing the prototype gasifier unit

[Fig. 2-12.](#) Cover for the fuel hopper

[Fig. 2-13.](#) Operating configuration of the fuel hopper and it's cover

[Fig. 2-14.](#) Lock ring and welded tabs

[Fig. 2-15.](#) Exploded, schematic diagram of the filter unit

[Fig. 2-16.](#) Detail of the standoffs for the bottom plate of the filter unit

[Fig. 2-17.](#) Divider plate (#1) and bottom plate (#3), with standoffs (#4), for the filter unit

[Fig. 2-18.](#) Circular lid (#1) for the filter unit

[Fig. 2-19.](#) Blower (#1) with exhaust extension assembly

[Fig. 2-20.](#) Assembled and installed blower (#1), extension assembly (#4), and conduit connectors for gas inlet (#2) and outlet (#3) on lid of filter unit

[Fig. 2-21.](#) Filter container (#1) showing latches (#2) for lid and hose (#3) around top

[Fig. 2-22.](#) Exploded, schematic diagram of the carbureting unit and control valves

[Fig. 2-23.](#) Schematic diagram of a butterfly control valve

[Fig. 2-24.](#) Parts required for the butterfly valve

[Fig. 2-25.](#) Butterfly valve assembly

[Fig. 2-26.](#) Assembled butterfly valves

[Fig. 2-27.](#) Assembled carburetion unit

[Fig. 2-28.](#) Carburetion unit attached to engine's existing intake manifold

[Fig. 3-1.](#) Virtually all varieties of wood chips can be used for fuel

[Fig. 3-2.](#) Ignite a single piece of newspaper to start the gasifier unit; push the flaming newspaper through the ignition port and directly into the grate

[Fig. 3-3.](#) Igniting the exhaust gas will demonstrate that the gasifier unit is working properly

[Fig. 3-4.](#) Refill the fuel hopper before it becomes two-thirds empty

[Fig. 3-5.](#) The lid must be used to cover the fuel hopper in wet weather or when shutting the unit down

[Back to Table of Contents](#)

**MENU:** [HOME](#) » [Reconstruction](#) » [Recovery](#) » [Renewal](#) » [Energy Types](#)

---

---

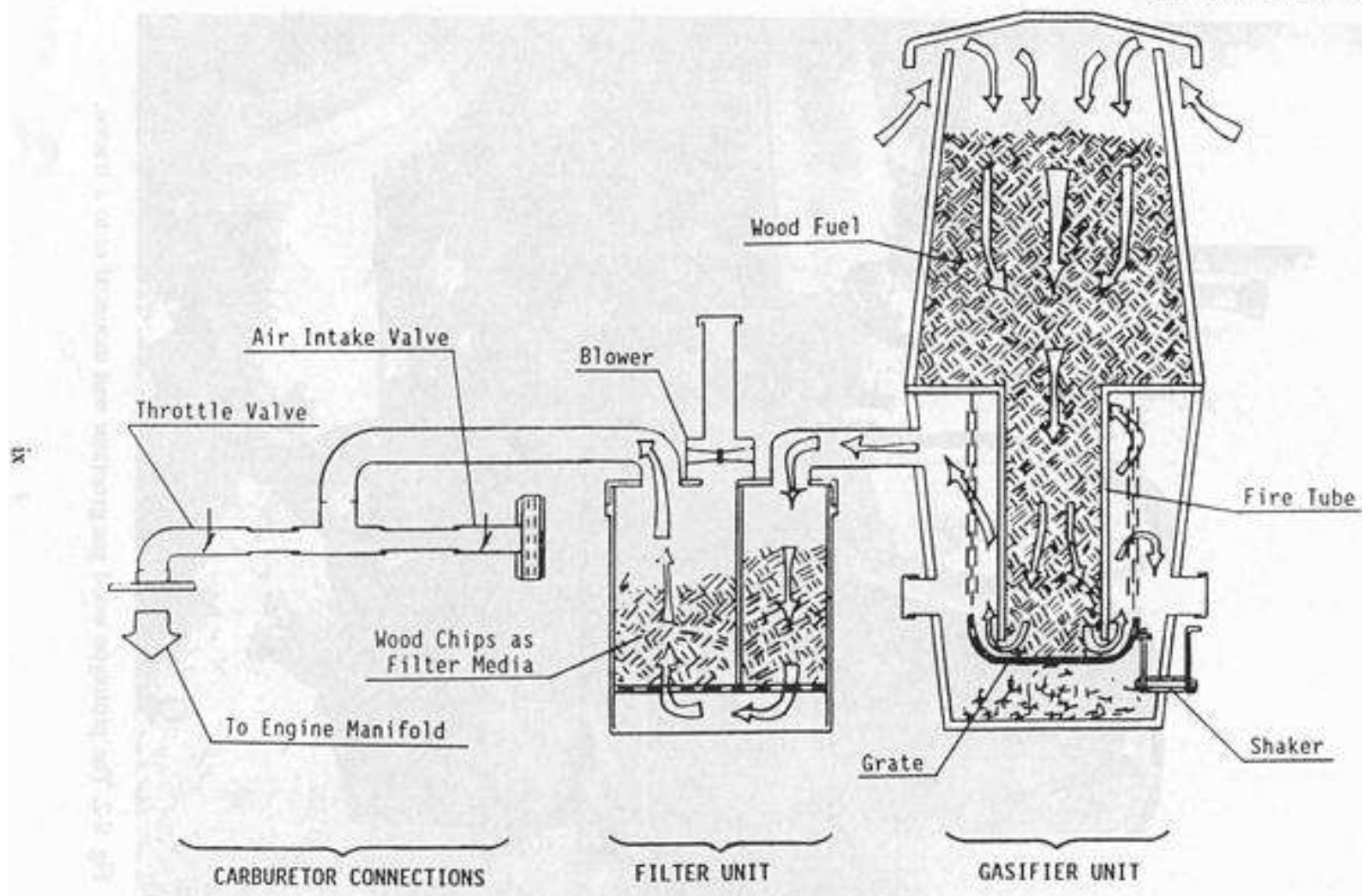


Fig. S-1. Schematic view of the stratified, downdraft gasifier.

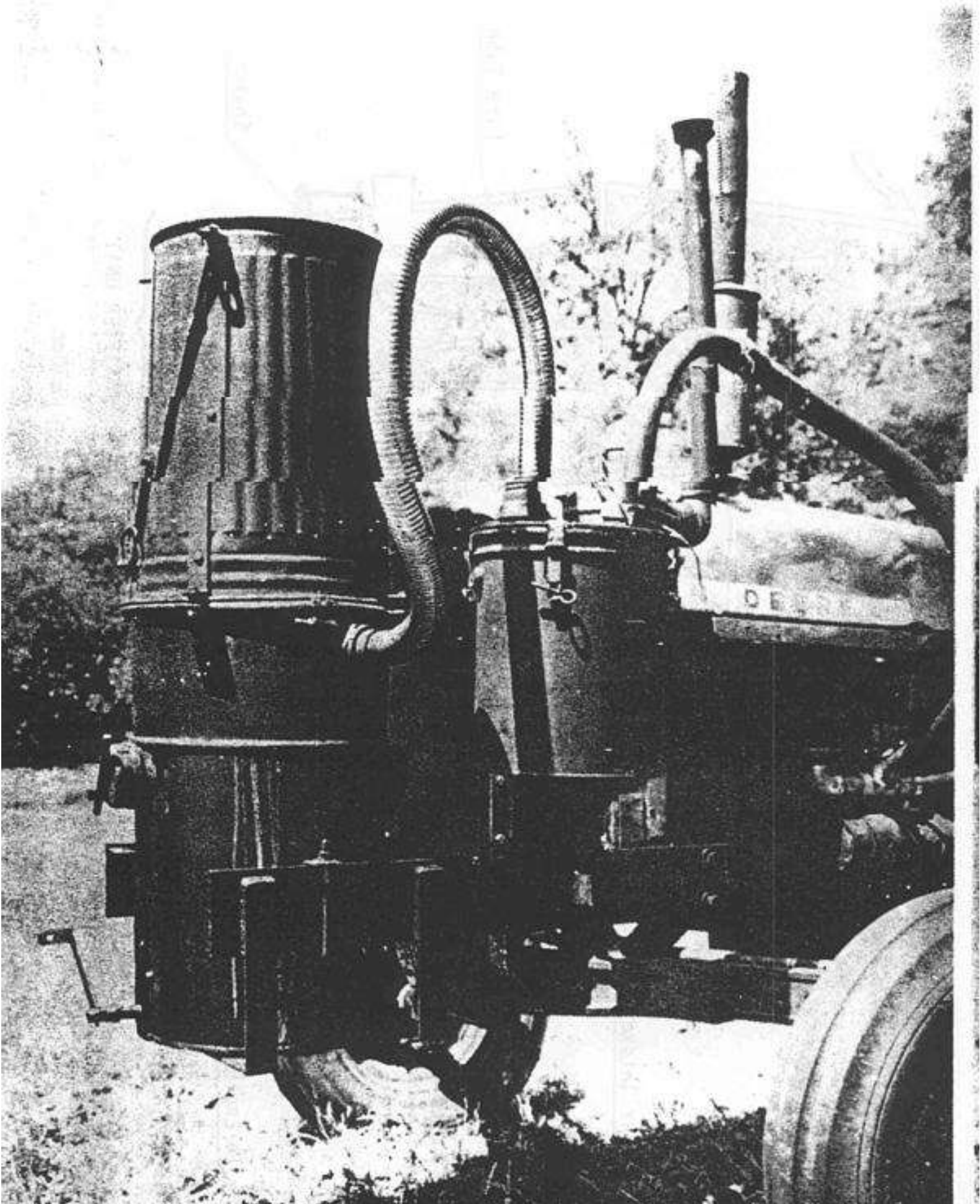




Fig. S-2. The prototype wood gas generator unit mounted onto a tractor.

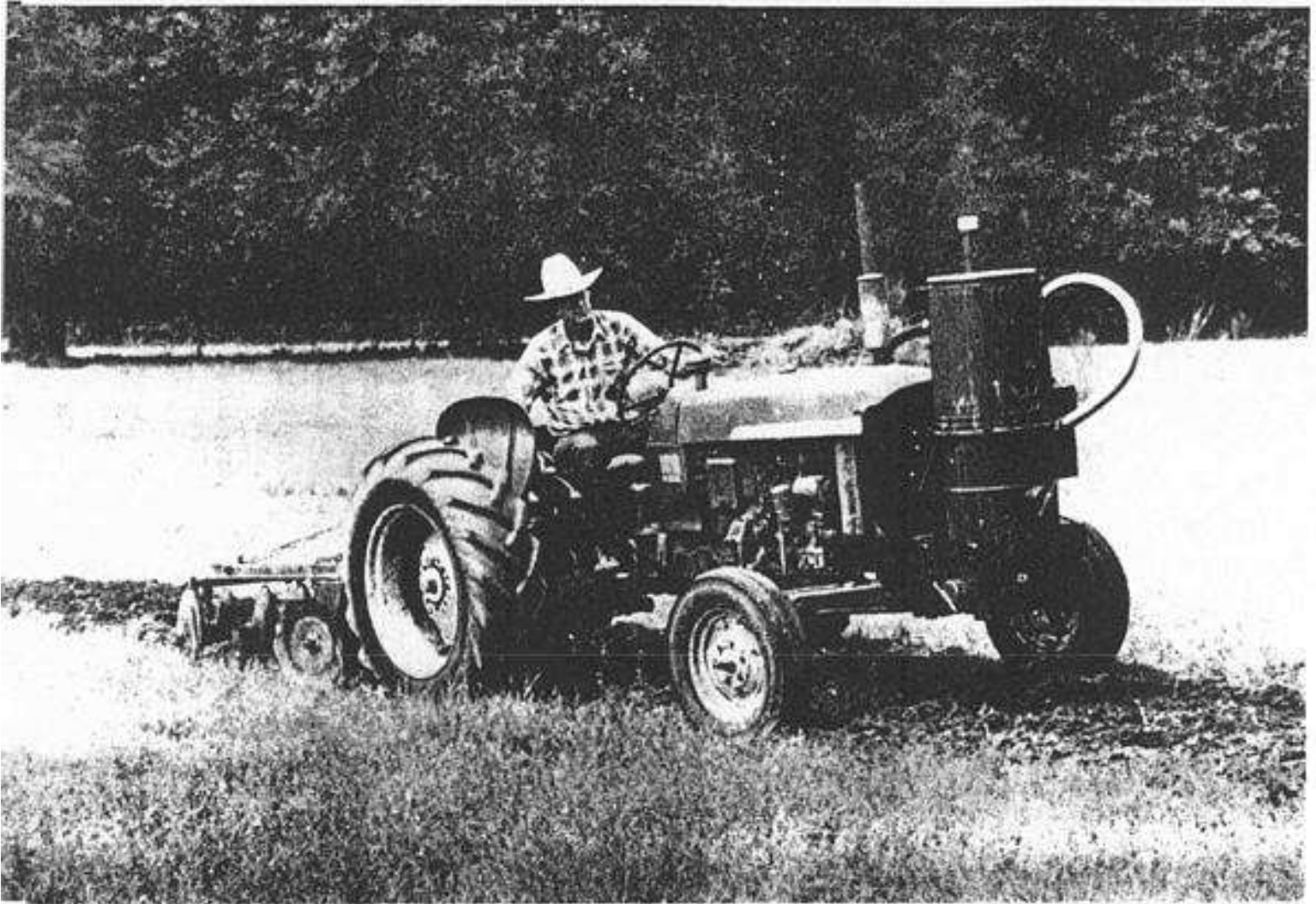


Fig. S-3. Wood gas generator unit in operation during field testing.



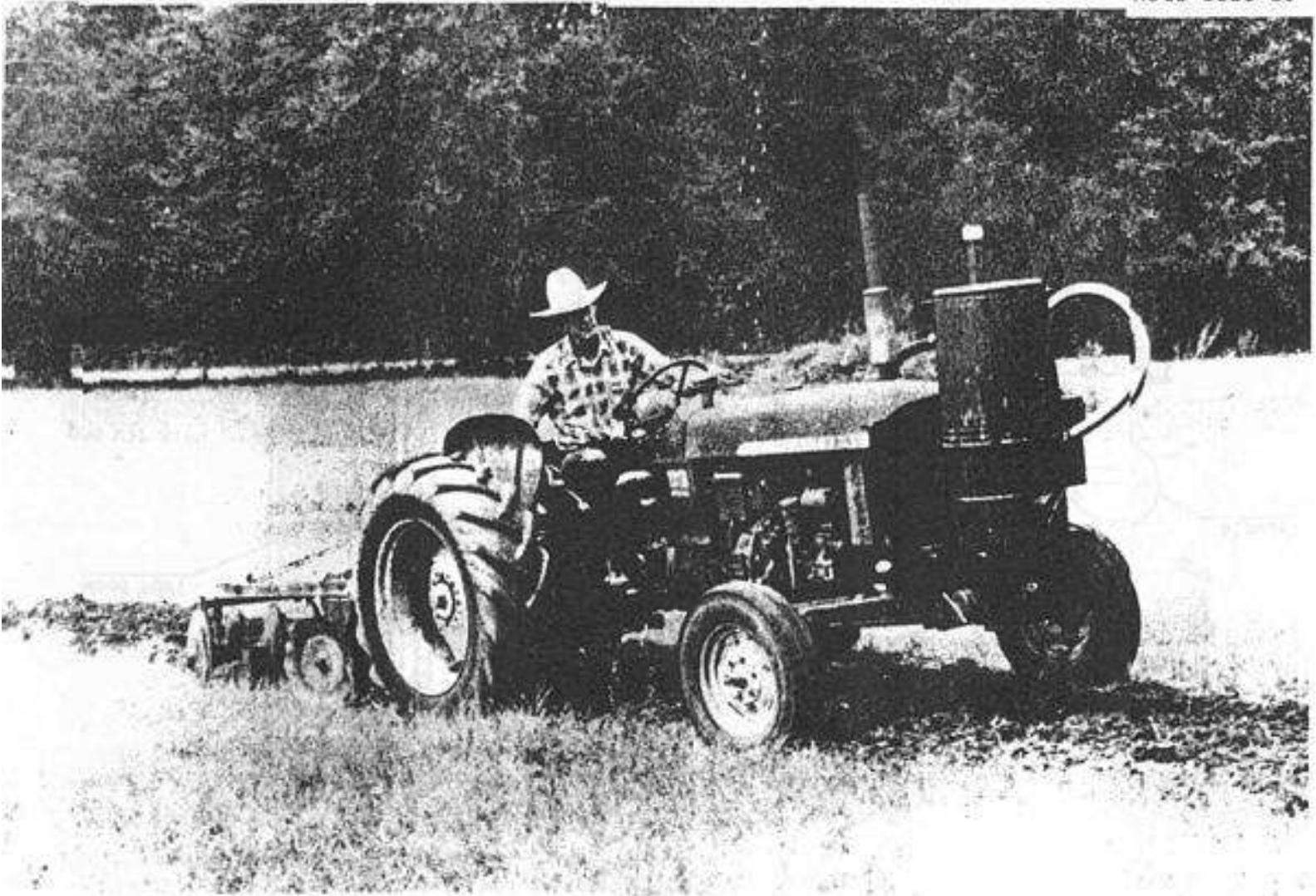


Fig. 1-1. Wood gas generator unit in operation during field testing.

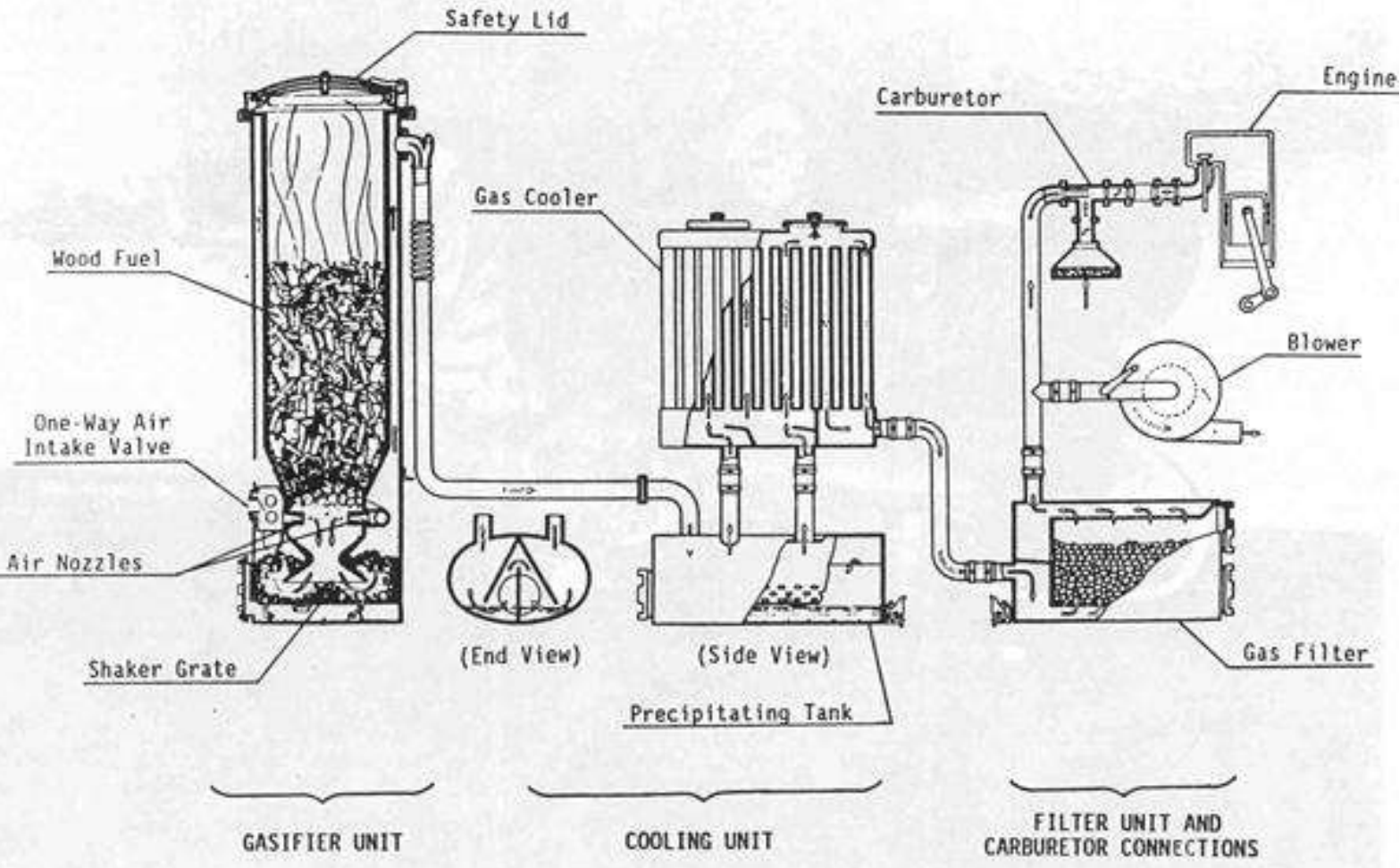


Fig. 1-2. Schematic view of the World War II, Imbert gasifier.

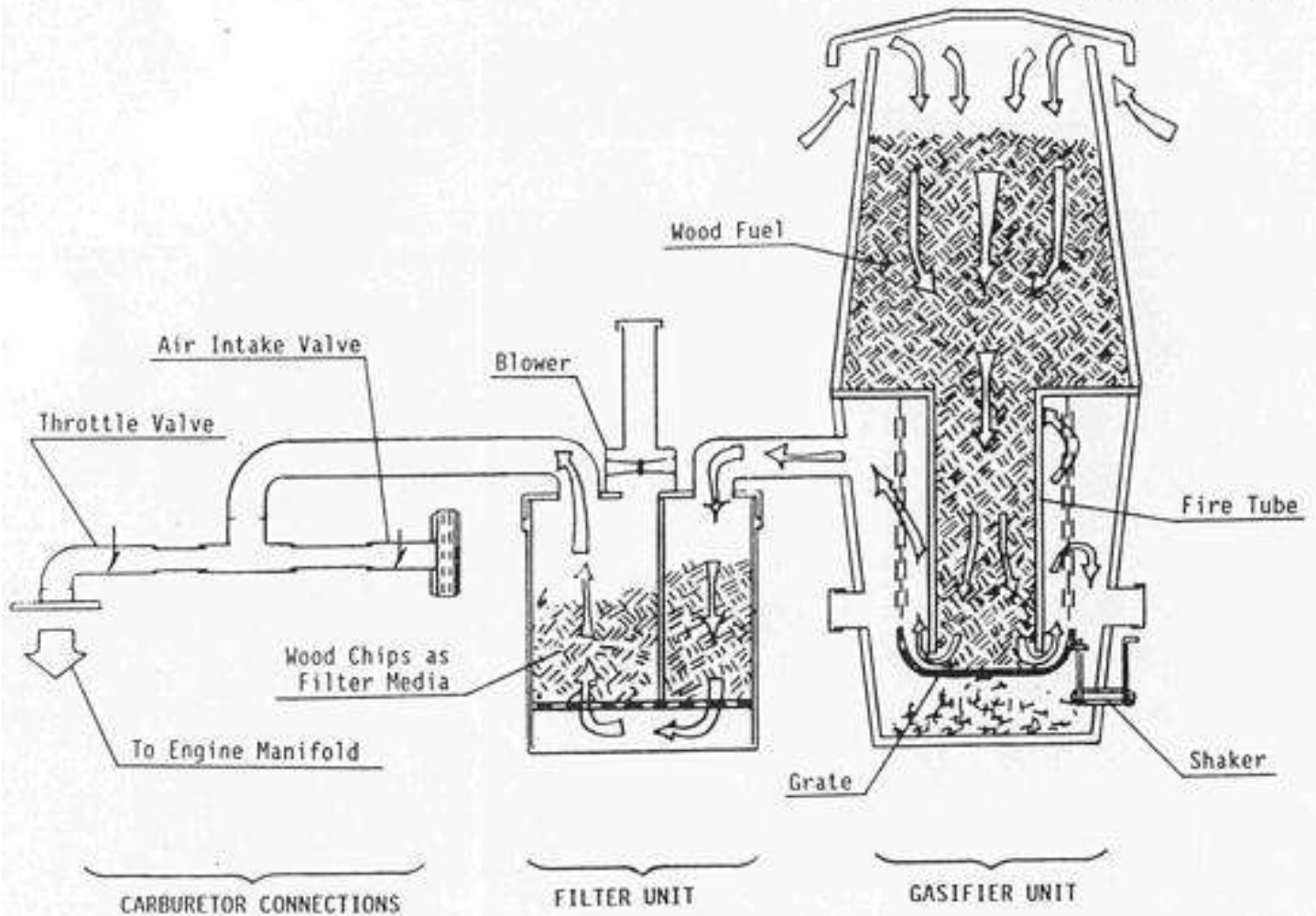


Fig. 1-3. Schematic view of the stratified, downdraft gasifier.

ORNL-Photo 5321-86

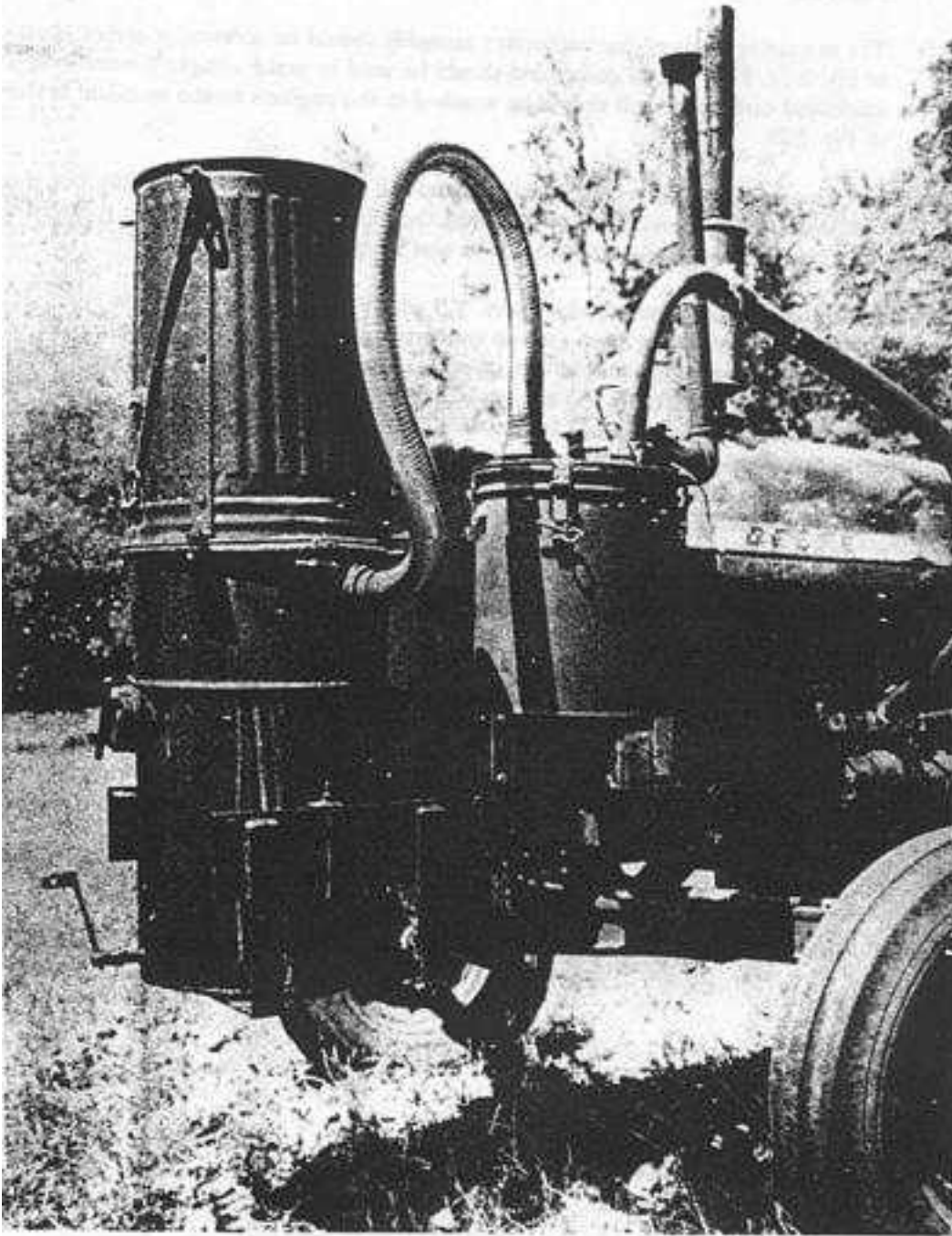


Fig. 2-1. The prototype wood gas generator unit mounted onto a tractor.

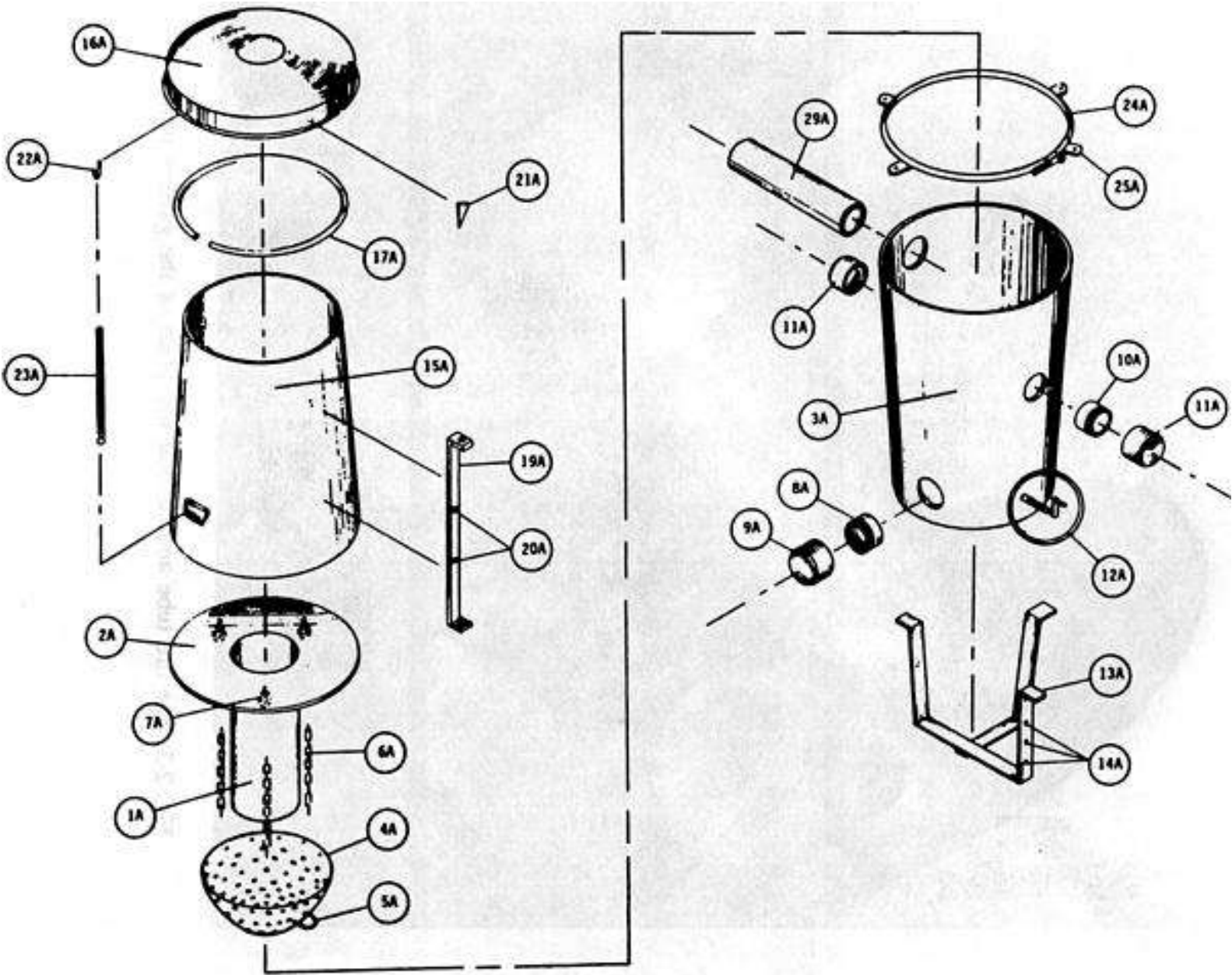


Fig. 2-2. Exploded, schematic diagram of the wood gas generator unit and the fuel hopper.

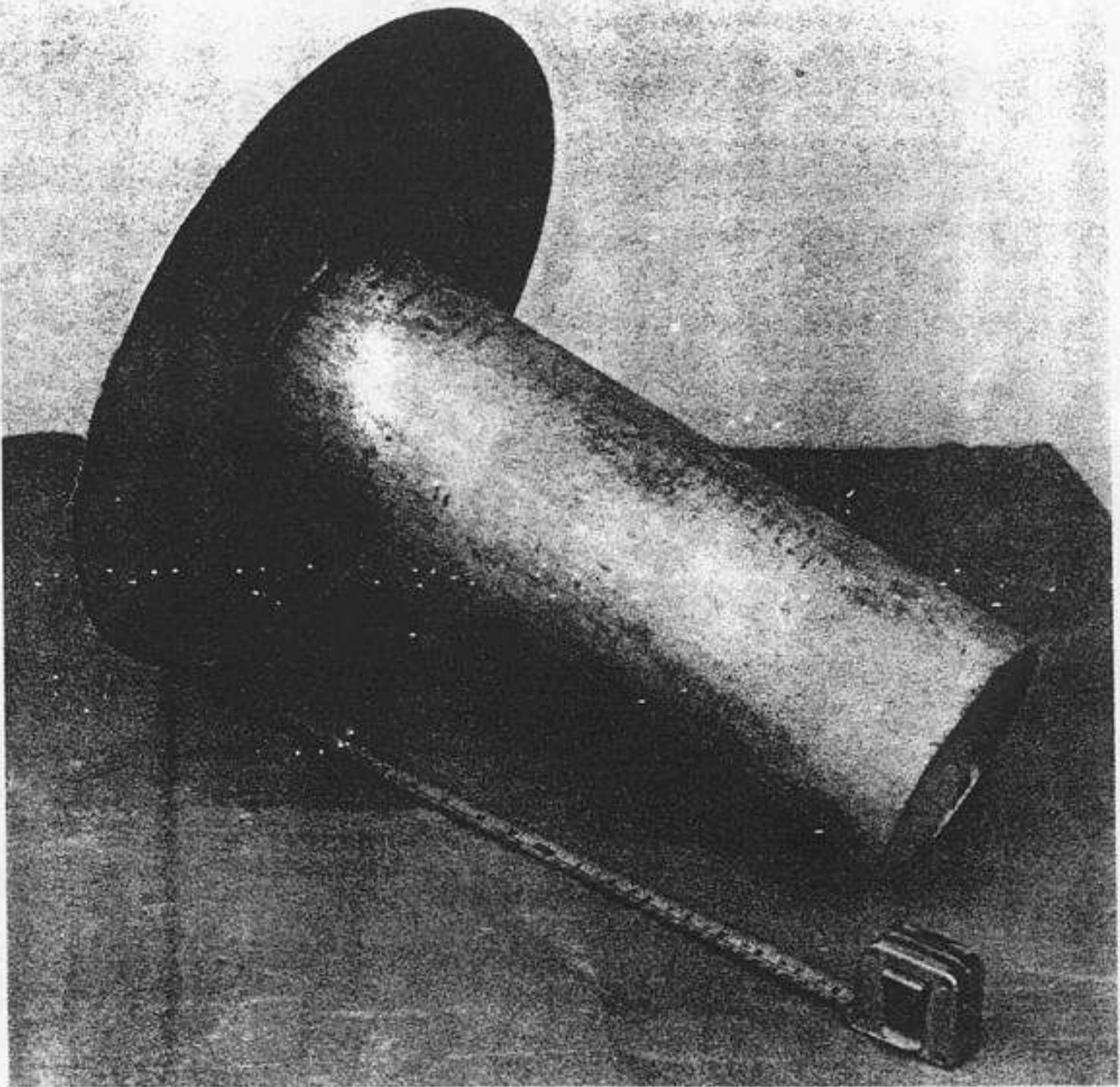


Fig. 2-3. The fire tube and circular top plate of the gasifier unit.

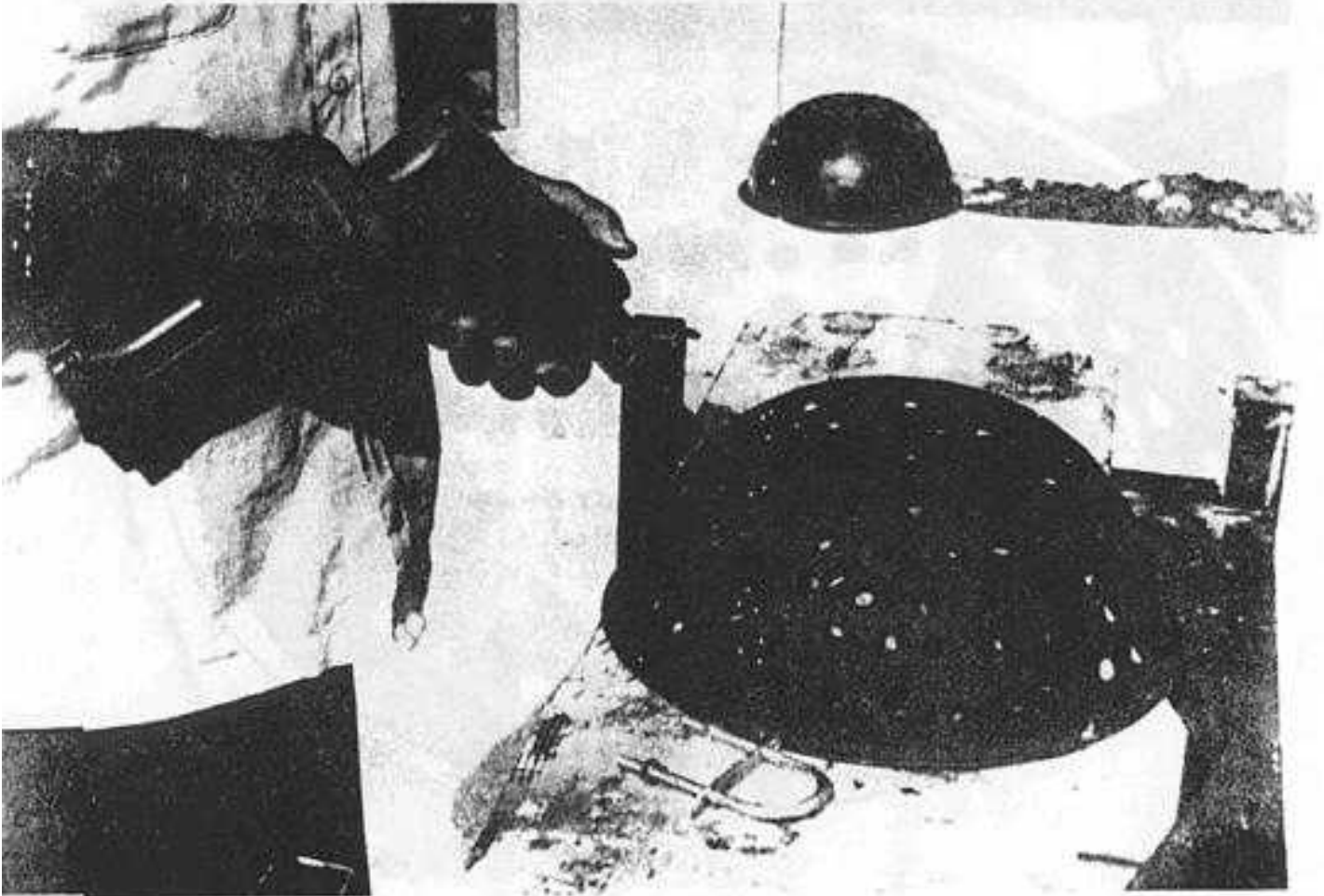


Fig. 2-4. Drilling holes into the stainless steel mixing bowl to be used for the grate. Note the U-bolt in the foreground.

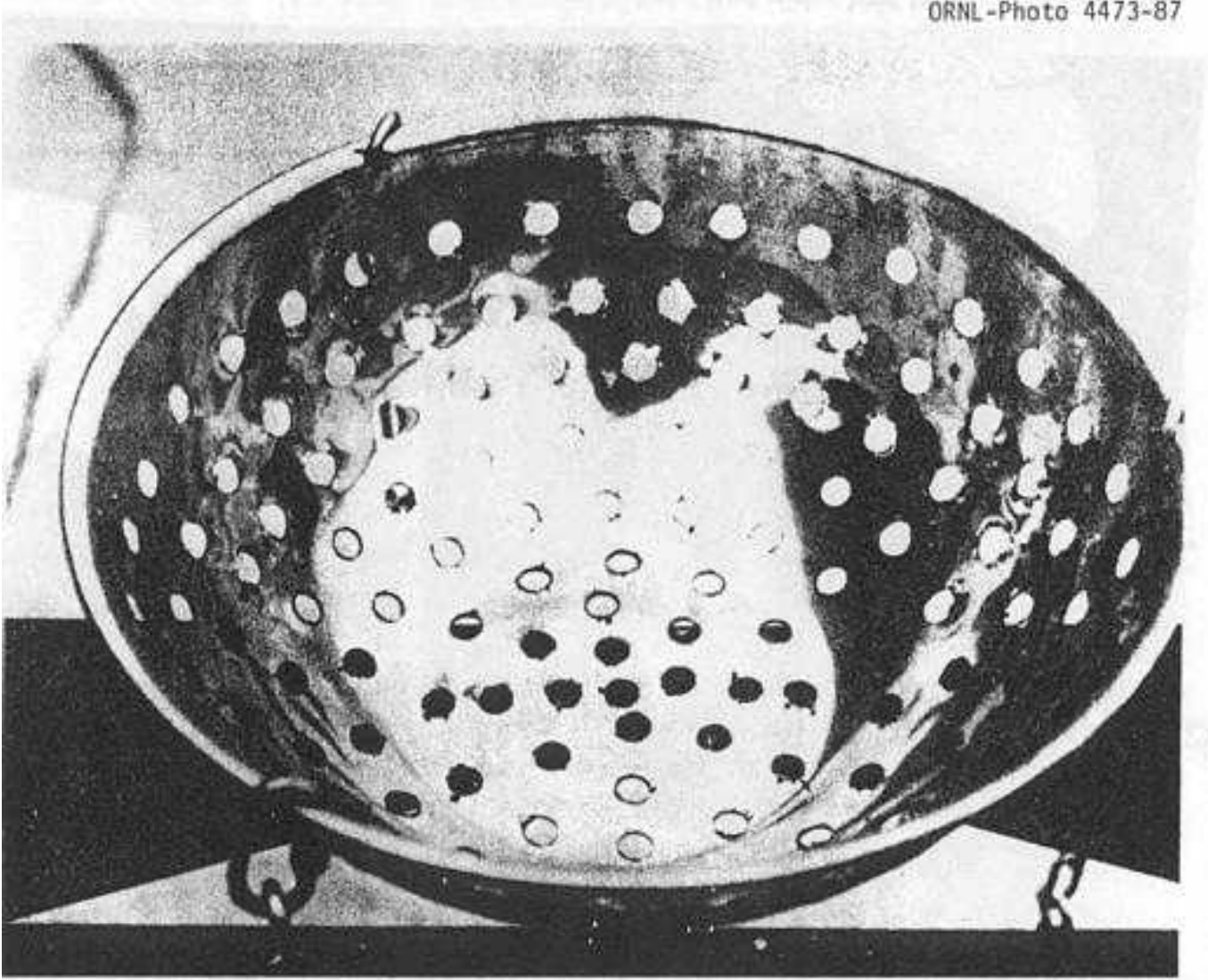
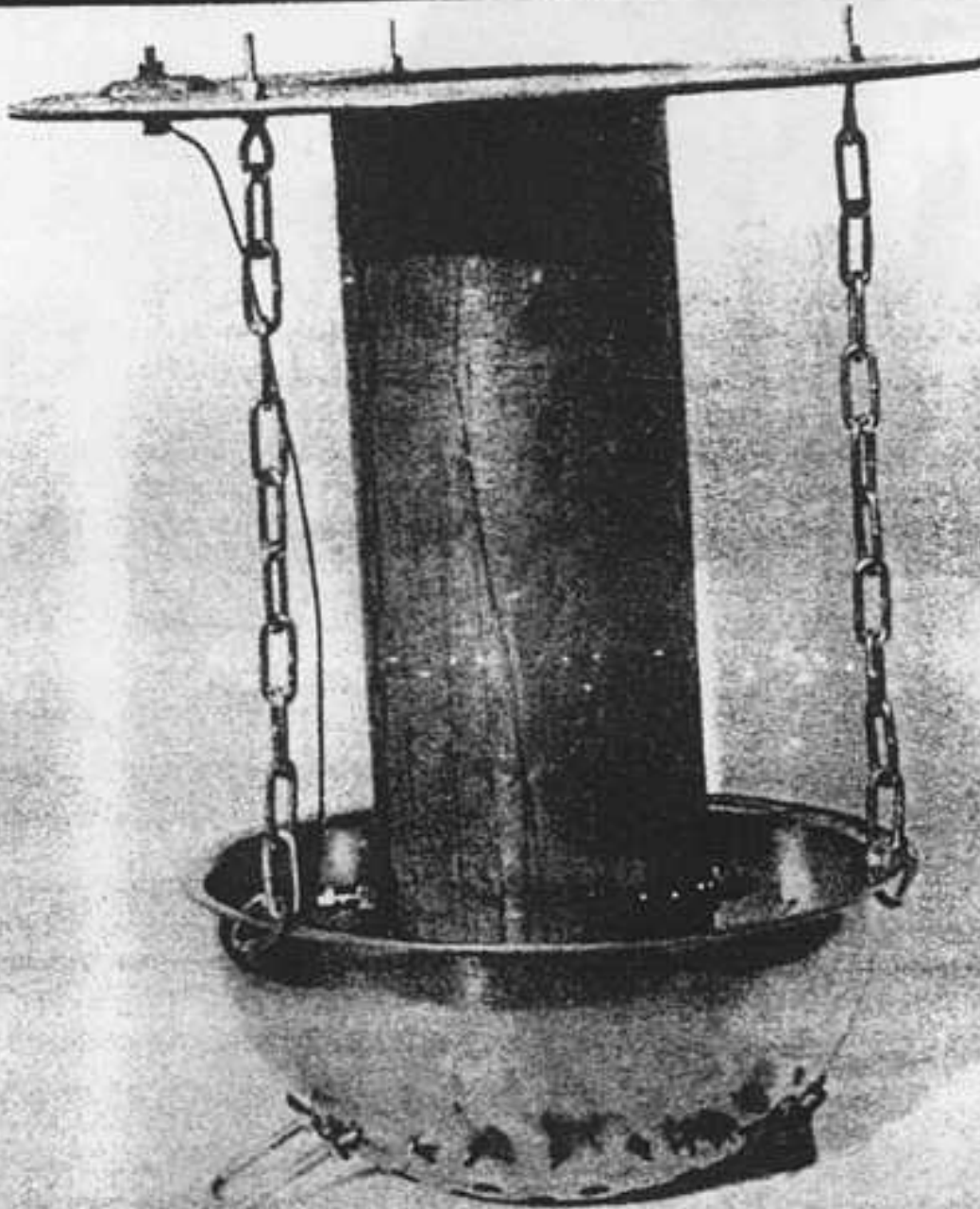


Fig. 2-5. Chains attached to the lip of the stainless steel mixing bowl.





**Fig. 2-6.** Connect the mixing bowl to the top plate with chains. Note that the diesel ignitor "glow plugs" shown in this photograph were included for experimentation only; they were abandoned in the final prototype design.

ORNL-Photo 4529-87

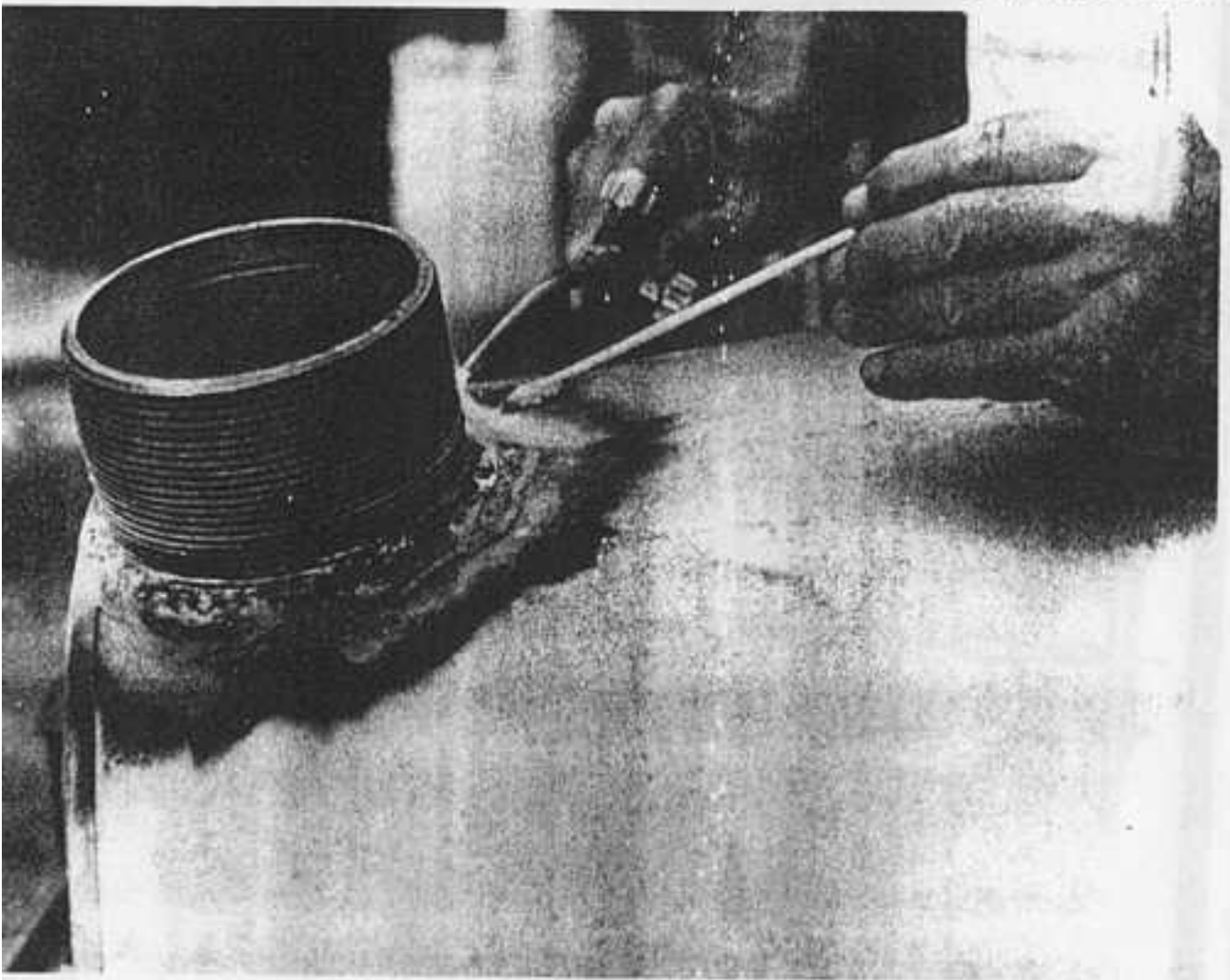
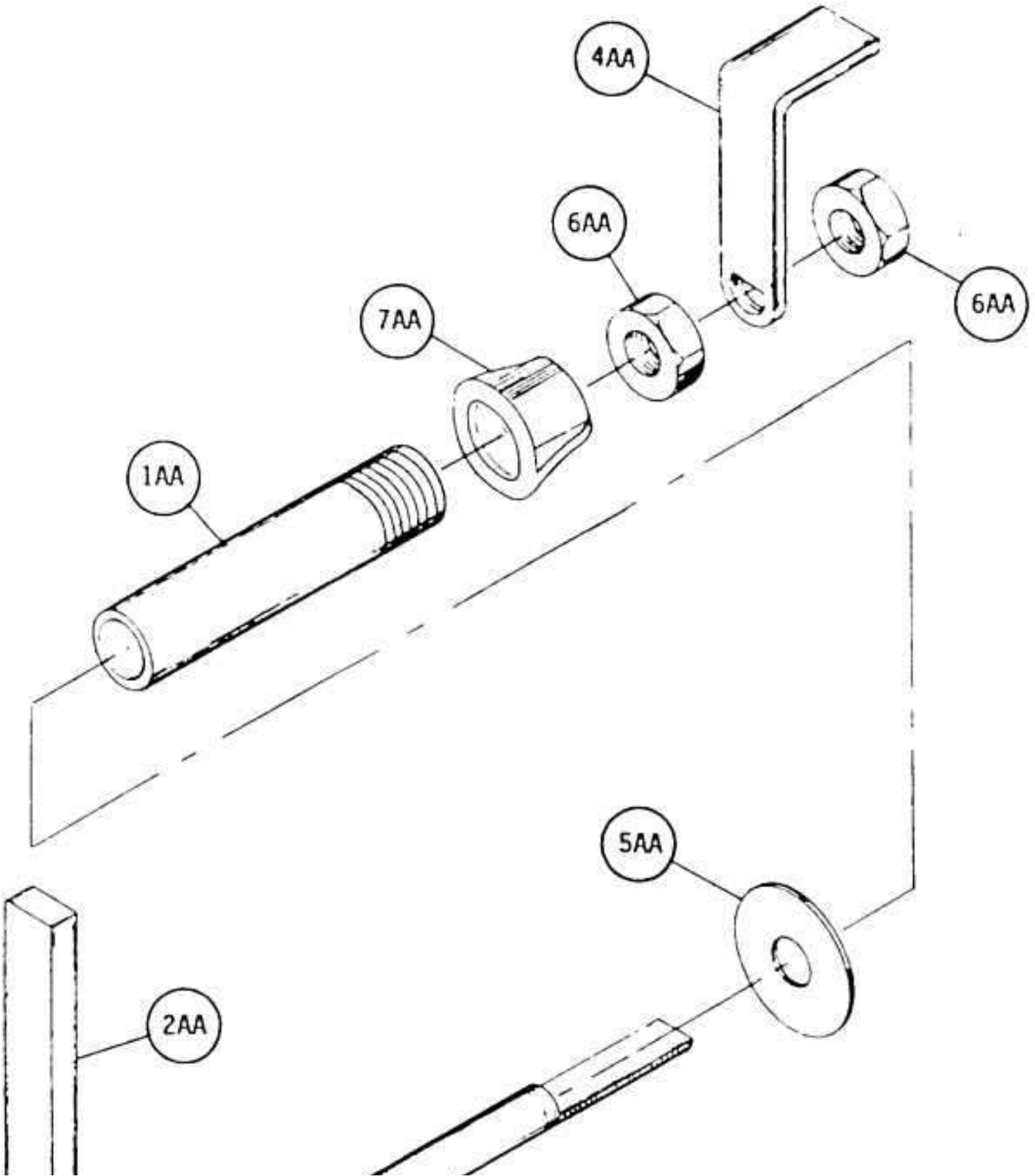


Fig. 2-7. Braze, do not weld, the plumbing fittings to the thin walled drums.



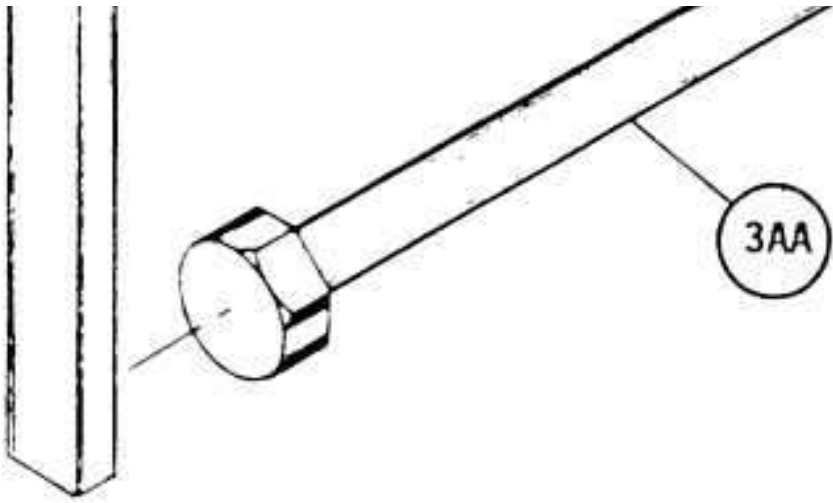


Fig. 2-8. Exploded, schematic diagram of the grate shaking mechanism.

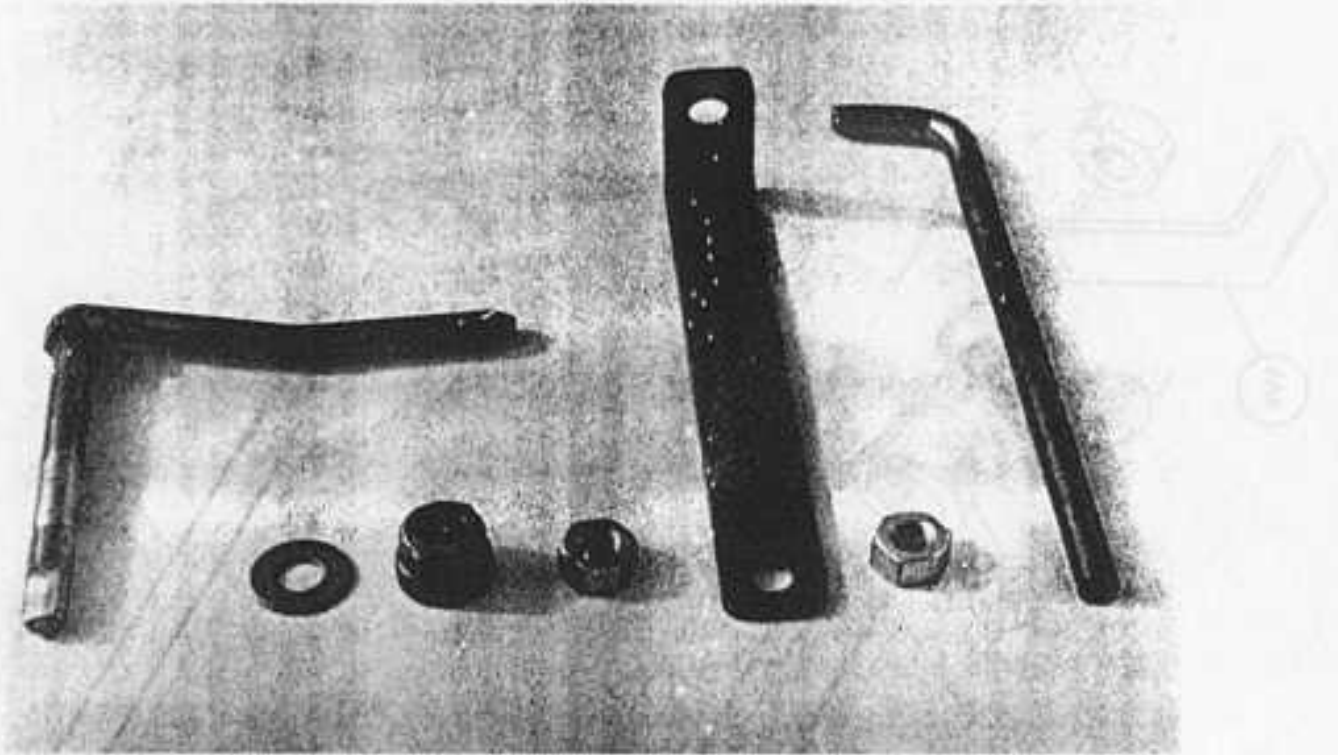
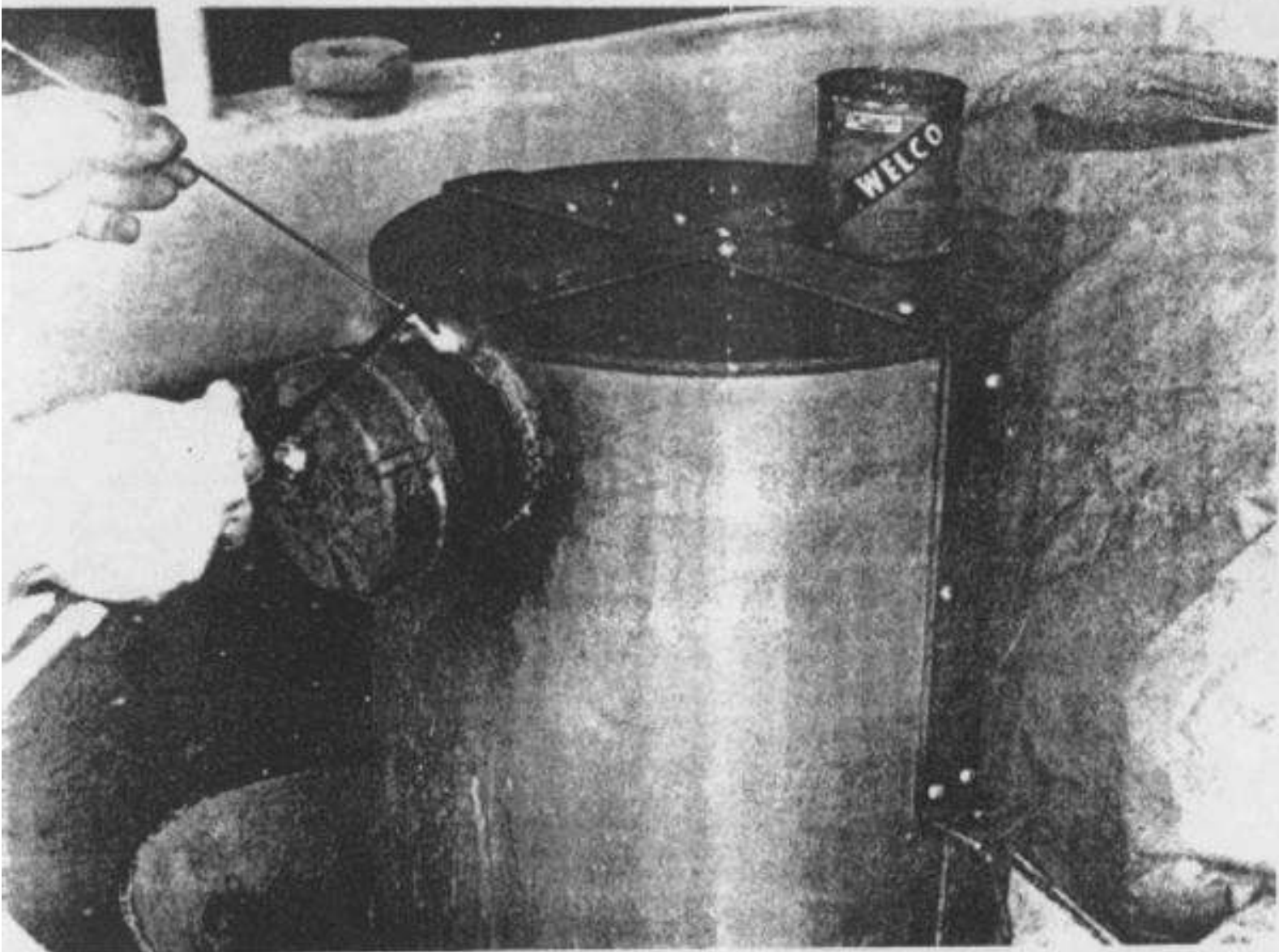


Fig. 2-9. Parts for the shaker assembly. Note the flattened portion of the bolt (at extreme left) which positively locks into the handle (third from right). At the extreme right is a "poker bar" which engages into the hole in the top of the handle to operate the shaker mechanism; the shaker handle will get very hot during normal gasifier operation.



**Fig. 2-10.** The support frame can be brazed or bolted to the side of the gasifier unit. All bolts should be sealed air tight.

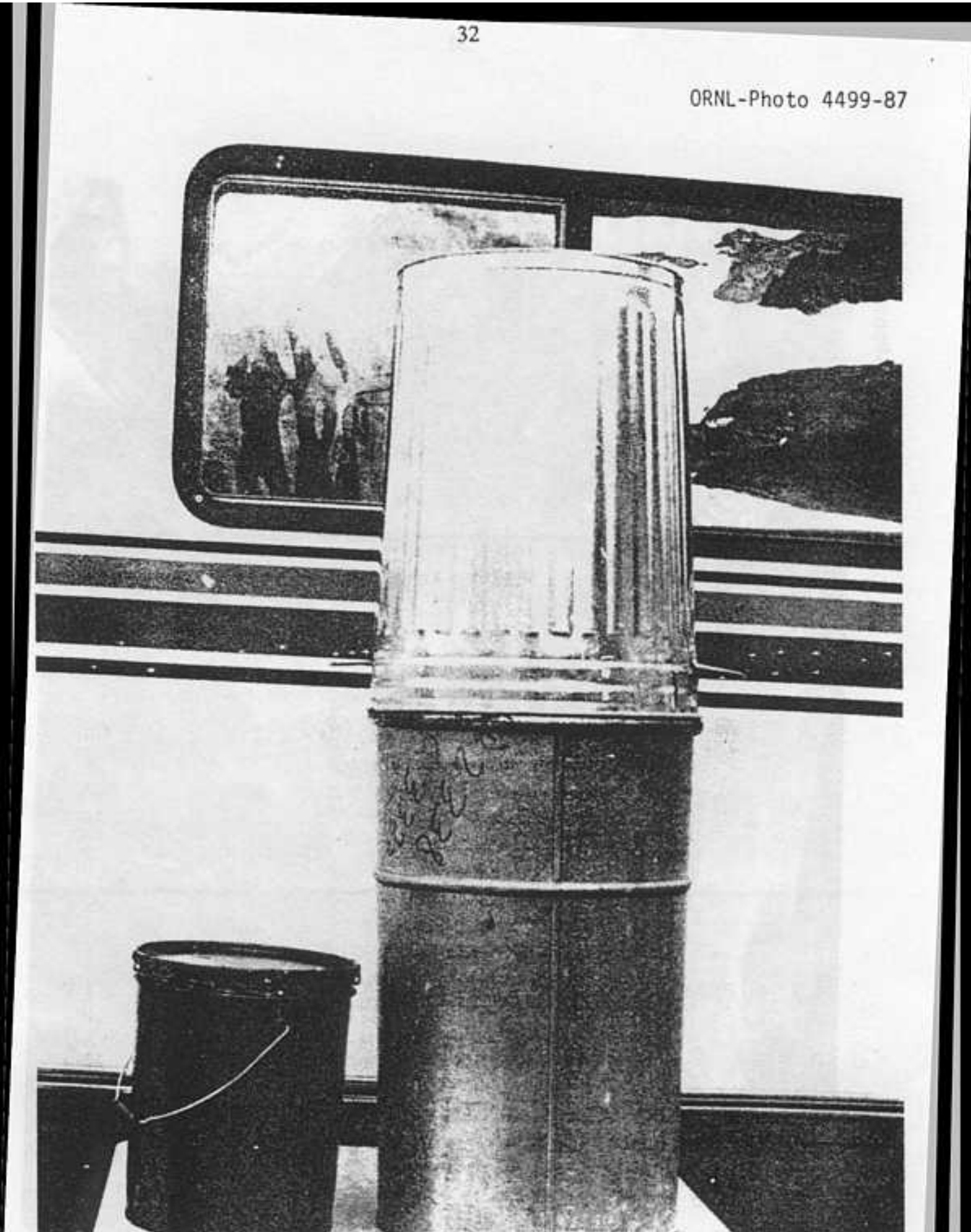




Fig. 2-11. Containers used in constructing the prototype gasifier unit. At right, a 20-gal garbage can (the fuel hopper) is shown on top of a 30-gal metal drum (the gasifier unit housing). The 5-gal paint can, at left, is used as the filter container.



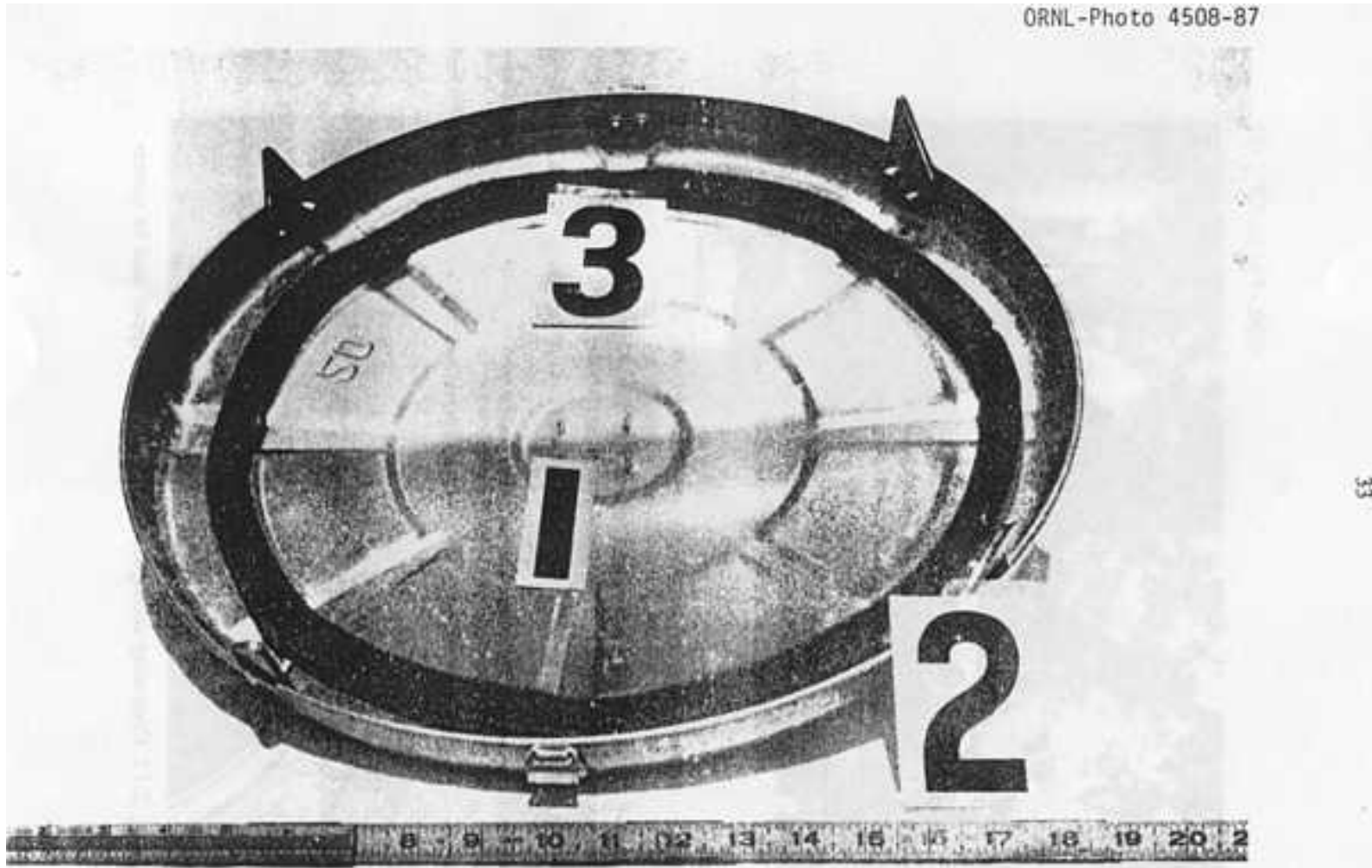
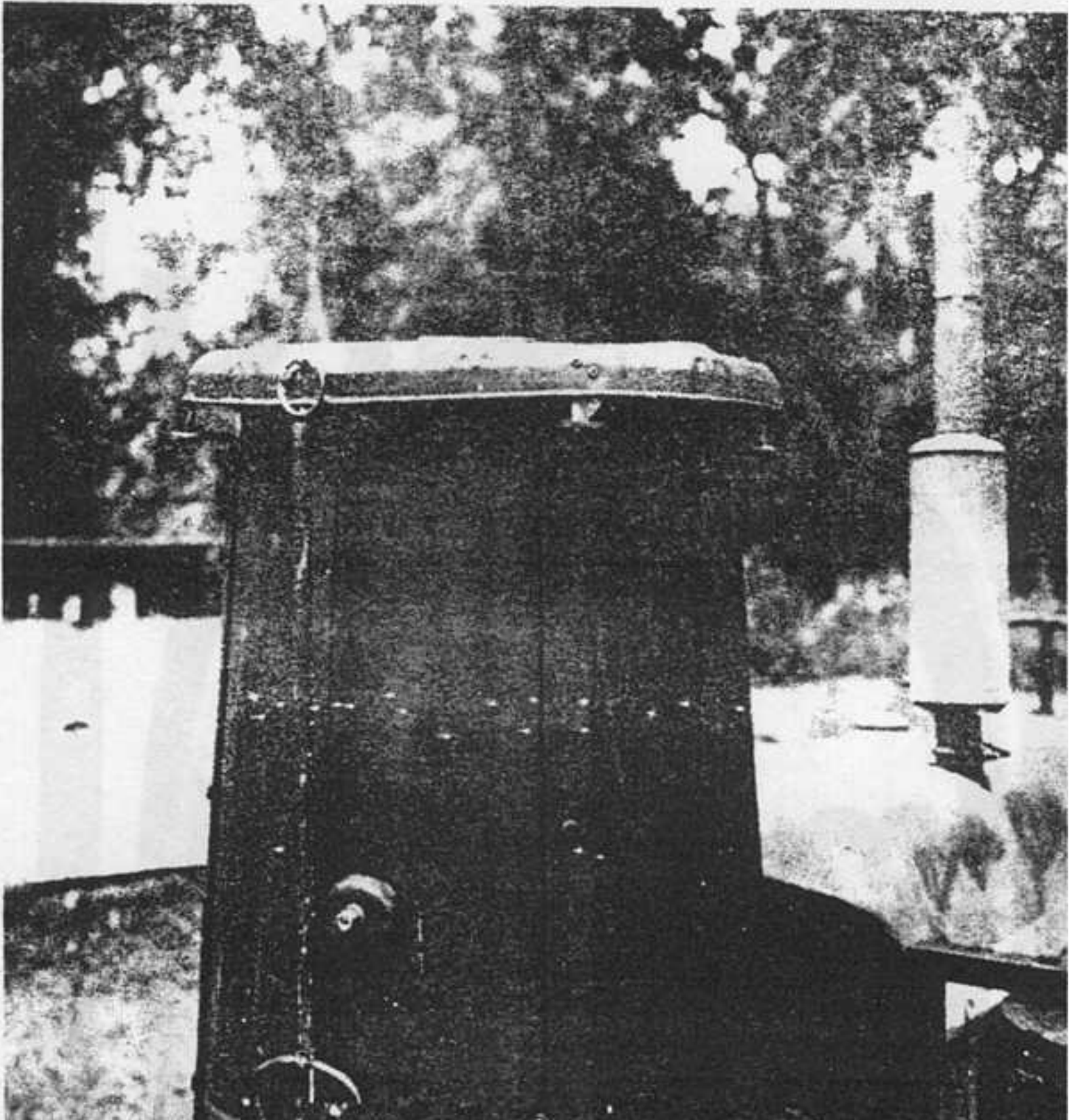


Fig. 2-12. Cover for the fuel hopper. Note the foam weatherstripping (#3) attached to the underside of the lid where it contacts the fuel hopper. Attach four standoffs (#2) to the lid (#1) as shown.



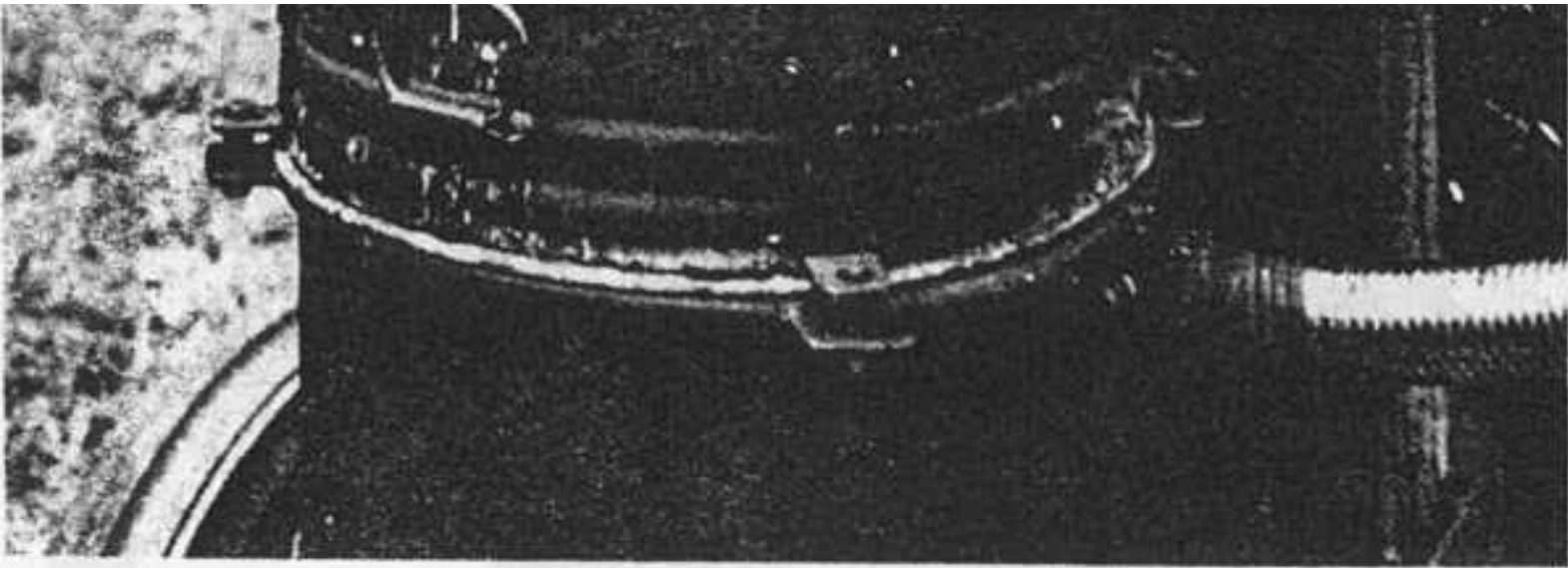


Fig. 2-13. Operating configuration of the fuel hopper and its cover.

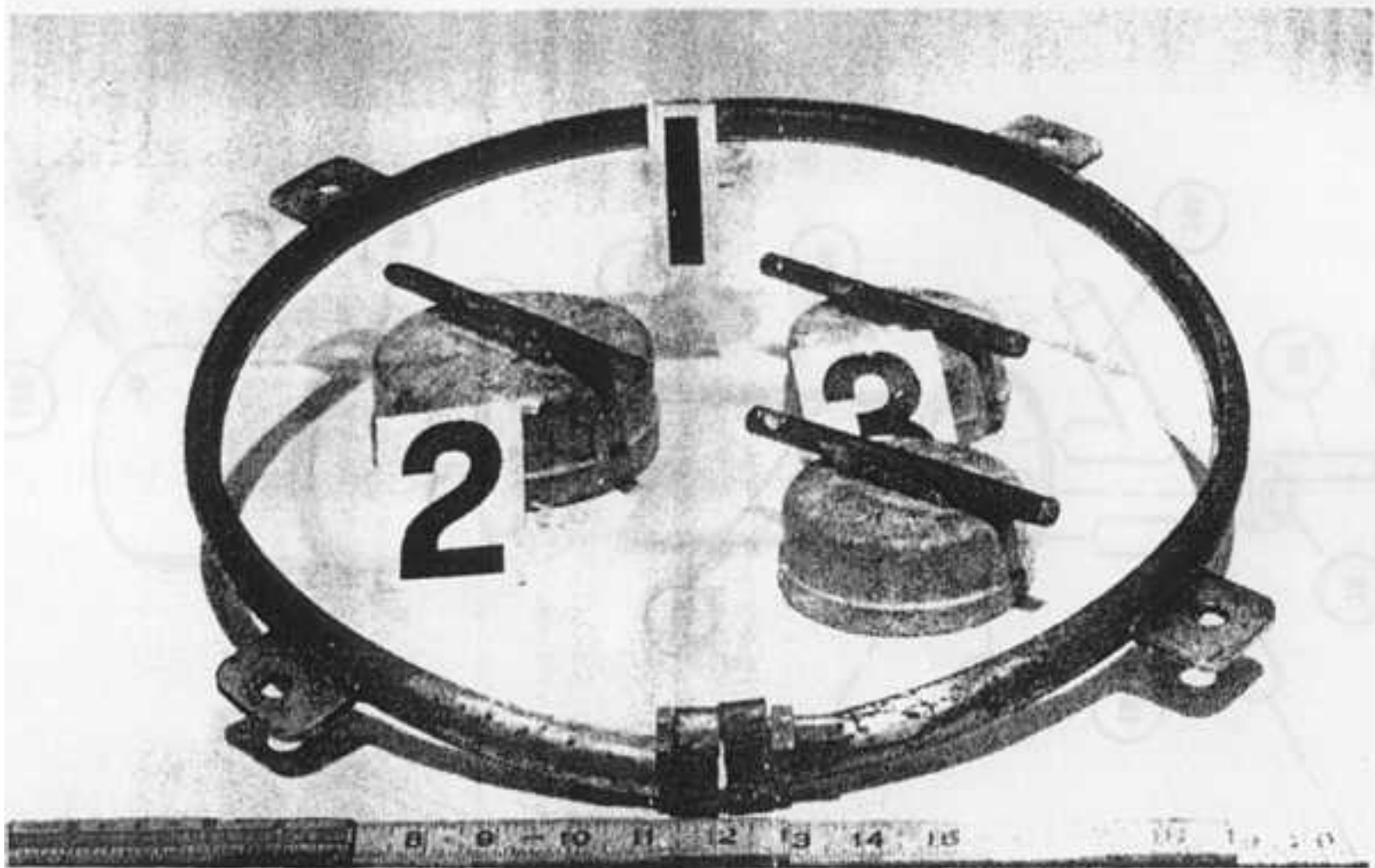
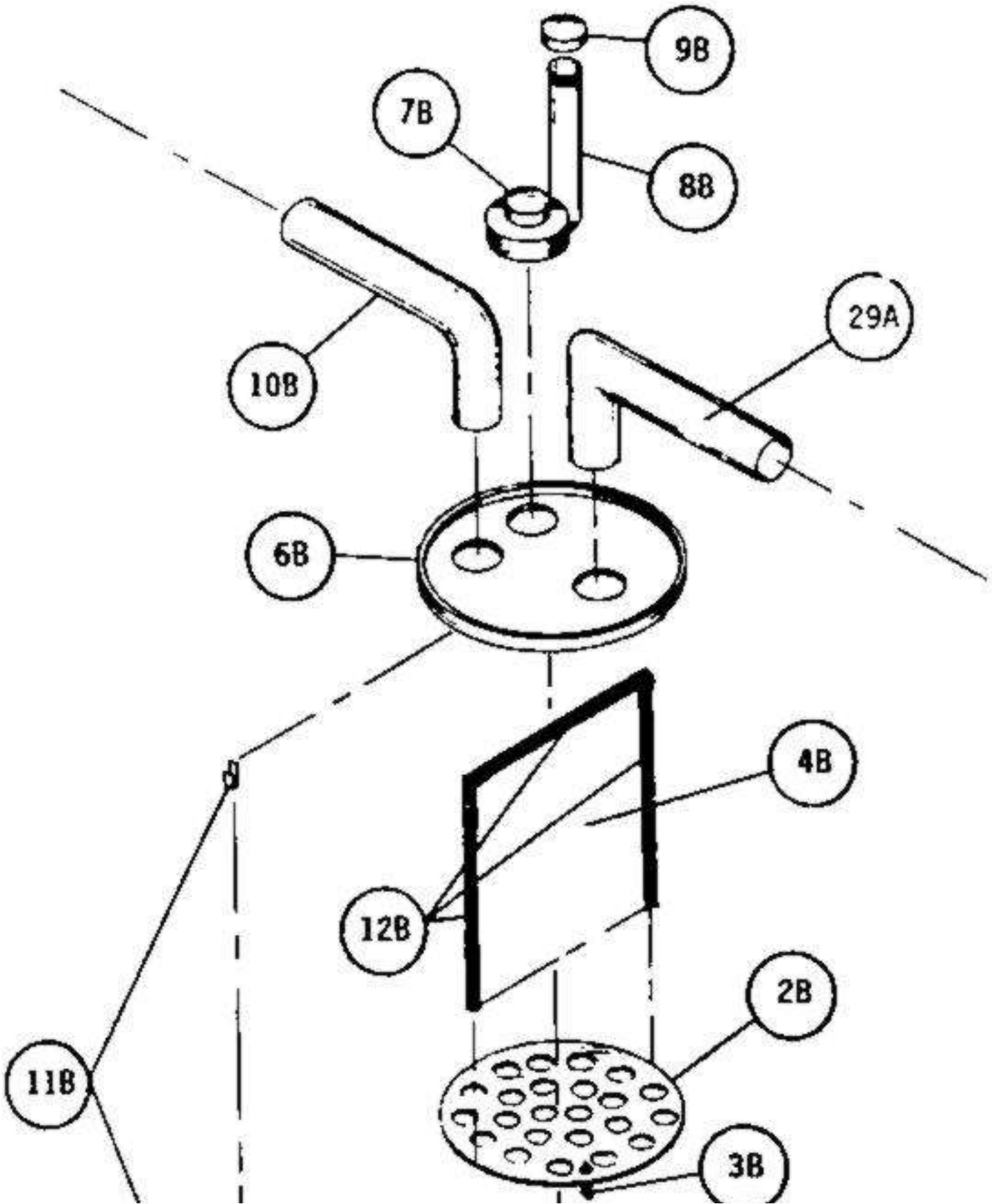


Fig. 2-14. Lock ring and welded tabs. Also pictured inside the lock ring (#1): the ash cleanout cover cap (#2), and the ignition cover cap (#3).



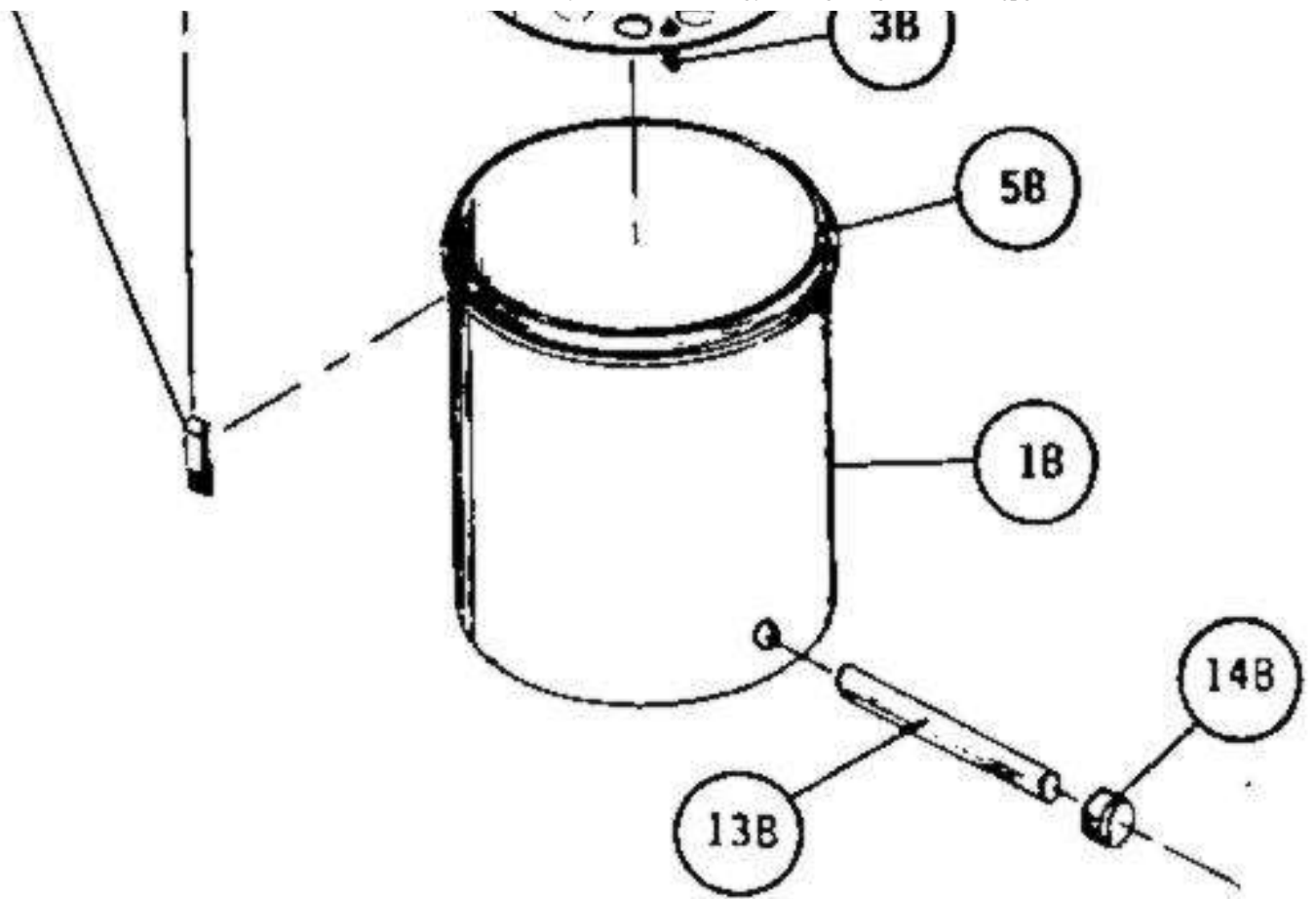
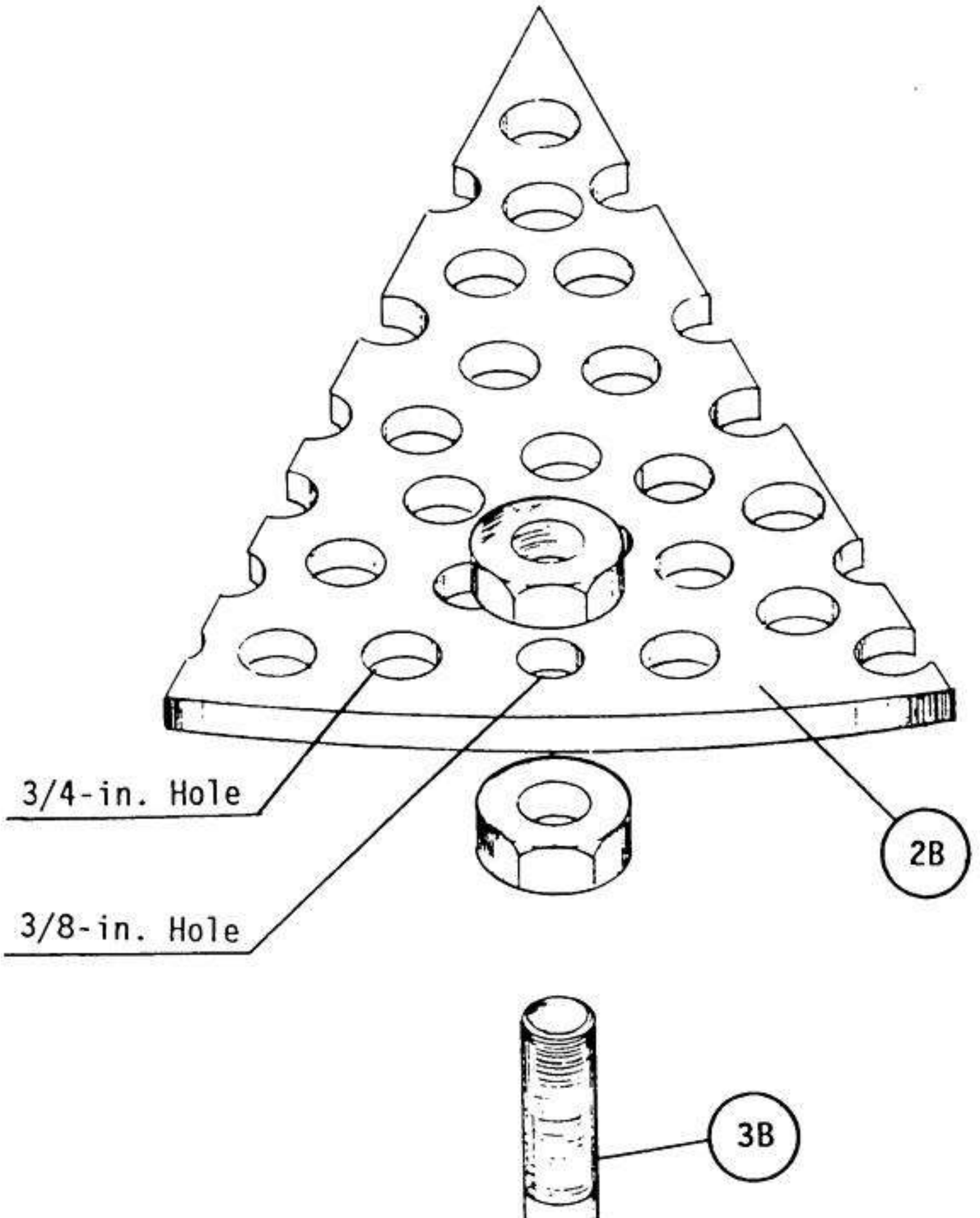


Fig. 2-15. Exploded, schematic diagram of the filter unit.





**Fig. 2-16. Detail of the standoffs for the bottom plate of the filter unit.**



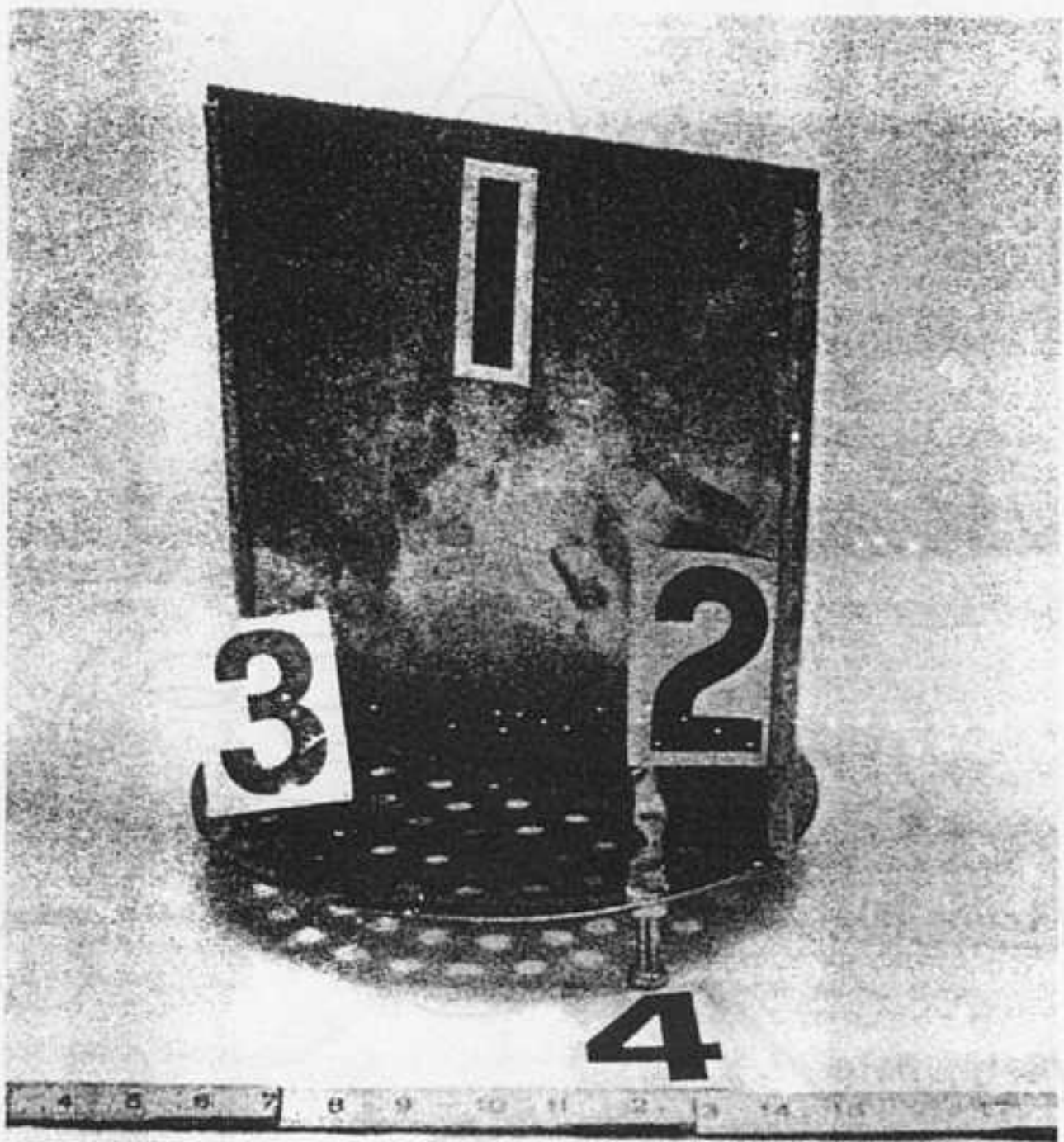


Fig. 2-17. Divider plate (#1) and bottom plate (#3), with standoffs (#4), for the filter unit. Note the high-temperature hose lining the sides of the divider plate.

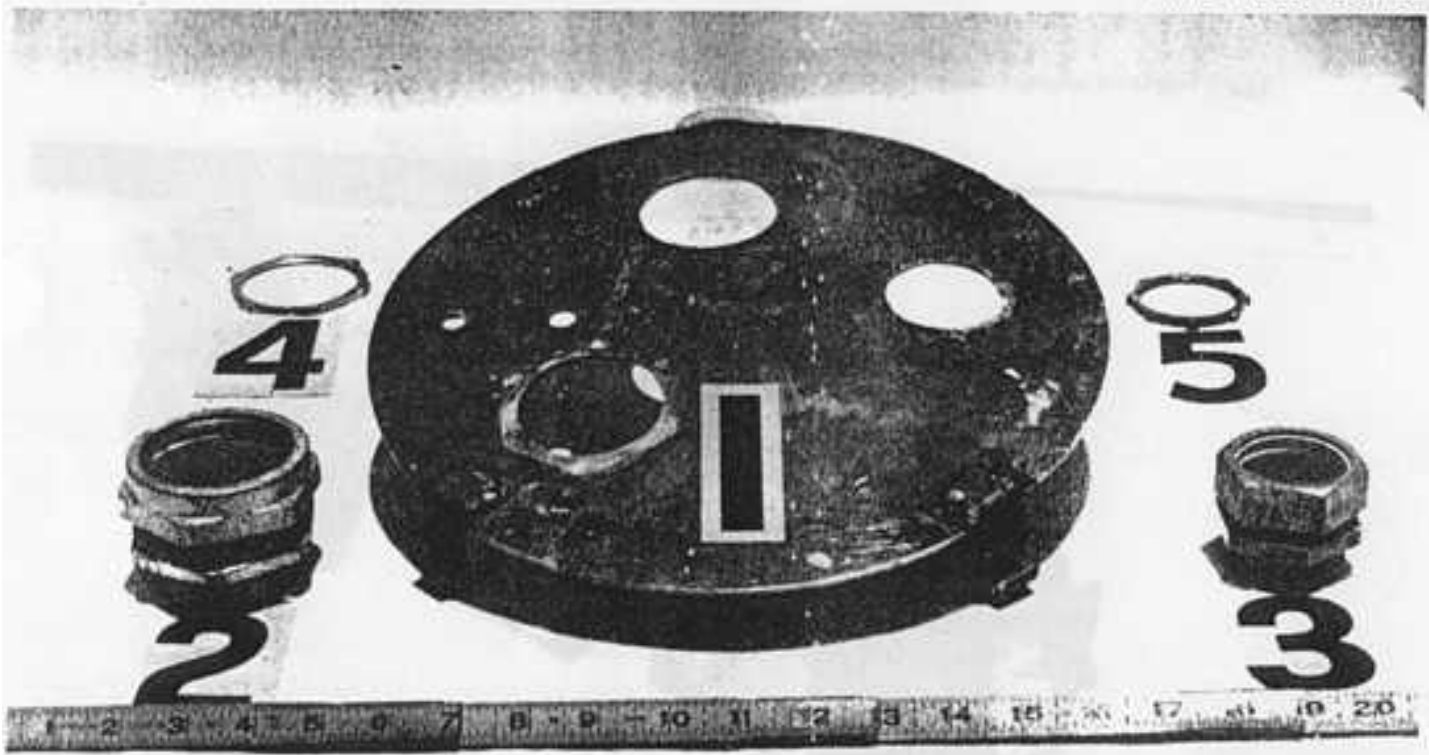


Fig. 2-18. Circular lid (#1) for the filter unit. Note the arrangement of the holes; divider plate would roughly run from 10 o'clock position to 4 o'clock position (assuming 12 o'clock is taken to be at the rear of the photograph). Also shown are the conduit connectors (#2 and #3) and accompanying nuts (#4 and #5) for inside the lid.

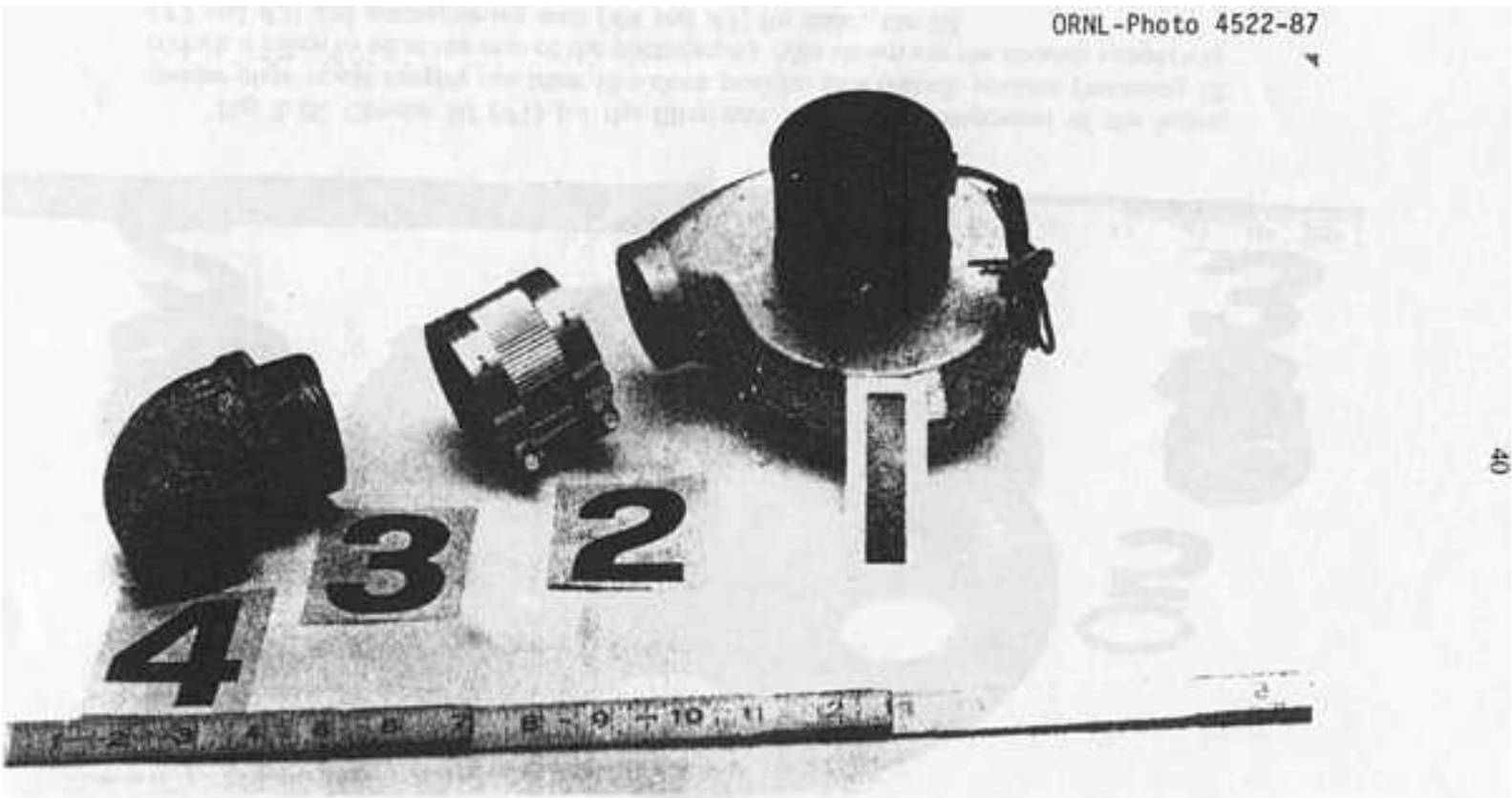


Fig. 2-19. Blower (#1) with exhaust extension assembly. Note adapter coupling (#2), pipe nipple (#3), and elbow (#4) for vertical exhaust pipe.

ORNL-Photo 4512-87



Fig. 2-20. Assembled and installed blower (#1), extension assembly (#4), and conduit connectors for gas inlet (#2) and outlet (#3) on lid of filter unit. Note hook attachments at edge of lid for latches.

ORNL-DWG 87-14558

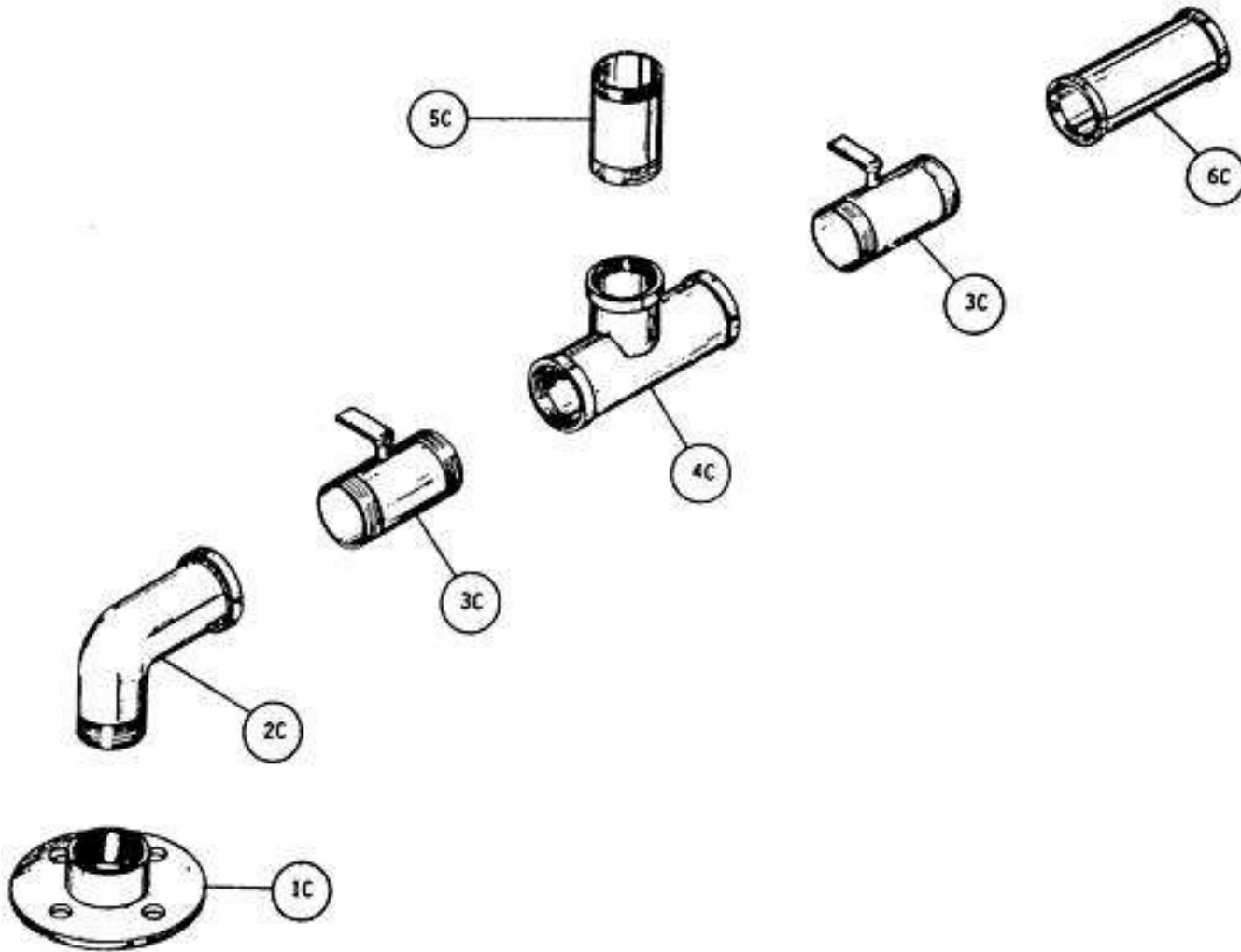


Fig. 2-22. Exploded, schematic diagram of the carbureting unit and control valves.

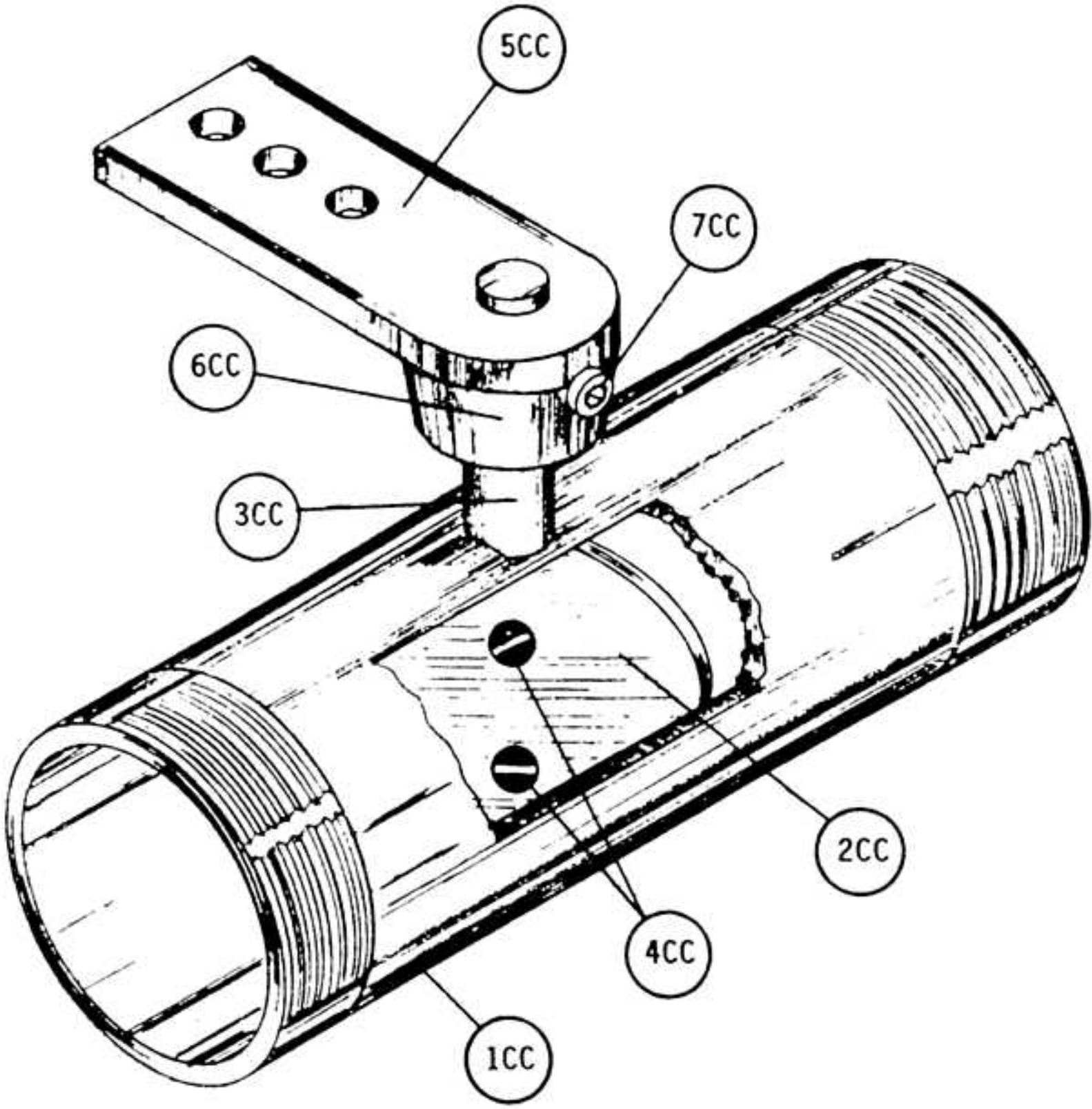


Fig. 2-23. Schematic diagram of a butterfly control valve.

**Fig. 2-23. Schematic diagram of a butterfly control valve.**

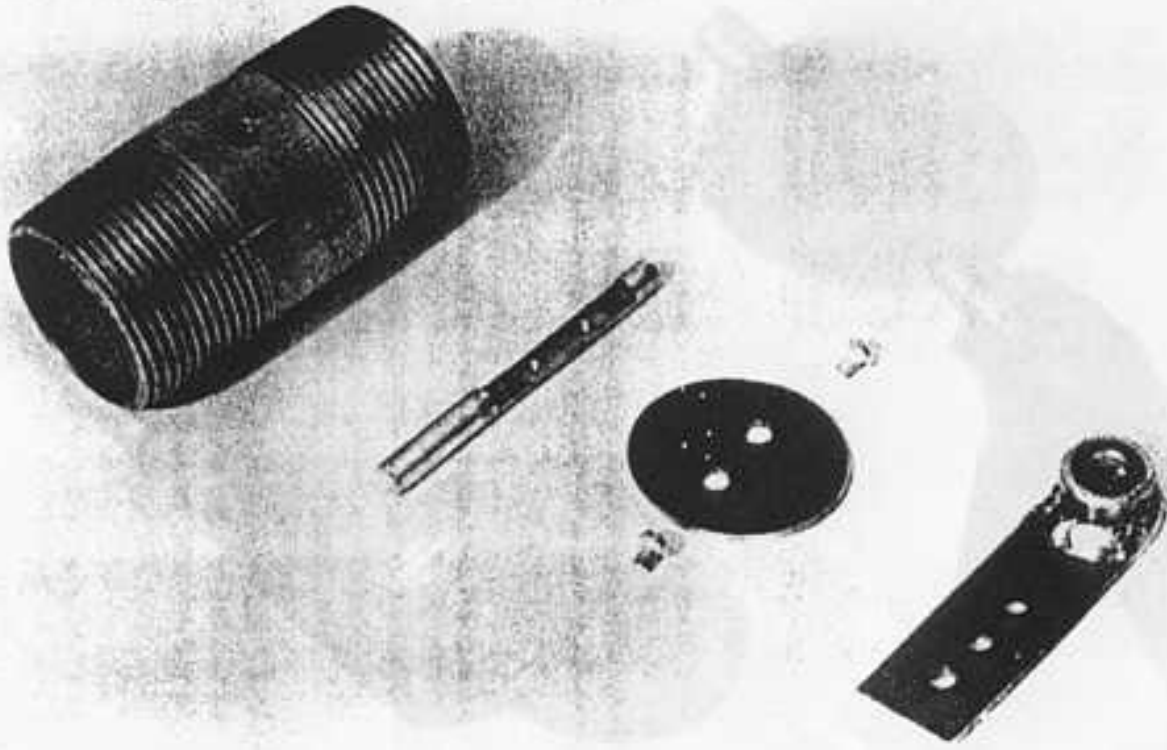


Fig. 2-24. Parts required for the butterfly valve.

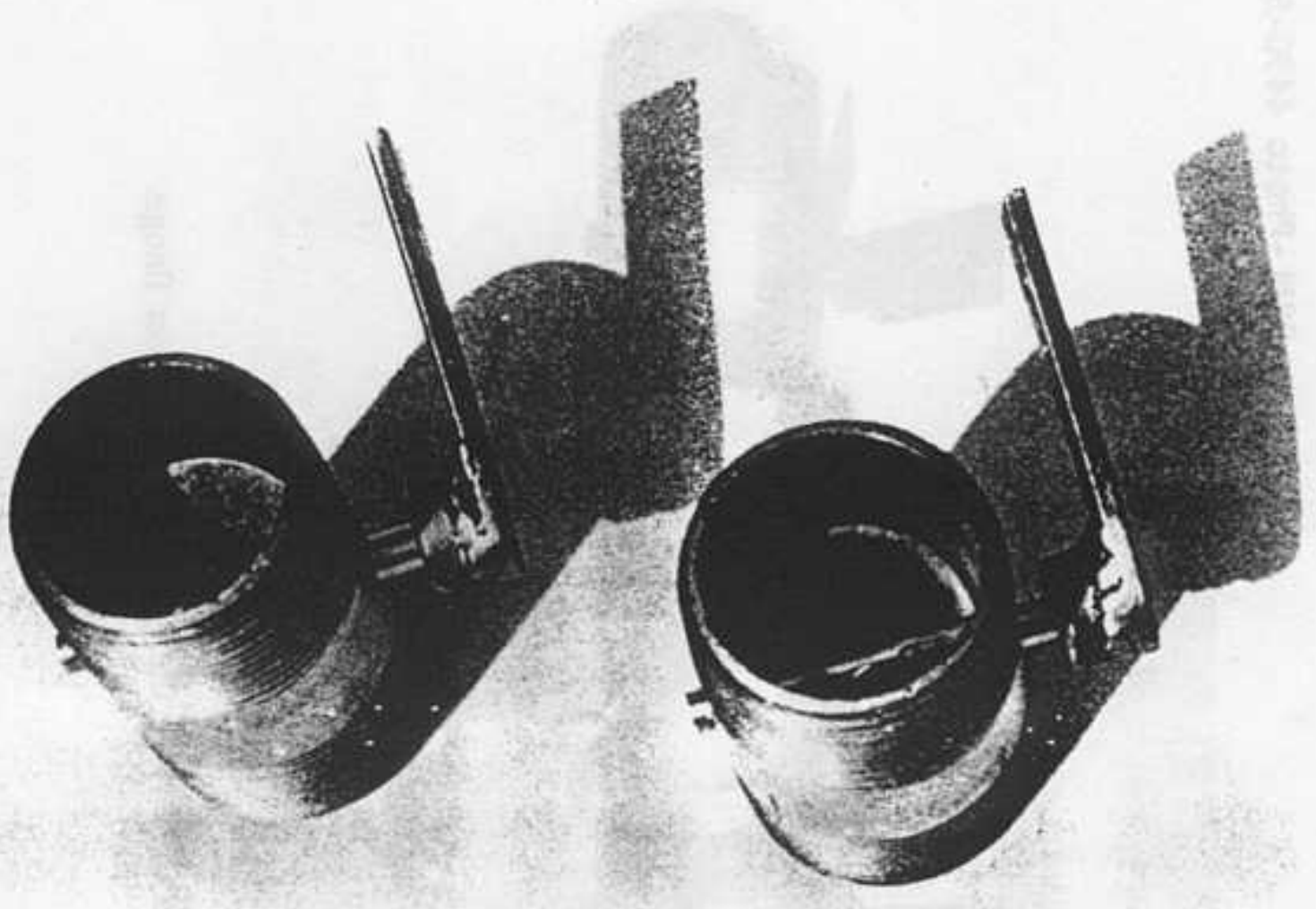
45



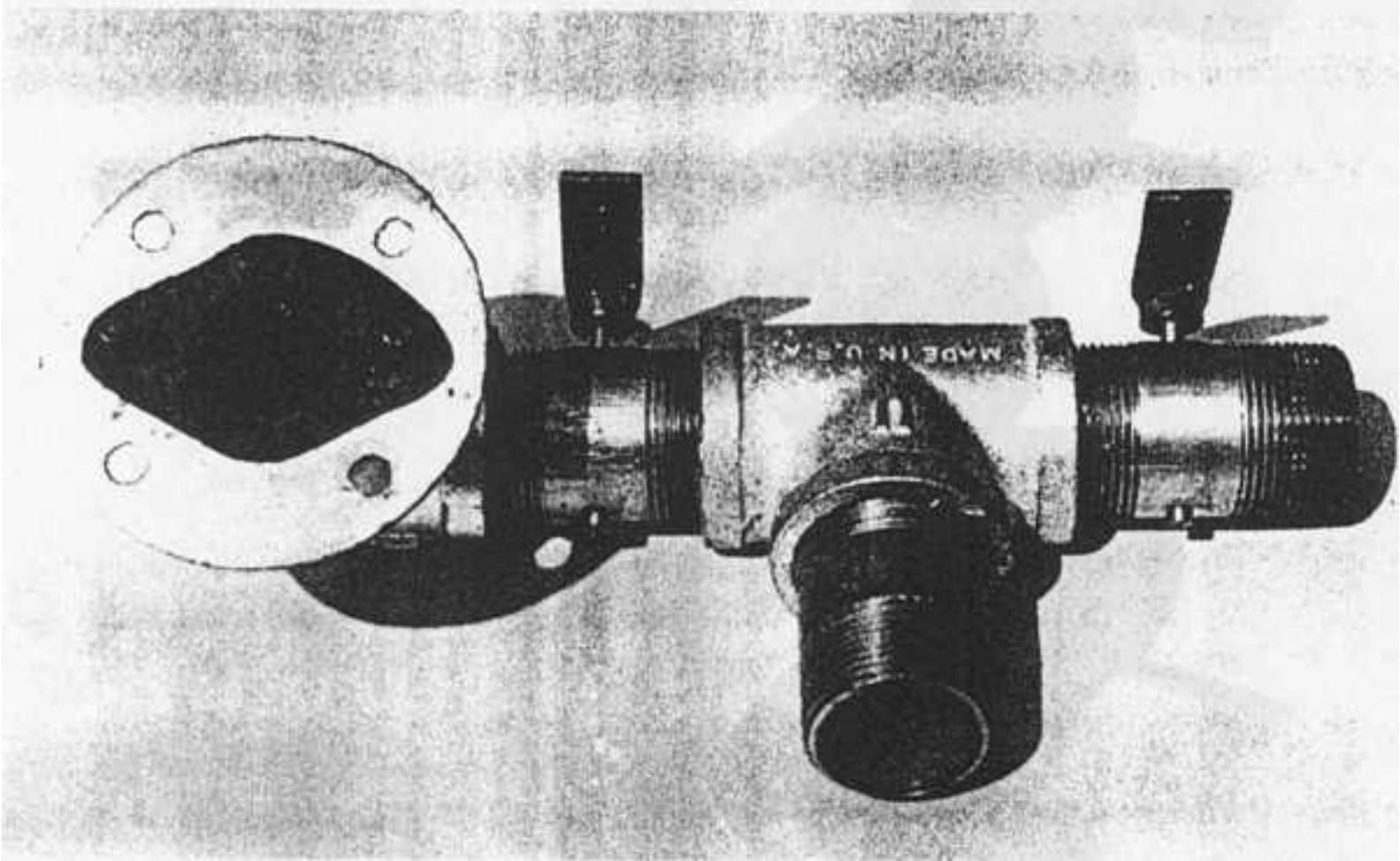
ORNL-Photo 4485-87



Fig. 2-25. Butterfly valve assembly. Note that the valve has been assembled outside of the valve body for clarity.



**Fig. 2-26. Assembled butterfly valves.**



**Fig. 2-27. Assembled carburetion unit. Note the gasket on the closet flange.**

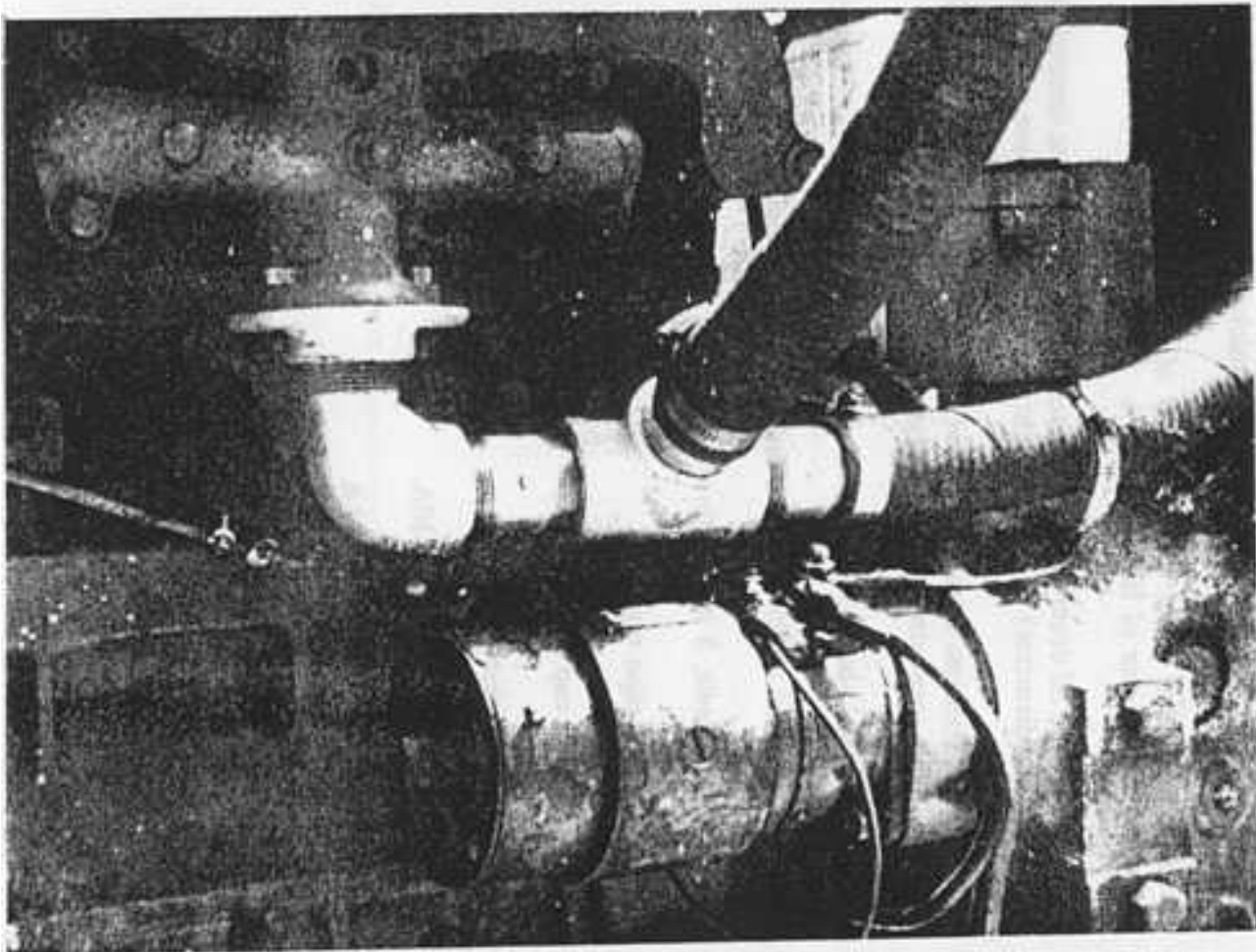
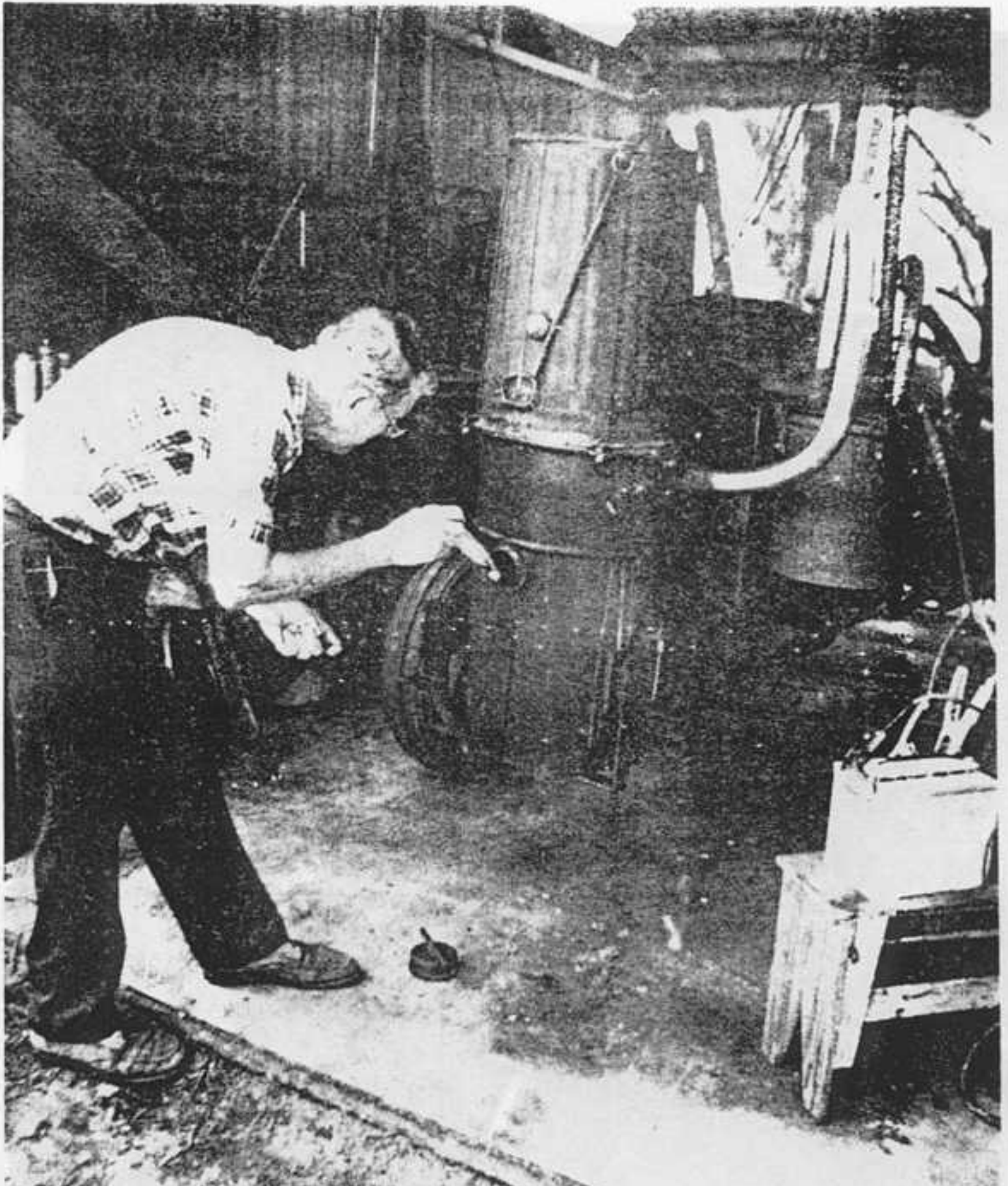


Fig. 2-28. Carburetion unit attached to engine's existing intake manifold. Wood gas enters from the side of the tee; air enters from the right-hand end. The butterfly valve at the right (partially obscured) is connected to the air control (choke) cable; the left valve is connected to the throttle linkage.



**Fig. 3-1. Virtually all varieties of wood chips can be used for fuel. (Minimum size for this 6-in. firetube unit: 3/4 by 3/4 by 1/4 in.; maximum size: 2-in. cubes.)**





**Fig. 3-2. Ignite a single picce of newspaper to start the gasifier unit. Push the flaming newspaper through the ignition port and directly into the grate. (At the right of the photo, note the battery which is operating the blower atop the filter unit.)**

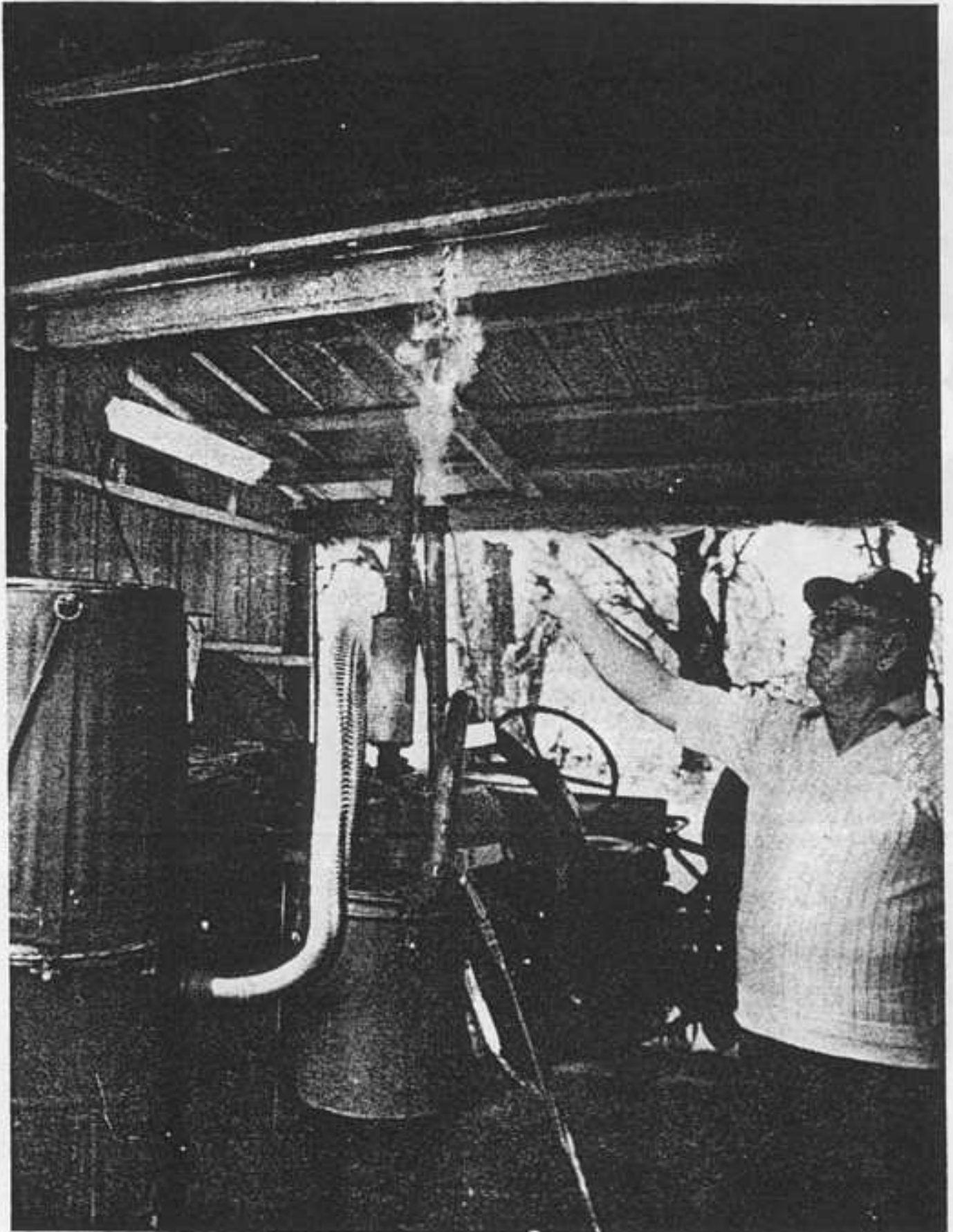
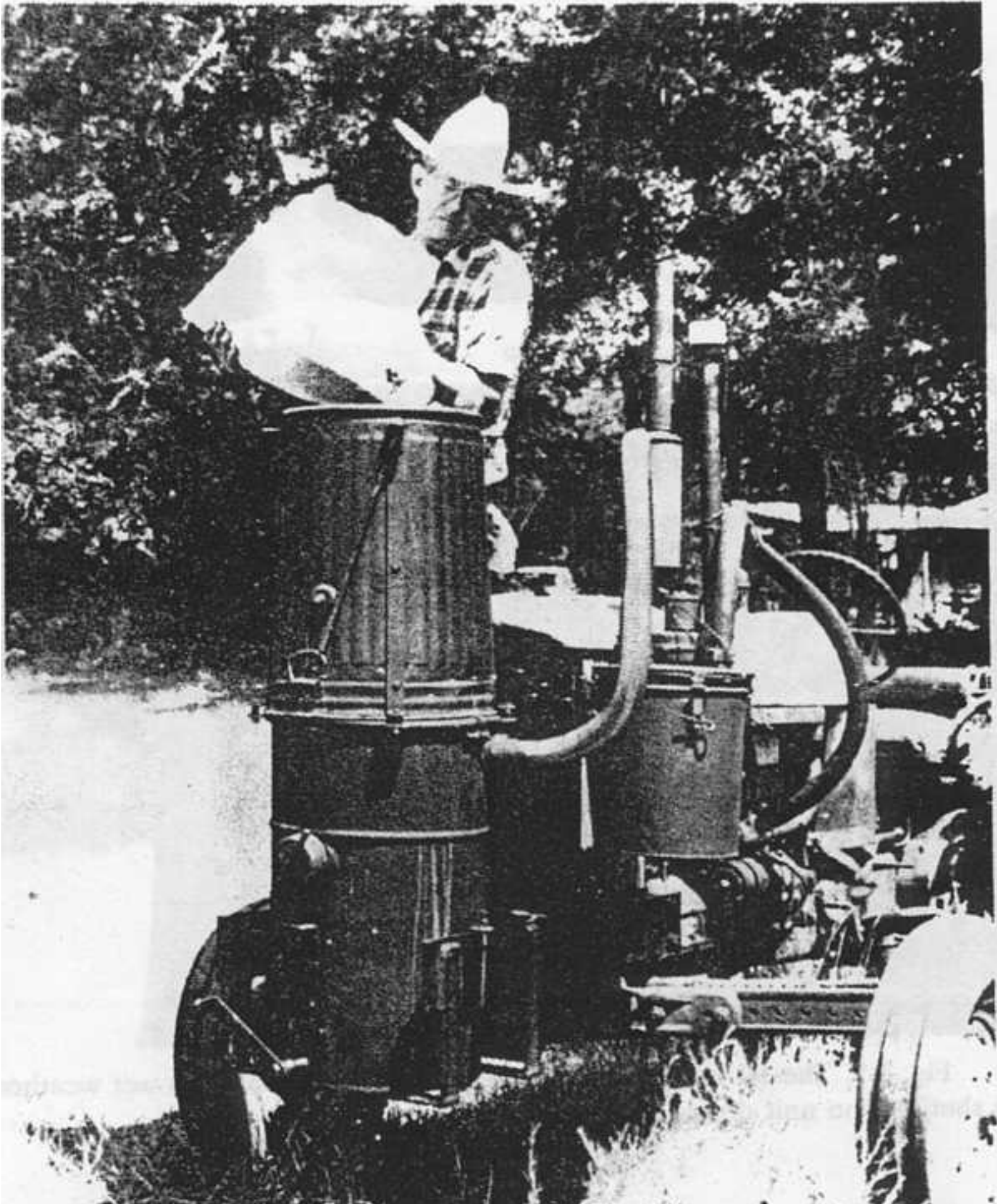


Fig. 3-3. Igniting the exhaust gas will demonstrate that the gasifier unit is working

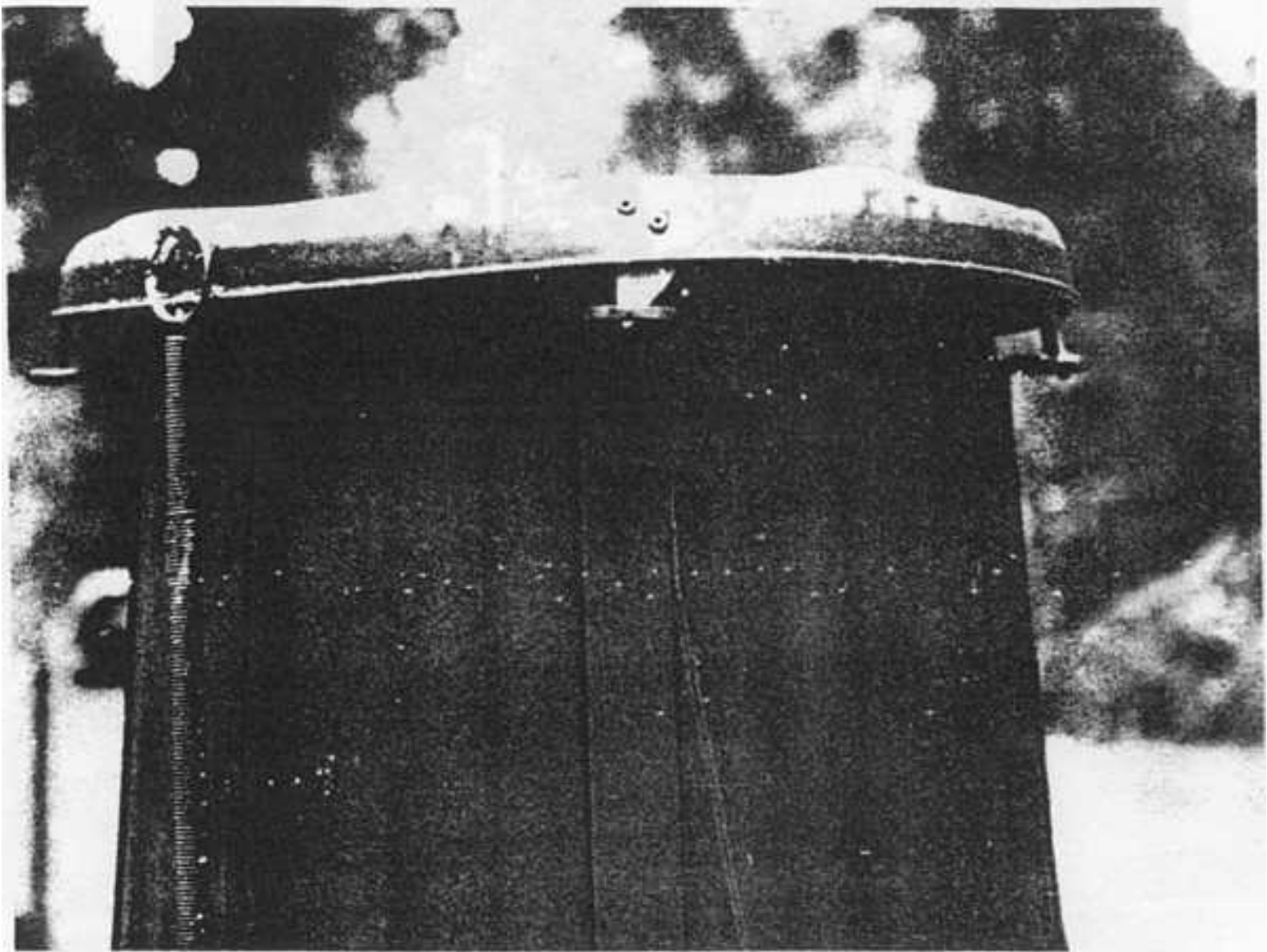


**Fig. 3-3. Igniting the exhaust gas will demonstrate that the gasifier unit is working properly.**





**Fig. 3-4. Refill the fuel hopper before it becomes two-thirds empty.**



**Fig. 3-5. The lid must be used to cover the fuel hopper in wet weather or when shutting the unit down.**

**MENU: [HOME](#) » [Reconstruction](#) » [Recovery](#) » [Renewal](#) » [Energy Types](#)**

# LIST OF TABLES

[Table 2-1](#). List of materials for the gasifier unit and the wood fuel hopper

[Table 2-2](#). Fire tube dimensions

[Table 2-3](#). List of materials for the primary filter unit

[Table 2-4](#). List of materials for the carbureting unit

[Table 3-1](#). Trouble-shooting your wood gas generator

[Table 3-2](#). Effects of breathing carbon monoxide

[Back to Table of Contents](#)

**MENU: [HOME](#) » [Reconstruction](#) » [Recovery](#) » [Renewal](#) » [Energy Types](#)**

---

---

# Table 2-1. List of materials for the gasifier unit and the wood fuel hopper

Item	Quantity	Description
1A	1	Metal pipe, tube, or other, open-ended metal cylinder; diameter and length from Table 2-2; minimum wall thickness of 1/4 in.
2A	1	Circular metal plate with thickness of 1/8 in.; diameter equal to outside diameter of Item 1A.
3A	1	30-gal metal oil drum or metal container with approximate dimensions of 18 in. (diameter) by 29 in. (height); container must have a bottom.
4A	1	10-quart stainless steel mixing bowl, container, or other stainless steel bowl with approximately 14-in. diameter and 6-in. depth.
5A	1	2-in. metal U-bolt.
6A	1	3/16-in. metal chain with 1-in. links; 7 ft total length.
7A	3	1/4-in. eyebolts, 3 in. length with two nuts for each eyebolt.
8A	1	4-in. metal pipe nipple.
9A	1	Metal pipe, cap for Item 8A.
10A	2	3-in. metal pipe nipple.
11A	2	Metal pipe cap for Item 10A.
12A		Shaker assembly; see Fig. <a href="#">2-8</a> .
1AA	1	Metal 1/2-in. pipe; 6 in. length.
2AA	1	Iron bar stock; square or round, 1/2 in.; 6 in. length.
3AA	1	1/2-in. bolt; 8 in. long.
4AA	1	Iron bar stock; rectangular, 1/4 by 1 in.; 10 in. length.
5AA	1	1/2-in. flat washer.
6AA	2	1/2-in. nuts.
7AA	1	Metal pipe cap or bushing for Item 1AA.
13A	1	Iron bar stock; rectangular, 1/4 by 2 in.; 10 ft length.
14A	25	1/4-in. bolts; 314 in. length; with nuts.
15A	1	20-gal metal garbage can or metal container with approximate dimensions of 18 in. (top diameter) by 24 in. (height); bottom is not required.
16A	1	Lid for 20-gal garbage can.
17A	1	Garden hose; 1/2 to 5/8 in. diameter; length equal to circumference of Item 15A.
18A	1	Foam weather stripping with adhesive backing; 1/4 by 1 in.; length equal to circumference of Item 15A.

19A	1	Iron bar stock; rectangular, 1/4 by 2 in.; 10 ft length.
20A	12	1/4-in. bolts; 3/4 in. length; with nuts.
21A	4	Metal triangles; 2 by 2.5 in., 1/8 to 1/4 in. thick.
22A	2	Metal eye hook.
23A	2	Screen door spring, 14 in. length.
24A	1	Lock ring for 30-gal (or larger) oil drum.
25A	4	Metal squares; 2 by 2 in., 1/4 in. thick.
26A	4	3/8-in. bolts; 3 in. length.
27A	1	Tube. of high temperature silicone or liquid high temperature gasket material.
28A	1	60-lb. sack of hydraulic or other waterproof cement [such as SEC-PLUG (tm), which is manufactured by the Atlas Chemical Company, Miami, FL].
29A	1	2-in. pipe, electrical conduit, flexible automobile exhaust pipe, or other metal tubing; 6-ft minimum length. Pipe must be able to withstand temperatures of 400°F.

---

## Table 2-2. Fire tube dimensions

<b>Inside diameter (inches)</b>	<b>Minimum length (inches)</b>	<b>Engine power (hp)</b>	<b>Typical engine displacement (cubic inches)</b>
2-	16	5	10
4-	16	15	30
6	16	30	60
7	18	40	80
8	20	50	100
9	22	65	130
10	24	80	160
11	26	100	200
12	28	120	240
13	30	140	280
14	32	160	320

\*A fire tube with an inside diameter of less than. 6 in. would create bridging problems with wood chips and blocks. If the engine is rated at or below 15 horsepower, use a 6-in. minimum fire tube diameter and create a throat restriction in the bottom of the tube corresponding to the diameter entered in the above table.

**NOTES:** For engines with displacement rated in liters, the conversion factor is 1 liter = 61.02 cubic inches.

The horsepower listed above is the SAE net brake horsepower as measured at the rear of the transmission with standard accessories operating. Since the figures vary when a given engine is installed and used for different purposes, such figures are representative rather than exact. The above horsepower ratings are given at the engine's highest operating speed.



## Table 2-3. List of materials for the primary filter unit

Item	Quantity	Description
1B	1	5-gal metal can or other metal container with minimum dimensions of 11.5-in. diameter and 13 in. tall.
2B	1	Circular metal plate; diameter equal to 1/2 in. smaller than inside diameter of Item 1B; thickness of 1/8 in.
3B	3	3/8-in. bolts; 3 in. length with two nuts for each bolt.
4B	1	Rectangular metal plate; width equal to 1/4 in. smaller than inside diameter of Item 1B; height equal to 2.5 in. smaller than internal height of Item 1B; 1/8 in. thick.
5B	1	High-temperature hose, 3/8 to 5/8 in. diameter; length equal to circumference of Item 1B.
6B	1	Circular metal plate; diameter equal to outside diameter of Item 1B; thickness of 1/8 in.
7B	1	12-volt blower (automotive heater type); case and fan must be all metal.
8B	1	Metal extension pipe for blower outlet, including elbows and connections for vertical orientation; 1 ft. minimum length.
9B	1	Cap for Item 8B; plastic is acceptable.
10B	1	1.25-in. metal pipe, electrical conduit, automotive exhaust pipe, or other metal tubing; 2 ft minimum length.
11B	3	Metal latch for securely connecting Items 1B and 6B together. Such devices as suitcase or luggage catches, bail-type latches, window sash catches (with strike), or wing-nut latches are acceptable.
12B	1	High-temperature hose, 3/8 to 5/8 in. diameter; length equal to three times the height of Item 4B.
13B	1	Metal 1/2-in. pipe, threaded on one end; 8 in. length.
14B	1	Metal pipe cap for Item 13B.

## Table 2-4.

### List of materials for the carbureting unit

Item	Quantity	Description
1C	1	1.25-in. closet flange.
2C	1	1.25-in. male-to-female 45° pipe elbow.
3C		Butterfly valve; see <a href="#">Fig. 2-23</a> .
1CC	2	1.25-in. pipe nipple or threaded length of pipe, 3-in. length.
2CC	2	Oval metal plate; 1/16 in. thick; short dimension equal to inside diameter of Item 1CC; long dimension equal to 1.02 times the short dimension.
3CC	2	3/8-in. diameter rod; 2.5 in. length.
4CC	4	3/16-in. screws; 3/16 in. length.
3CC	2	Flat bar stock; rectangular 1/2 by 3 in.; 1/8 in. thick.
6CC	1	7/16-in. nut.
7CC	1	1/8-in. set screw.
4C	1	1.25-in. tee with all female threads.
5C	1	1.25-in. pipe nipple or threaded length of pipe, 3 in. length.
6C	1	1.25-in. pipe or hose.
7C	1	Gasket material; sized to cover Item 1C.
8C	1	Tube of pipe compound or Teflon tape for sealing threaded assemblies.

---

# Table 3-1.

## Trouble-shooting your wood gas generator

Trouble	Cause	Remedy
Start up takes too long	Dirty system or clogged pipes.	Clean the gasifier unit and all the connecting piping.
	Blower is too weak	Check the blower and the battery's charge.
	Wet or poor quality charcoal	Check charcoal and replace or refill to proper level.
	Wood fuel bridges in the fire tube.	Lightly tamp down the wood fuel in the hopper and fire tube or replace the fuel with smaller-sized chips.
Engine will not start.	Insufficient gas	Use the blower longer during start up.
	Wet wood fuel.	Vent steam and smoke through the fire tube and fuel hopper for several minutes.
	Incorrect fuel-air mixture.	Regulate the carburetor's air control for proper mixing
Engine starts, but soon dies	Not enough gas has been produced.	Use low RPM while starting engine and do not rev engine for several minutes.
	Air channels through fire tube.	Tamp down wood fuel lightly in hopper. <u>Do not</u> crush charcoal above the grate.
Engine loses power under load.	Restricted gas flow in piping.	Reduce air mixture valve setting. Check for partial blockage of unit or piping.
	Leaks in system.	Check all covers and pipes for air tightness

# Table 3-2.

## Effect of breathing carbon monoxide

<b>Carbon monoxide content of inhaled air (%)</b>	<b>Physiological effects</b>
0.020	Possible mild frontal headache after two to three hours
0.040	Frontal headache and nausea after one to two hours; occipital (rear of head) headache after 2.5 to 3.5 hours.
0.080	Headache, dizziness, and nausea in 45 min; collapse and possible unconsciousness in who hours.
0.160	Headache, dizziness, and nausea inn 45 min; collapse and possible unconsciousness in two hours.
0.320	Headache and dizziness in 5 to 10 min; unconsciousness and danger of death in 30 min.
0.640	Headache and dizziness in 1 to 2 min; unconsciousness and danger of death in 10 to 15 min.
1.280	Immediate physiological effect; unconsciousness and danger of death in 1 to 3 min.

---

**MENU:** [HOME](#) » [Reconstruction](#) » [Recovery](#) » [Renewal](#) » [Energy Types](#)

# CONSTRUCTION OF A SIMPLIFIED WOOD GAS GENERATOR FOR FUELING INTERNAL COMBUSTION ENGINES IN A PETROLEUM EMERGENCY

H. LaFontaine G. P. Zimmerman

## ABSTRACT

This report is one in a series of emergency technology assessments sponsored by the Federal Emergency Management Agency (FEMA). The purpose of this report is to develop detailed, illustrated instructions for the fabrication, installation, and operation of a biomass gasifier unit (i.e., a 'producer gas' generator, also called a "wood gas' generator) that is capable of providing emergency fuel for vehicles, such as tractors and trucks, in the event that normal petroleum sources were severely disrupted for an extended period of time. These instructions have been prepared as a manual for use by any mechanic who is reasonably proficient in metal fabrication or engine repair.

This report attempts to preserve the knowledge about wood gasification that was put into practical use during World War II. Detailed, step-by-step fabrication procedures are presented for a simplified version of the World War II, Imbert wood gas generator. This simple, stratified, downdraft gasifier unit can be constructed from materials that would be widely available in the United States in a prolonged petroleum crisis. For example, the body of the unit consists of a galvanized metal garbage can atop a small metal drum; common plumbing fittings throughout; and a large, stainless steel mixing bowl for the grate. The entire compact unit was mounted onto the front of a farm tractor and successfully field tested, using wood chips as the only fuel. Photographic documentation of the actual assembly of the unit as well as its operation is included.

[Back to Table of Contents](#)

**MENU:** [HOME](#) » [Reconstruction](#) » [Recovery](#) » [Renewal](#) » [Energy Types](#)

# 1. WHAT IS A WOOD GAS GENERATOR AND HOW DOES IT WORK?

This report is one in a series of emergency technology assessments sponsored by the Federal Emergency Management Agency (FEMA). The purpose of this report is to develop detailed, illustrated instructions for the fabrication, installation, and operation of a biomass gasifier unit (i.e., a "producer gas" generator, also called a 'wood gas' generator) that is capable of providing emergency fuel for vehicles, such as tractors and trucks, in the event that normal petroleum sources were severely disrupted for an extended period of time. These instructions have been prepared as a manual for use by any mechanic who is reasonably proficient in metal fabrication or engine repair.

## 1.1 INTRODUCTION

Fuel gas, produced by the reduction of coal and peat, was used for heating, as early as 1840 in Europe, and by 1884 it had been adapted to fuel engines in England. Before 1940, gas generator units were a familiar, but not extensively utilized, technology. However, petroleum shortages during World War II led to widespread gas generator applications in the transportation industries of Western Europe. (Charcoal-burning taxis, a related application, were still common in Korea as late as 1970.) The United States, never faced with such prolonged or severe oil shortages, has lagged far behind Europe and the Orient in familiarity with and application of this technology; however, a catastrophe could so severely disrupt the supply of petroleum in this country that this technology might be critical in meeting the energy needs of some essential economic activities, such as the production and distribution of food.

This report attempts to preserve the knowledge about wood gasification as put into practical use during World War II. Detailed, step-by-step procedures are presented in this report for constructing a simplified version of the World War II, Imbert wood gas generator. This simple, stratified, downdraft gasifier unit can be constructed from materials that would be widely available in the United States in a prolonged petroleum crisis. For example, the body of the unit consists of a galvanized metal garbage can atop a small metal drum; common plumbing fittings throughout; and a large, stainless steel mixing bowl for the grate. A prototype gasifier unit was fabricated from these instructions. This unit was then mounted onto the front of a gasoline-engine farm tractor and successfully field tested, using wood chips as the only fuel; see [Fig. 1-1](#) (all figures and tables are presented at the end of their respective sections).

Photographic documentation of the actual assembly of the unit, as well as its operational field test, is included in this report.

The use of wood gas generators need not be limited to transportation applications. Stationary engines can also be fueled by wood gasifiers to run electric generators, pumps, and industrial equipment. In fact, the use of wood gas as a fuel is not even restricted to gasoline engines; if a small amount of diesel fuel is

used for ignition, a properly adjusted diesel engine can be operated primarily on wood gas introduced through the intake manifold. However, this report is concerned with the operation of four-cylinder gasoline engines rated from 10 to 150 horsepower. If more information is needed about operating gasifiers on other fuels (such as coal, charcoal, peat, sawdust or seaweed), a list of relevant literature is contained in the Bibliography at the end of this report.

The goal of this report is to furnish information for building a homemade wood gas generator made out of ordinary, available hardware, in order to get tractors, trucks, and other vehicles operating without delay, if a severe liquid fuel emergency should arise. Section 1 describes gasification principles and wood gas generators, in general, and gives some historical background about their operation and effectiveness. Section 2 contains detailed step-by-step instructions for constructing your own wood gas generator unit; illustrations and photographs are included to prevent confusion. Section 3 contains information on operating, maintaining, and trouble-shooting your wood gas generator; also included are some very important guidelines on safety when using your gasifier system.

The wood gasifier design presented in this report has as its origin the proven technology used in World War II during actual shortages of gasoline and diesel fuel. It should be acknowledged that there are alternate technologies (such as methane production or use of alcohol fuels) for keeping internal combustion engines in operation during a prolonged petroleum crisis; the wood gasifier unit described in this report represents only one solution to the problem.

## 1.2 PRINCIPLES OF SOLID FUEL GASIFICATION

All internal combustion engines actually run on vapor, not liquid. The liquid fuels used in gasoline engines are vaporized before they enter the combustion chamber above the pistons. In diesel engines, the fuel is sprayed into the combustion chamber as fine droplets which burn as they vaporize. The purpose of a gasifier, then, is to transform solid fuels into gaseous ones and to keep the gas free of harmful constituents. A gas generator unit is, simultaneously, an energy converter and a filter. In these twin tasks lie its advantages and its difficulties.

The first question many people ask about gasifiers is, 'Where does the combustible gas come from?' Light a wooden match; hold it in a horizontal position; and notice that while the wood becomes charcoal, it is not actually burning but is releasing a gas that begins to burn brightly a short distance away from the matchstick. Notice the gap between the matchstick and the luminous flame; this gap contains the wood gas which starts burning only when properly mixed with air (which contains oxygen). By weight, this gas (wood gas) from the charring wood contains approximately 20% hydrogen ( $H_2$ ), 20% carbon monoxide ( $CO$ ), and small amounts of methane, all of which are combustible, plus 50 to 60% nitrogen ( $N_2$ ). The nitrogen is not combustible; however, it does occupy volume and dilutes the wood gas as it enters and burns in an engine. As the wood gas burns, the products of combustion are carbon dioxide ( $CO_2$ ) and water vapor ( $H_2O$ ).

The same chemical laws which govern combustion processes also apply to gasification. The solid, biomass fuels suitable for gasification cover a wide range, from wood and paper to peat, lignite, and coal, including coke derived from coal. All of these solid fuels are composed primarily of carbon with varying amounts of hydrogen, oxygen, and impurities, such as sulfur, ash, and moisture. Thus, the aim of gasification is the almost complete transformation of these constituents into gaseous form so that only the ashes and inert materials remain.

In a sense, gasification is a form of incomplete combustion; heat from the burning solid fuel creates gases which are unable to burn completely, due to insufficient amounts of oxygen from the available supply of air. In the matchstick example above, as the wood was burned and pyrolyzed into charcoal, wood gas was created, but the gas was also consumed by combustion (since there was an enormous supply of air in the room). In creating wood gas for fueling internal combustion engines, it is important that the gas not only be properly produced, but also preserved and not consumed until it is introduced into the engine where it may be appropriately burned.

Gasification is a physiochemical process in which chemical transformations occur along with the conversion of energy. The chemical reactions and thermochemical conversions which occur inside a wood gas generator are too long and too complicated to be covered here. Such knowledge is not necessary for constructing and operating a wood gasifier. Books with such information are listed in the Reference Section (see, for example, Reed 1979, Vol. II; or Reed and Das 1988).

## 1.3 BACKGROUND INFORMATION

The use of wood to provide heat is as old as mankind; but by burning the wood we only utilize about one-third of its energy. Two-thirds is lost into the environment with the smoke. Gasification is a method of collecting the smoke and its combustible components. Making a combustible gas from coal and wood began around 1790 in Europe. Such manufactured gas was used for street lights and was piped into houses for heating, lighting, and cooking. Factories used it for steam boilers, and farmers operated their machinery on wood gas and coal gas. After the discovery of large petroleum reserves in Pennsylvania in 1859, the entire world changed to oil - a cheaper and more convenient fuel. Thousands of gas works all over the world were eventually dismantled.

Wood gas generators are not technological marvels that can totally eliminate our current dependence on oil, reduce the impacts of an energy crunch, or produce long-term economic relief from high fossil fuel prices, but they are a proven emergency solution when such fuels become unobtainable in case of war, civil upheaval, or natural disaster. In fact, many people can recall a widespread use of wood gas generators during World War II, when petroleum products were not available for the civilian populations in many countries. Naturally, the people most affected by oil and petroleum scarcity made the greatest advancements in wood gas generator technology.

In occupied Denmark during World War II, 95% of all mobile farm machinery, tractors, trucks, stationary engines, fishing and ferry boats were powered by wood gas generators. Even in neutral



Sweden, 40% of all motor traffic operated on gas derived from wood or charcoal (Reed and Jantzen 1979). All over Europe, Asia, and Australia, millions of gas generators were in operation between 1940 and 1946. Because of the wood gasifier's somewhat low efficiency, the inconvenience of operation, and the potential health risks from toxic fumes, most of such units were abandoned when oil again became available in 1945. Except for the technology of producing alternate fuels, such as methane or alcohol, the only solution for operating existing internal combustion engines, when oil and petroleum products are not available, has been these simple, inexpensive gasifier units.

### 1.3.1 The World War II, Imbert Gasifier

The basic operation of two gasifiers is described in this and the following section. Their operating advantages and disadvantages will also be discussed. This information is included for the technically interested reader only; it is intended to give the reader more insight into the subtleties of the operating principles of the wood gas generator described in this manual. Those readers who are anxious to begin construction of their own wood gas generator may skip the material below and proceed directly to [Sect. 2](#) without any loss of continuity.

The constricted hearth, downdraft gasifier shown in [Fig. 1-2](#) is sometimes called the 'Imbert' gasifier after its inventor, Jacques Imbert; although, it has been commercially manufactured under various names. Such units were mass produced during World War II by many European automotive companies, including General Motors, Ford, and Mercedes-Benz. These units cost about \$1500 (1985 evaluation) each. However, after World War II began in 1939, it took six to eight months before factory-made gasifiers were generally available. Thousands of Europeans were saved from certain starvation by home-built, simple gasifier units made from washing machine tubs, old water heaters, and metal gas or oxygen cylinders. Surprisingly, the operation of these units was nearly as efficient as the factory-made units; however, the homemade units lasted for only about 20000 miles with many repairs, while the factory-made units operated, with few repairs, up to 100,000 miles.

In [Fig. 1-2](#), the upper cylindrical portion of the gasifier unit is simply a storage bin or hopper for wood chips or other biomass fuel. During operation, this chamber is filled every few hours as needed. The spring-loaded, airtight cover must be opened to refill the fuel hopper; it must remain closed and sealed during gasifier operation. The spring permits the cover to function as a safety valve because it will pop open in case of any excessive internal gas pressure.

About one-third of the way up from the bottom of the gasifier unit, there is a set of radially directed air nozzles; these allow air to be injected into the wood as it moves downward to be gasified. In a gas generator for vehicle use, the downstroke of the engine's pistons creates the suction force which moves the air into and through the gasifier unit; during startup of the gasifier, a blower is used to create the proper airflow. The gas is introduced into the engine and consumed a few seconds after it is made. This gasification method is called "producer gas generation," because no storage system is used; only that amount of gas demanded by the engine is produced. When the, engine is shut off, the production of gas stops.

During normal operation, the incoming air burns and pyrolyzes some of the wood, most of the tars and oils, and some of the charcoal that fills the constricted area below the nozzles. Most of the fuel mass is converted to gas within this combustion zone. The Imbert gasifier is, in many ways, self-adjusting. If there is insufficient charcoal at the air nozzles, more wood is burned and pyrolyzed to make more charcoal. If too much charcoal forms, then the charcoal level rises above the nozzles, and the incoming air burns the charcoal. Thus, the combustion zone is maintained very close to the nozzles.

Below this combustion zone, the resulting hot combustion gases - carbon dioxide ( $\text{CO}_2$ ) and water vapor ( $\text{H}_2\text{O}$ ) - pass into the hot charcoal where they are chemically reduced to combustible fuel gases: carbon monoxide ( $\text{CO}$ ) and hydrogen ( $\text{H}_2$ ). The hearth constriction causes all gases to pass through the reaction zone, thus giving maximum mixing and minimum heat loss. The highest temperatures are reached in this region.

Fine char and ash dust can eventually clog the charcoal bed and will reduce the gas flow unless the dust is removed. The charcoal is supported by a movable grate which can be shaken at intervals. Ash buildup below the grate can be removed during cleaning operations. Usually, wood contains less than 1% ash (by weight). However, as the charcoal is consumed, it eventually collapses to form a powdery charcoal/ash mixture which may represent 2 to 10% (by weight) of the total fuel mass.

The cooling unit required for the Imbert gasifier consists of a water filled precipitating tank and an automotive radiator type gas cooler. The precipitating tank removes all unacceptable tars and most of the fine ash from the gas flow, while the radiator further cools the gas. A second filter unit, containing a fine mesh filtration material, is used to remove the last traces of any ash or dust that may have survived passage through the cooling unit. Once out of the filter unit, the wood gas is mixed with air in the vehicle's carburetor and is then introduced directly into the engine's intake manifold.

The World War II, Imbert gasifier requires wood with a low moisture content (less than 20% by weight) and a uniform, blocky fuel in order to allow easy gravity feed through the constricted hearth. Twigs, sticks, and bark shreds cannot be used. The constriction at the hearth and the protruding air nozzles present obstructions to the passage of the fuel and may create bridging and channeling followed by poor quality gas output, as unpyrolyzed fuel falls into the reaction zone. The vehicle units of the World War II era had ample vibration to jar the carefully sized wood blocks through the gasifier. In fact, an entire industry emerged for preparing wood for use in vehicles at that time (Reed and Jantzen 1979). However, the constricted hearth design seriously limits the range of wood fuel shapes that can be successfully gasified without expensive cubing or pelletizing pretreatment. It is this limitation that makes the Imbert gasifier less flexible for emergency use.

In summary, the World War II Imbert gasifier design has stood the test of time and has successfully been mass produced. It is relatively inexpensive, uses simple construction materials, is easy to fabricate, and can be operated by motorists with a minimum amount of training.

### 1.3.2 The Stratified, Downdraft Gasifier

Until the early 1980's, wood gasifiers all over the world (including the World War II designs) operated on the principle that both the fuel hopper and the combustion unit be airtight; the hopper was sealed with a top or lid that had to be opened every time wood was added. Smoke and gas vented into the atmosphere while new wood was being loaded; the operator had to be careful not to breathe the unpleasant smoke and toxic fumes.

Over the last few years, a new gasifier design has been developed through cooperative efforts among researchers at the Solar Energy Research Institute in Colorado, the University of California in Davis, the Open University in London, the Buck Rogers Company in Kansas, and the Biomass Energy Foundation, Inc., in Florida (Reed and Das 1988). This simplified design employs a balanced, negative-pressure concept in which the old type of sealed fuel hopper is no longer necessary. A closure is only used to preserve the fuel when the engine is stopped. This new technology has several popular names, including 'stratified, downdraft gasification' and 'open top gasification.' Two years of laboratory and field testing have indicated that such simple, inexpensive gasifiers can be built from existing hardware and will perform very well as emergency units.

A schematic diagram of the stratified, downdraft gasifier is shown in [Fig. 1-3](#). During operation of this gasifier, air passes uniformly downward through four zones, hence the name 'stratified:'

1. The uppermost zone contains unreacted fuel through which air and oxygen enter. This region serves the same function as the fuel hopper in the Imbert design.
2. In the second zone, the wood fuel reacts with oxygen during pyrolysis. Most of the volatile components of the fuel are burned in this zone and provide heat for continued pyrolysis reactions. At the bottom of this zone, all of the available oxygen from the air has completely reacted. The open top design ensures uniform access of air to the pyrolysis region.
3. The third zone is made up of charcoal from the second zone. Hot combustion gases from the pyrolysis region react with the charcoal to convert the carbon dioxide and water vapor into carbon monoxide and hydrogen.
4. The inert char and ash, which constitute the fourth zone, are normally too cool to cause further reactions; however, since the fourth zone is available to absorb heat or oxygen as conditions change, it serves both as a buffer and as a charcoal storage region. Below this zone is the grate. The presence of char and ash serves to protect the grate from excessive temperatures.

The stratified, downdraft design has a number of advantages over the World War II, Imbert gasifier. The open top permits fuel to be fed more easily and allows easy access. The cylindrical shape is easy to fabricate and permits continuous flow of fuel. No special fuel shape or pretreatment is necessary; any blocky fuel can be used.

The foremost question about the operation of the stratified, downdraft gasifier concerns char and ash removal. As the charcoal reacts with the combustion gases, it eventually reaches a very low density and

breaks up into a dust containing all of the ash as well as a percentage of the original carbon. This dust may be partially carried away by the gas; however, it might eventually begin to plug the gasifier, and so it must be removed by shaking or agitation. Both the Imbert gasifiers and the stratified concept have a provision for shaking the grate; when they are used to power vehicles, they are automatically shaken by the vehicle's motion.

An important issue in the design of the stratified, downdraft gasifier is the prevention of fuel bridging and channeling. High-grade biomass fuels such as wood blocks or chips will flow down through the gasifier under the influence of gravity, and downdraft air flow. However, other fuels (such as shredded wood, sawdust, and bark) can form a bridge that will prevent continuous flow and cause very high temperatures. Obviously, it is desirable to use these widely available biomass residues. Bridging can be prevented by stirring, shaking, or by agitating the grate or by having it agitated by the vehicle's movement. For prolonged idling, a hand-operated shaker has been included in the design.

A prototype design of the stratified, downdraft gasifier design has been developed. The detailed but simple design is described and illustrated in Section 2 (see Table of Contents), however, it has not been widely tested at this time. The reader is urged to use his ingenuity and initiative in constructing his own wood gas generator. As long as the principle of airtightness in the combustion regions, in the connecting piping, and in the filter units is followed, the form, shape, and method of assembly is not important.

---

[Back to Table of Contents](#)

**MENU: [HOME](#) » [Reconstruction](#) » [Recovery](#) » [Renewal](#) » [Energy Types](#)**

---

---

## 2. BUILDING YOUR OWN WOOD GAS GENERATOR

The following fabrication instructions, parts lists, and illustrations describe the prototype gasifier unit shown schematically in [Fig. 1-3](#). These instructions are simple and easy to follow. The dimensions in the following plans are given in inches rather than in millimeters to make construction easier for those who might be unfamiliar with the metric system and to allow the builder to take advantage of available, alternate construction materials. It will be obvious to the experienced engineer, mechanic, or builder that most of the dimensions (for example, plate thicknesses and cleanout diameters) are not critical to the acceptable performance of the finished gasifier unit.

The prototype gasifier unit described in the following text was actually constructed and field tested on a gasoline engine farm tractor (a 35-hp, John Deere 1010 Special); see [Fig. 2-1](#). The unit operated very well, and on par with the European, World War II designs, but it has not had the test of time nor the millions of operating hours like the older Imbert design. This new stratified design was developed for the construction of simple, inexpensive emergency wood gas generator units. The prototype design below should be considered to be the absolute minimum in regard to materials, piping and filter arrangement, and carburetor system connections.

The gasifier unit, as described below, is designed to maintain proper cooling, even at moderate vehicle speeds. If this unit is to be used on stationary engines or on slow-moving vehicles, a gas cooler and a secondary filter must be placed in the piping system between the generator unit and the carburetor. The ideal temperature for the wood gas at the inlet to the carburetor manifold would be 70°F, with acceptable peaks of 140 to 160°F. For every 10 degrees above 70°F, an estimated 1% horsepower is lost. Cooler gas has higher density and, therefore, contains more combustible components per unit volume.

The millions of wood gasifiers built during World War II proved that shape, form, and construction material had little or no effect on the performance of the unit. Judicious substitution or the use of scavenged parts is, therefore, quite acceptable. What is important is that:

1. the fire tube dimensions (inside diameter and length) must be correctly selected to match the rated horsepower of particular engine which is to be fueled,
2. airtightness of the gas generator unit and all connecting piping must be maintained at all times, and
3. unnecessary friction should be eliminated in all of the air and gas passages by avoiding sharp bends in the piping and by using piping sizes which are not too small.

### 2.1. BUILDING THE GAS GENERATOR UNIT AND THE FUEL HOPPER

[Figure 2-2](#) shows an exploded view of the gas generator unit and the fuel hopper; the list of materials is

given in [Table 2-1](#) (all figures and tables mentioned in Sect. 2 are presented at the end of Sect. 2). Only the dimensions of the fire tube (Item 1A) must be reasonably close; all other dimensions and materials can be substituted as long as complete airtightness is maintained. In the following instructions, all item numbers refer both to [Fig. 2-2](#) and to [Table 2-1](#).

The prototype unit described in this report was constructed for use with a 35-hp gasoline engine; the unit has a fire tube diameter of 6 in. (as determined from [Table 2-2](#)). A gas generator unit containing a fire tube up to 9-in. diameter (i.e., a gasifier unit for fueling engines up to about 65 hp) can be constructed from the following instructions. If your engine requires a fire tube diameter of 10 in. or more, use a 55-gal drum for the gas unit and another 55-gal drum for the fuel hopper.

The following fabrication procedure is very general and can be applied to the construction of gas generator units of any size; however, the specific dimensions which are given in the parts list and in the instructions below are for this particular prototype unit. All accompanying photographs were taken during the actual assembly of the prototype unit. The fabrication procedure is as follows:

1. Using the displacement or horsepower rating of the engine to be fueled by the gasifier unit, determine the dimensions (inside diameter and length) of the fire tube (Item 1A) from [Table 2-2](#). Fabricate a cylindrical tube or cut a length of correctly sized pipe to match the dimensions from [Table 2-2](#). (For the prototype gasifier unit illustrated in this report, a 6-in.-diam firetube was used; its length was 19 in.)
2. The circular top plate (Item 2A) should be cut to a diameter equal to the outside diameter of the gasifier housing drum (Item 3A) at its top. A circular hole should then be cut in the center of the top plate; the diameter of this hole must be equal to the outside diameter of the fire tube. The fire tube (Item 1A) should then be welded at a right angle to the top plate (Item 2A) as shown in [Fig. 2-3](#).
3. The grate (Item 4A) should be made from a stainless steel mixing bowl or colander. Approximately 125 holes with diameters of 1/2 in. should be drilled in the bottom and up the sides of the mixing bowl; see [Fig. 2-4](#). A U-bolt (Item 5A) should be welded horizontally to the side of the grate, 2 in. from its bottom. This U-bolt will be interlocked with the shaker mechanism (Item 12A) in a later step.
4. The support chains (Item 6A) are to be attached to the grate in three evenly spaced holes drilled under the lip of the mixing bowl or colander; see [Fig. 2-5](#). These chains are to be connected to the top plate (Item 2A) with eyebolts (Item 7A), as shown in [Fig. 2-6](#). Each eyebolt should have two nuts, one on each side of the top plate, so that the eyebolts can be adjusted to the proper length. When assembled, the bottom of the firetube should be 1.25 in. above the bottom of the mixing bowl.

5. A hole equal to the outside diameter of the ash cleanout port (Item 8A) should be cut into the side of the gasifier housing drum (Item 3A); the bottom edge of this hole should be about 1/2 in. from the bottom of the drum. Because of the thin wall thickness of oil drums and garbage cans, welding is not recommended; brazing such parts to the drums or cans will ensure both strength and airtightness (see [Fig. 2-7](#)).
6. Two holes, equal to the outside diameters of the ignition ports (Item 10A), are to be cut with their centers at a distance from the top of the housing drum (Item 3A) equal to the firetube length less 7 in. (19 in. less 7 in. equals 12 in. for this prototype unit); the holes should be placed opposite each other as shown in [Fig. 2-2](#). The ignition ports should be attached to the wall of the housing drum by brazing.
7. When the ash cleanout port (Item 8A) and the ignition ports (Item 10A) have been attached to the wall of the gasifier housing drum (Item 3A), they should then be closed with pipe caps, Items 9A and 11A respectively. The threads of the pipe caps should be first coated with high temperature silicone (Item 27A) to ensure airtightness. An optional steel crossbar welded to the pipe cap will reduce the effort required to open these caps later.
8. The shaker assembly (Item 12A) is shown in [Fig. 2-8](#). The 1/2-in. pipe (Item 1AA) should be brazed into the side of the housing drum (Item 3A), 1.5 inches from the bottom of the drum; the length of this pipe which protrudes into the drum must be chosen so that the upright bar (Item 2AA) is in line with the U-bolt (Item 5A) on the grate. Likewise, the length of the upright bar must be selected so as to connect into the U-bolt.
9. Weld the upright bar (Item 2AA) to the head of the bolt (Item 3AA). The threaded end of the bolt should be ground down or flattened on one side, as shown in [Fig. 2-9](#), to positively interlock with a slot to be drilled and filed in the handle (Item 4AA). The handle can be formed or bent into any desired or convenient shape.
10. A hole should be drilled in the pipe cap (Item 7AA) so that there is a close fit between this hole and the bolt (Item 3AA). The close fit will help to ensure airtightness.
11. Before assembling the shaker, as shown in [Fig. 2-8](#), coat the bolt (Item 3AA) with a small amount of grease. Before inserting the bolt, fill the pipe (Item 1AA) with high temperature silicone (Item 27A) to ensure airtightness. Tighten the nuts (Item 6AA) so that the position of the handle (Item 4AA) is maintained by friction, yet is capable of being turned and agitated during cleanout or stationary operation.
12. Fabricate the supports (Item 13A) for the gasifier unit housing drum (Item 3A) out of rectangular, iron bar stock. The shape and height of the support flanges must be determined by the frame of the vehicle to which the gasifier is to be mounted. The supports can either be bolted to the bottom and side with the 1/4-in. bolts (Item 14A) or can be brazed directly to the drum; see [Fig. 2-10](#).

Remember to seal all bolt holes for airtightness.

13. Completely cover the bottom of the housing drum (Item 3A) with 1/2 in. of hydraulic cement (Item 28A). The cement should also be applied to the inside of the drum for about 5 in. up the inside walls near the bottom. All edges should be rounded for easy ash removal.
14. The fuel hopper (Item 15A) is to be made from a second container with its bottom up as shown in [Fig. 2-11](#). Remove the bottom, leaving a 1/4-in. lip around the circumference.
15. A garden hose (Item 17A) should be cut to a length equal to the circumference of the fuel hopper (Item 15A) and should then be, slit along its entire length. It should be placed over the edge of the fuel hopper from which the bottom was removed. This will prevent injury to the operator when adding wood fuel to the unit. To insure close fit of the garbage can lid (Item 16A), a piece of weather stripping (Item 18A) should be attached under the lid where it makes contact with the fuel hopper.
16. Cut four support bars (Item 19A) to lengths 2.5 in. longer than the height of the fuel hopper (Item 15A). Drill a 3/8-in. hole in each end of all four support bars; these holes should be centered 3/4 in. from the ends. Bend 2 in. of each end of these support bars over at a right angle; then, mount them evenly spaced around the fuel hopper (Item 15A) with 1/4-in. bolts (Item 20A). One of the bends on each support bar should be as close to the lower edge of the fuel hopper as possible.
17. Cut four metal triangular standoffs (Item 21A) and braze, weld, or rivet them flat against the edge of the garbage can lid (Item 16A) as shown in [Fig. 2-12](#); they must be aligned with the four support bars (Item 19A) attached to the fuel hopper. During operation, the garbage can lid must have a minimum 3/4-in. opening for air passage; the standoffs should provide this clearance, where they are engaged into the holes in the top edges of the support bars (Item 19A); see [Fig. 2-13](#).
18. Two eye hooks (Item 22A) should be attached to opposite sides of the garbage can lid (Item 16A). Two screen door springs (Item 23A) should be attached to the garbage can handle-s and used under tension to keep the top lid (Item 16A) either open or closed.
19. Cut the oil drum lock ring (Item 24A) to the exact circumference of the top plate (Item 2A) so that it will fit snugly around the gasifier unit housing drum (Item 3A).
20. Cut four 2 by 2 by 1/4-in. tabs (Item 25A); then, braze these tabs to the lock ring (Item 24A), evenly spaced and in alignment with the support bars (Item 19A) on the fuel hopper. Drill a 3/8-in. hole in each tab to align with the holes in the fuel hopper support bars (Item 19A). The lock ring is shown in [Fig. 2-14](#).
21. The connecting pipe (Item 29A) between the gasifier unit and the filter unit should be attached to the gasifier housing drum (Item 3A) at a point 6 in. below the top of the drum. This pipe must be a



minimum of 2-in. in diameter and should be at least 6 ft long for cooling purposes. At least one of the ends of this pipe must be removable for cleaning and maintenance. On this prototype unit, an airtight electrical conduit connector was used; this connection is visible in [Fig. 2-1](#). Many similar plumbing devices are available and can be used if they are suitable for operation at 400°F and above. The pipe can also be welded or brazed directly to the housing drum.

22. When assembling the gasifier unit, the upright bar (Item 2AA) on the shaker assembly must be placed inside the U-bolt (Item 5A) on the grate.
23. The lock ring will then clamp the gasifier unit housing drum (Item 3A) and the top plate (Item 2A) together. The fuel hopper support bars (Item 19A) must be attached to the tabs (Item 25A) on the lock ring with bolts (Item 26A). High temperature silicone (Item 27A) should be applied to all edges to make an airtight connection. The lock ring connections are shown in the lower portion of [Fig. 2-13](#).

## 2.2 BUILDING THE PRIMARY FILTER UNIT

[Figures 2-15](#) and [2-16](#) show exploded views of the primary filter unit; the list of materials is given in [Table 2-3](#) (all figures and tables mentioned in Sect. 2 listed in the figure and table files). In the following instructions, all item numbers refer to either [Fig. 2-15](#) or [2-16](#) and to [Table 2-3](#).

The prototype primary filter unit was made from a 5-gal paint can. That size seems to be sufficient for gasifiers with fire tubes up to 10 in. in diameter. If a fire tube diameter of more than 10 in. is required, then a 20-gal garbage can or a 30-gal oil drum should be used. The Filter unit could be fabricated in any shape or form as long as airtightness and unobstructed flow of gas are provided. If a 5-gal container is used, it must be clean and free of any chemical residue. The top edge must be straight and without any indentations. If an alternate container can be found or fabricated, a larger diameter will permit longer operation between cleanings.

The piping (Item 29A in [Figs. 2-2](#) and [2-15](#)) which connects the gas generator unit to the primary filter should be considered to be a necessary part of the cooling system and should never have an inside diameter less than 2 in. A flexible automotive exhaust pipe was used on the prototype filter unit described below; it was shaped into a semicircular arc so that increased length would achieve a greater cooling effect. The fabrication procedure for the filter unit follows:

1. A hole equal to the outside diameter of the drain tube (Item 13B in [Fig. 2-15](#)) should be cut into the side of the filter container (Item 1B); the bottom edge of this hole should be about 1/2 in. from the inside bottom of the container.
2. The drain tube (Item 13B) should be inserted into the previously cut hole in the filter container and should be positioned so that its nonthreaded end is near the center of the container and is about 1/2

- in. off the bottom. Once this position has been ensured, braze (do not weld) the drain pipe into the side of the filter container. Close the threaded, exterior end of the drain pipe with the pipe cap (Item 14B).
3. Coat the bottom of the filter container (Item 1B) with a 1/2-in. layer of hydraulic cement (Item 28A), taking care not to plug or obstruct the end of the drain tube (Item 13B) with cement (i.e., fill the drain tube with a paper, styrofoam, or other easily removable, but rigid material). The cement should also be applied for about 1.5 in. up the inside walls of the container near its bottom. Round the edges slightly; the cement is to provide a pathway for any liquid condensate to drain out through the drain tube. The cement must be allowed to harden before proceeding with the fabrication steps below. Remove the filler material from the drain tube when the cement has hardened.
  4. A circular bottom plate (Item 2B) should be cut to a diameter 1/2 in. smaller than the inside diameter of the filter container (Item 1B). This will allow for heat expansion and easy removal for cleaning. This bottom plate should be drilled with as many 3/4-in. holes as are practical for the size of the plate. Three evenly spaced 3/8-in. holes should also be drilled around the edge of the bottom plate for the spacer bolts (Item 3B).
  5. [Fig. 2-16](#) shows the detail of using three bolts (Item 3B) as spacers for the bottom plate (Item 2B). The length of the bolts should be adjusted to provide a clearance of about 2-in. between the layer of cement in the bottom of the container (Item 1B) and the bottom plate (Item 2B).
  6. A rectangular divider plate (Item 4B) should be cut to a width 1/4 in. less than the inside diameter of the filter container (Item 1B) and to a height 2.5 in. less than the inside height of the container. This divider plate should then be welded at a right angle to the centerline of the bottom plate (Item 2B) as shown in [Fig. 2-17](#).
  7. Cut a piece of high-temperature hydraulic hose (Item 5B) to a length equal to the circumference of the filter container. It should be slit along its entire length and then placed over the top edge of the filter container (Item 1B) to ensure airtightness.
  8. A circular lid (Item 6B) should be cut equal to the outside diameter of the filter container (Item 1B). Three holes should be cut into this lid for the exhaust pipe (Item 29A) from the gasifier unit, the blower (Item 7B), and the filter exhaust pipe (Item 10B) to the engine manifold. Note the arrangement of these holes: the pipe (Item 29A) from the gasifier unit must enter the lid on one side of the divider plate (Item 4B); the blower (Item 7B) and the filter exhaust pipe (Item 10B) to the engine manifold must be located on the other side of the divider plate. This arrangement can be seen in [Fig. 2-18](#).
  9. The connecting pipe (Item 29A) between the gasifier unit and the filter unit should be attached to the lid (Item 5B) of the filter container. At least one of the ends of the connecting pipe (Item 29A)

must be removable for cleaning and maintenance. On this prototype unit, an airtight electrical conduit connector was used. Many similar plumbing devices are available and can be used if they are suitable for operation at 400°F and above. The pipe can also be welded or brazed directly to the lid.

10. Attach the blower (Item 7B) to the filter container lid (Item 6B). On the prototype gasifier illustrated in this report, a heater blower from a Volkswagen automobile was used. Connections for a vertical extension tube (Item SB) will have to be fabricated as shown in [Fig. 2-19](#). A closing cap (Item 9B) is required for the blower exhaust tube. A plumbing cap of steel or plastic with a close fit can be used or fabricated to fit. The vertical extension and the closing cap are visible in [Fig. 2-1](#).
11. The gas outlet (Item 10B) to the carbureting unit on the engine should be 1.25 in. minimum diameter. In fabricating this connection, all abrupt bends should be avoided to ensure free flow of gas. Using plumbing elbows is one solution. The gas outlet (Item 10B) can either be welded or brazed to the lid (Item 6B) of the filter container or an airtight, electrical conduit connector can be used.
12. Latching devices (Item 11B) should be welded or brazed to the lid (see [Fig. 2-20](#)) and to the sides (see [Fig. 2-21](#)) of the filter container. An air tight connection between the lid and the filter container must be maintained.
13. Cut two lengths of high-temperature hydraulic hose (Item 12B) equal to the height of the divider plate (Item 4B); cut a third length of hose equal to the width of the divider plate. Slit each hose along its entire length. Place the first two hoses on each side of the divider plate, and place the third hose along the top edge of the divider plate as shown in [Fig. 2-17](#).
14. Insert the divider plate (Item 4B) into the filter container (Item 1B), making sure that the hoses (Item 12B) create an airtight seal along all sides. By changing the length of the spacer bolts (Item 3B), adjust the height of the divider plate so that it is exactly flush with the top of the filter container. Make sure that the lid (Item 5B) will seat flatly and tightly against the top edge of the divider plate.
15. Fill the filter container (Item 1B) on-both sides of the divider plate with wood chips, the same kind as would be used for fuel in the gasifier unit. After carefully packing and leveling these wood chips, place the lid (Item 6B) on the filter container, and close the latches tightly.

## 2.3. BUILDING THE CARBURETING UNIT WITH THE AIR AND THROTTLE CONTROLS

[Figures 2-22](#) and [2-23](#) show exploded views of the carbureting unit; the list of materials is given in [Table 2-4](#) (all figures and tables mentioned in Sect. 2 are presented at the end of Sect. 2). In the following

instruction's, all item numbers refer both to [Figs. 2-22](#) and [2-23](#) and to [Table 2-4](#). The following is a simple and easy way to assemble a carburetor to achieve both air mixture and throttle control. It can be mounted to either updraft or downdraft manifolds by simply turning the unit over. Most of the fabrication procedure below is devoted to the assembly of two butterfly valves: one for the throttle valve and one for the air mixture valve. The remainder of the carburetor unit can be assembled from ordinary, threaded plumbing parts.

The inside diameter of the piping used in the carburetor unit must be related to the size of the engine and should never be smaller than the intake opening on the engine manifold. If in doubt on the inside diameter for the pipe and/or hose sizes, always go with a larger diameter. This will reduce friction losses and will give longer operating hours between cleanings.

When the wood gas leaves the filter unit it should normally be below 180°F. About 2 ft from the filter container, an automotive water hose can be connected to the pipe on the carbureting unit. This rubber hose will keep engine vibration from creating air leaks in the filter unit or in the connecting piping. The hose must be a fairly new item; such hoses have a steel spring inside to keep them from collapsing when negative pressure is applied. The spring will soon rust if it has first been subjected to water and then to the hot wood gas enriched with hydrogen. The fabrication procedure for the assembly of two butterfly valves follows:

1. The manifold adapter (Item 1C in [Fig. 2-22](#)) must be fitted with bolts and/or holes for mounting onto the engine's existing intake manifold. Because gasoline engines are produced with so many different types of intake manifolds, ingenuity and common sense must be used to modify the manifold adapter (Item 1C) for each different engine to be operated on wood gas. A gasket (Item 7C) should be cut to match the shape of the engine intake fitting.
2. The butterfly valve (Item 3C) is shown in [Figs. 2-24](#) and [2-25](#); two such valves are required. A 3/8-in. hole should be drilled through the diameter of each valve body (Item 1CC) at the midpoint of its length.
3. The valve plate (Item 2CC) must be oval in shape with the dimensions given in [Table 2-4](#). An oval valve plate must be used so that, in the closed position, the valve will be about 10° off center. This will ensure that the valve will come to a complete stop in the closed position.
4. The edges of the valve plate (Item 2CC), around the longer diameter of the oval, should be beveled to provide a positive, airtight closure. Two evenly spaced, 1/4-in. holes should be drilled along the shorter diameter of the oval plate.
5. The valve support rod (Item 3CC) should be filed or ground flat on one side as shown in [Fig. 2-24](#); the flat area must begin 1/4 in. from one end and must continue for a distance equal to the inside diameter of the valve body (Item 1CC).

6. Two 3/16-in. holes should be drilled into the flat area of the valve support rod (Item 3CC); these holes must align with the holes in the valve plate (Item 2CC). They must also be tapped (with threads) to accept the valve plate screws (Item 4CC).
7. The butterfly valve (Item 3C) should be assembled by first placing the valve support rod (Item 3CC) through the hole in the valve body (Item 1CC). The valve plate (Item 2CC) should be dropped into one end of the valve body and then inserted into the flat area of the valve support rod. The two screws (Item 4CC) should be used to attach the valve plate to the support rod. Check to see that the assembled valve plate rotates freely and seats completely in the closed position.
8. A nut (Item 6CC) should be welded flat against one side of the throttle arm (Item 5CC) near its end. A 1/8-in. hole should be drilled into the side of the nut and must be threaded to accept the set screw (Item 7CC). At least one hole should be drilled into the throttle arm for attachment of the engine throttle control or air control linkages.
9. Place the nut (Item 6CC) on the throttle arm over the end of the valve support rod (Item 3CC) and use the set screw (Item 7CC) to secure the assembly. The throttle arm can be placed in any convenient orientation. Assembled butterfly valves are shown in [Fig. 2-26](#).
10. The remaining parts of the carburetor assembly should be screwed together as shown in [Fig. 2-27](#). Pipe thread compound should be used to make airtight connections. The assembled carburetor unit should be attached to the engine's intake manifold as shown in [Fig. 2-28](#)
11. This prototype gasifier was designed to operate if gasoline were unavailable; but, if dual operation on wood and gasoline is desired, the elbow (Item 2C) could be replaced with a tee, allowing a gasoline carburetor to also be mounted.
12. The arm on the butterfly valve (Item 3C) which is closest to the elbow (Item 2C) is to be connected to the foot- (or, on tractors, hand-) operated accelerator. The other butterfly valve is to be used as the air mixture control valve and can be operated with a manual choke cable. If the engine has an automatic choking device, then a hand operated choke cable should be installed. Both butterfly valves and their connecting control linkages must operate smoothly with the ability to adjust the valve yet keep it stationary in the selected position during operation. The linkages must close the valves airtight when the engine is off.
13. The air inlet (Item 6C) should be connected by an extension hose or pipe, either iron or plastic, to the existing engine's air filter in order to prevent road dust or agricultural residue from entering the engine.
14. The wood gas inlet (Item 5C) is to be connected to the outlet piping (Item 10B as shown in [Fig. 2-15](#)) from the wood gas filter unit. Part of this connection should be a high-temperature rubber or neoprene hose to absorb engine vibration.

[Back to Table of Contents](#)

**MENU: [HOME](#) » [Reconstruction](#) » [Recovery](#) » [Renewal](#) » [Energy Types](#)**

---

---

ORNL-Photo 4517-87



Fig. 2-21. Filter container (#1) showing latches (#2) for lid and hose (#3) around top.

# 3. OPERATING AND MAINTAINING YOUR WOOD GAS GENERATOR

## 3.1 USING WOOD AS A FUEL

Because wood was used extensively as generator fuel during World War II, and since it is plentiful in most parts of the populated United States, it merits particular attention for use as an emergency source of energy. When used in gas generators, about 20 lb. of wood have the energy equivalence of one gallon of gasoline.

Wood consists of carbon, oxygen, hydrogen, and a small amount of nitrogen. As a gas generator fuel, wood has several advantages. The ash content is quite low, only 0.5 to 2% (by weight), depending on the species and upon the presence of bark. Wood is free of sulfur, a contaminant that easily forms sulfuric acid which can cause corrosion damage to both the engine and the gas generator. Wood is easily ignited a definite virtue for the operation of any gas generator unit.

The main disadvantages for wood as a fuel are its bulkiness and its moisture content. As it is a relatively light material, one cubic yard of wood produces only 500 to 600 lb. of gas generator fuel. Moisture content is notoriously high in wood fuels, and it must be brought below 20% (by weight) before it can be used in a gas generator unit. By weight, the moisture in green wood runs from 25 to 60%, in air-dried wood from 12 to 15%, and in kiln-dried wood about 8%. Moisture content can be measured quite easily by carefully weighing a specimen of the wood, placing it in an oven at 220° F for thirty minutes, reweighing the specimen, and reheating it until its weight decreases to a constant value. The original moisture content is equivalent to the weight lost.

The prototype unit in this manual (with an 6-in.-diam firetube) operated well on both wood chips (minimum size: 3/4 by 3/4 by 1/4 in.) and blocks (up to 2-in. cubes); see [Fig. 3-1](#) (all figures and tables mentioned in Sect. 3 are presented at the end of Sect. 3). Larger sizes could be used, if the firetube diameter is increased to prevent bridging of the individual pieces of wood; of course, a throat restriction would then have to be added to the bottom of the firetube so as to satisfy the dimensions in [Table 2-2](#) in Sect. 2.

## 3.2 SPECIAL CONSIDERATIONS AND ENGINE MODIFICATIONS



To start the fire in the gasifier, the blower must be used to create a suction airflow through the wood in the hopper and downward in the firetube. If an especially high horse power engine is to be fueled by the gasifier unit, then it might be necessary to install two such blowers and run them simultaneously during start-up.

When the wood gas leaves the gasifier unit, all the oxygen pulled down with the air through the firetube has been chemically converted and is contained in carbon monoxide (CO) and water (H<sub>2</sub>O). The wood gas is unable to burn without being mixed with the proper amount of additional oxygen. If an air leak develops below the grate area, the hot gas will burn while consuming the available oxygen and will create heat; this will almost certainly destroy the gasifier unit if it is not detected soon. If an air leak develops in the filter unit or in the connecting piping, the gas will become saturated with improper amounts of oxygen and will become too dilute to power the engine. Therefore airtightness from the gasifier unit to the engine is absolutely essential.

Ideally, as the wood gas enters the engine manifold it should be mixed with air in a ratio of 1:1 or 1.1:1 (air to gas) by volume. The carburetion system described in this report will provide this mixture with a minimum of friction losses in the piping. The throttle control valve and the air control valve must be operable from the driver's seat of the vehicle. The engine's spark plug gaps should be adjusted to between 0.012 and 0.015 in.; the ignition timing should be adjusted to 'early.'

### **3.3 INITIAL START-UP PROCEDURE**

Initially, you will need to add charcoal to the grate below the firetube. Subsequent operation will already have the grate full of charcoal which has been left over from the previous operating period.

Fill the firetube with charcoal to a level 4 in. above the grate. Fill the hopper with air-dried wood; then, proceed with the routine start-up directions below.

Charcoal produced for outdoor barbecue grills is not well suited for gas generator use. To produce a better grade of charcoal, place a rag soaked in alcohol on the grate, or place 3 to 5 pages of newspaper on the grate, then fill the fire tube to a height of 10 to 12 in. with well-dried wood. Have all the valves closed and let the Fire tube act as a chimney until the wood is converted to charcoal.

### **3.4 ROUTINE START-UP PROCEDURE**

1. Agitate the grate shaker handle for at least twenty seconds to shake down the Charcoal from the previous operating period.
2. Open the ash cleanout port and remove the ashes from the generator housing drum. Lubricate the threads of the cleanout port with high-temperature silicone, and close the cover of the cleanout port so that it is airtight.

3. Fill the hopper with wood fuel, and tamp the fuel down lightly. Either leave the lid completely off the fuel hopper, or adjust the opening around the lid to a 3/4-in. (or larger) clearance.
4. Close the carburetor's air control valve and remove the cover from the blower exhaust on top of the filter unit. Start the blower, and let it run for thirty seconds to avoid explosion of residual gas in the system. Then, with the blower still operating, proceed with the next step.
5. Open the ignition port, and ignite a 12- by 12-in. piece of newspaper; with a long stick or wire, push the burning sheet of newspaper into the grate; see [Fig. 3-2](#). Close the ignition port. If no smoke appears at the blower's exhaust port, repeat the start-up sequence from Step (5). If repeated attempts fail, new charcoal should be added to the unit as described in Sect. 3.3, above, and the start-up ignition sequence should be repeated.
6. After a few minutes of smoky exhaust, test the gas at the, blower exhaust by safely and carefully attempting to ignite it, see [Fig. 3-3](#). When the gas burns consistently well, stop the blower and replace the cover on the blower exhaust.
7. Open the carburetor's air control valve, adjust the engine's accelerator, and start the engine in a normal manner. Let the engine warm up slowly (two to five minutes). If the engine fails to start or dies repeatedly, restart the blower and repeat the ignition sequence from Step (4).

## 3.5 DRIVING AND NORMAL OPERATION

Shift gears so as to keep the engine speed (rpm) high at all times. Remember that it is the vacuum created by the pistons that provides the force which moves the gas from the gasifier unit into the engine.

Refill the hopper with wood (as shown in [Fig. 3-4](#)) before it is completely empty, but avoid refilling just before the end of engine operation. Periodically shake down the ashes from the grate. If your system is equipped with a gas cooler, drain water from the cooler from time to time.

Under operation in dry weather, the gasifier can be operated without the lid on the fuel hopper. However, when the gasifier unit is shut down the hopper must be covered to prevent air from continuing to burn the wood in the hopper. Under wet-weather operation, the cover must be placed on the fuel hopper, and then lifted up and rotated about 2 in. until the triangular pieces line up with the holes in the support bars. The tension of the screen door springs will then hold the lid closed. See [Fig. 3-5](#) for clarification.

## 3.6 SHUTTING DOWN THE GASIFIER UNIT

When shutting down the gasifier unit, turn off the ignition switch and open the carburetor's air control valve for ten seconds to relieve any pressure from within the system. Then, completely close the air control valve, and place the cover tightly on the fuel hopper. When restarting after a short stopover, let the engine warm up briefly. After longer stops (up to one hour), tamp down the wood lightly and try to use the blower for restarting without relighting the wood fuel. After very long stops (over two hours) the charcoal must be ignited again.

## 3.7 ROUTINE MAINTENANCE

Periodically check all nuts on the gasifier unit, the fuel hopper, the filter unit, and the carburetor for snugness; check all penetrations and fittings for airtightness. In addition, perform the following maintenance activities as scheduled:

### 3.7.1 Daily Maintenance

Open the ash cleanout port of the gasifier housing drum and remove the ashes after shaking the grate for at least thirty seconds. Replace the cover of the port after coating the threads with high-temperature silicone to ensure airtightness. Open the drain tube, at the bottom of the filter container and allow any liquid condensate to drain out; remember to close the drain tube when finished.

### 3.7.2 Weekly Maintenance (or every 15 hours of operation)

Clean out the gasifier housing drum, the fuel hopper, and the filter. Rinse out the piping and connections to and from the filter. Replace the wood chips inside the filter, (The used wood chips from the filter can be dumped into the fuel hopper and burned to produce wood gas.) Use high-temperature silicone on all pipe connections and on the filter lid to ensure airtightness.

### 3.7.3 Biweekly Maintenance (or every 30 hours of operation)

Make sure that all pipe connections are secure and airtight. Check and tighten all mounting connections to the vehicle chassis. Check for rust on the outside of the gas generator housing drum, especially on the lower region. Coat with high-temperature protective paint as necessary.

## 3.8 OPERATING PROBLEMS AND TROUBLE-SHOOTING

A discussion of problems and their related causes and cures is contained in the trouble-shooting guide of [Table 3-1](#). Many operational problems can be traced to failure to maintain the airtightness of all piping connections and fittings; the piping should be routinely checked to prevent such problems.

## 3.9 HAZARDS ASSOCIATED WITH GASIFIER OPERATION

Unfortunately, gas generator operation involves certain problems, such as toxic hazards and fire hazards.

These hazards should not be treated lightly; their inclusion here, at the end of this report, does not mean that these hazards are unimportant. The reader should not underestimate the dangerous nature of these hazards.

### 3.9.1 Toxic Hazards

Many deaths in Europe during World War II were attributed to poisoning from wood gas generators. The danger of 'generator gas poisoning' was one of the reasons that such gasifiers were readily abandoned at the end of World War II. It is important to emphasize that generator gas poisoning' is carbon monoxide (CO) poisoning. Acute 'generator gas poisoning' is identical with the symptoms that may develop if a heating stove damper is closed too early, or if a gasoline vehicle is allowed to idle in a poorly ventilated garage.;[Table 3-2](#) shows how poisoning symptoms develop according to the concentration of carbon monoxide in breathable air. It is important to note that rather brief exposures to very small concentrations of carbon monoxide result in undesirable physiological effects.

In case of carbon monoxide poisoning, first aid should consist of the following procedures:

1. Move the victim quickly out into the open air or to a room with fresh air and good ventilation. All physical exertion on the part of the victim must be avoided.
2. If the victim is unconscious, every second is valuable. Loosen any tight clothing around the neck. If breathing has stopped, remove foreign objects from the mouth (false teeth, chewing gum, etc.) and immediately give artificial respiration.
3. Keep the victim warm.
4. Always call a physician.
5. In case of mild carbon monoxide poisoning without unconsciousness, the victim should be given oxygen if possible.

### 3.9.2 Technical Aspects of 'Generator Gas Poisoning'

Generator gas poisoning is often caused by technical defects in the functioning of the gas generator unit. When the engine is running, independent of the starting blower, the entire system is under negative pressure created by the engine's pistons; the risk of poisoning through leakage is therefore minimal. However, when the engine is shut off, formation of wood gas continues, causing an increase of pressure inside the generator unit. This pressure increase lasts for approximately 20 minutes after the engine is shut off. For this reason, it is not advisable to stay in the vehicle during this period. Also, the gas generator unit should be allowed to cool for at least 20 minutes before the vehicle is placed in an enclosed garage connected with living quarters. It should be emphasized that the gas formed during the

shutdown period has a carbon monoxide content of 23 to 27% and is thus very toxic.

### 3.9.3 Fire Hazard

The outside of a gas generator housing drum may reach the same temperature as a catalytic converter on today's automobiles. Care should be taken when operating in areas where dry grass or combustible material can come into contact with the housing drum of the gas generator unit. If a gas generator unit is mounted on a personal car, bus, van or truck, a minimum 6-in. clearance must be maintained around the unit. Disposal of ashes must only be attempted after the unit has cooled down (to below 150°F). Such residue must be placed away from any combustible material and preferably be hosed down with water for absolute safety.

---

[Back to Table of Contents](#)

**MENU:** [HOME](#) » [Reconstruction](#) » [Recovery](#) » [Renewal](#) » [Energy Types](#)

---

---

# BIBLIOGRAPHY

Anonymous, 'Coast to Coast on Homemade Fuel,' The Mother Earth News (No. 73) pp. 178-179 (January/February 1982).

Anonymous, 'Wood Gas Update,' in Mother Earth News (No. 71) pp. 164-165 (September/October 1981).

Anonymous, 'Mother's Woodburning Truck,' The Mother Earth News (No. 69) pp. 126-129 (May/June 1981).

Chatterjee, A.K., State of the Art Report on Pyrolysis of Wood and Agricultural Biomass, PN-AAK-818, U.S. Department of Agriculture, Newark, NJ, March 1981.

Cruz, I.E., Producer-Gas Technology for Rural Applications, published by the Food and Agriculture Organization of the United Nations, New York, NY, 1985.

Donath, E.E., 'Vehicle Gas Producers,' Processing Technology (3) pp. 141-153 (1980).

Eoff, K.M., and D.M. Post, 'How to Power a Gasoline Engine with Wood,' Technical Reprint No. 1, The Mother Earth News, Hendersonville, NC, 1981.

Kaupp, A., and J.R. Goss, State of the Art Report for Small Scale (to 50kW) Gas Producer-Engine Systems, USDA Contract No. 53-319R-O-141, University of California, Davis, CA, March 1981.

Miller, B., State-of-the-Art Survey of Wood Gasification, EPRI-AP-3101, Fred C. Hart Associates, Inc., Washington, DC, May 1983.

Nygards, N., Wood Gas Generator Vehicles (a translation of the Swedish book), published by Purwaco International, Minneapolis, MN, 1979.

Oliver, E.D., Technical Evaluation of Wood Gasification, EPRI-AP-2567, Synthetic Fuels Association, Inc., Palo Alto, CA, August 1982.

Reed, T.B. (ed), A Survey of Biomass Gasification, VoL 1--Synopsis and executive Summary, SERI/TR-33-239 (Vol. I), Solar Energy Research Institute, Golden, CO, July 1979.

Reed, T.B. (ed), A Survey of Biomass Gasification VoL II -- Principles of Gasification, SERM-33-239

(Vol. II), Solar Energy Research Institute, Golden, CO, July 1979.

Reed, T.B. (ed), A Survey of Biomass Gasification, VoL III -- Current Technology and Research, SERM-33-239 (Vol. III), Solar Energy Research Institute, Golden, CO, April 1980.

Reed, T.B., and A- Das, Handbook of Biomass Downdraft Gasifier Engine Systems, SERI/SP-271-3022, Solar Research Institute, Golden, CO, March 1988.

Reed, T.B., and D. Jantzen, Generator Gas: The Swedish experience from 1939-1945 (a translation of the Swedish book, Gengas), SERI/SP-33-140, Solar Energy Research Institute, Golden, CO, January 1979.

Skov, N., and M.L. Papworth, PEGASUS (Petroleum/Gasoline Substitute Systems), published by the Pegasus Publishing Co., Miami, FL, 1974.

Vietmeyer, N.L., et al., Producer Gas: Another Fuel for Motor Vehicle Transport, published by the National Academy Press, Washington, DC, 1983.

Wise, D.L. (ed.), Fuel Gas from Biomass, published by the CRC Press, Boca Raton, FL, 1981.

---

Construction Plans for Other Wood Gas Generator Units can be Purchased from the Following Organizations:

PEGASUS Publishing Co.  
1995 Keystone Blvd.  
Miami, FL 33181

Missouri Gasification Systems, Inc.  
Route 3, Box 198  
California, MO 65018

Mother's Plans  
The Mother Earth News  
P.O. Box 70  
Hendersonville, NC 28791

Nunnikhoven Industries  
P. O. Box 580  
Mediapolis, IA 52637

[Back to Table of Contents](#)

**MENU: [HOME](#) » [Reconstruction](#) » [Recovery](#) » [Renewal](#) » [Energy Types](#)**

---

---



# Construction of a Simplified Wood Gas Generator for Fueling Internal Combustion Engines in a Petroleum Emergency Final Report



APPROVED FOR PUBLIC RELEASE: DISTRIBUTION UNLIMITED





# **Construction of a Simplified Wood Gas Generator for Fueling Internal Combustion Engines in a Petroleum Emergency Final Report**

*by:*

H. LaFontaine, Biomass Energy Foundation, Inc.  
Miami, Florida

*and*

F. P. Zimmerman, Oak Ridge National Laboratory, Energy Division

FEMA Interagency Agreement Number: EMW-84-E-1737  
Work Unit: 3521D

*for:*

Federal Emergency Management Agency  
Washington, D.C. 20472

"This report has been reviewed in the Federal Emergency Management Agency and approved for publication. Approval does not signify that the contents necessarily reflect the views and policies of the Federal Emergency Management Agency."

Date Published: March 1989

**APPROVED FOR PUBLIC RELEASE: DISTRIBUTION UNLIMITED**

Prepared by:

Oak Ridge National Laboratory  
Oak Ridge, Tennessee 37831-6285  
for the U.S. Department of Energy





## REPORT DOCUMENTATION PAGE

1a. REPORT SECURITY CLASSIFICATION Unclassified			1b. RESTRICTIVE MARKINGS None			
2a. SECURITY CLASSIFICATION AUTHORITY			3. DISTRIBUTION/AVAILABILITY OF REPORT  Unlimited			
2b. DECLASSIFICATION/DOWNGRADING SCHEDULE N/A						
4. PERFORMING ORGANIZATION REPORT NUMBER(S) ORNL-6404			5. MONITORING ORGANIZATION REPORT NUMBER(S) N/A			
6a. NAME OF PERFORMING ORGANIZATION Oak Ridge National Lab.		6b. OFFICE SYMBOL (if applicable)		7a. NAME OF MONITORING ORGANIZATION		
6c. ADDRESS (City, State, and ZIP Code) P. O. Box 2008 Oak Ridge, TN 37831-6190			7b. ADDRESS (City, State, and ZIP Code)			
8a. NAME OF FUNDING/SPONSORING ORGANIZATION Federal Emergency Mgmt. Agency		8b. OFFICE SYMBOL (if applicable)		9. PROCUREMENT INSTRUMENT IDENTIFICATION NUMBER Interagency Agreement No. EMW 84 E 1737		
8c. ADDRESS (City, State, and ZIP Code) 500 C Street, SW Washington, DC 20472			10. SOURCE OF FUNDING NUMBERS			
			PROGRAM ELEMENT NO.	PROJECT NO.	TASK NO.	WORK UNIT ACCESSION NO. 3521D
11. TITLE (Include Security Classification) Construction of a Simplified Wood Gas Generator for Fueling Internal Combustion Engines in a Petroleum Emergency						
12. PERSONAL AUTHOR(S) Harry LaFontaine, Gregory P. Zimmerman						
13a. TYPE OF REPORT Final		13b. TIME COVERED FROM _____ TO _____		14. DATE OF REPORT (Year, Month, Day) March 1979		15. PAGE COUNT 85
16. SUPPLEMENTARY NOTATION						
17. COSATI CODES			18. SUBJECT TERMS (Continue on reverse if necessary and identify by block number) Emergency Technology, Wood Gasification, Wood Gas, Producer Gas, Downdraft Gasifier, Stratified Gasifier, Petroleum Crisis, Alternate Fuels, Internal Combustion Engines			
FIELD	GROUP	SUB-GROUP				
19. ABSTRACT (Continue on reverse if necessary and identify by block number) This report is one in a series of emergency technology assessments sponsored by the Federal Emergency Management Agency (FEMA). The purpose of this report is to develop detailed, illustrated instructions for the fabrication, installation, and operation of a biomass gasifier unit (that is, a "producer gas" generator, also called a "wood gas" generator) which is capable of providing emergency fuel for vehicles, such as tractors and trucks, in the event that normal petroleum sources were severely disrupted for an extended period of time. These instructions are prepared in the format of a manual for use by any mechanic who is reasonably proficient in metal fabrication or engine repair.  This report attempts to preserve the knowledge about wood gasification as put into practical use during World War II. Detailed, step-by-step fabrication procedures are presented for a simplified version of the World War II, Imbert wood gas generator. This simple, stratified,  (contd)						
20. DISTRIBUTION/AVAILABILITY OF ABSTRACT <input type="checkbox"/> UNCLASSIFIED/UNLIMITED <input type="checkbox"/> SAME AS RPT. <input type="checkbox"/> DTIC USERS				21. ABSTRACT SECURITY CLASSIFICATION		
22a. NAME OF RESPONSIBLE INDIVIDUAL			22b. TELEPHONE (Include Area Code)		22c. OFFICE SYMBOL	

19. ABSTRACT (contd)

downdraft gasifier unit can be constructed from materials which would be widely available in the United States in a prolonged petroleum crisis. For example, the body of the unit consists of a galvanized metal garbage can atop a small metal drum; common plumbing fittings are used throughout; and a large, stainless steel mixing bowl is used for the grate. The entire compact unit was mounted onto the front of a farm tractor and successfully field tested, using wood chips as the only fuel. Photographic documentation of the actual assembly of the unit as well as its operation is included.

## CONTENTS

	Page
EXECUTIVE SUMMARY .....	v
S.1. PRINCIPLES OF SOLID FUEL GASIFICATION .....	vi
S.2. THE STRATIFIED, DOWNDRAFT GASIFIER .....	vi
CONVERSION FACTORS FOR SI UNITS .....	xiii
LIST OF FIGURES .....	xv
LIST OF TABLES .....	xvii
ABSTRACT .....	1
1. WHAT IS A WOOD GAS GENERATOR AND HOW DOES IT WORK? ...	3
1.1. INTRODUCTION .....	3
1.2. PRINCIPLES OF SOLID FUEL GASIFICATION .....	4
1.3. BACKGROUND INFORMATION .....	5
1.3.1. The World War II, Imbert Gasifier .....	6
1.3.2. The Stratified, Downdraft Gasifier .....	7
2. BUILDING YOUR OWN WOOD GAS GENERATOR .....	13
2.1. BUILDING THE GAS GENERATOR UNIT AND THE FUEL HOPPER .....	14
2.2. BUILDING THE PRIMARY FILTER UNIT .....	17
2.3. BUILDING THE CARBURETING UNIT WITH THE AIR AND THROTTLE CONTROLS .....	19
3. OPERATING AND MAINTAINING YOUR WOOD GAS GENERATOR ...	55
3.1. USING WOOD AS A FUEL .....	55
3.2. SPECIAL CONSIDERATIONS AND ENGINE MODIFICATIONS ...	55
3.3. INITIAL START-UP PROCEDURE .....	56
3.4. ROUTINE START-UP PROCEDURE .....	56
3.5. DRIVING AND NORMAL OPERATION .....	57
3.6. SHUTTING-DOWN THE GASIFIER UNIT .....	57
3.7. ROUTINE MAINTENANCE .....	57
3.7.1 Daily Maintenance .....	58
3.7.2 Weekly Maintenance (or every 15 hours of operation) .....	58
3.7.3 Biweekly Maintenance (or every 30 hours of operation) .....	58
3.8. OPERATING PROBLEMS AND TROUBLE-SHOOTING .....	58
3.9. HAZARDS ASSOCIATED WITH GASIFIER OPERATION .....	58
3.9.1. Toxic Hazards .....	58
3.9.2. Technical Aspects of "Generator Gas Poisoning" .....	59
3.9.3. Fire Hazard .....	59
BIBLIOGRAPHY .....	67





## EXECUTIVE SUMMARY

This report is one in a series of emergency technology assessments sponsored by the Federal Emergency Management Agency (FEMA). The purpose of this report is to develop detailed, illustrated instructions for the fabrication, installation, and operation of a biomass gasifier unit (i.e., a "producer gas" generator, also called a "wood gas" generator) which is capable of providing emergency fuel for vehicles, such as tractors and trucks, should normal petroleum sources be severely disrupted for an extended period of time. These instructions have been prepared as a manual for use by any mechanic who is reasonably proficient in metal fabrication or engine repair.

Fuel gas, produced by the reduction of coal and peat, was used for heating as early as 1840 in Europe and by 1884 had been adapted to fuel engines in England. Prior to 1940, gas generator units were a familiar, but not extensively utilized, technology. However, petroleum shortages during World War II led to widespread gas generator applications in the transportation industries of Western Europe. (Charcoal-burning taxis, a related application, were still common in Korea as late as 1970.) The United States, never faced with such prolonged or severe oil shortages, has lagged far behind Europe and the Orient in familiarity with and application of this technology. However, a catastrophic event could disrupt the supply of petroleum in this country so severely that this technology might be critical in meeting the energy needs of some essential economic activities, such as the production and distribution of food.

In occupied Denmark during World War II, 95% of all mobile farm machinery, tractors, trucks, stationary engines, and fishing and ferry boats were powered by wood gas generator units. Even in neutral Sweden, 40% of all motor traffic operated on gas derived from wood or charcoal. All over Europe, Asia, and Australia, millions of gas generators were in operation between 1940 and 1946. Because of the wood gasifier's somewhat low efficiency, the inconvenience of operation, and the potential health risks from toxic fumes, most of such units were abandoned when oil again became available in 1945. Except for the technology of producing alternate fuels, such as methane or alcohol, the only solution for operating existing internal combustion engines, when oil and petroleum products are not available, has been these simple, inexpensive gasifier units.

This report attempts to preserve the knowledge about wood gasification that was put into practical use during World War II. In this report, detailed step-by-step procedures are presented for constructing a simplified version of the World War II wood gas generator; this simple, stratified, downdraft gasifier unit (shown schematically in Fig. S-1) can be constructed from materials which would be widely available in the United States in a prolonged petroleum crisis. For example, the body of the unit consists of a galvanized metal garbage can atop a small metal drum; common plumbing fittings are used throughout; and a large, stainless steel mixing bowl is used for the grate. A prototype gasifier unit was fabricated from these instructions (see Fig. S-2); this unit was then mounted onto the front of a farm tractor and successfully field tested, using wood chips as the only fuel (see Fig. S-3). Photographic documentation of the actual assembly of the unit, as well as its operational field test, is included in the body of this report.

The use of wood gas generators need not be limited to transportation applications. Stationary engines can also be fueled by wood gasifiers to run electric generators, pumps, and industrial equipment. In fact, the use of wood gas as a fuel is not even restricted to

gasoline engines; if a small amount of diesel fuel is used for ignition, a properly adjusted diesel engine can be operated primarily on wood gas introduced through the intake manifold.

## **S.1. PRINCIPLES OF SOLID FUEL GASIFICATION**

All internal combustion engines actually run on vapor, not liquid. The liquid fuels used by gasoline engines are vaporized before they enter the combustion chamber above the pistons. In diesel engines, the fuel is sprayed into the combustion chamber as fine droplets which burn as they vaporize. The purpose of a gasifier, then, is to transform solid fuels into gaseous ones and to keep the gas free of harmful constituents. A gas generator unit is simultaneously an energy converter and a filter. In these twin tasks lie its advantages and its difficulties.

In a sense, gasification is a form of incomplete combustion—heat from the burning solid fuel creates gases which are unable to burn completely because of the insufficient amounts of oxygen from the available supply of air. The same chemical laws which govern combustion processes also apply to gasification. There are many solid biomass fuels suitable for gasification—from wood and paper to peat, lignite, and coal, including coke derived from coal. All of these solid fuels are composed primarily of carbon with varying amounts of hydrogen, oxygen, and impurities, such as sulphur, ash, and moisture. Thus, the aim of gasification is the almost complete transformation of these constituents into gaseous form so that only the ashes and inert materials remain. In creating wood gas for fueling internal combustion engines, it is important that the gas not only be properly produced, but also preserved and not consumed until it is introduced into the engine where it may be appropriately burned.

Gasification is a physiochemical process in which chemical transformations occur along with the conversion of energy. The chemical reactions and thermochemical conversions which occur inside a wood gas generator are too long and too complicated to be covered here; however, such knowledge is not necessary for constructing and operating a wood gasifier. By weight, gas (wood gas) produced in a gasifier unit contains approximately 20% hydrogen ( $H_2$ ), 20% carbon monoxide ( $CO$ ), and small amounts of methane, all of which are combustible, plus 50 to 60% nitrogen ( $N_2$ ). The nitrogen is not combustible; however, it does occupy volume and dilutes the wood gas as it enters and burns in an engine. As the wood gas burns, the products of combustion are carbon dioxide ( $CO_2$ ) and water vapor ( $H_2O$ ).

One of the by-products of wood gasification is carbon monoxide, a poisonous gas. The toxic hazards associated with breathing this gas should be avoided during refueling operations or prolonged idling, particularly in inadequately ventilated areas. Except for the obvious fire hazard resulting from the combustion processes inside the unit, carbon monoxide poisoning is the major potential hazard during normal operation of these simplified gasifier units.

## **S.2. THE STRATIFIED, DOWNDRAFT GASIFIER**

Until the early 1980s, wood gasifiers all over the world (including the World War II designs) operated on the principle that both the fuel hopper and the combustion unit be absolutely airtight; the hopper was sealed with a top or lid which had to be opened every time wood was added. Smoke and gas vented into the atmosphere while wood was being loaded; the operator had to be careful not to breathe the unpleasant smoke and toxic fumes.

Over the last few years, a new gasifier design has been developed through cooperative efforts among researchers at the Solar Energy Research Institute in Colorado, the University of California in Davis, the Open University in London, the Buck Rogers Company in Kansas, and the Biomass Energy Foundation, Inc., in Florida. This simplified design employs a balanced, negative-pressure concept in which the old type of sealed fuel hopper is no longer necessary. A closure is only used to preserve the fuel when the engine is stopped. This new technology has several popular names, including "stratified, downdraft gasification" and "open top gasification." Several years of laboratory and field testing have indicated that such simple, inexpensive gasifiers can be built from existing hardware and will perform very well as emergency units.

A schematic diagram of the stratified, downdraft gasifier is shown in Fig. S-1. During operation of this gasifier, air passes uniformly downward through four zones, hence the name "stratified:"

1. The uppermost zone contains unreacted fuel through which air and oxygen enter. This region serves the same function as the fuel hopper in the older, World War II designs.
2. In the second zone, the wood fuel reacts with oxygen during pyrolysis. Most of the volatile components of the fuel are burned in this zone and provide heat for continued pyrolysis reactions. At the bottom of this zone, all of the available oxygen from the air should be completely reacted. The open top design ensures uniform access of air to the pyrolysis region.
3. The third zone is made up of charcoal from the second zone. Hot combustion gases from the pyrolysis region react with the charcoal to convert the carbon dioxide and water vapor into carbon monoxide and hydrogen.
4. The inert char and ash, which constitute the fourth zone, are normally too cool to cause further reactions; however, because the fourth zone is available to absorb heat or oxygen as conditions change, it serves both as a buffer and as a charcoal storage region. Below this zone is the grate. The presence of char and ash serves to protect the grate from excessive temperatures.

The stratified, downdraft design has a number of advantages over the World War II gasifier designs. The open top permits fuel to be fed more easily and allows easy access. The cylindrical shape is easy to fabricate and permits continuous flow of fuel. No special fuel shape or pretreatment is necessary; any blocky fuel can be used.

The foremost question about the operation of the stratified, downdraft gasifier concerns char and ash removal. As the charcoal reacts with the combustion gases, it eventually reaches a very low density and breaks up into a dust containing all of the ash as well as a percentage of the original carbon. This dust may be partially carried away by the gas and might eventually begin to plug the gasifier. Hence, it must be removed by shaking or agitation. When the stratified gasifier unit is used to power vehicles, it is automatically shaken by the vehicle's motion.

An important issue in the design of the stratified, downdraft gasifier is the prevention of fuel bridging and channeling. High-grade biomass fuels, such as wood blocks or chips, will flow down through the gasifier because of gravity and downdraft air flow. However, other fuels (such as shredded chips, sawdust, and bark) can form a bridge, which will obstruct

continuous flow and cause very high temperatures. Bridging can be prevented by stirring, shaking, or by agitating the grate or by having it agitated by the vehicle's movement. For prolonged idling, a hand-operated shaker has been included in the design in this report.

A prototype unit of the stratified, downdraft gasifier design (see Figs. S-2 and S-3) has been fabricated according to the instructions in this report; however, it has not been widely tested at this time. The reader is urged to use his ingenuity and initiative in constructing his own wood gas generator. As long as the principle of airtightness in the combustion regions, in the connecting piping, and in the filter units is followed, the form, shape, and method of assembly is not important.

The wood gasifier design presented in this report has as its origin the proven technology used in World War II during actual shortages of gasoline and diesel fuel. It should be acknowledged that there are alternate technologies (such as methane production or use of alcohol fuels) for keeping internal combustion engines in operation during a prolonged petroleum crisis; the wood gasifier unit described in this report represents only one solution to the problem.

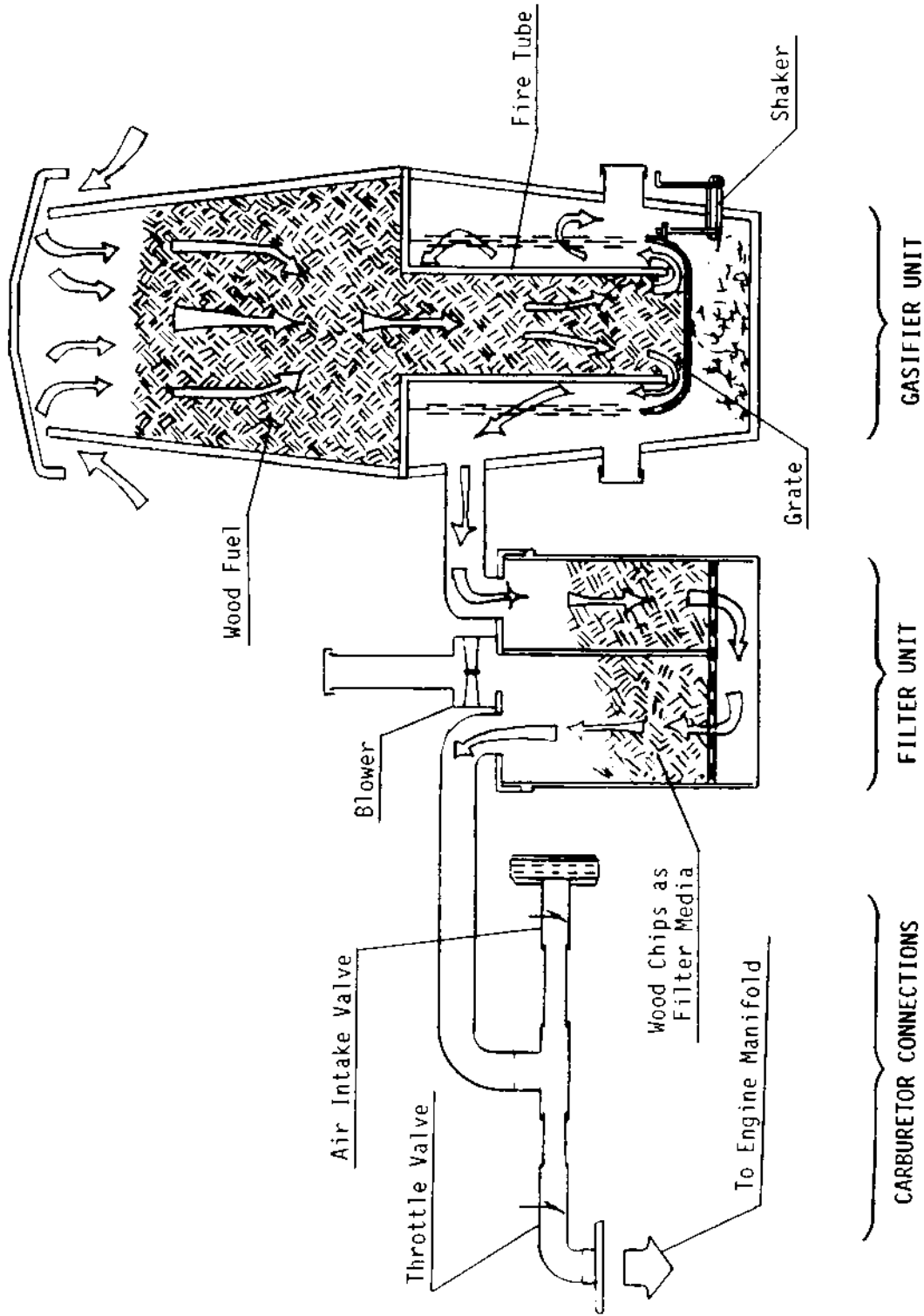
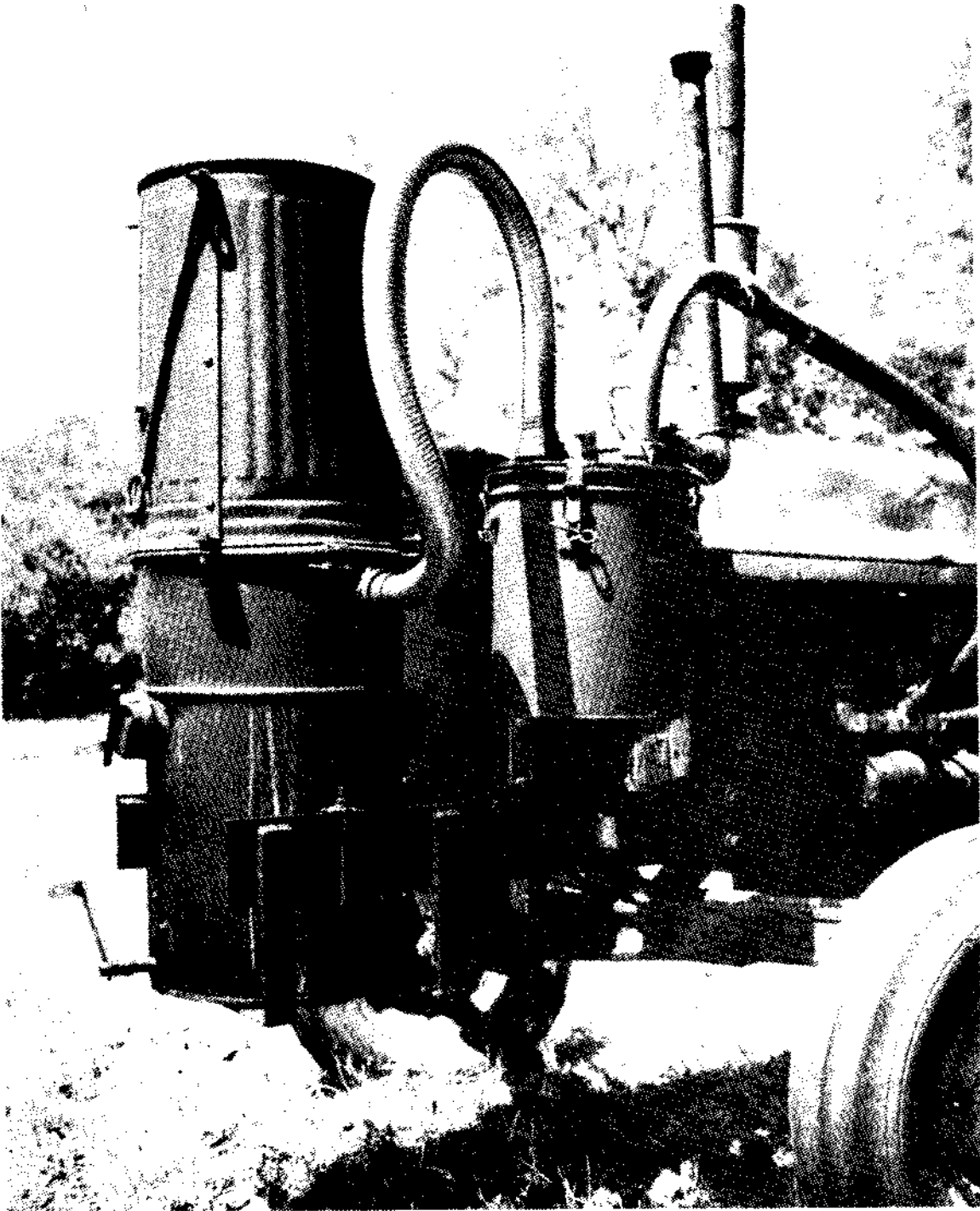


Fig. S-1. Schematic view of the stratified, downdraft gasifier.



**Fig. S-2. The prototype wood gas generator unit mounted onto a tractor.**

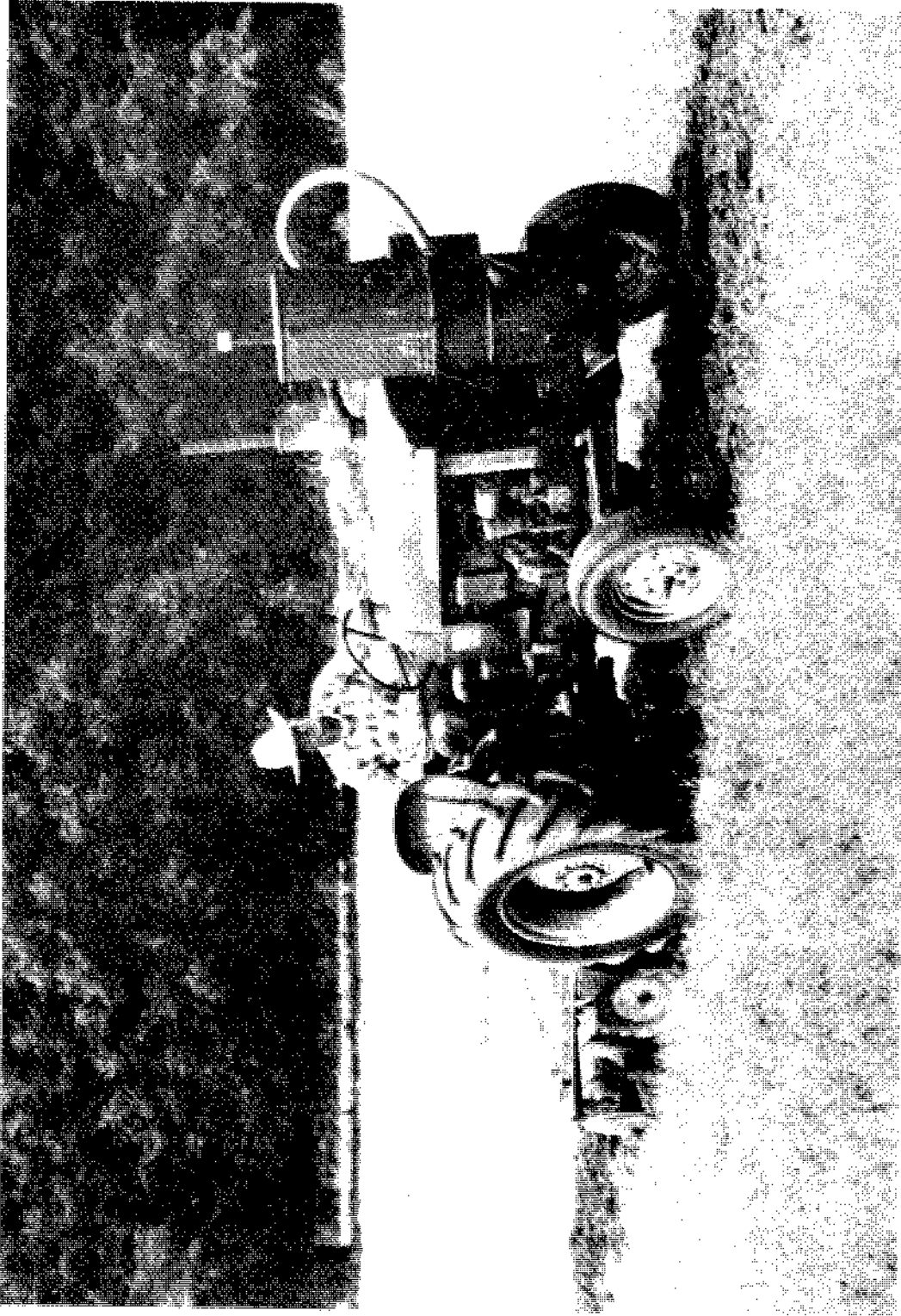


Fig. S-3. Wood gas generator unit in operation during field testing.





## CONVERSION FACTORS FOR SI UNITS

English units have been retained in the body of this report. The report refers to commercially available materials and sizes which are commonly expressed in English units. The conversion factors for SI units are given below:

<u>To convert from</u>	<u>To</u>	<u>Multiply by</u>
cubic feet (ft <sup>3</sup> )	cubic meters (m <sup>3</sup> )	0.0283
cubic yards (yd <sup>3</sup> )	cubic meters (m <sup>3</sup> )	0.7646
Fahrenheit degrees (°F)	Kelvin degrees (°K)	(see Note 1)
foot (ft)	meter (m)	0.3048
gallon (gal)	cubic meters (m <sup>3</sup> )	3.785 X 10 <sup>-3</sup>
horsepower (hp)	watt (W)	745.7
inch (in.)	meter (m)	0.0254
pound (lb)	kilogram (kg)	0.4536
quart (qt.)	cubic meters (m <sup>3</sup> )	9.464 X 10 <sup>-4</sup>

---

Note 1: To convert temperatures, use the following equation,

$$K = 273 + 0.5556 \times (F - 32) ,$$

where

F is the temperature in Fahrenheit degrees, and

K is the temperature in Kelvin degrees.



## LIST OF FIGURES

Fig. S-1.	Schematic view of the stratified, downdraft gasifier	ix
Fig. S-2.	The prototype wood gas generator unit mounted onto a tractor	x
Fig. S-3.	Wood gas generator unit in operation during field testing	xi
Fig. 1-1.	Wood gas generator unit in operation during field testing	9
Fig. 1-2.	Schematic view of the World War II, Imbert gasifier	10
Fig. 1-3.	Schematic view of the stratified, downdraft gasifier	11
Fig. 2-1.	The prototype wood gas generator unit mounted onto a tractor	22
Fig. 2-2.	Exploded, schematic diagram of the wood gas generator unit and the fuel hopper	23
Fig. 2-3.	The fire tube and circular top plate of the gasifier unit	24
Fig. 2-4.	Drilling holes into the stainless steel mixing bowl to be used for the grate	25
Fig. 2-5.	Chains attached to the lip of the stainless steel mixing bowl	26
Fig. 2-6.	Connect the mixing bowl to the top plate with chains	27
Fig. 2-7.	Braze, <u>do not weld</u> , the plumbing fittings to the thin walled drums	28
Fig. 2-8.	Exploded, schematic diagram of the grate shaking mechanism	29
Fig. 2-9.	Parts for the shaker assembly	30
Fig. 2-10.	The support frame can be brazed or bolted to the side of the gasifier unit	31
Fig. 2-11.	Containers used in constructing the prototype gasifier unit	32
Fig. 2-12.	Cover for the fuel hopper.	33
Fig. 2-13.	Operating configuration of the fuel hopper and its cover	34
Fig. 2-14.	Lock ring and welded tabs	35
Fig. 2-15.	Exploded, schematic diagram of the filter unit	36
Fig. 2-16.	Detail of the standoffs for the bottom plate of the filter unit	37
Fig. 2-17.	Divider plate (#1) and bottom plate (#3), with standoffs (#4), for the filter unit	38
Fig. 2-18.	Circular lid (#1) for the filter unit	39
Fig. 2-19.	Blower (#1) with exhaust extension assembly	40
Fig. 2-20.	Assembled and installed blower (#1), extension assembly (#4), and conduit connectors for gas inlet (#2) and outlet (#3) on lid of filter unit	41
Fig. 2-21.	Filter container (#1) showing latches (#2) for lid and hose (#3) around top	42
Fig. 2-22.	Exploded, schematic diagram of the carbureting unit and control valves	43
Fig. 2-23.	Schematic diagram of a butterfly control valve.	44
Fig. 2-24.	Parts required for the butterfly valve	45
Fig. 2-25.	Butterfly valve assembly	46
Fig. 2-26.	Assembled butterfly valves	47
Fig. 2-27.	Assembled carburetion unit	48

## LIST OF FIGURES (continued)

Fig. 2-28.	Carburetion unit attached to engine's existing intake manifold . . . . .	49
Fig. 3-1.	Virtually all varieties of wood chips can be used for fuel . . . . .	60
Fig. 3-2.	Ignite a single piece of newspaper to start the gasifier unit; push the flaming newspaper through the ignition port and directly into the grate . . . . .	61
Fig. 3-3.	Igniting the exhaust gas will demonstrate that the gasifier unit is working properly . . . . .	62
Fig. 3-4.	Refill the fuel hopper before it becomes two-thirds empty . . . . .	63
Fig. 3-5.	The lid must be used to cover the fuel hopper in wet weather or when shutting the unit down . . . . .	64

## LIST OF TABLES

Table 2-1.	List of materials for the gasifier unit and the wood fuel hopper . . . . .	50
Table 2-2.	Fire tube dimensions . . . . .	52
Table 2-3.	List of materials for the primary filter unit . . . . .	53
Table 2-4.	List of materials for the carbureting unit . . . . .	54
Table 3-1.	Trouble-shooting your wood gas generator . . . . .	65
Table 3-2.	Effects of breathing carbon monoxide . . . . .	66



**CONSTRUCTION OF A SIMPLIFIED WOOD GAS GENERATOR  
FOR FUELING INTERNAL COMBUSTION ENGINES  
IN A PETROLEUM EMERGENCY**

H. LaFontaine  
G. P. Zimmerman

**ABSTRACT**

This report is one in a series of emergency technology assessments sponsored by the Federal Emergency Management Agency (FEMA). The purpose of this report is to develop detailed, illustrated instructions for the fabrication, installation, and operation of a biomass gasifier unit (i.e., a "producer gas" generator, also called a "wood gas" generator) that is capable of providing emergency fuel for vehicles, such as tractors and trucks, in the event that normal petroleum sources were severely disrupted for an extended period of time. These instructions have been prepared as a manual for use by any mechanic who is reasonably proficient in metal fabrication or engine repair.

This report attempts to preserve the knowledge about wood gasification that was put into practical use during World War II. Detailed, step-by-step fabrication procedures are presented for a simplified version of the World War II, Imbert wood gas generator. This simple, stratified, downdraft gasifier unit can be constructed from materials that would be widely available in the United States in a prolonged petroleum crisis. For example, the body of the unit consists of a galvanized metal garbage can atop a small metal drum; common plumbing fittings throughout; and a large, stainless steel mixing bowl for the grate. The entire compact unit was mounted onto the front of a farm tractor and successfully field tested, using wood chips as the only fuel. Photographic documentation of the actual assembly of the unit as well as its operation is included.

---





## 1. WHAT IS A WOOD GAS GENERATOR AND HOW DOES IT WORK?

This report is one in a series of emergency technology assessments sponsored by the Federal Emergency Management Agency (FEMA). The purpose of this report is to develop detailed, illustrated instructions for the fabrication, installation, and operation of a biomass gasifier unit (i.e., a "producer gas" generator, also called a "wood gas" generator) that is capable of providing emergency fuel for vehicles, such as tractors and trucks, in the event that normal petroleum sources were severely disrupted for an extended period of time. These instructions have been prepared as a manual for use by any mechanic who is reasonably proficient in metal fabrication or engine repair.

### 1.1 INTRODUCTION

Fuel gas, produced by the reduction of coal and peat, was used for heating, as early as 1840 in Europe, and by 1884 it had been adapted to fuel engines in England. Before 1940, gas generator units were a familiar, but not extensively utilized, technology. However, petroleum shortages during World War II led to widespread gas generator applications in the transportation industries of Western Europe. (Charcoal-burning taxis, a related application, were still common in Korea as late as 1970.) The United States, never faced with such prolonged or severe oil shortages, has lagged far behind Europe and the Orient in familiarity with and application of this technology; however, a catastrophe could so severely disrupt the supply of petroleum in this country that this technology might be critical in meeting the energy needs of some essential economic activities, such as the production and distribution of food.

This report attempts to preserve the knowledge about wood gasification as put into practical use during World War II. Detailed, step-by-step procedures are presented in this report for constructing a simplified version of the World War II, Imbert wood gas generator. This simple, stratified, downdraft gasifier unit can be constructed from materials that would be widely available in the United States in a prolonged petroleum crisis. For example, the body of the unit consists of a galvanized metal garbage can atop a small metal drum; common plumbing fittings throughout; and a large, stainless steel mixing bowl for the grate. A prototype gasifier unit was fabricated from these instructions. This unit was then mounted onto the front of a gasoline-engine farm tractor and successfully field tested, using wood chips as the only fuel; see Fig. 1-1 (all figures and tables are presented at the end of their respective sections). Photographic documentation of the actual assembly of the unit, as well as its operational field test, is included in this report.

The use of wood gas generators need not be limited to transportation applications. Stationary engines can also be fueled by wood gasifiers to run electric generators, pumps, and industrial equipment. In fact, the use of wood gas as a fuel is not even restricted to gasoline engines; if a small amount of diesel fuel is used for ignition, a properly adjusted diesel engine can be operated primarily on wood gas introduced through the intake manifold. However, this report is concerned with the operation of four-cycle gasoline engines rated from 10 to 150 horsepower. If more information is needed about operating gasifiers on other

fuels (such as coal, charcoal, peat, sawdust or seaweed), a list of relevant literature is contained in the Bibliography at the end of this report.

The goal of this report is to furnish information for building a homemade wood gas generator made out of ordinary, available hardware, in order to get tractors, trucks, and other vehicles operating without delay, if a severe liquid fuel emergency should arise. Section 1 describes gasification principles and wood gas generators, in general, and gives some historical background about their operation and effectiveness. Section 2 contains detailed step-by-step instructions for constructing your own wood gas generator unit; illustrations and photographs are included to prevent confusion. Section 3 contains information on operating, maintaining, and trouble-shooting your wood gas generator; also included are some very important guidelines on safety when using your gasifier system.

The wood gasifier design presented in this report has as its origin the proven technology used in World War II during actual shortages of gasoline and diesel fuel. It should be acknowledged that there are alternate technologies (such as methane production or use of alcohol fuels) for keeping internal combustion engines in operation during a prolonged petroleum crisis; the wood gasifier unit described in this report represents only one solution to the problem.

## 1.2 PRINCIPLES OF SOLID FUEL GASIFICATION

All internal combustion engines actually run on vapor, not liquid. The liquid fuels used in gasoline engines are vaporized before they enter the combustion chamber above the pistons. In diesel engines, the fuel is sprayed into the combustion chamber as fine droplets which burn as they vaporize. The purpose of a gasifier, then, is to transform solid fuels into gaseous ones and to keep the gas free of harmful constituents. A gas generator unit is, simultaneously, an energy converter and a filter. In these twin tasks lie its advantages and its difficulties.

The first question many people ask about gasifiers is, "Where does the combustible gas come from?" Light a wooden match; hold it in a horizontal position; and notice that while the wood becomes charcoal, it is not actually burning but is releasing a gas that begins to burn brightly a short distance away from the matchstick. Notice the gap between the matchstick and the luminous flame; this gap contains the wood gas which starts burning only when properly mixed with air (which contains oxygen). By weight, this gas (wood gas) from the charring wood contains approximately 20% hydrogen ( $H_2$ ), 20% carbon monoxide ( $CO$ ), and small amounts of methane, all of which are combustible, plus 50 to 60% nitrogen ( $N_2$ ). The nitrogen is not combustible; however, it does occupy volume and dilutes the wood gas as it enters and burns in an engine. As the wood gas burns, the products of combustion are carbon dioxide ( $CO_2$ ) and water vapor ( $H_2O$ ).

The same chemical laws which govern combustion processes also apply to gasification. The solid, biomass fuels suitable for gasification cover a wide range, from wood and paper to peat, lignite, and coal, including coke derived from coal. All of these solid fuels are composed primarily of carbon with varying amounts of hydrogen, oxygen, and impurities, such as sulphur, ash, and moisture. Thus, the aim of gasification is the almost complete transformation of these constituents into gaseous form so that only the ashes and inert materials remain.

In a sense, gasification is a form of incomplete combustion; heat from the burning solid fuel creates gases which are unable to burn completely, due to insufficient amounts of

oxygen from the available supply of air. In the matchstick example above, as the wood was burned and pyrolyzed into charcoal, wood gas was created, but the gas was also consumed by combustion (since there was an enormous supply of air in the room). In creating wood gas for fueling internal combustion engines, it is important that the gas not only be properly produced, but also preserved and not consumed until it is introduced into the engine where it may be appropriately burned.

Gasification is a physiochemical process in which chemical transformations occur along with the conversion of energy. The chemical reactions and thermochemical conversions which occur inside a wood gas generator are too long and too complicated to be covered here. Such knowledge is not necessary for constructing and operating a wood gasifier. Books with such information are listed in the Reference Section (see, for example, Reed 1979, Vol. II; or Reed and Das 1988).

### 1.3 BACKGROUND INFORMATION

The use of wood to provide heat is as old as mankind; but by burning the wood we only utilize about one-third of its energy. Two-thirds is lost into the environment with the smoke. Gasification is a method of collecting the smoke and its combustible components. Making a combustible gas from coal and wood began around 1790 in Europe. Such manufactured gas was used for street lights and was piped into houses for heating, lighting, and cooking. Factories used it for steam boilers, and farmers operated their machinery on wood gas and coal gas. After the discovery of large petroleum reserves in Pennsylvania in 1859, the entire world changed to oil—a cheaper and more convenient fuel. Thousands of gas works all over the world were eventually dismantled.

Wood gas generators are not technological marvels that can totally eliminate our current dependence on oil, reduce the impacts of an energy crunch, or produce long-term economic relief from high fossil fuel prices, but they are a proven emergency solution when such fuels become unobtainable in case of war, civil upheaval, or natural disaster. In fact, many people can recall a widespread use of wood gas generators during World War II, when petroleum products were not available for the civilian populations in many countries. Naturally, the people most affected by oil and petroleum scarcity made the greatest advancements in wood gas generator technology.

In occupied Denmark during World War II, 95% of all mobile farm machinery, tractors, trucks, stationary engines, fishing and ferry boats were powered by wood gas generators. Even in neutral Sweden, 40% of all motor traffic operated on gas derived from wood or charcoal (Reed and Jantzen 1979). All over Europe, Asia, and Australia, millions of gas generators were in operation between 1940 and 1946. Because of the wood gasifier's somewhat low efficiency, the inconvenience of operation, and the potential health risks from toxic fumes, most of such units were abandoned when oil again became available in 1945. Except for the technology of producing alternate fuels, such as methane or alcohol, the only solution for operating existing internal combustion engines, when oil and petroleum products are not available, has been these simple, inexpensive gasifier units.

### 1.3.1 The World War II, Imbert Gasifier

The basic operation of two gasifiers is described in this and the following section. Their operating advantages and disadvantages will also be discussed. This information is included for the technically interested reader only; it is intended to give the reader more insight into the subtleties of the operating principles of the wood gas generator described in this manual. Those readers who are anxious to begin construction of their own wood gas generator may skip the material below and proceed directly to Sect. 2 without any loss of continuity.

The constricted hearth, downdraft gasifier shown in Fig. 1-2 is sometimes called the "Imbert" gasifier after its inventor, Jacques Imbert; although, it has been commercially manufactured under various names. Such units were mass produced during World War II by many European automotive companies, including General Motors, Ford, and Mercedes-Benz. These units cost about \$1500 (1985 evaluation) each. However, after World War II began in 1939, it took six to eight months before factory-made gasifiers were generally available. Thousands of Europeans were saved from certain starvation by home-built, simple gasifier units made from washing machine tubs, old water heaters, and metal gas or oxygen cylinders. Surprisingly, the operation of these units was nearly as efficient as the factory-made units; however, the homemade units lasted for only about 20,000 miles with many repairs, while the factory-made units operated, with few repairs, up to 100,000 miles.

In Fig. 1-2, the upper cylindrical portion of the gasifier unit is simply a storage bin or hopper for wood chips or other biomass fuel. During operation, this chamber is filled every few hours as needed. The spring-loaded, airtight cover must be opened to refill the fuel hopper; it must remain closed and sealed during gasifier operation. The spring permits the cover to function as a safety valve because it will pop open in case of any excessive internal gas pressure.

About one-third of the way up from the bottom of the gasifier unit, there is a set of radially directed air nozzles; these allow air to be injected into the wood as it moves downward to be gasified. In a gas generator for vehicle use, the downstroke of the engine's pistons creates the suction force which moves the air into and through the gasifier unit; during startup of the gasifier, a blower is used to create the proper airflow. The gas is introduced into the engine and consumed a few seconds after it is made. This gasification method is called "producer gas generation," because no storage system is used; only that amount of gas demanded by the engine is produced. When the engine is shut off, the production of gas stops.

During normal operation, the incoming air burns and pyrolyzes some of the wood, most of the tars and oils, and some of the charcoal that fills the constricted area below the nozzles. Most of the fuel mass is converted to gas within this combustion zone. The Imbert gasifier is, in many ways, self-adjusting. If there is insufficient charcoal at the air nozzles, more wood is burned and pyrolyzed to make more charcoal. If too much charcoal forms, then the charcoal level rises above the nozzles, and the incoming air burns the charcoal. Thus, the combustion zone is maintained very close to the nozzles.

Below this combustion zone, the resulting hot combustion gases—carbon dioxide ( $\text{CO}_2$ ) and water vapor ( $\text{H}_2\text{O}$ )—pass into the hot charcoal where they are chemically reduced to combustible fuel gases: carbon monoxide ( $\text{CO}$ ) and hydrogen ( $\text{H}_2$ ). The hearth constriction causes all gases to pass through the reaction zone, thus giving maximum mixing and minimum heat loss. The highest temperatures are reached in this region.

Fine char and ash dust can eventually clog the charcoal bed and will reduce the gas flow unless the dust is removed. The charcoal is supported by a movable grate which can be

shaken at intervals. Ash buildup below the grate can be removed during cleaning operations. Usually, wood contains less than 1% ash (by weight). However, as the charcoal is consumed, it eventually collapses to form a powdery charcoal/ash mixture which may represent 2 to 10% (by weight) of the total fuel mass.

The cooling unit required for the Imbert gasifier consists of a water-filled precipitating tank and an automotive radiator-type gas cooler. The precipitating tank removes all unacceptable tars and most of the fine ash from the gas flow, while the radiator further cools the gas. A second filter unit, containing a fine-mesh filtration material, is used to remove the last traces of any ash or dust that may have survived passage through the cooling unit. Once out of the filter unit, the wood gas is mixed with air in the vehicle's carburetor and is then introduced directly into the engine's intake manifold.

The World War II, Imbert gasifier requires wood with a low moisture content (less than 20% by weight) and a uniform, blocky fuel in order to allow easy gravity feed through the constricted hearth. Twigs, sticks, and bark shreds cannot be used. The constriction at the hearth and the protruding air nozzles present obstructions to the passage of the fuel and may create bridging and channeling followed by poor quality gas output, as unpyrolyzed fuel falls into the reaction zone. The vehicle units of the World War II era had ample vibration to jar the carefully sized wood blocks through the gasifier. In fact, an entire industry emerged for preparing wood for use in vehicles at that time (Reed and Jantzen 1979). However, the constricted hearth design seriously limits the range of wood fuel shapes that can be successfully gasified without expensive cubing or pelletizing pretreatment. It is this limitation that makes the Imbert gasifier less flexible for emergency use.

In summary, the World War II Imbert gasifier design has stood the test of time and has successfully been mass produced. It is relatively inexpensive, uses simple construction materials, is easy to fabricate, and can be operated by motorists with a minimum amount of training.

### 1.3.2 The Stratified, Downdraft Gasifier

Until the early 1980s, wood gasifiers all over the world (including the World War II designs) operated on the principle that both the fuel hopper and the combustion unit be airtight; the hopper was sealed with a top or lid that had to be opened every time wood was added. Smoke and gas vented into the atmosphere while new wood was being loaded; the operator had to be careful not to breathe the unpleasant smoke and toxic fumes.

Over the last few years, a new gasifier design has been developed through cooperative efforts among researchers at the Solar Energy Research Institute in Colorado, the University of California in Davis, the Open University in London, the Buck Rogers Company in Kansas, and the Biomass Energy Foundation, Inc., in Florida (Reed and Das 1988). This simplified design employs a balanced, negative-pressure concept in which the old type of sealed fuel hopper is no longer necessary. A closure is only used to preserve the fuel when the engine is stopped. This new technology has several popular names, including "stratified, downdraft gasification" and "open top gasification." Two years of laboratory and field testing have indicated that such simple, inexpensive gasifiers can be built from existing hardware and will perform very well as emergency units.

A schematic diagram of the stratified, downdraft gasifier is shown in Fig. 1-3. During operation of this gasifier, air passes uniformly downward through four zones, hence the name "stratified:"

1. The uppermost zone contains unreacted fuel through which air and oxygen enter. This region serves the same function as the fuel hopper in the Imbert design.
2. In the second zone, the wood fuel reacts with oxygen during pyrolysis. Most of the volatile components of the fuel are burned in this zone and provide heat for continued pyrolysis reactions. At the bottom of this zone, all of the available oxygen from the air has completely reacted. The open top design ensures uniform access of air to the pyrolysis region.
3. The third zone is made up of charcoal from the second zone. Hot combustion gases from the pyrolysis region react with the charcoal to convert the carbon dioxide and water vapor into carbon monoxide and hydrogen.
4. The inert char and ash, which constitute the fourth zone, are normally too cool to cause further reactions; however, since the fourth zone is available to absorb heat or oxygen as conditions change, it serves both as a buffer and as a charcoal storage region. Below this zone is the grate. The presence of char and ash serves to protect the grate from excessive temperatures.

The stratified, downdraft design has a number of advantages over the World War II, Imbert gasifier. The open top permits fuel to be fed more easily and allows easy access. The cylindrical shape is easy to fabricate and permits continuous flow of fuel. No special fuel shape or pretreatment is necessary; any blocky fuel can be used.

The foremost question about the operation of the stratified, downdraft gasifier concerns char and ash removal. As the charcoal reacts with the combustion gases, it eventually reaches a very low density and breaks up into a dust containing all of the ash as well as a percentage of the original carbon. This dust may be partially carried away by the gas; however, it might eventually begin to plug the gasifier, and so it must be removed by shaking or agitation. Both the Imbert gasifiers and the stratified concept have a provision for shaking the grate; when they are used to power vehicles, they are automatically shaken by the vehicle's motion.

An important issue in the design of the stratified, downdraft gasifier is the prevention of fuel bridging and channeling. High-grade biomass fuels such as wood blocks or chips will flow down through the gasifier under the influence of gravity, and downdraft air flow. However, other fuels (such as shredded wood, sawdust, and bark) can form a bridge that will prevent continuous flow and cause very high temperatures. Obviously, it is desirable to use these widely available biomass residues. Bridging can be prevented by stirring, shaking, or by agitating the grate or by having it agitated by the vehicle's movement. For prolonged idling, a hand-operated shaker has been included in the design.

A prototype design of the stratified, downdraft gasifier design has been developed. The detailed but simple design is described and illustrated in Sect. 2; however, it has not been widely tested at this time. The reader is urged to use his ingenuity and initiative in constructing his own wood gas generator. As long as the principle of airtightness in the combustion regions, in the connecting piping, and in the filter units is followed, the form, shape, and method of assembly is not important.

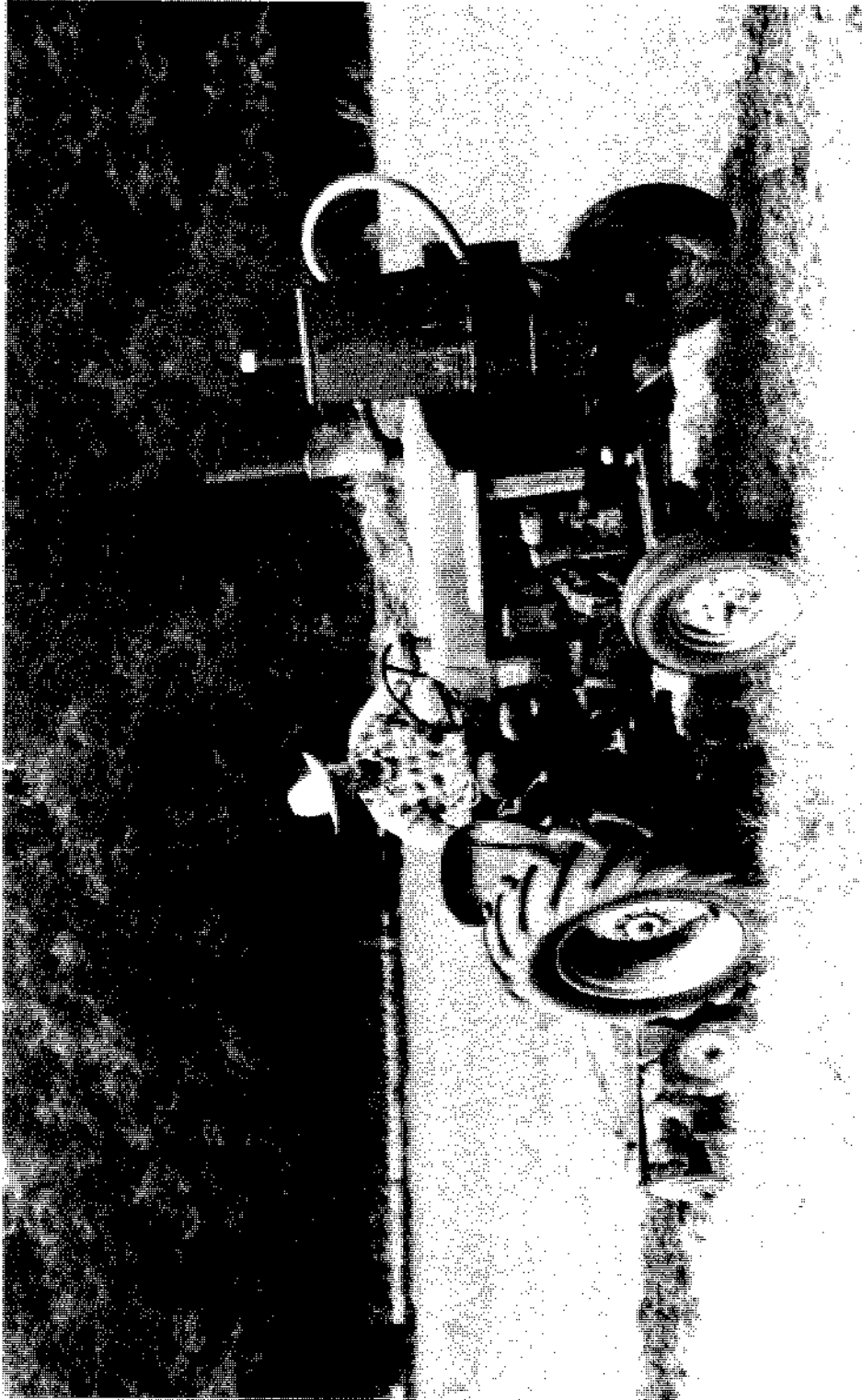


Fig. 1-1. Wood gas generator unit in operation during field testing.

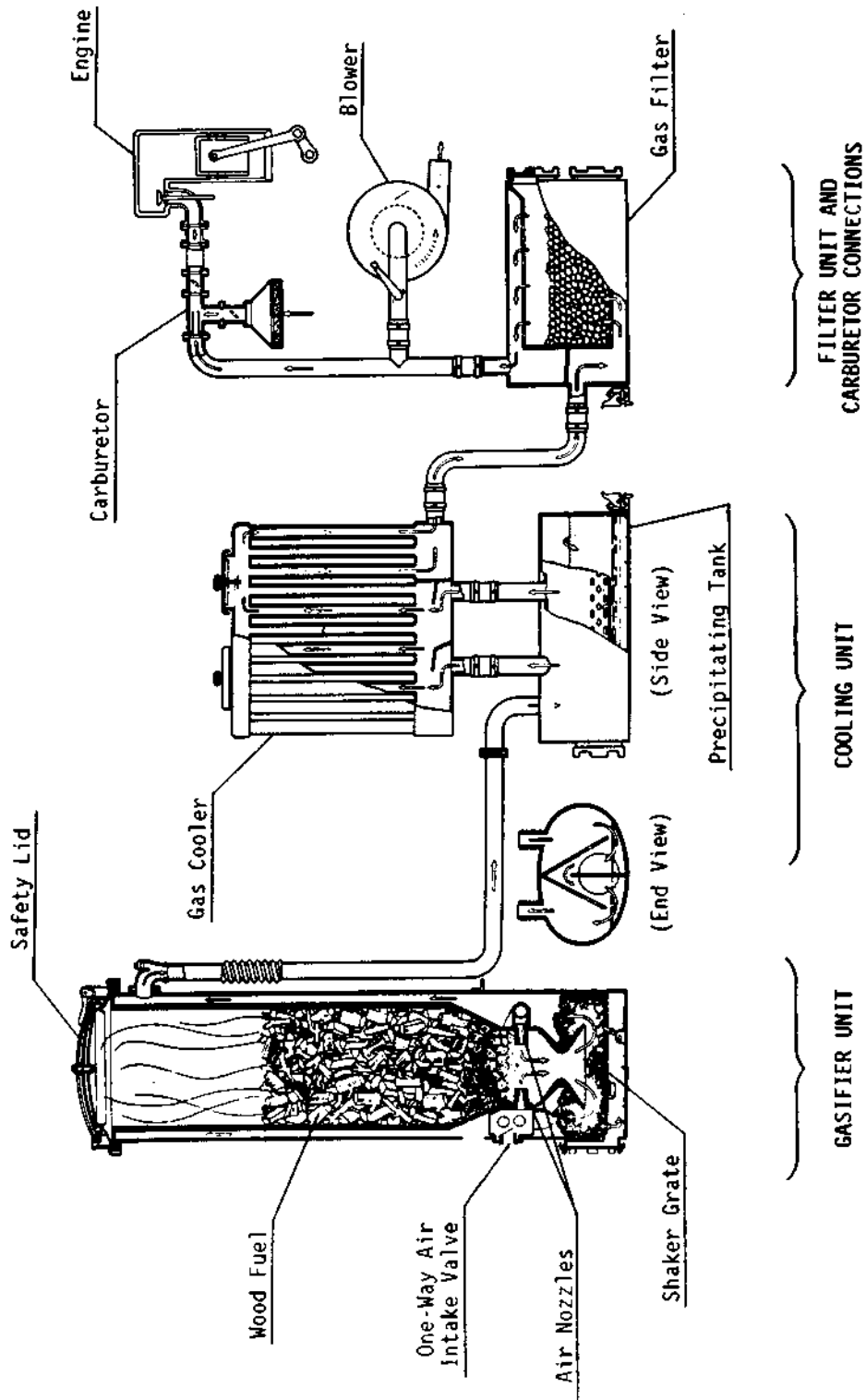


Fig. 1-2. Schematic view of the World War II, Imbert gasifier.



ORNL - DWG 87 - 14553

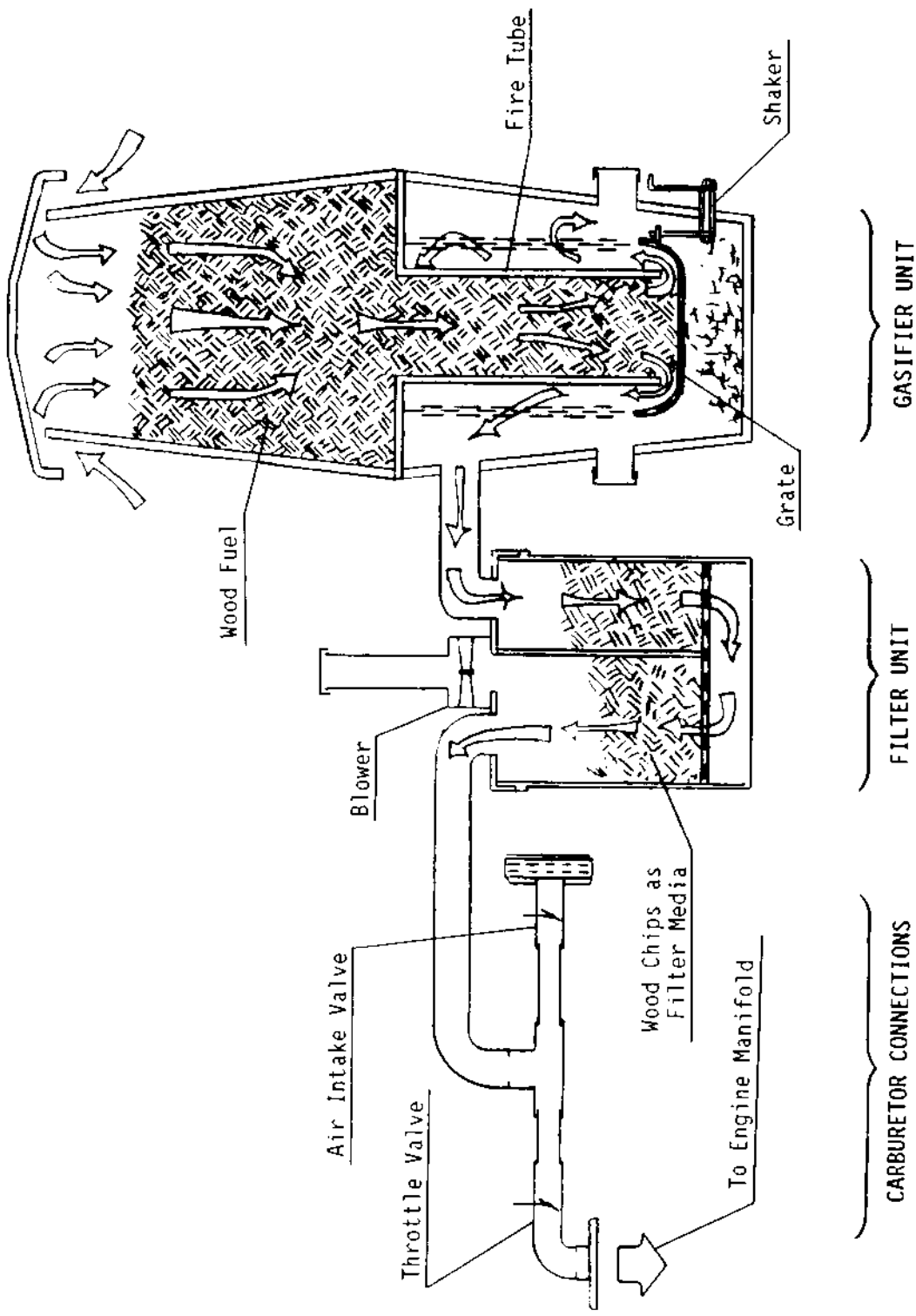


Fig 1-3. Schematic view of the stratified, downdraft gasifier.



## 2. BUILDING YOUR OWN WOOD GAS GENERATOR

The following fabrication instructions, parts lists, and illustrations describe the prototype gasifier unit shown schematically in Fig. 1-3. These instructions are simple and easy to follow. The dimensions in the following plans are given in inches rather than in millimeters to make construction easier for those who might be unfamiliar with the metric system and to allow the builder to take advantage of available, alternate construction materials. It will be obvious to the experienced engineer, mechanic, or builder that most of the dimensions (for example, plate thicknesses and cleanout diameters) are not critical to the acceptable performance of the finished gasifier unit.

The prototype gasifier unit described in the following text was actually constructed and field tested on a gasoline-engine farm tractor (a 35-hp, John Deere 1010 Special); see Fig. 2-1. The unit operated very well, and on par with the European, World War II designs, but it has not had the test of time nor the millions of operating hours like the older Imbert design. This new stratified design was developed for the construction of simple, inexpensive emergency wood gas generator units. The prototype design below should be considered to be the absolute minimum in regard to materials, piping and filter arrangement, and carburetor system connections.

The gasifier unit, as described below, is designed to maintain proper cooling, even at moderate vehicle speeds. If this unit is to be used on stationary engines or on slow-moving vehicles, a gas cooler and a secondary filter must be placed in the piping system between the generator unit and the carburetor. The ideal temperature for the wood gas at the inlet to the carburetor manifold would be 70°F, with acceptable peaks of 140 to 160°F. For every 10 degrees above 70°F, an estimated 1% horsepower is lost. Cooler gas has higher density and, therefore, contains more combustible components per unit volume.

The millions of wood gasifiers built during World War II proved that shape, form, and construction material had little or no effect on the performance of the unit. Judicious substitution or the use of scavenged parts is, therefore, quite acceptable. What is important is that:

1. the fire tube dimensions (inside diameter and length) must be correctly selected to match the rated horsepower of particular engine which is to be fueled,
2. airtightness of the gas generator unit and all connecting piping must be maintained at all times, and
3. unnecessary friction should be eliminated in all of the air and gas passages by avoiding sharp bends in the piping and by using piping sizes which are not too small.

## 2.1. BUILDING THE GAS GENERATOR UNIT AND THE FUEL HOPPER

Figure 2-2 shows an exploded view of the gas generator unit and the fuel hopper; the list of materials is given in Table 2-1 (all figures and tables mentioned in Sect. 2 are presented at the end of Sect. 2). Only the dimensions of the fire tube (Item 1A) must be reasonably close; all other dimensions and materials can be substituted as long as complete airtightness is maintained. In the following instructions, all item numbers refer both to Fig. 2-2 and to Table 2-1.

The prototype unit described in this report was constructed for use with a 35-hp gasoline engine; the unit has a fire tube diameter of 6 in. (as determined from Table 2-2). A gas generator unit containing a fire tube up to 9-in. diameter (i.e., a gasifier unit for fueling engines up to about 65 hp) can be constructed from the following instructions. If your engine requires a fire tube diameter of 10 in. or more, use a 55-gal drum for the gas unit and another 55-gal drum for the fuel hopper.

The following fabrication procedure is very general and can be applied to the construction of gas generator units of any size; however, the specific dimensions which are given in the parts list and in the instructions below are for this particular prototype unit. All accompanying photographs were taken during the actual assembly of the prototype unit.

The fabrication procedure is as follows:

1. Using the displacement or horsepower rating of the engine to be fueled by the gasifier unit, determine the dimensions (inside diameter and length) of the fire tube (Item 1A) from Table 2-2. Fabricate a cylindrical tube or cut a length of correctly sized pipe to match the dimensions from Table 2-2. (For the prototype gasifier unit illustrated in this report, a 6-in.-diam firetube was used; its length was 19 in.)
2. The circular top plate (Item 2A) should be cut to a diameter equal to the outside diameter of the gasifier housing drum (Item 3A) at its top. A circular hole should then be cut in the center of the top plate; the diameter of this hole must be equal to the outside diameter of the fire tube. The fire tube (Item 1A) should then be welded at a right angle to the top plate (Item 2A) as shown in Fig. 2-3.
3. The grate (Item 4A) should be made from a stainless steel mixing bowl or colander. Approximately 125 holes with diameters of 1/2 in. should be drilled in the bottom and up the sides of the mixing bowl; see Fig. 2-4. A U-bolt (Item 5A) should be welded horizontally to the side of the grate, 2 in. from its bottom. This U-bolt will be interlocked with the shaker mechanism (Item 12A) in a later step.
4. The support chains (Item 6A) are to be attached to the grate in three evenly spaced holes drilled under the lip of the mixing bowl or colander; see Fig. 2-5. These chains are to be connected to the top plate (Item 2A) with eyebolts (Item 7A), as shown in Fig. 2-6. Each eyebolt should have two nuts, one on each side of the top plate, so that the eyebolts can be adjusted to the proper length. When assembled, the bottom of the firetube should be 1.25 in. above the bottom of the mixing bowl.
5. A hole equal to the outside diameter of the ash cleanout port (Item 8A) should be cut into the side of the gasifier housing drum (Item 3A); the bottom edge of this hole

should be about 1/2 in. from the bottom of the drum. Because of the thin wall thickness of oil drums and garbage cans, welding is not recommended; brazing such parts to the drums or cans will ensure both strength and airtightness (see Fig. 2-7).

6. Two holes, equal to the outside diameters of the ignition ports (Item 10A), are to be cut with their centers at a distance from the top of the housing drum (Item 3A) equal to the firetube length less 7 in. (19 in. less 7 in. equals 12 in. for this prototype unit); the holes should be placed opposite each other as shown in Fig. 2-2. The ignition ports should be attached to the wall of the housing drum by brazing.
7. When the ash cleanout port (Item 8A) and the ignition ports (Item 10A) have been attached to the wall of the gasifier housing drum (Item 3A), they should then be closed with pipe caps, Items 9A and 11A respectively. The threads of the pipe caps should be first coated with high temperature silicone (Item 27A) to ensure airtightness. An optional steel crossbar welded to the pipe cap will reduce the effort required to open these caps later.
8. The shaker assembly (Item 12A) is shown in Fig. 2-8. The 1/2-in. pipe (Item 1AA) should be brazed into the side of the housing drum (Item 3A), 1.5 inches from the bottom of the drum; the length of this pipe which protrudes into the drum must be chosen so that the upright bar (Item 2AA) is in line with the U-bolt (Item 5A) on the grate. Likewise, the length of the upright bar must be selected so as to connect into the U-bolt.
9. Weld the upright bar (Item 2AA) to the head of the bolt (Item 3AA). The threaded end of the bolt should be ground down or flattened on one side, as shown in Fig. 2-9, to positively interlock with a slot to be drilled and filed in the handle (Item 4AA). The handle can be formed or bent into any desired or convenient shape.
10. A hole should be drilled in the pipe cap (Item 7AA) so that there is a close fit between this hole and the bolt (Item 3AA). The close fit will help to ensure airtightness.
11. Before assembling the shaker, as shown in Fig. 2-8, coat the bolt (Item 3AA) with a small amount of grease. Before inserting the bolt, fill the pipe (Item 1AA) with high temperature silicone (Item 27A) to ensure airtightness. Tighten the nuts (Item 6AA) so that the position of the handle (Item 4AA) is maintained by friction, yet is capable of being turned and agitated during cleanout or stationary operation.
12. Fabricate the supports (Item 13A) for the gasifier unit housing drum (Item 3A) out of rectangular, iron bar stock. The shape and height of the support flanges must be determined by the frame of the vehicle to which the gasifier is to be mounted. The supports can either be bolted to the bottom and side with the 1/4-in. bolts (Item 14A) or can be brazed directly to the drum; see Fig. 2-10. Remember to seal all bolt holes for airtightness.
13. Completely cover the bottom of the housing drum (Item 3A) with 1/2 in. of hydraulic cement (Item 28A). The cement should also be applied to the inside of the drum for

about 5 in. up the inside walls near the bottom. All edges should be rounded for easy ash removal.

14. The fuel hopper (Item 15A) is to be made from a second container with its bottom up as shown in Fig. 2-11. Remove the bottom, leaving a 1/4-in. lip around the circumference.
15. A garden hose (Item 17A) should be cut to a length equal to the circumference of the fuel hopper (Item 15A) and should then be slit along its entire length. It should be placed over the edge of the fuel hopper from which the bottom was removed. This will prevent injury to the operator when adding wood fuel to the unit. To insure close fit of the garbage can lid (Item 16A), a piece of weather stripping (Item 18A) should be attached under the lid where it makes contact with the fuel hopper.
16. Cut four support bars (Item 19A) to lengths 2.5 in. longer than the height of the fuel hopper (Item 15A). Drill a 3/8-in. hole in each end of all four support bars; these holes should be centered 3/4 in. from the ends. Bend 2 in. of each end of these support bars over at a right angle; then, mount them evenly spaced around the fuel hopper (Item 15A) with 1/4-in. bolts (Item 20A). One of the bends on each support bar should be as close to the lower edge of the fuel hopper as possible.
17. Cut four metal triangular standoffs (Item 21A) and braze, weld, or rivet them flat against the edge of the garbage can lid (Item 16A) as shown in Fig. 2-12; they must be aligned with the four support bars (Item 19A) attached to the fuel hopper. During operation, the garbage can lid must have a minimum 3/4-in. opening for air passage; the standoffs should provide this clearance when they are engaged into the holes in the top edges of the support bars (Item 19A); see Fig. 2-13.
18. Two eye hooks (Item 22A) should be attached to opposite sides of the garbage can lid (Item 16A). Two screen door springs (Item 23A) should be attached to the garbage can handles and used under tension to keep the top lid (Item 16A) either open or closed.
19. Cut the oil drum lock ring (Item 24A) to the exact circumference of the top plate (Item 2A) so that it will fit snugly around the gasifier unit housing drum (Item 3A).
20. Cut four 2 by 2 by 1/4-in. tabs (Item 25A); then, braze these tabs to the lock ring (Item 24A), evenly spaced and in alignment with the support bars (Item 19A) on the fuel hopper. Drill a 3/8-in. hole in each tab to align with the holes in the fuel hopper support bars (Item 19A). The lock ring is shown in Fig. 2-14.
21. The connecting pipe (Item 29A) between the gasifier unit and the filter unit should be attached to the gasifier housing drum (Item 3A) at a point 6 in. below the top of the drum. This pipe must be a minimum of 2-in. in diameter and should be at least 6 ft long for cooling purposes. At least one of the ends of this pipe must be removable for cleaning and maintenance. On this prototype unit, an airtight electrical conduit connector was used; this connection is visible in Fig. 2-1. Many similar plumbing devices

are available and can be used if they are suitable for operation at 400° F and above. The pipe can also be welded or brazed directly to the housing drum.

22. When assembling the gasifier unit, the upright bar (Item 2AA) on the shaker assembly must be placed inside the U-bolt (Item 5A) on the grate.
23. The lock ring will then clamp the gasifier unit housing drum (Item 3A) and the top plate (Item 2A) together. The fuel hopper support bars (Item 19A) must be attached to the tabs (Item 25A) on the lock ring with bolts (Item 26A). High temperature silicone (Item 27A) should be applied to all edges to make an airtight connection. The lock ring connections are shown in the lower portion of Fig. 2-13.

## 2.2 BUILDING THE PRIMARY FILTER UNIT

Figures 2-15 and 2-16 show exploded views of the primary filter unit; the list of materials is given in Table 2-3 (all figures and tables mentioned in Sect. 2 are presented at the end of Sect. 2). In the following instructions, all item numbers refer to either Fig. 2-15 or 2-16 and to Table 2-3.

The prototype primary filter unit was made from a 5-gal paint can. That size seems to be sufficient for gasifiers with fire tubes up to 10 in. in diameter. If a fire tube diameter of more than 10 in. is required, then a 20-gal garbage can or a 30-gal oil drum should be used. The filter unit could be fabricated in any shape or form as long as airtightness and unobstructed flow of gas are provided. If a 5-gal container is used, it must be clean and free of any chemical residue. The top edge must be straight and without any indentations. If an alternate container can be found or fabricated, a larger diameter will permit longer operation between cleanings.

The piping (Item 29A in Figs. 2-2 and 2-15) which connects the gas generator unit to the primary filter should be considered to be a necessary part of the cooling system and should never have an inside diameter less than 2 in. A flexible automotive exhaust pipe was used on the prototype filter unit described below; it was shaped into a semicircular arc so that increased length would achieve a greater cooling effect.

The fabrication procedure for the filter unit follows:

1. A hole equal to the outside diameter of the drain tube (Item 13B in Fig. 2-15) should be cut into the side of the filter container (Item 1B); the bottom edge of this hole should be about 1/2 in. from the inside bottom of the container.
2. The drain tube (Item 13B) should be inserted into the previously cut hole in the filter container and should be positioned so that its nonthreaded end is near the center of the container and is about 1/2 in. off the bottom. Once this position has been ensured, braze (do not weld) the drain pipe into the side of the filter container. Close the threaded, exterior end of the drain pipe with the pipe cap (Item 14B).
3. Coat the bottom of the filter container (Item 1B) with a 1/2-in. layer of hydraulic cement (Item 28A), taking care not to plug or obstruct the end of the drain tube (Item 13B) with cement (i.e., fill the drain tube with a paper, styrofoam, or other easily removable, but rigid material). The cement should also be applied for about 1.5 in. up

the inside walls of the container near its bottom. Round the edges slightly; the cement is to provide a pathway for any liquid condensate to drain out through the drain tube. The cement must be allowed to harden before proceeding with the fabrication steps below. Remove the filler material from the drain tube when the cement has hardened.

4. A circular bottom plate (Item 2B) should be cut to a diameter 1/2 in. smaller than the inside diameter of the filter container (Item 1B). This will allow for heat expansion and easy removal for cleaning. This bottom plate should be drilled with as many 3/4-in. holes as are practical for the size of the plate. Three evenly spaced 3/8-in. holes should also be drilled around the edge of the bottom plate for the spacer bolts (Item 3B).
5. Fig. 2-16 shows the detail of using three bolts (Item 3B) as spacers for the bottom plate (Item 2B). The length of the bolts should be adjusted to provide a clearance of about 2-in. between the layer of cement in the bottom of the container (Item 1B) and the bottom plate (Item 2B).
6. A rectangular divider plate (Item 4B) should be cut to a width 1/4 in. less than the inside diameter of the filter container (Item 1B) and to a height 2.5 in. less than the inside height of the container. This divider plate should then be welded at a right angle to the centerline of the bottom plate (Item 2B) as shown in Fig. 2-17.
7. Cut a piece of high-temperature hydraulic hose (Item 5B) to a length equal to the circumference of the filter container. It should be slit along its entire length and then placed over the top edge of the filter container (Item 1B) to ensure airtightness.
8. A circular lid (Item 6B) should be cut equal to the outside diameter of the filter container (Item 1B). Three holes should be cut into this lid for the exhaust pipe (Item 29A) from the gasifier unit, the blower (Item 7B), and the filter exhaust pipe (Item 10B) to the engine manifold. Note the arrangement of these holes: the pipe (Item 29A) from the gasifier unit must enter the lid on one side of the divider plate (Item 4B); the blower (Item 7B) and the filter exhaust pipe (Item 10B) to the engine manifold must be located on the other side of the divider plate. This arrangement can be seen in Fig. 2-18.
9. The connecting pipe (Item 29A) between the gasifier unit and the filter unit should be attached to the lid (Item 6B) of the filter container. At least one of the ends of the connecting pipe (Item 29A) must be removable for cleaning and maintenance. On this prototype unit, an airtight electrical conduit connector was used. Many similar plumbing devices are available and can be used if they are suitable for operation at 400° F and above. The pipe can also be welded or brazed directly to the lid.
10. Attach the blower (Item 7B) to the filter container lid (Item 6B). On the prototype gasifier illustrated in this report, a heater blower from a Volkswagen automobile was used. Connections for a vertical extension tube (Item 8B) will have to be fabricated as shown in Fig. 2-19. A closing cap (Item 9B) is required for the blower exhaust tube. A plumbing cap of steel or plastic with a close fit can be used or fabricated to fit. The vertical extension and the closing cap are visible in Fig. 2-1.



11. The gas outlet (Item 10B) to the carbureting unit on the engine should be 1.25 in. minimum diameter. In fabricating this connection, all abrupt bends should be avoided to ensure free flow of gas. Using plumbing elbows is one solution. The gas outlet (Item 10B) can either be welded or brazed to the lid (Item 6B) of the filter container or an airtight, electrical conduit connector can be used.
12. Latching devices (Item 11B) should be welded or brazed to the lid (see Fig. 2-20) and to the sides (see Fig. 2-21) of the filter container. An air-tight connection between the lid and the filter container must be maintained.
13. Cut two lengths of high-temperature hydraulic hose (Item 12B) equal to the height of the divider plate (Item 4B); cut a third length of hose equal to the width of the divider plate. Slit each hose along its entire length. Place the first two hoses on each side of the divider plate, and place the third hose along the top edge of the divider plate as shown in Fig. 2-17.
14. Insert the divider plate (Item 4B) into the filter container (Item 1B), making sure that the hoses (Item 12B) create an airtight seal along all sides. By changing the length of the spacer bolts (Item 3B), adjust the height of the divider plate so that it is exactly flush with the top of the filter container. Make sure that the lid (Item 5B) will seat flatly and tightly against the top edge of the divider plate.
15. Fill the filter container (Item 1B) on both sides of the divider plate with wood chips, the same kind as would be used for fuel in the gasifier unit. After carefully packing and leveling these wood chips, place the lid (Item 6B) on the filter container, and close the latches tightly.

### 2.3. BUILDING THE CARBURETING UNIT WITH THE AIR AND THROTTLE CONTROLS

Figures 2-22 and 2-23 show exploded views of the carbureting unit; the list of materials is given in Table 2-4 (all figures and tables mentioned in Sect. 2 are presented at the end of Sect. 2). In the following instructions, all item numbers refer both to Figs. 2-22 and 2-23 and to Table 2-4. The following is a simple and easy way to assemble a carburetor to achieve both air mixture and throttle control. It can be mounted to either updraft or downdraft manifolds by simply turning the unit over. Most of the fabrication procedure below is devoted to the assembly of two butterfly valves: one for the throttle valve and one for the air mixture valve. The remainder of the carburetor unit can be assembled from ordinary, threaded plumbing parts.

The inside diameter of the piping used in the carburetor unit must be related to the size of the engine and should never be smaller than the intake opening on the engine manifold. If in doubt on the inside diameter for the pipe and/or hose sizes, always go with a larger diameter. This will reduce friction losses and will give longer operating hours between cleanings.

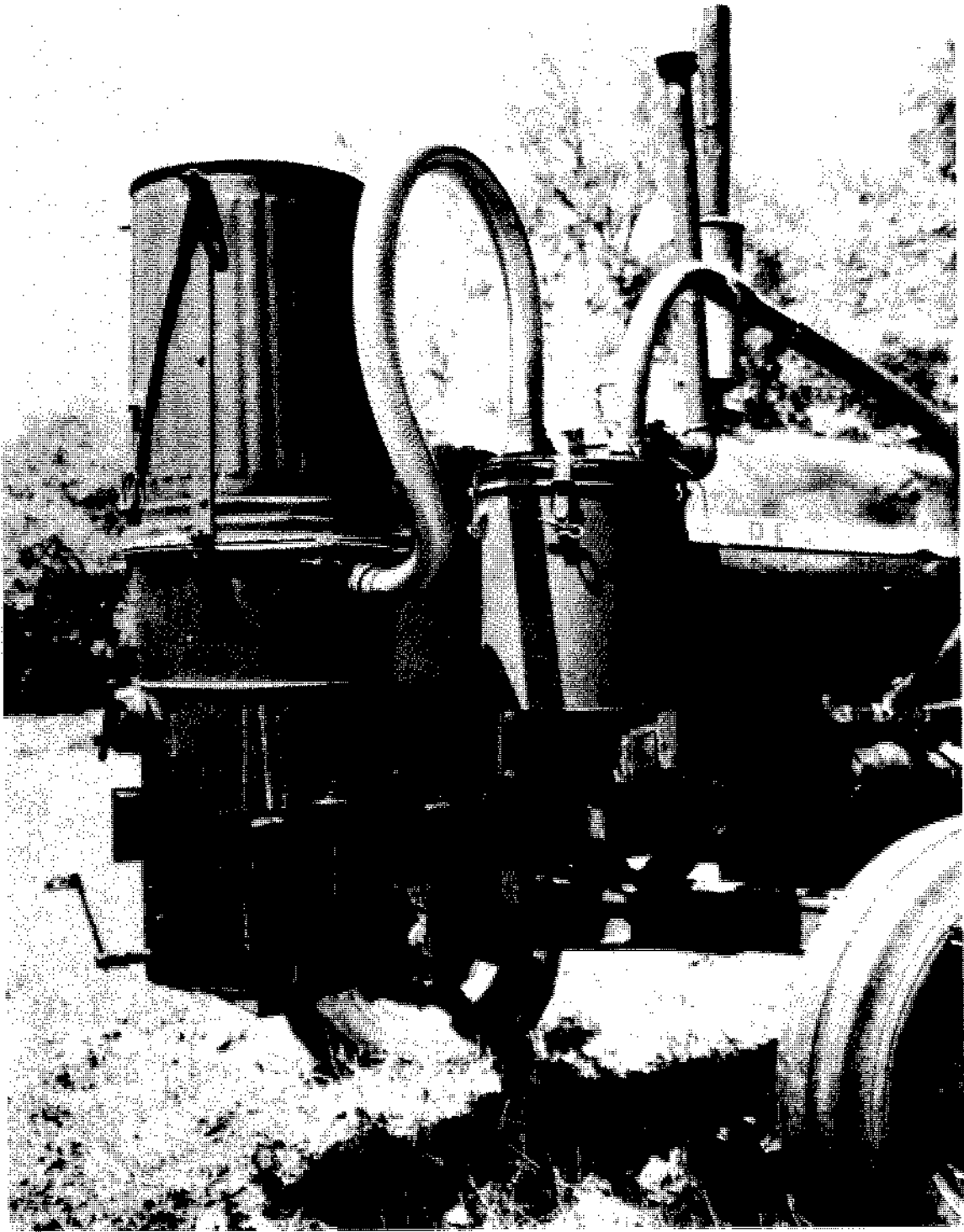
When the wood gas leaves the filter unit it should normally be below 180°F. About 2 ft from the filter container, an automotive water hose can be connected to the pipe on the carbureting unit. This rubber hose will keep engine vibration from creating air leaks in the

filter unit or in the connecting piping. The hose must be a fairly new item; such hoses have a steel spring inside to keep them from collapsing when negative pressure is applied. The spring will soon rust if it has first been subjected to water and then to the hot wood gas enriched with hydrogen.

The fabrication procedure for the assembly of two butterfly valves follows:

1. The manifold adapter (Item 1C in Fig. 2-22) must be fitted with bolts and/or holes for mounting onto the engine's existing intake manifold. Because gasoline engines are produced with so many different types of intake manifolds, ingenuity and common sense must be used to modify the manifold adapter (Item 1C) for each different engine to be operated on wood gas. A gasket (Item 7C) should be cut to match the shape of the engine intake fitting.
2. The butterfly valve (Item 3C) is shown in Figs. 2-24 and 2-25; two such valves are required. A 3/8-in. hole should be drilled through the diameter of each valve body (Item 1CC) at the midpoint of its length.
3. The valve plate (Item 2CC) must be oval in shape with the dimensions given in Table 2-4. An oval valve plate must be used so that, in the closed position, the valve will be about 10° off center. This will ensure that the valve will come to a complete stop in the closed position.
4. The edges of the valve plate (Item 2CC), around the longer diameter of the oval, should be beveled to provide a positive, airtight closure. Two evenly spaced, 1/4-in. holes should be drilled along the shorter diameter of the oval plate.
5. The valve support rod (Item 3CC) should be filed or ground flat on one side as shown in Fig. 2-24; the flat area must begin 1/4 in. from one end and must continue for a distance equal to the inside diameter of the valve body (Item 1CC).
6. Two 3/16-in. holes should be drilled into the flat area of the valve support rod (Item 3CC); these holes must align with the holes in the valve plate (Item 2CC). They must also be tapped (with threads) to accept the valve plate screws (Item 4CC).
7. The butterfly valve (Item 3C) should be assembled by first placing the valve support rod (Item 3CC) through the hole in the valve body (Item 1CC). The valve plate (Item 2CC) should be dropped into one end of the valve body and then inserted into the flat area of the valve support rod. The two screws (Item 4CC) should be used to attach the valve plate to the support rod. Check to see that the assembled valve plate rotates freely and seats completely in the closed position.
8. A nut (Item 6CC) should be welded flat against one side of the throttle arm (Item 5CC) near its end. A 1/8-in. hole should be drilled into the side of the nut and must be threaded to accept the set screw (Item 7CC). At least one hole should be drilled into the throttle arm for attachment of the engine throttle control or air control linkages.

9. Place the nut (Item 6CC) on the throttle arm over the end of the valve support rod (Item 3CC) and use the set screw (Item 7CC) to secure the assembly. The throttle arm can be placed in any convenient orientation. Assembled butterfly valves are shown in Fig. 2-26.
10. The remaining parts of the carburetor assembly should be screwed together as shown in Fig. 2-27. Pipe thread compound should be used to make airtight connections. The assembled carburetor unit should be attached to the engine's intake manifold as shown in Fig. 2-28
11. This prototype gasifier was designed to operate if gasoline were unavailable; but, if dual operation on wood and gasoline is desired, the elbow (Item 2C) could be replaced with a tee, allowing a gasoline carburetor to also be mounted.
12. The arm on the butterfly valve (Item 3C) which is closest to the elbow (Item 2C) is to be connected to the foot- (or, on tractors, hand-) operated accelerator. The other butterfly valve is to be used as the air mixture control valve and can be operated with a manual choke cable. If the engine has an automatic choking device, then a hand-operated choke cable should be installed. Both butterfly valves and their connecting control linkages must operate smoothly with the ability to adjust the valve yet keep it stationary in the selected position during operation. The linkages must close the valves airtight when the engine is off.
13. The air inlet (Item 6C) should be connected by an extension hose or pipe, either iron or plastic, to the existing engine's air filter in order to prevent road dust or agricultural residue from entering the engine.
14. The wood gas inlet (Item 5C) is to be connected to the outlet piping (Item 10B as shown in Fig. 2-15) from the wood gas filter unit. Part of this connection should be a high-temperature rubber or neoprene hose to absorb engine vibration.



**Fig. 2-1.** The prototype wood gas generator unit mounted onto a tractor.

ORNL-DWG 87-145

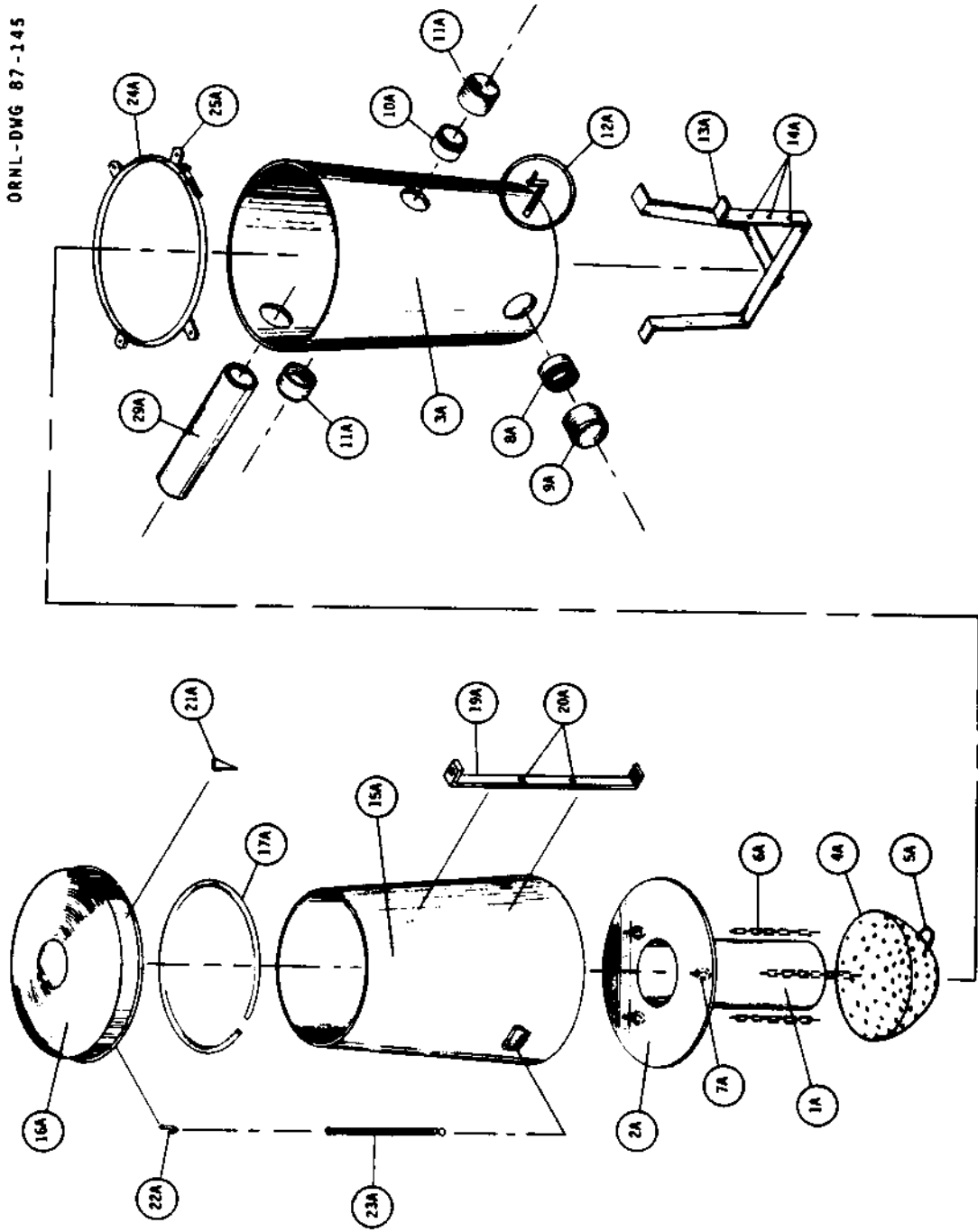
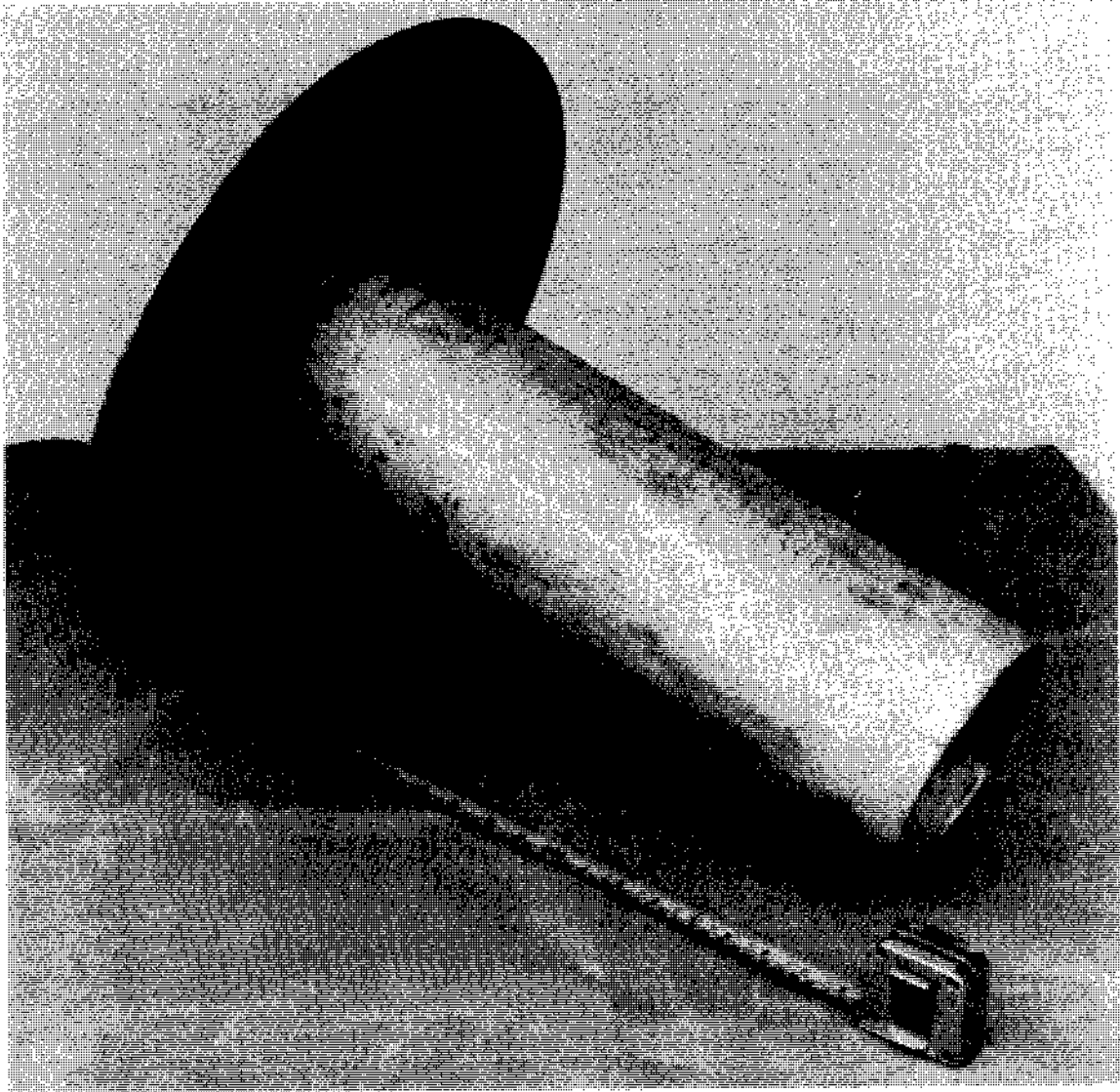


Fig. 2-2. Exploded, schematic diagram of the wood gas generator unit and the fuel hopper.



**Fig. 2-3. The fire tube and circular top plate of the gasifier unit.**



**Fig. 2-4. Drilling holes into the stainless steel mixing bowl to be used for the grate. Note the U-bolt in the foreground.**

ORNL-Photo 4473-87

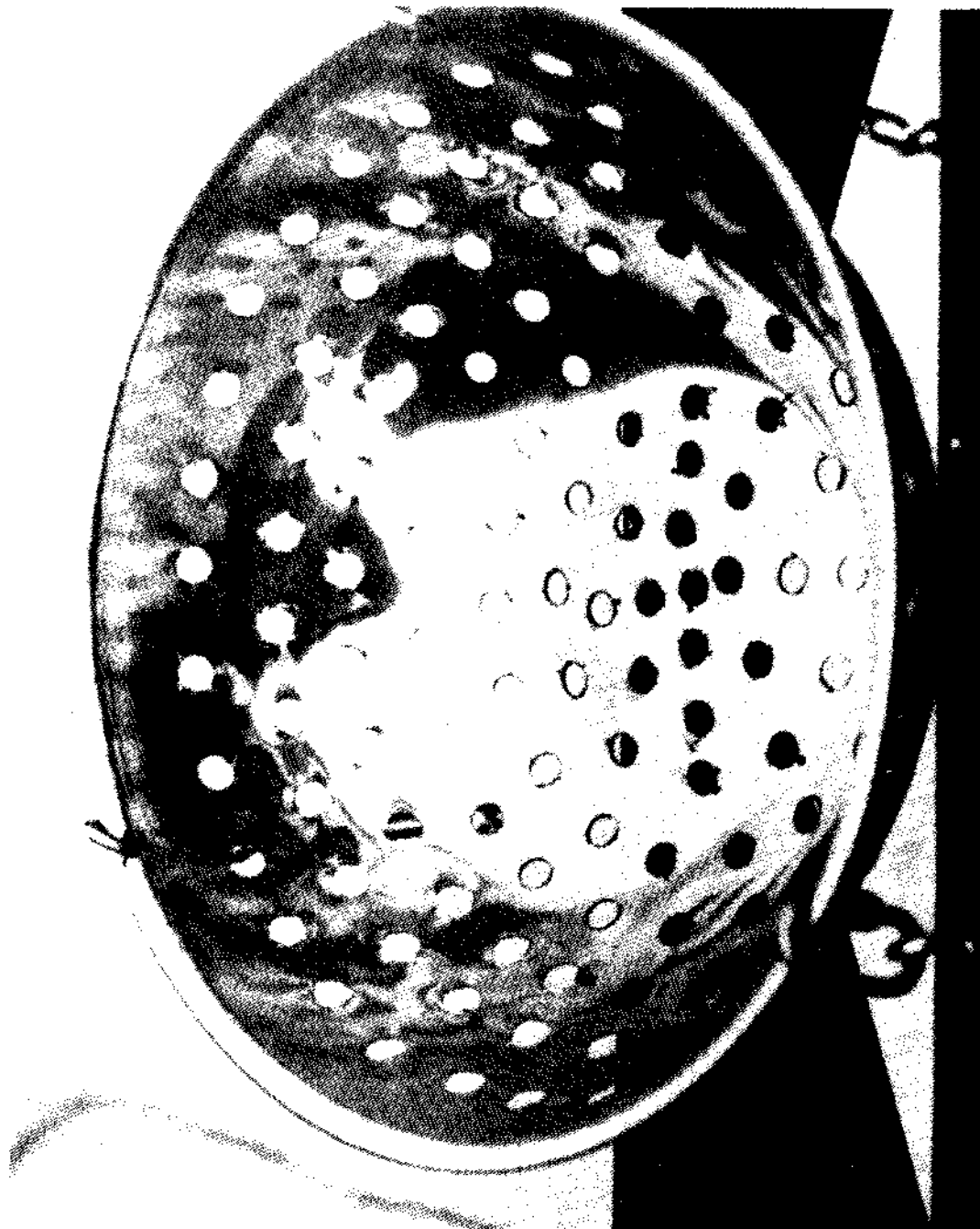


Fig. 2-5. Chains attached to the lip of the stainless steel mixing bowl.



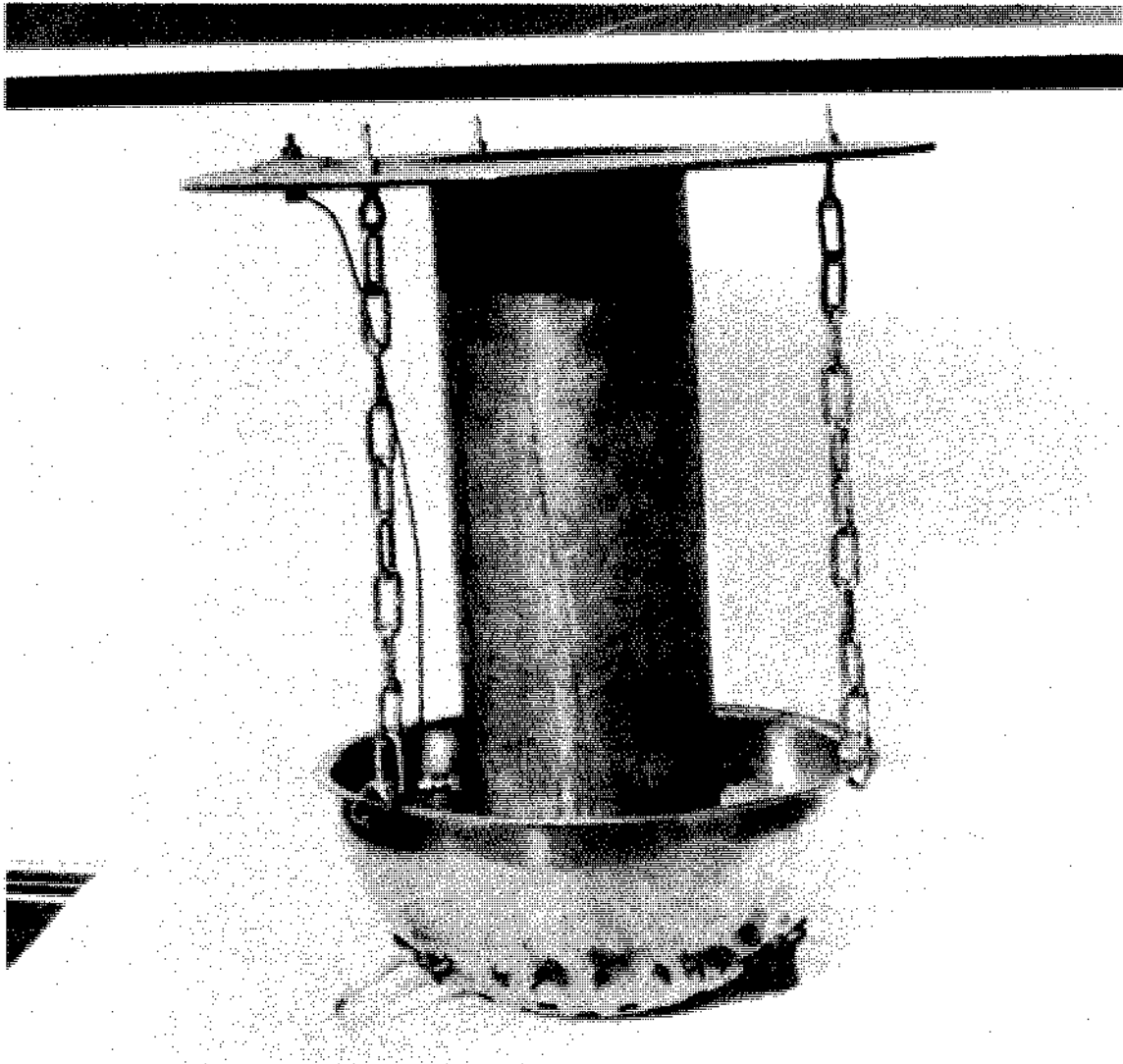


Fig. 2-6. Connect the mixing bowl to the top plate with chains. Note that the diesel ignitor "glow plugs" shown in this photograph were included for experimentation only; they were abandoned in the final prototype design.

ORNL - Photo 4529-87



Fig. 2-7. Braze, do not weld, the plumbing fittings to the thin walled drums.

ORNL-DWG 87-14555

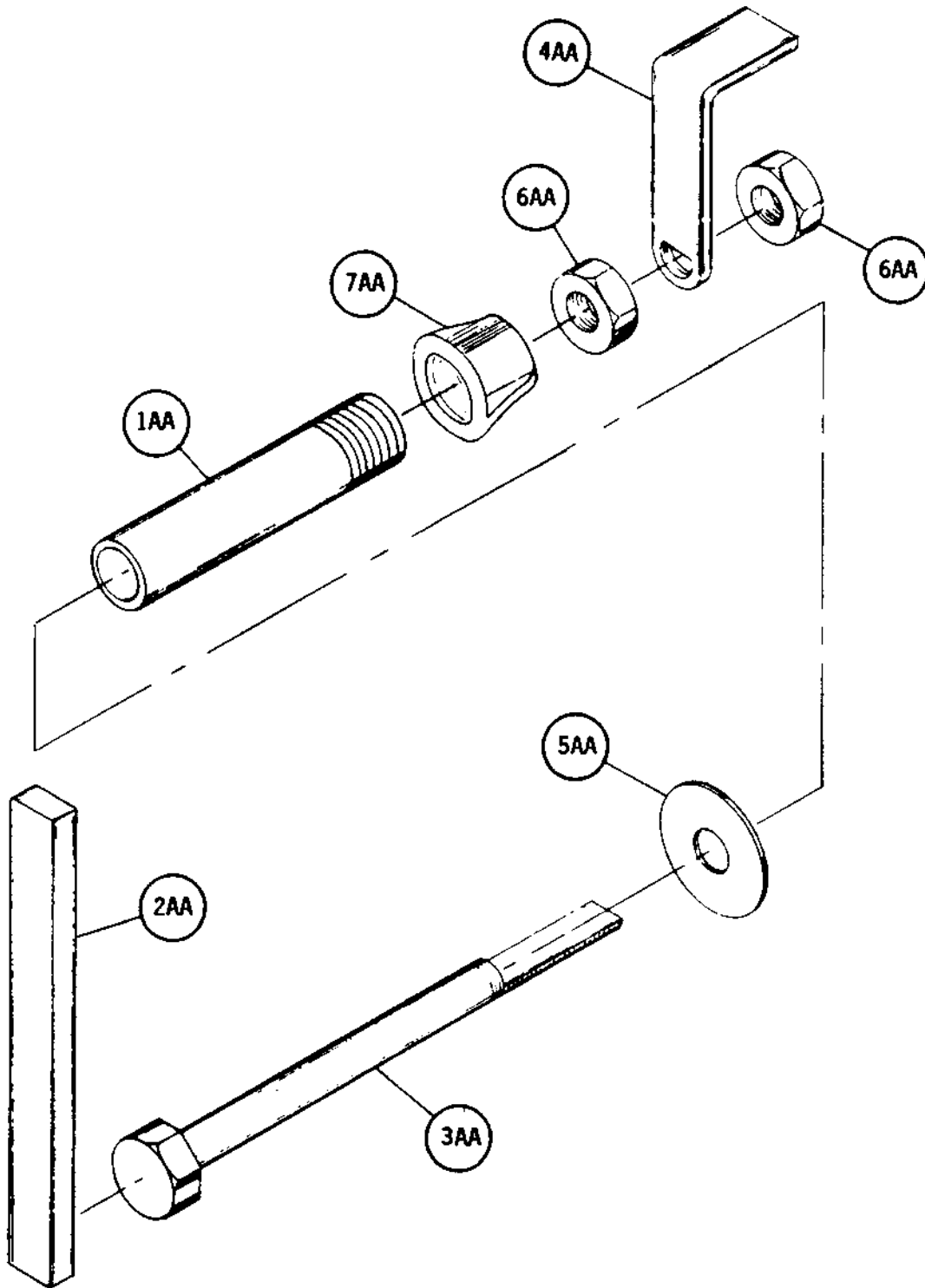


Fig. 2-8. Exploded, schematic diagram of the grate shaking mechanism.

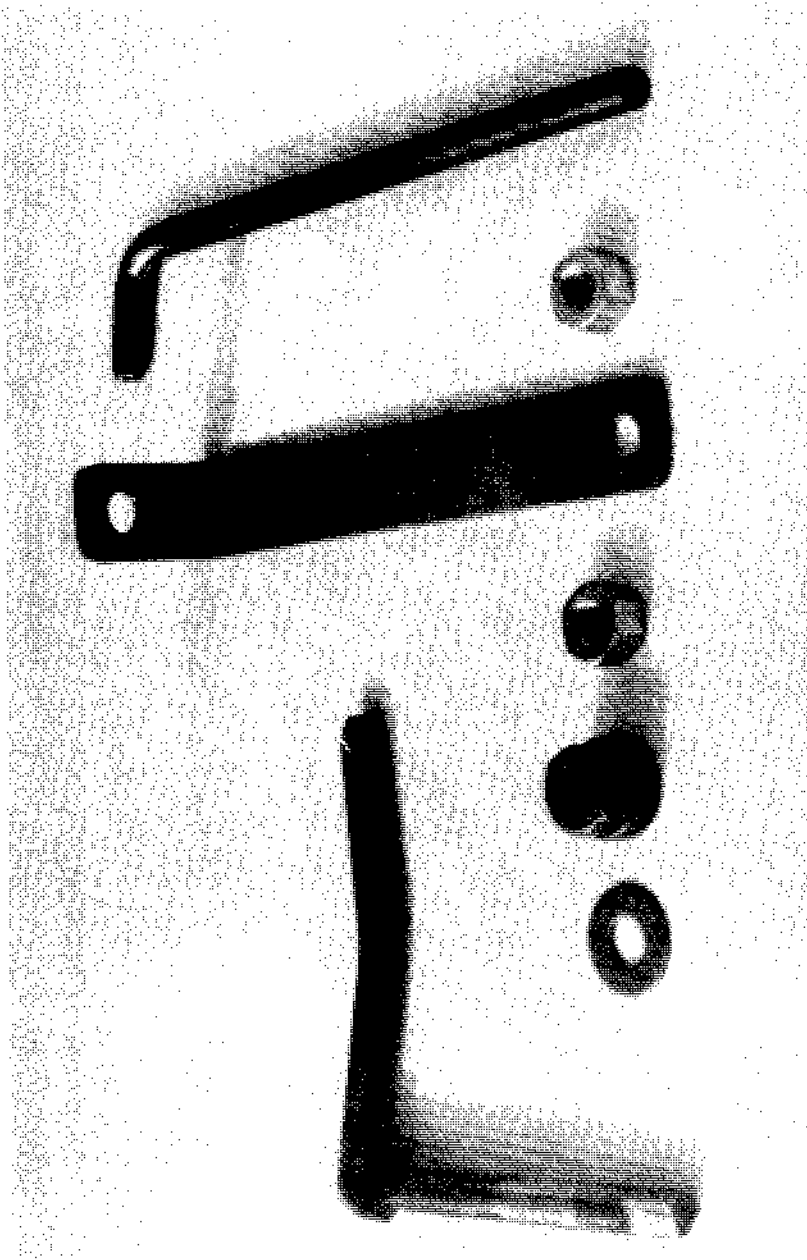
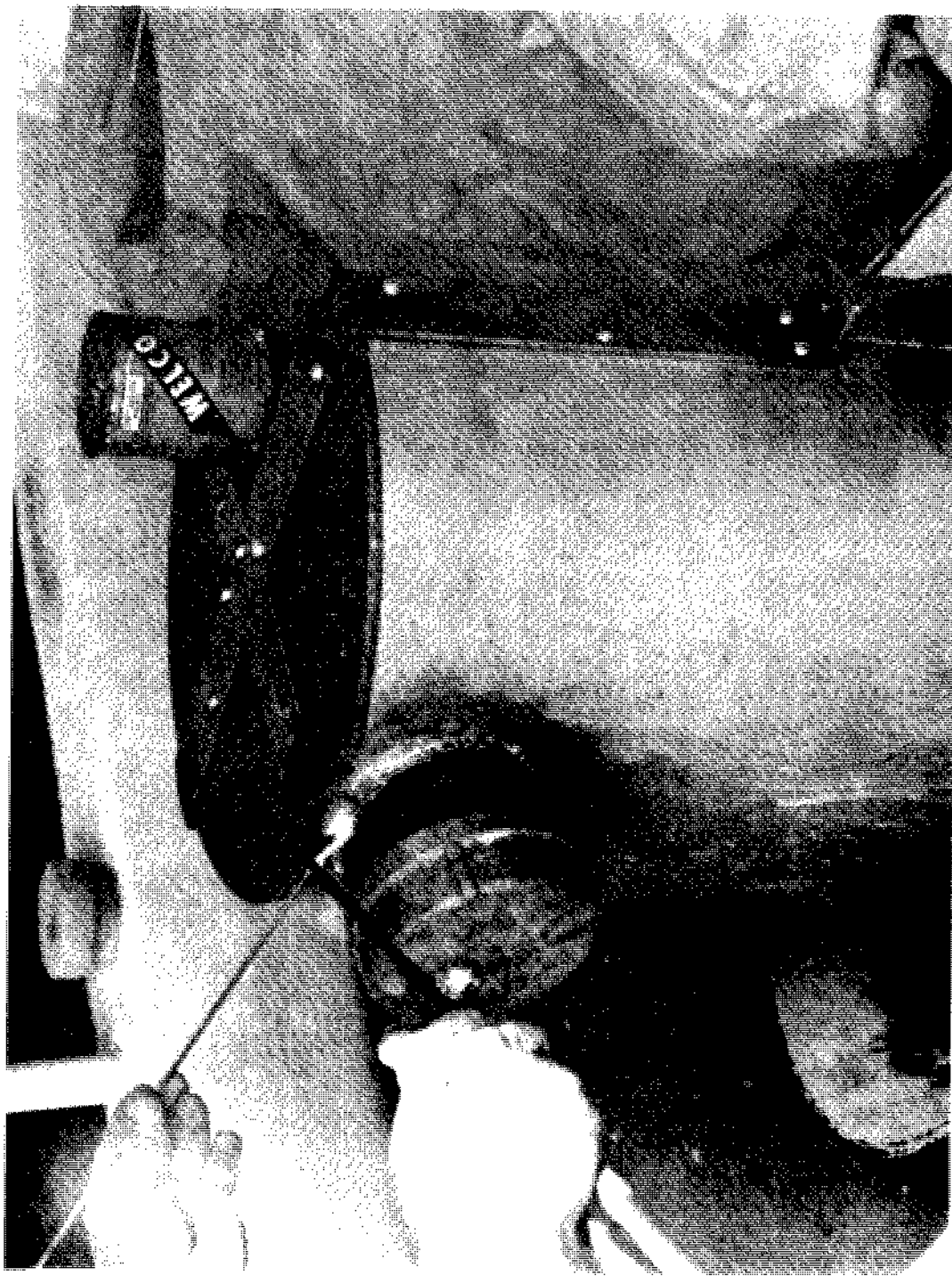


Fig. 2-9. Parts for the shaker assembly. Note the flattened portion of the bolt (at extreme left) which positively locks into the handle (third from right). At the extreme right is a "poker bar" which engages into the hole in the top of the handle to operate the shaker mechanism; the shaker handle will get very hot during normal gasifier operation.

ORNL-Photo 4527-87



**Fig. 2-10. The support frame can be brazed or bolted to the side of the gasifier unit. All bolts should be sealed air tight.**

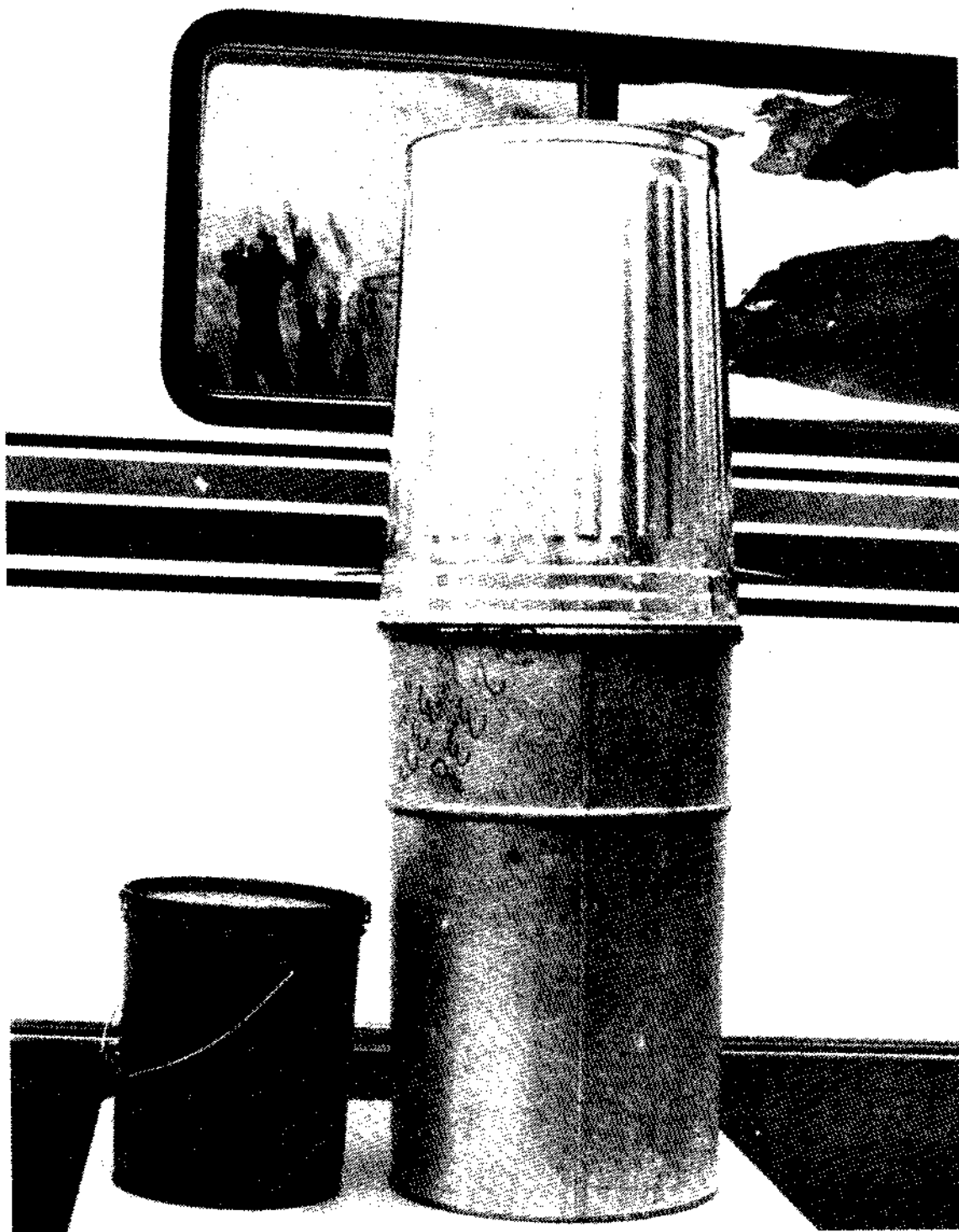
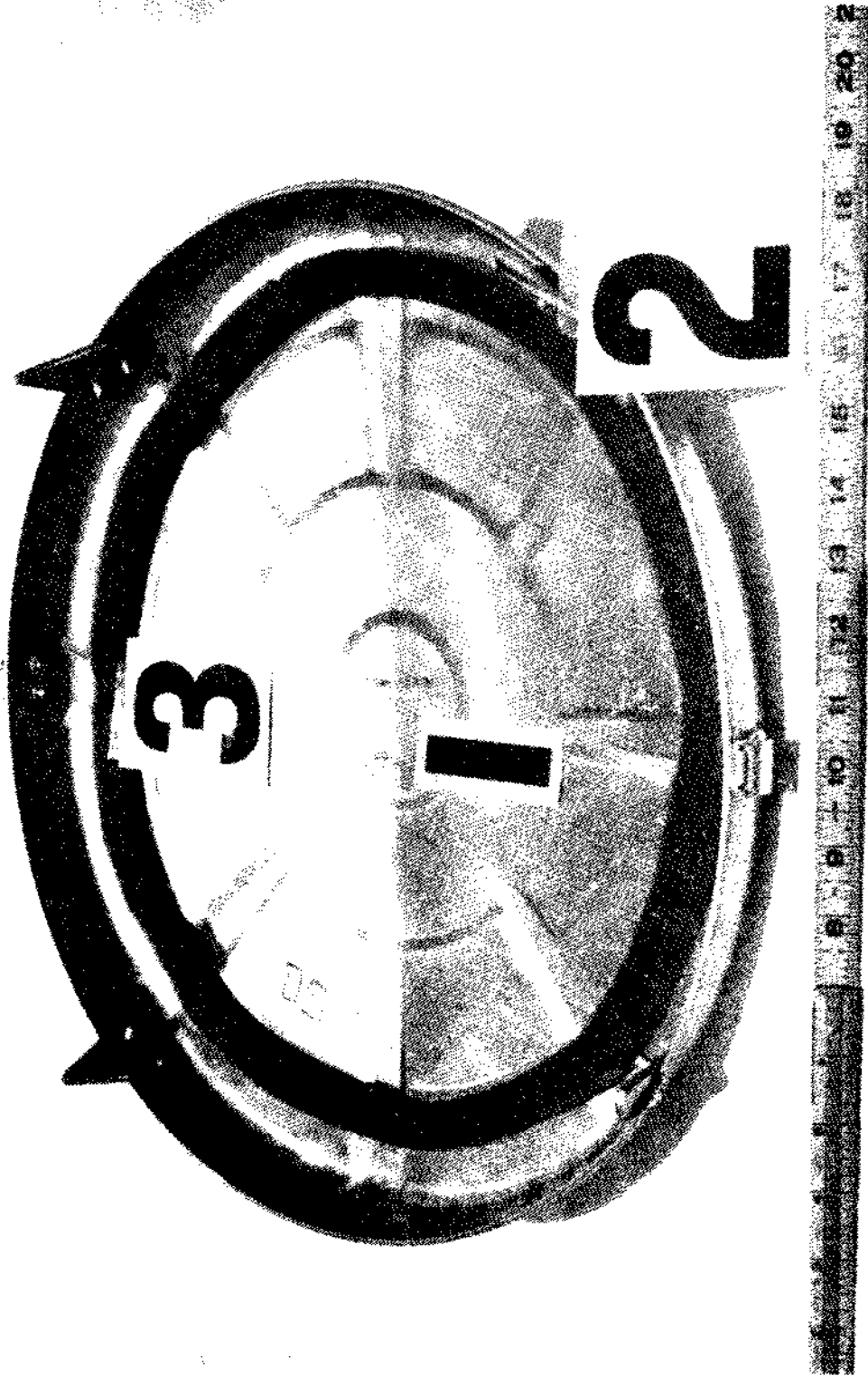


Fig. 2-11. Containers used in constructing the prototype gasifier unit. At right, a 20-gal garbage can (the fuel hopper) is shown on top of a 30-gal metal drum (the gasifier unit housing). The 5-gal paint can, at left, is used as the filter container.



**Fig. 2-12. Cover for the fuel hopper. Note the foam weatherstripping (#3) attached to the underside of the lid where it contacts the fuel hopper. Attach four standoffs (#2) to the lid (#1) as shown.**

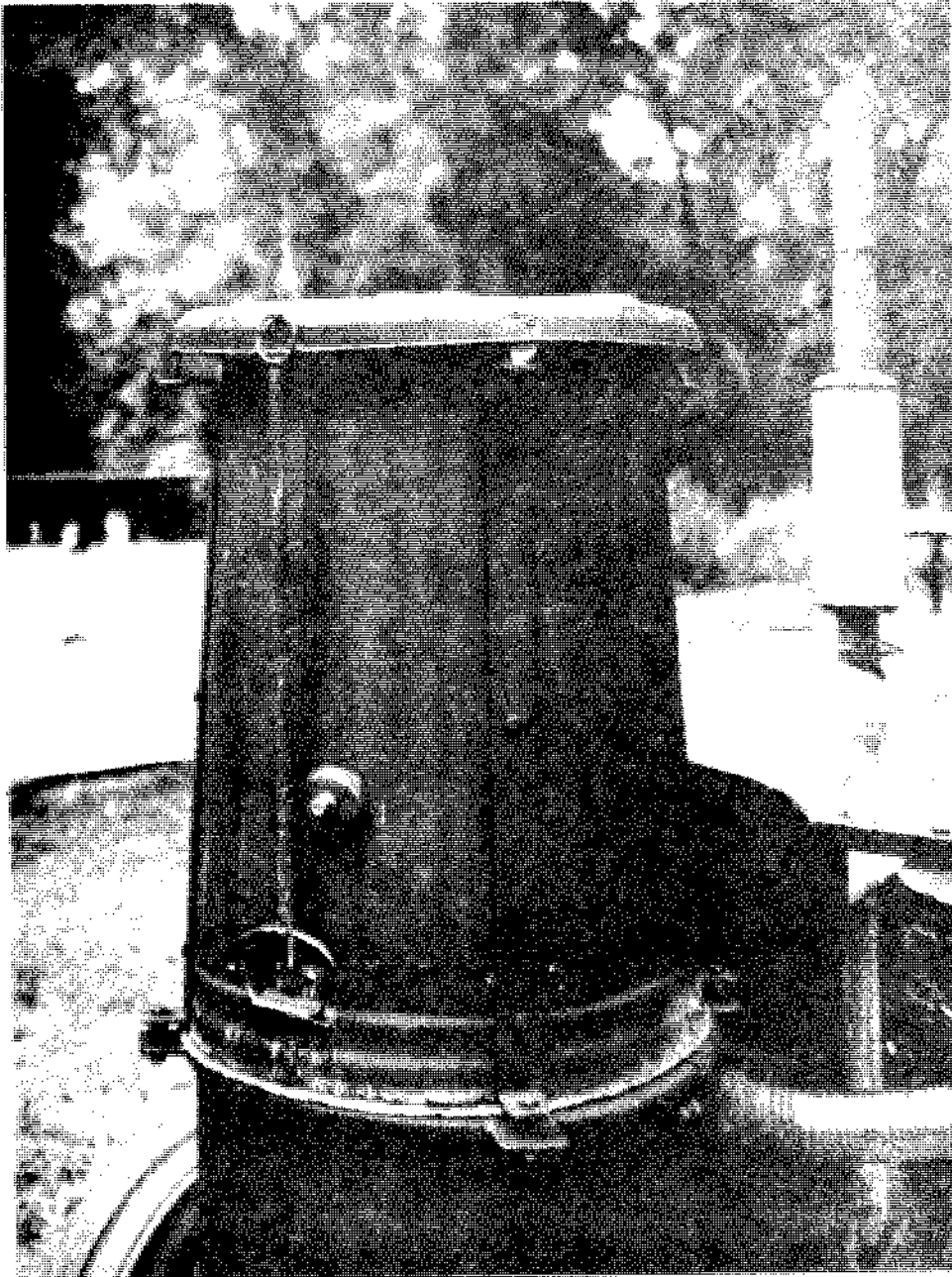


Fig. 2-13. Operating configuration of the fuel hopper and its cover.



ORNL-Photo 4506-87

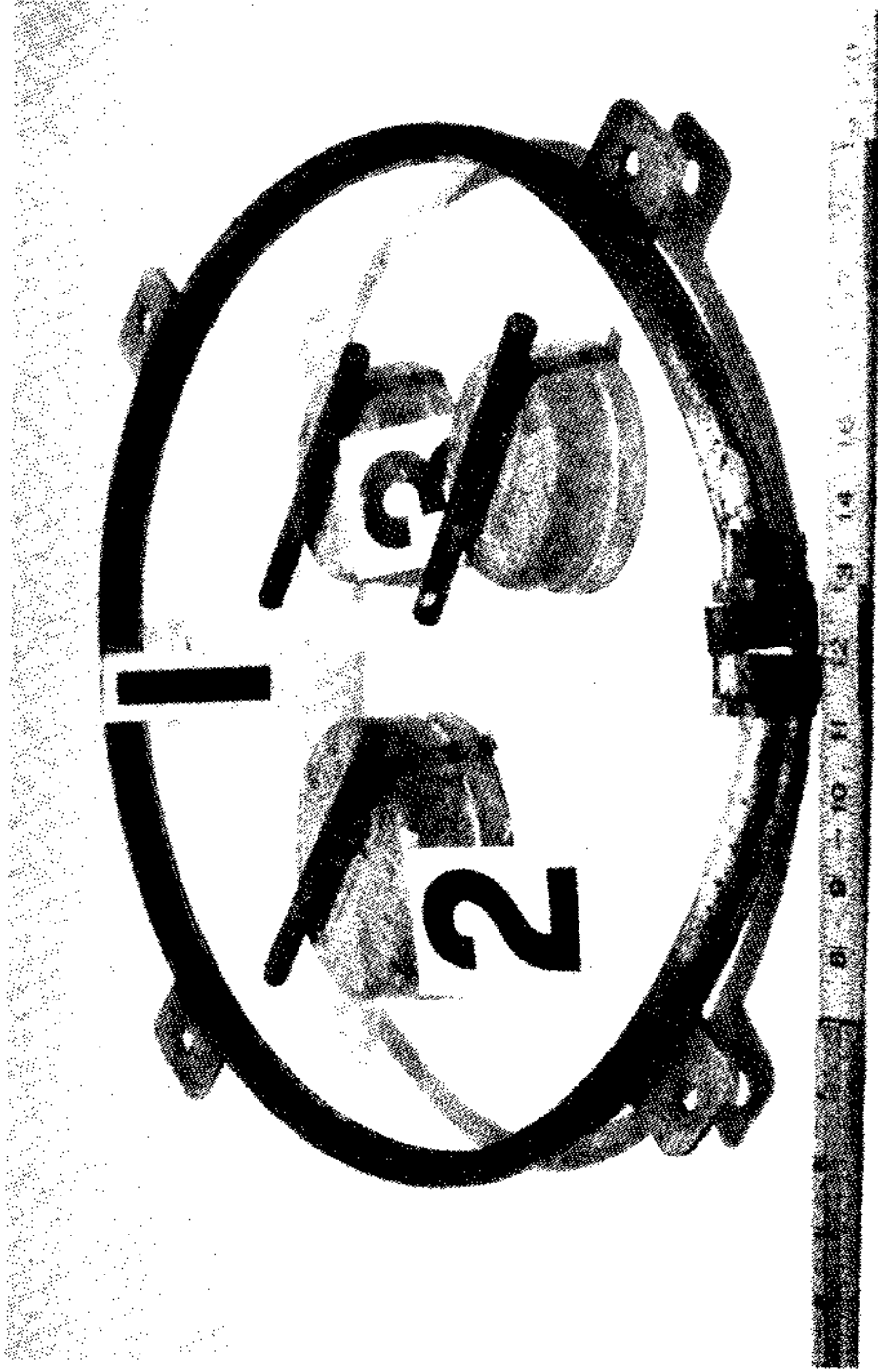


Fig. 2-14. Lock ring and welded tabs. Also pictured inside the lock ring (#1): the ash cleanout cover cap (#2), and the ignition cover cap (#3).

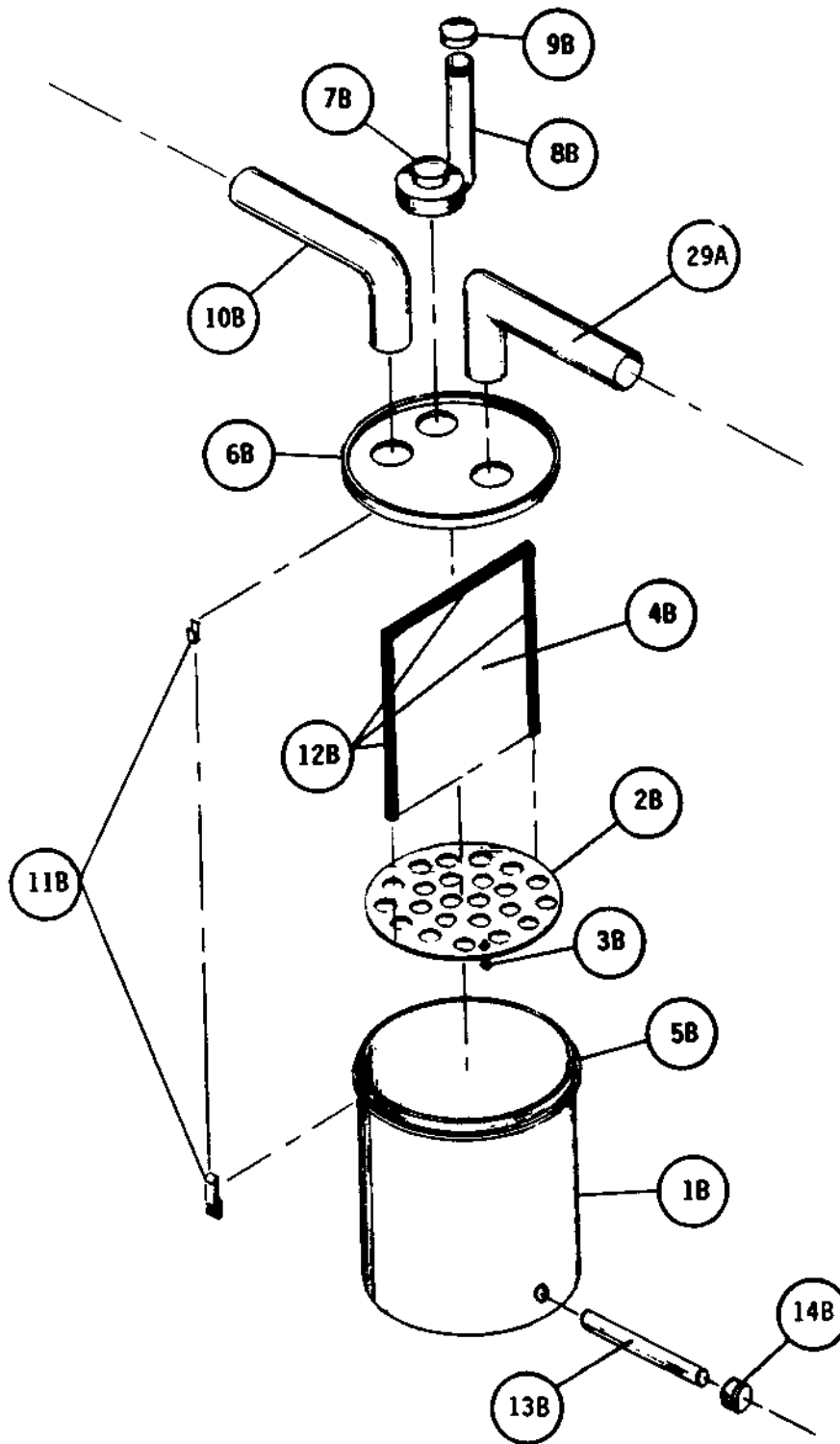


Fig. 2-15. Exploded, schematic diagram of the filter unit.

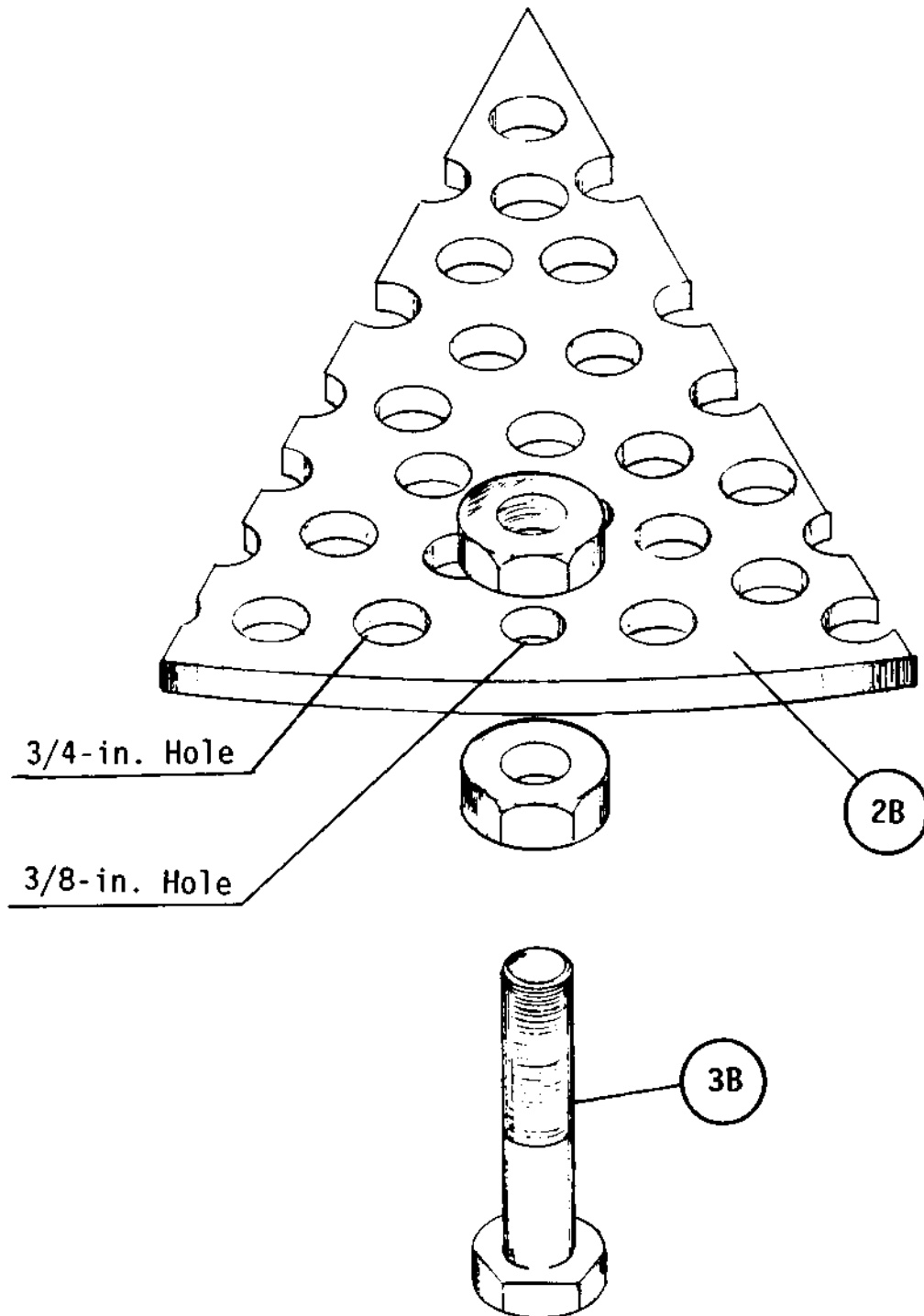


Fig. 2-16. Detail of the standoffs for the bottom plate of the filter unit.

ORNL-Photo 4519-87

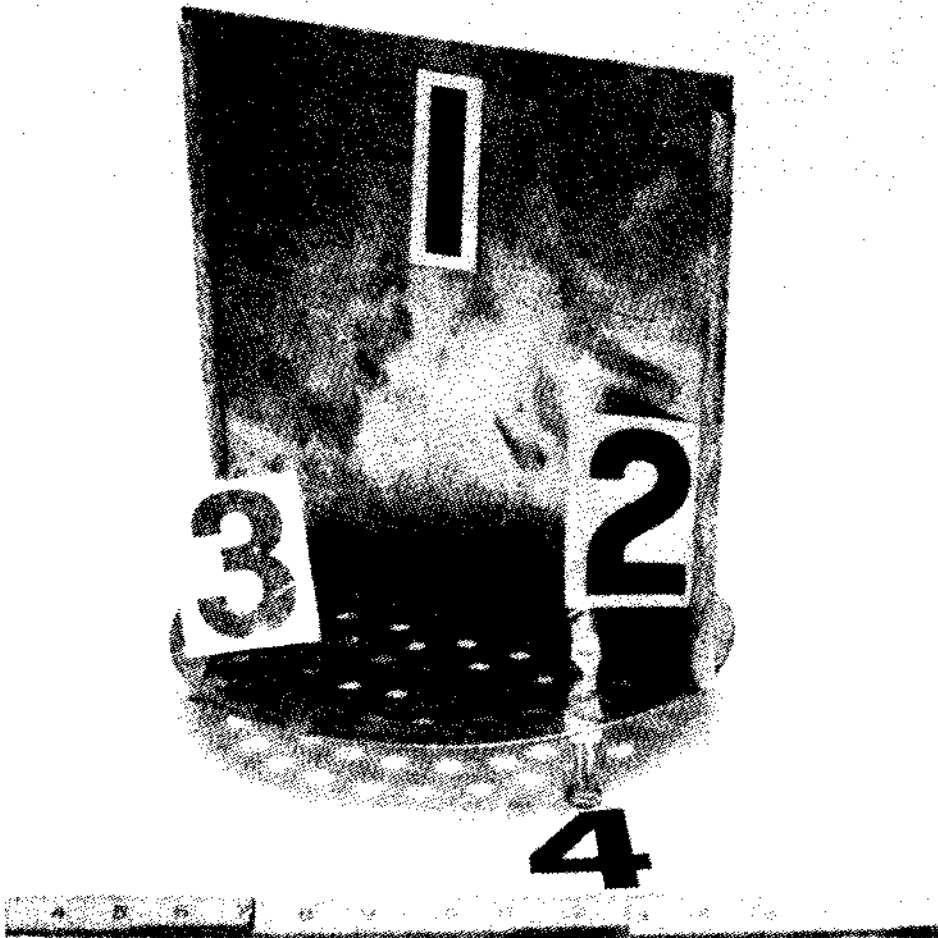


Fig. 2-17. Divider plate (#1) and bottom plate (#3), with standoffs (#4), for the filter unit. Note the high-temperature hose lining the sides of the divider plate.

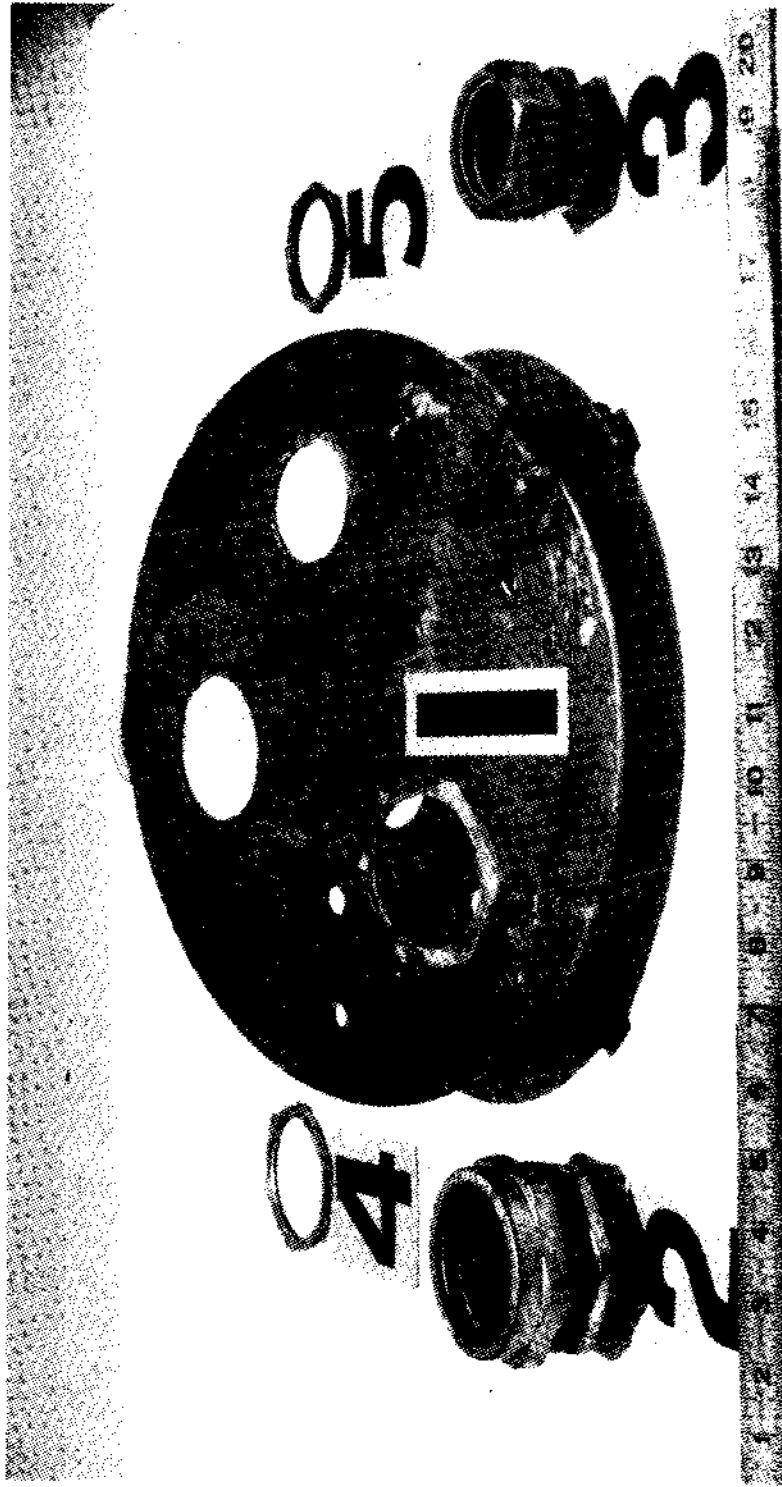


Fig. 2-18. Circular lid (#1) for the filter unit. Note the arrangement of the holes; divider plate would roughly run from 10 o'clock position to 4 o'clock position (assuming 12 o'clock is taken to be at the rear of the photograph). Also shown are the conduit connectors (#2 and #3) and accompanying nuts (#4 and #5) for inside the lid.

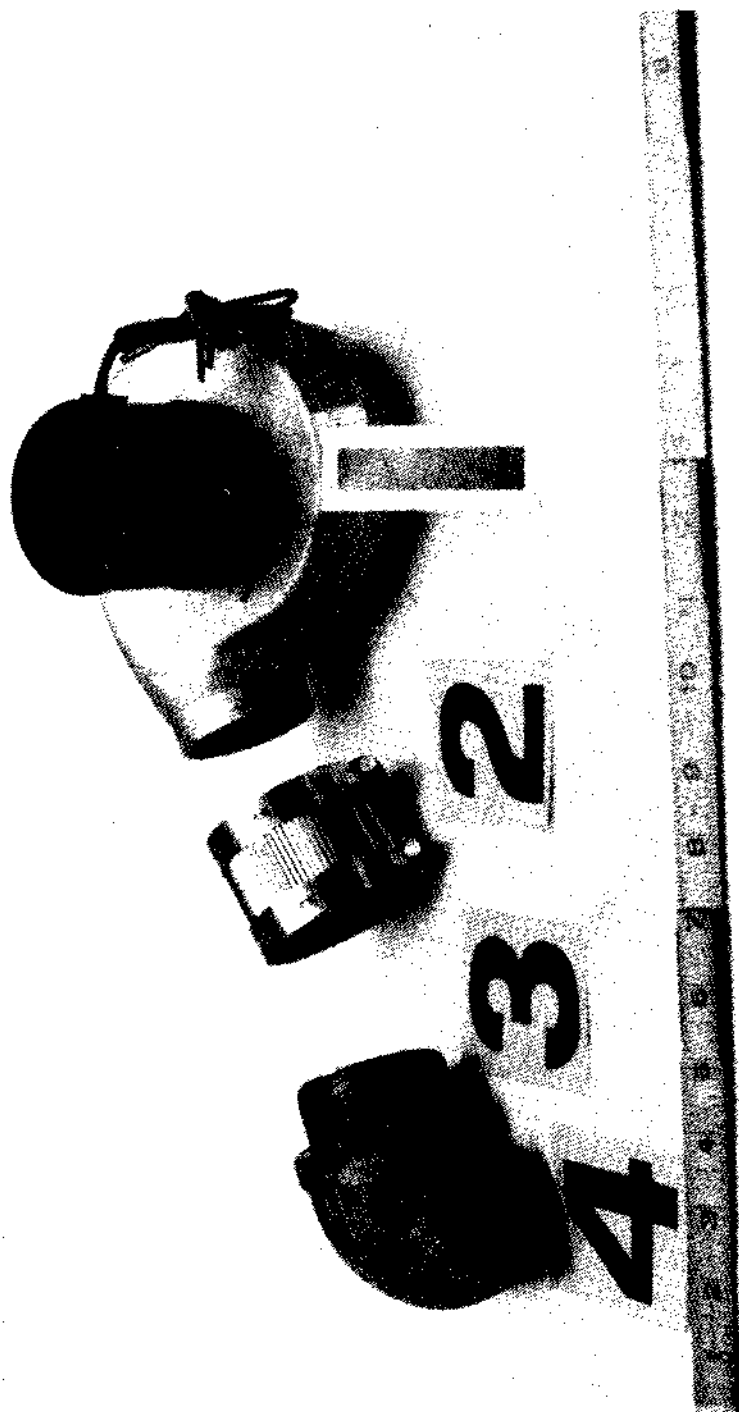


Fig. 2-19. Blower (#1) with exhaust extension assembly. Note adapter coupling (#2), pipe nipple (#3), and elbow (#4) for vertical exhaust pipe.

ORNL-Photo 4512-87

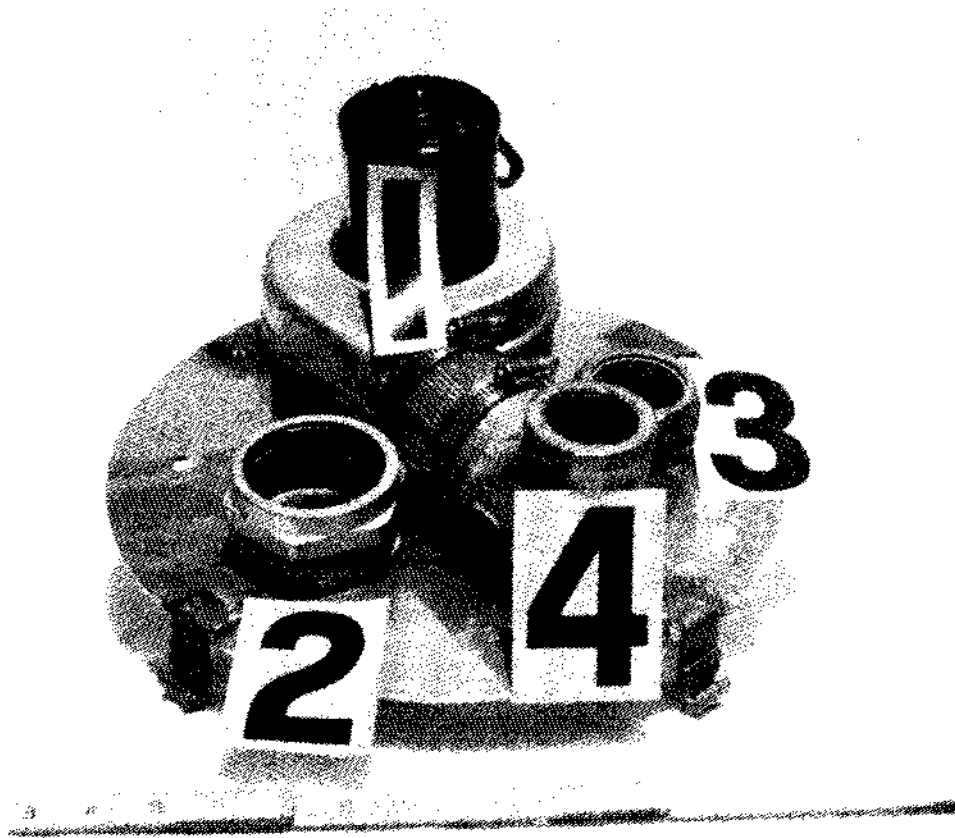


Fig. 2-20. Assembled and installed blower (#1), extension assembly (#4), and conduit connectors for gas inlet (#2) and outlet (#3) on lid of filter unit. Note hook attachments at edge of lid for latches.

ORNL-Photo 4517-87



Fig. 2-21. Filter container (#1) showing latches (#2) for lid and hose (#3) around top.



ORNL-DWG 87-14558

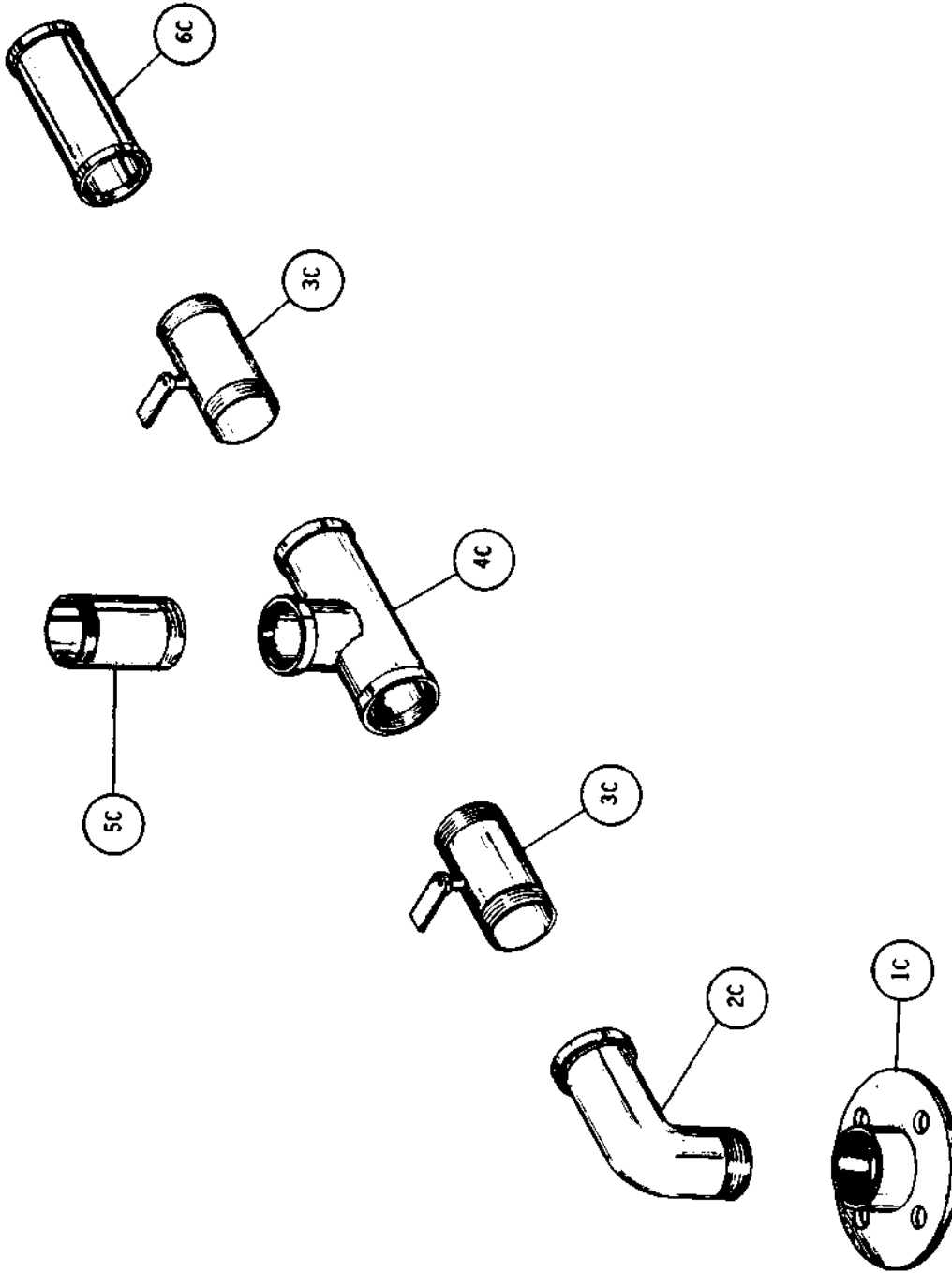


Fig. 2-22. Exploded, schematic diagram of the carburecing unit and control valves.

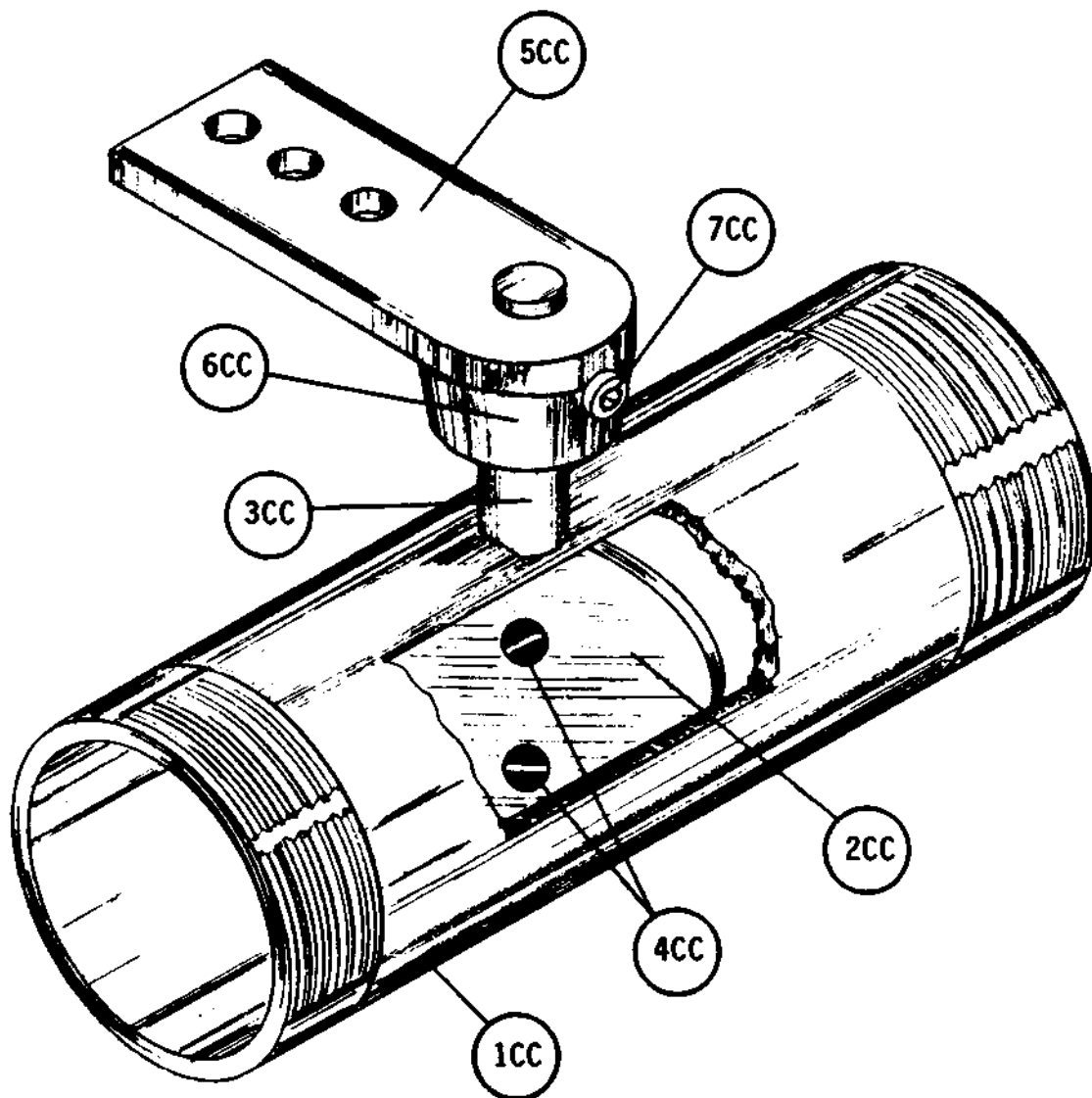


Fig. 2-23. Schematic diagram of a butterfly control valve.

ORNL - Photo 4484 - 87

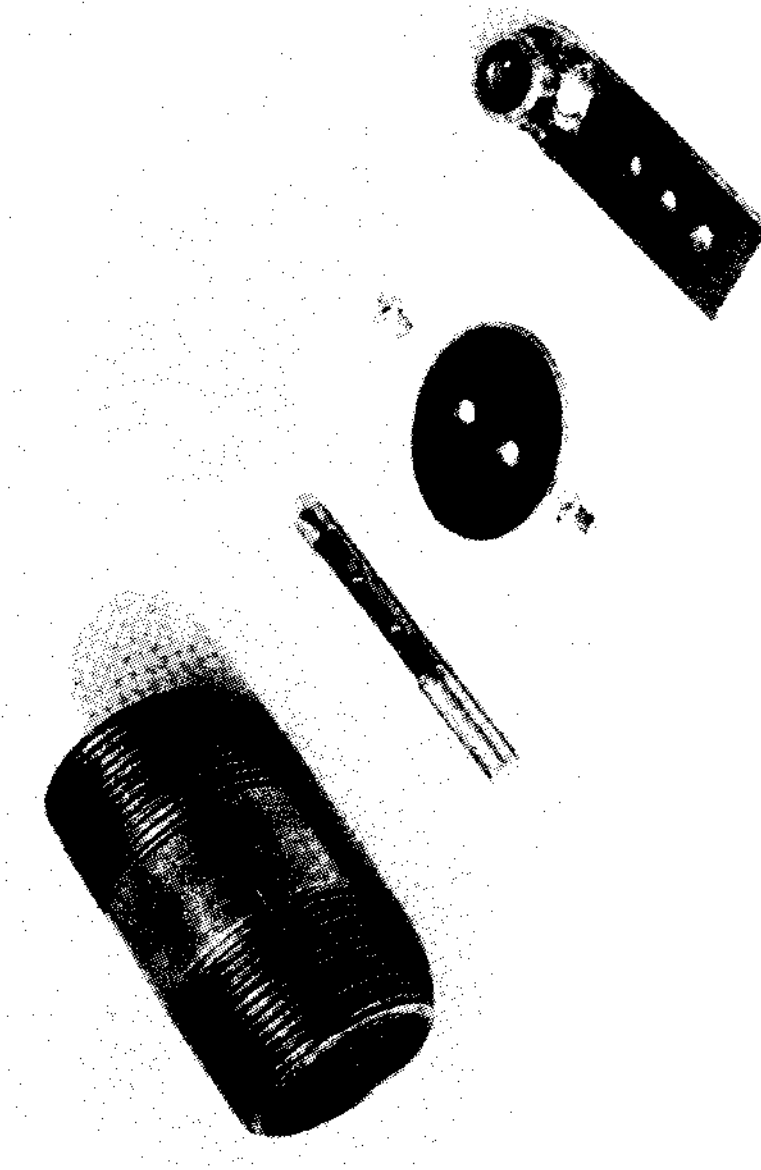


Fig. 2-24. Parts required for the butterfly valve.

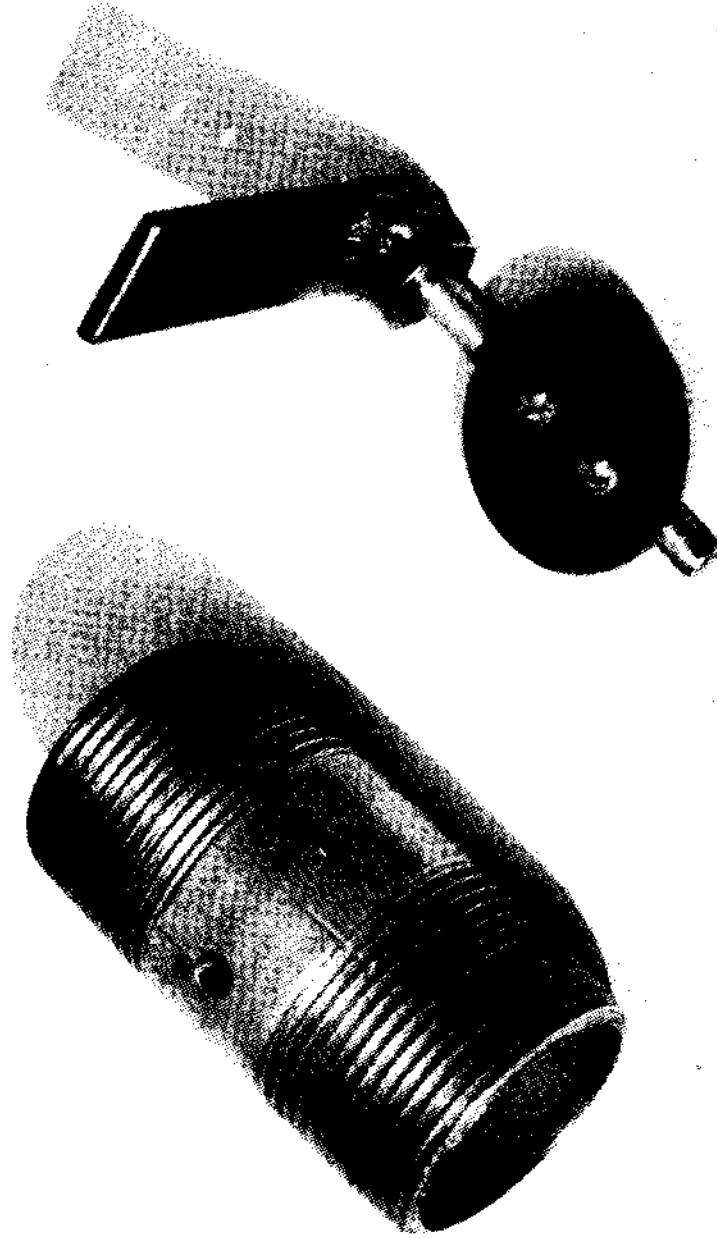
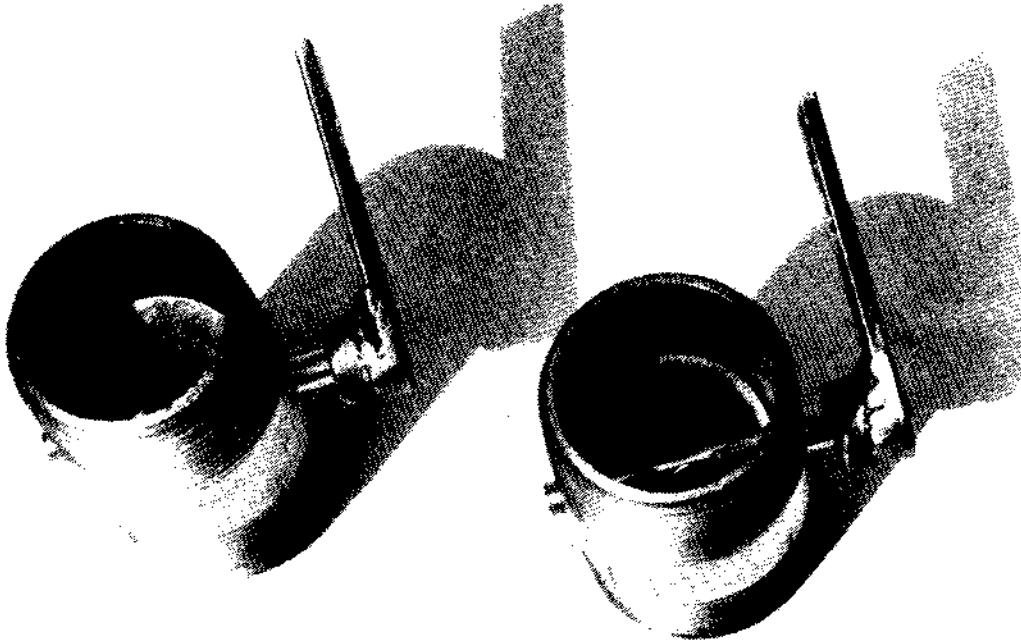


Fig. 2-25. Butterfly valve assembly. Note that the valve has been assembled outside of the valve body for clarity.

ORNL-Photo 4487-87



**Fig. 2-26. Assembled butterfly valves.**

ORNL-Photo 4490-87

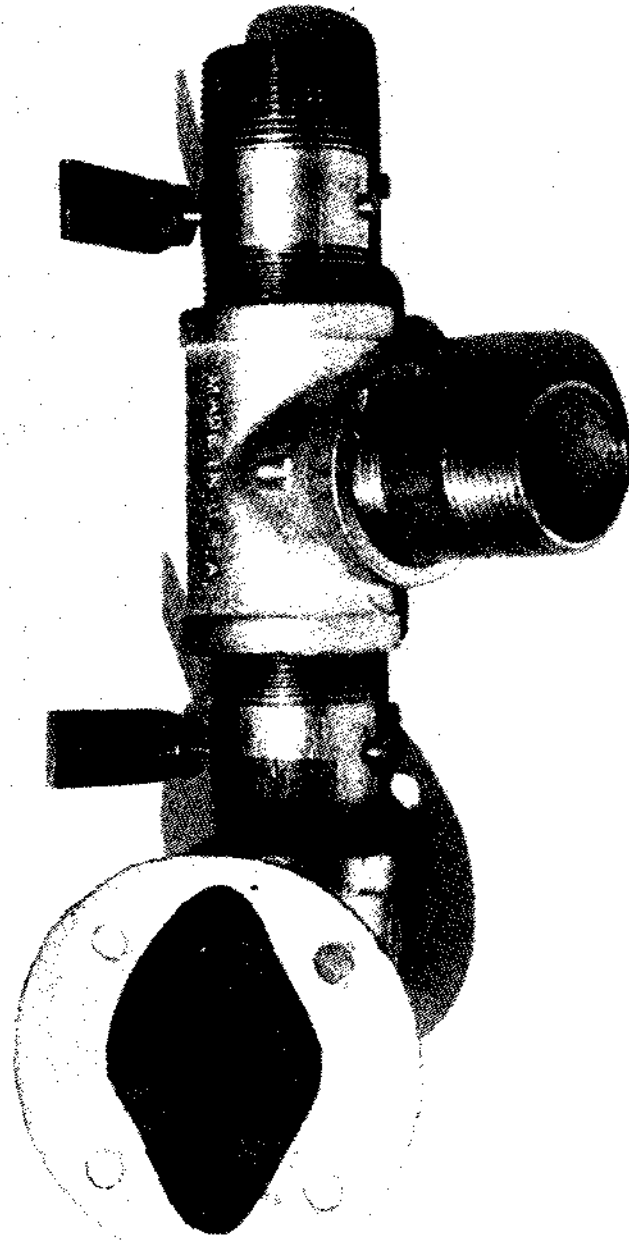


Fig. 2-27. Assembled carburetion unit. Note the gasket on the closet flange.

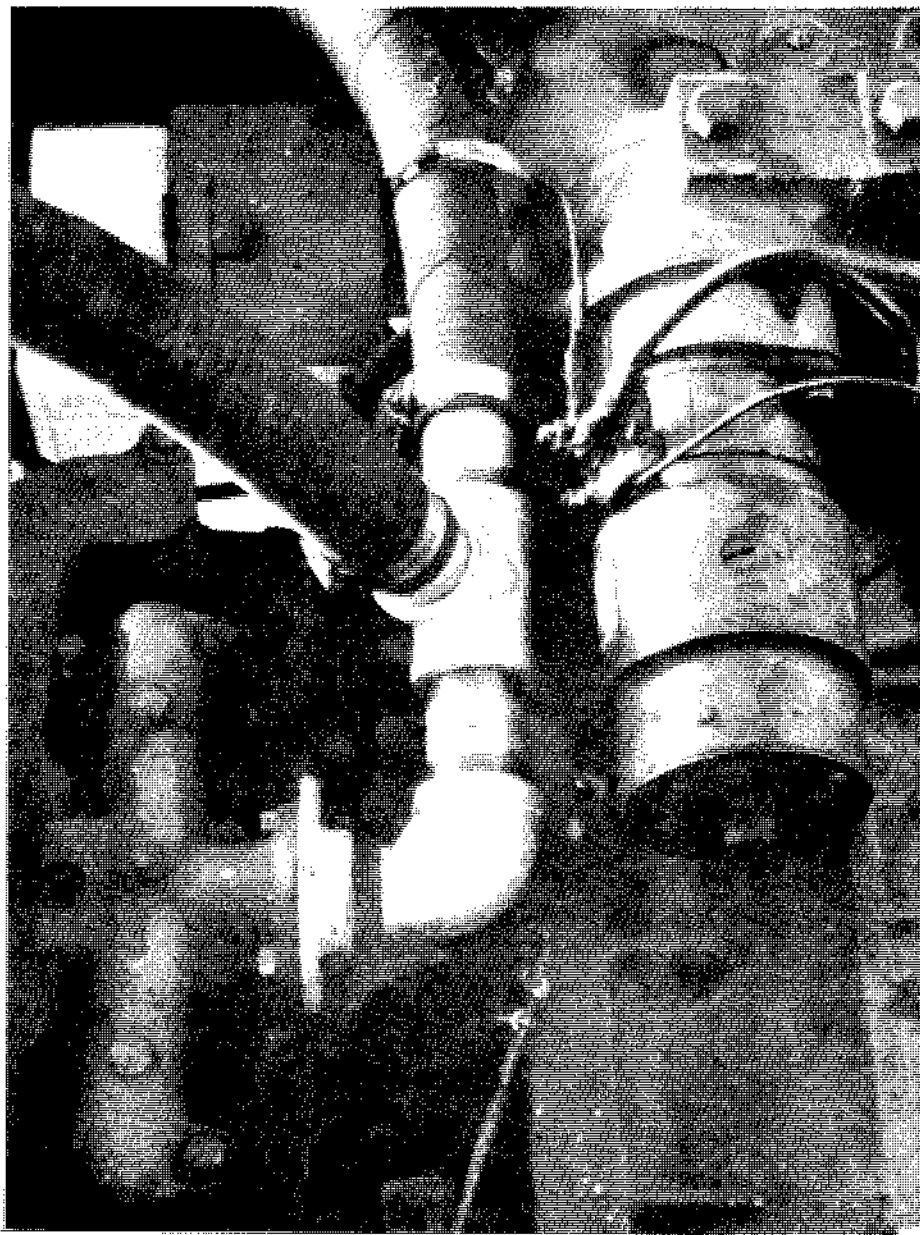


Fig. 2-28. Carburetion unit attached to engine's existing intake manifold. Wood gas enters from the side of the tee; air enters from the right-hand end. The butterfly valve at the right (partially obscured) is connected to the air control (choke) cable; the left valve is connected to the throttle linkage.

**Table 2-1. List of materials for the gasifier unit and the wood fuel hopper**

Item	Quantity	Description
1A	1	Metal pipe, tube, or other, open-ended metal cylinder; diameter and length from Table 2-2; minimum wall thickness of 1/4 in.
2A	1	Circular metal plate with thickness of 1/8 in.; diameter equal to outside diameter of Item 1A.
3A	1	30-gal metal oil drum or metal container with approximate dimensions of 18 in. (diameter) by 29 in. (height); container must have a bottom.
4A	1	10-quart stainless steel mixing bowl, colander, or other stainless steel bowl with approximately 14-in. diameter and 6-in. depth.
5A	1	2-in. metal U-bolt.
6A	1	3/16-in. metal chain with 1-in. links; 7 ft total length.
7A	3	1/4-in. eyebolts, 3 in. length with two nuts for each eyebolt.
8A	1	4-in. metal pipe nipple.
9A	1	Metal pipe cap for Item 8A.
10A	2	3-in. metal pipe nipple.
11A	2	Metal pipe cap for Item 10A.
12A		Shaker assembly; see Fig. 2-8.
1AA	1	Metal 1/2-in. pipe; 6 in. length.
2AA	1	Iron bar stock; square or round, 1/2 in.; 6 in. length.
3AA	1	1/2-in. bolt; 8 in. long.
4AA	1	Iron bar stock; rectangular, 1/4 by 1 in.; 10 in. length.
5AA	1	1/2-in. flat washer.
6AA	2	1/2-in. nuts.
7AA	1	Metal pipe cap or bushing for Item 1AA.



Table 2-1. (continued)

Item	Quantity	Description
13A	1	Iron bar stock; rectangular, 1/4 by 2 in.; 10 ft length.
14A	25	1/4-in. bolts; 3/4 in. length; with nuts.
15A	1	20-gal metal garbage can or metal container with approximate dimensions of 18 in. (top diameter) by 24 in. (height); bottom is not required.
16A	1	Lid for 20-gal garbage can.
17A	1	Garden hose; 1/2 to 5/8 in. diameter; length equal to circumference of Item 15A.
18A	1	Foam weather stripping with adhesive backing; 1/4 by 1 in.; length equal to circumference of Item 15A.
19A	1	Iron bar stock; rectangular, 1/4 by 2 in.; 10 ft length.
20A	12	1/4-in. bolts; 3/4 in. length; with nuts.
21A	4	Metal triangles; 2 by 2.5 in., 1/8 to 1/4 in. thick.
22A	2	Metal eye hook.
23A	2	Screen door spring, 14 in. length.
24A	1	Lock ring for 30-gal (or larger) oil drum.
25A	4	Metal squares; 2 by 2 in., 1/4 in. thick.
26A	4	3/8-in. bolts; 3 in. length.
27A	1	Tube of high temperature silicone or liquid high temperature gasket material.
28A	1	60-lb. sack of hydraulic or other waterproof cement [such as SEC-PLUG (tm), which is manufactured by the Atlas Chemical Company, Miami, FL].
29A	1	2-in. pipe, electrical conduit, flexible automobile exhaust pipe, or other metal tubing; 6-ft minimum length. Pipe must be able to withstand temperatures of 400°F.

Table 2-2. Fire tube dimensions

Inside diameter (inches)	Minimum length (inches)	Engine power (horsepower)	Typical engine displacement (cubic inches)
2 <sup>a</sup>	16	5	10
4 <sup>a</sup>	16	15	30
6	16	30	60
7	18	40	80
8	20	50	100
9	22	65	130
10	24	80	160
11	26	100	200
12	28	120	240
13	30	140	280
14	32	160	320

<sup>a</sup>A fire tube with an inside diameter of less than 6<sup>1</sup>/<sub>2</sub> in. would create bridging problems with wood chips and blocks. If the engine is rated at or below 15 horsepower, use a 6-in. minimum fire tube diameter and create a throat restriction in the bottom of the tube corresponding to the diameter entered in the above table.

**NOTES:**

For engines with displacement rated in liters, the conversion factor is 1 liter = 61.02 cubic inches.

The horsepower listed above is the SAE net brake horsepower as measured at the rear of the transmission with standard accessories operating. Since the figures vary when a given engine is installed and used for different purposes, such figures are representative rather than exact. The above horsepower ratings are given at the engine's highest operating speed.

**Table 2-3. List of materials for the primary filter unit**

Item	Quantity	Description
1B	1	5-gal metal can or other metal container with minimum dimensions of 11.5-in. diameter and 13 in. tall.
2B	1	Circular metal plate; diameter equal to 1/2 in. smaller than inside diameter of Item 1B; thickness of 1/8 in.
3B	3	3/8-in. bolts; 3 in. length with two nuts for each bolt.
4B	1	Rectangular metal plate; width equal to 1/4 in. smaller than inside diameter of Item 1B; height equal to 2.5 in. smaller than internal height of Item 1B; 1/8 in. thick.
5B	1	High-temperature hose, 3/8 to 5/8 in. diameter; length equal to circumference of Item 1B.
6B	1	Circular metal plate; diameter equal to outside diameter of Item 1B; thickness of 1/8 in.
7B	1	12-volt blower (automotive heater type); case and fan must be all metal.
8B	1	Metal extension pipe for blower outlet, including elbows and connections for vertical orientation; 1 ft. minimum length.
9B	1	Cap for Item 8B; plastic is acceptable.
10B	1	1.25-in. metal pipe, electrical conduit, automotive exhaust pipe, or other metal tubing; 2 ft minimum length.
11B	3	Metal latch for securely connecting Items 1B and 6B together. Such devices as suitcase or luggage catches, bail-type latches, window sash catches (with strike), or wing-nut latches are acceptable.
12B	1	High-temperature hose, 3/8 to 5/8 in. diameter; length equal to three times the height of Item 4B.
13B	1	Metal 1/2-in. pipe, threaded on one end; 8 in. length.
14B	1	Metal pipe cap for Item 13B.

Table 2-4. List of materials for the carbureting unit

Item	Quantity	Description
1C	1	1.25-in. closet flange.
2C	1	1.25-in. male-to-female 45° pipe elbow.
3C		Butterfly valve; see Fig. 2-23.
1CC	2	1.25-in. pipe nipple or threaded length of pipe, 3-in. length.
2CC	2	Oval metal plate; 1/16 in. thick; short dimension equal to inside diameter of Item 1CC; long dimension equal to 1.02 times the short dimension.
3CC	2	3/8-in. diameter rod; 2.5 in. length.
4CC	4	3/16-in. screws; 3/16 in. length.
5CC	2	Flat bar stock; rectangular, 1/2 by 3 in.; 1/8 in. thick.
6CC	1	7/16-in. nut.
7CC	1	1/8-in. set screw.
4C	1	1.25-in. tee with all female threads.
5C	1	1.25-in. pipe nipple or threaded length of pipe, 3 in. length.
6C	1	1.25-in. pipe or hose.
7C	1	Gasket material; sized to cover Item 1C.
8C	1	Tube of pipe compound or Teflon tape for sealing threaded assemblies.

### 3. OPERATING AND MAINTAINING YOUR WOOD GAS GENERATOR

#### 3.1 USING WOOD AS A FUEL

Because wood was used extensively as generator fuel during World War II, and since it is plentiful in most parts of the populated United States, it merits particular attention for use as an emergency source of energy. When used in gas generators, about 20 lb of wood have the energy equivalence of one gallon of gasoline.

Wood consists of carbon, oxygen, hydrogen, and a small amount of nitrogen. As a gas generator fuel, wood has several advantages. The ash content is quite low, only 0.5 to 2% (by weight), depending on the species and upon the presence of bark. Wood is free of sulphur, a contaminant that easily forms sulfuric acid which can cause corrosion damage to both the engine and the gas generator. Wood is easily ignited—a definite virtue for the operation of any gas generator unit.

The main disadvantages for wood as a fuel are its bulkiness and its moisture content. As it is a relatively light material, one cubic yard of wood produces only 500 to 600 lb of gas generator fuel. Moisture content is notoriously high in wood fuels, and it must be brought below 20% (by weight) before it can be used in a gas generator unit. By weight, the moisture in green wood runs from 25 to 60%, in air-dried wood from 12 to 15%, and in kiln-dried wood about 8%. Moisture content can be measured quite easily by carefully weighing a specimen of the wood, placing it in an oven at 220°F for thirty minutes, reweighing the specimen, and reheating it until its weight decreases to a constant value. The original moisture content is equivalent to the weight lost.

The prototype unit in this manual (with an 6-in.-diam firetube) operated well on both wood chips (minimum size: 3/4 by 3/4 by 1/4 in.) and blocks (up to 2-in. cubes); see Fig. 3-1 (all figures and tables mentioned in Sect. 3 are presented at the end of Sect. 3). Larger sizes could be used, if the firetube diameter is increased to prevent bridging of the individual pieces of wood; of course, a throat restriction would then have to be added to the bottom of the firetube so as to satisfy the dimensions in Table 2-2 in Sect. 2.

#### 3.2 SPECIAL CONSIDERATIONS AND ENGINE MODIFICATIONS

To start the fire in the gasifier, the blower must be used to create a suction airflow through the wood in the hopper and downward in the firetube. If an especially high horsepower engine is to be fueled by the gasifier unit, then it might be necessary to install two such blowers and run them simultaneously during start-up.

When the wood gas leaves the gasifier unit, all the oxygen pulled down with the air through the firetube has been chemically converted and is contained in carbon monoxide (CO) and water (H<sub>2</sub>O). The wood gas is unable to burn without being mixed with the proper amount of additional oxygen. If an air leak develops below the grate area, the hot gas will burn while consuming the available oxygen and will create heat; this will almost certainly destroy the gasifier unit if it is not detected soon. If an air leak develops in the filter unit or in the connecting piping, the gas will become saturated with improper amounts of oxygen

and will become too dilute to power the engine. Therefore, airtightness from the gasifier unit to the engine is absolutely essential.

Ideally, as the wood gas enters the engine manifold it should be mixed with air in a ratio of 1:1 or 1.1:1 (air to gas) by volume. The carburetion system described in this report will provide this mixture with a minimum of friction losses in the piping. The throttle control valve and the air control valve must be operable from the driver's seat of the vehicle.

The engine's spark plug gaps should be adjusted to between 0.012 and 0.015 in.; the ignition timing should be adjusted to "early."

### 3.3 INITIAL START-UP PROCEDURE

Initially, you will need to add charcoal to the grate below the firetube. Subsequent operation will already have the grate full of charcoal which has been left over from the previous operating period.

Fill the firetube with charcoal\* to a level 4 in. above the grate. Fill the hopper with air-dried wood; then, proceed with the routine start-up directions below.

### 3.4 ROUTINE START-UP PROCEDURE

1. Agitate the grate shaker handle for at least twenty seconds to shake down the charcoal from the previous operating period.
2. Open the ash cleanout port and remove the ashes from the generator housing drum. Lubricate the threads of the cleanout port with high-temperature silicone, and close the cover of the cleanout port so that it is airtight.
3. Fill the hopper with wood fuel, and tamp the fuel down lightly. Either leave the lid completely off the fuel hopper, or adjust the opening around the lid to a 3/4-in. (or larger) clearance.
4. Close the carburetor's air control valve and remove the cover from the blower exhaust on top of the filter unit. Start the blower, and let it run for thirty seconds to avoid explosion of residual gas in the system. Then, with the blower still operating, proceed with the next step.
5. Open the ignition port, and ignite a 12- by 12-in. piece of newspaper; with a long stick or wire, push the burning sheet of newspaper into the grate; see Fig. 3-2. Close the ignition port. If no smoke appears at the blower's exhaust port, repeat the start-up

---

\*Charcoal produced for outdoor barbecue grills is not well suited for gas generator use. To produce a better grade of charcoal, place a rag soaked in alcohol on the grate, or place 3 to 5 pages of newspaper on the grate, then fill the fire tube to a height of 10 to 12 in. with well-dried wood. Have all the valves closed and let the fire tube act as a chimney until the wood is converted to charcoal.

sequence from Step (e). If repeated attempts fail, new charcoal should be added to the unit as described in Sect. 3.3, above, and the start-up ignition sequence should be repeated.

6. After a few minutes of smoky exhaust, test the gas at the blower exhaust by safely and carefully attempting to ignite it; see Fig. 3-3. When the gas burns consistently well, stop the blower and replace the cover on the blower exhaust.
7. Open the carburetor's air control valve, adjust the engine's accelerator, and start the engine in a normal manner. Let the engine warm up slowly (two to five minutes). If the engine fails to start or dies repeatedly, restart the blower and repeat the ignition sequence from Step (4).

### 3.5 DRIVING AND NORMAL OPERATION

Shift gears so as to keep the engine speed (rpm) high at all times. Remember that it is the vacuum created by the pistons that provides the force which moves the gas from the gasifier unit into the engine.

Refill the hopper with wood (as shown in Fig. 3-4) before it is completely empty, but avoid refilling just before the end of engine operation. Periodically shake down the ashes from the grate. If your system is equipped with a gas cooler, drain water from the cooler from time to time.

Under operation in dry weather, the gasifier can be operated without the lid on the fuel hopper. However, when the gasifier unit is shut down the hopper must be covered to prevent air from continuing to burn the wood in the hopper. Under wet-weather operation, the cover must be placed on the fuel hopper, and then lifted up and rotated about 2 in. until the triangular pieces line up with the holes in the support bars. The tension of the screen door springs will then hold the lid closed. See Fig. 3-5 for clarification.

### 3.6 SHUTTING-DOWN THE GASIFIER UNIT

When shutting down the gasifier unit, turn off the ignition switch and open the carburetor's air control valve for ten seconds to relieve any pressure from within the system. Then, completely close the air control valve, and place the cover tightly on the fuel hopper. When restarting after a short stopover, let the engine warm up briefly. After longer stops (up to one hour), tamp down the wood lightly and try to use the blower for restarting without relighting the wood fuel. After very long stops (over two hours) the charcoal must be ignited again.

### 3.7 ROUTINE MAINTENANCE

Periodically check all nuts on the gasifier unit, the fuel hopper, the filter unit, and the carburetor for snugness; check all penetrations and fittings for airtightness. In addition, perform the following maintenance activities as scheduled:

### **3.7.1 Daily Maintenance**

Open the ash cleanout port of the gasifier housing drum and remove the ashes after shaking the grate for at least thirty seconds. Replace the cover of the port after coating the threads with high-temperature silicone to ensure airtightness. Open the drain tube at the bottom of the filter container and allow any liquid condensate to drain out; remember to close the drain tube when finished.

### **3.7.2 Weekly Maintenance (or every 15 hours of operation)**

Clean out the gasifier housing drum, the fuel hopper, and the filter. Rinse out the piping and connections to and from the filter. Replace the wood chips inside the filter. (The used wood chips from the filter can be dumped into the fuel hopper and burned to produce wood gas.) Use high-temperature silicone on all pipe connections and on the filter lid to ensure airtightness.

### **3.7.3 Biweekly Maintenance (or every 30 hours of operation)**

Make sure that all pipe connections are secure and airtight. Check and tighten all mounting connections to the vehicle chassis. Check for rust on the outside of the gas generator housing drum, especially on the lower region. Coat with high-temperature protective paint as necessary.

## **3.8 OPERATING PROBLEMS AND TROUBLE-SHOOTING**

A discussion of problems and their related causes and cures is contained in the troubleshooting guide of Table 3-1. Many operational problems can be traced to failure to maintain the airtightness of all piping connections and fittings; the piping should be routinely checked to prevent such problems.

## **3.9 HAZARDS ASSOCIATED WITH GASIFIER OPERATION**

Unfortunately, gas generator operation involves certain problems, such as toxic hazards and fire hazards. These hazards should not be treated lightly; their inclusion here, at the end of this report, does not mean that these hazards are unimportant. The reader should not underestimate the dangerous nature of these hazards.

### **3.9.1 Toxic Hazards**

Many deaths in Europe during World War II were attributed to poisoning from wood gas generators. The danger of "generator gas poisoning" was one of the reasons that such gasifiers were readily abandoned at the end of World War II. It is important to emphasize that "generator gas poisoning" is carbon monoxide (CO) poisoning. Acute "generator gas



poisoning" is identical with the symptoms that may develop if a heating stove damper is closed too early, or if a gasoline vehicle is allowed to idle in a poorly ventilated garage. Table 3-2 shows how poisoning symptoms develop according to the concentration of carbon monoxide in breathable air. It is important to note that rather brief exposures to very small concentrations of carbon monoxide result in undesirable physiological effects.

In case of carbon monoxide poisoning, first aid should consist of the following procedures:

1. Move the victim quickly out into the open air or to a room with fresh air and good ventilation. All physical exertion on the part of the victim must be avoided.
2. If the victim is unconscious, every second is valuable. Loosen any tight clothing around the neck. If breathing has stopped, remove foreign objects from the mouth (false teeth, chewing gum, etc.) and immediately give artificial respiration.
3. Keep the victim warm.
4. Always call a physician.
5. In case of mild carbon monoxide poisoning without unconsciousness, the victim should be given oxygen if possible.

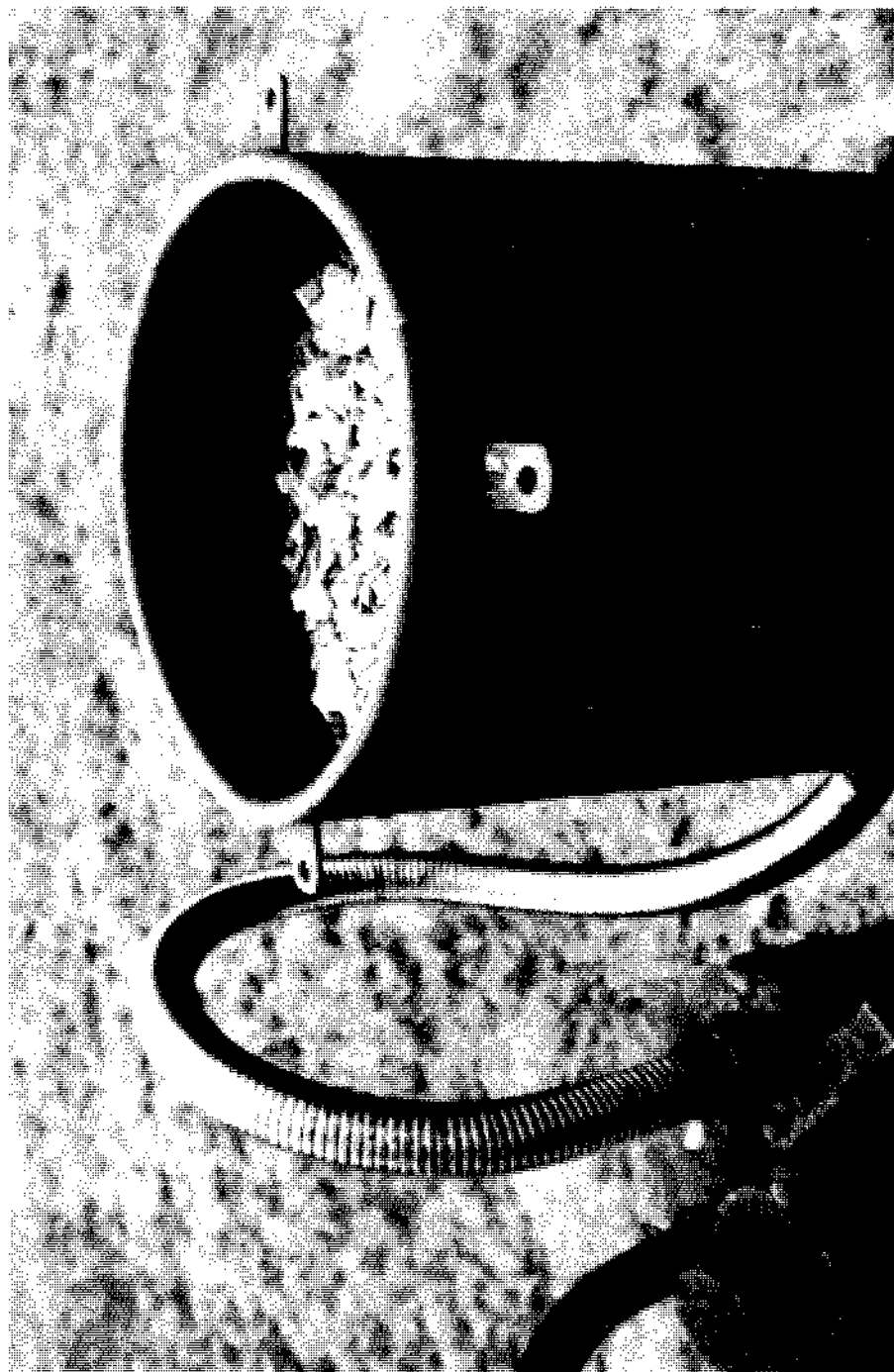
### **3.9.2 Technical Aspects of "Generator Gas Poisoning"**

Generator gas poisoning is often caused by technical defects in the functioning of the gas generator unit. When the engine is running, independent of the starting blower, the entire system is under negative pressure created by the engine's pistons; the risk of poisoning through leakage is therefore minimal. However, when the engine is shut off, formation of wood gas continues, causing an increase of pressure inside the generator unit. This pressure increase lasts for approximately 20 minutes after the engine is shut off. For this reason, it is not advisable to stay in the vehicle during this period. Also, the gas generator unit should be allowed to cool for at least 20 minutes before the vehicle is placed in an enclosed garage connected with living quarters. It should be emphasized that the gas formed during the shut-down period has a carbon monoxide content of 23 to 27% and is thus very toxic.

### **3.9.3 Fire Hazard**

The outside of a gas generator housing drum may reach the same temperature as a catalytic converter on today's automobiles. Care should be taken when operating in areas where dry grass or combustible material can come into contact with the housing drum of the gas generator unit. If a gas generator unit is mounted on a personal car, bus, van or truck, a minimum 6-in. clearance must be maintained around the unit. Disposal of ashes must only be attempted after the unit has cooled down (to below 150°F). Such residue must be placed away from any combustible material and preferably be hosed down with water for absolute safety.

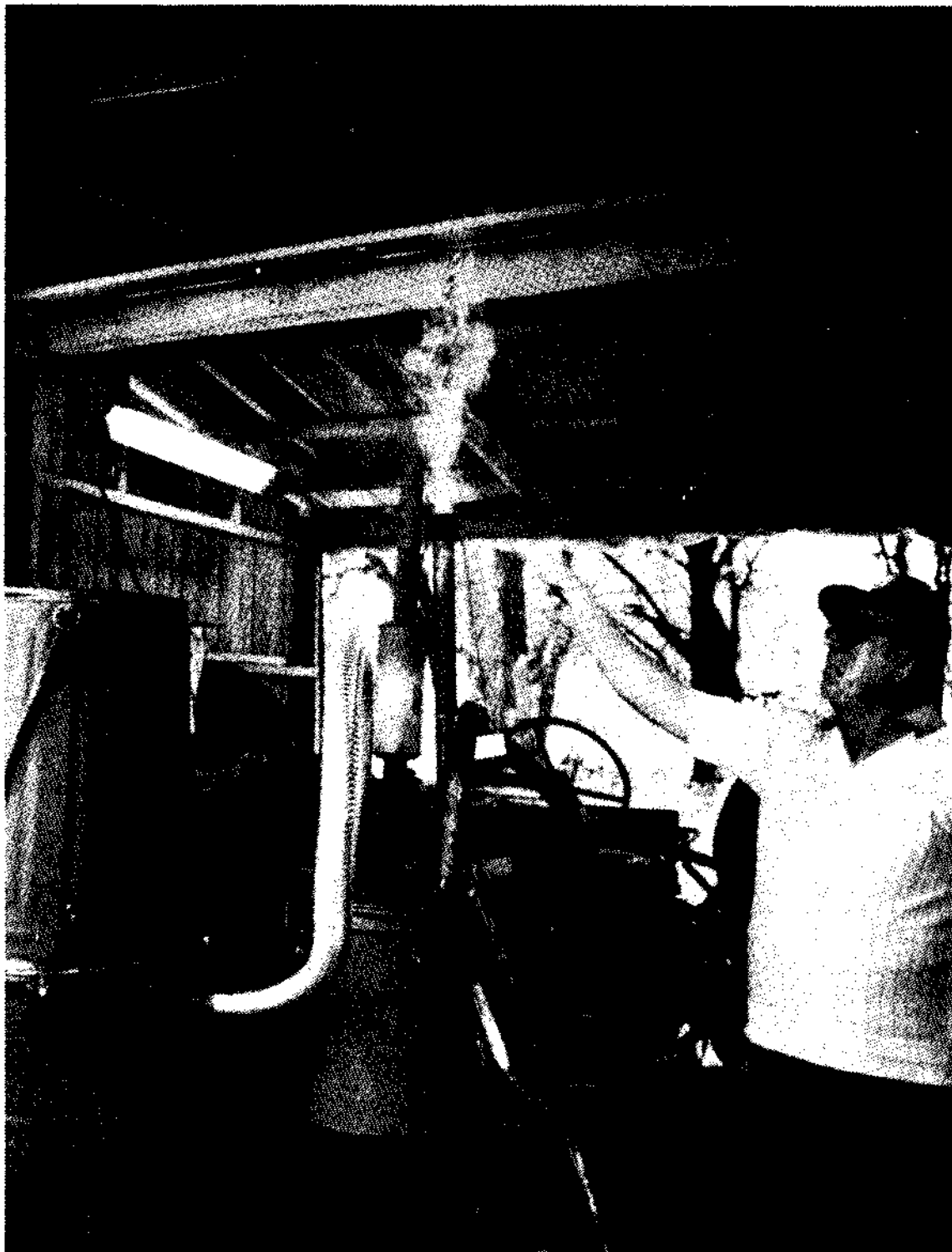
ORNL-Photo 5332-86



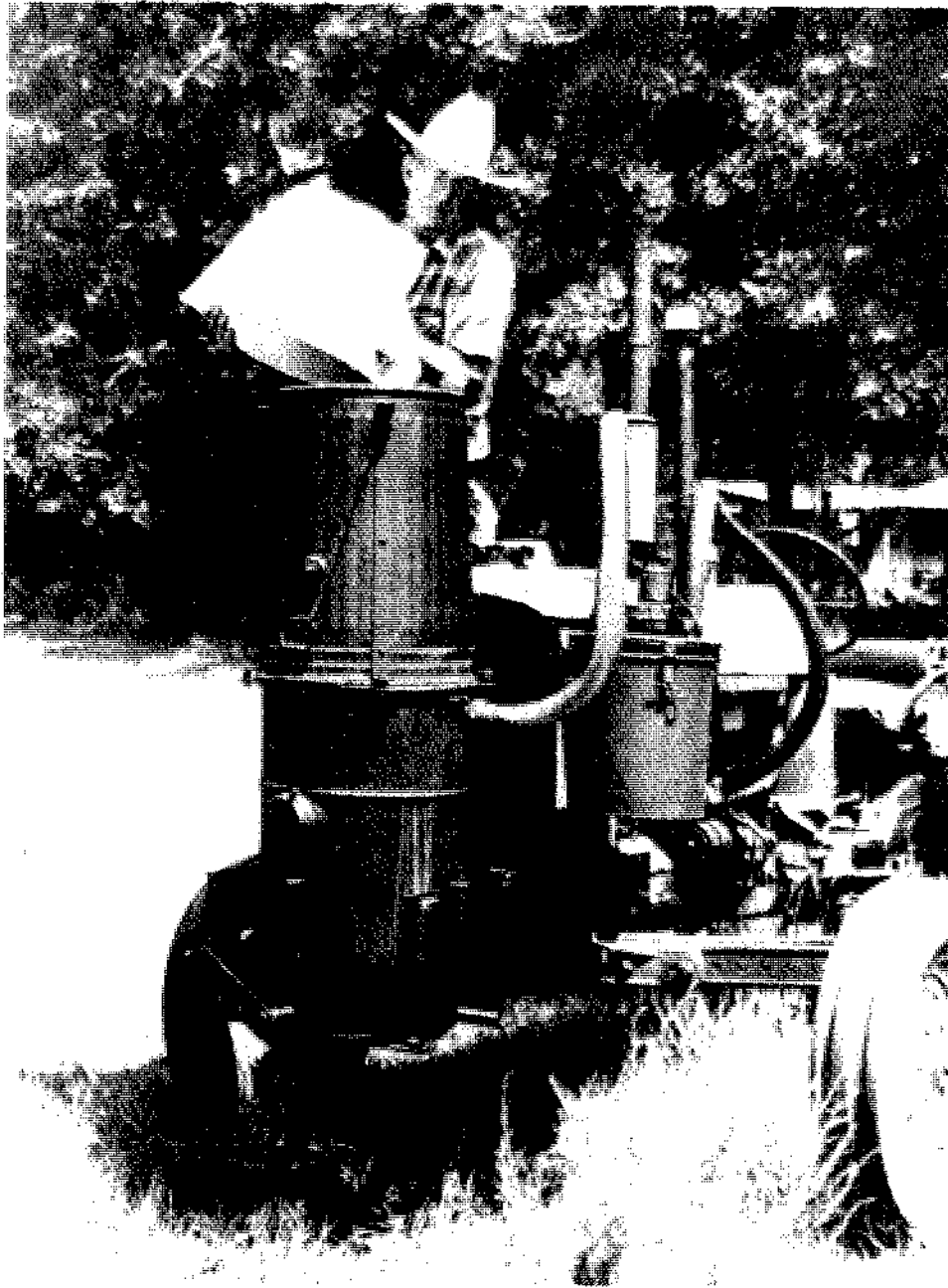
**Fig. 3-1. Virtually all varieties of wood chips can be used for fuel. (Minimum size for this 6-in. firetube unit: 3/4 by 3/4 by 1/4 in.; maximum size: 2-in. cubes.)**



**Fig. 3-2. Ignite a single piece of newspaper to start the gasifier unit. Push the flaming newspaper through the ignition port and directly into the grate. (At the right of the photo, note the battery which is operating the blower atop the filter unit.)**

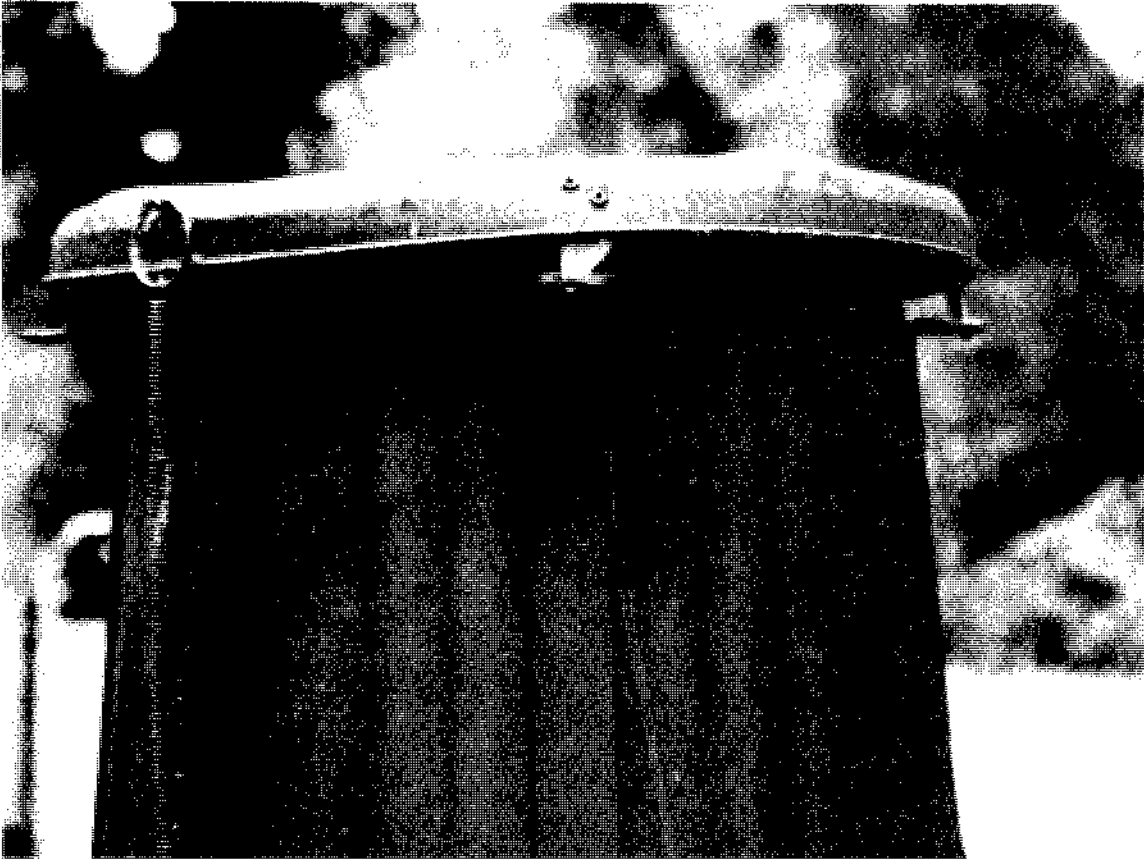


**Fig. 3-3. Igniting the exhaust gas will demonstrate that the gasifier unit is working properly.**



**Fig. 3-4. Refill the fuel hopper before it becomes two-thirds empty.**

ORNL-Photo 5314-86



**Fig. 3-5. The lid must be used to cover the fuel hopper in wet weather or when shutting the unit down.**

Table 3-1. Trouble-shooting your wood gas generator

Trouble	Cause	Remedy
Start up takes too long.	1. Dirty system or clogged pipes.	Clean the gasifier unit and all connecting piping.
	2. Blower is too weak.	Check the blower and test the battery's charge.
	3. Wet or poor quality charcoal.	Check charcoal and replace or refill to proper level.
	4. Wood fuel bridges in the fire tube.	Lightly tamp down the wood fuel in the hopper and fire tube or replace the fuel with smaller-sized chips.
Engine will not start.	1. Insufficient gas.	Use the blower longer during start up.
	2. Wet wood fuel.	Vent steam and smoke through the fire tube and fuel hopper for several minutes.
	3. Incorrect fuel-air mixture.	Regulate the carburetor's air control valve for proper mixing.
Engine starts, but soon dies.	1. Not enough gas has been produced.	Use low RPM while starting engine and do not rev engine for several minutes.
	2. Air channels through fire tube.	Tamp down wood fuel lightly in hopper. <u>Do not</u> crush charcoal above the grate.
Engine loses power under load.	1. Restricted gas flow in piping.	Reduce air mixture valve setting. Check for partial blockage of unit or piping.
	2. Leaks in system.	Check all covers and pipes for air tightness.

Table 3-2. Effects of breathing carbon monoxide

Carbon monoxide content of inhaled air (%)	Physiological effects
0.020	Possible mild frontal headache after two to three hours.
0.040	Frontal headache and nausea after one to two hours; occipital (rear of head) headache after 2.5 to 3.5 hours.
0.080	Headache, dizziness, and nausea in 45 min; collapse and possible unconsciousness in two hours.
0.160	Headache, dizziness, and nausea in 20 min; collapse, unconsciousness and possible death in two hours.
0.320	Headache and dizziness in 5 to 10 min; unconsciousness and danger of death in 30 min.
0.640	Headache and dizziness in 1 to 2 min; unconsciousness and danger of death in 10 to 15 min.
1.280	Immediate physiological effect; unconsciousness and danger of death in 1 to 3 min.

*Source: Murakoa, J. S., Shelter Habitability Studies—The Effects of Oxygen Depletion and Fire Gases on Occupants of Shelter, NCEL-TR-144, U.S. Naval Civil Engineering Laboratory, Port Hueneme, CA, July 1961.*



## BIBLIOGRAPHY

- Anonymous, "Coast to Coast on Homemade Fuel," **The Mother Earth News** (No. 73) pp. 178-179 (January/February 1982).
- Anonymous, "Wood Gas Update," **The Mother Earth News** (No. 71) pp. 164-165 (September/October 1981).
- Anonymous, "Mother's Woodburning Truck," **The Mother Earth News** (No. 69) pp. 126-129 (May/June 1981).
- Chatterjee, A.K., *State of the Art Report on Pyrolysis of Wood and Agricultural Biomass*, PN-AAK-818, U.S. Department of Agriculture, Newark, NJ, March 1981.
- Cruz, I.E., *Producer-Gas Technology for Rural Applications*, published by the Food and Agriculture Organization of the United Nations, New York, NY, 1985.
- Donath, E.E., "Vehicle Gas Producers," **Processing Technology** (3) pp. 141-153 (1980).
- Eoff, K.M., and D.M. Post, "How to Power a Gasoline Engine with Wood," Technical Reprint No. 1, **The Mother Earth News**, Hendersonville, NC, 1981.
- Kaupp, A., and J.R. Goss, *State of the Art Report for Small Scale (to 50kW) Gas Producer-Engine Systems*, USDA Contract No. 53-319R-O-141, University of California, Davis, CA, March 1981.
- Miller, B., *State-of-the-Art Survey of Wood Gasification*, EPRI-AP-3101, Fred C. Hart Associates, Inc., Washington, DC, May 1983.
- Nygards, N., *Wood Gas Generator for Vehicles* (a translation of the Swedish book), published by Purwaco International, Minneapolis, MN, 1979.
- Oliver, E.D., *Technical Evaluation of Wood Gasification*, EPRI-AP-2567, Synthetic Fuels Association, Inc., Palo Alto, CA, August 1982.
- Reed, T.B. (ed), *A Survey of Biomass Gasification, Vol. I--Synopsis and Executive Summary*, SERI/TR-33-239 (Vol. I), Solar Energy Research Institute, Golden, CO, July 1979.
- Reed, T.B. (ed), *A Survey of Biomass Gasification, Vol. II--Principles of Gasification*, SERI/TR-33-239 (Vol. II), Solar Energy Research Institute, Golden, CO, July 1979.
- Reed, T.B. (ed), *A Survey of Biomass Gasification, Vol. III--Current Technology and Research*, SERI/TR-33-239 (Vol. III), Solar Energy Research Institute, Golden, CO, April 1980.
- Reed, T.B., and A. Das, *Handbook of Biomass Downdraft Gasifier Engine Systems*, SERI/SP-271-3022, Solar Research Institute, Golden, CO, March 1988.

Reed, T.B., and D. Jantzen, *Generator Gas: The Swedish Experience from 1939-1945* (a translation of the Swedish book, *Gengas*), SERI/SP-33-140, Solar Energy Research Institute, Golden, CO, January 1979.

Skov, N., and M.L. Papworth, *PEGASUS (Petroleum/Gasoline Substitute Systems)*, published by the Pegasus Publishing Co., Miami, FL, 1974.

Vietmeyer, N.L., et al., *Producer Gas: Another Fuel for Motor Vehicle Transport*, published by the National Academy Press, Washington, DC, 1983.

Wise, D.L. (ed.), *Fuel Gas from Biomass*, published by the CRC Press, Boca Raton, FL, 1981.

---

Construction Plans for Other Wood Gas Generator Units  
can be Purchased from the Following Organizations:

PEGASUS Publishing Co.  
1995 Keystone Blvd.  
Miami, FL 33181

Missouri Gasification Systems, Inc.  
Route 3, Box 198  
California, MO 65018

Mother's Plans  
The Mother Earth News  
P.O. Box 70  
Hendersonville, NC 28791

Nunnikhoven Industries  
P. O. Box 580  
Mediapolis, IA 52637

# Biofuels

## Table of Contents:

### [Overview: Biofuels.](#)

Growing it on the farm.

### [Biodiesel: Make Your Own Biodiesel](#)

*"Anybody can make biodiesel. It's easy, you can make it in your kitchen -- and it's BETTER than the petro-diesel fuel the big oil companies sell you. Your diesel motor will run better and last longer on your home-made fuel, and it's much cleaner -- better for the environment and better for health. If you make it from used oil it's not only cheap but you'll be recycling a troublesome waste product. Best of all is the GREAT feeling of freedom, independence and empowerment it will give you. Here's how to do it -- everything you need to know. "* (Quoted from: Journey to Forever)

### [SEALED Make Your Own Biodiesel](#)

This is the SEALED mirrored version of this site that won't be opened until after The Great Catastrophe.

### [SEALED Make Your Own Biodiesel -Page 2](#)

This is a second page of the above SEALED mirrored version of the above site that won't be opened until after The Great Catastrophe.

### [SEALED Foolproof Way to Make Biodiesel](#)

This particular page appears to be one of **SPECIAL** interest. Here it is still another SEALED mirrored page the original of which is linked from the above open site. This mirrored copy won't be opened until after The Great Catastrophe.

### [SEALED Using Straight Vegetable Oil](#)

This page is also one of **SPECIAL** interest. Here it is still another SEALED mirrored page the original of which is linked from the above open site. This mirrored copy won't

be opened until after The Great Catastrophe.

### [SEALED Separating Glycerine/FFAs](#)

And a final page from this link of some interest. Here it is still another SEALED mirrored page the original of which is linked from the above open site. This mirrored copy won't be opened until after The Great Catastrophe.

### [SEALED From the Fryer to the Fuel Tank](#)

This 1999 SEALED 172 page .pdf file won't be opened until after The Great Catastrophe. It is written by Joshua and Kaia Tickell and is available from Bookmasters P.O. Box 388 Ashland OH 44805 800-266-5564 or 419-281-18902 fax 419-281-6883 email: order@bookmaster.com

### [Seed Presses Pressing Oil from Seeds](#)

This 24 page .pdf file lists 56 oil bearing seeds and discusses a variety of methods for extraction and processing. These oils can be used either for food or fuel.

Click here to return to the  
[Individual Agricultural Recovery  
After Nuclear Holocaust](#)

---

## Making it on the Farm

RAPESEED, LINSEED, FLAXSEED, SUNFLOWERSEED, SESAMESEED, PEANUT, GROUNDNUTS, MUSTARDSEED, POPPY, COTTON SEED etc. are but a few of the seeds that have been suggested for making biofuel. There are also techniques that have used grasses, corn, and all sorts of other vegetable and biomass. Some techniques require stills which we cover elsewhere but perhaps you will find some simpler techniques and guidance in the material presented here.

Click here to return to the  
[Table of Contents](#)

**MENU: [HOME](#) » [Reconstruction](#) » [Recovery](#) » [Renewal](#) » [Energy Types](#)**

---

---

# Stills

## Table of Contents:

### [Overview: Stills.](#)

The problems of stills.

### [SEALED How Distillation Works](#)

This is a SEALED 8 page .pdf file explains the basic concepts. This site that won't be opened until after The Great Catastrophe.

### [SEALED Building a home still](#)

This is a SEALED 78 page .pdf file with lots of pictures. This site that won't be opened until after The Great Catastrophe.

### [LINK: Running on Alcohol](#)

This is the present open source for the mirrored copy that we have below.

### [SEALED Running on Alcohol](#)

This sealed site has three pages that can be linked from the open site above. This first one describes a small home still that the owner actually uses to provide fuel for a number of automobiles.

### [SEALED A Large Farm System](#)

This second sealed site describes a somewhat larger system that was built to produce fuel on a commercial basis.

### [SEALED Still Safety](#)

This third sealed site discusses safety aspects regarding stills.

### [SEALED Making It On The Farm](#)

This is another SEALED 182 page manual in .pdf that we purchased. This site won't be opened until after The Great Catastrophe.

[LINK: The Manual For the Home and Farm Production of Alcohol](#)

This is the present open source for the mirrored copy that we have below.

[SEALED The Manual For the Home and Farm Production of Alcohol](#)

This is a site SEALED mirror of the above source. This site won't be opened until after The Great Catastrophe. However, below is an overview of the chapters so that you can see its thoroughness AND also at this time you can go to the open site above.

## **Chapter 1 AN OVERVIEW**

- Alcohol Fuel
- Uses of Alcohol Fuel
- Other Alternative Fuels

## **Chapter 2 BASIC FUEL THEORY**

- Chemical Composition
- Combustion Properties
- Volatility
- Octane Ratings
- Water Injection
- Exhaust Composition
- Engine Performance - Straight Alcohol
- Engine Performance - Alcohol Blends

## **Chapter 3 UTILIZATION OF ALCOHOL FUELS**

- Methods of Utilization
- Alcohol Blends
- Pure Alcohol
- Diesel Engines
- Engine Modification
- Alcohol Injection

## **Chapter 4 ETHANOL PRODUCTION - GENERAL DISCUSSION**

- Raw Materials
- Manufacturing Steps
- Process Design

## **Chapter 5 PROCESSING STEPS COMMON TO ALL MATERIALS**

- Dilution
- Ph Control
- Backslopping

Cleanliness

Hydrometers

## **Chapter 6 PROCESSING STEPS SPECIFIC TO SACCHARINE MATERIALS**

General Description

Extraction

## **Chapter 7 PROCESSING STEPS SPECIFIC TO STARCHY MATERIALS**

Preparation of Starchy Materials

Milling

Cooking

Conversion

Malting

Premalting

Preparation of Malt

Enzyme Conversion

Acid Hydrolysis

Mash Cooling

## **Chapter 8 PROCESSING STEPS SPECIFIC TO CELLULOSE MATERIALS**

Cellulose Conversion

## **Chapter 9 YEAST AND FERMENTATION**

Yeast

Yeast Preparation

Fermentation

Fermentation By-products

Note of Caution

## **Chapter 10 INDIVIDUAL RAW MATERIALS**

Sugar/Starch Content vs Alcohol

Saccharine Materials

Fruits

Molasses

Cane Sorghum

Sugar Beets

Sugar Corn Wastes

Starchy Materials

Grains

Jerusalem Artichokes

Potatoes

Sweet Potatoes

Cellulose Materials

Multiple Enzyme Treatment

## **Chapter 11 DISTILLATION**

Distillation Theory

The Reflux Column

## **Chapter 12 DRYING THE ALCOHOL**

- General Description
- Absorption Methods
- Drying With Lime
- Azeotropic Methods

### **Chapter 13 MASHING AND FERMENTATION EQUIPMENT**

- General Discussion
- Batch Cooking and Mashing Equipment
- Fermentation Equipment

### **Chapter 14 DISTILLATION EQUIPMENT**

- Simple Reflux Column
- Condensers
- Boilers
- Reflux Control
- Hydrometer Sump
- Construction of a Reflux Column
- Operation of the Still
- Caution

### **Chapter 15 SOLAR STILLS**

- General Discussion
- Principle of Operation
- Construction of Solar Stills

### **Chapter 17 PUTTING IT ALL TOGETHER**

- Large And Small Systems
- Very Small
- Small
- Medium
- Large
- Considerations

### **Chapter 18 THE FUTURE**

- Present Technology
- New Technology
- Immobilized Enzymes
- Cellulose Conversion
- Alternatives To Distillation
- Biological Research
- Conclusion

---

## **The Problem of Stills**

I am personally a teetotaler and totally opposed to the use of alcohol as a recreational drink. Still alcohol



does have its medicinal purposes and can also be used as an antiseptic and as a aesthetic. In fact in may be about the only aesthetic available until the production of ether can be established.

Here we are principally talking about the use of stills for making fuel. With all the surplus rotting potatoes in the area we would have liked to make a still and produce fuel for our diesel generators. But, presently, there is a \$100,000 annual fine (license) for doing so. We will simply have to wait for a more propitious time.

The building and operation of a still takes some skill but it is not what we would call a high-tech operation. After all, the skill is most often identified with hillbilly moonshine makers. The designs here will at least demonstrate the principles involved. It may be largely a matter of scale to get up to larger volumes needed for fuel.

Click here to return to the  
[Table of Contents](#)

**MENU: [HOME](#) » [Reconstruction](#) » [Recovery](#) » [Renewal](#) » [Energy Types](#)**

---

---

# Solar Energy

## Table of Contents:

### [Overview: Solar Energy.](#)

What works and what doesn't.

### [Cooking: An overall survey of solar cookers.](#)

This is an online overall survey of solar cookers that ties into the next two explanations.

### [SEALED: Overall survey of Solar Cookers.](#)

The SEALED version of the of the above site. This file will not be opened until after the nuclear war.

### [Cooking 2: An overall survey of BOX solar cookers.](#)

Because there are so many different designs of solar cookers the information referenced here has been narrowed to what seemed most applicable to the anticipated immediate needs of nuclear survivors.

### [SEALED: An overall survey of BOX solar cookers.](#)

The SEALED version of the of the above site. This file will not be opened until after the nuclear war.

### [Cooking 3: A very simple design.](#)

This is a detailed explanation about one exceptionally simple design. With more time and resources one will probably wish to consider one of the other designs in the links above. This design, however, has the additional advantage in that it is very portable.

### [SEALED: A very simple design.](#)

The SEALED version of the of the above site. This file will not be opened until after the nuclear war.

### [Hotwater 1: Make it with the sun even in cold climates.](#)

This SEALED 9 page .pdf file is about a closed anti-freeze system. This file will not be opened until after the nuclear war.

**[Hotwater 2: Build Your Own Solar Water Heater.](#)**

This SEALED 118 page .pdf file is much more detailed. This file will not be opened until after the nuclear war.

**[Hotwater 3: Solar Hotwater Heating - A DIY Guide.](#)**

This SEALED 31 page .pdf file is another system. It is always good to get a variety of ideas and explanations. This file will not be opened until after the nuclear war.

---

## Solar Overview

After a nuclear war, solar power for making electricity is probably not going to be an option unless one happens to find some salvagable solar panels. I obtained books on the subject of making "hobbyist" solar panels and they are so terribly inefficient that it is just not a practical way to go at all. Solar panels operate only during daytime, on days that are not cloudy, and in locations near enough to the equator that you don't get low sun angles and long nights. Consequently commercial solar panels presently have a payout of about a hundred years which means, given interest rates, the value of money, the life expectancy of the panels themselves, and human life expectancy - they just are not a practical way to go in most situations. They have application for some small power requirements in very remote locations but that is about it in many parts of the world. In outerspace with 24 hour sunlight they may be the cat's meow - but nothing that we need to concern ourselves about in a nuclear recovery situation.

Still, sunlight is a great power source for stills, solar cookers and as a means of heating water. Those are the applications that are treated here.

Click here to return to the  
[Table of Contents](#)

**MENU: [HOME](#) » [Reconstruction](#) » [Recovery](#) » [Renewal](#) » [Energy Types](#)**

---

---

# Simple Technology

## Table of Contents:

Some of the information regarding Simplified Technology is presently in locked files because it is copyrighted information. The concept behind putting it on this site in that manner is to gather the information now and to archive it in a form that may possibly be disseminated later. Some of the information here could as well as have gone under farming or pioneering skills. There is so much information about using bicycles, that while they might have gone under simple machines, they have gotten a category of their own. The same applies to windmills and waterwheels. Some of the decisions as where to put information have been arbitrary but there is just too much to put it all under one category, so the reader needs to look under all the categories when studying the subject.

### [Basic Machines: The Basic Principles of Machinery](#)

This 168 page .pdf book is open and available for downloading NOW. It covers levers, block and tackle, plane and wedge, and on up through hydraulic devices, and internal combustion engines, and more.

### [Simple Machines: Descriptions of Simple Machines](#)

This 81 page .pdf book from MIT explains how to build dozens of primitive machines, drills, lathes, pumps, and all sorts of other useful devices. Currently a locked file because of copyright.

### [Farm Devices: Patterns for Simple Farm Devices](#)

This 150 page .pdf book shows how farmers built their own devices in the 1700s and 1800s (and for perhaps centuries earlier). Practical ideas that are still used today.

### [Scythes: A tool of the centuries](#)

This 63 page .pdf copyrighted and presently sealed book covers one of the most basic and essential tools of the centuries. Along with ax, hoe, hammer and shovel, it has been essential to the establishment of civilization. Largely displaced by modern harvesting methods it is a technology that may need to be at least temporarily "recovered".

### [Blacksmithing: An essential technology](#)

This 132 page .pdf copyrighted and presently sealed book covers an essential technology that may have to be recovered. About a hundred years ago every village would have one or more blacksmiths, but then the

skill largely disappeared except as retained by farriers (horse shoeing is another subject) and some ornamental artists.

*[Regulator:](#)* [How to build your own alternator regulator](#)

*[SEALED:](#)* [How to build your own alternator regulator](#)

This is the SEALED mirrored version of this site that won't be opened until after The Great Catastrophe. The above open link is to the original Forcefield Site.

*[Float Switch:](#)* [How to build a float switch](#)

*[SEALED:](#)* [How to build a float switch](#)

This is the SEALED mirrored version of this site that won't be opened until after The Great Catastrophe. The above open link is to the original Forcefield Site.

*[Propane Conversion:](#)* [How to do a gas to propane conversion](#)

*[SEALED:](#)* [How to do a gas to propane conversion](#)

This is the SEALED mirrored version of this site that won't be opened until after The Great Catastrophe. The above open link is to the original Forcefield Site.

*[LED Conversion:](#)* [How to convert flashlights to use LEDs](#)

*[SEALED:](#)* [How to convert flashlights to use LEDs](#)

This is the SEALED mirrored version of this site that won't be opened until after The Great Catastrophe. The above open link is to the original Forcefield Site.

Click here to return to the  
[Overview Table of Contents](#)

**MENU: [HOME](#) » [Reconstruction](#) » [Recovery](#) » [Renewal](#) » [Survival](#)**

---

---

# **BASIC MACHINES AND HOW THEY WORK**

Prepared by Bureau of  
Naval Personnel

Dover Publications, Inc.  
New York

Published in Canada by General Publishing Company, Ltd., 30 Lesmill Road, Don Mills, Toronto, Ontario.

Published in the United Kingdom by Constable and Company, Ltd., 10 Orange Street, London WC 2.

This Dover edition, first published in 1971, is an unabridged and unaltered republication of the work originally published by the United States Government Printing Office in 1965, under the title: *Basic Machines*. This work was prepared by the Bureau of Naval Personnel, Department of the Navy, as Navy Training Course NAVPERS 10624-A.

*International Standard Book Number: 0-486-21709-4*  
*Library of Congress Catalog Card Number: 77-153739*

Manufactured in the United States of America  
Dover Publications, Inc.  
180 Varick Street  
New York, N. Y. 10014

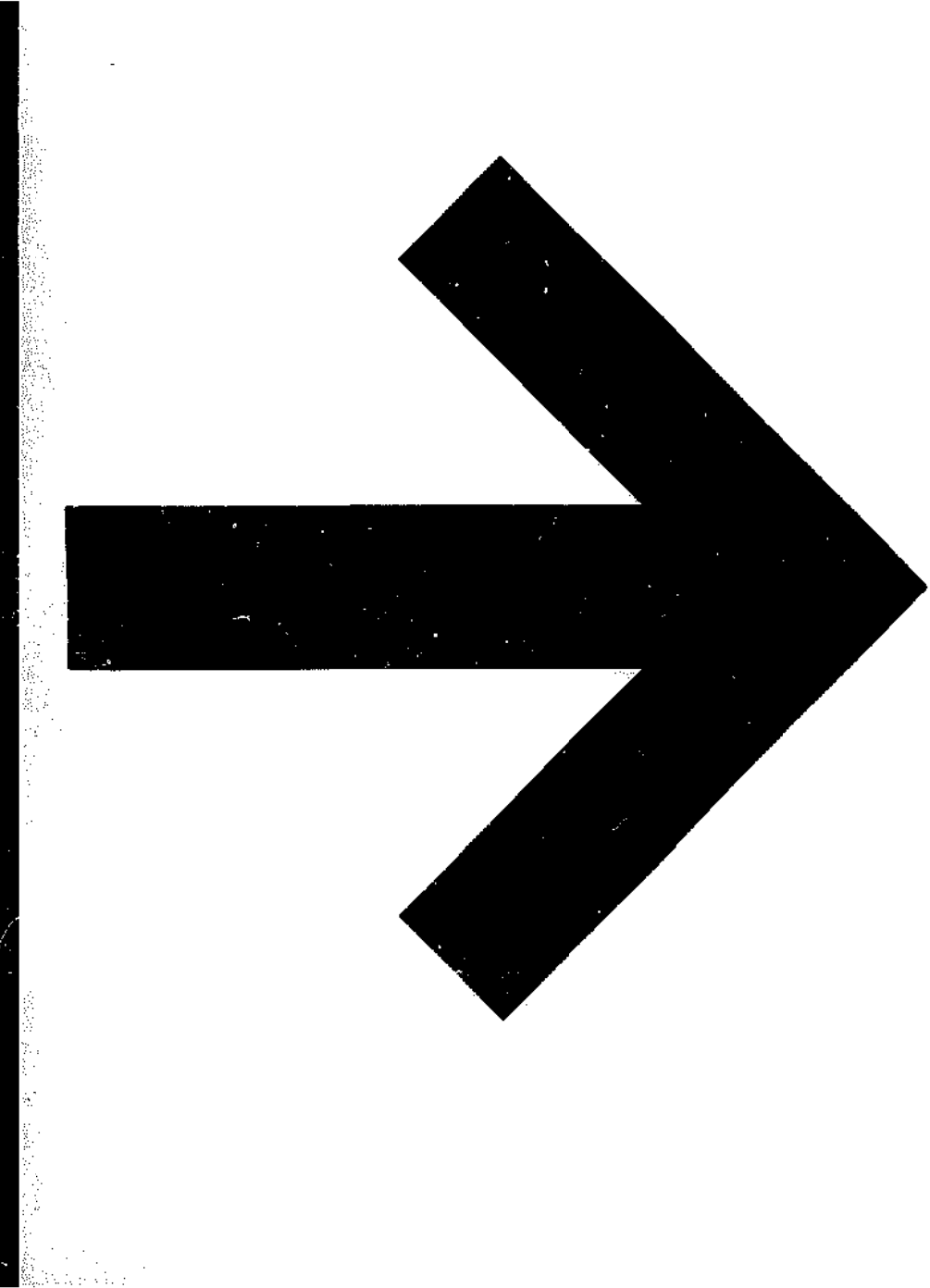
## PREFACE

Basic Machines is written as a reference for the enlisted men in the Navy whose duties require knowledge of the fundamentals of machinery.

Beginning with the simplest of machines—the lever—the book proceeds with the discussion of block and tackle, wheel and axle, inclined plane, screw and gears. It explains the concepts of work and power, and differentiates between the terms "force" and "pressure." The fundamentals of hydrostatic and hydraulic mechanisms are discussed in detail. The final chapters include several examples of the combination of simple mechanisms to make complex machines.

As one of several basic Navy Training Courses, this book was prepared by the Education and Training Support Service, Washington, D.C., for the Chief of Naval Personnel.





## CONTENTS

CHAPTER	Page
1. Levers . . . . .	1
2. Block and Tackle . . . . .	10
3. The Wheel and Axle . . . . .	16
4. The Inclined Plane and Wedge . . . . .	23
5. The Screw . . . . .	26
6. Gears . . . . .	30
7. Work . . . . .	39
8. Power . . . . .	46
9. Force and Pressure . . . . .	50
10. Hydrostatic and Hydraulic Machines . . . . .	58
11. Machine Elements and Basic Mechanisms . . . . .	69
12. Complex Machines . . . . .	87
13. Internal Combustion Engine . . . . .	106
14. Power Trains . . . . .	130
15. Basic Computer Mechanisms . . . . .	150
INDEX . . . . .	158

## CREDITS

<u>Source</u>	<u>Figures</u>
Underwood Corporation	Figure 12-4 through Figure 12-16
U. S. Naval Institute: Naval Auxiliary Machinery Naval Turbines	Figure 9-6 Figure 11-2

## CHAPTER 1

# LEVERS

### YOUR HELPERS

Ships have evolved through the ages from crude rafts to the huge complex cruisers and carriers of today's Navy. It was a long step from oars to sails, and another long step from sails to steam. With today's modern nuclear-powered ships another long step has been taken. Each step in the progress of shipbuilding has involved the use of more and more machines, until today's Navy men are specialists in operating and maintaining machinery. The Boatswain operates the winches to hoist cargo and the anchor; the men in the engine room operate pumps, valves, generators, and other machines to produce and control the ship's power; men in the weapons department operate shell hoist, and rammers; elevate and train the guns and missile launchers; the cooks operate mixers and can openers; men in the CB rates drive trucks, operate cranes, graders, and bulldozers. In fact it is safe to say every rate in the Navy uses machinery some time during the day's work.

Each machine used aboard ship has made the physical work load of the crew lighter. You don't walk the capstan to raise the anchor, or heave on a line to sling cargo aboard. Machines have taken over these jobs, and have simplified and made countless others easier. Machines are your friends. They have taken much of the backache and drudgery out of a sailor's life. Reading this book should help you recognize and understand the operations of many of the machines you see about you.

### WHAT IS A MACHINE?

As you look about you, you probably see half a dozen machines that you don't recognize as such. Ordinarily you think of a machine as a complex device—a gasoline engine or a typewriter. They are machines, but so is a

hammer, a screwdriver, a ship's wheel. A machine is any device that helps you to do work. It may help by changing the amount of the force or the speed of action. For example, a claw hammer is a machine—you can use it to apply a large force for pulling out a nail. A relatively small pull on the handle produces a much greater force at the claws.

We use machines to TRANSFORM energy. For example, a generator transforms mechanical energy into electrical energy. We use machines to TRANSFER energy from one place to another. For example, the connecting rods, crankshaft, drive shaft, and rear axle transfer energy from the automobile engine to the rear wheels.

Another use of machines is to MULTIPLY FORCE. We use a system of pulleys (a chain hoist for example) to lift a heavy load. The pulley system enables us to raise the load by exerting a force which is smaller than the weight of the load. We must exert this force over a greater distance than the height through which the load is raised; thus, the load moves more slowly than the chain on which we pull. A machine enables us to gain force, but only at the expense of speed.

Machines may also be used to MULTIPLY SPEED. The best example of this is the bicycle, by which we gain speed by exerting a greater force.

Machines are also used to CHANGE THE DIRECTION OF A FORCE. For example, the signalman's halyard enables one end of the line to exert an upward force on a signal flag as a downward force is exerted on the other end.

There are only six simple machines—the LEVER, the BLOCK, the WHEEL and AXLE, the INCLINED PLANE, the SCREW, and the GEAR. However, physicists recognize that there are only two basic principles in machines; namely, the lever and the inclined plane. The wheel and

axle, the block and tackle, and gears may be considered levers. The wedge and the screw use the principle of the inclined plane.

When you are familiar with the principles of these simple machines, you can readily understand the operation of complex machines. Complex machines are merely combinations of two or more simple machines.

**THE LEVER**

The simplest machine, and perhaps the one with which you are most familiar, is the LEVER. A seasaw is a familiar example of a lever in which one weight balances the other.

There are three basic parts which you will find in all levers; namely, the FULCRUM (F), a force or EFFORT (E), and a RESISTANCE (R). Look at the lever in figure 1-1. You see the pivotal point F (fulcrum); the EFFORT (E) which you apply at a distance A from the fulcrum; and a resistance (R) which acts at a distance a from the fulcrum. Distances A and a are the lever arms.

**CLASSES OF LEVERS**

The three classes of levers are shown in figure 1-2. The location of the fulcrum (the fixed or pivot point) with relation to the resistance (or weight) and the effort determines the lever class.

**First-Class Levers**

In the first-class lever (fig. 1-2A), the fulcrum is located between the effort and the resistance. As mentioned earlier, the seasaw is a good example of the first-class lever.

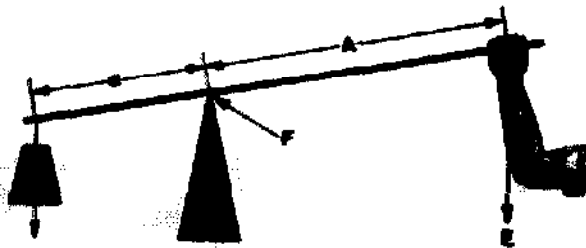


Figure 1-1.—A simple lever.

191.1

The amount of weight and the distance from the fulcrum can be varied to suit the need. Another good example is the oars in a row-boat. Notice that the sailor in figure 1-3 applies his effort on the handles of the oars. The oarlock acts as the fulcrum, and the water acts as the resistance to be overcome. In this case, as in figure 1-1, the force is applied on one side of the fulcrum and the resistance to be overcome is applied to the opposite side, hence this is a first-class lever. Crowbars, shears, and pliers are common examples of this class of lever.

**Second-Class Levers**

The second-class lever (fig. 1-2B) has the fulcrum at one end; the effort is applied at the other end. The resistance is somewhere between these points. The wheelbarrow in figure 1-4 is a good example of a second-class lever. If you apply 50 pounds of effort to the handles of a wheelbarrow 4 feet from the fulcrum (wheel), you can lift 200 pounds of weight 1 foot from the fulcrum. If the load were placed farther back away from the wheel, would it be easier or harder to lift?

Both first- and second-class levers are commonly used to help in overcoming big resistances with a relatively small effort.

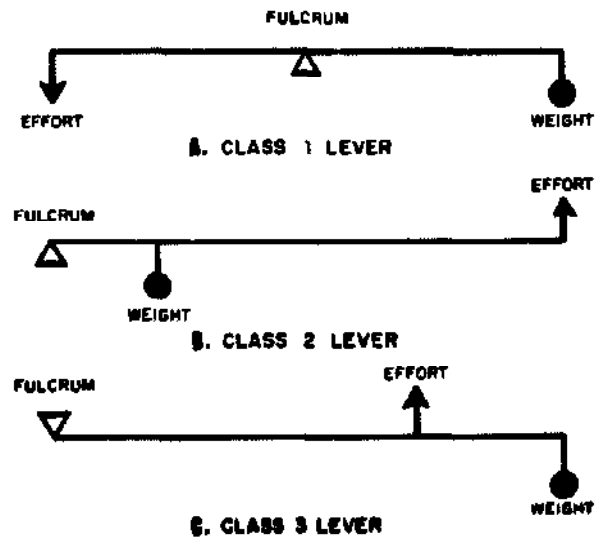


Figure 1-2.—Three classes of levers.

5.30

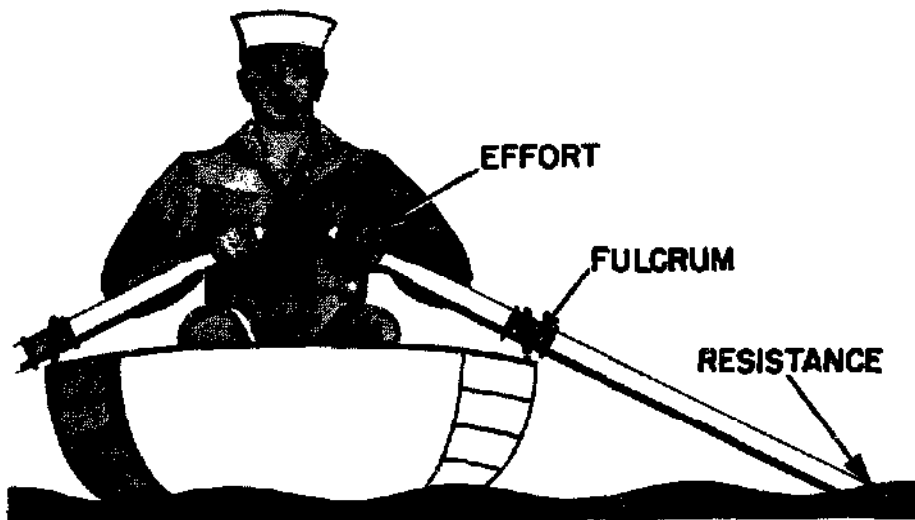


Figure 1-3.—Oars are levers.

131.2

### Third-Class Levers

There are occasions when you will want to speed up the movement of the resistance even though you have to use a large amount of effort. Levers that help you accomplish this are third-class levers. As shown in figure 1-2C, the fulcrum is at one end of the lever and the weight or resistance to be overcome is at the

other end, with the effort applied at some point between the fulcrum and the resistance. You can always spot third-class levers because you will find the effort applied between the fulcrum and the resistance. Look at figure 1-5. It is easy to see that while point E is moving the short distance  $e$ , the resistance R has been moved a greater distance  $r$ . The speed of R must have been greater than that of E, since R covered a greater distance in the same length of time.

Your arm (fig. 1-6), is a third-class lever. It is this lever action that makes it possible for you to flex your arms so quickly. Your elbow is the fulcrum. Your biceps muscle,

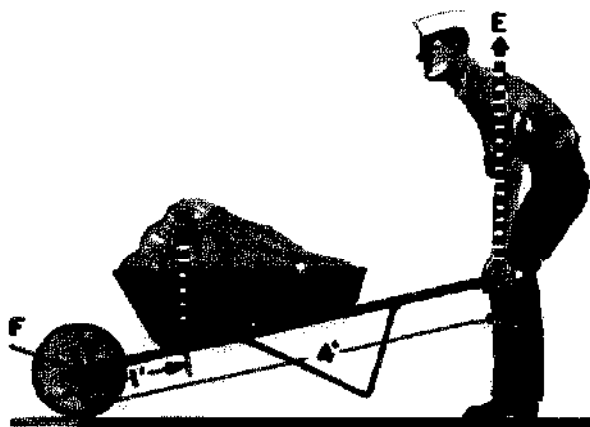


Figure 1-4.—This makes it easier.

131.3

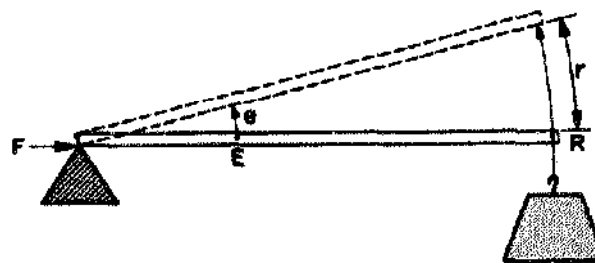


Figure 1-5.—A third-class lever.

131.4

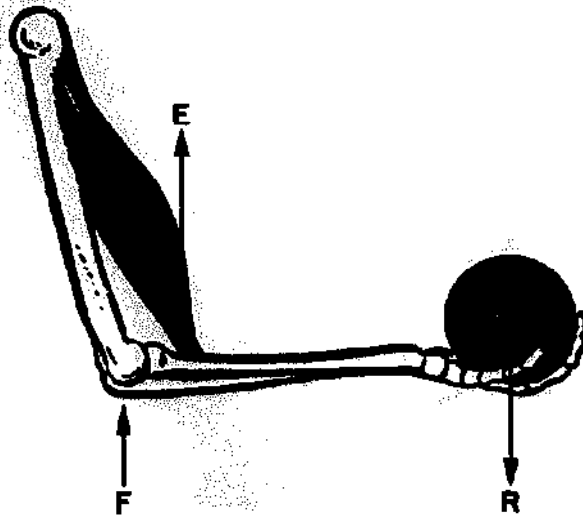


Figure 1-6.—Your arm is a lever.

131.5

which ties onto your forearm about an inch below the elbow, applies the effort; and your hand is the resistance, located some 18 inches from the fulcrum. In the split second it takes your biceps muscle to contract an inch, your hand has moved through an 18-inch arc. You know from experience that it takes a big pull at E to overcome a relatively small resistance at R. Just to remind yourself of this principle, try closing a door by pushing on it about three or four inches from the hinges (fulcrum). The moral is, you don't use third-class levers to do heavy jobs, you use them to gain speed.

One convenient thing about machines is that you can determine in advance the forces required for their operation, as well as the forces they will exert. Consider for a moment the first-class lever. Suppose you have an iron bar, like the one shown in figure 1-7. This bar is 9 feet long, and you want to use it to raise a 300-pound crate off the deck while you slide a dolly under the crate. But you can exert only 100 pounds to lift the crate. So you place the fulcrum—a wooden block—beneath one end of the bar, and force that end of the bar under the crate. Then you push down on the other end of the bar. After a few adjustments of the position of the fulcrum, you will find that your 100-pound force will just fit the crate when the fulcrum is 2 feet from center of the crate.

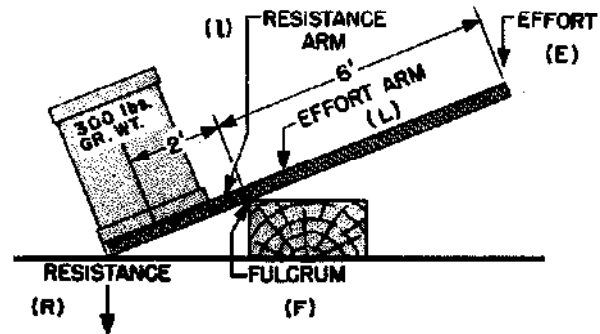


Figure 1-7.—Easy does it.

110.4

This leaves a 6-foot length of bar from the fulcrum to the point where you push down. The 6-foot portion is three times as long as the distance from the fulcrum to the center of the crate. But you lifted a load three times as great as the force you applied— $3 \times 100 = 300$  pounds. Here is an indication of a direct relationship between lengths of lever arms and forces acting on those arms.

You can state this relationship in general terms by saying—the length of the effort arm is the same number of times greater than the length of the resistance arm as the resistance to be overcome is greater than the effort you must apply. Writing these words as a mathematical equation, it looks like this—

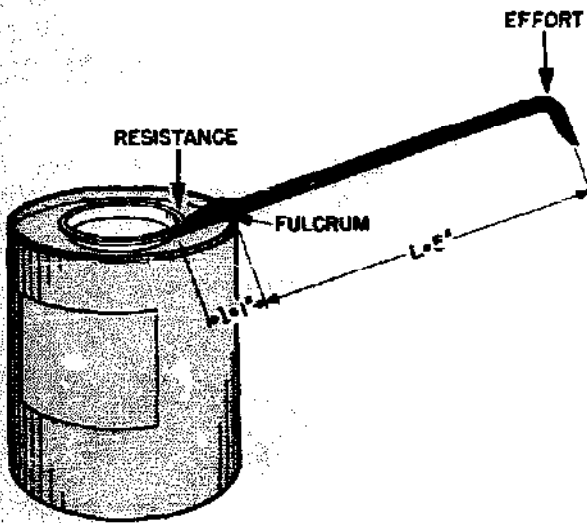
$$\frac{L}{l} = \frac{R}{E}$$

in which,

- L = length of effort arm.
- l = length of resistance arm.
- R = resistance weight or force.
- E = effort force.

Remember that all distances must be in the same units—such as feet, and all forces must be in the same units—such as pounds.

Now take another problem and see how it works out. Suppose you want to pry up the lid of a paint can (fig. 1-8) with a 6-inch file scraper, and you know that the average force holding the lid is 50 pounds. If the distance from the edge of the paint can to the edge of



131.6

Figure 1-8.—A first-class job.

the cover is one inch, what force will you have to apply on the end of the file scraper?

According to the formula:

$$\frac{L}{l} = \frac{R}{E}$$

Here  $L = 5$  inches;  $l = 1$  inch;  $R = 50$  pounds, and  $E$  is unknown.

Substitute the numbers in their proper places, Then,

$$\frac{5}{1} = \frac{50}{E}$$

and

$$E = \frac{50 \times 1}{5} = 10 \text{ pounds}$$

You will need to apply a force of only 10 pounds.

The same general formula applies for second-class levers. But you must be careful to measure the proper lengths of the effort arm and the resistance arm. Looking back at the wheelbarrow problem, assume that the length of the handles from the axle of the wheel—which is the fulcrum—to the grip is 4 feet. How long is the effort arm? You're right, it's 4 feet. If the center of the load of sand is 1 foot from

the axle, then the length of the resistance arm is 1 foot.

By substituting in the formula,

$$\frac{L}{l} = \frac{R}{E}$$

$$\frac{4}{1} = \frac{200}{E}$$

and

$$E = 50 \text{ lb.}$$

Now for the third-class lever. With one hand, you lift a projectile weighing approximately 10 pounds. If your biceps muscle attaches to your forearm 1 inch below your elbow, and the distance from the elbow to the palm of your hand is 18 inches, what pull must your muscle exert in order to hold the projectile and flex your arm at the elbow?

By substituting in the formula,

$$\frac{L}{l} = \frac{R}{E}, \text{ it becomes } \frac{1}{18} = \frac{10}{E}$$

and

$$E = 18 \times 10 = 180 \text{ lb.}$$

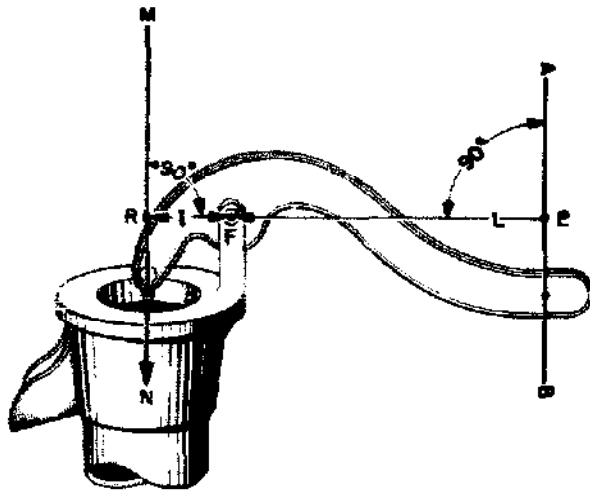
Your muscle must exert a 180-pound pull to hold up a 10-pound shell. Our muscles are poorly arranged for lifting or pulling—and that's why some work seems pretty tough. But remember, third-class levers are used primarily to speed up the motion of the resistance.

#### Curved Lever Arms

Up to this point you have been looking at levers with straight arms. In every case, the direction in which the resistance acts is parallel to the direction in which the effort is exerted. However, all levers are not straight. You'll need to learn to recognize all types of levers, and to understand their operation.

Look at figure 1-9. You may wonder how to measure the length of the effort arm, which is represented by the curved pump handle. You do not measure around the curve—you still use a straight-line distance. To determine the length of the effort arm, draw a straight line AB through the point where the effort is applied and in the direction that it is applied. From point E on this line, draw a second line EF that passes through the fulcrum and is perpendicular to line AB. The length of the line EF is the actual length L of the effort arm.





131.7

Figure 1-9.—A curved lever arm.

To find the length of the resistance arm, use the same method. Draw a line MN in the direction that the resistance is operating, and through the point where the resistance is attached to the other end of the handle. From point R on this line, draw a line RF perpendicular to MN so that it passes through the fulcrum. The length of RF is the length l of the resistance arm.

Regardless of the curvature of the handle, this method can be used to find the lengths L and l. Then curved levers are solved just like straight levers.

### MECHANICAL ADVANTAGE

There is another thing about first-class and second-class levers that you have probably noticed by now. Since they can be used to magnify the applied force, they provide positive mechanical advantages. The third-class lever provides what's called a fractional mechanical advantage, which is really a mechanical disadvantage—you use more force than the force of the load you lift.

In the wheelbarrow problem, you saw that a 50-pound pull actually overcame the 200-pound weight of the sand. The sailor's effort was magnified four times, so you may say that the mechanical advantage of the wheelbarrow is

4. Expressing the same idea in mathematical terms,

$$\text{MECHANICAL ADVANTAGE} = \frac{\text{RESISTANCE}}{\text{EFFORT}}$$

or

$$M. A. = \frac{R}{E}$$

Thus, in the case of the wheelbarrow,

$$M.A. = \frac{200}{50} = 4$$

This rule applies to all machines.

Mechanical advantage of levers may also be found by dividing the length of the effort arm A by the length of the resistance arm a. Stated as a formula, this reads:

$$\text{MECHANICAL ADVANTAGE} = \frac{\text{EFFORT ARM}}{\text{RESISTANCE ARM}}$$

$$M. A. = \frac{A}{a}$$

How does this apply to third-class levers? Your muscle pulls with a force of 1,800 pounds in order to lift a 100-pound projectile. So you

have a mechanical advantage of  $\frac{100}{1,800}$  or  $\frac{1}{18}$ , which is fractional—less than 1.

### SUMMARY

Now for a brief summary of levers.

Levers are machines because they help you to do your work. They help by changing the size, direction, or speed of the force you apply.

There are three classes of levers. They differ primarily in the relative points where effort is applied, where the resistance is overcome, and where the fulcrum is located.

First-class levers have the effort and the resistance on opposite sides of the fulcrum, and effort and resistance move in opposite directions.

Second-class levers have the effort and the resistance on the same side of the fulcrum, but the effort is farther from the fulcrum than is the resistance. Both effort and resistance move in the same direction.

Third-class levers have the effort applied on the same side of the fulcrum as the resistance, but the effort is applied between the resistance and the fulcrum. Both move in the same direction.

First- and second-class levers can be used to magnify the amount of the effort exerted, and to decrease the speed of effort. First-class and third-class levers can be used to magnify the distance and the speed of the effort exerted, and to decrease its magnitude.

The same general formula applies to all three types of levers:

$$\frac{L}{l} = \frac{R}{E}$$

**MECHANICAL ADVANTAGE (M.A.)** is an expression of the ratio of the applied force and the resistance. It may be written:

$$M. A. = \frac{R}{E}$$

#### APPLICATIONS AFLOAT AND ASHORE

Doors aboard a ship are locked shut by lugs called dogs. Figure 1-10 shows you how these dogs are used to secure the door. If the handle is four times as long as the lug, that 50-pound heave of yours is multiplied to 200 pounds against the slanting face of the wedge. Incidentally, take a look at that wedge—it's an inclined plane, and it multiplies the 200-pound

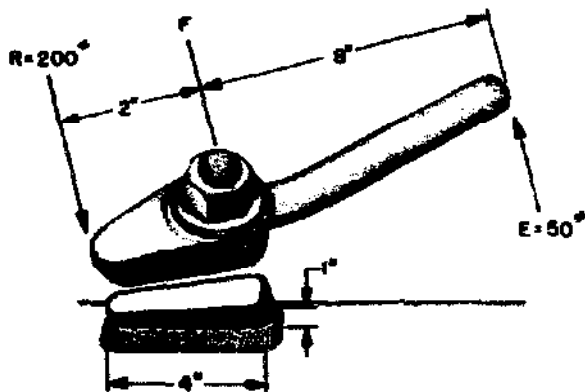


Figure 1-10.—It's a dog.

3.100

force by about four. Result—your 50-pound heave actually ends up as an 800-pound force on each wedge to keep the hatch closed! The hatch dog is one use of a first-class lever, in combination with an inclined plane.

The breech of a big gun is closed with a breech plug. Figure 1-11 shows you that this plug has some interrupted screw threads on it which fit into similar interrupted threads in the breech. Turning the plug part way around locks it into the breech. The plug is locked and unlocked by the operating lever. Notice that the connecting rod is secured to the operating lever a few inches from the fulcrum. You'll see that this is an application of a second-class lever!

You know that the plug is in there good and tight. But, with a mechanical advantage of ten, your 100-pound pull on the handle will twist the plug loose with a force of a half-ton.

If you've spent any time opening crates at a base, you've already used a wrecking bar. The blue-jacket in figure 1-12 is busily engaged in tearing that crate open. The wrecking bar is a first-class lever. Notice that it has curved lever arms. Can you figure the mechanical advantage of this one? Your answer should be M. A. = 5.

The crane in figure 1-13 is used for handling relatively light loads around a warehouse or a dock. You can see that the crane is rigged as a third-class lever. The effort is applied between the fulcrum and the load. This gives a mechanical advantage of less than one. If it's going to support that 1/2 ton load, you know that the pull on the lifting cable will have to be considerably greater than 1000 pounds. How much greater? Use the formula, and figure it out—

$$\frac{L}{l} = \frac{R}{E}$$

Got the answer? Right—E=1,333 lb. Now, because the cable is pulling at an angle of about 22° at E, you can use some trigonometry to find that the pull on the cable will be about 3,560 pounds to lift the 1/2-ton weight! However, since the loads are generally light, and speed is important, it is a practical and useful machine.

Anchors are usually housed in the hawsepipes and secured by a chain stopper. The chain

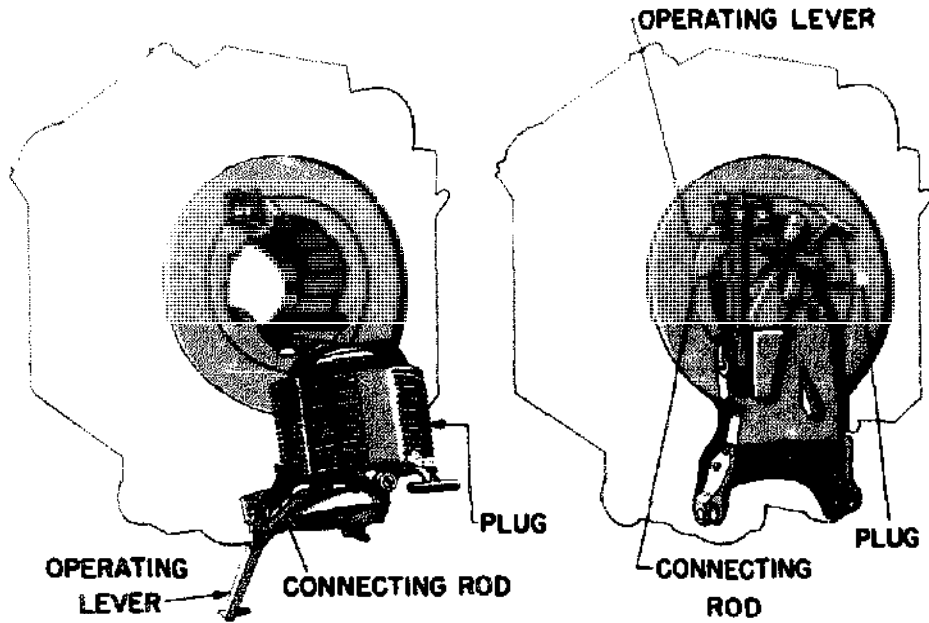


Figure 1-11.—An 8-inchers breech.

80.213:214

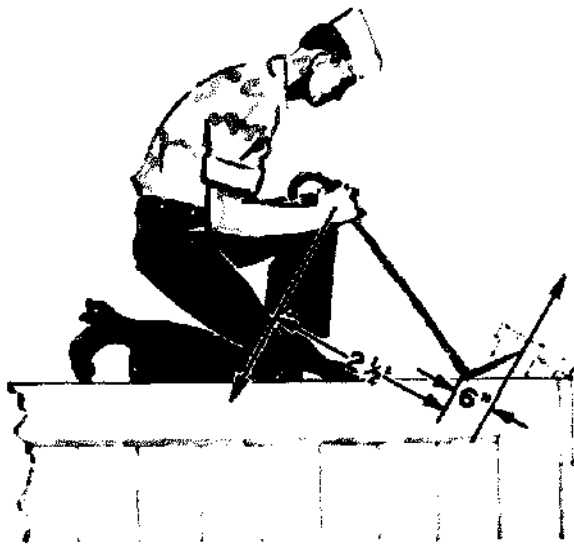


Figure 1-12.—Using a wrecking bar. 131.8

stopper consists of a short length of chain containing a turnbuckle and a pelican hook. When you secure one end of the stopper to a pad eye in the deck and lock the pelican hook over the anchor chain, the winch is relieved of the strain.

Figure 1-14A gives you the details of the pelican hook.

Figure 1-14B shows the chain stopper as a whole. Notice that the load is applied close

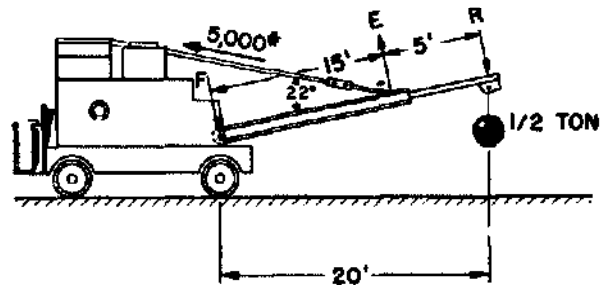
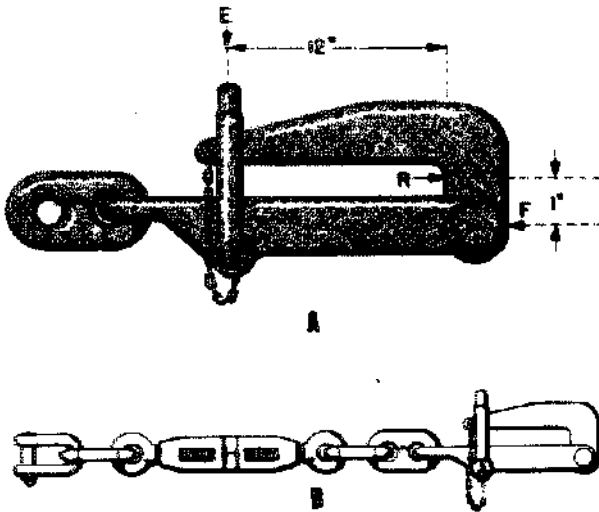


Figure 1-13.—An electric crane. 131.9



3.223

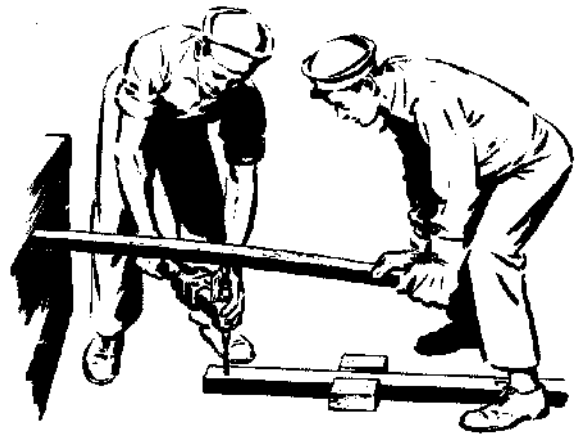
Figure 1-14.—A. A pelican hook;  
B. A chain stopper.

to the fulcrum. The resistance arm  $a$  is very short. The bale shackle, which holds the hook secure, exerts its force at a considerable distance  $A$  from the fulcrum. If the chain rests against the hook one inch from the fulcrum, and the bale shackle is holding the hook closed  $12 + 1 = 13$  inches from the fulcrum, what's the mechanical advantage? It's 13. A strain of only 1,000 pounds on the base shackle can hold the hook closed when a  $6\frac{1}{2}$ -ton anchor is dangling over the ship's side. You'll recognize

the pelican hook as a second-class lever with curved arms.

Figure 1-15 shows you a couple of guys who are using their heads to spare their muscles. Rather than exert themselves by bearing down on that drill, they pick up a board from a nearby crate and use it as a second-class lever.

If the drill is placed half way along the board, they will get a mechanical advantage of two. How would you increase the mechanical advantage if you were using this rig? Right. You move the drill in closer to the fulcrum. In the Navy, a knowledge of levers and how to apply them pays off.



131.10

Figure 1-15.—An improvised drill press.

## CHAPTER 2

# BLOCK AND TACKLE

Blocks—pulleys to a landlubber—are simple machines that have many uses aboard ship, as well as on shore. Remember how your mouth hung open as you watched movers taking a piano out of a fourth story window? The fat guy on the end of the tackle eased the piano safely to the sidewalk with a mysterious arrangement of blocks and ropes. Or perhaps you've been in the country and watched the farmer use a block-and-tackle to put hay in a barn. Since old Dobbin or the tractor did the hauling, there was no need for a fancy arrangement of ropes and blocks. Incidentally, you'll often hear the rope or tackle called the fall. Block-and-tackle, or block-and-fall.

In the Navy you'll rig a block-and-tackle to make some of your work easier. Learn the names of the parts of a block. Figure 2-1 will give you a good start on this. Look at the single block and see some of the ways you can use it. If you lash a single block to a fixed object—an overhead, a yardarm, or a bulkhead—you give yourself the advantage of being able to pull from a convenient direction. For example, in figure 2-2 you haul up a flag hoist, but you really pull down. You can do this by having a single sheaved block made fast to the yardarm. This makes it possible for you to stand in a convenient place near the flag bag and do the job. Otherwise you would have to go aloft, dragging the flag hoist behind you.

### MECHANICAL ADVANTAGE

With a single fixed sheave, the force of your down-pull on the fall must be equal to the weight of the object being hoisted. You can't use this rig to lift a heavy load or resistance with a small effort—you can change only the direction of your pull.

A single fixed block is really a first-class lever with equal arms. The arms EF and FR in figure 2-3 are equal; hence the mechanical advantage is one. When you pull down at A with a force of one pound, you raise a load of one pound at B. A single fixed block does not magnify force nor speed.

You can, however, use a single block-and-fall to magnify the force you exert. Notice, in figure 2-4 that the block is not fixed, and that the fall is doubled as it supports the 200-pound cask. When rigged this way, a single block-and-fall is called a runner. Each half of the fall carries one half of the total load, or 100 pounds. Thus, by the use of the runner, the bluejacket is lifting a 200-pound cask with a 100-pound pull. The

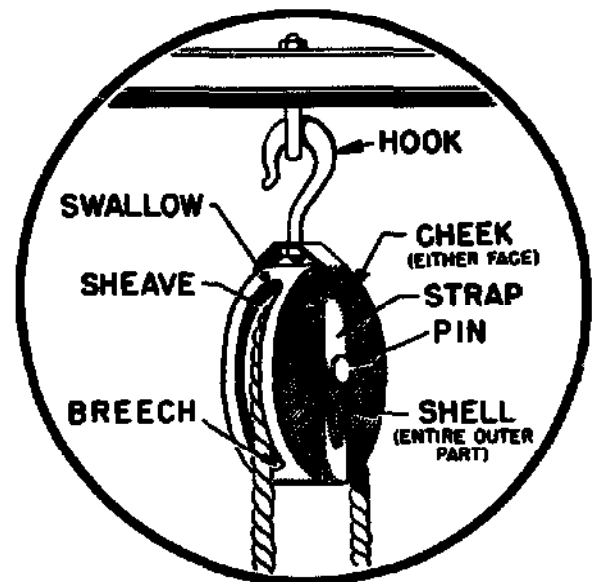


Figure 2-1.—Look it over.

29.184

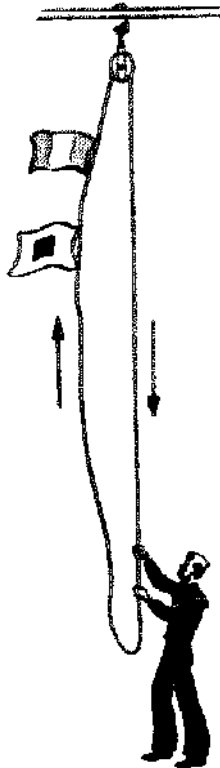


Figure 2-2.—A flag hoist.

69.122

mechanical advantage is two. Check this by the formula:

$$M. A. = \frac{R}{E} = \frac{200}{100}, \text{ or } 2$$

The single movable block in this setup is really a second-class lever. See figure 2-5. Your effort *E* acts upward upon the arm *EF*, which is the diameter of the sheave. The resistance *R* acts downward on the arm *FR*, which is the radius of the sheave. Since the diameter is twice the radius, the mechanical advantage is two.

But, when the effort at *E* moves up two feet, the load at *R* is raised only one foot. That's one thing to remember about blocks and falls—if you are actually getting a mechanical advantage from the system, the length of rope that passes through your hands is greater than the distance

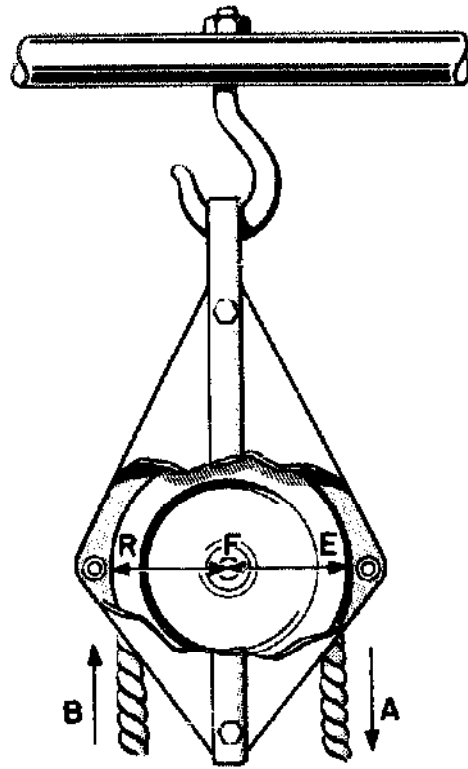


Figure 2-3.—No advantage.

29.187

that the load is raised. However, if you can lift a big load with a small effort, you don't care how much rope you have to pull.

The bluejacket in figure 2-4 is in an awkward position to pull. If he had another single block handy, he could use it to change the direction of the pull, as in figure 2-6. This second arrangement is known as a gun tackle purchase. Because the second block is fixed, it merely changes the direction of pull—and the mechanical advantage of the whole system remains two.

You can arrange blocks in a number of ways, depending on the job to be done and the mechanical advantage you want to get. For example, a luff tackle consists of a double block and a single block, rigged as in figure 2-7. Notice that the weight is suspended by the three parts of rope which extend from the movable single block. Each part of the rope carries its share of the load. If the crate weighs 600 pounds, then each of the three parts of the rope supports its share—200 pounds. If there's a pull of 200 pounds downward on rope *B*, you will have to pull downward

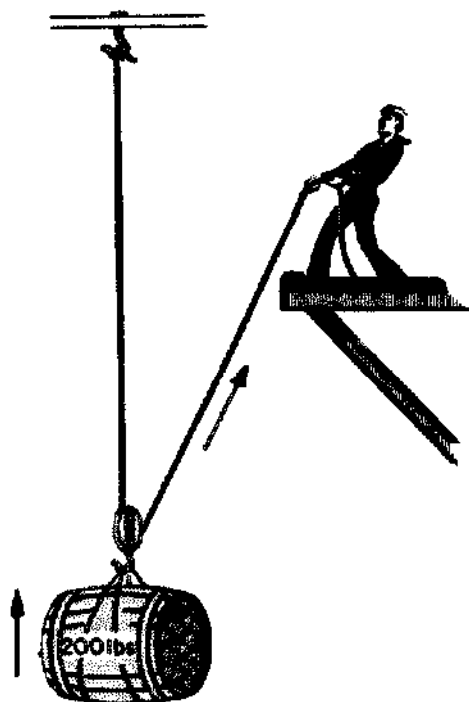


Figure 2-4.—A runner.

29.187

with a force of 200 pounds on A to counterbalance the pull on B. Neglecting the friction in the block, a pull of 200 pounds is all that is necessary to raise the crate. The mechanical advantage is:

$$M. A. = \frac{R}{E} = \frac{600}{200} = 3$$

Here's a good tip. If you count the number of the parts of rope going to and from the movable block, you can figure the mechanical advantage at a glance. This simple rule will help you to quickly approximate the mechanical advantage of most tackles you see in the Navy.

Many combinations of single, double, and triple sheave blocks are possible. Two of these combinations are shown in figure 2-8.

If you can secure the dead end of the fall to the movable block, the advantage is increased by one. Notice that this is done in figure 2-7. That is a good point to remember. Don't forget, either, that the strength of your fall-rope—is a limiting factor in any tackle. Be sure your fall will carry the load. There is no point in rigging a six-fold purchase which carries a 5-ton load with two triple blocks on a 3-inch manila rope attached to

a winch. The winch could take it, but the rope couldn't.

Now for a review of the points you have learned about blocks, and then to some practical applications aboard ship—

With a single fixed block the only advantage is the change of direction of the pull. The mechanical advantage is still one.

A single movable block gives a mechanical advantage of two.

Many combinations of single, double, and triple blocks can be rigged to give greater advantages.

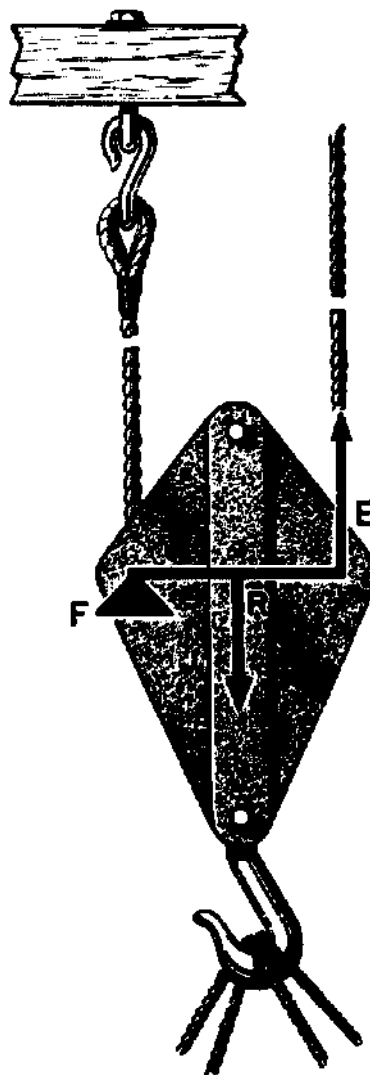


Figure 2-5.—It's 2 to 1.

29.187

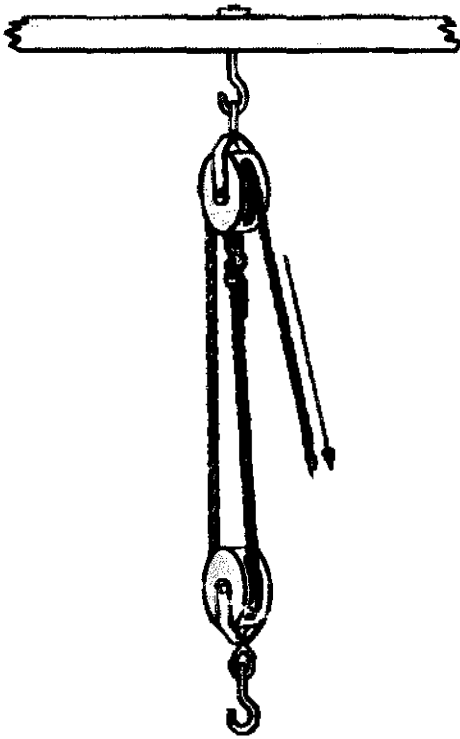


Figure 2-6.—A gun tackle. 29.187

A general rule of thumb is that the number of the parts of the fall going to and from the movable block tells you the approximate mechanical advantage of that tackle.

If you fix the dead end of the fall to the movable block you increase the mechanical advantage by one.

#### APPLICATIONS AFLOAT AND ASHORE

Blocks and tackle are used for a great number of lifting and moving jobs afloat and ashore. The five or six basic combinations are used over and over again in many situations. Cargo is loaded aboard, depth charges are placed in their racks, life boats are lowered over the side by the use of this machine. Heavy machinery, guns, and gun mounts are swung into position with the aid of blocks and tackle. In a thousand situations, bluejackets find this machine useful and efficient.

Yard and stay tackles are used on shipboard when you want to pick up a load from the hold and

swing it onto the deck, or to shift any load a short distance. Figure 2-9 shows you how the load is first picked up by the yard tackle. The stay tackle is left slack. After the load is raised to the height necessary to clear obstructions, you take up on the stay tackle, and ease off on the yard fall. A glance at the rig tells you that the mechanical advantage of each of these tackles is only two. You may think that it isn't worth the trouble to rig a yard and stay tackle with that small advantage just to move a 400-pound crate along the deck. However, a few minutes spent in rigging may save many unpleasant hours with a sprained back.

If you want a high mechanical advantage, a luff upon luff is a good rig for you. You can raise heavy loads with this setup. Figure 2-10 shows you how it is rigged. If you apply the rule by which you count the parts of the fall going to and from the movable blocks, you find that block A gives a mechanical advantage of 3 to 1. Block B has four parts of fall running to and from it, a

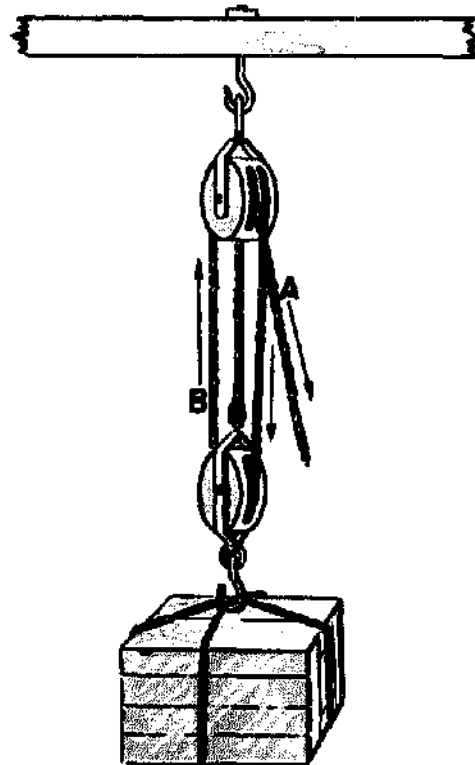
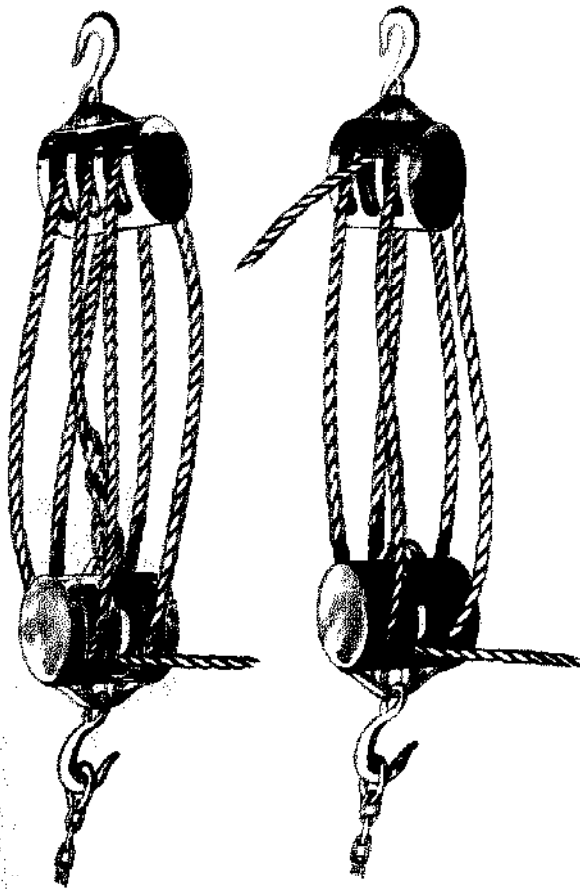


Figure 2-7.—A luff tackle. 29.187





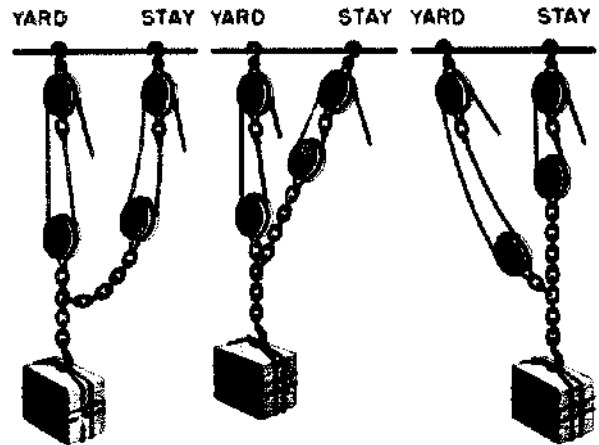
29.187

Figure 2-8.—Some other tackles.

mechanical advantage of 4 to 1. The mechanical advantage of those obtained from A is multiplied four times in B. The overall mechanical advantage of a luff upon luff is the product of the two mechanical advantages—or 12.

Don't make the mistake of adding mechanical advantages. Always multiply them.

You can easily figure out the M.A. for the apparatus shown in figure 2-10. Suppose the load weighs 1,200 pounds. Since it is supported by the parts 1, 2, and 3 of the fall running to and from block A, each part must be supporting one third of the load, or 400 pounds. If part 3 has a pull of 400 pounds on it, part 4 which is made fast to block B, also has a 400-pound pull on it. There are four parts of the second fall going to and from block B, and each of these takes an

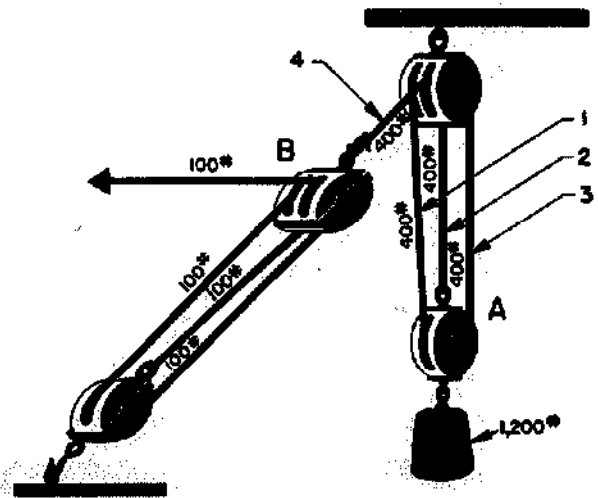


29.187

Figure 2-9.—A yard and stay tackle.

equal part of the 400-pound pull. Therefore, the hauling part requires a pull of only  $1/4 \times 400$ , or 100 pounds. So, here you have a 100-pound pull raising a 1,200-pound load. That's a mechanical advantage of 12.

In shops ashore and aboard ship you are almost certain to run into a chain hoist, or differential pulley. Ordinarily, these hoists are suspended from overhead trolleys, and are used to lift heavy objects and move them from one part of the shop to another.



29.187

Figure 2-10.—Luff upon luff.

To help you to understand the operation of a chain hoist, look at the one in figure 2-11. Assume that you grasp the chain at E and pull until the large wheel A has turned around once. Then the distance through which your effort has moved is equal to the circumference of that wheel, or  $2\pi R$ . How much will the lower wheel C and its load be raised? Since wheel C is a single movable block, its center will be raised only one-half the distance that the chain E was pulled, or a distance  $\pi R$ . However, the smaller wheel B, which is rigidly fixed to A, makes one revolution at the same time as A does so B will feed some chain down to C. The length of the chain fed down will be equal to the circumference of B, or  $2\pi r$ . Again, since C is single movable block, the downward movement of its center will be equal to only one-half the length of the chain fed to it, or  $\pi r$ .

Of course, C does not first move up a distance  $\pi R$  and then move down a distance  $\pi r$ . Actually, its steady movement upward is equal

to the difference between the two, or  $(\pi R - \pi r)$ . Don't worry about the size of the movable pulley, C. It doesn't enter into these calculations. Usually its diameter is between that of A and that of B.

The mechanical advantage equals the distance through which the effort E is moved, divided by the distance that the load is moved. This is called the velocity ratio, or theoretical mechanical advantage. It is theoretical because the frictional resistance to the movement of mechanical parts is left out. In practical uses, all moving parts have frictional resistance.

The equation for theoretical mechanical advantage may be written—

Theoretical mechanical advantage =

$$\frac{\text{Distance effort moves}}{\text{Distance resistance moves}}$$

and in this case,

$$\text{T. M. A.} = \frac{2\pi R}{\pi R - \pi r} = \frac{2R}{R - r}$$

If A is a large wheel, and B is a little smaller, the value of  $2R$  becomes large, and  $(R - r)$  becomes small. Then you have a large number for  $\frac{2R}{R - r}$  which is the theoretical mechanical advantage.

You can lift heavy loads with chain hoists. To give you an idea of the mechanical advantage of a chain hoist, suppose the large wheel has a radius  $R$  of 6 inches and the smaller wheel a radius  $r$  of  $5\frac{3}{4}$  inches. What theoretical mechanical advantage would you get? Use the formula—

$$\text{T. M. A.} = \frac{2R}{R - r}$$

Then substitute the numbers in their proper places, and solve—

$$\text{T. M. A.} = \frac{2 \times 6}{6 - 5\frac{3}{4}} = \frac{12}{1/4} = 48$$

Since the friction in this type of machine is considerable, the actual mechanical advantage is not as high as the theoretical mechanical advantage would lead you to believe. For example, that theoretical mechanical advantage of 48 tells you that with a one-pound pull you should be able to lift a 48-pound load. However, actually your one-pound pull might only lift a 20-pound load. The rest of your effort would be used in overcoming the friction.

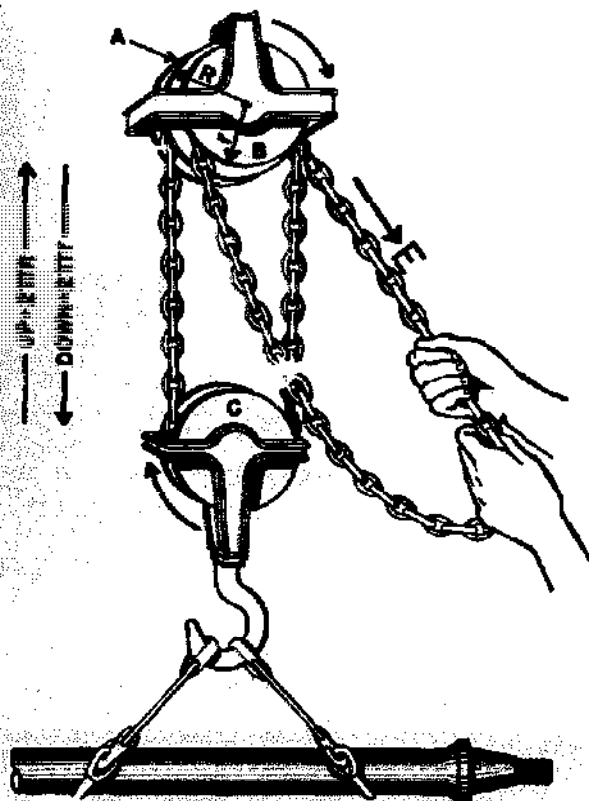


Figure 2-11.—A chain hoist.

29.187

## CHAPTER 3

# THE WHEEL AND AXLE

Have you ever tried to open a door when the knob was missing? If you have, you know that trying to twist that small four-sided shaft with your fingers is tough work. That gives you some appreciation of the advantage you get by using a knob. The door knob is an example of a simple machine called a wheel and axle.

The steering wheel on an automobile, the handle of an ice cream freezer, a brace and bit—these are familiar examples of this type of simple machine. As you know from your experience with these devices, the wheel and axle is commonly used to multiply the force you exert. If a screwdriver won't do a job because you can't turn it, you stick a screwdriver bit in the chuck of a brace and the screw probably goes in with little difficulty.

There's one thing you'll want to get straight right at the beginning. The wheel-and-axle machine consists of a wheel or crank rigidly attached to the axle, which turns with the wheel. Thus, the front wheel of an automobile is not a wheel-and-axle machine because the axle does not turn with the wheel.

### MECHANICAL ADVANTAGE

How does the wheel-and-axle arrangement help to magnify the force you exert? Suppose you use a screwdriver bit in a brace to drive a stubborn screw. Look at figure 3-1A. Your effort is applied on the handle which moves in a circular path, the radius of which is 5 inches. If you apply a 10-pound force on the handle, how big a force will be exerted against the resistance at the screw? Assume the radius of the screwdriver blade is 1/4 inch. You are really using the brace as a second-class lever—see figure 3-1B. The size of the resistance

which can be overcome can be found from the formula—

$$\frac{L}{l} = \frac{R}{E}$$

In which—

L = radius of the circle through which the handle turns,

l = one-half the width of the edge of the screwdriver blade,

R = force of the resistance offered by the screw,

E = force of effort applied on the handle.

Substituting in the formula; and solving:

$$\frac{5}{1/4} = \frac{R}{10}$$

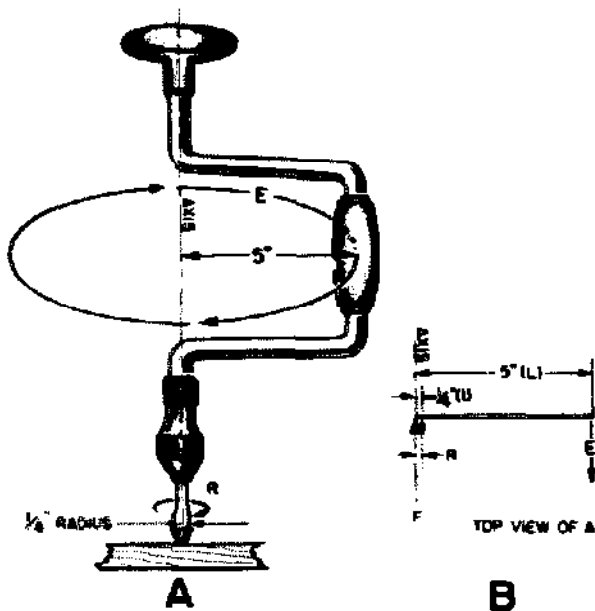
$$R = \frac{5 \times 10}{1/4}$$

$$= 5 \times 10 \times 4$$

$$= 200 \text{ lb.}$$

This means that the screwdriver blade will tend to turn the screw with a force of 200 pounds. The relationship between the radii or the diameters, or the circumferences of the wheel and axle tells you how great a mechanical advantage you can get.

Take another situation. The old oaken bucket, figure 3-2, was raised by a wheel-and-axle arrangement. If the distance from the center of the axle to the handle is 8 inches, and the radius of the drum around which the rope is wound is 2 inches, then you have a theoretical mechanical advantage of 4. That's why they used these rigs.



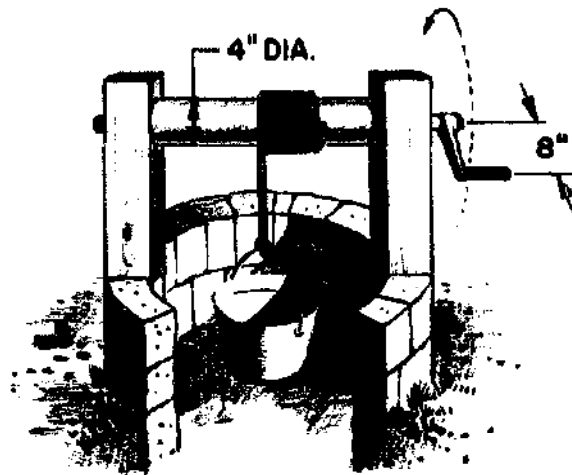
44.20  
Figure 3-1.—It magnifies your effort.

**MOMENT OF FORCE**

In a number of situations you can use the wheel-and-axle to speed up motion. The rear-wheel sprocket of a bike, along with the rear wheel itself, is an example. When you are pedaling, the sprocket is fixed to the wheel, so the combination is a true wheel-and-axle machine. Assume that the sprocket has a circumference of 8 inches, and the wheel circumference is 80 inches. If you turn the sprocket at a rate of one revolution per second, each sprocket tooth moves at a speed of 8 inches per second. Since the wheel makes one revolution for each revolution made by the sprocket, any point on the tire must move through a distance of 80 inches in one second. So, for every eight-inch movement of a point on the sprocket, you have moved a corresponding point on the wheel through 80 inches.

Since a complete revolution of the sprocket and wheel requires only one second, the speed of a point on the circumference of the wheel is 80 inches per second, or ten times the speed of a tooth on the sprocket.

(NOTE: Both sprocket and wheel make the same number of revolutions per second so the speed of turning for the two is the same.)

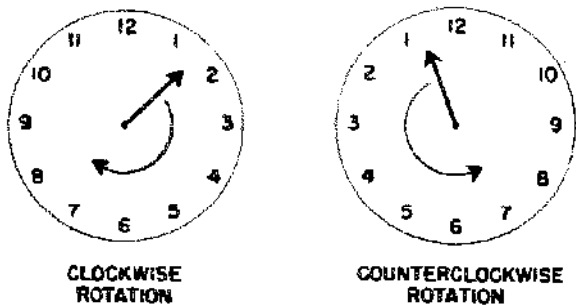


131.11  
Figure 3-2.—The old oaken bucket.

Here is an idea which you will find useful in understanding the wheel and axle, as well as other machines. You probably have noticed that the force you apply to a lever tends to turn or rotate it about the fulcrum? You also know that a heave on a fall tends to rotate the sheave of the block and that turning the steering wheel of a car tends to rotate the steering column. Whenever you use a lever, or a wheel and axle, your effort on the lever arm or the rim of the wheel tends to cause a rotation about the fulcrum or the axle in one direction or another. If the rotation occurs in the same direction as the hands of a clock, that direction is called clockwise. If the rotation occurs in the opposite direction from that of the hands of a clock, the direction of rotation is called counterclockwise. A glance at figure 3-3 will make clear the meaning of these terms.

You have already seen that the result of a force acting on the handle of the carpenter's brace depends not only on the amount of that force but also on the distance from the handle to the center of rotation. From here on you'll know this result as a moment of force, or a torque (pronounced tork). Moment of force and torque have the same meaning.

Look at the effect of counterclockwise movement of the capstan bar in figure 3-4. Here the amount of the effort is designated  $E_1$  and the distance from the point where this force is



CLOCKWISE ROTATION

COUNTERCLOCKWISE ROTATION

131.12

Figure 3-3.—Directions of rotation.

applied to the center of the axle is  $L_1$ . Then  $E_1 \times L_1$  is the moment of force. You'll notice that this term includes both the amount of the effort and the distance from the point of application of effort to the center of the axle. Ordinarily, the distance is measured in feet and the applied force is measured in pounds.

Therefore, moments of force are generally measured in foot-pounds—abbreviated ft-lb. A moment of force is frequently called a moment.

By using a longer capstan bar, the bluejacket in figure 3-4 can increase the effectiveness of his push without making a bigger effort. But if he applied his effort closer to the head of the capstan and used the same force, the moment of force would be less.

BALANCING MOMENTS

You know that the bluejacket in figure 3-4 would land flat on his face if the anchor hawser snapped. But just as long as nothing breaks, he must continue to push on the capstan bar. He is working against a clockwise moment of force, which is equal in magnitude but opposite in direction to his counterclockwise moment of force. The resisting moment, like the effort moment, depends on two factors. In the case of the resisting moment, these factors are the force  $R_2$  with which the anchor pulls on the hawser, and the distance  $L_2$  from the center of

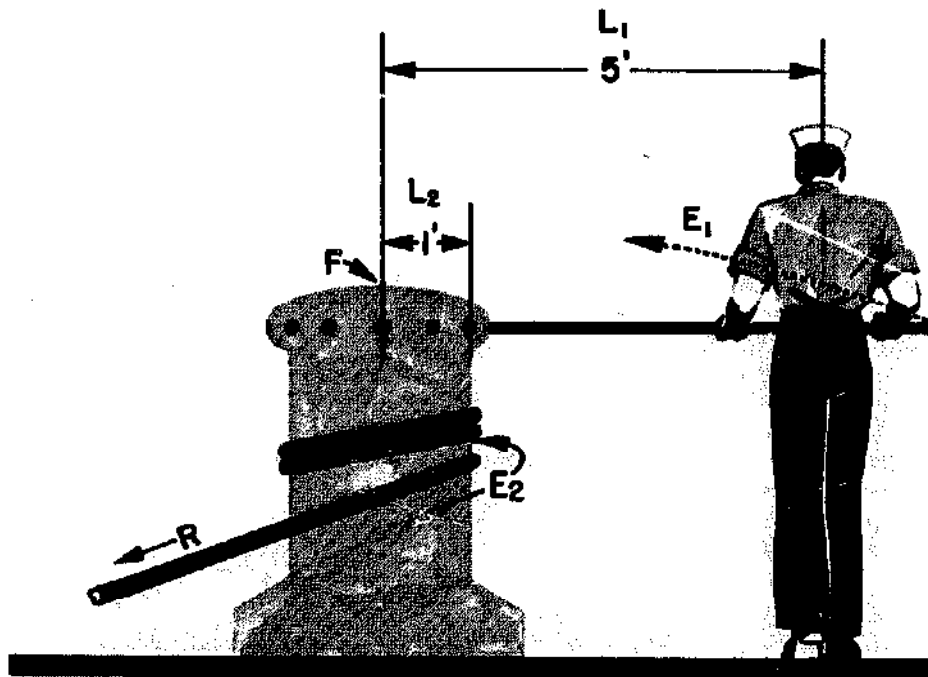


Figure 3-4.—Using a capstan.

131.13

the capstan to its rim. The existence of this resisting force would be evident if the blue-jacket let go of the capstan bar. The weight of the anchor pulling on the capstan would cause the whole works to spin rapidly in a clockwise direction—and good-bye anchor! The principle involved here is that whenever the counterclockwise and the clockwise moments of force are in balance, the machine either moves at a steady speed or remains at rest.

This idea of the balance of moments of force can be summed up by the expression—

**CLOCKWISE MOMENTS =  
COUNTERCLOCKWISE MOMENTS**

And, since a moment of force is the product of the amount of the force times the distance the force acts from the center of rotation, this expression of equality may be written—

$$E_1 \times L_1 = E_2 \times L_2$$

In which—

- $E_1$  = force of effort,
- $L_1$  = distance from fulcrum or axle to point where force is applied,
- $E_2$  = force of resistance,
- $L_2$  = distance from fulcrum or center of axle to the point where resistance is applied.

**EXAMPLE 1**

Put this formula to work on a capstan problem. A single capstan bar is gripped 5 feet from the center of a capstan head with a radius of one foot. A 1/2-ton anchor is to be lifted. How big a push does the sailor have to exert?

First, write down the formula—

$$E_1 \times L_1 = E_2 \times L_2$$

Here  $L_1 = 5$ ;  $E_2 = 1,000$  pounds; and  $L_2 = 1$ . Substitute these values in the formula, and it becomes:

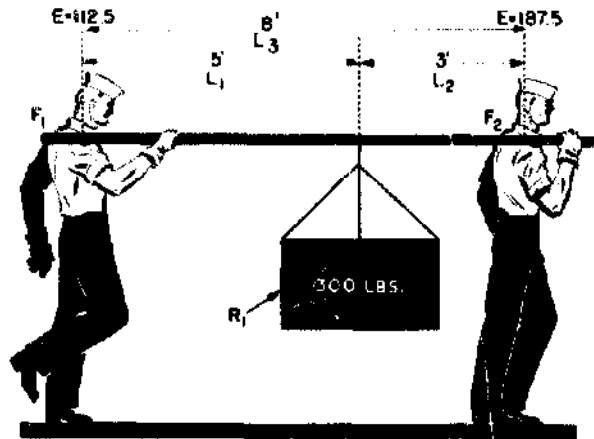
$$E_1 \times 5 = 1,000 \times 1$$

and—

$$E_1 = \frac{1,000}{5} = 200 \text{ pounds}$$

**EXAMPLE 2**

Consider now the sad case of Slim and Sam, as illustrated in figure 3-5. Slim has suggested that they carry the 300-pound crate slung on a



131.14

Figure 3-5.—A practical application.

handy 10-foot pole. He was smart enough to slide the load up 3 feet from Sam's shoulder.

Here's how they made out. Use Slim's shoulder as a fulcrum  $F_1$ . Look at the clockwise moment caused by the 300-pound load. That load is five feet away from Slim's shoulder. If  $R_1$  is the load, and  $L_1$  the distance from Slim's shoulder to the load, the clockwise moment  $M_A$  is—

$$M_A = R_1 \times L_1 = 300 \times 5 = 1,500 \text{ ft.-lb.}$$

With Slim's shoulder still acting as the fulcrum, the resistance of Sam's effort causes a counterclockwise moment  $M_B$  acting against the load moment. This counterclockwise moment is equal to Sam's effort  $E_2$  times the distance  $L_3$  from his shoulder to the fulcrum  $F_1$  at Slim's shoulder. Since  $L_2 = 8$  ft., the formula is—

$$M_B = E_2 \times L_3 = E_2 \times 8 = 8E_2$$

But there is no rotation, so the clockwise moment and the counterclockwise moment are equal.  $M_A = M_B$ . Hence—

$$1,500 = 8E_2$$

$$E_2 = \frac{1,500}{8} = 187.5 \text{ pounds.}$$

So poor Sam is carrying 187.5 pounds of the 300-pound load.

the capstan to its rim. The existence of this resisting force would be evident if the blue-jacket let go of the capstan bar. The weight of the anchor pulling on the capstan would cause the whole works to spin rapidly in a clockwise direction—and good-bye anchor! The principle involved here is that whenever the counterclockwise and the clockwise moments of force are in balance, the machine either moves at a steady speed or remains at rest.

This idea of the balance of moments of force can be summed up by the expression—

**CLOCKWISE MOMENTS =  
COUNTERCLOCKWISE MOMENTS**

And, since a moment of force is the product of the amount of the force times the distance the force acts from the center of rotation, this expression of equality may be written—

$$E_1 \times L_1 = E_2 \times L_2$$

In which—

- $E_1$  = force of effort,
- $L_1$  = distance from fulcrum or axle to point where force is applied,
- $E_2$  = force of resistance,
- $L_2$  = distance from fulcrum or center of axle to the point where resistance is applied.

**EXAMPLE 1**

Put this formula to work on a capstan problem. A single capstan bar is gripped 5 feet from the center of a capstan head with a radius of one foot. A 1/2-ton anchor is to be lifted. How big a push does the sailor have to exert?

First, write down the formula—

$$E_1 \times L_1 = E_2 \times L_2$$

Here  $L_1 = 5$ ;  $E_2 = 1,000$  pounds; and  $L_2 = 1$ . Substitute these values in the formula, and it becomes:

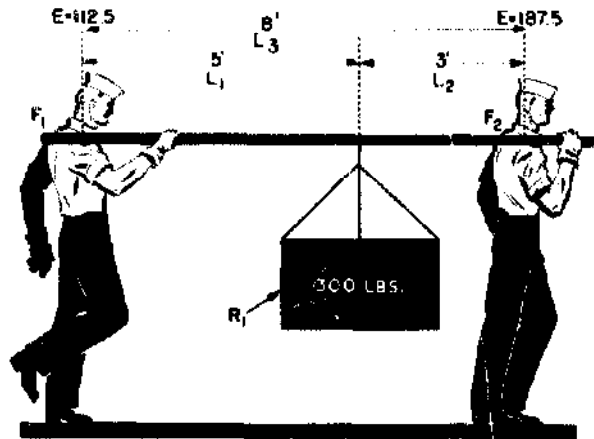
$$E_1 \times 5 = 1,000 \times 1$$

and—

$$E_1 = \frac{1,000}{5} = 200 \text{ pounds}$$

**EXAMPLE 2**

Consider now the sad case of Slim and Sam, as illustrated in figure 3-5. Slim has suggested that they carry the 300-pound crate slung on a



131.14

Figure 3-5.—A practical application.

handy 10-foot pole. He was smart enough to slide the load up 3 feet from Sam's shoulder.

Here's how they made out. Use Slim's shoulder as a fulcrum  $F_1$ . Look at the clockwise moment caused by the 300-pound load. That load is five feet away from Slim's shoulder. If  $R_1$  is the load, and  $L_1$  the distance from Slim's shoulder to the load, the clockwise moment  $M_A$  is—

$$M_A = R_1 \times L_1 = 300 \times 5 = 1,500 \text{ ft.-lb.}$$

With Slim's shoulder still acting as the fulcrum, the resistance of Sam's effort causes a counterclockwise moment  $M_B$  acting against the load moment. This counterclockwise moment is equal to Sam's effort  $E_2$  times the distance  $L_3$  from his shoulder to the fulcrum  $F_1$  at Slim's shoulder. Since  $L_2 = 8$  ft., the formula is—

$$M_B = E_2 \times L_3 = E_2 \times 8 = 8E_2$$

But there is no rotation, so the clockwise moment and the counterclockwise moment are equal.  $M_A = M_B$ . Hence—

$$1,500 = 8E_2$$

$$E_2 = \frac{1,500}{8} = 187.5 \text{ pounds.}$$

So poor Sam is carrying 187.5 pounds of the 300-pound load.

When an object is at rest or is moving steadily, the clockwise moments are just equal and opposite to the counterclockwise moments.

Moments of the force, depend upon two factors—the amount of the force, and the distance from the fulcrum or axis to the point where the force is applied.

When two equal forces are applied at equal distances on opposite sides of a fulcrum, and move in opposite directions so that they both tend to cause rotation about the fulcrum, you have a couple.

#### APPLICATIONS AFLOAT AND ASHORE

A trip to the engine room makes you realize how important the wheel and axle is on the modern ship. Everywhere you look you see wheels of all sizes and shapes. Most of them are used to open and close valves quickly. One common type of valve is shown in figure 3-7. Turning the wheel causes the threaded stem to rise and open the valve. Since the valve must close water-tight, air-tight, or steam-tight, all the parts must fit snugly. To move the stem on most valves without the aid of the wheel would be impossible. The wheel gives you the necessary mechanical advantage.

You've handled enough wrenches to know that the longer the handle, the tighter you can turn a nut. Actually, a wrench is a wheel-and-axle machine. You can consider the handle as one spoke of a wheel, and the place where you

take hold of the handle as a point on the rim. The nut which is held in the jaws of the wrench can be compared to the axle.

You know that you can turn a nut too tight—and strip the threads or cause internal parts to seize. This is especially true when you are taking up on bearings. In order to make the proper adjustment, you use a torque wrench. There are several types. Figure 3-8 shows you one that is very simple. When you pull on the handle, its shaft bends. The rod on which the pointer is fixed does not bend—so the pointer indicates on the scale the torque, or moment of force, that you are exerting. The scale is generally stated in pounds, although it is really measuring foot-pounds of torque. If the nut is to be tightened by a moment of 90 ft-lb, you pull until the pointer is opposite the number 90 on the scale. The servicing or repair manual on an engine or piece of machinery generally tells you what the torque—or moment of force—should be on each set of nuts or bolts.

The gun pointer uses a couple to elevate and depress the gun barrel. He cranks away at a hand-wheel that has two handles. The right-hand handle is on the opposite side of the axle from the left-hand handle—180° apart. Look at figure 3-9. When he pulls on one handle and pushes on the other, he's producing a couple. But if he lets go the left handle to scratch himself, and cranks only with his right hand, he no longer has a couple—just a simple first-class lever! And he'd have to push twice as hard with one hand.

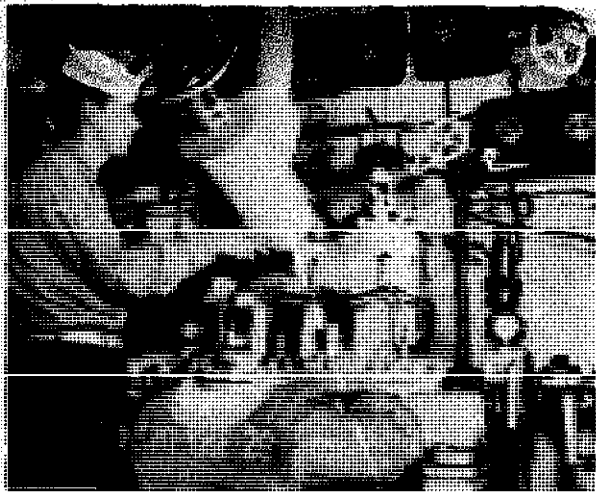


Figure 3-7.—Valves.

131.16

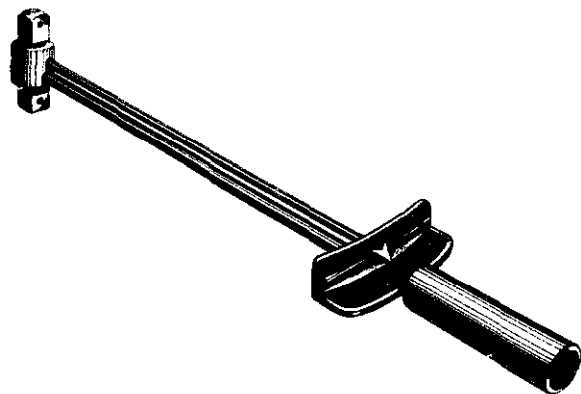


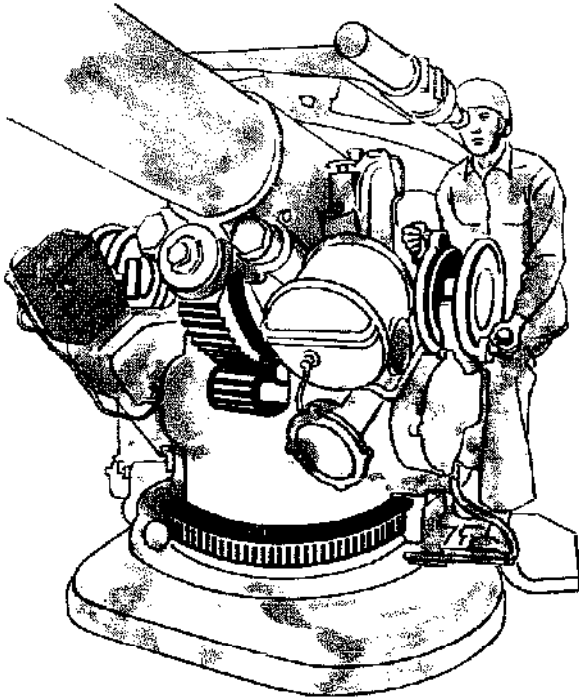
Figure 3-8.—A simple torque wrench.

5.9

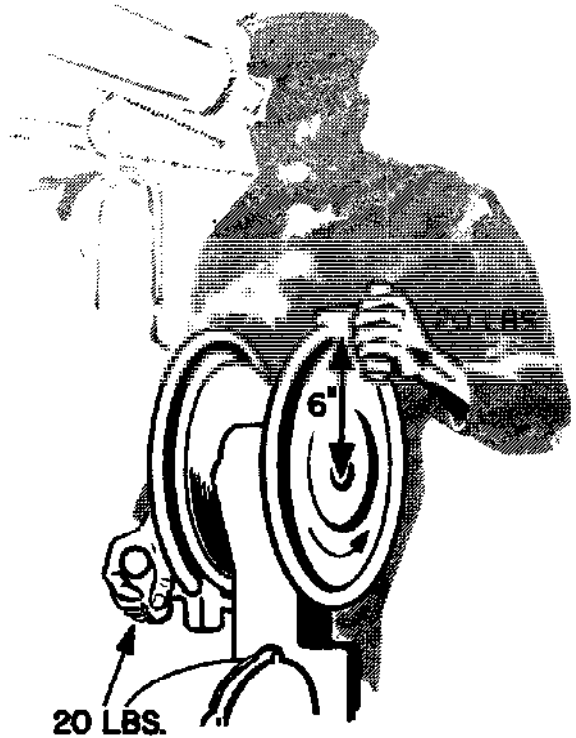


A system of gears—a gear train—transmits the motion to the barrel. A look at figure 3-10 will help you to figure the forces involved. The radius of the wheel is 6 inches—1/2 foot—and each handle is being turned with a force of, say, 20 pounds. The moment on the top which tends to rotate the wheel in a clockwise direction is equal to 20 times 1/2 = 10 ft-lb. The bottom

handle also rotates the wheel in the same direction with an equal moment. Thus the total twist or torque on the wheel is 10 + 10 = 20 ft-lb. To get the same moment with one hand, applying a 20-pound force, the radius of the wheel would have to be twice as great—12 inches, or one foot. The couple is a convenient arrangement of the wheel-and-axle machine.



131.17  
Figure 3-9.—A pointer's handwheel.



131.18  
Figure 3-10.—Developing a torque.

## CHAPTER 4

# THE INCLINED PLANE AND THE WEDGE

### THE BARREL ROLL

You have probably watched a driver load barrels on a truck. The truck is backed up to the curb. The driver places a long double plank or ramp from the sidewalk to the tail gate, and then rolls the barrel up the ramp. A 32-gallon barrel may weigh close to 300 pounds when full, and it would be quite a job to lift one up into the truck. Actually, the driver is using a simple machine called the inclined plane. You have seen the inclined plane used in many situations. Cattle ramps, a mountain highway, and the gangplank are familiar examples.

The inclined plane permits you to overcome a large resistance by applying a relatively small force through a longer distance than the load is raised. Look at figure 4-1. Here you see the driver easing the 300-pound barrel up to the bed of the truck, three feet above the sidewalk. He is using a plank nine feet long. If he didn't use the ramp at all, he'd have to apply a 300-pound force straight up through the three-foot distance. With the ramp, however, he can apply his effort over the entire nine feet of the plank as the barrel is slowly rolled up to a height of three feet. It looks, then, as if he could use a force only three-ninths of 300, or 100 pounds, to do the job. And that is actually the situation.

Here's the formula. Remember it from chapter 1?

$$\frac{L}{l} = \frac{R}{E}$$

In which—L = length of the ramp, measured along the slope,

l = height of the ramp,

R = weight of object to be raised, or lowered,

E = force required to raise or lower object

Now apply the formula to this problem—

In this case, L = 9 ft.; l = 3 ft.; and R = 300 lb. By substituting these values in the formula, you get—

$$\frac{9}{3} = \frac{300}{E}$$

$$9E = 900$$

$$E = 100 \text{ pounds}$$

Since the ramp is three times as long as its height, the mechanical advantage is three. You find the theoretical mechanical advantage by dividing the total distance through which your effort is exerted by the vertical distance through which the load is raised or lowered.

### THE WEDGE

The wedge is a special application of the inclined plane. You have probably used wedges. Abe Lincoln used a wedge to help him split logs into rails for fences. The blades of knives, axes, hatchets, and chisels act as wedges when they are forced into a piece of wood. The wedge is two inclined planes, set base-to-base. By driving the wedge full-length into the material to be cut or split, the material is forced apart a distance equal to the width of the broad end of the wedge. See figure 4-2.

Long, slim wedges give high mechanical advantage. For example, the wedge of figure 4-2 has a mechanical advantage of six. Their greatest value, however, lies in the fact that you can use them in situations where other simple machines won't work. Imagine the trouble you'd have trying to pull a log apart with a system of pulleys.

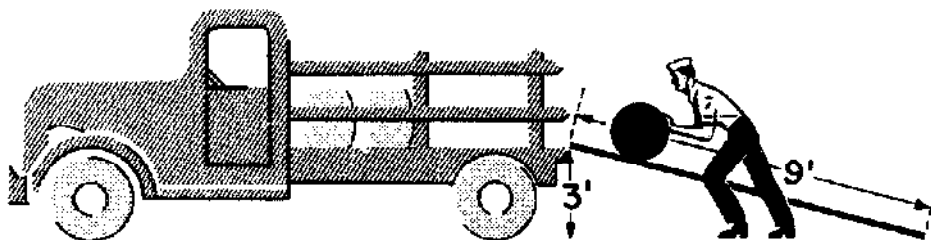


Figure 4-1.—An inclined plane.

110.4

SUMMARY

Before you look at some of the Navy applications of the inclined plane and the wedge, here's a summary of what to remember from this chapter—

The inclined plane is a simple machine that lets you raise or lower heavy objects by applying a small force over a relatively long distance.

The theoretical mechanical advantage of the inclined plane is found by dividing the length of the ramp by the perpendicular height that the load will be raised or lowered. The actual mechanical advantage is equal to the weight of the resistance or load, divided by the force that must be used to move the load up the ramp.

The wedge is two inclined planes set base-to-base. It finds its greatest use in cutting or splitting materials.

APPLICATIONS AFLOAT AND ASHORE

One of the most common uses of the inclined plane in the Navy is the gangplank. Going aboard the ship by gangplank, illustrated in figure 4-3 is certainly easier than climbing up a sea ladder. And you appreciate the M.A. of the gangplank even more when you have to carry your sea bag or a case of prunes aboard.

Remember that hatch dog in figure 1-10. The dog that's used to secure a door not only takes advantage of the lever principle, but—if you look sharply—you can see that the dog seats itself on a steel wedge which is welded to the door. As the dog slides upward along this wedge, it forces the door tightly shut. This is an inclined plane, with its length about eight times its thickness. That means you get a theoretical mechanical advantage of eight. You figured, in

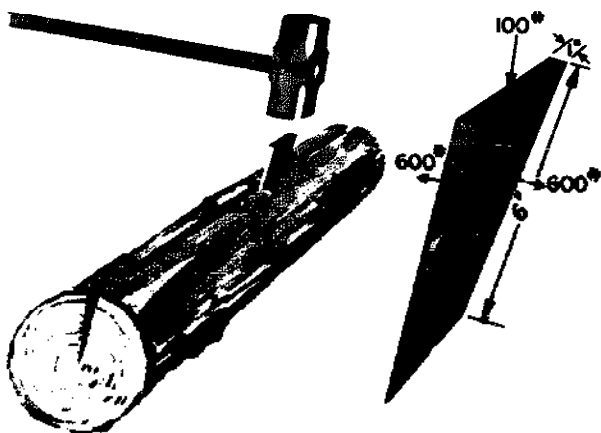


Figure 4-2.—A wedge.

131.19



Figure 4-3.—The gangplank is an inclined plane.

131.20

## Chapter 4—THE INCLINED PLANE AND THE WEDGE

---

chapter 1, that you got a mechanical advantage of four from the lever action of the dog—so the overall mechanical advantage is 8 times 4 or 32, neglecting friction. Not bad for such a simple gadget, is it? Push down with 50 pounds heave on the handle and you squeeze the door shut with a force of 1600 pounds, on that dog. You'll find the damage-control parties using wedges by the dozen to shore up bulkheads and decks. A few

sledge-hammer blows on a wedge will quickly and firmly tighten up the shoring.

Chipping scale or paint off steel is a tough job. However, the job is made a lot easier with a compressed air chisel. The wedge-shaped cutting edge of the chisel gets in under the scale or the paint, and exerts great pressure to lift the scale or paintlayer. The chisel bit is another application of the inclined plane.

## CHAPTER 5

# THE SCREW

### A MODIFIED INCLINED PLANE

The screw is a simple machine that has many uses. The vise on a workbench makes use of the great mechanical advantage of the screw. So do the screw clamps used to hold a piece of furniture together while it is being glued. And so do many automobile jacks and even the food grinder in the kitchen at home.

A screw is a modification of the inclined plane. Cut a sheet of paper in the shape of a right triangle—an inclined plane. Wind it around a pencil, as in figure 5-1. Then you can see that the screw is actually an inclined plane wrapped around a cylinder. As the pencil is turned, the paper is wound up so that its hypotenuse forms a spiral thread similar to the thread on the screw shown at the right. The pitch of the screw, and of the paper, is the distance between identical points on the same threads, and measured along the length of the screw.

### THE JACK

In order to understand how the screw works, look at figure 5-2. Here you see a jack screw of the type that is used to raise a house or a piece of heavy machinery. The jack has a lever handle with a length  $r$ . If you pull the lever handle around one turn, its outer end has described a circle. The circumference of this circle is equal to  $2\pi$ . (You remember that  $\pi$  equals 3.14, or  $\frac{22}{7}$ ). That is the distance, or the lever arm, through which your effort is applied.

At the same time, the screw has made one revolution, and in doing so has been raised a height equal to its pitch  $p$ . You might say that one full thread has come up out of the base. At any rate, the load has been raised a distance  $p$ .

Remember that the theoretical mechanical advantage is equal to the distance through which

the effort or pull is applied, divided by the distance the resistance or load is moved. Assuming a 2-foot—24"—length for the lever arm, and a 1/4-inch pitch for the thread, you can find the theoretical mechanical advantage by the formula—

$$M. A. = \frac{2\pi r}{p}$$

in which

$r$  = length of handle = 24 inches  
 $p$  = pitch, or distance between corresponding points on successive threads = 1/4-inch.

Substituting,

$$T. M. A. = \frac{2 \times 3.14 \times 24}{1/4} = \frac{150.72}{1/4} = 602.88$$

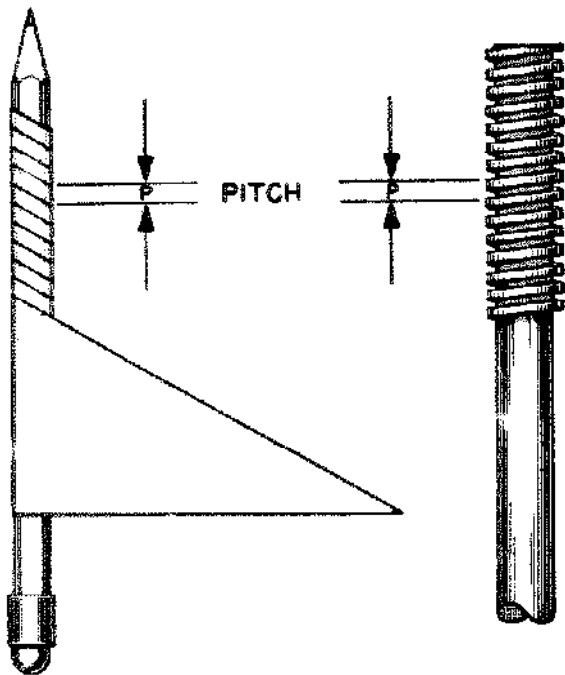
A 50-pound pull on the handle would result in a theoretical lift of  $50 \times 602$  or about 30,000 pounds. Fifteen tons for fifty pounds.

But jacks have considerable friction loss. The threads are cut so that the force used to overcome friction is greater than the force used to do useful work. If the threads were not cut this way, if no friction were present, the weight of the load would cause the jack to spin right back down to the bottom as soon as you released the handle.

### THE MICROMETER

In using the jack, you exerted your effort through a distance of  $2\pi r$ , or 150 inches, in order to raise the screw 1/4 inch. It takes a lot of circular motion to get a small amount of straight-line motion from the head of the jack. You will use this point to advantage in the micrometer, which is a useful device for making accurate small measurements, measurements of a few thousandths of an inch.

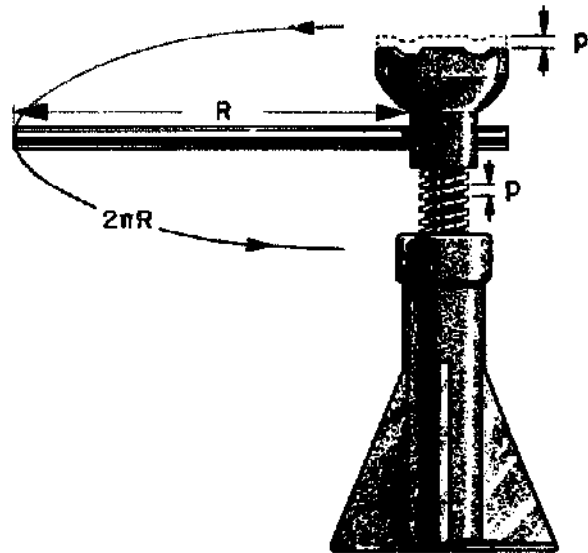
In figure 5-3, you see a cutaway view of a micrometer. The thimble turns freely on the



110.4  
Figure 5-1.—A screw is an inclined plane in spiral form.

sleeve, which is rigidly attached to the micrometer frame. The spindle is attached to the thimble, and is fitted with screw threads which move the spindle and thimble to right or left in the sleeve when you rotate the thimble. These screw threads are cut 40 threads to the inch. Hence one turn of the thimble moves the spindle and thimble  $1/40$  inch. This represents one of the smallest divisions on the micrometer. Four of these small divisions make  $4/40$  of an inch, or  $1/10$  inch. Thus the distance from 0 to 1 or 1 to 2 on the sleeve represents  $1/10$  or 0.1 inch.

To allow even finer measurements, the thimble is divided into 25 equal parts laid out by graduation marks around its rim, as shown in figure 45. If you turn the thimble through 25 of these equal parts, you have made one complete revolution of the screw, which represents a lengthwise movement of  $1/40$  of an inch. Now, if you turn the thimble one of these units on its scale, you have moved the spindle a distance of  $1/25$  of  $1/40$  inch, or  $1/1000$  of an inch—0.001 inch.



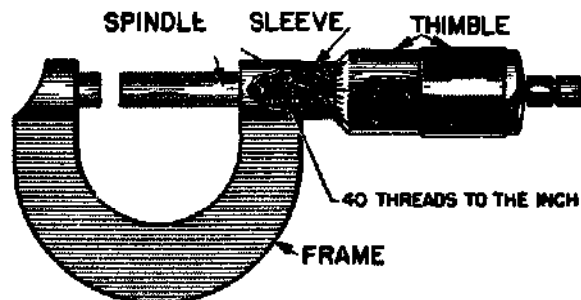
81.25  
Figure 5-2.—A jack screw.

The micrometer in figure 5-4 reads 0.503 inch, which is the true diameter of the half-inch drill-bit shank being measured. This tells you that the diameter of this particular bit is 0.003 inch greater than its nominal diameter of  $1/2$  inch—0.500".

Because you can make such accurate measurements with this instrument, it is indispensable in every machine shop.

#### SUMMARY

Look over the basic ideas you have learned from this chapter, and then see how the Navy uses this simple machine—the screw.



4.20  
Figure 5-3.—A micrometer.

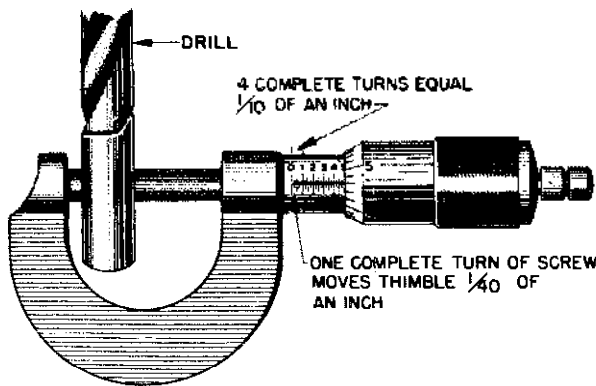


Figure 5-4.—Taking turns.

4.20

The screw is a modification of the inclined plane—modified to give you a high mechanical advantage.

The theoretical mechanical advantage of the screw can be found by the formula

$$M.A. = \frac{2\pi}{p}$$

As in all machines, the actual mechanical advantage equals the resistance divided by the effort.

In many applications of the screw, you make use of the large amount of friction that is commonly present in this simple machine.

By the use of the screw, large amounts of circular motion are reduced to very small amounts of straight-line motion.

**APPLICATIONS AFLOAT AND ASHORE**

It's a tough job to pull a rope or cable up tight enough to get all the slack out of it. But you can do it. Use a turnbuckle. The turnbuckle is an application of the screw. See figure 5-5. If

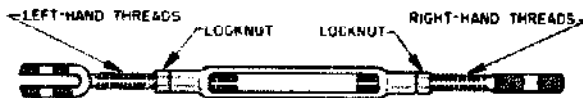


Figure 5-5.—A turnbuckle.

131.21

you turn it in one direction, it takes up the slack in a cable. Turning it the other way slacks off on the cable. You'll notice that one bolt of the turnbuckle has left-hand threads, and the other bolt has right-hand threads. Thus, when you turn the turnbuckle to tighten up the line, both bolts tighten up. If both bolts were right-hand thread—standard thread—one would tighten while the other one loosened an equal amount. Result—no change in cable-slack. Most turnbuckles have the screw threads cut to provide a large amount of frictional resistance to keep the turnbuckle from unwinding under load. In some cases, the turnbuckle has a lock nut on each of the screws to prevent slipping. You'll find turnbuckles used in a hundred different ways afloat and ashore.

Ever wrestled with a length of wire rope? Obstinate and unwieldy, wasn't it? Riggers have dreamed up tools to help subdue wire rope. One of these tools—the rigger's vise—is shown in figure 5-6. This rigger's vise uses the great mechanical advantage of the screw to hold the wire rope while the crew splices a thimble—a reinforced loop—onto the end of the cable. Rotating the handle causes the jaw on that screw to move in or out along its grooves. This machine is a modification of the vise on a work bench. Notice the right-hand and left-hand screws on the left-hand clamp.

Figure 5-7 shows you another use of the screw. Suppose you want to stop a winch with its load suspended in mid-air. To do this, you need a brake. The brake on most anchor or cargo winches consists of a metal band that



Figure 5-6.—A rigger's vise.

131.22

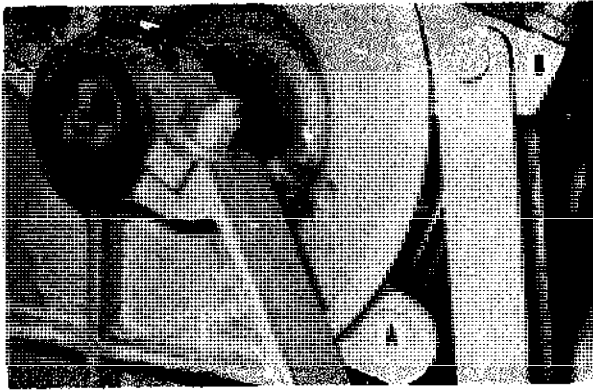


Figure 5-7.—A friction brake.

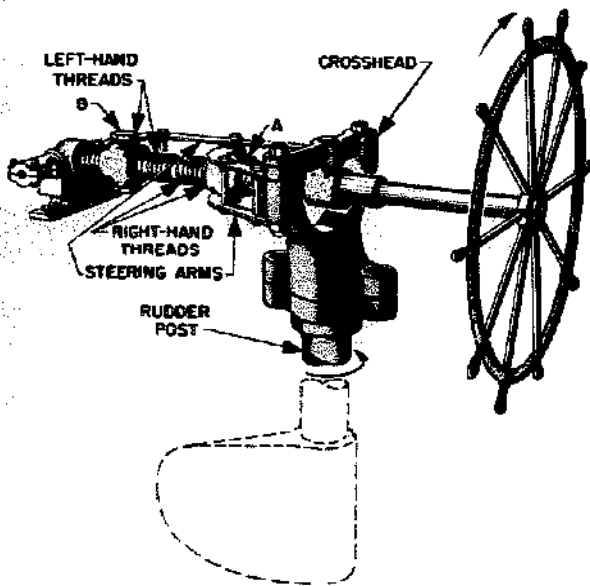
131.23

encircles the brake drum. The two ends of the band are fastened to nuts connected by a screw attached to a handwheel. As you turn the handwheel, the screw pulls the lower end of the band A up toward its upper end B. The huge M.A. of the screw puts the squeeze on the drum, and all rotation of the drum is stopped.

One type of steering gear used on many small ships—and as a spare steering system on some larger ships—is the screw gear. Figure 5-8

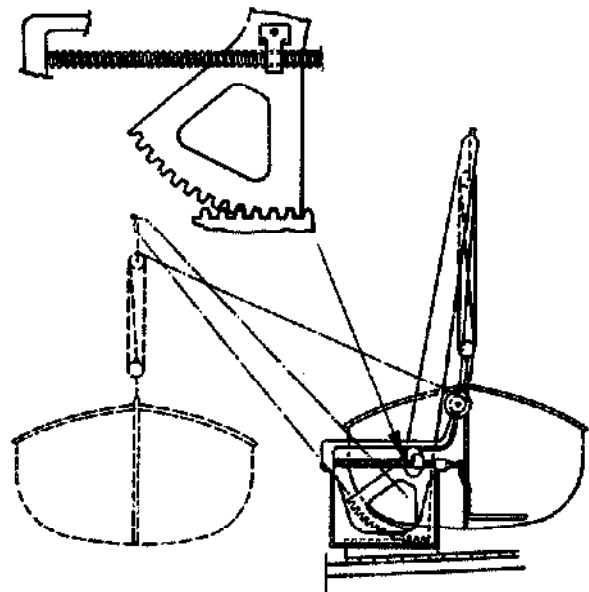
shows you that the wheel turns a long threaded shaft. Half the threads—those nearer the wheel end of this shaft—are right-hand threads. The other half of the threads—those farther from the wheel—are left-hand threads. The nut A has a right-hand thread, and nut B has a left-hand thread. Notice that the cross head which turns the rudder is connected to the nuts by two steering arms. If you stand in front of the wheel and turn it in a clockwise direction—to your right—arm A moves forward and arm B moves backward. This turns the rudder counterclockwise, so that the ship swings in the direction you turn the wheel. There is a great mechanical advantage to this steering mechanism.

Figure 5-9 shows you another practical use of the screw. The quadrant davit makes it possible for two men to put a large life boat over the side with little effort. The operating handle is attached to a threaded screw which passes through a traveling nut. If the operating handle is cranked in a counterclockwise direction (as you face outboard), the nut travels outward along the screw. The traveling nut is fastened to the davit arm by a swivel. The davit arm and the boat swing outboard as a result of the outward movement of the screw. The thread on that screw is the self-locking type—if you let go of the handle the nut remains locked in position.



131.24

Figure 5-8.—The screw gives a tremendous mechanical advantage.



80.101

Figure 5-9.—The quadrant davit.



## CHAPTER 6

# GEARS

Did you ever take a clock apart to see what made it tick? Of course you came out with some parts left over when you got it back together again. And they probably included a few gear wheels. Gears are used in many machines. Frequently the gears are hidden from view in a protective case filled with grease or oil, and you may not see them.

An egg beater gives you a simple demonstration of the three things that gears do. They can change the direction of motion; increase or decrease the speed of the applied motion; and magnify or reduce the force which you apply. Gears also give you a positive drive. There can be, and usually is, creep or slip in a belt drive. But gear teeth are always in mesh, and there can be no creep and slip.

Follow the directional changes in figure 6-1. The crank handle is turned in the direction indicated by the arrow—clockwise, when viewed from the right. The 32 teeth on the large vertical wheel A mesh with the 8 teeth on the right-hand horizontal wheel B, which rotates as indicated by the arrow. Notice that as B turns in a clockwise direction, its teeth mesh with those of wheel C and cause wheel C to revolve in the opposite direction. The rotation of the crank handle has been transmitted by gears to the beater blades, which also rotate.

Now figure out how the gears change the speed of motion. There are 32 teeth on gear A and 8 teeth on gear B. But the gears mesh, so that one complete revolution of A results in four complete revolutions of gear B. And since gears B and C have the same number of teeth, one revolution of B results in one revolution of C. Thus the blades revolve four times as fast as the crank handle.

In chapter 1 you learned that third-class levers increase speed at the expense of force. The same thing happens with this egg beater. The magnitude of the force is changed. The force required to turn the handle is greater than

the force applied to the frosting by the blades. Therefore a mechanical advantage of less than one results.

### TYPES OF GEARS

When two shafts are not lying in the same straight line, but are parallel, motion can be transmitted from one to the other by means of spur gears. This setup is shown in figure 6-2.

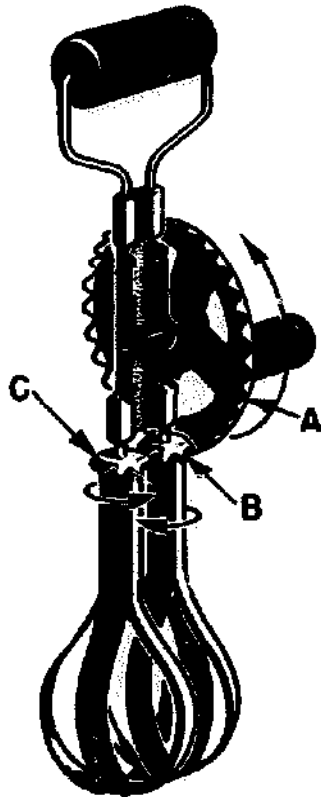
Spur gears are wheels with mating teeth cut in their surfaces so that one can turn the other without slippage. When the mating teeth are cut so that they are parallel to the axis of rotation, as shown in figure 6-2, the gears are called straight spur gears.

When two gears of unequal size are meshed together, the smaller of the two is usually called a pinion. By unequal size, we mean an unequal number of teeth causing one gear to be of a larger diameter than the other. The teeth, themselves, must be of the same size in order to mesh properly.

The most commonly used type are the straight spur gears, but quite often you'll run across another type of spur gear called the helical spur gear.

In helical gears the teeth are cut slantwise across the working face of the gear. One end of the tooth, therefore, lies ahead of the other. In other words, each tooth has a leading end and a trailing end. A look at these gears in figure 6-3A will show you how they're constructed.

In the straight spur gears the whole width of the teeth comes in contact at the same time. But with helical (spiral) gears contact between two teeth starts first at the leading ends and moves progressively across the gear faces until the trailing ends are in contact. This kind of meshing action keeps the gears in constant contact with one another. Therefore, less lost



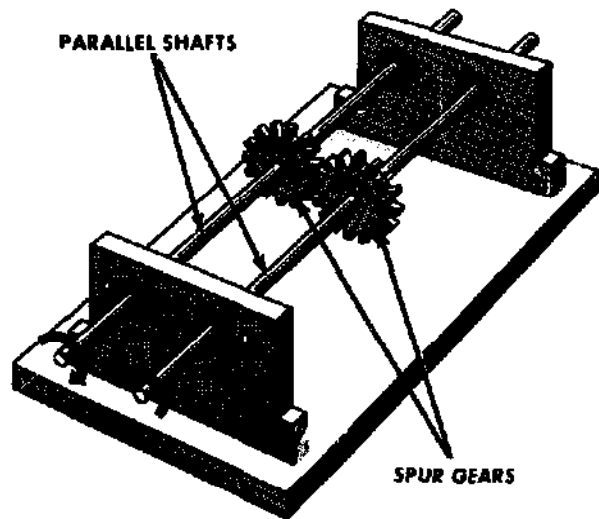
131.25  
Figure 6-1.—A simple gear arrangement.

motion and smoother, quieter action is possible. One disadvantage of this helical spur gear is the tendency of each gear to thrust or push axially on its shaft. It is necessary to put a special thrust bearing at the end of the shaft to counteract this thrust.

Thrust bearings are not needed if herringbone gears like those shown in figure 6-4 are used. Since the teeth on each half of the gear are cut in opposite directions, each half of the gear develops a thrust which counterbalances that of the other half. You'll find herringbone gears used mostly on heavy machinery.

Figure 6-3 also shows you three other gear arrangements in common use.

The internal gear in figure 6-3B has teeth on the inside of a ring, pointing inward toward the axis of rotation. An internal gear is always meshed with an external gear, or pinion, whose



5.22.1  
Figure 6-2.—Spur gears coupling two parallel shafts.

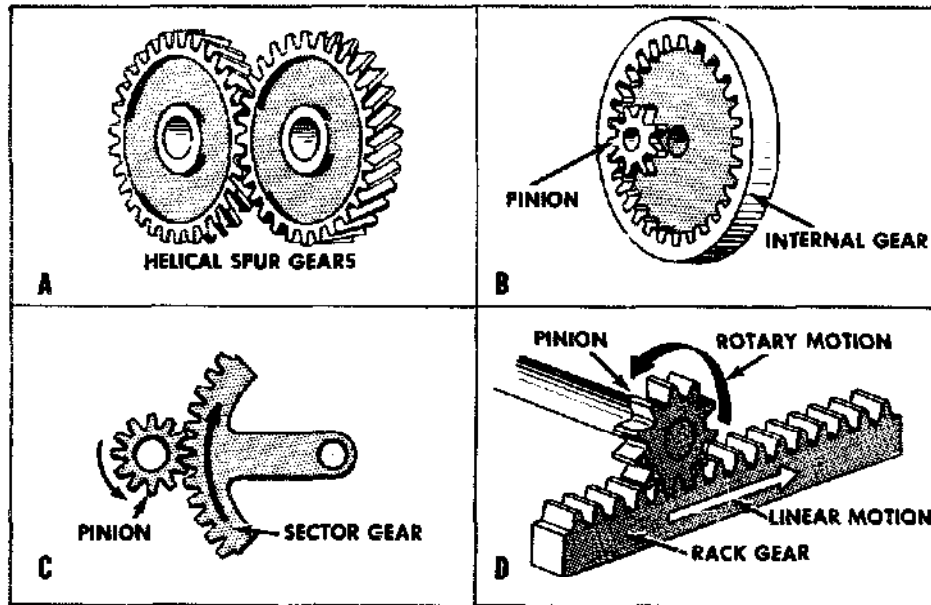
center is offset from the center of the internal gear. Either the internal or pinion gear can be the driver gear, and the gear ratio is calculated the same as for other gears—by counting teeth.

Often only a portion of a gear is needed where the motion of the pinion is limited. In this case the sector gear (fig. 6-3C) is used to save space and material. The rack and pinion in figure 6-3D are both spur gears. The rack may be considered as a piece cut from a gear with an extremely large radius. The rack-and-pinion arrangement is useful in changing rotary motion into linear motion.

**THE BEVEL GEAR.**—So far most of the gears you've learned about transmit motion between parallel shafts. But when shafts are not parallel (at an angle), another type of gear is used—the bevel gear. This type of gear can connect shafts lying at any given angle because they can be beveled to suit the angle.

Figure 6-5A shows a special case of the bevel gear—the miter gear. A pair of miter gears is used to connect shafts having a 90° angle, which means the gear faces are beveled at a 45° angle.

You can see in figure 6-5B how bevel gears are designed to join shafts at any angle. Gears cut at any angle other than 45° are called just plain bevel gears.



5.23:24

Figure 6-3.—Gear types.

The gears shown in figure 6-5 are called straight bevel gears, because the whole width of each tooth comes in contact with the mating tooth at the same time. However, you'll also run across spiral bevel gears with teeth cut so as to have advanced and trailing ends. Figure 6-6 shows you what spiral bevel gears look like. They have the same advantages as

other spiral (helical) gears—less lost motion and smoother, quieter operation.

**THE WORM AND WORM WHEEL.**—Worm and worm-wheel combinations, like those in figure 6-7, have many uses and advantages. But it's better to understand their operating theory before learning of their uses and advantages.

Figure 6-7A shows the action of a single-thread worm. For each revolution of the worm,

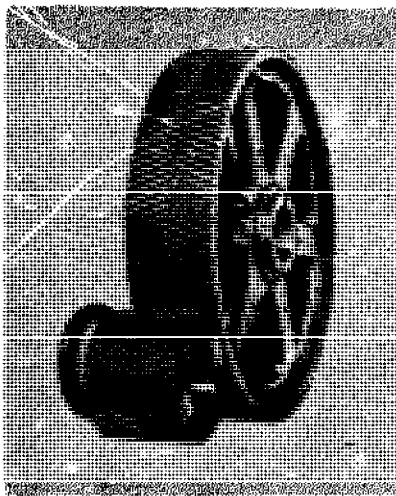
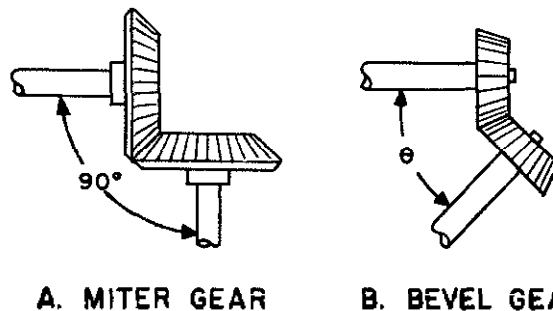


Figure 6-4.—Herringbone gear.

5.22.3



A. MITER GEAR

B. BEVEL GEAR

5.22.4

Figure 6-5.—Bevel gears.

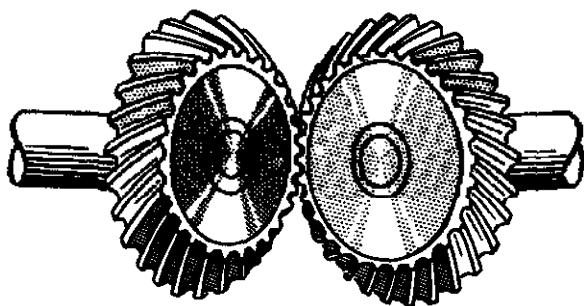


Figure 6-6.—Spiral bevel gears.

5.22.6

the worm wheel turns one tooth. Thus if the worm wheel has 25 teeth the gear ratio is 25:1.

Figure 6-7B shows a double-thread worm. For each revolution of the worm in this case, the worm wheel turns two teeth. That makes the gear ratio 25:2 if the worm wheel has 25 teeth.

Likewise, a triple-threaded worm would turn the worm wheel three teeth per revolution of the worm.

A worm gear is really a combination of a screw and a spur gear. Tremendous mechanical advantages can be obtained with this arrangement. Worm drives can also be designed so that only the worm is the driver—the

spur cannot drive the worm. On a hoist, for example, you can raise or lower the load by pulling on the chain which turns the worm. But if you let go of the chain, the load cannot drive the spur gear and let the load drop to the deck. This is a non-reversing worm drive.

#### CHANGING DIRECTION WITH GEARS

No doubt you know that the crankshaft in an automobile engine can turn in only one direction. If you want the car to go backwards, the effect of the engine's rotation must be reversed. This is done by a reversing gear in the transmission, not by reversing the direction in which the crankshaft turns.

A study of figure 6-8 will show you how gears are used to change the direction of motion. This is a schematic diagram of the sight mounts on a Navy gun. If you crank the range-adjusting handle A in a clockwise direction the gear B directly above it is made to rotate in a counter-clockwise direction. This motion causes the two pinions C and D on the shaft to turn in the same direction as gear B against the teeth cut in the bottom of the table. The table is tipped in the direction indicated by the arrow.

As you turn the deflection-adjusting handle E in a clockwise direction the gear F directly above it turns in the opposite direction. Since the two bevel gears G and H are fixed on the

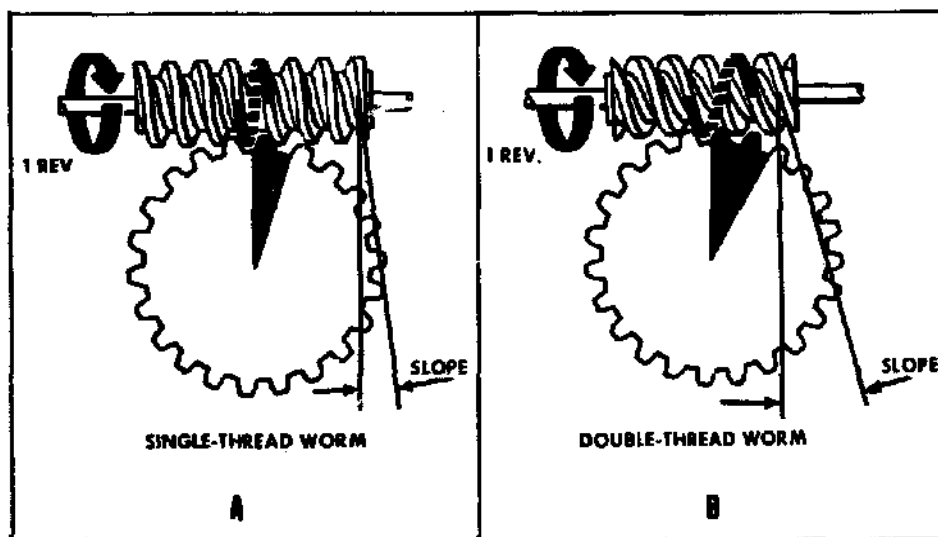
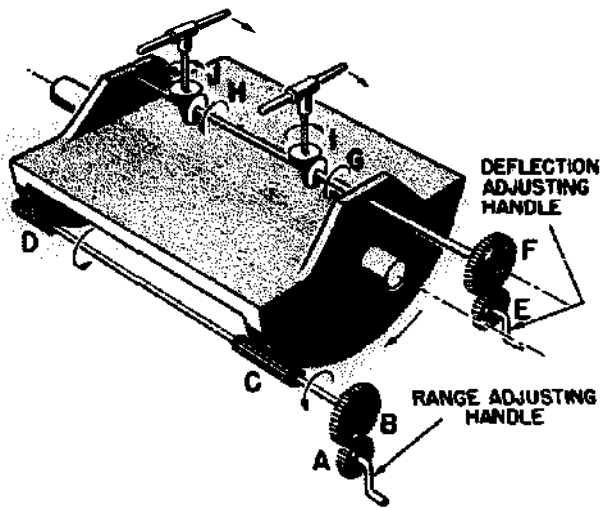


Figure 6-7.—Worm gears.

5.22.9



131.26  
Figure 6-8.—Gears change direction of applied motion.

shaft with F, they also turn. These bevel gears, meshing with the horizontal bevel gears I and J, cause I and J to swing the front ends of the telescopes to the right. Thus with a simple system of gears, it is possible to keep the two telescopes pointed at a moving target. In this and many other practical applications, gears serve one purpose—to change the direction of motion.

**CHANGING SPEED**

As you've already seen in the egg-beater, gears can be used to change the speed of motion. Another example of this use of gears is found in your clock or watch. The mainspring slowly unwinds and causes the hour hand to make one revolution in 12 hours. Through a series—or train—of gears, the minute hand makes one revolution each hour, while the second hand goes around once per minute.

Figure 6-9 will help you to understand how speed changes are made possible. Wheel A has 10 teeth which mesh with the 40 teeth on wheel B. Wheel A will have to rotate four times to cause B to make one revolution. Wheel C is rigidly fixed on the same shaft with B. Thus C makes the same number of revolutions as B. However, C has 20 teeth, and meshes with wheel D which has only 10 teeth. Hence, wheel D turns twice as fast as wheel C.

Now, if you turn A at a speed of four revolutions per second, B will be rotated at one revolution per second. Wheel C also moves at one revolution per second, and causes D to turn at two revolutions per second. You get out two revolutions per second after having put in four revolutions per second. Thus the overall speed reduction is 2/4—or 1/2—which means that you got half the speed out of the last driven wheel that you put into the first driver wheel.

You can solve any gear speed-reduction problem with this formula—

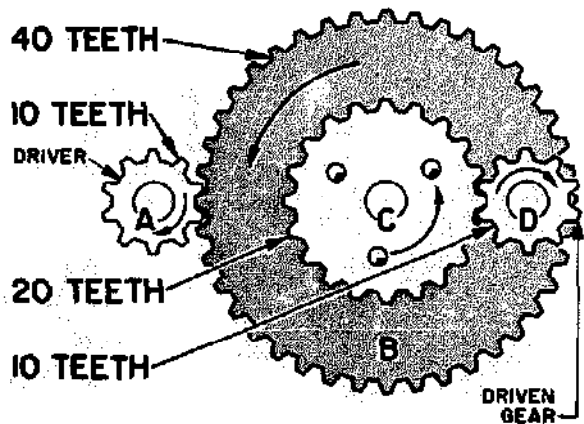
$$S_2 = S_1 \times \frac{T_1}{T_2}$$

where

- S<sub>1</sub> = speed of first shaft in train
- S<sub>2</sub> = speed of last shaft in train
- T<sub>1</sub> = product of teeth on all drivers
- T<sub>2</sub> = product of teeth on all driven gears

Now use the formula on the gear train of figure 6-8.

$$S_2 = S_1 \times \frac{T_1}{T_2} = 4 \times \frac{10 \times 20}{40 \times 10} = \frac{800}{400} = 2 \text{ revs. per sec.}$$



131.27  
Figure 6-9.—Gears can change speed of applied motion.

Almost any increase or decrease in speed can be obtained by choosing the correct gears for the job. For example, the turbines on a ship have to turn at high speeds—say 5800 rpm—if they are going to be efficient. But the propellers, or screws, must turn rather slowly—say 195 rpm—to push the ship ahead with maximum efficiency. So, a set of reduction gears is placed between the turbines and the propeller shaft.

When two external gears mesh, they rotate in opposite directions. Often you'll want to avoid this. Put a third gear, called an idler, between the driver and the driven gear. But don't let this extra gear confuse you on speeds. Just neglect the idler entirely. It doesn't change the gear ratio at all, and the formula still applies. The idler merely makes the driver and its driven gear turn in the same direction. Figure 6-10 will show you how this works.

**MAGNIFYING FORCE WITH GEARS**

Gear trains are used to increase the mechanical advantage. In fact, wherever there is a speed reduction, the effect of the effort you apply is multiplied. Look at the cable winch in figure 6-11. The crank arm is 30 inches long, and the drum on which the cable is wound has a 15-inch radius. The small pinion gear has 10

teeth, which mesh with the 60 teeth on the internal spur gear. You will find it easier to figure the mechanical advantage of this machine if you think of it as two machines.

First, figure out what the gear and pinion do for you. The theoretical mechanical advantage of any arrangement of two meshed gears can be found by the following formula—

$$M. A. \text{ (theoretical)} = \frac{T_o}{T_a}$$

In which,  $T_o$  = number of teeth on driven gear;

$T_a$  = number of teeth on driver gear.

In this case,  $T_o = 60$  and  $T_a = 10$ . Then,

$$M. A. \text{ (theoretical)} = \frac{T_o}{T_a} = \frac{60}{10} = 6$$

Now, for the other part of the machine, which is a simple wheel-and-axle arrangement consisting of the crank arm and the drum. The theoretical mechanical advantage of this can be found by dividing the distance the effort moves— $2\pi R$ —in making one complete revolution, by the distance the cable is drawn up in one revolution of the drum— $2\pi r$ .

$$M. A. \text{ (theoretical)} = \frac{2\pi R}{2\pi r} = \frac{R}{r} = \frac{30}{15} = 2$$

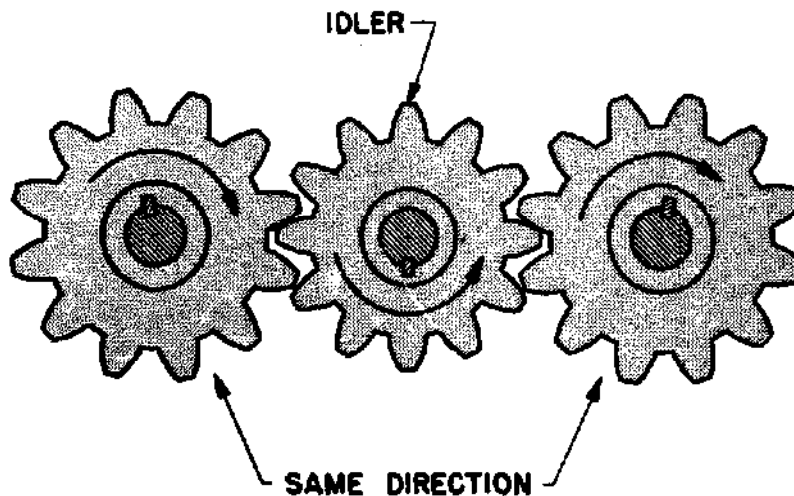
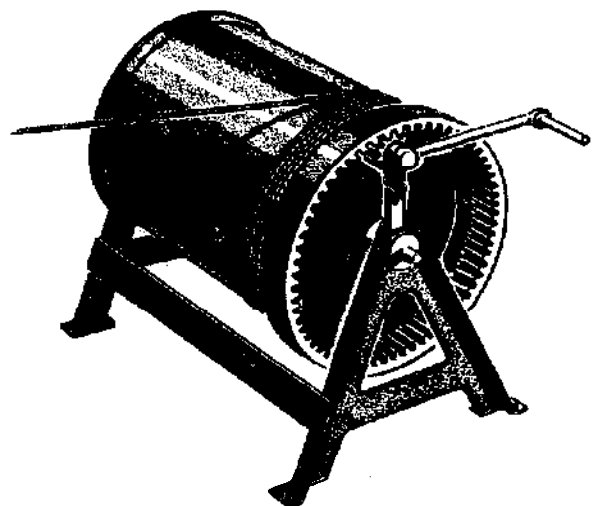


Figure 6-10.—An idler gear.

12.55



131.28

Figure 6-11.—This magnifies your effort.

You know that the total, or overall, theoretical mechanical advantage of a compound machine is equal to the product of the mechanical advantages of the several simple machines that make it up. In this case you considered the winch as being two machines—one having an M. A. of 6, and the other an M. A. of 2. Therefore, the over-all theoretical mechanical advantage of the winch is  $6 \times 2$ , or 12. Since friction is always present, the actual mechanical advantage may be only 7 or 8. Even so, by applying a force of 100 pounds on the handle, you could lift a load of 700 or 800 pounds.

You use gears to produce circular motion. But you often want to change rotary motion into up-and-down or linear motion. You can use cams to do this. For example—

The cam shaft in figure 6-12 is turned by the gear. A cam is keyed to the shaft and turns with it. The cam has an irregular shape which is designed to move the valve stem up and down, giving the valve a straight-line motion as the cam shaft rotates.

When the cam shaft rotates, the high point—lobe—of the cam raises the valve to its open position. As the shaft continues to rotate, the high point of the cam is passed and the valve is lowered to closed position.

A set of cams, two to a cylinder, driven by timing gears from the crankshaft operate the exhaust and intake valves on the gasoline automobile engine as shown in figure 6-13. Cams are widely used in machine tools and other devices to make rotating gears and shafts do up-and-down work.

#### SUMMARY

These are the important points you should keep in mind about gears—

Gears can do a job for you by changing the direction, speed, or size of the force which you apply.

When two external gears mesh, they always turn in opposite directions. You can make them turn in the same direction by placing an idler gear between the two.

The product of the number of teeth on each of the driver gears, divided by the product of the number of teeth on each of the driven gears, gives you the speed ratio of any gear train.

The theoretical mechanical advantage of any gear train is the product of the number of teeth on the driven gear wheels, divided by the product of the number of teeth on the driver gears.

The overall theoretical mechanical advantage of a compound machine is equal to the product of the theoretical mechanical advantages of all the simple machines which make it up.

Cams are used to change rotary motion into linear motion.

One of the gear systems you'll get to see frequently aboard ship is that on the anchor winch. Figure 6-14 shows you one type in which you can readily see how the wheels go 'round. The driving gear A is turned by the winch engine or motor. This gear has 22 teeth, which mesh with the 88 teeth on the large wheel B. Thus, you know that the large wheel makes one revolution for every four revolutions of the driving gear A. You get a 4-to-1 theoretical mechanical advantage out of that pair. Secured to the same shaft with B is the small spur gear C, covered up here. The gear C has 30 teeth which mesh with the 90 teeth on the large gear D, also covered up. The advantage from C to D is

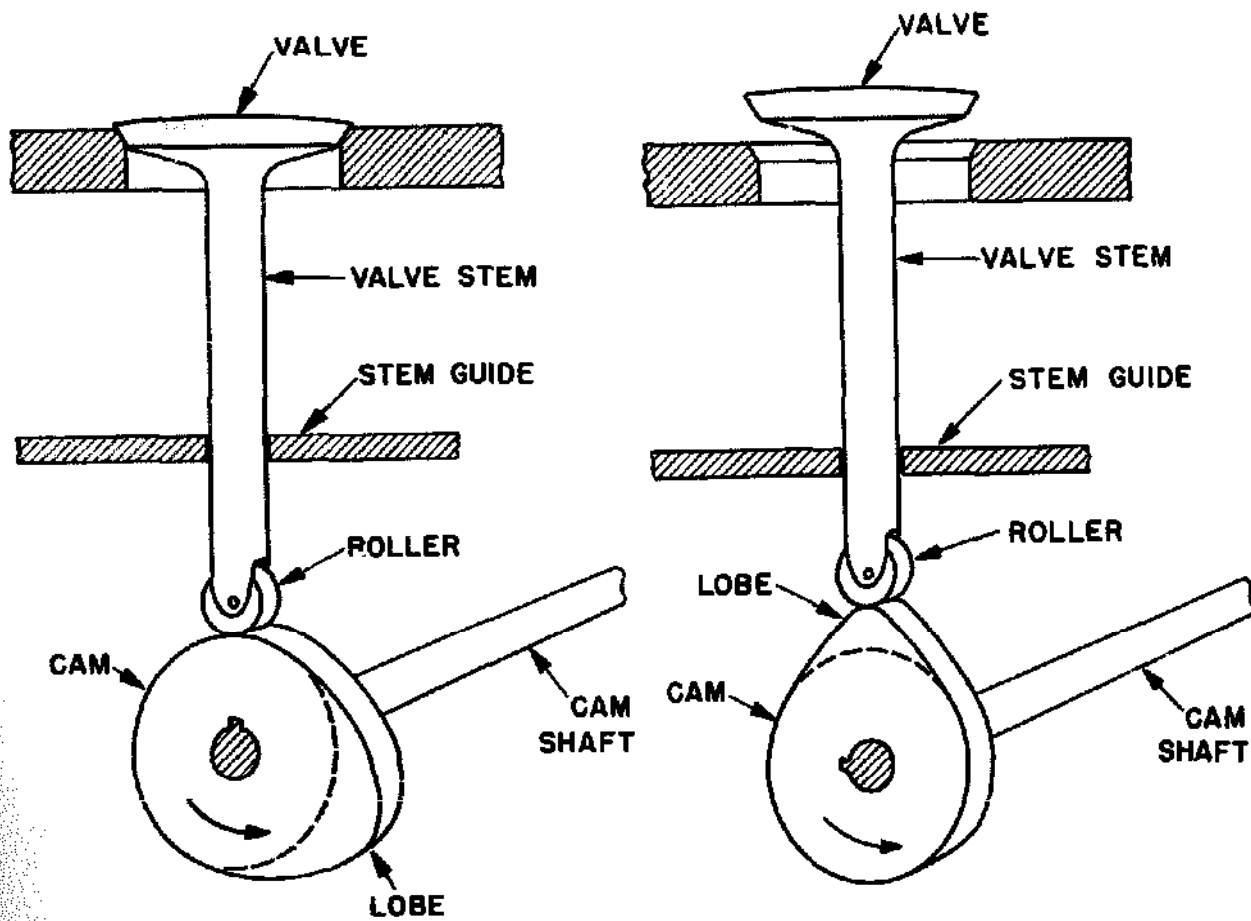


Figure 6-12.—Cam-driven valve.

131.29

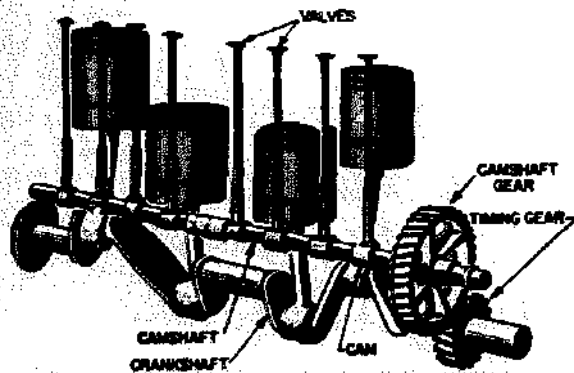


Figure 6-13.—Automobile valve gear.

131.30

3 to 1. The sprocket wheel to the far left, on the same shaft with D, is called a wildcat. The anchor chain is drawn up over this. Every second link is caught and held by the protruding teeth of the wildcat. The overall mechanical advantage of the winch is  $4 \times 3$ , or 12 to 1.

Figure 6-15 shows you an application of the rack and pinion as a steering mechanism. Turning the ship's wheel turns the small pinion A. This pinion causes the internal spur gear to turn. Notice that there is a large mechanical advantage in the arrangement.

Now you see that center pinion P turns. It meshes with the two vertical racks. When the wheel is turned full to the right, one rack moves downward and the other moves upward to the positions of the racks. Attached to the bottom



of the racks are two hydraulic pistons which control the steering of the ship. You'll get some information on this hydraulic system in a later chapter.

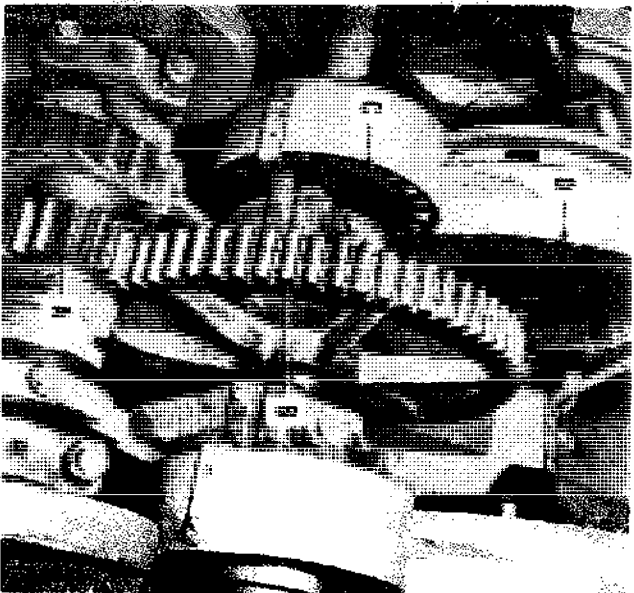


Figure 6-14.—An anchor winch.  
131.31

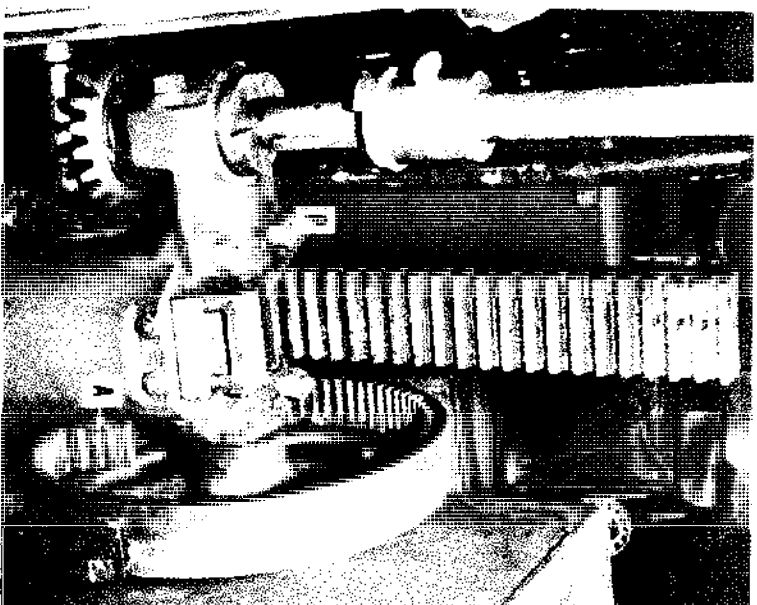


Figure 6-15.—A steering mechanism.  
131.32

## CHAPTER 7

# WORK

### MEASUREMENT

You know that machines help you to do work. But just what is work? Work doesn't mean simply applying a force. If that were so, you would have to consider that Big-Boy, busily applying his 220-pound force on the sea bag in figure 7-1 is doing work. But no work is being done!

Work, in the mechanical sense of the term, is done when a resistance is overcome by a force acting through a measureable distance. Now, if Big-Boy were to lift his 90-pound bag off the deck and put it on his bunk, he would be doing work. He would be overcoming a resistance by applying a force through a distance.

Notice that two factors are involved—force and movement through a distance. The force is normally measured in pounds, and the distance in feet. Work, therefore, is commonly measured in units called foot-pounds. You do one foot-pound of work when you lift a one-pound weight through a height of one foot. But—you also do one foot-pound of work when you apply one pound of force on any object through a distance of one foot. Writing this as a formula, it becomes—

$$\text{WORK} = \text{FORCE} \times \text{DISTANCE}$$

(foot-pounds) = (pounds) x (feet)

Thus, if the sailor lifts a 90-pound bag through a vertical distance of 5 feet, he will do—

$$\text{WORK} = 90 \times 5 = 450 \text{ ft-lb.}$$

There are two points concerning work that you should get straight right at the beginning.

First, in calculating the work done you measure the actual resistance being overcome. This is not necessarily the weight of the object being

moved. To make this clear, look at the job the bluejacket in figure 7-2 is doing. He is pulling a 900-pound load of supplies 200 feet along the dock. Does this mean that he is doing 900 times 200, or 180,000 foot-pounds of work? Of course not. He isn't working against the pull of gravity—or the total weight—of the load. He's pulling only against the rolling friction of the truck, and that may be as little as 90 pounds. That is the resistance which is being overcome. Always be sure that you know what resistance is being overcome by the effort, as well as the distance through which it is moved. The resistance in one case may be the weight of the object; in another it may be the frictional resistance of the object as it is dragged or rolled along the deck.

The second point to hold in mind is that you have to move the resistance to do any work on it. Look at Willie in figure 7-3. The poor guy has been holding that suitcase for the past 15 minutes waiting for the bus. His arm is getting tired; but according to the definition of work, he isn't doing any—because he isn't moving the suitcase. He is merely exerting a force against the pull of gravity on the bag.

You already know about the mechanical advantage of a lever. Now consider it in terms of getting work done easily. Look at figure 7-4. The load weighs 300 pounds, and you want to lift it up onto a platform a foot above the deck. How much work must you do on it? Since 300 pounds must be raised one foot, 300 times 1, or 300 foot-pounds of work must be done. You can't make this weight any smaller by the use of any machine. However, if you use the eight-foot plank as shown, you can do that amount of work, by applying a smaller force through a longer distance. Notice that you have a mechanical advantage of 3, so that a 100-pound push down on the end of the plank will raise the 300-pound crate. Through how long a distance will you have to exert that 100-pound push? Neglecting



131.33

Figure 7-1.—No work is being done.

friction—and in this case you can safely do so—the work done on the machine is equal to the work done by the machine. Say it this way—

Work put in = work put out.

And since Work = force x distance, you can substitute "force times distance" on each side of the work equation. Thus—

$$F_1 \text{ times } S_1 = F_2 \text{ times } S_2$$

in which,

$F_1$  = effort applied, in pounds

$S_1$  = distance through which effort moves, in feet

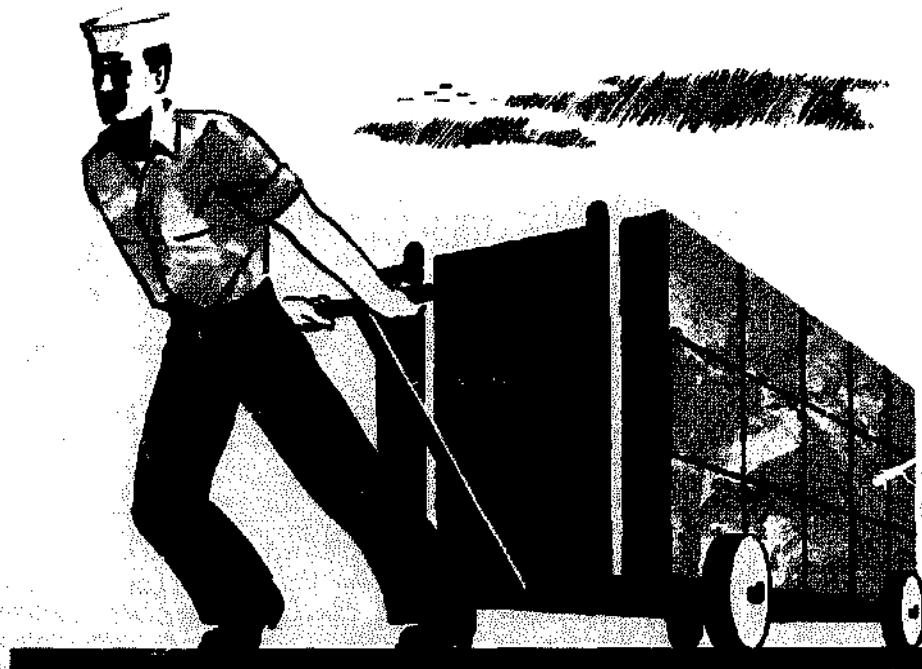
$F_2$  = resistance overcome, in pounds

$S_2$  = distance resistance is moved, in feet

Now substitute the known values, and you obtain—

$$100 \text{ times } S_1 = 300 \text{ times } 1$$

$$S_1 = 3 \text{ feet}$$



131.34

Figure 7-2.—Working against friction.



131.35

Figure 7-3.—No motion no work.

The advantage of using the lever is not that it makes any less work for you, but that it allows you to do the job with the force at your command. You'd probably have some difficulty lifting 300 pounds directly upward without a machine to help you!

A block and tackle also makes work easier. But like any other machine, it can't decrease the total amount of work to be done. With a rig like the one shown in figure 7-5, the bluejacket has a mechanical advantage of 5, neglecting friction. Notice that five parts of the rope go to and from the movable block. To raise the 600-pound load 20 feet, he needs to exert a pull of only 1/5 of 600—or 120 pounds. But—he is going to have to pull more than 20 feet of rope through his hands in order to do this. Use the formula again to figure why this is so—

Work input = work output

$$F_1 \times S_1 = F_2 \times S_2$$

And by substituting the known values—

$$120 \times S = 600 \times 20$$

$$S_1 = 100 \text{ feet.}$$

This means that he has to pull 100 feet of rope through his hands in order to raise the load 20 feet. Again, the advantage lies in the fact that a relatively small force operating through a large distance can move a big load through a small distance.

The sailor busy with the big piece of machinery in figure 7-6 has his work cut out for him. He is trying to seat the machine square on its foundations. The rear end must be shoved over one-half foot against a frictional resistance of 1,500 pounds. The amount of work to be done is  $1,500 \times 1/2$ , or 750 foot-pounds. He will have to do at least this much work on the jack he is using. If the jack has a 2 1/2-foot handle— $R = 2 1/2 \text{ ft}$ —and the pitch of the jack screw is 1/4 inch, he can do the job with little effort. Neglecting friction, you can figure it out this way—

Work input = work output

$$F_1 \times S_1 = F_2 \times S_2$$

In which

$F_1$  = force in pounds applied on the handle;  
 $S_1$  = distance, in feet, that the end of the handle travels in one revolution;

$F_2$  = resistance to be overcome;  
 $S_2$  = distance in feet that head of jack is advanced by one revolution of the screw.  
 Or, the pitch of the screw.

And, by substitution,

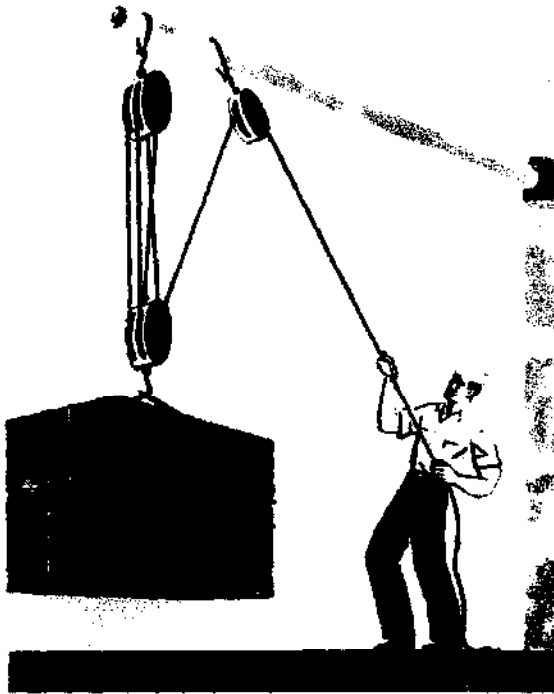
$$F_1 \times 2R = 1500 \times 1/48,$$

since  $1/4'' = 1/48$  of a foot

$$F_1 \times 2 \times 2 1/2 = 1500 \times 1/48$$

$$F_1 = 2 \text{ pounds}$$

The jack makes it theoretically possible for the sailor to exert a 1,500-pound push with a 2-pound effort, but look at the distance through which he must apply that effort. One complete turn of the handle represents a distance of 15.7 feet. That 15.7-foot rotation advances the piece of machinery only 1/4th of an inch—or 1/48th of a foot. Force is gained at the expense of distance.



131.37

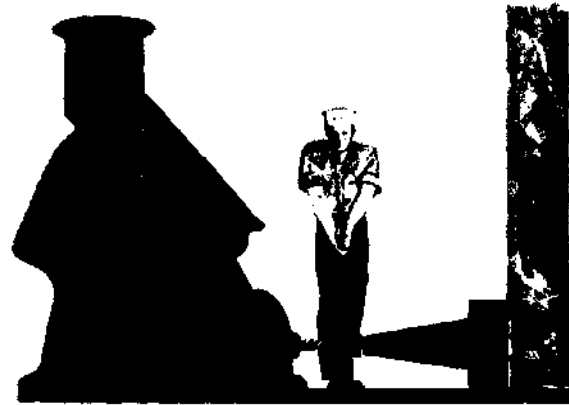
Figure 7-5.—A block and tackle makes work easier.

lump of sugar on a table and give each an equal push, the marble will move farther. This is because rolling friction is always less than sliding friction. You take advantage of this fact whenever you use ball bearings or roller bearings. See figure 7-7.

Remember that rolling friction is always less than sliding friction. The Navy takes advantage of that fact. Look at figure 7-8. This roller chock not only cuts down the wear and tear on lines and cables which are run through it, but—by reducing friction—also reduces the load the winch has to work against.

The roller bitt in figure 7-9 is another example of how you can cut down the wear and tear on lines or cable and also reduce your frictional loss.

When it is necessary to have one surface move over another, you can decrease the friction by the use of lubricants, such as oil, grease, or soap. You will use lubricants on flat surfaces, gun slides for example, as well as on ball and



131.38

Figure 7-6.—A big push.

roller bearings, to further reduce the frictional resistance and to cut down the wear.

Don't forget that in a lot of situations friction is mighty helpful, however. Many a blue-jacket has found out about this the hard way—on a wet, slippery deck. On some of our ships you'll find that a rough-grained deck covering is used. Here you have friction working for you. It helps you to keep your footing.

#### EFFICIENCY

Up to this point you have been neglecting the effect of friction on machines. This makes it easier to explain machine operation, but you know from practical experience that friction is involved every time two surfaces move against one another. And the work used in overcoming the frictional resistance does not appear in the work output. Since this is so, it's obvious that you have to put more work into a machine than you get out of it. In other words, no machine is 100 percent efficient.

Take the jack in figure 7-6, for example. The chances are good that a 2-pound force exerted on the handle wouldn't do the job at all. More likely a pull of at least 10 pounds would be required. This indicates that only 2 out of the 10 pounds, or 20 percent of the effort is usefully employed to do the job. The remaining 8 pounds of effort were consumed in overcoming the friction in the jack. Thus, the jack has an efficiency of only 20 percent. Most jacks are inefficient, but even with this inefficiency, it is possible to deliver a huge push with a small amount of effort.

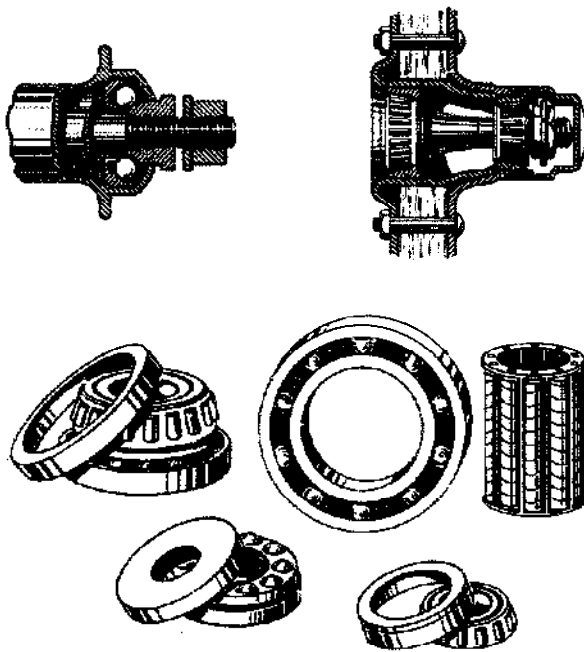
Actually,  $50 \div 0.60 = 83.3$  pounds. You can check this yourself in the following manner—

$$\begin{aligned} \text{Efficiency} &= \frac{\text{Output}}{\text{Input}} \\ &= \frac{F_2 \times S_2}{F_1 \times S_1} \end{aligned}$$

One revolution of the drum would raise the 600-pound load a distance  $S_2$  of  $2\pi r$  or 7.85 feet. To make the drum revolve once, the pinion gear must be rotated six times by the handle; and the handle must be turned through a distance  $S_1$  of  $6 \times 2\pi R$ , or 94.2 feet. Then, by substitution—

$$0.60 = \frac{600 \times 7.85}{F_1 \times 94.2}$$

$$F_1 = \frac{600 \times 7.85}{94.2 \times 0.60} = 83.3 \text{ pounds.}$$



12.50

Figure 7-7.—These reduce friction.

A simple way to calculate the efficiency of a machine is to divide the output by the input—convert to percentage

$$\text{Efficiency} = \frac{\text{Output}}{\text{Input}}$$

Now go back to the block-and-tackle problem illustrated in figure 7-5. It's likely that instead of being able to lift the load with a 120-pound pull, the bluejacket would perhaps have to use a 160-pound pull through the 100 feet. You can calculate the efficiency of the rig by the following method—

$$\text{Efficiency} = \frac{\text{output}}{\text{input}} = \frac{F_2 \times S_2}{F_1 \times S_1}$$

and, by substitution,

$$= \frac{600 \times 20}{160 \times 100} = 0.75 \text{ or } 75 \text{ percent.}$$

Theoretically, with the mechanical advantage of twelve developed by the cable winch back in figure 6-11 you should be able to lift a 600-pound load with a 50-pound push on the handle. If the machine has an efficiency of 60 percent, how big a push would you actually have to apply?



131.39

Figure 7-8.—It saves wear and tear.

Because this machine is only 60-percent efficient, you have to put  $94.2 \times 83.3$ , or 7,847 foot-pounds of work into it in order to get 4,710 foot-pounds of work out of it. The difference— $7,847 - 4,710$  3,137 foot-pounds—is used to overcome friction within the machine.

### SUMMARY

Here are some of the important points you should remember about friction, work, and efficiency—

You do work when you apply a force against a resistance and move the resistance.

Since force—measured in pounds—and distance—measured in feet—are involved, work is measured in foot-pounds. One foot-pound of work is the result of a one-pound force, acting against a resistance through a distance of one foot.

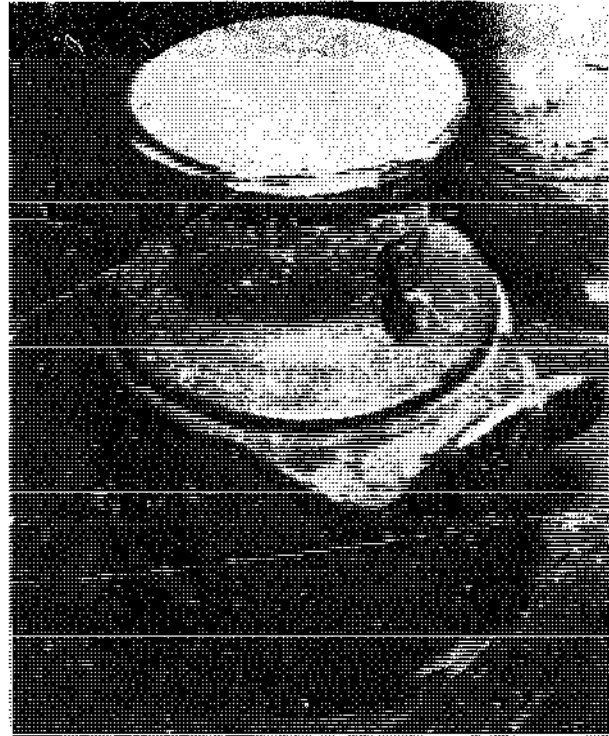
Machines help you to do work by making it possible to move a large resistance through a small distance by the application of a small force through a large distance.

Since friction is present in all machines, more work must be done on the machine than the machine actually does on the load.

The efficiency of any machine can be found by dividing the output by the input.

The resistance that one surface offers to movement over a second surface is called friction.

Friction between two surfaces depends upon the nature of the materials and the magnitude of the forces pushing them together.



131.40  
Figure 7-9.—Roller bitt saves line.

## CHAPTER 8

# POWER

It's all very well to talk about how much work a man can do, but the payoff is how long it takes him to do it. Look at "Lightning" in figure 8-1. He has lugged 3 tons of bricks up to the second deck of the new barracks. However, it has taken him three 10-hour days—1800 minutes—to do the job. In raising the 6000 pounds 15 feet he did 90,000 foot-pounds of work. Remember—force x distance = work. Since it took him 1800 minutes, he has been working at the rate of  $90,000 \div 1800$ , or 50 foot-pounds of work per minute.

That's power—the rate of doing work. Thus, power always includes the time element. Doubtless you could do the same amount of work in one 10-hour day, or 600 minutes—which would mean that you would work at the rate of  $90,000 \div 600 = 150$  foot-pounds per minute. You then would have a power value three times as great as that of "Lightning."

By formula—

$$\text{Power} = \frac{\text{Work, in ft-lb}}{\text{Time, in minutes}}$$

### HORSEPOWER

You measure force in pounds; distance in feet; work in foot-pounds. What is the common unit used for measuring power? The horsepower. If you want to tell someone how powerful an engine is, you could say that it is so many times more powerful than a man, or an ox, or a horse. But what man, and whose ox or horse? James Watt, the fellow who invented the steam engine, compared his early models with the horse. By experiment, he found that an average horse could lift a 330-pound load straight up through a distance of 100 feet in one minute. Figure 8-2 shows you the type of rig he used to find this out. By agreement among scientists, that figure of 33,000 foot-pounds of work done in one minute has been

accepted as the standard unit of power, and it is called a horsepower—hp.

Since there are 60 seconds in a minute, one horsepower is also equal to  $\frac{33,000}{60} = 550$  foot-pounds per second. By formula—

$$\text{Horsepower} = \frac{\text{Power (in ft-lb per min)}}{33,000}$$

### CALCULATING POWER

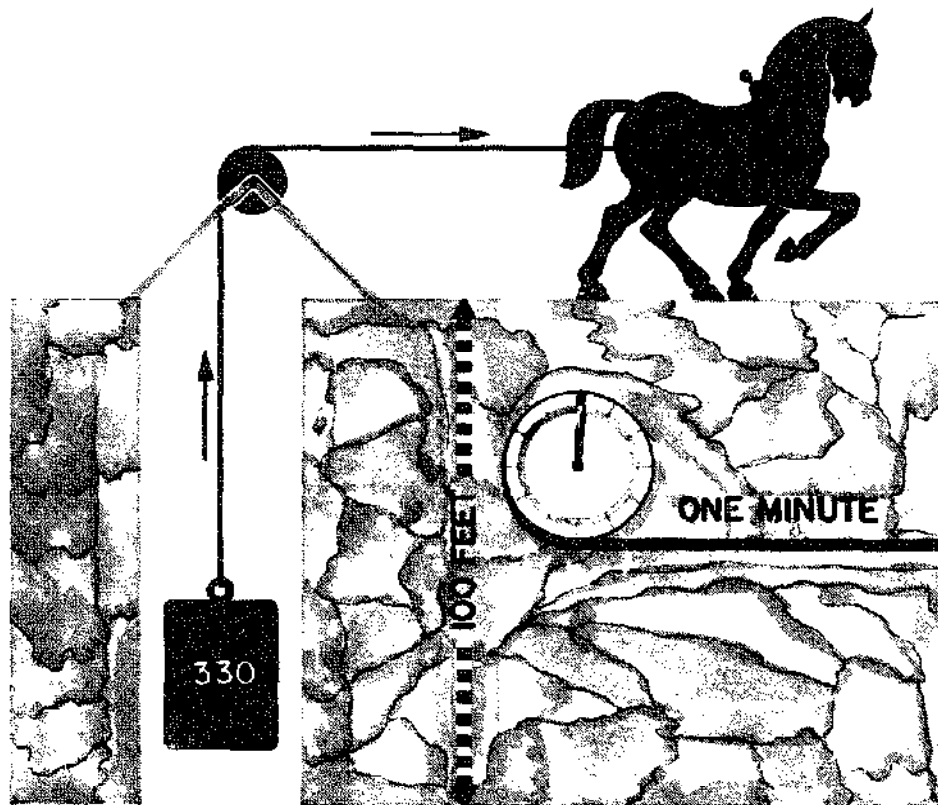
It isn't difficult to figure how much power is needed to do a certain job in a given length of time, nor to predict what size engine or motor is



Figure 8-1.—Get a horse.

131.41





131.42

Figure 8-2.—One horsepower.

needed to do it. Suppose an anchor winch must raise a 6,600-pound anchor through 120 feet in 2 minutes. What must be the theoretical horsepower rating of the motor on the winch?

The first thing to do is to find the rate at which the work must be done. You see the formula—

$$\text{Power} = \frac{\text{work}}{\text{time}} = \frac{\text{force} \times \text{distance}}{\text{time}}$$

Substitute the known values in the formula, and you get—

$$\text{Power} = \frac{6,600 \times 120}{2} = 396,000 \text{ ft-lb/min}$$

So far, you know that the winch must work at a rate of 396,000 ft-lb/min. To change this rate to horsepower, you divide by the rate at

which the average horse can work—33,000 ft-lb/min.

$$\begin{aligned} \text{Horsepower} &= \frac{\text{Power (ft-lb/min)}}{33,000} = \\ &= \frac{396,000}{33,000} = 12 \text{ hp.} \end{aligned}$$

Theoretically, the winch would have to be able to work at a rate of 12 horsepower in order to get the anchor raised in 2 minutes. Of course, you've left out all friction in this problem, so the winch motor would actually have to be larger than 12 hp.

Planes are raised from the hangar deck to the flight deck of a carrier on an elevator. Some place along the line, an engineer had to figure out how powerful the motor had to be in order

to raise the elevator. It's not too tough when you know how. Allow a weight of 10 tons for the elevator, and 5 tons for the plane. Suppose that you want to raise the elevator and plane 25 feet in 10 seconds. And that the overall efficiency of the elevator mechanism is 70 percent. With that information you can figure what the delivery horsepower of the motor must be. Set up the formulas—

$$\text{Power} = \frac{\text{force} \times \text{distance}}{\text{time}}$$

$$\text{hp} = \frac{\text{power}}{33,000}$$

Substitute the known values in their proper places, and you have—

$$\text{power} = \frac{30,000 \times 25 \text{ ft}}{10/60 \text{ minute}} = 4,500,000 \text{ ft lb/min.}$$

$$\text{hp} = \frac{4,500,000}{33,000} = 136.4 \text{ hp.}$$

So, 136.4 horsepower would be needed if the engine had 100 percent overall efficiency. You want to use 70 percent efficiency, so you use the formula—

$$\text{Efficiency} = \frac{\text{Output}}{\text{Input}}$$

$$\text{Input} = \frac{136.4}{0.70} = 194.8 \text{ hp.}$$

This is the rate at which the engine must be able to work. To be on the safe side, you'd probably select a 200-horsepower auxiliary to do the job.

#### FIGURING THE HORSEPOWER RATING OF A MOTOR

You have probably seen the horsepower rating plates on electric motors. A number of methods may be used to determine this rating. One way that the rating of a motor or a steam or gas engine can be found is by the use of the prony brake. Figure 8-3 shows you the Prony brake setup. A pulley wheel is fixed to the shaft of the motor, and a leather belt is held firmly against the pulley. Attached to the two ends of the belt are spring scales. When the motor is standing still, each scale reads the same—say 15 pounds.

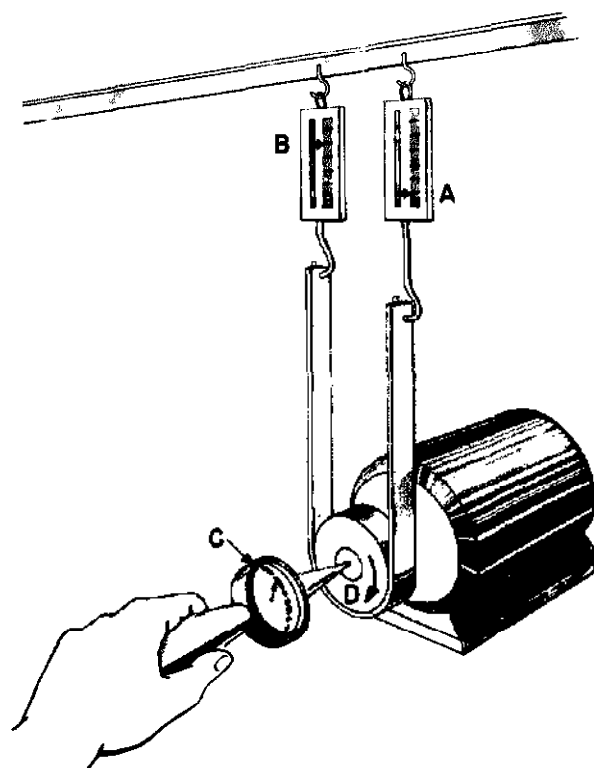


Figure 8-3.—A prony brake. 131.43

When the pulley turns in a clockwise direction, the friction between the belt and the pulley makes the belt try to move with the pulley. Therefore, pull on scale A will be greater, and the pull on scale B will be less than 15 pounds.

Suppose that scale A reads 25 pounds, and scale B reads 5 pounds. That tells you that the drag, or the force against which the motor is working, is 25-5=20 pounds. In this case the normal speed of the motor is 1800 rpm (revolutions per minute) and the diameter of the pulley is one foot.

The number of revolutions can be found by holding the revolution counter C against the end of the shaft for one minute. This counter will record the number of turns the shaft makes per minute. The distance D which any point on the pulley travels in one minute is equal to the circumference of the pulley times the number of revolutions— $3.14 \times 1 \times 1800 = 5652 \text{ ft.}$

You know that the motor is exerting a force of 20 pounds through that distance. The work done

in one minute is equal to the force times the distance, or work =  $F \times D = 20 \times 5,652 = 113,040$  ft -lb/min. Change this to horsepower—

$$\frac{113,040}{33,000} = 3.43 \text{ hp.}$$

Here are a few ratings for motors or engines with which you are familiar—an electric mixer

has a 1/16-hp motor; a washing machine a 1/4-hp motor.

#### SUMMARY

There are two important points for you to remember about Power—

Power is the rate at which work is done.

The unit in which power is measured is the horsepower, which is equivalent to working at a rate of 33,000 ft-lb per min, or 550 ft-lb per sec.

## CHAPTER 9

# FORCE AND PRESSURE

By this time you should have a pretty good idea of what a force is. A force is a push or a pull exerted on—or by—an object. You apply a force on a machine, and the machine in turn transmits a force to the load. Men and machines, however, are not the only things that can exert forces. If you've been out in a sailboat you know that the wind can exert a force. Further, you don't have to get knocked on your ear more than a couple of times by the waves to get the idea that water, too, can exert a force. As a matter of fact, from reveille to taps you are almost constantly either exerting forces or resisting them. That's the reason you are pooped when you hit the sack.

### MEASURING FORCES

You've had a lot of experience in measuring forces. You can estimate or "guess" the weight of a package you're going to mail by "hefting" it. Or you can put it on a scale to find its weight accurately. Weight is a common term that tells you how much force or pull gravity is exerting on the object.

You can readily measure force with a spring scale. An Englishman named Hooke discovered that if you hang a 1-pound weight on a spring, the spring stretches a certain distance. A 2-pound weight will extend the spring just twice as far, and 3 pounds will lengthen it three times as far as the 1-pound weight did. Right there is the makings of the spring scale. All you need to do is attach a pointer to the spring, put a face on the scale, and mark on the face the positions of the pointer for various loads in pounds or ounces.

This type of scale can be used to measure the pull of gravity—the weight—of an object, or the force of a pull exerted against friction, as shown in figure 9-1. Unfortunately, springs get tired, just as you do. When they get old, they don't always snap back to the original position. Hence an old spring or an overloaded spring will give inaccurate readings.

### HONEST WEIGHT—NO SPRINGS

Because springs do get tired, other types of force-measuring devices are made. You've seen the sign, "Honest Weight—No Springs", on the butchershop scales. Scales of this type are shown in figure 9-2. They are applications of first-class levers. The one shown in figure 9-2A is the simplest type. Since the distance from the fulcrum to the center of each platform is equal, the scale is balanced when equal weights are placed on the platforms. With your knowledge of levers, you will be able to figure out how the steel yard shown in figure 9-2B operates.

### PRESSURE

Have you ever tried to walk on crusted snow that would breakthrough when you put your weight on it? But you could walk on the same snow if you put on snowshoes. Further, you know that snowshoes do not reduce your weight—they merely distribute it over a larger area. In doing this, they reduce the pressure per square inch. Figure out how that works. If you weigh 160 pounds, that weight, or force, is more or less evenly distributed by the soles of your shoes. The area of the soles of an average man's shoes is roughly 60 square inches. Each one of those square inches has to carry  $160 \div 60 = 2.6$  pounds of your weight. Since 2.6 pounds per square inch is too much for the snow crust, you break through.

When you put on the snowshoes, you distribute your weight over an area of approximately 900 sq in.—depending, of course, on the size of the snowshoes. Now the force on each one of those square inches is equal to only  $160 \div 900 = 0.18$  pound. The pressure on the snow has been decreased, and the snow can easily support you.

Pressure is force per unit area—and is measured, in pounds per square inch—"psi." With snowshoes on, you exert a pressure of 0.18

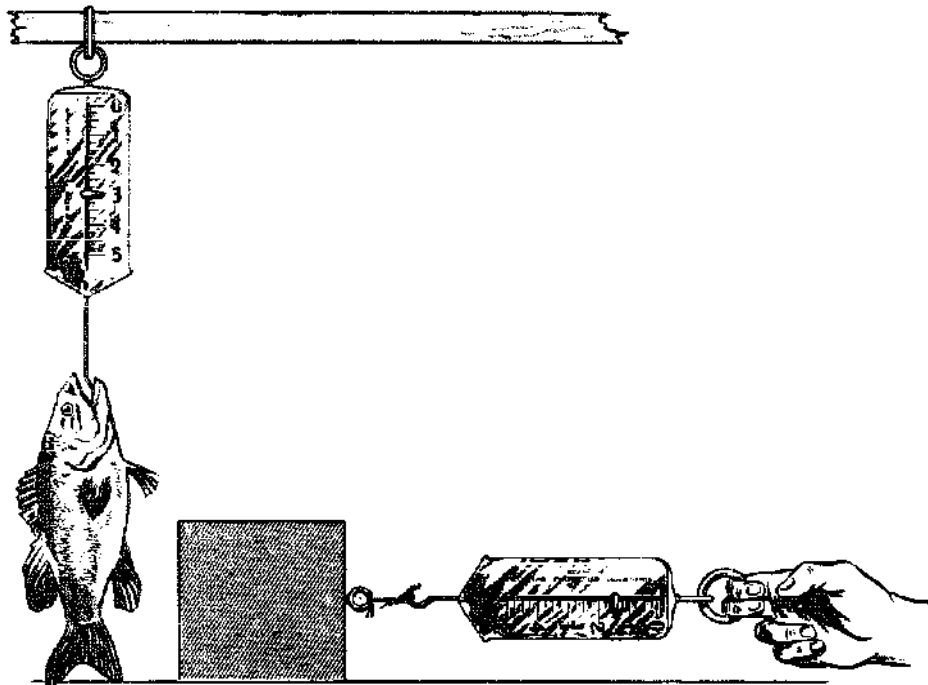


Figure 9-1.—You can measure force with a scale.

131.44

psi. To calculate pressure, divide the force by the area over which the force is applied. The formula is—

$$\text{Pressure, in psi} = \frac{\text{Force, in lb}}{\text{Area, in sq in}}$$

Or

$$P = \frac{F}{A}$$

To get this idea, follow this problem. A tank for holding fresh water aboard a ship is 10 feet long, 6 feet wide, and 4 feet deep. It holds, therefore, 10x6x4, or 240 cubic feet of water. Each cubic foot of water weighs about 62.5 pounds. The total force tending to push the bottom out of the tank is equal to the weight of the water—240x62.5, or 15,000 lb. What is the pressure on the bottom? Since the weight is evenly distributed on the bottom, you apply the formula  $P = \frac{F}{A}$  and substitute the proper values for F and A. In this case, F=15,000 lb, and the area of the bottom in

square inches is 10x6x144, since 144 sq in.=1 sq ft.

$$P = \frac{15,000}{10 \times 6 \times 144} = 1.74 \text{ psi}$$

Now work out the idea in reverse. You live at the bottom of the great sea of air which surrounds the earth. Because the air has weight—gravity pulls on the air, too—the air exerts a force on every object which it surrounds. Near sea level that force on an area of 1 square inch is roughly 15 pounds. Thus, the air-pressure at sea level is about 15 psi. The pressure gets less and less as you go up to higher altitudes.

With your finger, mark out an area of one square foot on your chest. What is the total force which tends to push in your chest? Again use the formula  $P = \frac{F}{A}$ . Now substitute 15 psi for P, and for A use 144 sq. in. Then  $F = 144 \times 15$ , or 2160 lb. The force on your chest is 2160 lb per square foot—more than a ton pushing against an area of

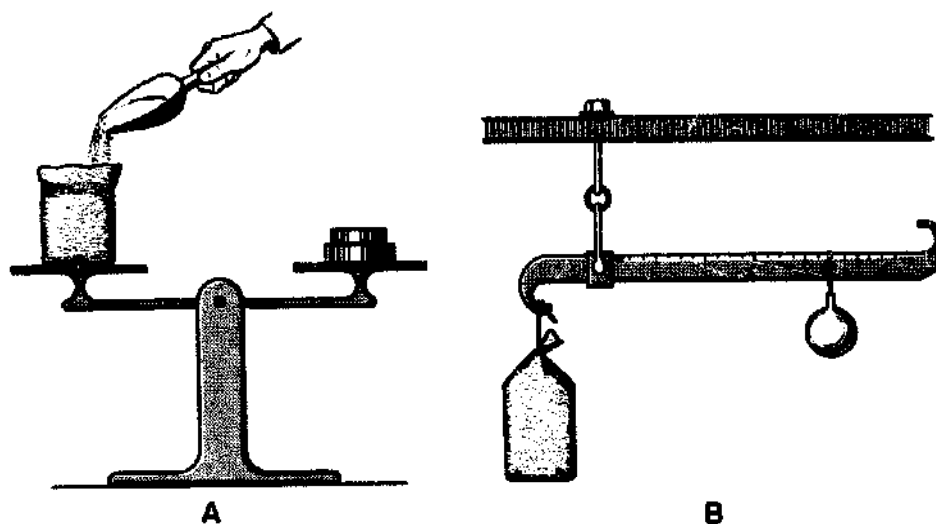


Figure 9-2.—Balances.

18.30

1 sq ft. If there were no air inside your chest to push outward with the same pressure, you'd be squashed flatter than a bride's biscuit.

**MEASURING PRESSURE**

Fluids—which include both liquids and gases—exert pressure. A fluid at rest exerts

equal pressure in all directions. Figure 9-3 shows that. Whether the hole is in the top, the bottom, or in one of the sides of a submarine, the water pushes in through the hole.

In many jobs aboard ship, it is necessary to know the pressure exerted by gas or a liquid. For example, it is important at all times to know

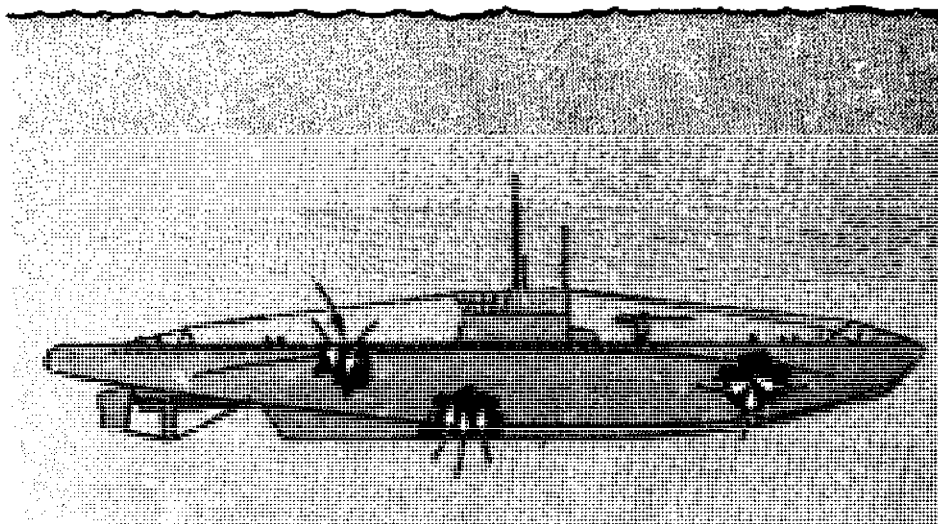


Figure 9-3.—Fluids exert pressure in all directions.

131.45

the steam pressure inside of a boiler. One device to measure pressure is the Bourdon gage, shown in figure 9-4. Its working principle is the same as that of those snakelike paper tubes which you get at a New Year's party. They straighten out when you blow into them.

In the Bourdon gage there is a thin-walled metal tube, somewhat flattened, and bent into the form of a C. Attached to its free end is a lever system which magnifies any motion of the free end of the tube. The fixed end of the gage ends in a fitting which is threaded into the boiler system so that the pressure in the boiler will be transmitted to the tube. Like the paper "snake," the metal tube tends to straighten out when the pressure inside it is increased. As the tube straightens, the pointer is made to move around the dial. The pressure, in psi, may be read directly on the dial.

Air pressure and pressures of steam and other gases, and fluid pressures in hydraulic systems, are generally measured in pounds per square inch. For convenience, however, the pressure exerted by water is commonly measured in pounds per square foot. You'll find more about this in chapter 10.

The Bourdon gage is a highly accurate but rather delicate instrument, and can be very easily damaged. In addition, it develops trouble where pressure fluctuates rapidly. To overcome this, another type of gage, the Schrader, was developed. The Schrader gage (fig. 9-5) is not as accurate as the Bourdon, but is sturdily constructed and quite suitable for ordinary hydraulic pressure measurements. It is especially recommended for fluctuating loads. In the Schrader gage a piston is directly actuated by the liquid pressure to be measured, and moves up a cylinder against the resistance of a spring, carrying a bar or indicator with it over a calibrated scale. In this manner, all levers, gears, cams, and bearings are eliminated, and a sturdy instrument can be constructed.

Where accurate measurements of comparatively slight pressures are desired, a diaphragm type gage may be used.

Diaphragm gages give sensitive and reliable indications of small pressure differences. Diaphragm gages are often used to measure the air pressure in the space between inner and outer boiler casings. In this type of gage, a diaphragm is connected to a pointer through a metal spring and a simple linkage system (fig. 9-6). One side

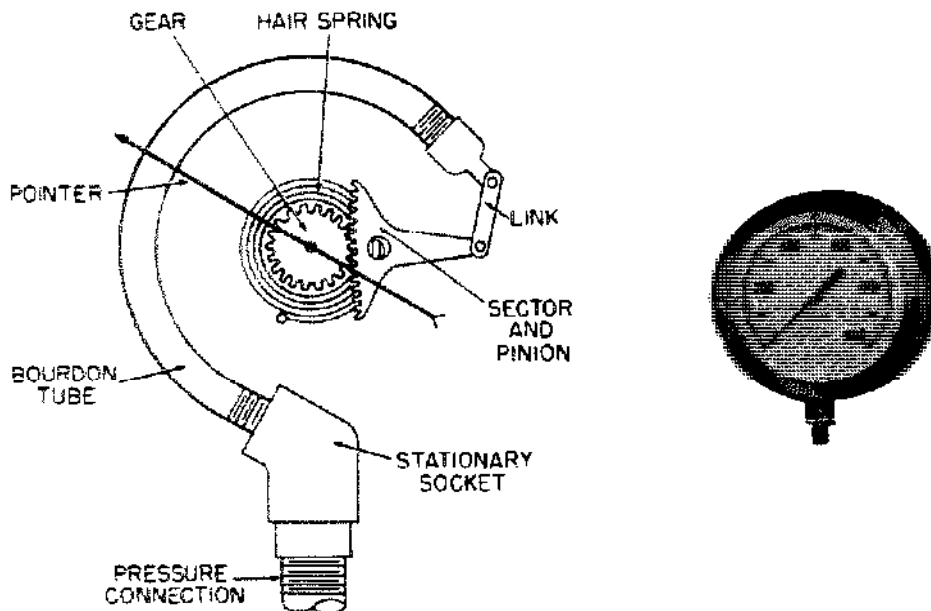


Figure 9-4.—The Bourdon gage.

38.211

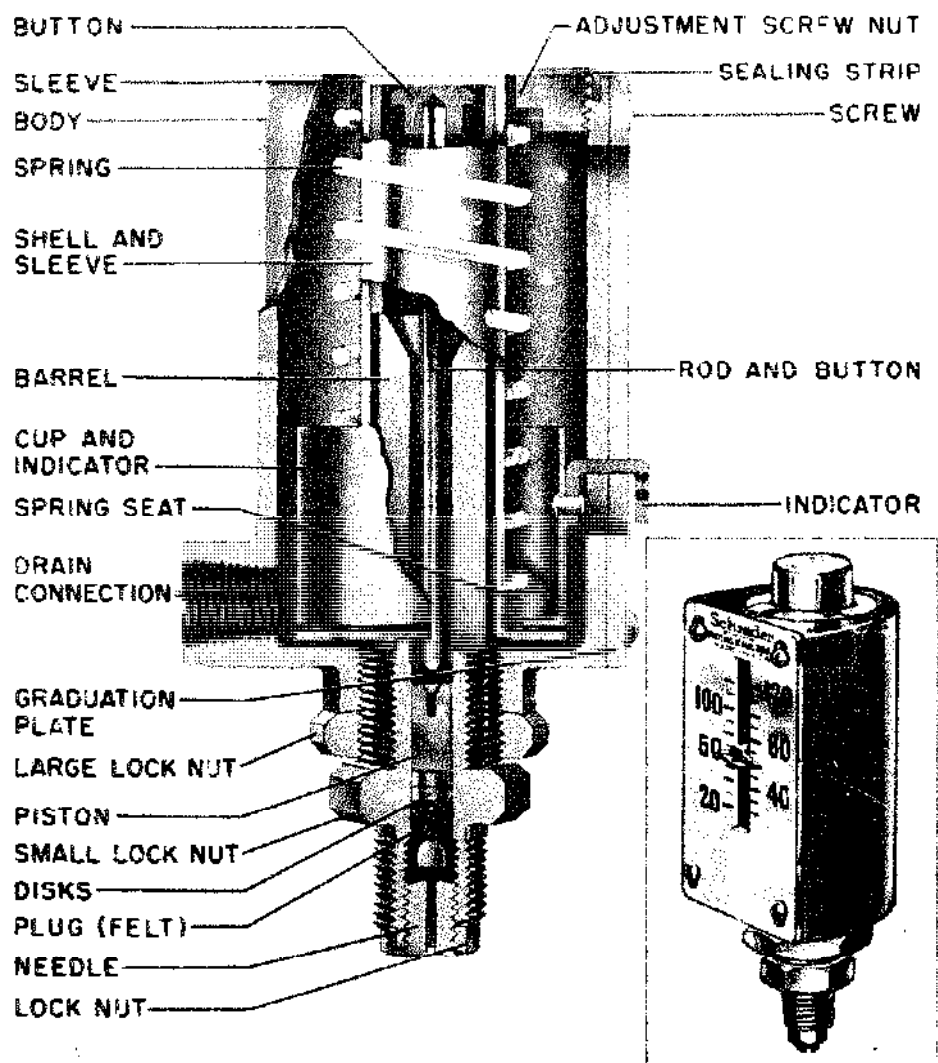


Figure 9-5.—The Schrader gage.

131.46

of the diaphragm is exposed to the pressure being measured, while the other side is exposed to the pressure of the atmosphere.

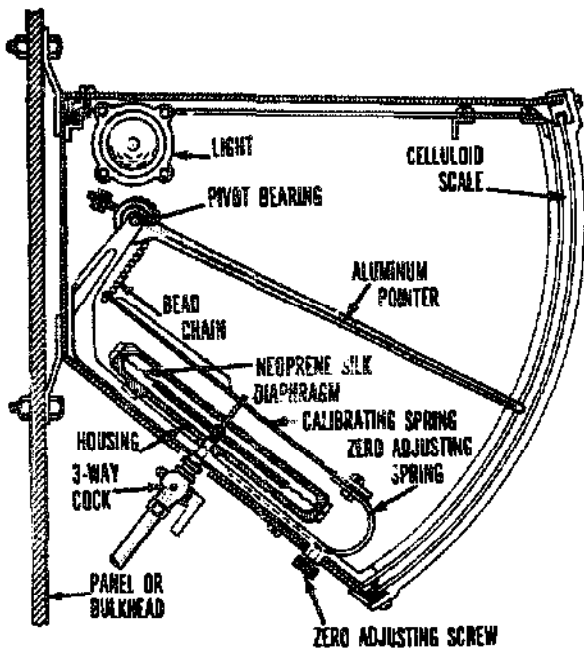
Any increase in the pressure line will move the diaphragm upwards against the action of the spring. The linkage system operates and the pointer rotates to a higher reading. When the pressure being measured decreases, the spring moves the diaphragm downward, rotating the pointer to a lower reading. Thus the position of the pointer is a balance between the pressure tending to push the diaphragm upward and the

spring action tending to push it down. When the gage reads "0" the pressure in the line is equal to the outside air pressure.

### THE BAROMETER

To the average man, the chief importance of weather is as an introduction to general conversation. But at sea and in the air, advance knowledge of what the weather will do is a matter of great concern to all hands. Operations are





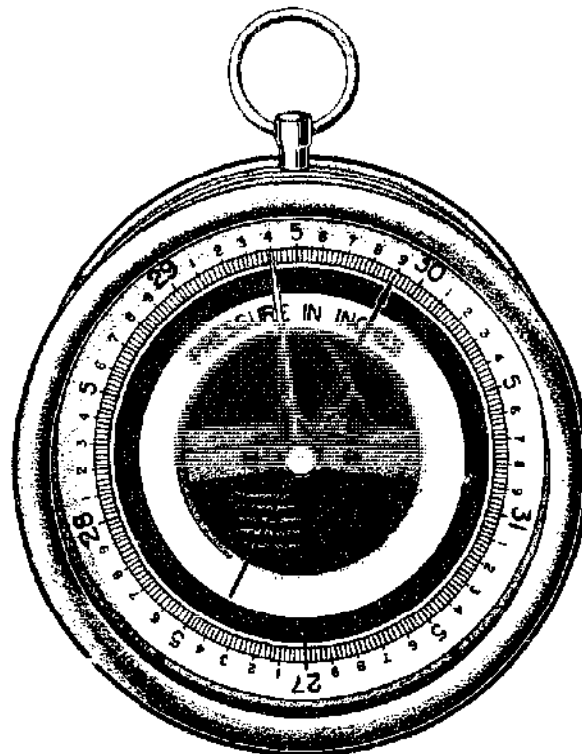
38.212X

Figure 9-6.—Diaphragm pressure gage.

planned or cancelled on the basis of weather predictions. Accurate weather forecasts are made only after a great deal of information has been collected by many observers located over a wide area.

One of the instruments used in gathering weather data is the barometer. Remember, the air is pressing on you all the time. So-called normal atmospheric pressure is 14.7 psi. But as the weather changes, the air pressure may be greater or less than normal. If the air pressure is low in the area where you are, you know that air from one or more of the surrounding high-pressure areas is going to move in toward you. Moving air—or wind—is one of the most important factors in weather changes. In general, if you're in a low-pressure area you may expect wind, rain, and storms. A high-pressure area generally enjoys clear weather. The barometer can tell you the air pressure in your locality, and give you a rough idea of what kind of weather may be expected.

The aneroid barometer shown in figure 9-7 is an instrument which measures air pressure. It contains a thin-walled metal box from which

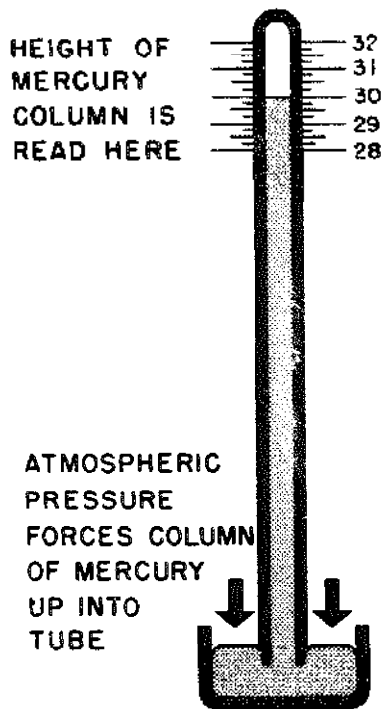


69.87

Figure 9-7.—An aneroid barometer.

most of the air has been pumped. A pointer is mechanically connected to the box by a lever system. If the pressure of the atmosphere increases, it tends to squeeze in the sides of the box. This squeeze causes the pointer to move towards the high-pressure end of the scale. If the pressure decreases, the sides of the box expand outward. This causes the pointer to move toward the low-pressure end of the dial.

Notice that the numbers on the dial run from 27 to 31. To understand why these particular numbers are used, you have to understand the operation of the mercurial barometer. You see one of these in figure 9-8. It consists of a glass tube partly filled with mercury. The upper end is closed. There is a vacuum above the mercury in the tube, and the lower end of the tube is submerged in a pool of mercury in an open cup. The atmosphere presses down on the mercury in the cup, and tends to push the mercury up in the tube. The greater the air pressure, the higher the column of mercury rises. At sea level, the



69.86

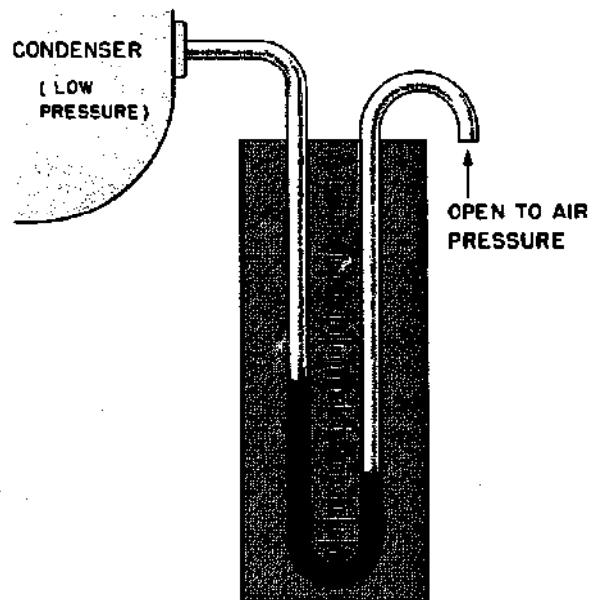
Figure 9-8.—A mercurial barometer.

normal pressure is 14.7 psi, and the height of the mercury in the tube is 30 inches. As the air pressure increases or decreases from day to day, the height of the mercury rises or falls. A mercury barometer aboard ship is usually mounted in gimbals to keep it in a vertical position despite the rolling and pitching of the ship.

Pressures indicated on dials of most gages are relative. That is, they are either greater or less than normal. But remember—the dial of an aneroid barometer always indicates absolute pressures, not relative. When the pressure exerted by any gas is less than 14.7 psi, you have what's called a partial vacuum. The condensers on steam turbines, for instance, are operated at pressure well below 14.7 psi. Steam under very high pressure is run into the turbine and causes the rotor to turn. After it has passed through the turbine it still exerts a back pressure against the blades. You can see that this is bad. Soon the back pressure would be nearly as

large as that of the incoming steam, and the turbine would not turn at all. To reduce the back pressure as much as possible, the exhaust steam is run through pipes which are surrounded by cold sea water. This causes the steam in the pipes to condense into water, and the pressure drops well below atmospheric pressure.

It is important for the engineer to know the pressure in the condensers at all times. To measure this reduced pressure, or partial vacuum, he uses a gage called a manometer. Figure 9-9 shows you how this simple device is made. A U-shaped tube has one end connected to the low-pressure condenser and the other end is open to the air. The tube is partly filled with colored water. The normal air pressure on the open end exerts a bigger push on the colored water than the push of the low-pressure steam, and the colored water is forced part way up into the left arm of the tube. From the scale between the two arms of the U, the difference in the height of the two columns of water can be read. This tells the engineer the degree of vacuum—or how much below atmospheric pressure the pressure is in the condenser.



61.4

Figure 9-9.—A manometer.

**SUMMARY**

Here are seven points that you should remember—

A force is a push or a pull exerted on—or by—an object.

Force is generally measured in pounds.

Pressure is the force per unit area which is exerted on, or by, an object. It is commonly measured in pounds per square inch—psi.

Pressure is calculated by the formula  $P = \frac{F}{A}$ .

Spring scales and lever balances are familiar instruments you use for measuring forces. Bourdon gages, barometers, and manometers are instruments for the measurement of pressure.

The normal pressure of the air is 14.7 psi at sea level.

Pressure is generally relative. It is sometimes greater—sometimes less—than normal air pressure. When pressure is less than the normal air pressure, you call it vacuum.

## CHAPTER 10

# HYDROSTATIC AND HYDRAULIC MACHINES

### HYDROSTATIC MACHINES

#### LIQUIDS AT REST

You know that liquids exert pressure. In order that your ship may remain afloat, the water must push upward on the hull. But the water is also exerting pressure on the sides. If you are billeted on a submarine, you are more conscious of water pressure—when you're submerged the sub is being squeezed from all sides. If your duties include deep-sea diving, you'll go over the side pumped up like a tire so that you can withstand the terrific force of the water below. The pressure exerted by the sea water, or by any liquid at rest, is called hydrostatic pressure. In handling torpedoes, mines, depth charges, and some types of aerial bombs, you'll be dealing with devices which are operated by hydrostatic pressure.

In chapter 9, you found out that all fluids exert pressure in all directions. That's simple enough. But how great is the pressure? Try a little experiment. Place a pile of blocks in front of you on the table. Stick the tip of your finger under the first block from the top. Not much pressure on your finger, is there? Stick it in between the third and fourth blocks. The pressure on your finger has increased. Now slide your finger under the bottom block in the pile. There you find the pressure is greatest. The pressure increases as you go lower in the pile. You might say that pressure increases with depth. The same is true in liquids. The deeper you go, the greater the pressure becomes. But, depth isn't the whole story.

Suppose the blocks in the preceding paragraph were made of lead. The pressure at any level in the pile would be considerably greater. Or, suppose they were blocks of balsa wood—the

pressure at each level wouldn't be so great. Pressure, then, depends not only on the depth, but also on the weight of the material. Since you are dealing with pressure—force per unit of area—you will also be dealing with weight per unit of volume—or density.

When you talk about the density of a substance you are talking about its weight per cubic foot—or per cubic inch. For example, the density of water is 62.5 lb. per cu. ft. This gives you a more exact way of comparing the weights of two materials. To say that lead is heavier than water isn't a complete statement. A 22-caliber bullet doesn't weigh as much as a pail of water. It is true, however, that a cubic foot of lead is lots heavier than a cubic foot of water. Lead has a greater density than water. The density of lead is 710 lb. per cu. ft., as compared with 62.5 lb. per cu. ft. for water.

Pressure depends on two factors—depth and density—so it is easy to write a formula that will help you find the pressure at any depth in any liquid. Here it is—

$$P = H \times D$$

in which

P = pressure, in lb. per sq. in., or lb. per sq. ft

H = depth of the point, measured in feet or inches.

and

D = density in lb. per cu. in. or in lb. per cu. ft.

Note: If inches are used, they must be used throughout; if feet are used, they must be used throughout.

What is the pressure on one square foot of the surface of a submarine if the submarine is 200 feet below the surface? Use the formula—

$$P = H \times D$$

and

$$P = 200 \times 62.5 = 12,500 \text{ lb. per sq. ft.}$$

Every square foot of the sub's surface which is at that depth has a force of over 6 tons pushing in on it. If the height of the hull is 20 feet, and the area in question is midway between the sub's top and bottom, you can see that the pressure on the hull will be at least  $(200 - 10) \times 62.5 = 11,875$  lb. per sq. ft., and the greatest pressure will be  $(200 + 10) \times 62.5 = 13,125$  lb. per sq. ft. Obviously, the hull has to be made very strong to withstand such pressures.

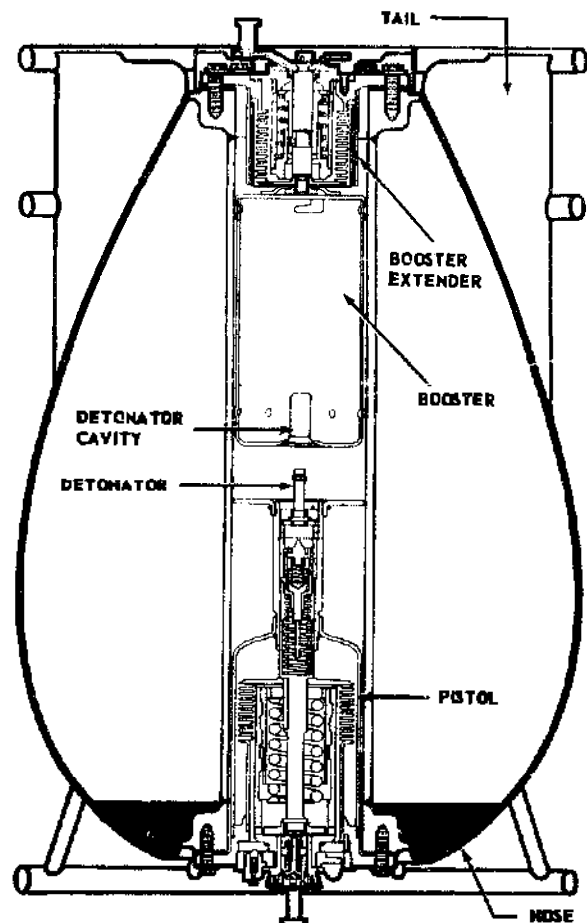
#### Using Pressure to Fire the Depth Charge

Although hiding below the surface exposes the sub to great fluid pressure, it also provides the sub with a great advantage. A submarine is hard to kill because it is hard to hit. A depth charge must explode within 30 to 50 feet of a submarine to really score. And that means the depth charge must not go off until it has had time to sink to approximately the same level as the sub. You use a firing mechanism which is set off by the pressure at the estimated depth of the submarine.

Figure 10-1 shows a depth charge and its interior components. A depth charge is a sheet-metal container filled with a high explosive and a firing device. A tube passes through its center from end to end. Fitted in one end of this tube is the booster, which is a load of granular TNT to set off the main charge. The safety fork is knocked off on launching, and the inlet valve cover is removed from an inlet through which the water enters.

When the depth charge gets about 12 to 15 feet below the surface, the water pressure is sufficient to extend a bellows in the booster extender. The bellows trips a release mechanism, and a spring pushes the booster up against the centering flange. Notice that the detonator fits into a pocket in the booster. Unless the detonator is in this pocket, it cannot set off the booster charge.

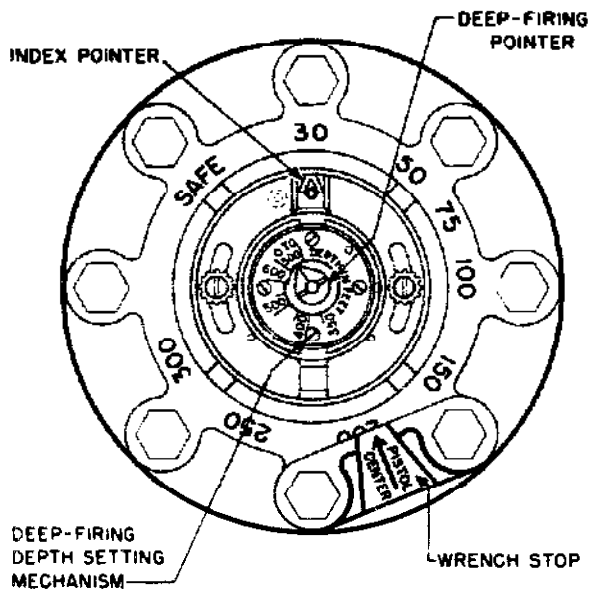
Nothing further happens until the detonator is fired. As you can see, the detonator is held in the end of the pistol, with the firing pin aimed



4.198

Figure 10-1.—A depth charge.

at the detonator base. The pistol also contains a bellows into which the water rushes as the charge goes down. As the pressure increases, the bellows begins to expand against the depth spring. You can adjust this spring so that the bellows will have to exert a predetermined force in order to compress it. Figure 10-2 shows you the depth-setting dials of one type of depth charge. Since the pressure on the bellows depends directly on the depth, you can arrange to have the charge go off at any depth you select on the dial. When the pressure in the bellows becomes sufficiently great it releases the firing spring, which drives the firing pin into the detonator. The booster, already moved into position, is fired, and this in turn sets off the entire load of TNT.



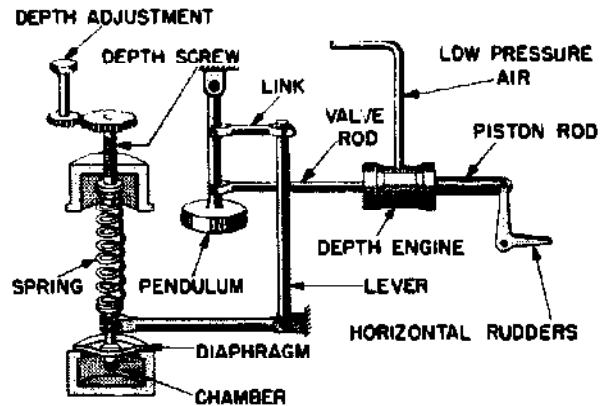
4.204  
Figure 10-2.—You select the depth on these dials.

These two bellows—operated by hydrostatic pressure—serve two purposes. First they permit the depth charge to be fired at the proper depth; second, they make the charge safe to handle and carry. If the safety fork and the valve inlet cover should accidentally be knocked off on deck, nothing would happen. Even if the detonator went off while the charge was being handled, the main charge would not let go unless the booster were in the extended position.

To keep a torpedo on course toward its target is quite a job. Maintaining the proper compass course by the use of a gyroscope is only part of the problem. The torpedo must travel at the proper depth so that it will neither pass under the target ship nor hop out of the water on the way. Here again hydrostatic pressure is used to advantage.

As figure 10-3 indicates, the tin fish contains an air-filled chamber which is sealed with a thin, flexible metal plate, or diaphragm. This diaphragm can bend upward or downward against the spring. The tension on this spring is determined by setting the depth-adjusting knob.

Suppose the torpedo starts to dive below the selected depth. The water, which enters the torpedo and surrounds the chamber, exerts an increased pressure on the diaphragm and causes it



4.122  
Figure 10-3.—Inside a torpedo.

to bend down. If you follow the lever system, you can see that the pendulum will be pushed forward. Notice that a valve rod connects the pendulum to the piston of the depth engine. As the piston moves to the left, low-pressure air from the torpedo's air supply enters the depth engine to the right of the piston and pushes it to the left. A depth engine must be used because the diaphragm is not strong enough to move the rudders.

The depth-engine's piston is connected to the horizontal rudders as shown. When the piston moves to the left, the rudder is turned upward, and the torpedo begins to rise to the proper depth. If the nose goes up, the pendulum tends to swing backward and keep the rudder from elevating the torpedo too rapidly. As long as the torpedo runs at the selected depth, the pressure on the chamber remains constant, and the rudders do not change from their horizontal position.

#### Pressure and the Deep-Sea Diver

Navy divers have a practical, first-hand knowledge of hydrostatic pressure. Think what happens to a diver who goes down 100 feet to work on a salvage job. The pressure on him at that depth is 6,250 lbs. per sq. ft.! Something must be done about that, or he'd be squashed flatter than a pancake.

To counterbalance this external pressure, the diver is enclosed in a rubber suit into which air under pressure is pumped by a shipboard

compressor. Fortunately, the air not only inflates the suit, but gets inside of the diver's body as well. It enters his lungs, and even gets into his blood stream which carries it to every part of his body. In that way his internal pressure can be kept just equal to the hydrostatic pressure.

As he goes deeper, the air pressure is increased to meet that of the water. In coming up, the pressure on the air is gradually reduced. If he is brought up too rapidly, he gets the "bends." The air which was dissolved in his blood begins to come out of solution, and form as bubbles in his veins. Any sudden release in the pressure on a fluid results in freeing some of the gases which are dissolved in the fluid.

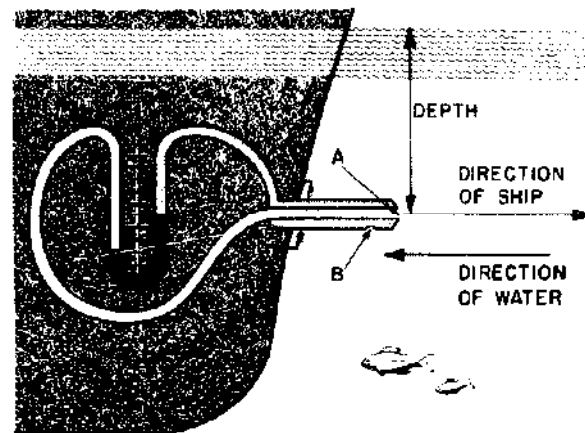
You have seen this happen when you suddenly relieve the pressure on a bottle of pop by removing the cap. The careful matching of hydrostatic pressure on the diver by means of air pressure in his suit is essential if diving is to be done at all.

#### A Sea-Going Speedometer

Here's another device that shows you how your Navy applies its knowledge of hydrostatic pressure. Did you ever wonder how the skipper knows the speed the ship is making through the water? There are several instruments used to give this information—the patent log, the engine revolution counter, and the pitometer log. The "PIT. LOG" is operated, in part, by hydrostatic pressure. It really indicates the difference between hydrostatic pressure and the pressure of the water flowing past the ship—but you can use this difference to indicate ship's speed.

Figure 10-4 shows you a schematic drawing of a pitometer log. A double-wall tube sticks out forward of the ship's hull into water which is not disturbed by the ship's motion. In the tip of the tube is an opening A. When the ship is moving there are two forces or pressures acting on this opening—the hydrostatic pressure due to the depth of water above the opening, and a pressure caused by the push of the ship through the water. The total pressure from these two forces is transmitted through the central or white tube to the left-hand arm of a manometer.

In the side of the tube is a second opening B which does not face in the direction the ship is moving. Opening B passed through the outer wall of the double-wall tube, but not through the inner wall. The only pressure affecting this opening



131.47  
Figure 10-4.—A Pitometer log.

B is the hydrostatic pressure. This pressure is transmitted through the outer tube (shaded in the drawing) to the right-hand arm of the manometer.

When the ship is dead in the water, the pressure through both openings A and B is the same, and the mercury in each arm of the manometer stands at the same level. However, as soon as the ship begins to move, additional pressure is developed at opening A, and the mercury is pushed down in the left-hand arm and up into the right-hand arm of the tube. The faster the ship goes, the greater this additional pressure becomes, and the greater the difference will be between the levels of the mercury in the two arms of the manometer. The speed of the ship can be read directly from the calibrated scale on the manometer.

Incidentally—since air is also a fluid—the airspeed of an aircraft can be found by a similar device. You have probably seen the thin tube sticking out from the leading edge of a wing, or from the nose of the plane. Flyers call this tube a pitot tube. Its fundamental principle is the same as that of the pitometer log.

#### SUMMARY

The Navy uses many devices whose operation is dependent on the hydrostatic principle. Here are three points to remember about the operation of these devices.

Pressure in a liquid is exerted equally in all directions.

You use the term hydrostatic pressure when you are talking about the pressure at any depth in a liquid that is not flowing. Pressure depends upon both depth and density.

The formula for finding pressure is—

$$P = H \times D$$

### HYDRAULIC MACHINES

#### LIQUIDS IN MOTION

Perhaps your earliest contact with a hydraulic machine was when you got your first haircut. Tony put a board across the arms of the chair, sat you on it, and began to pump the chair up to a convenient level. As you grew older, you probably discovered that the filling station attendant could put a car on the greasing rack, and—by some mysterious arrangement—jack it head-high. No doubt the attendant told you that oil under pressure below the piston was doing the job.

Come to think about it, you've probably known something about hydraulics for a long time. Automobiles and airplanes use hydraulic brakes. As a bluejacket, you'll have to operate many hydraulic machines, so you'll want to understand the basic principles on which they work.

Simple machines such as the lever, the inclined plane, the pulley, the wedge, and the wheel and axle, were used by primitive man. But it was considerably later before someone discovered that liquids and gases could be used to exert forces at a distance. Then, a vast number of new machines appeared. A machine which transmits forces by means of a liquid is a hydraulic machine. A variation of the hydraulic machine is the type that operates by the use of a compressed gas. This type is called the pneumatic machine. This chapter deals only with basic hydraulic machines.

#### Pascal's Law

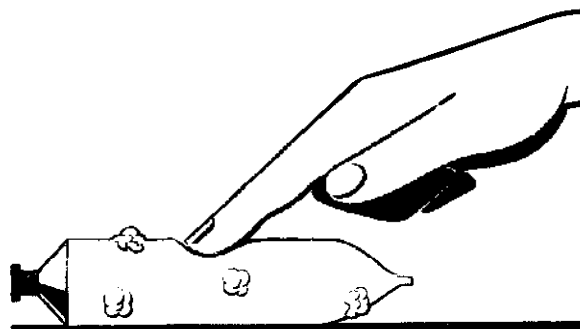
A Frenchman named Pascal discovered that a pressure applied to any part of a confined fluid is transmitted to every other part with no loss. The pressure acts with equal force on all equal areas of the confining walls, and perpendicular to the walls.

But remember this—when you are talking about the hydraulic principle as applied to a

hydraulic machine, you are talking about the way a liquid acts in a closed system of pipes and cylinders. The action of a liquid under such conditions is somewhat different from its behavior in open containers, or in lakes, rivers, or oceans. You should also keep in mind that most liquids cannot be compressed—squeezed into a smaller space. Liquids don't "give" the way air does when pressure is applied, nor do liquids expand when pressure is removed.

Punch a hole in a tube of shaving cream. If you push down at any point on the tube the cream comes out of the hole. Your force has been transmitted from one place to another by the shaving cream—which is fluid—a thick liquid. Figure 10-5 shows what would happen if you punched four holes in the tube. If you press on the tube at one point, the cream comes out of all four holes. This tells you that a force applied on a liquid is transmitted equally in every direction to all parts of the container. Right there you have illustrated a basic principle of hydraulic machines.

This principle is used in the operation of four-wheel hydraulic automobile brakes. Figure 10-6 is a simplified drawing of this brake system. You push down on the brake pedal and force the piston in the master cylinder against the fluid in that cylinder. This push sets up a pressure on the fluid just as your finger did on the shaving cream in the tube. The pressure on the fluid in the master cylinder is transmitted through the lines to the brake cylinders in each wheel. This fluid under pressure pushes against the pistons in each of the brake cylinders and forces the brake shoes out against the drums.



131.48  
Figure 10-5.—Pressure is transmitted in all directions.



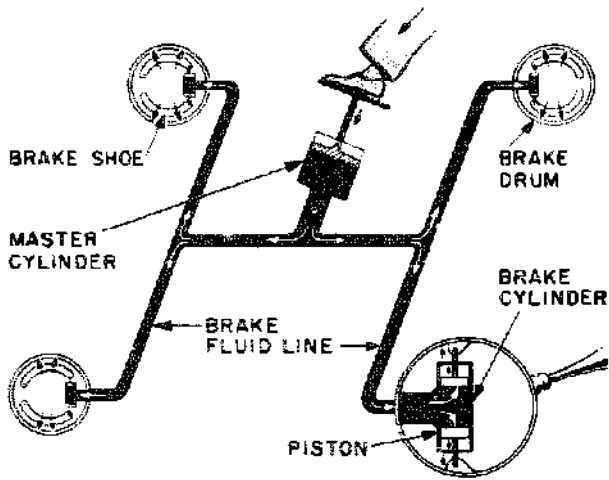


Figure 10-6.—Hydraulic brakes.

81.280

**Mechanical Advantage  
Through Hydraulics**

The next thing to understand about hydraulic machines is the relationship between the force you apply and the result you get. Figure 10-7 will help you on this. The U-shaped tube has a

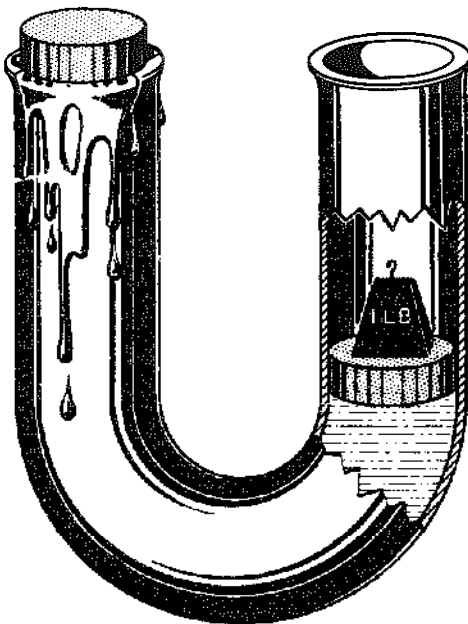


Figure 10-7.—The liquid transmits the force.

131.49

cross-sectional area of one sq. inch. In each arm there's a piston which fits snugly, but which can move up and down. If you place a one-pound weight on one piston, the other will be pushed out the top of its arm immediately. Place a one-pound weight on each piston, however, and they remain in their original positions, as shown in figure 10-8.

Thus you see that a pressure of one pound per sq. in. applied down on the right-hand piston exerts a pressure of one pound per sq. in. upward against the left-hand piston. In other words, not only is the force transmitted by the liquid around the curve, but the force is the same on each unit area of the container. It makes no difference how long the connecting tube is, or how many turns it makes. It is important, however, that the entire system be full of liquid. **Hydraulic systems will fail to operate properly if air is present in the lines or cylinders.**

Now look at figure 10-9. The piston on the right has an area of one sq. in., but the piston on the left has an area of 10 sq. in. If you push down on the smaller piston with a force of one pound, the liquid will transmit this pressure to every square inch of surface in the system. Since the left-hand piston has an area of 10 sq. in., and each square inch has a force of one pound transmitted to it, the total effect is to push on the larger piston with a total force of 10 pounds. Set a 10-pound weight on the larger piston and it will be supported by the one-pound force of the smaller piston.

There you have a one-pound push resulting in a 10-pound force. That's a mechanical advantage of ten. This is why hydraulic machines

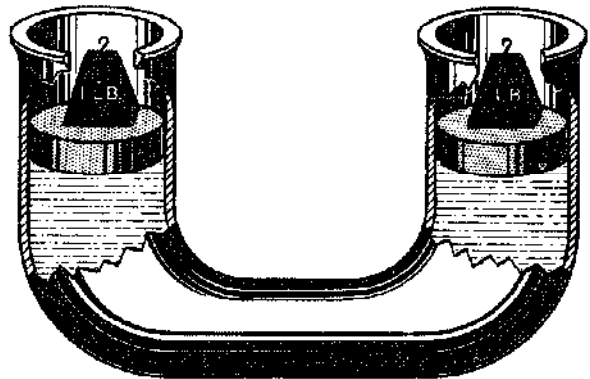
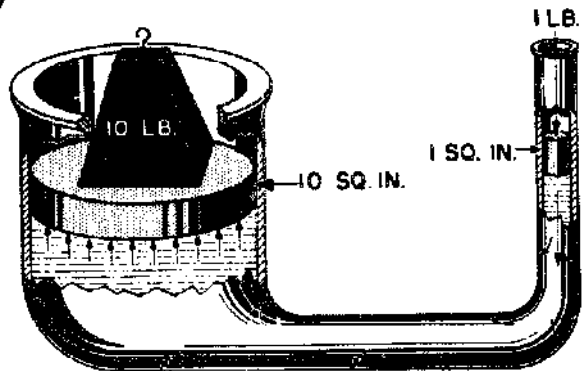


Figure 10-8.—Pressure is the same on all parts of an enclosed liquid.

5.181

166



4.7

Figure 10-9.—A mechanical advantage of 10.

Where's The Catch?

You know from your experience with levers that you can't get something for nothing. Applying this knowledge to the simple system in figure 10-9, you know that you can't get a 10-pound force from a one-pound effort without sacrificing distance. The one-pound effort will have to be applied through a much greater distance than the 10-pound force will move. If you raise the 10-pound weight through a distance of one foot, through what distance will the one-pound effort have to be applied? Remember—if you neglect friction, the work done on any machine equals the work done by that machine. Use the work formula, and you can find how far the smaller piston will have to move.

Work input = Work output

$$F_1 \times D_1 = F_2 \times D_2$$

By substituting—  $1 \times D_1 = 10 \times 1$

and—  $D_1 = 10 \text{ feet}$

are important. Here's a formula which will help you to figure the forces that act in a hydraulic machine—

$$\frac{F_1}{F_2} = \frac{A_1}{A_2}$$

- In which  $F_1$  = force, in pounds, applied to the small piston,
- $F_2$  = force, in pounds, applied to the large piston,
- $A_1$  = area of small piston, in square inches,
- $A_2$  = area of large piston, in square inches.

Try out the formula on the hydraulic press in figure 10-10. The large piston has an area of 90 sq. in. and the smaller one an area of two sq. in. The handle exerts a total force of 15 pounds on the small piston. With what total force will the large piston be raised?

Write down the formula—

$$\frac{F_1}{F_2} = \frac{A_1}{A_2}$$

Substitute the known values—

$$\frac{15}{F_2} = \frac{2}{90}$$

and—

$$F_2 = \frac{90 \times 15}{2} = 675 \text{ pounds.}$$

There's the catch. The smaller piston will have to move through a distance of 10 feet in order to raise the 10-pound load one foot. It looks then as though the smaller cylinder would have to be at least 10 feet long—and that wouldn't be practical. Actually, it isn't necessary—if you put a valve in the system.

The hydraulic press in figure 10-10 contains a valve for just this purpose. As the small piston moves down, it forces the fluid past the check valve A into the large cylinder. As soon as you start to move the small piston upward, the pressure to the right of the check valve A is removed, and the pressure of the fluid below the large piston helps the checkvalve spring force that valve shut. The liquid which has passed through the valve opening on the down stroke of the small piston is trapped in the large cylinder.

The small piston rises on the up-stroke until its bottom passes the opening to the fluid reservoir. More fluid is sucked past a check valve B and into the small cylinder. The next down-stroke forces this new charge of fluid out of the small cylinder past the check valve into the large cylinder. This process is repeated stroke by stroke until enough fluid has been forced into the large cylinder to raise the large piston the required distance of one foot. The force has been applied through a distance of 10 feet on the pump handle,

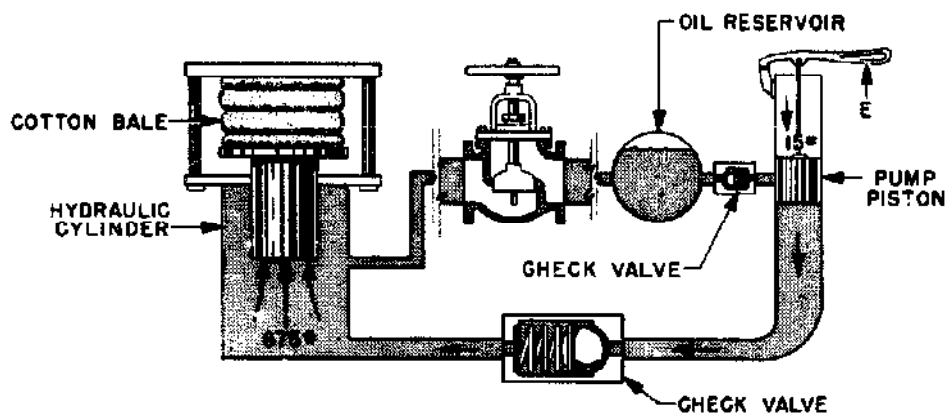


Figure 10-10.—Hydraulic press.

131.50

but it was done by making a series of relatively short strokes—the sum of all the strokes being equal to 10 feet.

Maybe you're beginning to wonder how the large piston gets back down after you've baled the cotton. The fluid can't run back past the check valve B—that's obvious. You lower the piston by letting the oil flow back to the reservoir through a return line. Notice that a simple gate valve is inserted in this line. When the gate valve is opened, the fluid flows back into the reservoir. Of course, this valve is kept shut while the pump is in operation.

#### Hydraulics Aid the Helmsman

You've probably seen the helmsman swing a ship weighing thousands of tons about as easily as you turn your car. No, he's not a superman. He does it with machines.

Many of these machines are hydraulic. There are several types of hydraulic and electro-hydraulic steering mechanisms, but the simplified diagram in figure 10-11 will help you to understand the general principles of their operation. As the hand steering wheel is turned in a counterclockwise direction, its motion turns the pinion gear *g*. This causes the left-hand rack *r*<sub>1</sub> to move downward, and the right-hand rack *r*<sub>2</sub> to move upward. Notice that each rack is attached to a piston *P*<sub>1</sub> or *P*<sub>2</sub>. The downward motion of rack *r*<sub>1</sub> moves piston *p*<sub>1</sub> downward in its cylinder and pushes the oil out of that cylinder through the line. At the same time, piston *p*<sub>2</sub> moves upward and pulls oil from the right-hand line into the right-hand cylinder.

If you follow these two lines, you see that they enter a hydraulic cylinder *S*—one line entering above and one below the single piston in that cylinder. In the direction of the oil flow in the diagram, this piston and the attached plunger are pushed down toward the hydraulic pump *h*. So far, in this operation, you have used hand power to develop enough oil pressure to move the control plunger attached to the hydraulic pump. At this point an electric motor takes over and drives the pump *h*.

Oil is pumped under pressure to the two big steering rams *R*<sub>1</sub> and *R*<sub>2</sub>. You can see that the pistons in these rams are connected directly to the rudder crosshead which controls the position of the rudder. With the pump operating in the direction shown, the ship's rudder is thrown to the left, and the bow will swing to port. This operation demonstrates how a small force applied on the steering wheel sets in motion a series of operations which result in a force of thousands of pounds.

#### Getting Planes on Deck

The swift, smooth power required to get airplanes from the hanger deck to the flight deck of a carrier is supplied by a hydraulic lift. Figure 10-12 explains how this lifting is done. A variable-speed gear pump is driven by an electric motor. Oil enters the pump from the reservoir and is forced through the lines to four hydraulic rams, the pistons of which raise the elevator platform. The oil under pressure exerts its force on each square inch of surface area of the four pistons. Since the pistons are large, a

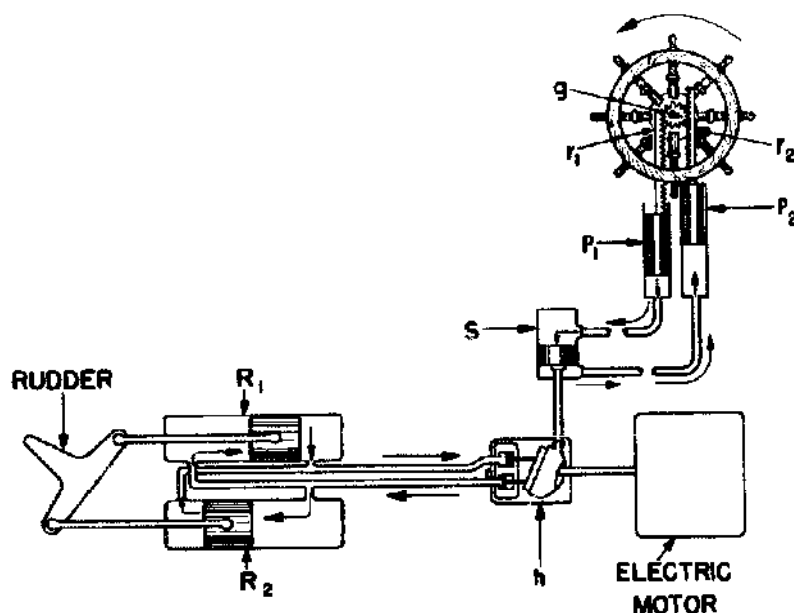


Figure 10-11.—Steering is easy with this machine.

131.51

large total lifting force results. The elevator can be lowered by reversing the pump, or by opening valve 1 and closing valve 2. The weight of the elevator will then force the oil out of the cylinders and back into the reservoir.

#### Submarines Use Hydraulics

Here's another application of hydraulics which you will find interesting. Inside a submarine, between the outer skin and the pressure hull, are several tanks of various design and purpose. These are used to control the total weight of the ship, allowing it to submerge or surface, and to control the trim, or balance fore and aft, of the submarine. The main ballast tanks have the primary function of either destroying or restoring positive buoyancy in the submarine. By allowing air to escape through hydraulically operated vents at the top of the tanks, sea water is able to enter through the flood ports at the bottom—replacing the air that had been holding it out. To regain positive buoyancy, the tanks are "blown" free of sea water with compressed air. Sufficient air is then left trapped in the tanks to prevent the sea water from reentering.

Other tanks, such as the variable ballast tanks and special ballast tanks like the negative tank, safety tank, and bow buoyancy tank, are used either to control trim, or stability, or for emergency weight compensating purposes. The variable ballast tanks have no direct connection to the sea. Therefore, water must be pumped into or out of them. The negative tank and the safety tank, however, can be opened to the sea through large flood valves. These valves, as well as the vent valves for the main ballast tanks and those for the safety and negative tanks, are all hydraulically operated. The vents and flood valves are outside of the pressure hull, so some means of remote control is necessary if they are to be opened and closed from within the submarine. For this purpose, hydraulic pumps, lines, and rams are used. Oil pumped through tubing running through the pressure hull actuates the valve's operating mechanisms by exerting pressure on and moving a piston in a hydraulic cylinder. It is easier and simpler to operate the valves by a hydraulic system from a control room than it would be to do so by a mechanical system of gears, shafts, and levers. The hydraulic lines can be readily led around corners and obstructions, and a minimum of moving parts is required.

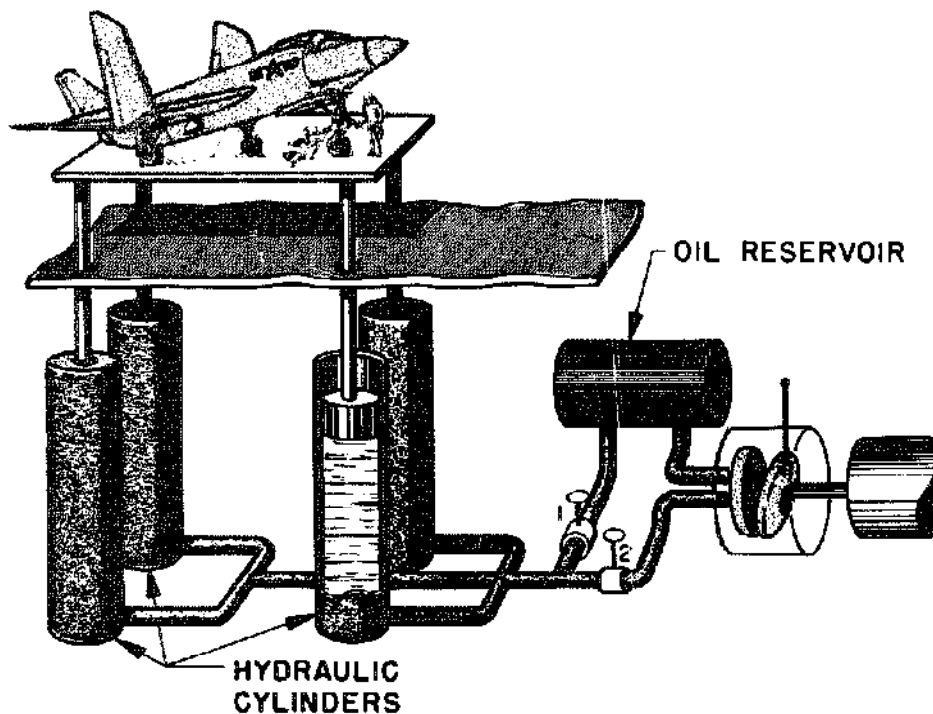


Figure 10-12.—This gets them there in a hurry.

131.52

Figure 10-13 is a schematic sketch of the safety tank—one of the special ballast tanks in a submarine. The main vent and the flood valves of this tank are operated hydraulically from remote control; although, in an emergency, they may be operated manually.

Hydraulics are also used in many other ways aboard the submarine. The periscope is raised and lowered, the submarine is steered, and the bow and stern planes are controlled by means of hydraulic systems. The windlass and capstan system, used in mooring the submarine, is hydraulically operated, and many more applications of hydraulics can be found aboard the submarine.

#### The Accumulator

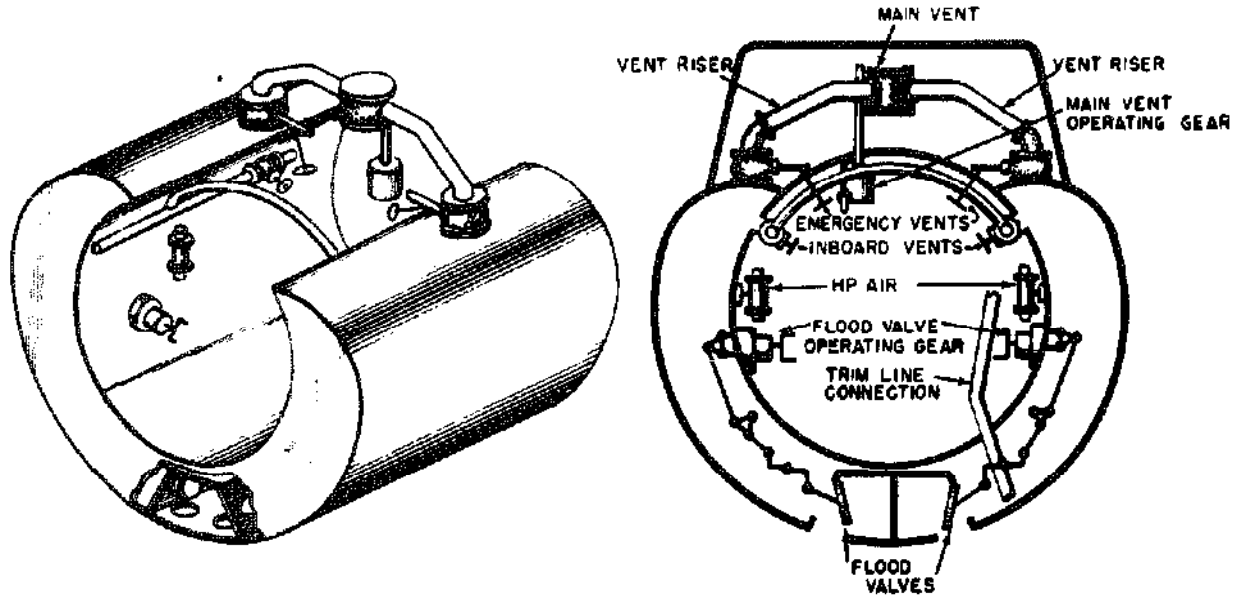
In some hydraulic systems, oil is kept under pressure in a container called an accumulator. Figure 11-14 shows you this large cylinder, into the top of which oil is pumped. A free piston

divides the cylinder into two parts. Compressed air is forced in below the piston at a pressure of, say, 600 psi. Oil is then forced in on top of the piston. As the pressure above it increases, the piston is forced down, and squeezes the air into a smaller space. Air is elastic—it can be compressed under pressure—but it will expand as soon as the pressure is reduced. When oil pressure is reduced, relatively large quantities of oil under working pressure are instantly available to operate hydraulic rams or motors any place on the sub.

#### SUMMARY

The working principle of all hydraulic mechanisms is simple enough. Whenever you find an application that seems a bit hard to understand, keep these points in mind—

Hydraulics is the term applied to the behavior of enclosed liquids. Machines which are operated by liquids under pressure are called hydraulic machines.



131.53

Figure 10-13.—Submarine special ballast tank (safety tank).

Liquids are incompressible. They cannot be squeezed into spaces smaller than they originally occupied.

A force applied on any area of a confined liquid is transmitted equally to every part of the liquid.

In hydraulic cylinders, the relation between the force exerted by the larger piston to the force applied on the smaller piston is the same as the relation between the area

of the larger piston and the area of the smaller piston.

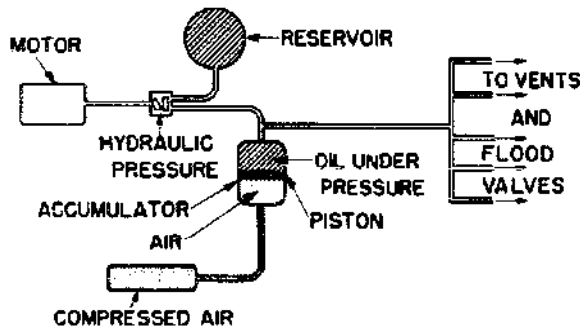
Some of the advantages of hydraulic machines are—

Tubing is used to transmit forces, and tubing can readily transmit forces around corners.

Little space is required for tubing.

Few moving parts are required.

Efficiency is high, generally 80-95%.



131.54

Figure 10-14.—This keeps pressure on tap.

## CHAPTER 11

# MACHINE ELEMENTS AND BASIC MECHANISMS

### MACHINE ELEMENTS

Any machine, however simple, utilizes one or more basic machine elements or mechanisms in its makeup. In this chapter we will take a look at some of the more familiar elements and mechanisms used in naval machinery and equipment.

### BEARINGS

In chapter 7 we saw that wherever two objects rub against each other, friction is produced. If the surfaces are very smooth, there will be little friction; if either or both are rough, there will be more friction. **FRICTION** is the resistance to any force that tends to produce motion of one surface over another. When you are trying to start a loaded hand truck rolling, you have to give it a hard tug (to overcome the resistance of static friction) to get it started. Starting to slide the same load across the deck would require a harder push than starting it on rollers. That is because rolling friction is always less than sliding friction. To take advantage of this fact, rollers or bearings are used in machines to reduce friction. Lubricants on bearing surfaces reduce the friction even further.

A bearing is a support and guide which carries a moving part (or parts) of a machine and maintains the proper relationship between the moving part or parts and the stationary part. It usually permits only one form of motion, as rotation, and prevents any other. There are two basic types of bearings: sliding type (plain bearings), also called friction or guide bearings, and anti-frictional type (roller and ball bearings).

#### Sliding Type (Plain) Bearings

In bearings of this type a film of lubricant separates the moving part from the stationary

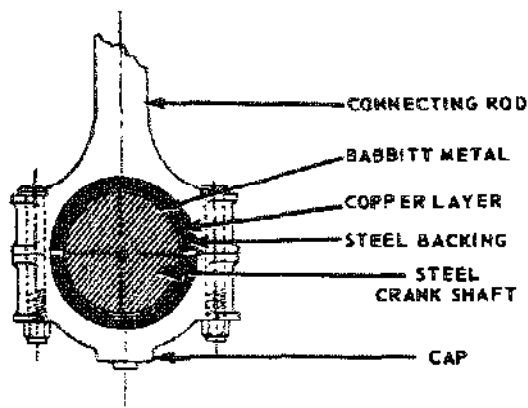
part. There are three types of sliding motion bearings in common use: Reciprocal motion bearings, journal bearings, and thrust bearings.

1. **RECIPROCAL MOTION BEARINGS** provide a bearing surface on which an object slides back and forth. They are found on steam reciprocating pumps, where connecting rods slide on bearing surfaces near their connections to the pistons. Similar bearings are used on the connecting rods of large internal-combustion engines, and in many mechanisms operated by cams.

2. **JOURNAL BEARINGS** are used to guide and support revolving shafts. The shaft revolves in a housing fitted with a liner. The inside of the liner, on which the shaft bears, is made of babbitt metal or similar soft alloy (antifriction metal) to reduce friction. The soft metal is backed by a bronze or a copper layer, and that has a steel back for strength. Sometimes the bearing is made in two halves, and is clamped or screwed around the shaft (fig. 11-1). It is also called a laminated sleeve bearing.

Under favorable conditions the friction in journal bearings is remarkably small. However, when the rubbing speed of a journal bearing is very low or extremely high, the friction loss may become excessive when compared with the performance of a rolling surface bearing. A good example is the railroad car, now being fitted with roller bearings to eliminate the "hot box" troubles of journal bearings.

Heavy-duty bearings have oil circulated around and through them and some have an additional cooling system that circulates water around the bearing. Although revolving the steel shaft against babbitt metal produces less friction (and therefore less heat and wear) than steel against steel, it is still a problem to keep the parts cool. You know what causes a "burned out bearing" on your car, and how to prevent it. The same care and lubrication are necessary on all Navy equipment, only more so, because



5.20

Figure 11-1.—Babbitt-lined bearing in which steel shaft revolves.

there is a lot of equipment, and many lives depend on its continued operation.

3. **THRUST BEARINGS** are used on rotating shafts, such as those supporting bevel gears, worm gears, propellers, and fans. They are installed to resist axial thrust or force and to limit

axial movement. They are used chiefly on heavy machinery, such as Kingsbury thrust bearings used in heavy marine propelling machinery (figs. 11-2 and 11-3). The base of the housing holds an oil bath, and the rotation of the shaft continually distributes the oil. The bearing consists of a thrust collar on the propeller shaft and two or more stationary thrust shoes on either side of the collar. Thrust is transmitted from the collar through the shoes to the gear housing and the ship's structure to which the gear housing is bolted.

Antifrictional Or Roller and Ball Bearings

You have had first-hand acquaintance with ball bearings since you were a child. They are what made your roller skates or bicycle wheels spin freely. If any of the little steel balls came out and were lost, your roller skates screeched and groaned. The balls or rollers are of hard, highly polished steel. The typical bearing consists of two hardened steel rings (called RACES), the hardened steel balls or rollers, and a SEPARATOR. The motion occurs between the race surfaces and the rolling elements. There

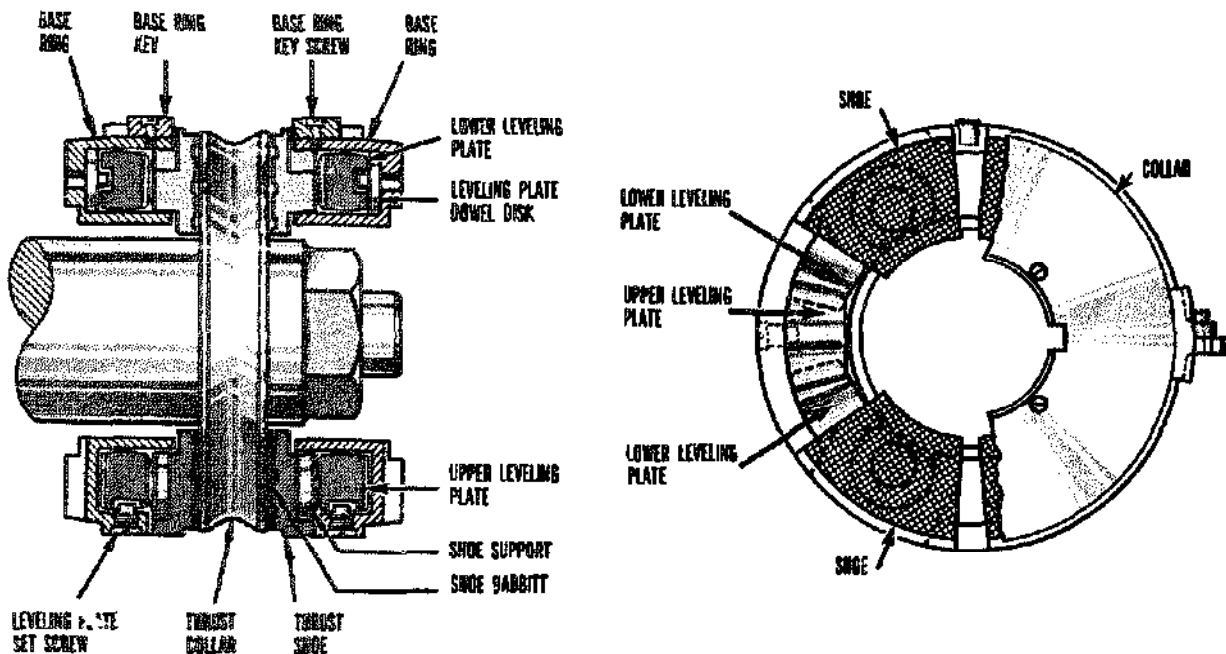
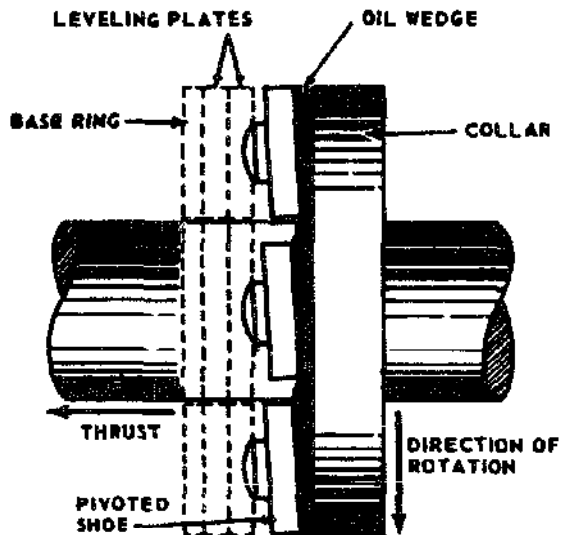


Figure 11-2.—Kingsbury pivoted-shoe thrust bearing.

38.85:.86X





38.86.1

Figure 11-3.—Diagrammatic arrangement of a Kingsburg thrust bearing, showing oil film.

are seven basic types of antifrictional bearings (fig. 11-4).

1. Ball bearings
2. Cylindrical roller bearings
3. Tapered roller bearings
4. Self-aligning roller bearings with spherical outer raceway
5. Self-aligning roller bearings with spherical inner raceway
6. Ball thrust bearings
7. Needle roller bearings

Roller bearing assemblies are usually easy to disassemble for inspection, cleaning, and replacement of parts. Ball bearings, however, are assembled by the manufacturer and installed, or replaced, as a unit. Sometimes maintenance publications refer to roller and ball bearings as being either thrust or radial bearings. The difference between the two depends on the angle of intersection between the direction of the load and the plane of rotation of the bearing. Figure 11-5A shows a radial ball bearing assembly. The load here is pressing outward along the radius of the shaft. Now suppose a strong thrust were to be exerted on the right end of the shaft, tending to move it to the left. You can see that the radial bearing is not designed to support this axial thrust. Even putting a shoulder between the load and the inner race wouldn't do. It would just

pop the bearings out of their races. The answer is to arrange the races differently, as in figure 11-5B. Here is a thrust bearing. With a shoulder under the lower race, and another between the load and the upper race, it will handle any axial load up to its design limit. Sometimes bearings are designed to support both thrust and radial loads. This is the explanation of the term **RADIAL THRUST** bearings. The tapered roller bearing in figure 11-6 is an example.

Antifriction bearings require smaller housings than other bearings of the same load capacity, and can operate at higher speeds.

## SPRINGS

Springs are elastic bodies (generally metal) which can be twisted, pulled, or stretched by some force, and which have the ability to return to their original shape when the force is released. All springs used in naval machinery are made of metal—usually steel, though some are of phosphor bronze, brass, or other alloys. A part that is subject to constant spring thrust or pressure is said to be **SPRING LOADED**. (Some components that appear to be spring loaded are actually under hydraulic or pneumatic pressure, or are moved by weights.)

### Functions of Springs

Springs are used for many purposes, and one spring may serve more than one purpose. Listed below are some of the more common of these functional purposes. As you read them, try to think of at least one familiar application of each.

1. To store energy for part of a functioning cycle.
2. To force a component to bear against, to maintain contact with, to engage, to disengage, or to remain clear of, some other component.
3. To counterbalance a weight or thrust (gravitational, hydraulic, etc.). Such springs are usually called equilibrator springs.
4. To maintain electrical continuity.
5. To return a component to its original position after displacement.
6. To reduce shock or impact by gradually checking the motion of a moving weight.
7. To permit some freedom of movement between aligned components without disengaging them. These are sometimes called **takeup springs**.

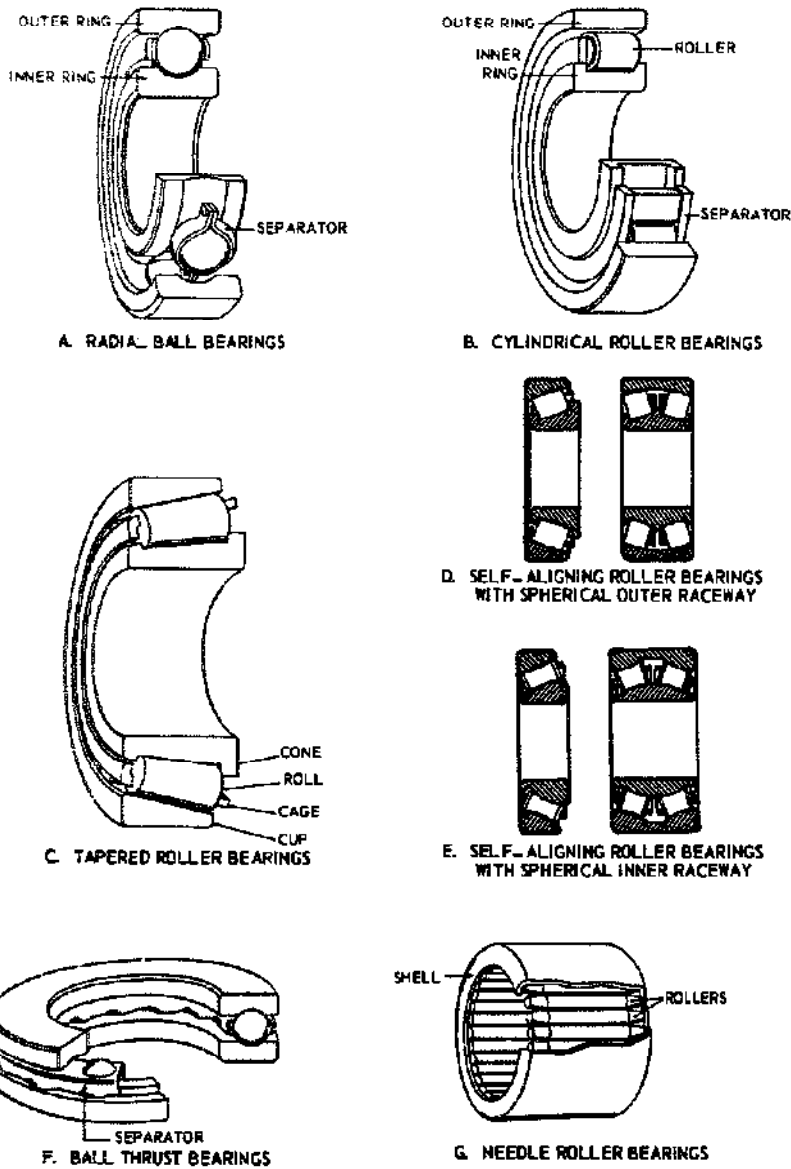


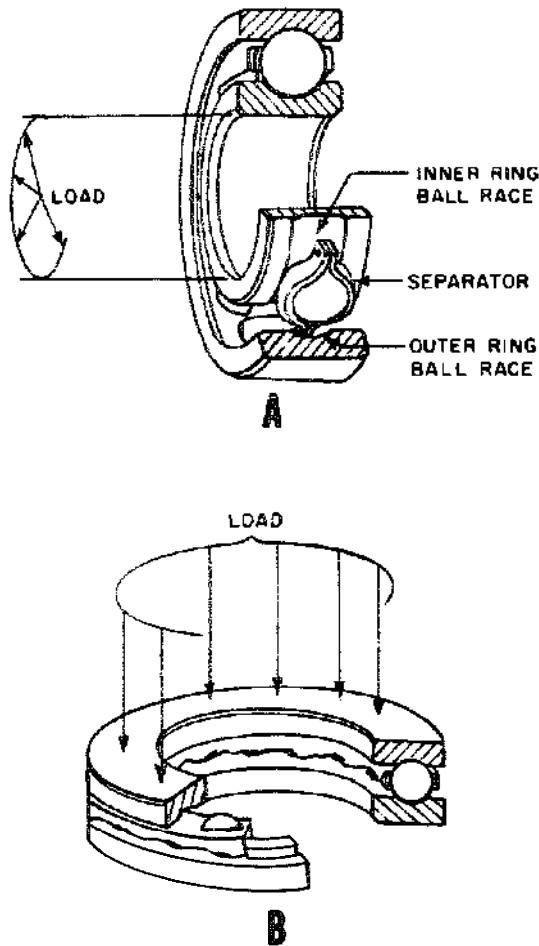
Figure 11-4.—The seven basic types of antifrictional bearings.

5.21

### Types of Springs

As you read different books you will find that authors do not agree on classification of types of springs. The names are not as important as the types of work they can do and the loads they can bear. We may say there are three basic types: (1) flat; (2) spiral; (3) helical or coil.

1. FLAT springs include various forms of elliptic or leaf springs (fig. 11-7A (1&2)), made up of flat or slightly curved bars, plates, or leaves, and special flat springs (fig. 11-7A (3)). A special flat spring is made from a flat strip or bar, into whatever shape or design is calculated to be best suited for its position and purpose.

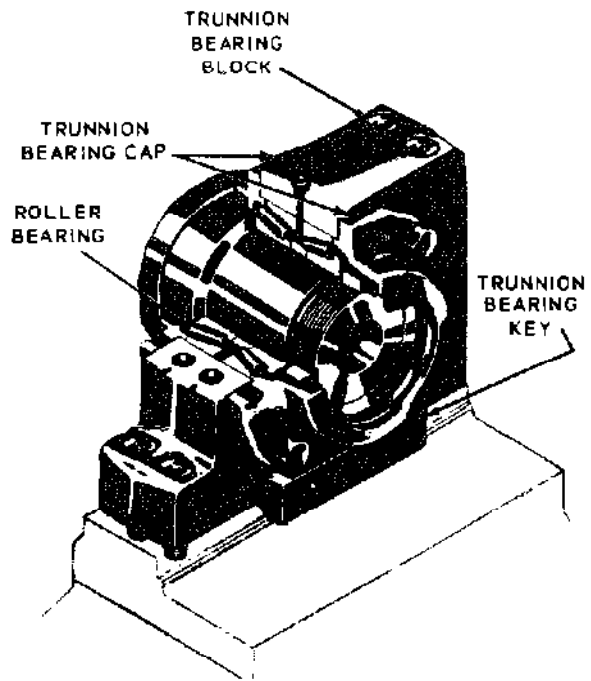


5.21  
Figure 11-5.—Ball bearings. A. Radial type; B. Thrust type.

2. **SPIRAL** springs are sometimes called clock or power springs (11-7B), and sometimes coil springs. A well known example is a watch or clock spring, which is wound (tightened) and then gradually releases the power as it unwinds.

Although there is good authority for calling this spring by other names, to avoid confusion we shall consistently call it **SPIRAL**.

3. **HELICAL** springs, often called spiral, but not in this text (fig. 11-7D), are probably the most common type of spring. They may be used in compression (fig. 11-7D (L)), extension or tension (fig. 11-7D (2)), or torsion (fig. 11-7D (3)). A spring used in compression tends to shorten in action, while a tension spring



84.120  
Figure 11-6.—Radial-thrust roller bearing.

lengthens in action. Torsion springs are made to transmit a twist instead of a direct pull, and operate by coiling or uncoiling action.

In addition to straight helical springs, cone, double cone, keg, and volute springs are also classed as helical. These are usually used in compression. A cone spring (fig. 11-7D (4)), often called a valve spring because it is frequently used in valves, is shaped by winding the wire on a tapered mandrel instead of a straight one. A double cone spring (not illustrated) is composed of two cones joined at the small ends, and a keg spring (not illustrated) is two cone springs joined at their large ends.

**VOLUTE** springs (fig. 11-7D (5)) are conical springs made from a flat bar which is so wound that each coil partially overlaps the adjacent one. The width (and thickness) of the material gives it great strength or resistance.

A conical spring can be pressed flat so it requires little space, and it is not likely to buckle sidewise.

4. **TORSION BARS** (fig. 11-7C) are straight bars that are acted on by torsion (twisting force). The bar may be circular or rectangular in cross

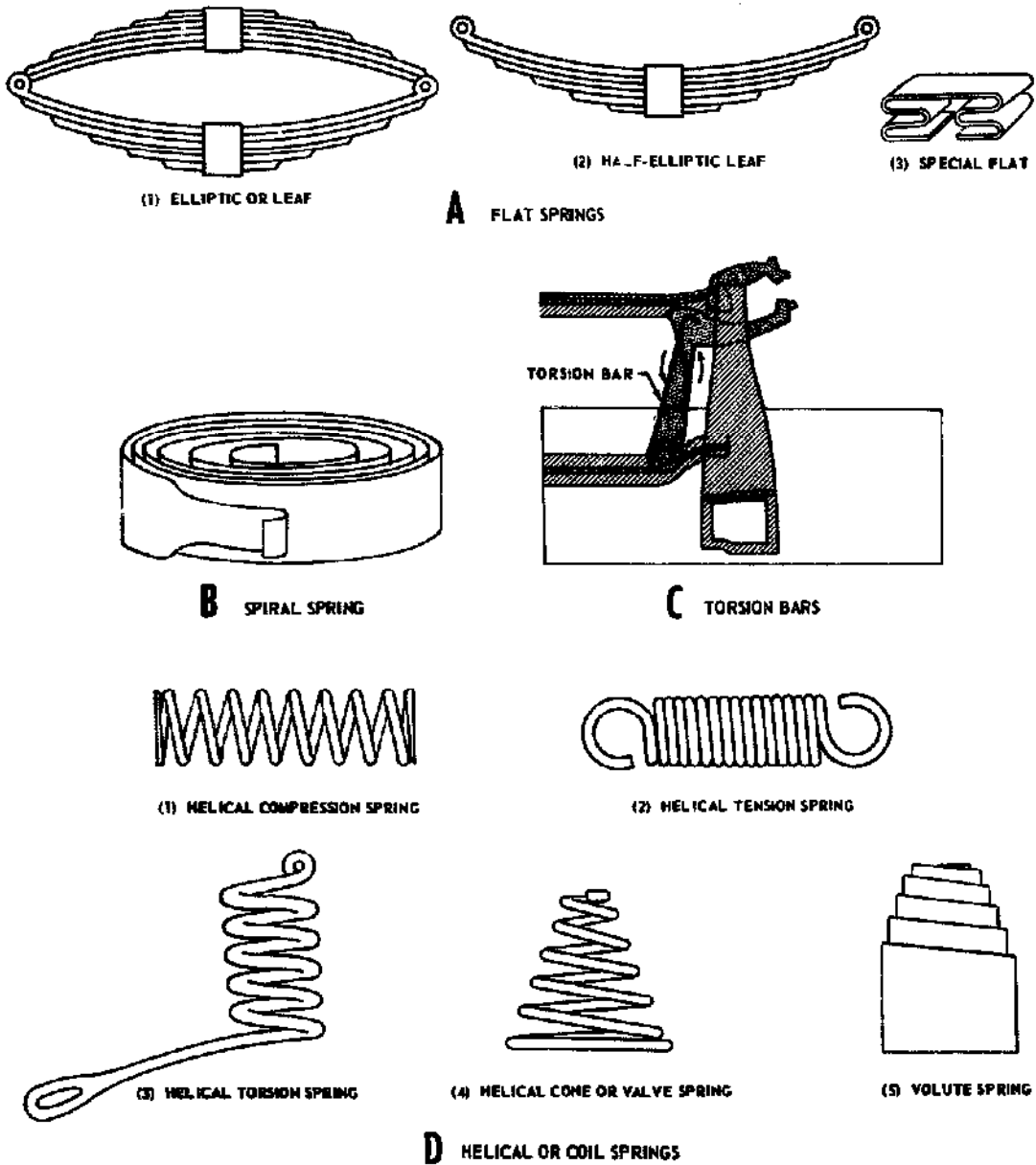


Figure 11-7.—Types of springs.

84.131

section, or less commonly in other shapes. It may also be a tube.

5. A special type of spring is a RING SPRING or DISC spring (not illustrated). It is made of a number of metal rings or discs that overlap each other.

**BASIC MECHANISMS**

**THE GEAR DIFFERENTIAL**

A gear differential is a mechanism that is capable of adding and subtracting mechanically. To be more precise, it adds the total revolutions

of two shafts—or subtracts the total revolutions of one shaft from the total revolutions of another shaft—and delivers the answer by positioning a third shaft. The gear differential will add or subtract any number of revolutions, or very small fractions of revolutions, continuously and accurately. It will produce a continuous series of answers as the inputs change.

Figure 11-8 is a cutaway drawing of a bevel gear differential showing all its parts and how they are related to each other. Grouped around the center of the mechanism are four bevel gears, meshed together. The two bevel gears on either side are called "end gears." The two bevel gears above and below are called "spider gears." The long shaft running through the end gears and the three spur gears is called the "spider shaft." The short shaft running through the spider gears, together with the spider gears themselves, is called the "spider."

Each of the spider gears and the end gears are bearing mounted on their shafts and are free to rotate. The spider shaft is rigidly connected with the spider cross shaft at the center block where they intersect. The ends of the spider shaft are secured in flanges or hangers, but they are bearing mounted and the shaft is free to rotate on its axis. It follows then that to rotate the spider shaft, the spider, consisting of the spider cross shaft and the spider gears, must tumble, or spin, on the axis of the spider shaft, inasmuch as the two shafts are rigidly connected.

The three spur gears shown in figure 11-8 are used to connect the two end gears and the spider shaft to other mechanisms. They may be of any convenient size. Each of the two input spur gears is attached to an end gear. An input gear and an end gear together are called a "side" of a differential. The third spur gear is the output gear, as designated in figure 11-8. This is the

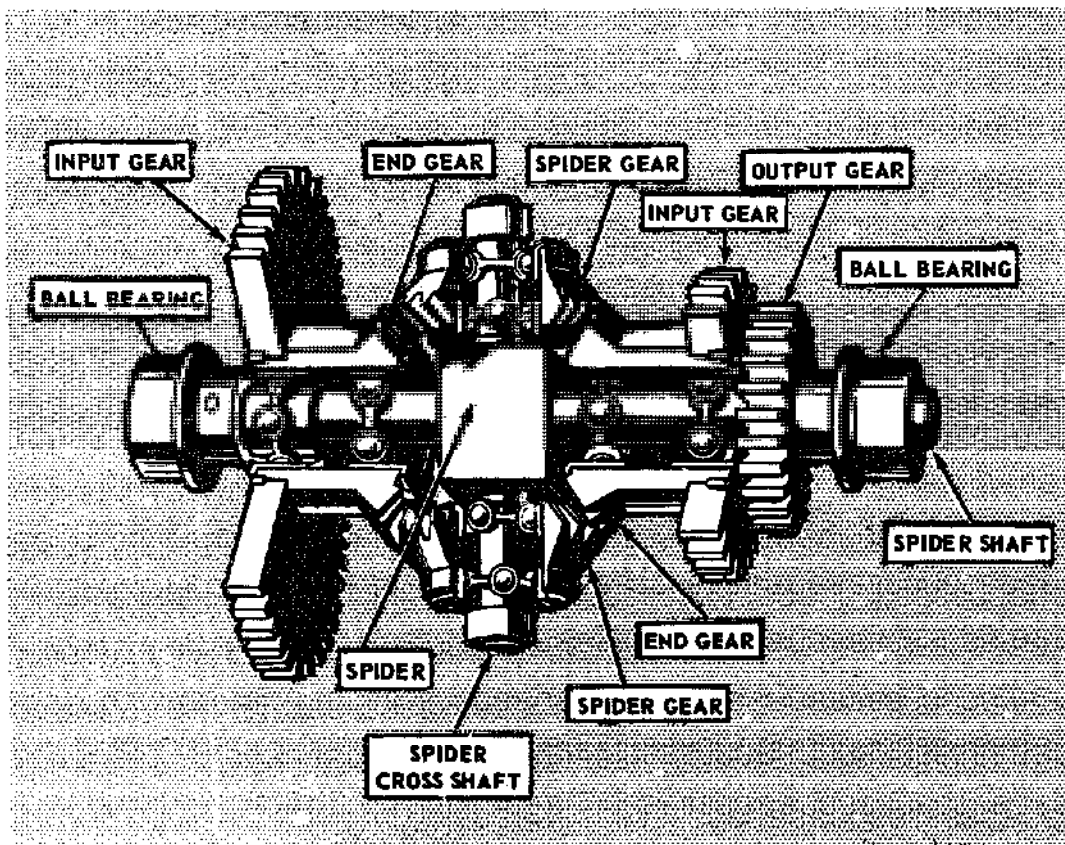


Figure 11-8.—Bevel gear differential.

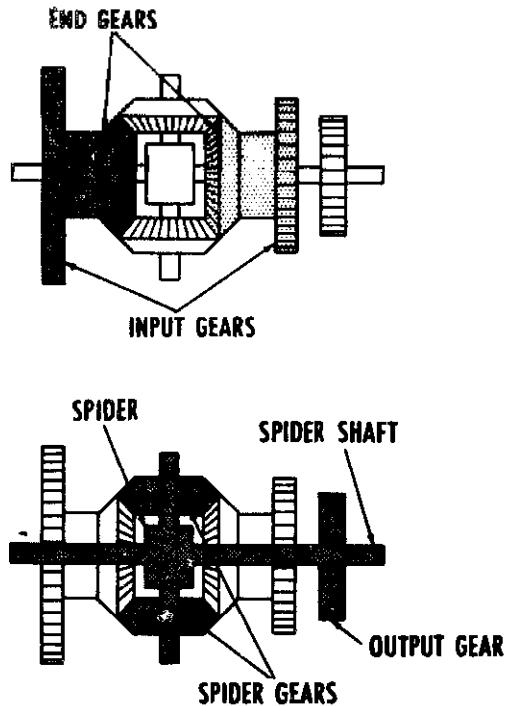
only gear that is pinned to the spider shaft. All of the other gears, both bevel and spur, in the differential are bearing mounted.

Figure 11-9 is an exploded view of a gear differential showing each of its individual parts, and figure 11-10 is a schematic sketch showing the relationship of the principle parts.

**How it Works**

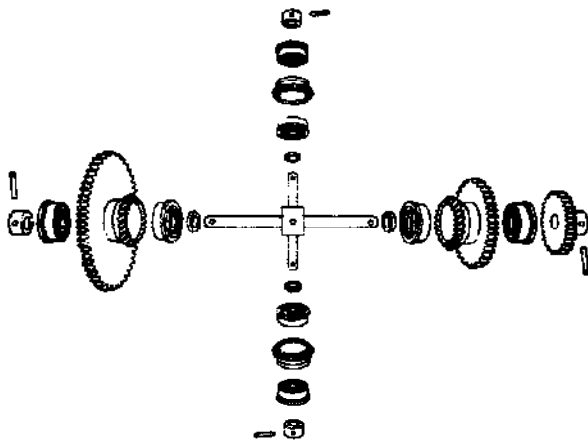
For the present we will assume that the two sides are the inputs and the gear on the spider shaft is the output. Later it will be shown that any of these three gears can be either an input or an output. Now let's look at figure 11-11. In this hookup the two end gears are positioned by the input shafts, which represent the quantities to be added or subtracted. The spider gears do the actual adding and subtracting. They follow the rotation of the two end gears, turning the spider shaft a number of revolutions proportional to the sum, or difference, of the revolutions of the end gears.

Suppose the left side of the differential is rotated while the other remains stationary, as in block 2 of figure 11-11. The moving end gear will drive the spider gears, making them roll on the stationary right end gear. This motion will turn the spider in the same direction as the input and, through the spider shaft and output gear, the output shaft. The output shaft will turn a number of revolutions proportional to the input.



110.8

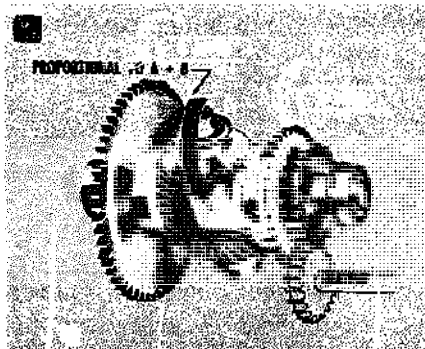
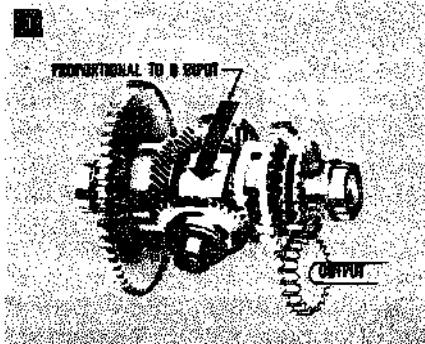
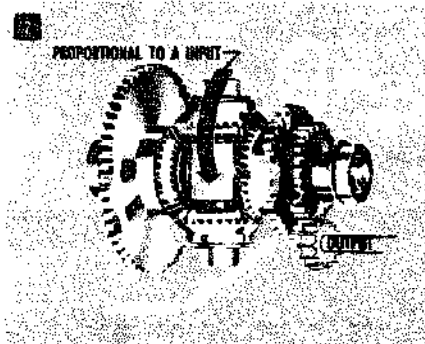
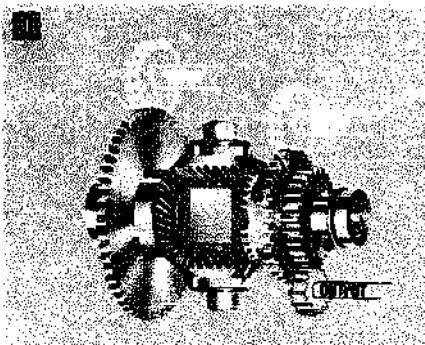
Figure 11-10. —The differential. End gears and spider arrangement.



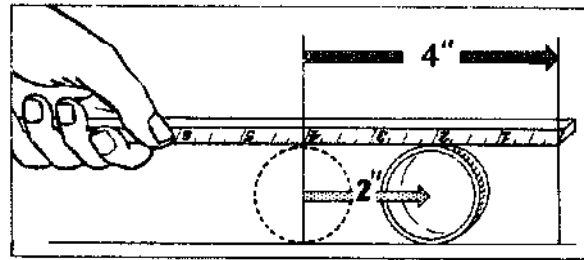
131.55

Figure 11-9. —Exploded view of differential gear system.

If the right side is now rotated and the left side held stationary, as in block 3 of figure 11-11, the same thing will happen. If both input sides of the differential are turned in the same direction at the same time, the spider will be turned by both at once, as in block 4 of figure 11-11. The output will be proportional to the sum of the two inputs. Actually, the spider makes only half as many revolutions as the sum of the revolutions of the end gears, because the spider gears are free to roll between the end gears. To understand this better, let's look at figure 11-12. Here a cylindrical drinking glass is rolled along a table top by pushing a ruler across its upper side. The glass will roll only half as far as the ruler travels. The spider gears in the differential roll against the end gears in exactly the same way. Of course, the answer can be corrected by



110.9 Figure 11-11.—How a differential works.



131.56 Figure 11-12.—The spider makes only half as many revolutions.

using a 2:1 gear ratio between the gear on the spider shaft and the gear for the output shaft. Very often, for design purposes, this gear ratio will be found to be different.

When the two sides of the differential move in opposite directions, the output of the spider shaft is proportional to the difference of the revolutions of the two inputs. This is because the spider gears are free to turn, and are driven in opposite directions by the two inputs. If the two inputs are equal and opposite, the spider gears will turn, but there will be no movement of the spider shaft. If the two inputs turn in opposite directions for an unequal number of revolutions, the spider gears roll on the end gear that makes the lesser number of revolutions, rotating the spider in the direction of the input making the greater number of revolutions. The motion of the spider shaft will be equal to half the difference between the revolutions of the two inputs. A change in the gear ratio to the output shaft can then give us any proportional answer we wish.

We have thus far been describing a hookup wherein the two sides are inputs and the spider shaft the output. As long as it is recognized that the spider follows the end gears for half the sum, or difference, of their revolutions, however, it is not necessary to always use this type hookup. The spider shaft may be used as one input and either of the sides used as the other. The other side will then become the output. This fact permits three different hookups for any given differential, as is illustrated in figure 11-13. Whichever proves the most convenient mechanically may be used.

In chapter 14 of this book, the differential as used in the automobile will be described. This differential is similar in principle, but, as you

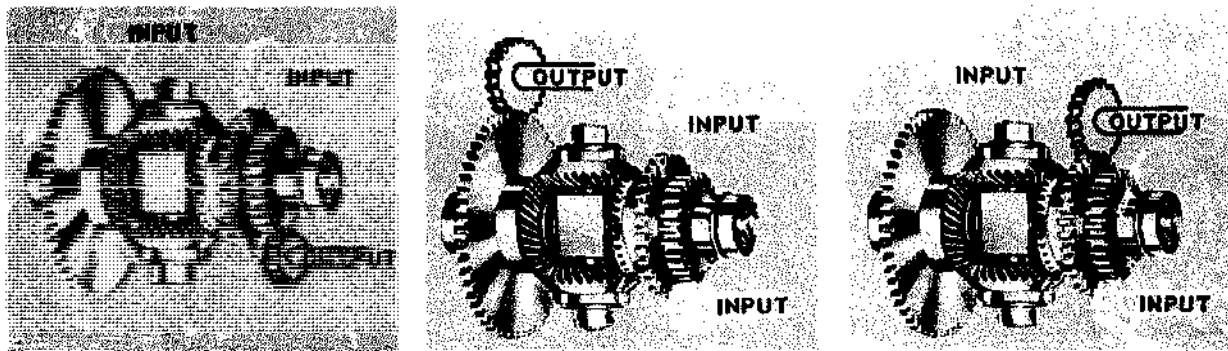


Figure 11-13.—Any of these three hookups can be used.

110.9

will see, is somewhat different in its mechanical makeup. In chapter 15 you will be given information on differentials as they are used in computers.

#### LINKAGES

A linkage may consist of either one or a combination of the following basic parts:

1. Rod, shaft, or plunger
2. Lever
3. Rocker arm
4. Bell crank

These parts combined are used to transmit limited rotary or linear motion. To change the direction of a motion, cams are used with the linkage.

Lever type linkages (fig. 11-14) are used in equipment which has to be opened and closed; for instance, valves in electric-hydraulic systems, gates, clutches, clutch-solenoid interlocks, etc. Rocker arms are merely a variation, or special use, of levers.

Bell cranks are used primarily to transmit motion from a link traveling in one direction to another link which is to be moved in a different direction. The bell crank is mounted on a fixed pivot, and the two links are connected at two points in different directions from the pivot. By properly locating the connection points, the output links can be made to move in any desired direction.

All linkages require occasional adjustments or repair, particularly when they become worn. To make the proper adjustments, a person must be familiar with the basic parts which constitute

a linkage. Adjustments are normally made by lengthening or shortening the rods and shafts by means of a clevis or turnbuckle.

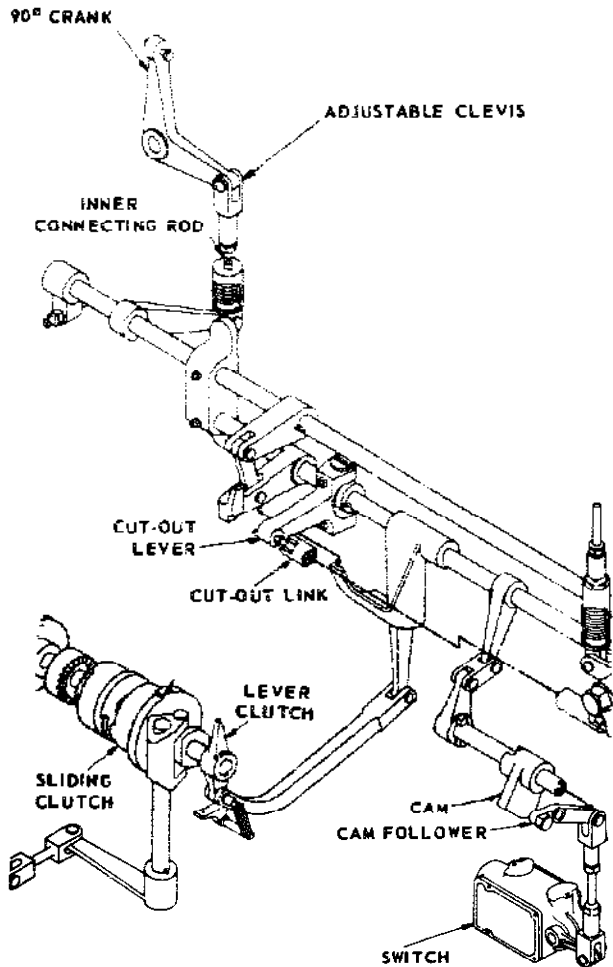
#### COUPLINGS

In a broad sense, the term "coupling" applies to any device that holds two parts together. Line shafts which are made up of several shafts of different lengths may be held together by any of several types of shaft couplings. When shafts are very closely aligned, the sleeve coupling, as in figure 11-15, may be used. It consists of a metal tube slit at each end. The slitted ends enable the clamps to fasten the sleeve securely to the shaft ends. With the clamps tightened, the shafts are held firmly together and turn as one shaft. The sleeve coupling also serves as a convenient device for making adjustments between units. The weight at the opposite end of the clamp from the screw is merely to offset the weight of the screw and clamp arms. By distributing the weight more evenly, shaft vibration is reduced.

The Oldham coupling, named for its inventor, may be used to transmit rotary motion between shafts which are parallel but not necessarily always in perfect alignment.

An Oldham coupling (fig. 11-16), consists of a pair of disks, one flat and the other hollow. These disks are pinned to the ends of the shafts. A third (center) disk, with a pair of lugs projecting from each face of the disk, fits into the slots between the two end disks and thus enables one shaft to drive the other shaft. A coil spring, housed within the center and the hollow end disk,

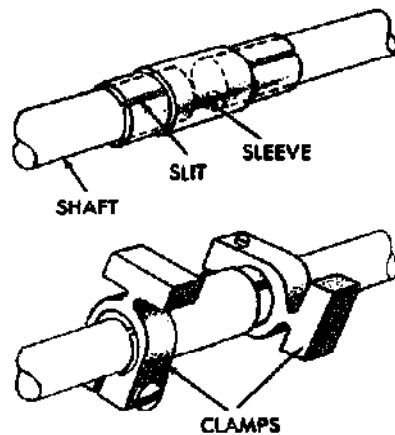




131.57

Figure 11-14.—Linkages.

forces the center disk against the flat disk. When the coupling is assembled on the shaft ends, a flat lock spring is slipped into the space around the coil spring. The ends of the flat spring are formed so that when the flat spring is pushed into the proper place, the ends of the spring are pushed out and locked around the lugs. A lock wire is passed between the holes drilled through the projecting lugs to guard the assembly. The coil spring compensates for any change in shaft length. (Shaft length may vary due to changes in temperature.)



12.51

Figure 11-15.—Sleeve coupling.

The disks, or rings, connecting the shafts allow a small amount of radial play, and this allows a small amount of misalignment of the shafts as they rotate. Oldham type couplings can be easily connected and disconnected.

A universal joint is the answer when two shafts not in the same plane must be coupled. Universal joints may have various forms. They are used in nearly all types and classes of machinery. An elementary universal joint, sometimes called a Hooke joint (fig. 11-17), consists of two U-shaped yokes fastened to the ends of the shafts to be connected. Within these yokes is a cross-shaped part which holds the yokes together and allows each yoke to bend, or pivot, one with respect to the other. With this arrangement, one shaft can drive the other even though the angle between the two is as great as  $25^\circ$  from alignment. Figure 11-18 shows a ring and trunnion type of universal joint. This is merely a slight modification of the old Hooke joint. This type is commonly used in automobile drive shaft systems. Two, and sometimes three, are utilized. You will read more about these in chapter 14 of this book. Another type of universal joint is used where a smoother torque transmission is desired and less structural strength is required. This is the Bendix-Weiss universal joint (fig. 11-19). In this type of joint, four large balls transmit the rotary force, with a smaller ball as a spacer. With the Hooke type of universal joint, a whipping motion occurs as the shafts rotate—the amount of whip depending on the degree of shaft misalignment. The Bendix-Weiss joint does not have this disadvantage; it

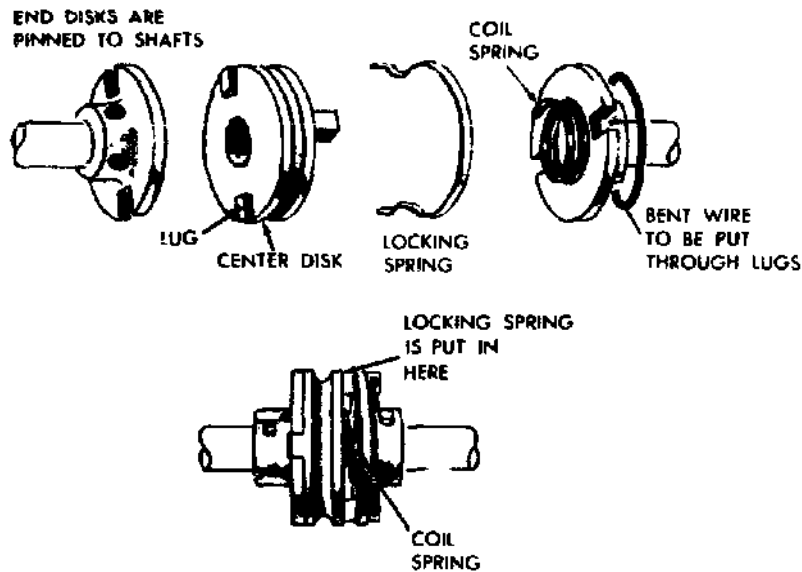


Figure 11-16.—Oldham coupling.

12.52

transmits rotary motion with a constant angular velocity. This type of joint is both more expensive to manufacture and of less strength than the Hooke types, however.

The following four types of couplings are also used extensively in naval equipment:

1. The fixed (sliding lug) coupling is non-adjustable; however, it does allow for a small amount of misalignment in shafting (fig. 11-20).

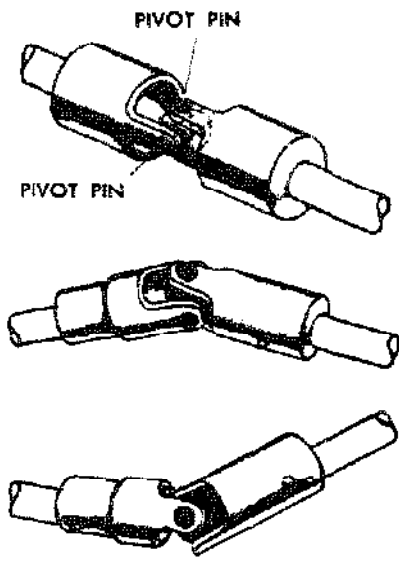
2. The flexible coupling (fig. 11-21), connects two shafts by means of a metal disk. Two coupling hubs, each splined to its respective shaft, are bolted to the metal disk. The flexible coupling provides a small amount of flexibility to allow for a slight axial misalignment of the shafts.

3. The adjustable (vernier) coupling provides a means of finely adjusting the relationship of two interconnected rotating shafts, (fig. 11-22). By loosening a clamping bolt and turning an adjusting worm, one shaft may be rotated while the other remains stationary. When the proper relationship is attained, the clamping bolt is retightened, locking the shafts together again.

4. The adjustable flexible (vernier) coupling (fig. 11-23) is simply a combination of the flexible disk coupling and the adjustable (vernier) coupling.

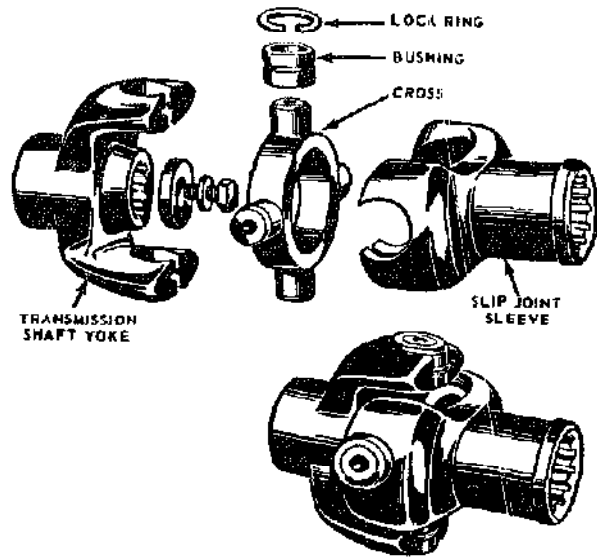
#### CAM AND CAM FOLLOWERS

A cam is a specially shaped surface, projection, or groove whose movement with respect to a part in contact with it (cam follower) drives the cam follower in another movement in response. A cam may be a projection on a revolving shaft (or on a wheel) for the purpose of changing the direction of motion from rotary to up-and-down, or vice versa. It may be a sliding piece or a groove to impart an eccentric motion. Some cams do not move at all, but cause a change of motion in the contacting part. Cams are not ordinarily used to transmit power in the sense that gear trains are. They are generally used to modify mechanical movement, the power for which is furnished through other means. They may control other mechanical units, or lock together or synchronize two or more engaging units.



5.34

Figure 11-17.—Universal joint (Hooke type).



81.194

Figure 11-18.—Ring and trunnion universal joint.

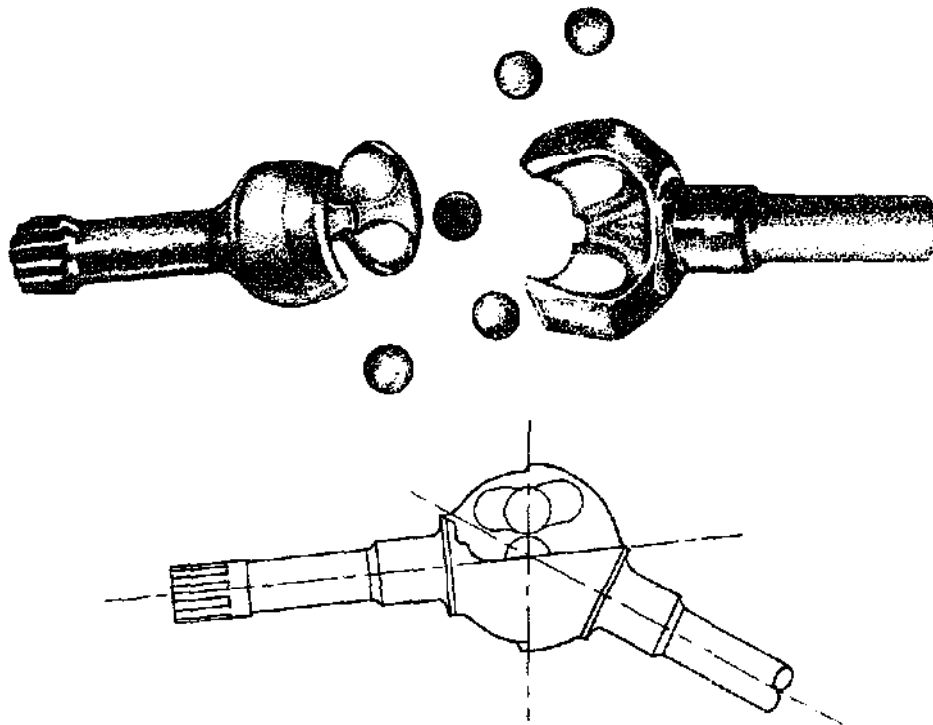
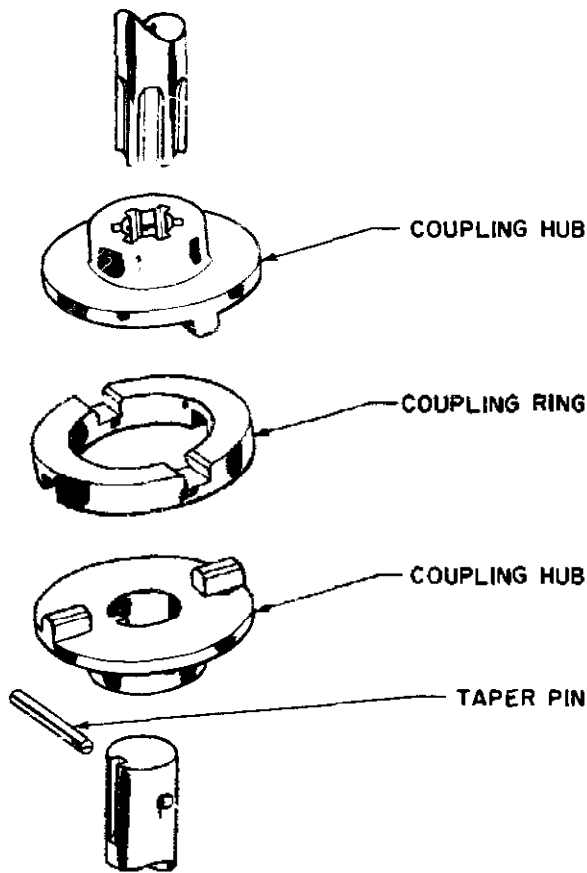


Figure 11-19.—Bendix-Weiss universal joint.

5.34



84.133.3

Figure 11-20.—Fixed coupling.

**Types and Uses**

Cams are of many shapes and sizes and are widely used in machines and machine tools (fig. 11-24). Cams may be classified as:

1. Radial or plate cams
2. Cylindrical or barrel cams
3. Pivoted beams

A similar grouping of types of cams is: Drum or barrel cams; edge cams; face cams.

The drum or barrel cam has a path for the roll or follower cut around the outside, and imparts a to-and-fro motion to a slide or lever in a plane parallel to the axis of the cam. Sometimes these cams are built up on a plain drum with cam plates attached.

Plate cams are used in 5''/38 and 3''/50 guns to open the breechblock during counter-recoil.

Edge or peripheral cams, also called disc cams, operate a mechanism in one direction only, gravity or a spring being relied upon to hold the cam roll in contact with the edge of the cam. The shape of the cam may be made to suit the action required, such as heart shape.

Face cams have a groove or roll path cut in the face and operate a lever or other mechanism positively in both directions, as the roll is always guided by the sides of the slot. Such a groove can be seen on top of the bolt of the Browning machine gun, caliber .30, or in fire control cams. The shape of the groove may give its name to the cam, as for example, constant lead cam, square cam, run-out cam.

The toe and wiper cam shown in figure 11-24 (d) is an example of a pivoted beam.

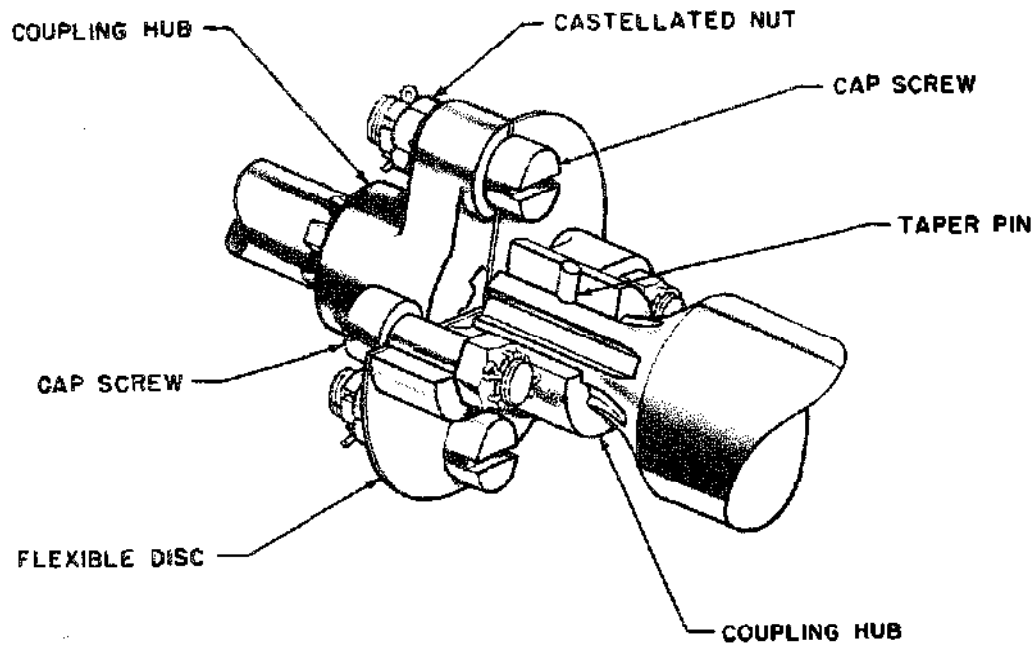
**CLUTCHES**

**TYPES**

A clutch is a form of coupling which is designed to connect or disconnect a driving and a driven member for stopping or starting the driven part. There are two general classes of clutches—positive clutches and friction clutches.

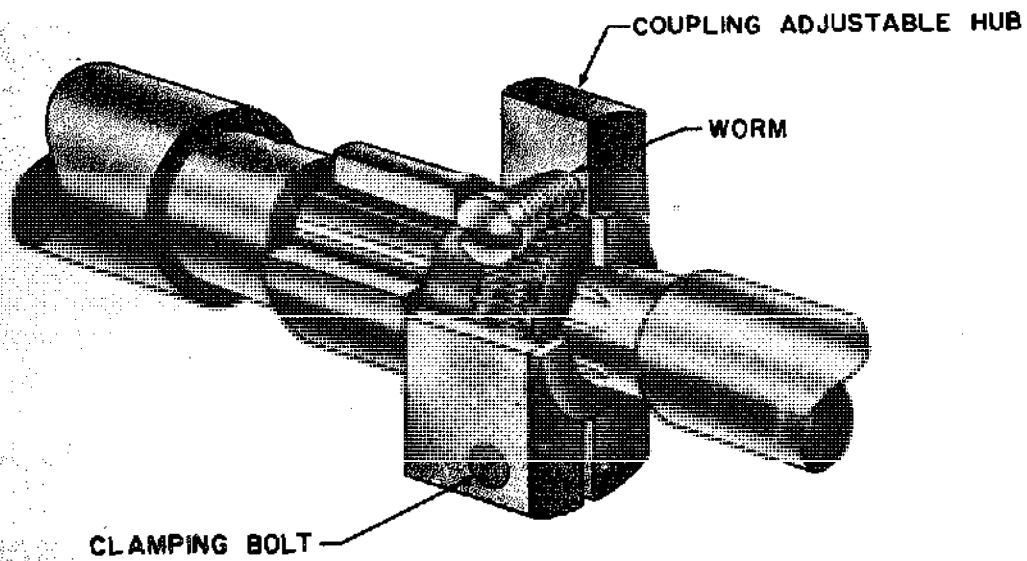
**Positive Clutches.** Positive clutches have teeth which interlock. The simplest is the jaw or claw type (fig. 11-25A), which is usable only at low speeds. The spiral claw or ratchet type (fig. 11-25B) cannot be reversed. An example of a clutch is seen in bicycles—it engages the rear sprocket with the rear wheel when the pedals are pushed forward, and lets the rear wheel revolve freely when the pedals are stopped.

**Friction Clutches.** The object of a friction clutch is to connect a rotating member to one that is stationary, to bring it up to speed, and to transmit power with a minimum of slippage. Figure 11-25C shows a cone clutch commonly used in motor trucks. They may be single-cone or double-cone. Figure 11-25D shows a disc clutch, also used in autos. A disc clutch may also have a number of plates (multiple-disc clutch). In a series of discs, each driven disc is located between two driving discs. You may have had experience with a multiple-disc clutch on your car. The Hele-Shaw clutch is a combined conical-disc clutch (fig. 11-25E). The groove permits circulation of oil, and cooling. Single-disc clutches are frequently dry clutches (no lubrication); multiple-disc clutches may be dry or wet (lubricated or run in oil).



84.133.2

Figure 11-21.—Flexible coupling.



131.58

Figure 11-22.—Adjustable (vernier) coupling.

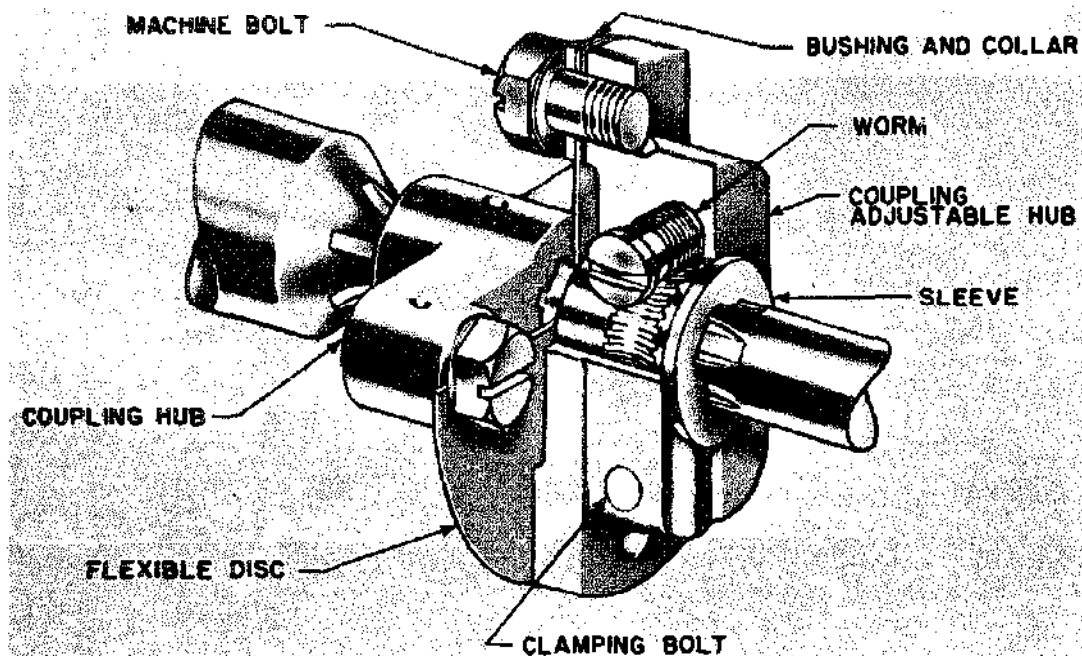


Figure 11-23.—Adjustable flexible (vernier) coupling.

11.133.4

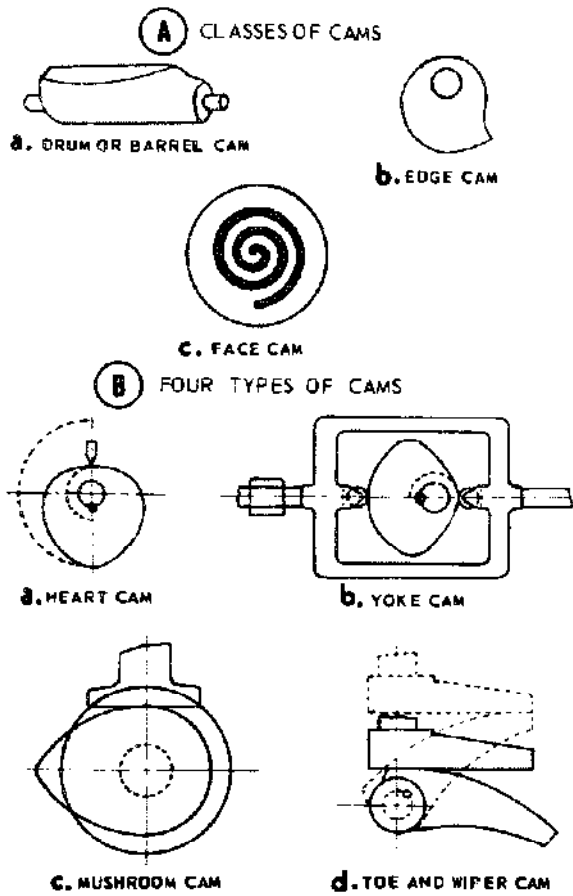
Magnetic clutches are a recent development in which the friction surfaces are brought together by magnetic force when the electricity is turned on (fig. 11-25F). The induction clutch transmits power without contact between driving and driven members.

Expanding clutches or rim clutches are named according to the way the pressure is applied to the rim—block, split-ring, band, or roller. In one type of expanding clutch a powerful effect is gained by the expanding action of right-and left-hand screws as a sliding sleeve is moved along a shaft, and expands the band

against the rim. The centrifugal clutch is a special application of a block clutch.

Coil clutches are used where heavy parts are to be moved, as in a rolling mill. Great friction is caused by the grip of the coil when it is thrust onto a cone on the driving shaft, yet the clutch is very sensitive to control.

Pneumatic and hydraulic clutches are used on Diesel engines and transportation equipment. Hydraulic couplings (fig. 11-25G), which serve also as clutches, are used in the hydraulic A-end of electric-hydraulic gun drives.



5.29

Figure 11-24.—Classes and types of cams.

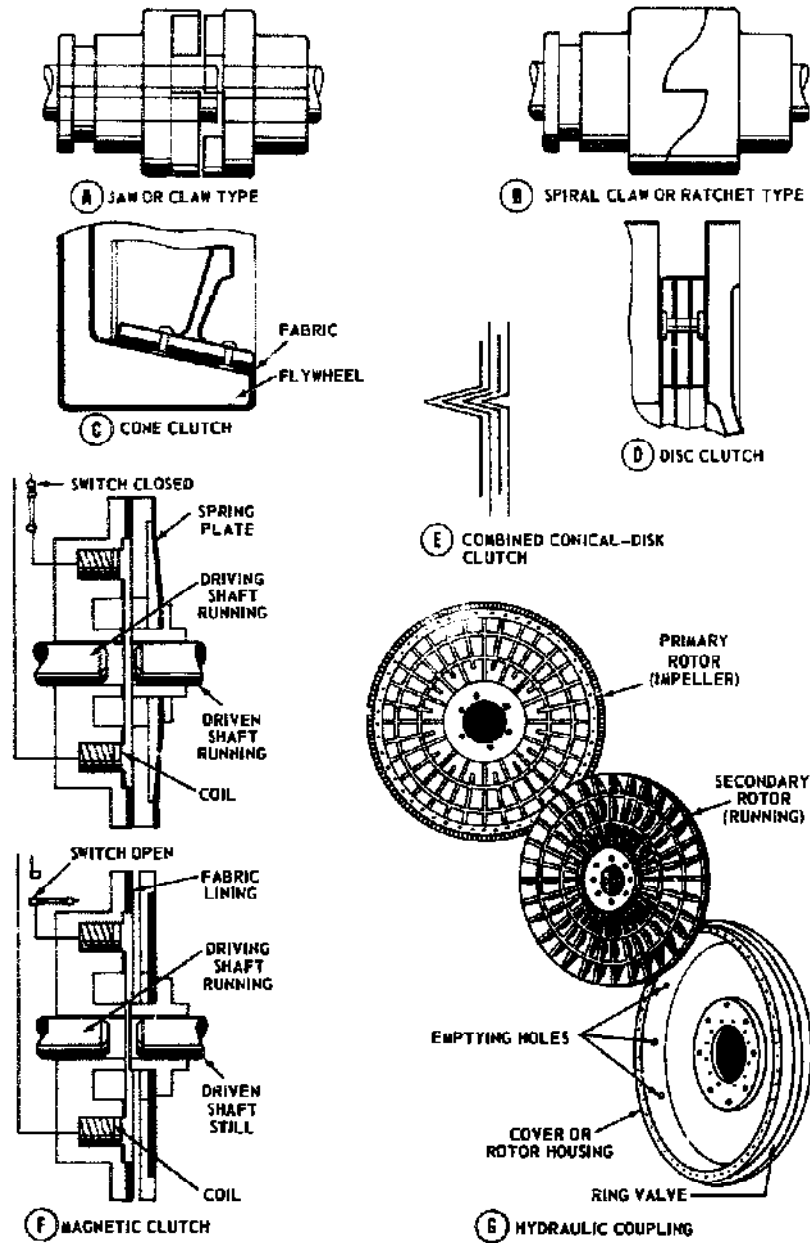


Figure 11-25. --Types of clutches.



## CHAPTER 12

# COMPLEX MACHINES

We've been studying only the more simple machines so far. Now that we've learned about them, let's take a look at some complex machines. One of the first things you should learn is to recognize the simple machines which make up a complex machine; for a complex machine is only a combination of simple machines. In the examples given in this chapter, look first for the simple machines. If you've been studying well, you should be able to predict what will happen when a force is applied at a given point in a simple machine. Make a step-by-step analysis, and you'll discover that complex machines are not as complicated or mysterious as they first appear to be.

### PORTHOLE CLOSER-BLANKET PULLER-UPPER

Take a good look at figure 12-1 and read the directions for operation. This machine was invented by a guy named Oscar. Sea water entering open port is caught in helmet (1) hung on rubber band. Rubber stretches and helmet is pushed down against shaft of Australian spear (2). Head of spear tips over box of bird seed (3) which falls in cage (4) where parrot (5) bends over to pick it up. Board strapped on parrot's back pulls on string (6) which releases arrow (7) and slams the port shut. Breeze from closing port turns page on calendar (8) to new day.

In the meantime, water falling over water-wheel (9) turns gears (10) which wind string (11) on drum (12). This pulls blanket up over Oscar. Arm (13) pulls on cord (14) and raises board under alarm clock (15) sliding same into bucket of water.

In case of mechanical breakdown at any point in the system, helmet is tipped by off-center peg (16) emptying water into funnel (17). Pipe (18) directs water onto Elmer, who is sleeping below. The theory is that Elmer will get up and do something about that open port--or about Oscar.

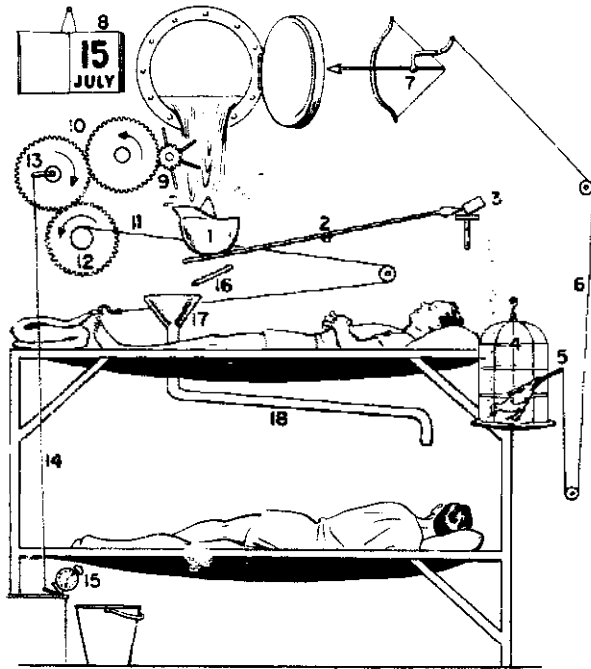
You'll probably agree that this nightmare is a complex machine. But, if you look carefully, you can see that Oscar has put together several simple machines to make this complicated device. He has used a couple of levers, several blocks, a gear train, and you can even find an inclined plane under the alarm clock.

While this gadget is nonsensical, it does call attention to the important fact that a complex machine is nothing more than a combination of two or more simple machines, conveniently arranged to do the job at hand. It makes no difference how big or complicated the machine is, you can figure out how it works if you understand the operation of the simple machines from which it is made. Just as you did with Oscar's Goldberg, always start at the point where the energy is applied and follow the movement systematically, step-by-step, to the business end.

### FUEL-OIL-HATCH COVER

Here's a complex mechanism that is easy to figure out. The hatch cover in figure 12-2 weighs a couple of hundred pounds; and the device which raises it is a complex machine. It is complex because it consists of two simple machines--a jackscrew and a first-class lever.

First locate the point where you apply a force to the machine. That wrench handle seems a likely spot. Remember that you can consider this handle as if it were the spoke of a wheel. Suppose you turn this handle in a counter-clockwise direction. That will cause the nut n to move upward along the threaded bolt. One complete turn of the handle will cause the nut to move upward a distance equal to the pitch of the thread on the bolt. The collar c follows the nut up and permits the lever arm I to rise. The other part of the lever arm L will move downward. Since I is much shorter than L, the downward movement of the cover will be much greater



131.59  
Figure 12-1.—A complex machine.

than the upward movement of the collar. It's a "speed-up" arrangement.

The hatch cover is closed by turning the handle counterclockwise, and is opened by turning the handle clockwise. This combination of two simple machines is better mechanically than one machine.

Here's how to go about figuring out how a complex machine works. Locate the point where the energy is applied and look over the part of the machine next in line. You say to yourself, "Oh, yeah, this is really a jackscrew"—or a wheel and axle, or whatever the machine happens to be. "If I turn it clockwise, then the piece right here will move so. That's going to cause this arm to move to the right. And since the arm is part of a first-class lever, the other end will move over to here to the left." In every case, you follow through in a similar manner from one part to another—carefully determining the direction and magnitude of the motion.

Perhaps you will want to know the size of the force that is exerted at some point in the machine, or perhaps the mechanical advantage up to a point. Remember that the mechanical advantage of a complex machine is equal to the

product of the mechanical advantage of each simple machine from which it is made.

Assume some numerical values for the hatch cover in figure 12-2 and see how you can calculate the mechanical advantage. For example, allow 18 inches for the length of the wrench from the end of the handle to the center of the bolt. Let the pitch of the thread be 1/4 inch. The collar is attached to arm 15 inches from the fulcrum, and the center of the cover lies 18 inches from the fulcrum along arm L.

The theoretical mechanical advantage of the jackscrew can be found by using the formula—

$$\begin{aligned} \text{M. A.} &= \frac{2\pi r}{p} \\ &= \frac{2 \times 3.14 \times 18}{1/4} = \frac{113}{1/4} = 452 \end{aligned}$$

Since jackscrews rarely have an efficiency of better than 30 percent, you'd be wise to multiply this theoretical mechanical advantage by 0.30, which gives an actual mechanical advantage of  $452 \times 0.30 = 136$  for this part of the machine.

Now figure what the lever action does for you. The theoretical mechanical advantage of a lever system can be found by dividing the length of the resistance arm by the length of the effort arm.

$$\text{M. A.} = \frac{1}{L} = \frac{5}{18} = 0.278$$

Notice that the lever gives you a mechanical advantage of less than one. Whenever the M.A. is less than one, you know that either the speed or the distance of motion has been magnified at the expense of force. In this case, you can afford to sacrifice force for distance.

The overall mechanical advantage of the machine is equal to the product of the two mechanical advantages, or  $136 \times 0.278 = 37.8$ . This is the standard method for figuring the M. A. of complex machines.

### A WATERTIGHT DOOR

Figure 12-3 shows you a watertight door—a complex machine that is a combination of a wheel-and-axle and a system of levers. That big center handle A is the point of input, which is the place to start. If you pull the handle to the right, point a on drive link 1 moves to the right. That's going to make point b on the same link move to the left. Now look at drag link 2.

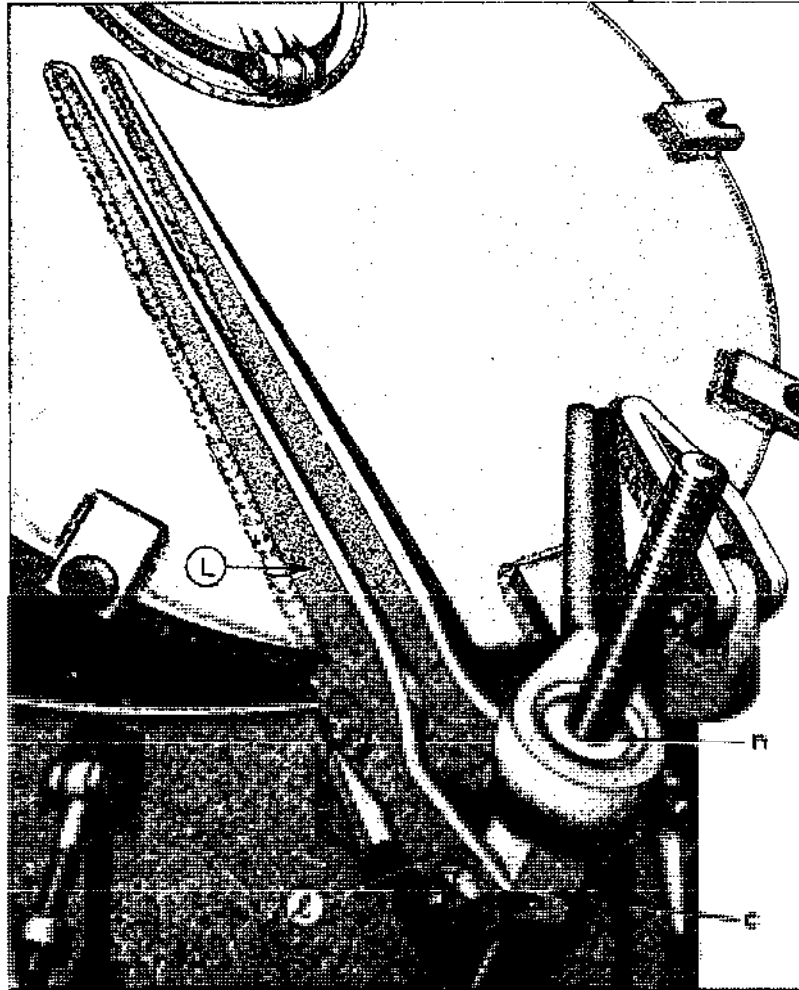


Figure 12-2.—A not-too-complex machine.

131.60

It will be moved to the left. Point a on drag line 2 moves in the direction indicated by the arrow. That action moves the outer—or right-hand—end of the bellcrank 3 upward, and the dog is extended to the locking position. At the same time drag link 4 moves downward—because it is pivoted to the left-hand end of bell-crank 3. If you follow the movement of link 4 you will see that as its end a moves down, it raises the end b of bellcrank 5 into the locking position.

Now come back to the end b of lever arm 2. Its motion is indicated by the arrow. End b moves lever 6 outward and into the locking position, and at the same time causes arm 7 to move

downward. This motion causes lever 8 to be swung in a clockwise direction until it too locks. You can see that lever arm 9 follows the movement of 8 and thus causes the dog at the top of the door to swing into the locked position.

Probably, at first glance, this mechanism looked highly complicated. But it isn't so tough to figure out, after all.

#### THE TYPEWRITER

The standard typewriter (fig. 12-4) is a good example of basic, or simple, machines combined

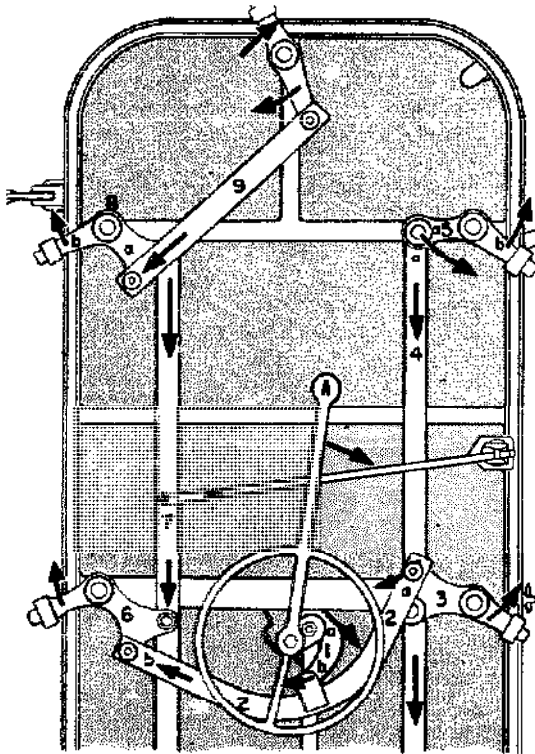


Figure 12-3.—It works too.

131.61

to make up a complex machine. In the following text and illustrations, see how many basic machines you can identify.

### CONSTRUCTION AND OPERATION

The keyboard of a typewriter contains all the keys, bars, levers, etc., which are used when operating the machine.

Each type key operates a type bar with a type head having two characters (top and bottom). When a key is depressed, the type head is carried up by a system of levers into the type guide where it strikes a ribbon in front of paper on the platen (roller) and prints one of the characters (soldered on the type head).

The bar at the lower front position of the keyboard is for spacing the escapement mechanism. There is a SHIFT key on each side of the

keyboard for shifting the type bars and segments up and down, as necessary, in order to use characters in the upper and lower positions on the type heads. Other keys are for backspacing, setting and clearing the tabulator mechanism, margin releasing, and so forth. There is also a ribbon selector lever, and another lever for changing direction of the ribbon.

A typewriter carriage is positioned on or between rails, and rides upon some type of roller or ball bearings. This carriage includes the platen and all parts of the typewriter which ride with it. The energy which drives the carriage while the machine is being operated comes from a mainspring enclosed in a metal drum. A ratchet wheel and pawl hold the mainspring in the position desired for a certain amount of tension. A draw band connects the end of the mainspring to the right end of the carriage.

The carriage rack, through the escapement mechanism (explained later), controls the space-by-space movement of the carriage. The teeth of the rack mesh with the escapement wheel pinion. The rack and pinion are conventional spur gear and rack assemblies. The pinion, when turned by movement of the carriage rack, turns the escapement wheel. The movement of the escapement wheel is limited by the escapement rocker, which moves forward and backward each time a key or the space bar is depressed and released, moving the carriage one space. Thus the escapement rocker allows the carriage to move only one type space each time a key or the space bar is struck. Movement of the carriage for each type space is controlled by the escapement wheel held by the LOOSE dog of the escapement rocker. The escapement wheel may rotate during regular typing only by the disengagement of the loose dog from the escapement wheel. When the escapement wheel shaft turns, it also feeds the ribbon through the ribbon guide.

The platen holds and controls the paper in the typewriter carriage and serves as a backstop for the typeface when it strikes the paper. At the left end of the platen there is a ratchet, which is held in position by a detent (shown later), until it is moved by the carriage return lever on the left of the carriage. The function of this ratchet is to establish evenly spaced typed lines on the paper.

In the middle of the left platen knob in figure 12-4 a variable line spacer is indicated. This variable line spacer is actually a clutch between the ratchet and the platen; it holds the platen ratchet in a fixed, locked relation to the platen. By pushing the variable line spacer in with the

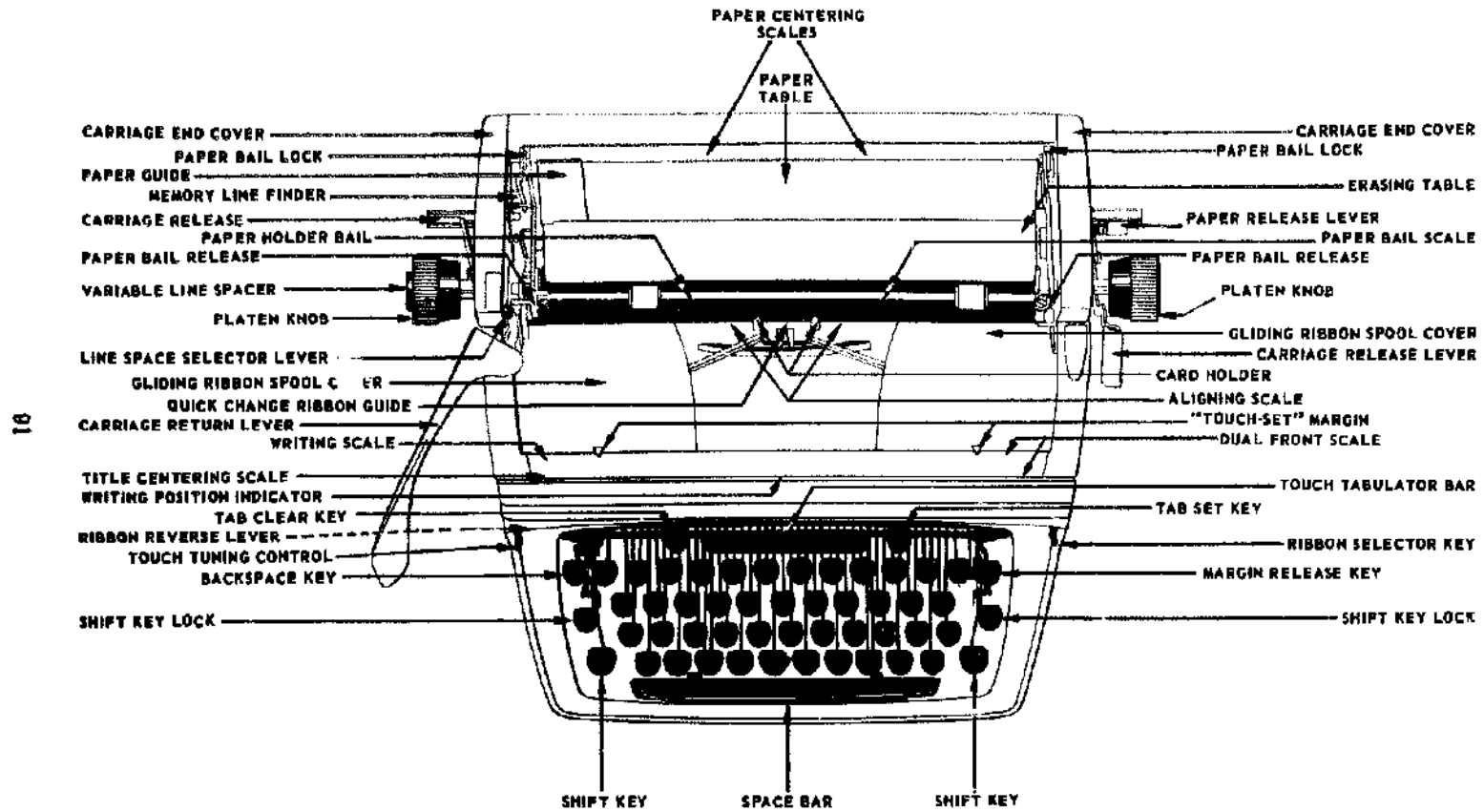


Figure 12-4.—External parts of a standard typewriter.

61.38X

left hand, the operator releases the clutch and can then turn the FREE platen to any desired position, forward or backward, with either hand. The line finder mechanism on a typewriter releases the ratchet detent and enables the operator to return the platen to an established writing line without using the variable mechanism.

**ESCAPEMENT MECHANISM**

The escapement mechanism (fig. 12-5) is the "heart" of a typewriter. It controls movement of the carriage during typing, allowing it to move a prescribed distance for each actuation of the escapement dogs (illustrated). The escapement is actuated once every time a type key is depressed and released, or once with each actuation of the space bar.

An escapement consists primarily of a wheel (with teeth on its perimeter) which works in conjunction with two holding dogs in a pivoted rocker mechanism. Study the illustration. As the dogs are moved back and forth, the wheel teeth contact the dogs alternately, resulting in the rotation of the wheel in EQUAL movements or steps.

The escapement rocker rocks forward and backward with respect to the front of the typewriter. This rocker contains the loose dog (catch) and the rigid (stationary) dog. As the escapement rocker pivots on a pivot pin and a pivot screw, it disengages the loose dog from an escapement wheel tooth and permits the escapement wheel to rotate. As the loose dog moves

off an escapement wheel tooth, the stationary dog moves between the teeth of the escapement wheel, limiting the rotation of the escapement wheel to the distance from one tooth to another.

When a typewriter is not in use, one tooth of the escapement wheel rests against the LOOSE DOG. Note the position of the loose dog in figure 12-5 (rear view). Tension of the carriage main-spring creates a force on the escapement wheel and overcomes the tension of the loose dog spring and forces the loose dog against a stop. When a key is depressed, or the space bar is depressed, the upper portion of the escapement dog body is rocked to the rear, moving the loose dog out of the path of the wheel tooth. At the same time, the rigid dog is moved into the path of the wheel tooth and the tooth stops against the rigid dog. When the loose dog is disengaged from an escapement wheel tooth, the loose dog spring pulls the loose dog to a position halfway between the next tooth and the one from which it was disengaged.

When the escapement mechanism returns to its normal position, the loose dog engages an escapement wheel tooth and is forced back against the loose dog stop by the pull of the main-spring on the carriage. The escapement is then completely restored and ready for the next cycle.

The sequence of mechanical action which takes place during typing is as follows:

1. When a key is struck (depressed) with sufficient force to type, the ribbon rises to cover the type.

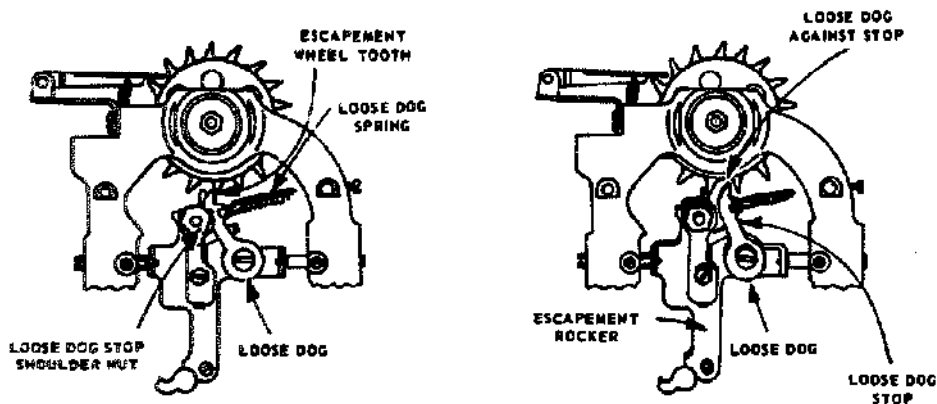


Figure 12-5.—Escapement mechanism.

61.39X

2. The type prints on the paper and the ribbon is advanced 1/2 space by the ribbon feed mechanism.
3. The escapement rocks, allowing the escapement wheel to advance 1/2 space; and the escapement wheel pinion and carriage feed rack allow the carriage to move 1/2 space.
4. The escapement returns to its original position, allowing the carriage to move 1/2 space and the ribbon to advance 1/2 space.

#### TYPE BAR MECHANISM

The type bar mechanism carries the type bar up to the platen when a key is depressed. The manner in which this mechanism works is illustrated in figure 12-6. When a type key is depressed, it pivots and depresses a spring beneath (key lever tension spring). At the same time, it pulls the bell crank forward and causes it to pivot on the fulcrum wire which passes through its base. A wire link between the bell crank and the type bar then pulls the base of the type bar forward, causing it to pivot on the fulcrum wire and move the type bar into the type guide (fig. 12-6). When the type bar goes into the type guide, the bar pushes the universal bar back, causing the bunter rod to trip the escapement dogs and allow the carriage to move one space. The segment stop ring (fig. 12-6), called the WHIP, prevents the type bar from springing, thus ensuring clear printing on the paper. When the key is released, the key lever tension spring (plus the weight of the type bar) forces the key lever up, returning the type bar action mechanism to its REST position.

While the type bar action mechanism is operating, the key lever and the ribbon universal bar also actuate the ribbon lift mechanism.

#### RIBBON DRIVE MECHANISM

The function of the ribbon drive mechanism is to move the ribbon from one spool to another in definite increments each time a key or the space bar is depressed, and to raise the ribbon to the line of type. Refer to figure 12-7 as you study how the ribbon drive mechanism works.

When the typewriter carriage moves one space to the left, the escapement wheel (fig. 12-7) rotates the distance of one tooth. A small gear on the escapement wheel shaft meshes with a small gear on the ribbon feed shaft, causing

a sprocket and chain on the other end of the shaft to rotate. The chain which passes over this sprocket drives another sprocket wheel on the right end of the ribbon drive shaft (fig. 12-7). Two idler pulleys guide the drive chain and maintain proper tension on it.

When the drive chain turns the large sprocket wheel on the ribbon drive shaft, a small gear on the drive shaft meshes with a ribbon spool shaft gear (right or left) and drives the ribbon spool shaft. When the ribbon spool shaft revolves, it turns a ribbon spool on top and winds the ribbon in small increments onto it. If the ribbon drive shaft is shifted to the right, automatically or manually, the right drive shaft gear meshes with the right ribbon spool shaft gear and revolves the ribbon spool shaft. When the ribbon drive shaft is shifted to the left, the gear on its left end drives the left ribbon spool shaft and winds the ribbon to the left.

#### Ribbon Drive Shaft Detent

You can change the direction of a typewriter ribbon by shifting a reverse lever (fig. 12-7) to the right or left. A slot in the lever limits the amount of space the lever may be moved, and a small spring retains it in the position to which it is moved. The rear arm of the reverse lever fits in a notch in the collar on the left end of the ribbon drive shaft, and moves the shaft to the right or left when the ribbon reverse lever is moved.

#### Ribbon Reverse Mechanism

The function of the ribbon reverse mechanism is to reverse the ribbon automatically from a full ribbon spool to the empty ribbon spool. The action of this mechanism ensures utilization of the ink in the full length of the ribbon and the same degree of brightness of color in every line of type. The ribbon reverse mechanism is illustrated in figure 12-7.

Note the ribbon spool, ribbon reverse trigger, ribbon reverse plunger, and the reversing cam on the ribbon drive shaft.

The end of the ribbon is attached to the ribbon spool by a catch. As long as there is one complete turn of ribbon on the ribbon spool, the ribbon reverse trigger is held in the IN position and the trigger holds up the plunger inside the ribbon spool shaft, so that the lower end of the plunger does not come into contact with the

BASIC MACHINES

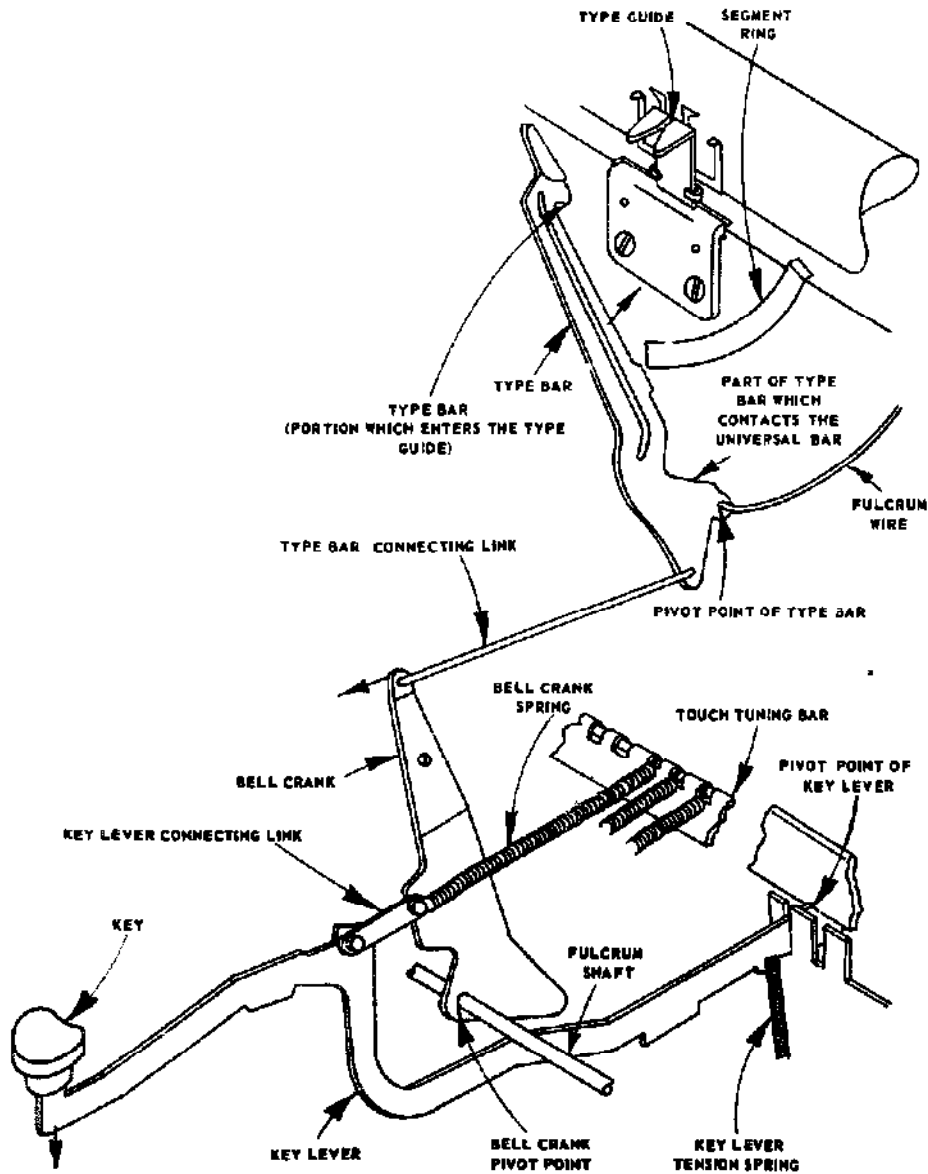


Figure 12-6.—Type bar action mechanism.

61.40K

reversing cam on the ribbon drive shaft as it rotates.

When a ribbon spool starts its last revolution before becoming completely empty, the ribbon reverse trigger which has been holding the ribbon reverse plunger up, moves OUT from the ribbon

spool and releases its hold on the top of the ribbon reverse plunger. As the ribbon reverse plunger drops down, it moves into the path of a reversing cam on the ribbon drive shaft, causing the drive shaft to move laterally, thereby disengaging the drive shaft gear from the ribbon spool



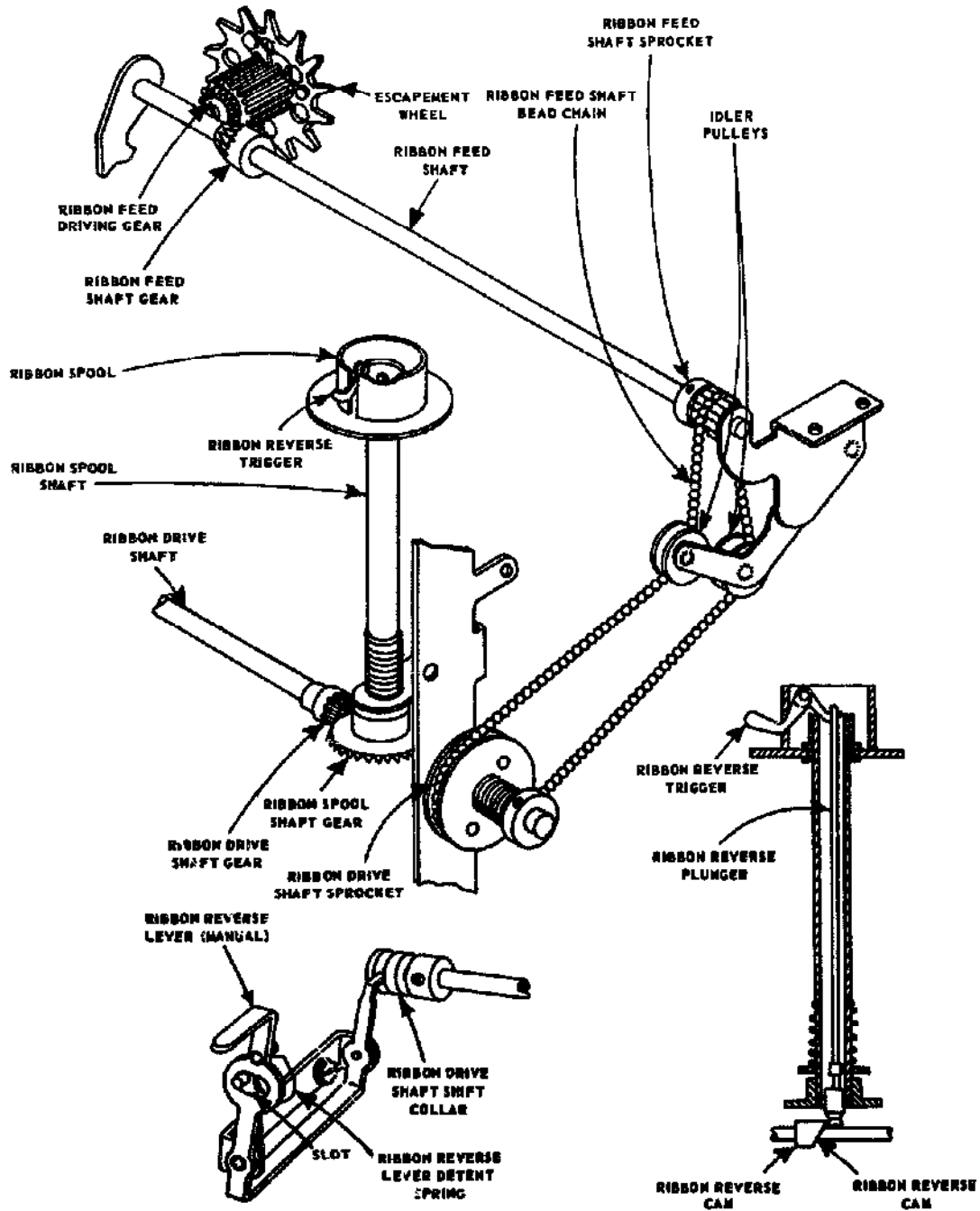


Figure 12-7.—Ribbon feed mechanism.

61.41X

## BASIC MACHINES

shaft gear at one end and engaging the drive shaft gear and opposite spool shaft gear at the other end.

As the ribbon starts to wind onto the empty ribbon spool, it pushes the ribbon reverse trigger in, causing the other end of the trigger to engage the slot in the top of the ribbon reverse plunger and raise it above the reversing cam on the ribbon drive shaft.

### Ribbon Lift Mechanism

The ribbon lift mechanism lifts the ribbon to a position in which it may be struck by the type when its presence is required, and to let it down when not required (to allow reading of a line that is being typed). Study illustration 12-8 as you follow the description of the operation of this mechanism.

When a type key is depressed, the key lever contacts a prong, immediately beneath, which is connected to the ribbon universal bar (U-bar), causing the U-bar to pivot its top forward. As the U-bar top pivots forward it raises the ribbon guide actuating lever link between the U-bar and the ribbon guide actuating lever. The ribbon guide actuating lever is connected to the ribbon guide (carrier) and raises it when the key is depressed, bringing the ribbon up in position to be struck by the type head. A spring provides tension to restore the ribbon guide actuating lever.

Note that the ribbon guide actuating lever has a horizontal slot in the middle, and the horizontal slot has an indentation in its upper surface. Then note the ribbon guide actuating lever link shift lever connected to the left end of the ribbon-shift shaft. On the right end of the ribbon shift shaft is the ribbon shift detent to which the ribbon bichrome shift lever is connected.

When the ribbon bichrome shift lever is in the BLACK position, the ribbon guide actuating lever link shift lever moves to position the ribbon guide actuating lever link at the front end (black position) of the horizontal slot in the ribbon guide actuating lever. Now, when a key is depressed, the ribbon guide actuating lever moves the ribbon guide in position for the type head to strike the upper (black) portion of the ribbon. If the ribbon bichrome shift lever is moved to the WHITE position (stencil), the ribbon guide actuating lever link shift lever moves the ribbon guide actuating lever link to the center of the horizontal slot in the ribbon guide actuating lever. When type keys are depressed, the ribbon

guide actuating lever link moves up and down in the vertical slot of the ribbon guide actuating lever without moving it, enabling the typist to print characters directly on the stencil because there is no ribbon in front of the type heads. If the ribbon bichrome shift lever is moved to the RED position, the ribbon guide actuating lever link shift lever moves the ribbon guide actuating lever link to the rear end of the slot in the ribbon guide actuating lever. If typing is done with the ribbon guide actuating lever link in this position, the ribbon guide actuating lever carries the ribbon guide high enough for the type heads to strike the lower (red) portion of the ribbon.

Having three positions for setting the ribbon lift mechanism permits efficient use of a standard two-color typewriter ribbon and allows the typist to cut a stencil by merely moving the ribbon bichrome shift lever to the WHITE position.

### BACKSPACE MECHANISM

The function of the backspace mechanism is to enable a typist to move the carriage one or more spaces to the right whenever necessary. This mechanism is shown in figure 12-9. When the backspace key lever is depressed, the backspace key lever link causes the bell crank to pivot and transfer the PULL to a horizontal plane. The backspace slide is then moved to the left at the two guide slots shown in the illustration. This action causes a backspacing pawl to engage a tooth on the escapement wheel pinion and turn the pinion clockwise until the pinion pawl on the escapement wheel moves over one tooth on the pinion. Since the carriage rack is engaged with the escapement wheel pinion, the carriage is also moved back one space to the RIGHT.

### TABULATOR MECHANISM

The tabulator mechanism of a typewriter enables the typist to move the carriage a definite, predetermined distance by depressing the tabulator bar (fig. 12-10). Refer to this illustration frequently as you study the manner in which the tabulator mechanism works.

If the tabulator stops are set as shown at left-center in figure 12-10 and the tabulator bar is depressed, the tabulator bar frame raises the key set tabulator (KST) stop blade and an arm on the KST stop blade contacts and raises

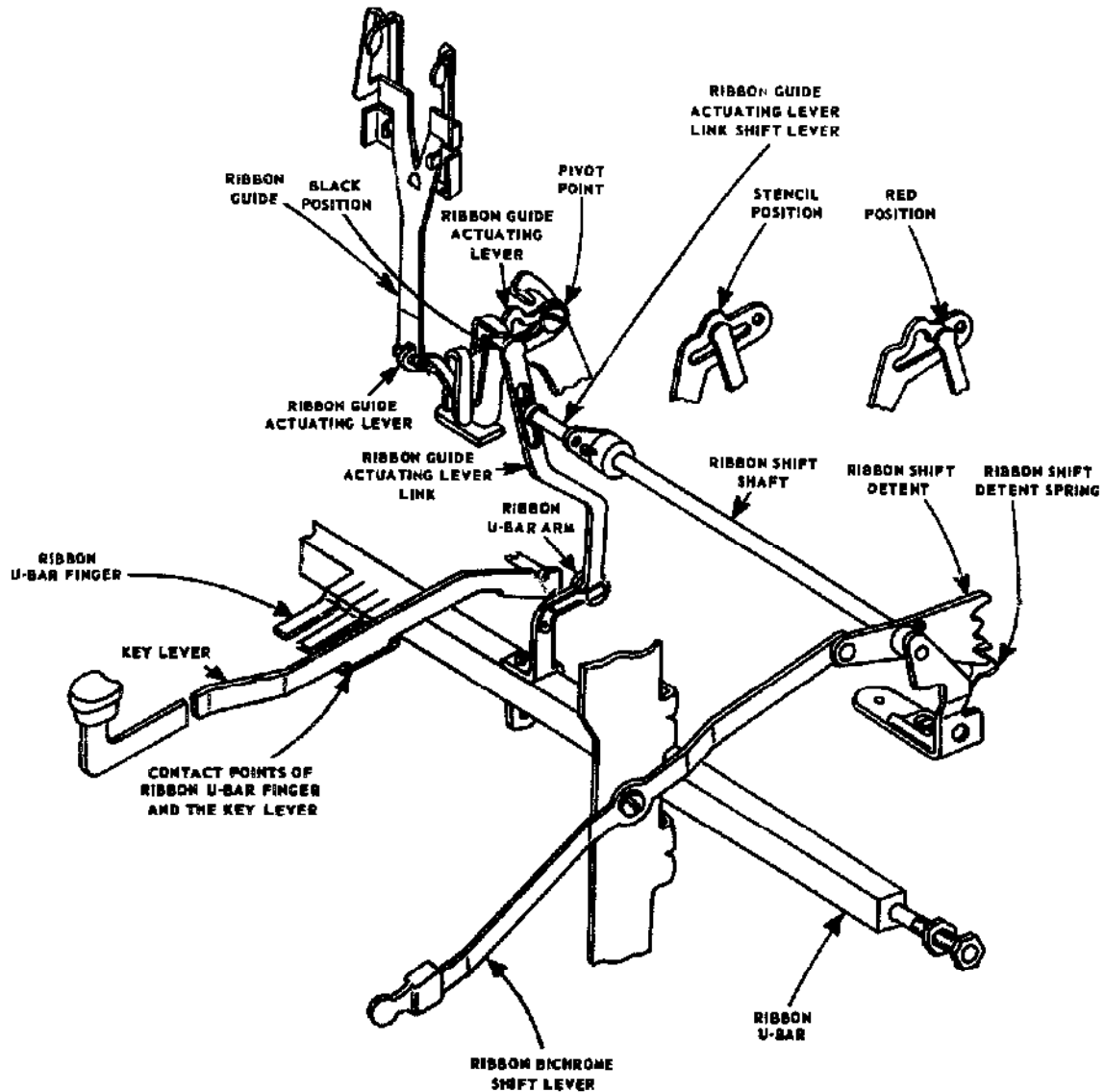


Figure 12-8.—Ribbon lift mechanism.

61.42X

the tabulator lever actuating plate in front of the KST frame, causing the shaft to rotate. A short arm (shaft arm) attached to the end of this shaft moves down and depresses the tabulator lever, which pivots, and a roller on front of the tabulator lever lifts the carriage feed

rack out of mesh with the escapement wheel pinion, allowing the carriage to move to the left.

By the time the carriage feed rack is raised out of mesh with the pinion, the KST stop blade has moved up into the path of a set tabulator stop, as shown in figure 12-10 (left-center).

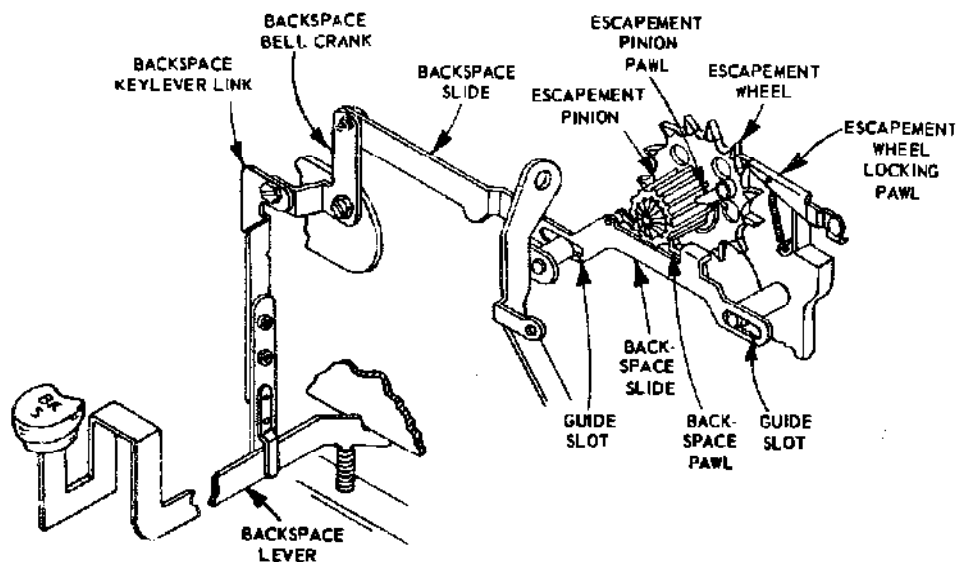


Figure 12-9.—Back spacer mechanism.

61.43X

The stop prevents the carriage from moving beyond this point.

The escapement wheel locking pawl, in conjunction with the escapement dogs, prevents the escapement wheel from moving out of position while the feed rack is disengaged. When the tabulator lever actuating plate in front of the KST frame is raised, a yielding device on the left end of the shaft moves against the spring drum brake arm and presses the brakeshoes against the side of the spring drum with enough force to regulate the speed of the carriage.

#### Tabulator Stop Setting Mechanism

The tabulator stop mechanism stops the carriage at the desired position. When the SET key is depressed with the carriage in any desired position, the key lever raises the stop setting link (lower link), shown in figure 12-11, moving the stop setting link (upper link) down against the stop immediately beneath it, and moves the stop to its lower or SET position. The stop remains in this position until it is cleared.

#### Tabulator Stop Clearing Mechanism

The tabulator stop clearing mechanism enables you to clear a set tabulator stop by

depressing the TAB-CLEAR key. To clear individual stops, tabulate to the stop which is to be cleared and depress the tab-clear key. The key lever then raises the clearing plunger, which contacts the bottom of the stop and raises it to the cleared or UP position.

To clear all stops which are set, move the carriage to the extreme left. Then depress the TAB-CLEAR key and hold it down while you move the carriage to the extreme right. The bottoms of the tabulator stops contact the beveled portion of the clearing plunger, which raises them to the top of the plunger.

#### SHIFT MECHANISM

The function of the shift mechanism (fig. 12-12) is to raise and lower the segment and type bars so that the typist may be able to type the upper and lower case characters on the type heads on a common line. When you depress a SHIFT key, the shift mechanism moves the segment and type bars to the DOWN position. By depressing a shift key LOCK next to the shift key, you can retain the segment and type bars in the down position as long as desired. The shift key lock lever is a simple, spring-loaded catch. When the lock is released, the segment returns to the rest position.

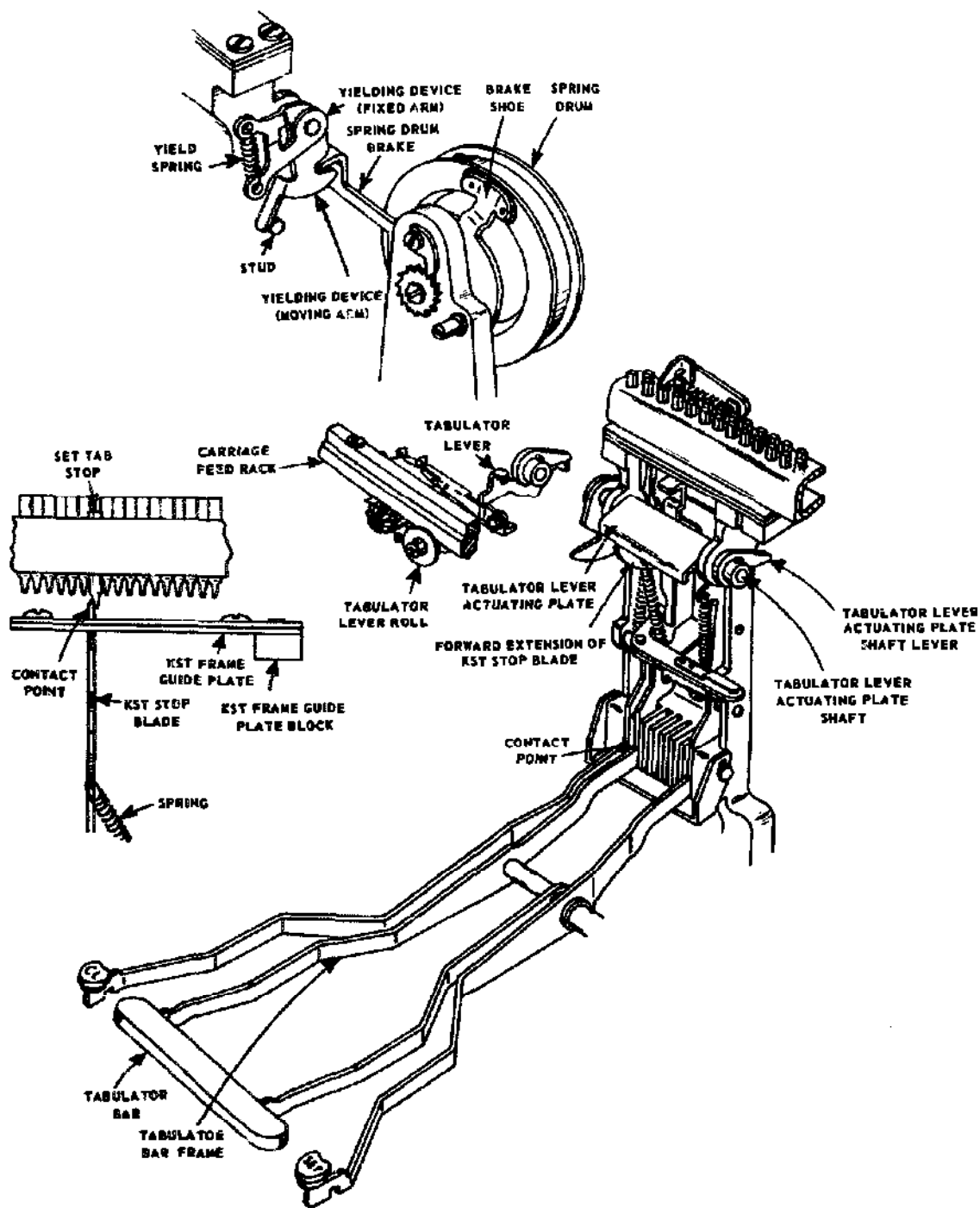


Figure 12-10.—Tabulator mechanism.

61.44X

BASIC MACHINES

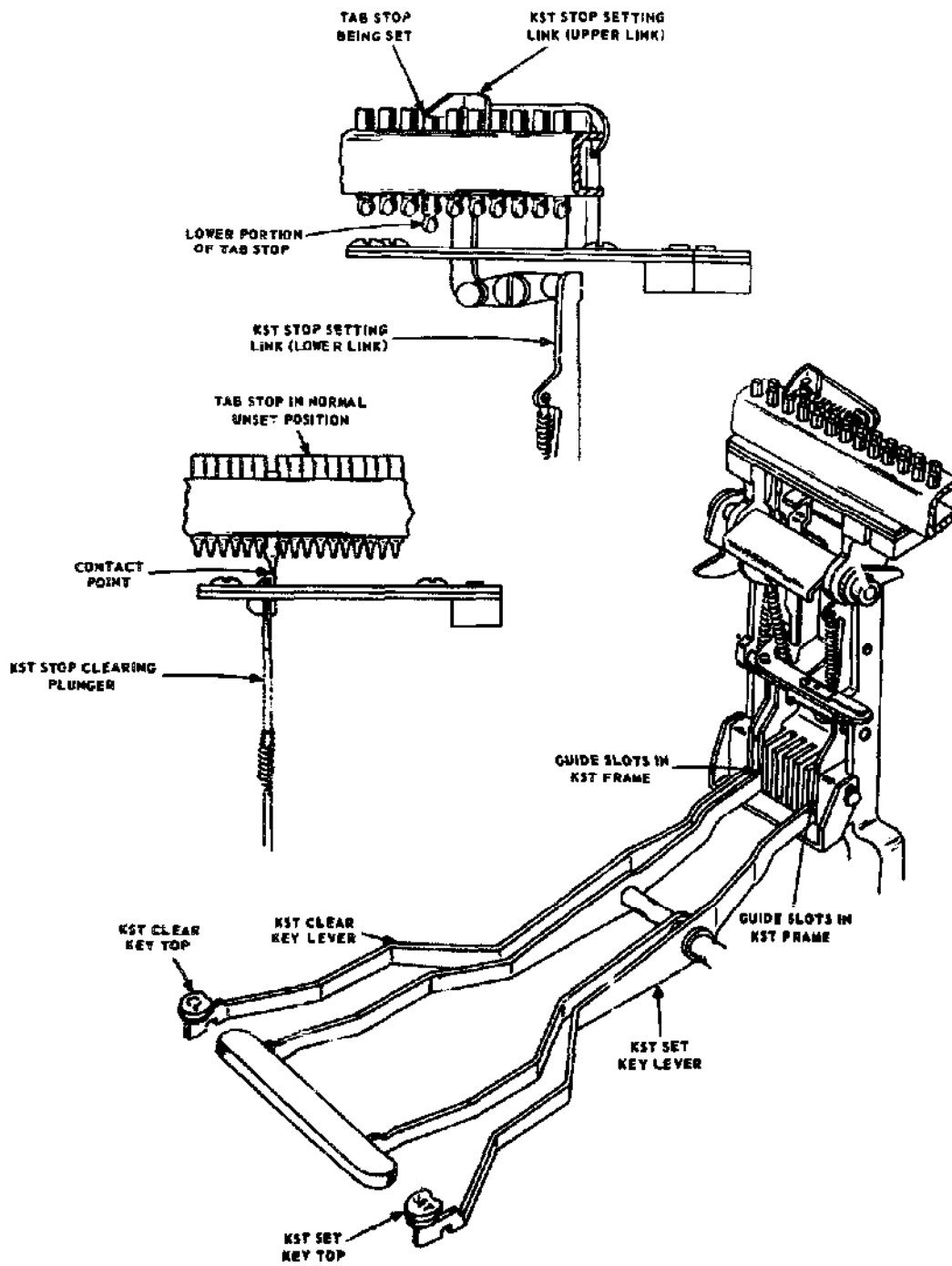
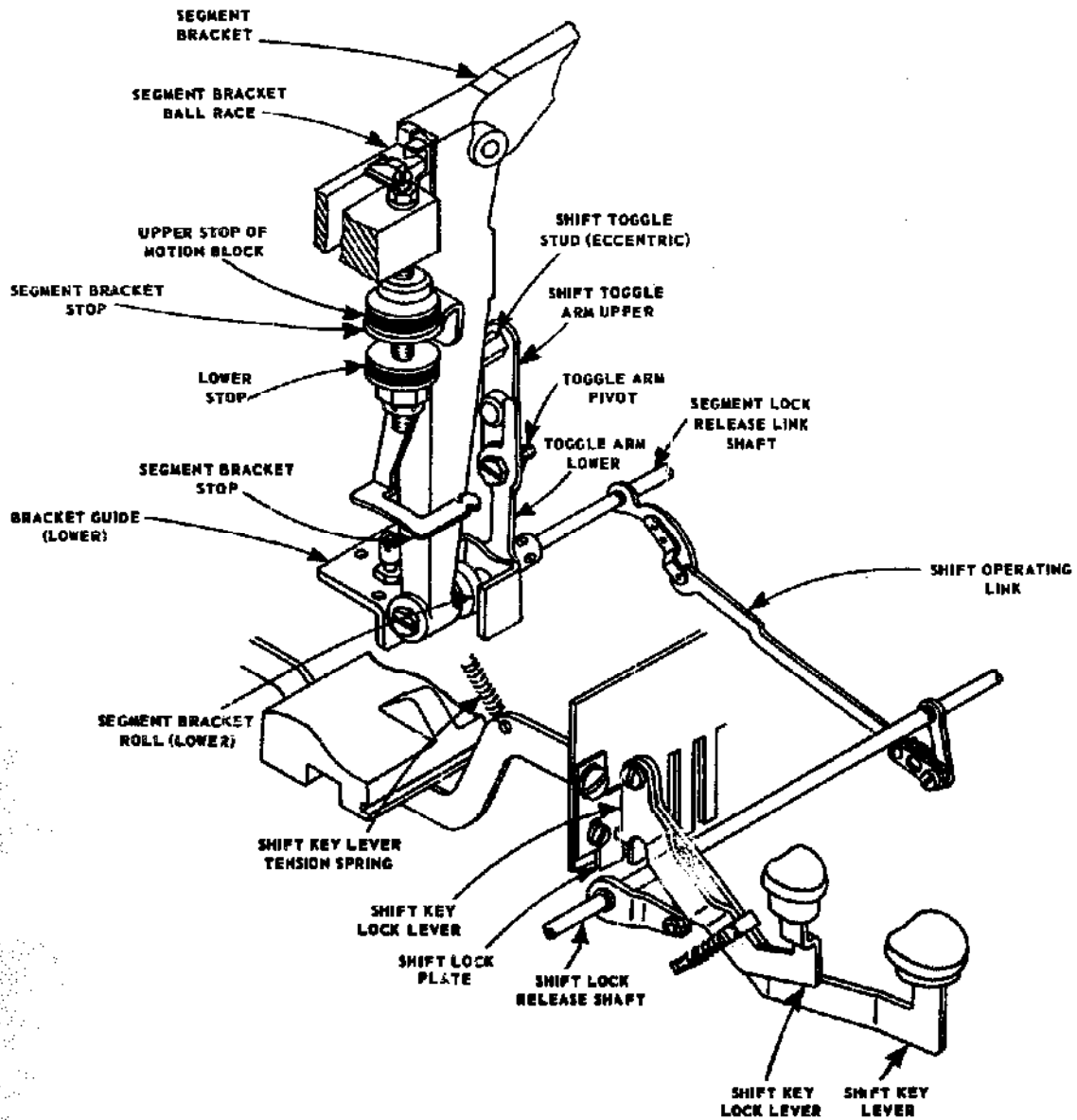


Figure 12-11.—Tabulator stop setting mechanism.

61.45X



61.46X

Figure 12-12.—Shift mechanism.

Depressing the shift key rotates the shift lock release shaft through a connecting link and an arm secured to the shaft. The shift lock release shaft, through the shift operating link, turns the segment lock release link shaft (illustrated). The

lower toggle arm is secured to the segment lock release link shaft and the upper toggle arm at the toggle arm pivot (fig. 12-12). The upper toggle arm is connected to an adjustment eccentric (shift toggle stud). As the lower toggle arm

## BASIC MACHINES

pivots forward, the lock is released and the action of the lower and upper toggle arms pulls the segment bracket (carrying the segment and type bars) down until the upper stop rests against the lower stop.

When a shift key lever, right or left, is released, a spring raises the shift key lever. This reverse action helps to restore the entire mechanism, but the power required to raise the segment bracket is supplied by two springs, one right and one left, which are connected between the segment bracket and the ribbon spool shaft brackets.

When the segment bracket is in the extreme upper position and the key shift lever is up, the lower toggle arm moves slightly over center toward the rear of the machine, locking the segment bracket in the upper position, thus preventing it from bouncing and causing irregular printing on the line.

### BELL RINGER MECHANISM

The bell ringer mechanism rings a bell to indicate that the carriage is approaching the tabular stop set for the right margin. Refer to figure 12-13 as you study this mechanism.

As the typewriter carriage moves to the left, the bell trip pawl on the right margin stop moves the bell hammer lever and the hammer away from the bell. When the bell trip pawl moves past the cam portion of the bell hammer lever, the bell

hammer lever is released, allowing the hammer to strike the bell under spring tension.

### LINE LOCK MECHANISM

The margin stops arrest the movement of the carriage to the right or left. The line lock, actuated by the margin stop, locks the universal bar to prevent type keys from overtyping on the last letter when the carriage is stopped. The line lock lever also locks the escapement in position to prevent operation of the space bar while the line is locked, and to prevent overspacing when the margin release key is depressed.

When the carriage moves to the left, the margin stop contacts the margin release rod arm (center). See figure 12-14. As the margin release rod moves to the left, the margin release rod arm (right) on its right extremity contacts the line lock actuating lever and moves it to the left. The line lock actuating lever then pivots at the pivot point (fig. 12-14) and pulls the line lock lever comb link connected to the link lock lever to the right, causing the line lock lever to position itself behind the bunter plate and around the bunter rod.

If a key is depressed when the line lock mechanism is in this position, the type bar is prevented from making an impression on the paper by the universal bar bunter plate being stopped by the link lock lever adjusting screw. Because the

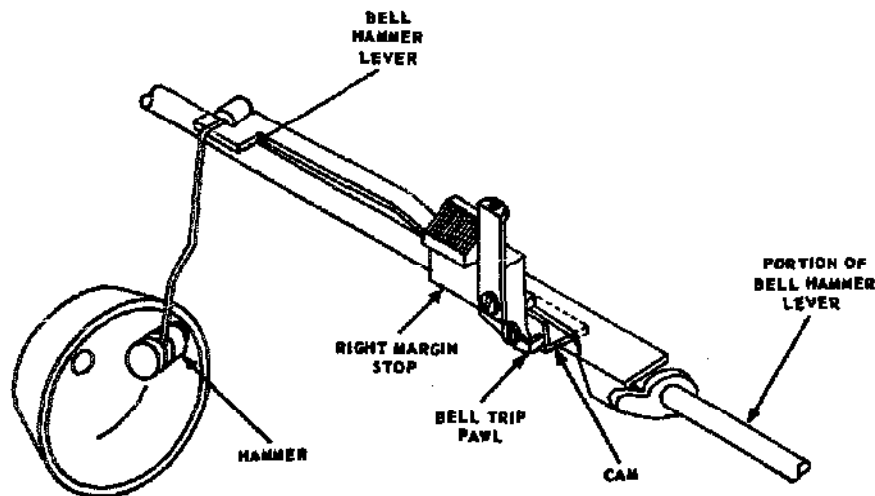


Figure 12-13.—Bell ringer mechanism.

61.47X



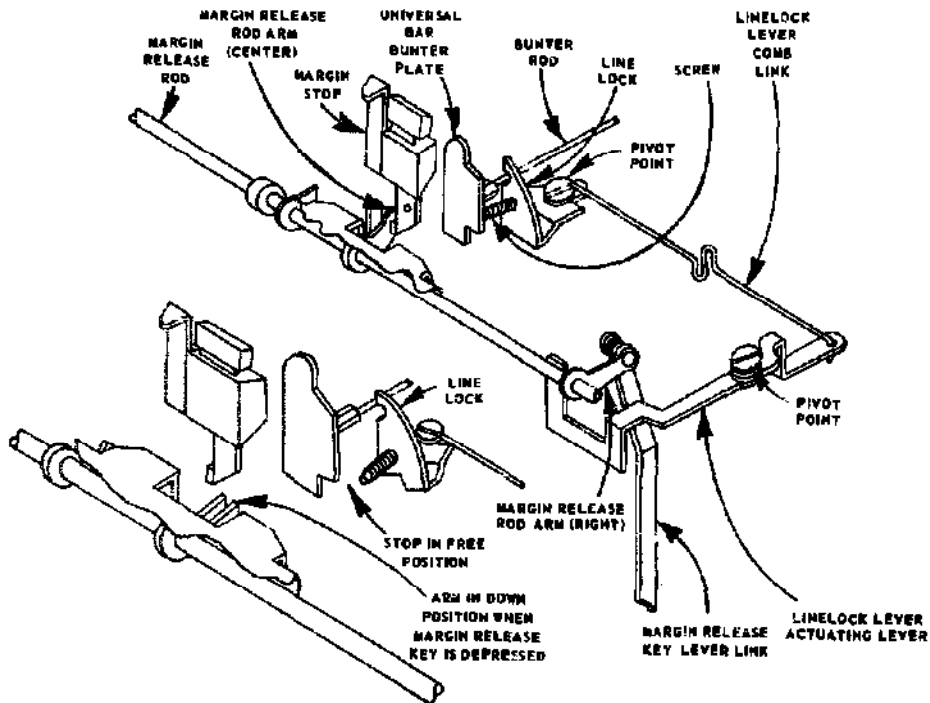


Figure 12-14.—Line lock mechanism.

61.48X

U-bar cannot move the bunter rod rearwards, this action also prevents the escapement from tripping. If the space bar is depressed with the line lock mechanism in this position, the line lock lever prevents actuation of the escapement by its contact with the bunter rod.

With the link lock mechanism in the position just explained, no more typing can be done on this line until the MARGIN-RELEASE key is depressed, causing the margin release rod to rotate and move the margin release rod arm fastened to it down below the margin stop. Study the illustration. The margin release rod then moves to the right and allows the line lock lever actuating lever to move to the right under spring tension, freeing the line lock lever from the bunter rod and the U-bar bunter plate.

#### LINE SPACE MECHANISM

A typewriter line space mechanism ensures the same amount of space between lines of type when the adjuster is set for a definite distance.

The manner in which this mechanism works is illustrated in figure 12-15.

There are three positions to which the line space adjuster of a typewriter may be set. The action of the line space pawl on the platen ratchet for all three positions is shown in figure 12-15. Study it carefully. The ratchet wheel in the illustration has 30 teeth (6 lines per inch).

When the line space lever is moved to the RIGHT, the line space pawl contacts a tooth on the platen ratchet and moves it rearwards the amount of space set (position 1, 2, or 3). After the ratchet is moved back to one of the three positions, a detent roller (fig. 12-15) which is engaged with the platen ratchet holds it in place.

#### PINION STOP SLIDE MECHANISM

The purpose of the pinion stop slide mechanism is to prevent overbanking at the left margin when the carriage is returned with excessive force or speed, and also to prevent underbanking when it is returned with little force. The pinion

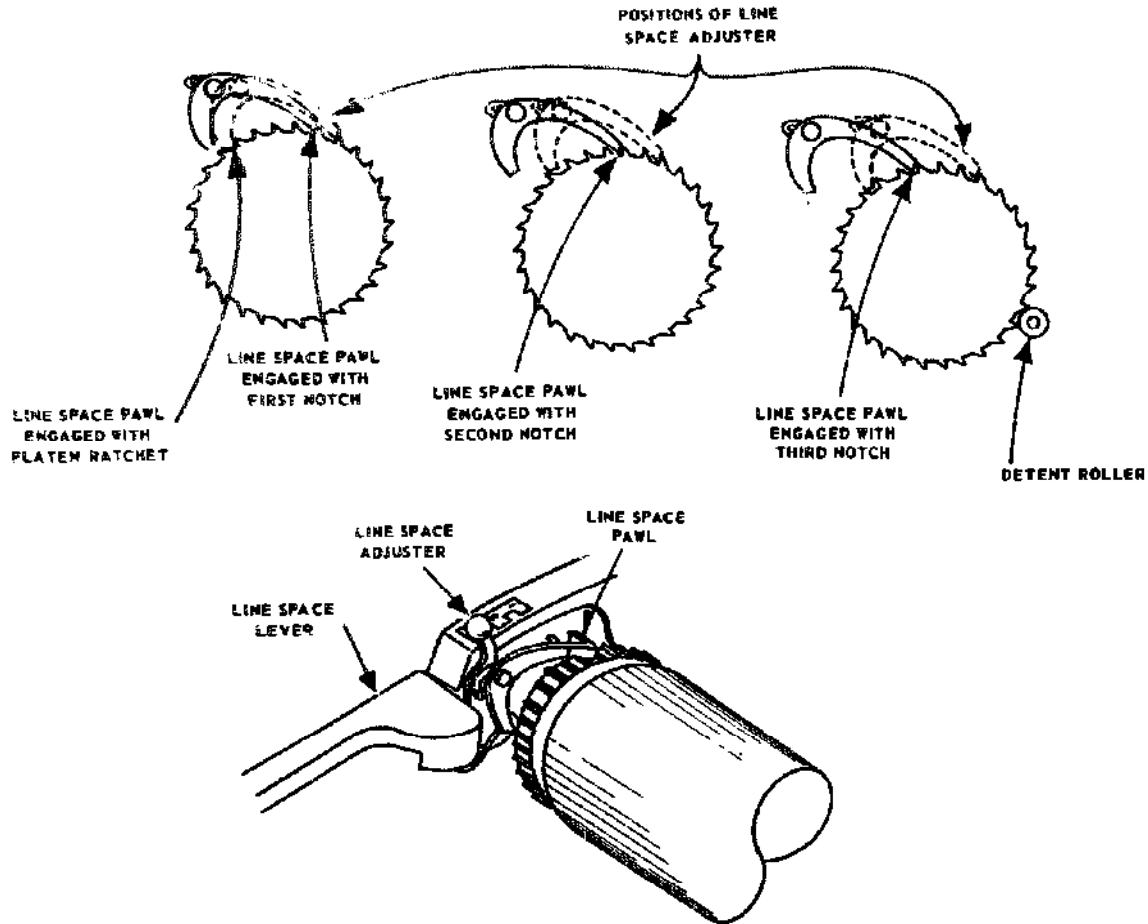


Figure 12-15.—Line space mechanism.

61.49X

stop slide (fig. 12-16) maintains the pinion in a fixed position as the carriage is banked. Any yielding of the carriage as a result of excessive force or speed when it banks is compensated for by the spring-loaded carriage feed rack.

As the carriage moves through the last space just before banking, the left margin stop contacts the pinion stop slide actuating slide and moves it to the right until it contacts and stops against the margin release rod arm. By means of the pinion stop slide intermediate lever, the pinion stop slide is moved to the left and the edge of the lip moves into the teeth of the escapement wheel pinion and prevents the pinion from turning. If

the carriage yields enough to equal one space, the yielding device and yield spring on the carriage feed rack (fig. 12-10) yields and allows the rack to remain at a correctly fixed relation with the pinion while the carriage continues until its momentum is expended.

#### SUMMARY

The operation of complex machines will be much easier for you to understand if you will keep in mind the following points:

A complex machine is nothing more than a combination of two or more simple machines.

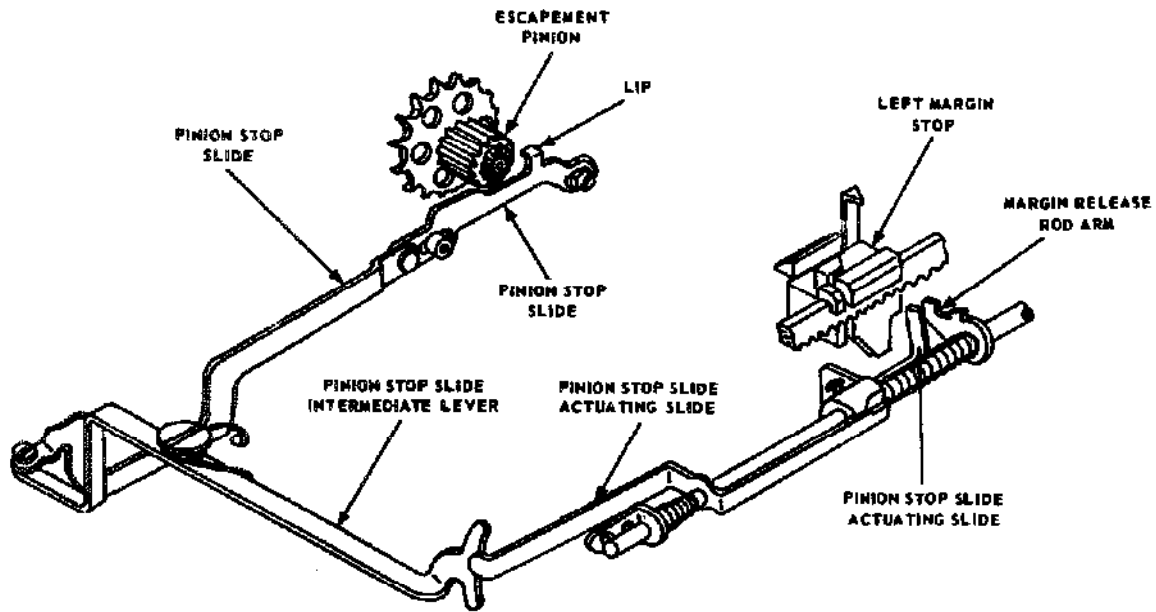


Figure 12-16.—Pinion stop slide mechanism.

61.50X

You can figure out how a complex machine works if you understand the operation of the simple machines from which it is made. Look first for the point where energy is applied, and follow the action through step-by-step—carefully determining the DIRECTION and MAGNITUDE of movement at each step.

The mechanical advantage of a complex machine is equal to the PRODUCT of the mechanical advantage of each simple machine from which it is made.

When a machine gives a mechanical advantage of MORE THAN ONE, it multiplies the FORCE of the applied energy. When it gives a mechanical advantage of LESS THAN ONE, it multiplies both the DISTANCE and the SPEED of the applied movement.

More examples of complex machines will be given in the following chapters of this book. None of them should be too difficult for you to understand if you analyze each of them carefully by the methods described in the foregoing.

## CHAPTER 13

# INTERNAL COMBUSTION ENGINE

The automobile is a familiar object to all of us; and the engine that makes it go is one of the most fascinating and talked about of all the complex machines we use today. In this chapter we will explain briefly some of the operational principles of this machine, and then break it down to its more basic mechanisms. In its makeup you will find many of the devices and basic mechanisms that you have studied earlier in this book. Look for these and the simple machines that make up the engine as you study its operation and construction.

### COMBUSTION ENGINE

An engine is defined simply as a machine that converts heat energy to mechanical energy. To fulfill this purpose, the engine may take one of several forms.

Combustion is the act of burning. Internal means inside or enclosed. Thus an internal combustion engine is one in which the fuel burns inside; that is, burning takes place within the same cylinder that produces energy to turn the crankshaft. In external combustion engines, such as steam engines, the combustion takes place outside the engine. Figure 13-1 shows, in simplified form, an external and an internal combustion engine.

The external combustion engine requires a boiler to which heat is applied. This combustion causes water to boil to produce steam. The steam passes into the engine cylinder under pressure and forces the piston to move downward. With the internal combustion engine, the combustion takes place inside the cylinder and is directly responsible for forcing the piston to move downward.

The transformation of heat energy to mechanical energy by the engine is based on a fundamental law of physics which states that gas will expand upon application of heat. The law

also states that when a gas is compressed the temperature of the gas will increase. If the gas is confined with no outlet for expansion, then the pressure of the gas will be increased when heat is applied (as it is in an automotive cylinder). In an engine, this pressure acts against the head of a piston, causing it to move downward.

As you know, the piston moves up and down in the cylinder. The up-and-down motion is known as reciprocating motion. This reciprocating motion (straight line motion) must be changed to rotary motion (turning motion) in order to turn the wheels of a vehicle. A crank and a connecting rod change this reciprocating motion to rotary motion.

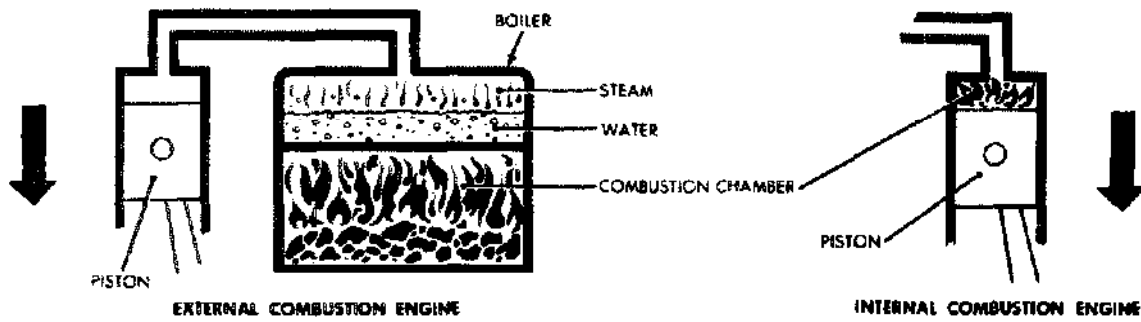
All internal combustion engines, whether gasoline or diesel, are basically the same. We can best demonstrate this by saying they all rely on three things—air, fuel, and ignition.

Fuel contains potential energy for operating the engine; air contains the oxygen necessary for combustion; and ignition starts combustion. All are fundamental, and the engine will not operate without any one of them. Any discussion of engines must be based on these three factors and the steps and mechanisms involved in delivering them to the combustion chamber at the proper time.

### DEVELOPMENT OF POWER

The power of an internal combustion engine comes from the burning of a mixture of fuel and air in a small, enclosed space. When this mixture burns it expands greatly, and the push or pressure created is used to move the piston, thereby cranking the engine. This movement is eventually sent back to the wheels to drive the vehicle.

Since similar action occurs in all cylinders of an engine, let's use one cylinder in our development of power. The one-cylinder engine



81.41

Figure 13-1.—Simple external and internal combustion engine.

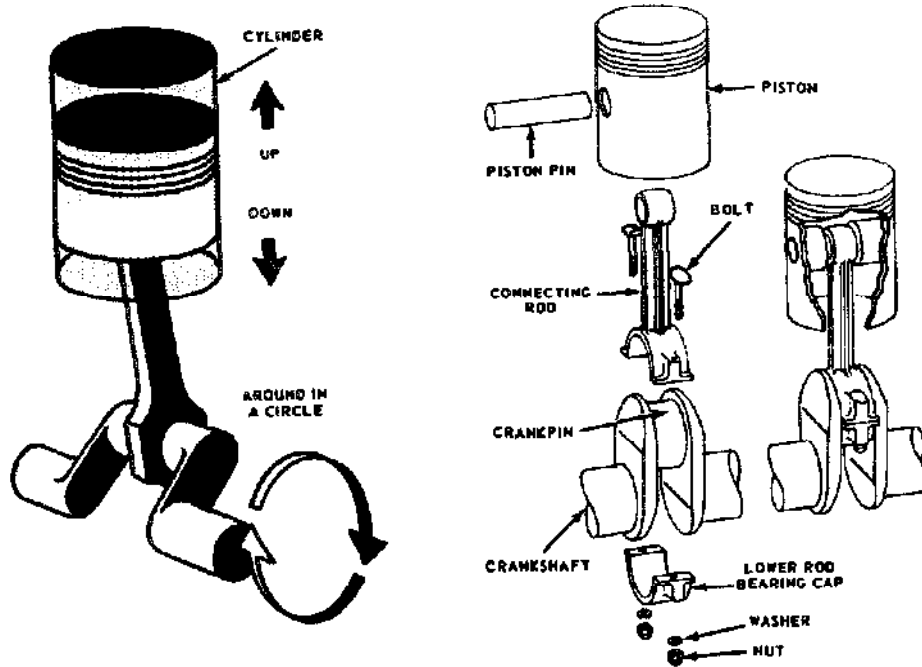
consists of four basic parts as shown in figure 13-2.

First we must have a cylinder which is closed at one end; this cylinder is similar to a tall metal can.

Inside the cylinder is the piston, a movable metal plug, which fits snugly into the cylinder,

but can still slide up and down easily. This up-and-down movement, produced by the burning of fuel in the cylinder, results in the production of power from the engine.

You have already learned that the up-and-down movement is called reciprocating motion. This motion must be changed to rotary motion



85.95

Figure 13-2.—Cylinder, piston, connecting rod, and crankshaft for a one-cylinder engine.

so the wheels or tracks of vehicles can be made to rotate. This change is accomplished by a crank on the crankshaft and a connecting rod which connects between the piston and the crank.

The crankshaft is a shaft with an offset portion, the crank, which describes a circle as the shaft rotates. The top end of the connecting rod is connected to the piston and must therefore go up and down. The lower end of the connecting rod is attached to the crankshaft. The lower end of the connecting rod also moves up and down but, because it is attached to the crankshaft, it must also move in a circle with the crank.

When the piston of the engine slides downward because of the pressure of the expanding gases in the cylinder, the upper end of the connecting rod moves downward with the piston, in a straight line. The lower end of the connecting rod moves down and in a circular motion at the same time. This moves the crank and in turn the crank rotates the shaft; this rotation is the desired result. So remember, the crankshaft and connecting rod combination is a mechanism for the purpose of changing straightline, up-and-down motion to circular, or rotary motion.

### BASIC ENGINE STROKES

Each movement of the piston from top to bottom or from bottom to top is called a stroke. The piston takes two strokes (an upstroke and a downstroke) as the crankshaft makes one complete revolution. When the piston is at the top of a stroke, it is said to be at top dead center (TDC). When the piston is at the bottom of a stroke, it is said to be at bottom dead center (BDC). These positions are called rock positions and will be discussed further in this chapter under "Timing." See figure 13-3 and figure 13-7.

The basic engine you have studied so far has had no provisions for getting the fuel-air mixture into the cylinder or burned gases out of the cylinder. There are two openings in the enclosed end of a cylinder. One of the openings, or ports, permits the mixture of air and fuel to enter and the other port permits the burned gases to escape from the cylinder. The two ports have valves assembled in them. These valves, actuated by the camshaft, close off either one or the other of the ports, or both of them, during various stages of engine operation. One of the valves, called the intake valve, opens to admit a mixture of fuel and air into the cylinder.

The other valve, called the exhaust valve, opens to allow the escape of burned gases after the fuel-and-air mixture has burned. Later on you will learn more about how these valves and their mechanisms operate.

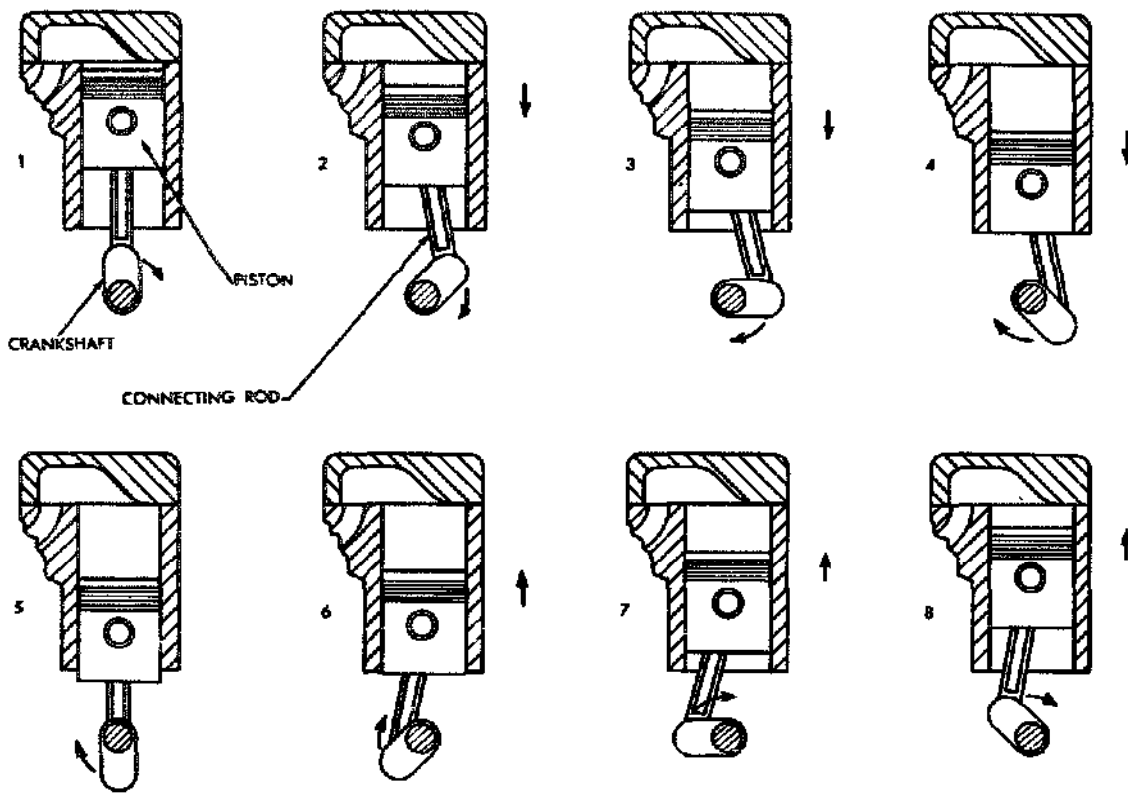
The following paragraphs give a simplified explanation of the action that takes place within the engine cylinder. This action may be divided into four parts: the intake stroke, the compression stroke, the power stroke, and the exhaust stroke. Since these strokes are easy to identify in the operation of a four-cycle engine, that engine is used in the description. This type of engine is also called a four-stroke-Otto-cycle engine, because it was Dr. N.A. Otto who, in 1876, first applied the principle of this engine.

### INTAKE STROKE

The first stroke in the sequence is called the intake stroke (fig. 13-4). During this stroke, the piston is moving downward and the intake valve is open. This downward movement of the piston produces a partial vacuum in the cylinder, and air and fuel rush into the cylinder past the open intake valve. This is somewhat the same effect as when you drink through a straw. A partial vacuum is produced in the mouth and the liquid moves up through the straw to fill the vacuum.

### COMPRESSION STROKE

When the piston reaches bottom dead center at the end of the intake stroke and is therefore at the bottom of the cylinder, the intake valve closes. This seals the upper end of the cylinder. As the crankshaft continues to rotate, it pushes up, through the connecting rod, on the piston. The piston is therefore pushed upward and compresses the combustible mixture in the cylinder; this is called the compression stroke (fig. 13-4). In gasoline engines, the mixture is compressed to about one-eighth of its original volume. (In a diesel engine the mixture may be compressed to as little as one-sixteenth of its original volume.) This compression of the air-fuel mixture increases the pressure within the cylinder. Compressing the mixture in this way makes it still more combustible; not only does the pressure in the cylinder go up, but the temperature of the mixture also increases.



81.42  
 Figure 13-3.—Relationship of piston, connecting rod, and crank on crankshaft as crankshaft turns one revolution.

**POWER STROKE**

As the piston reaches top dead center at the end of the compression stroke and therefore has moved to the top of the cylinder, the compressed fuel-air mixture is ignited. The ignition system causes an electric spark to occur suddenly in the cylinder, and the spark sets fire to the fuel-air mixture. In burning, the mixture gets very hot and tries to expand in all directions. The pressure rises to about 600 or 700 pounds per square inch. Since the piston is the only thing that can move, the force produced by the expanding gases forces the piston down. This force, or thrust, is carried through the connecting rod to the crankpin on the crankshaft. The crankshaft is given a powerful twist. This is called the power stroke (fig. 13-4). This turning effort, rapidly repeated in the engine and carried through gears and shafts, will turn

the wheels of a vehicle and cause it to move along the highway.

**EXHAUST STROKE**

After the fuel-air mixture has burned, it must be cleared from the cylinder. This is done by opening the exhaust valve just as the power stroke is finished and the piston starts back up on the exhaust stroke (fig. 13-4). The piston forces the burned gases out of the cylinder past the open exhaust valve. The four strokes (intake, compression, power, and exhaust) are continuously repeated as the engine runs.

**ENGINE CYCLES**

Now, with the basic knowledge you have of the parts and the four strokes of the engine, let

BASIC MACHINES

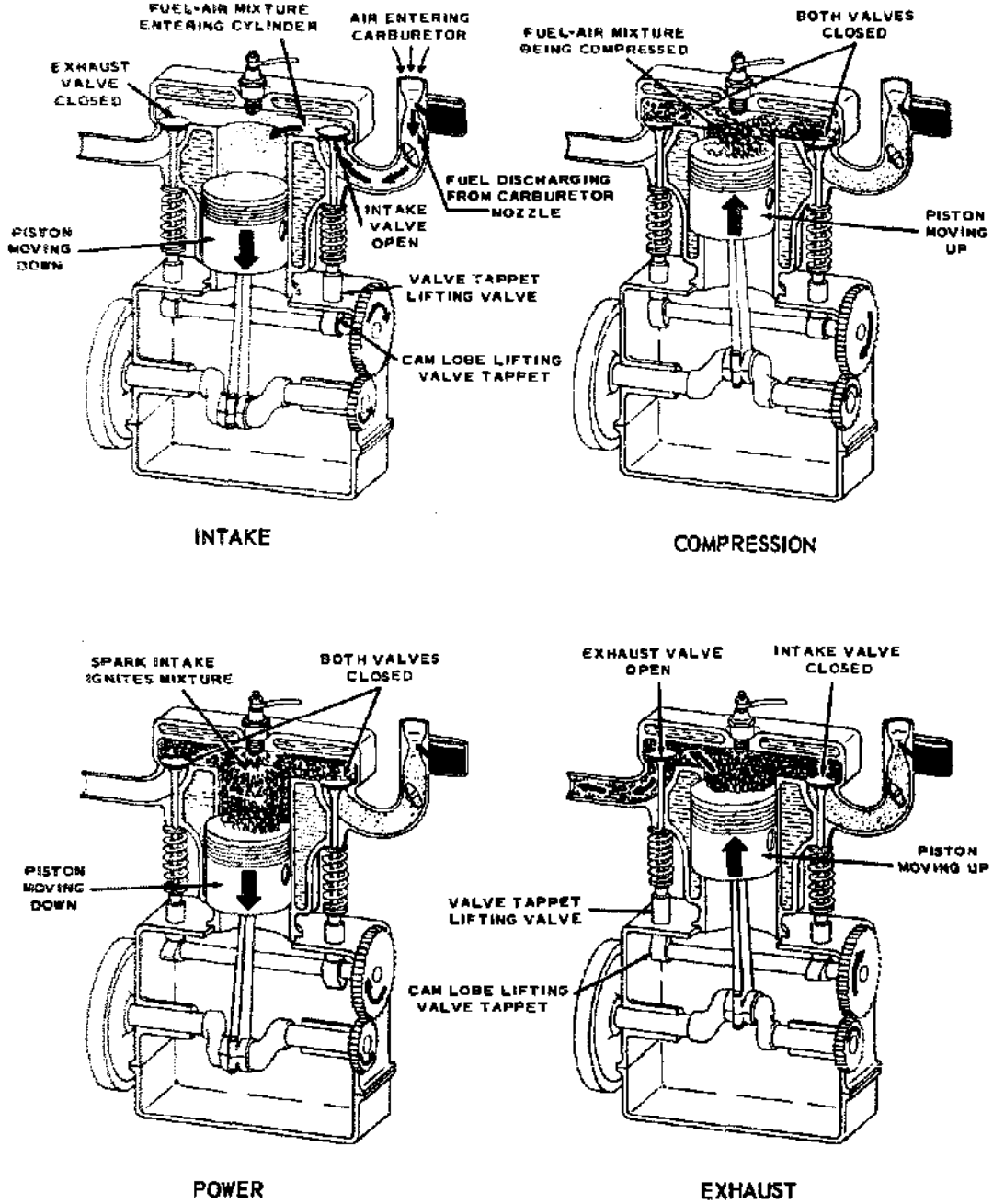


Figure 13-4.—Four-stroke cycle in a gasoline engine.

54.19



us see what happens during the actual running of the engine. To produce sustained power, an engine must accomplish a definite series of operations over and over again. All you have to do is follow one series of events—intake, compression, power, and exhaust—until they repeat themselves. This one series of events is called a cycle.

Most engines of today are called four-cycle engines. What is meant is four-stroke-cycle, but our habit of abbreviating has eliminated the middle word. Just the same, when you see four-cycle it means there are four strokes of the piston, two up and two down, to each cycle. Then it starts over again on another cycle of the same four strokes.

### TWO-CYCLE ENGINE

In the two-cycle engine, the entire cycle of events (intake, compression, power, and exhaust) takes place in two piston strokes.

A two-cycle engine is shown in figure 13-5. Every other stroke in this engine is a power stroke. Each time the piston moves down it is on the power stroke. Intake, compression, power, and exhaust still take place, but they are completed in just two strokes. In figure 13-5 the intake and exhaust ports are cut into the cylinder wall instead of being placed at the top of the combustion chamber as in the four-cycle engine. As the piston moves down on its power stroke, it first uncovers the exhaust port to let

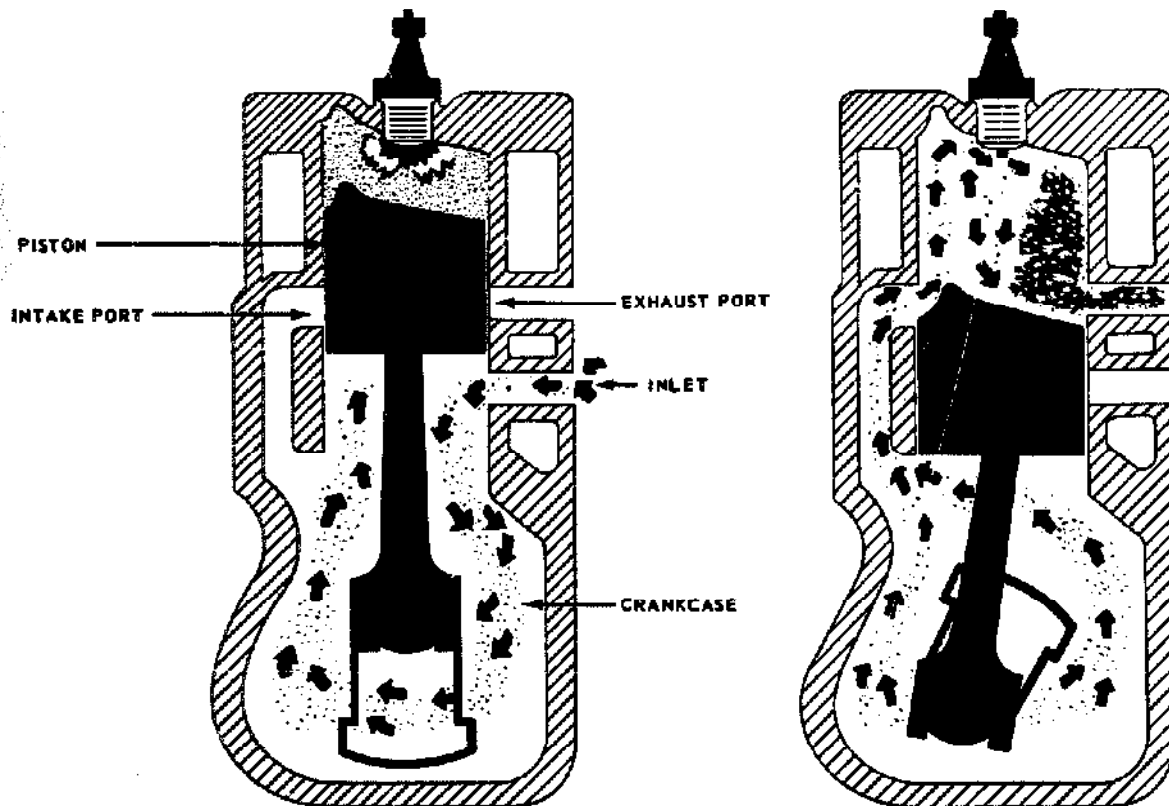


Figure 13-5.—Events in a two-cycle, internal combustion engine.

54.20

burned gases escape and then uncovers the intake port to allow a new fuel-air mixture to enter the combustion chamber. Then, on the upward stroke, the piston covers both ports and, at the same time, compresses the new mixture in preparation for ignition and another power stroke.

In the engine shown in figure 13-5 the piston is shaped so that the incoming fuel-air mixture is directed upward, thereby sweeping out ahead of it the burned exhaust gases. Also, there is an inlet into the crankcase through which the fuel-air mixture passes before it enters the cylinder. This inlet is opened as the piston moves upward, but it is sealed off as the piston moves downward on the power stroke. The downward moving piston slightly compresses the mixture in the crankcase, thus giving the mixture enough pressure to pass rapidly through the intake port as the piston clears this port. This improves the sweeping-out, or scavenging, effect of the mixture as it enters and clears the burned gases from the cylinder through the exhaust port.

#### FOUR-CYCLE vs TWO-CYCLE ENGINES

You have probably noted that the two-cycle engine produces a power stroke every crankshaft revolution; the four-cycle engine requires two crankshaft revolutions for each power stroke. It might appear then that the two-cycle could produce twice as much power as the four-cycle of the same size, operating at the same speed. However, this is not true. With the two-cycle engine some of the power is used to drive the blower that forces the air-fuel charge into the cylinder under pressure. Also, the burned gases are not completely cleared from the cylinder. Additionally, because of the much shorter period the intake port is open (as compared to the period the intake valve in a four-stroke-cycle is open), a relatively smaller amount of fuel-air mixture is admitted. Hence, with less fuel-air mixture, less power per power stroke is produced as compared to the power produced in a four-stroke cycle engine of like size operating at the same speed and with other conditions being the same. To increase the amount of fuel-air mixture, auxiliary devices are used with the two-stroke engine to ensure delivery of greater amounts of fuel-air mixture into the cylinder.

#### MULTIPLE-CYLINDER ENGINES

The discussion so far in this chapter has concerned a single-cylinder engine. A single cylinder provides only one power impulse every two crankshaft revolutions in a four-cycle engine and is delivering power only one-fourth of the time. To provide for a more continuous flow of power, modern engines use four, six, eight, or more cylinders. The same series of cycles take place in each cylinder.

In a four-stroke cycle six-cylinder engine, for example, the cranks on the crankshaft are set 120 degrees apart, the cranks for cylinders 1 and 6, 2 and 5, and 3 and 4 being in line with each other (fig. 13-6). The cylinders fire or deliver the power strokes in the following order: 1-5-3-6-2-4. Thus the power strokes follow each other so closely that there is a fairly continuous and even delivery of power to the crankshaft.

#### TIMING

In a gasoline engine, the valves must open and close at the proper times with regard to piston position and stroke. In addition, the ignition system must produce the sparks at the proper time so that the power strokes can start. Both valve and ignition system action must be properly timed if good engine performance is to be obtained.

Valve timing refers to the exact times in the engine cycle at which the valves trap the mixture and then allow the burned gases to escape. The valves must open and close so that they are constantly in step with the piston movement of the cylinder which they control. The position of the valves is determined by the camshaft; the position of the piston is determined by the crankshaft. Correct valve timing is obtained by providing the proper relationship between the camshaft and the crankshaft.

When the piston is at TDC the crankshaft can move 15° to 20° without causing the piston to move up and down any noticeable distance. This is one of the two rock positions (fig. 13-7). When the piston moves up on the exhaust stroke, considerable momentum is given to the exhaust gases as they pass out through the exhaust valve port, but if the exhaust valve closes at TDC, a small amount of the gases will be trapped and will dilute the incoming fuel-air mixture when the intake valves open. Since the piston has

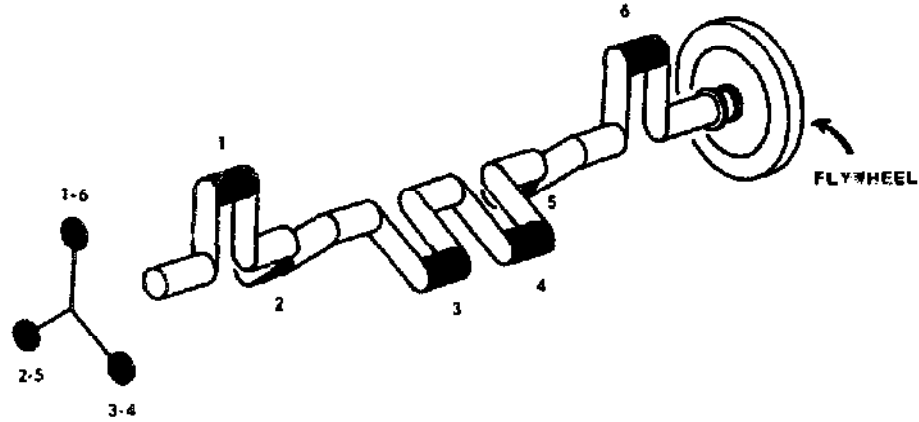


Figure 13-6.—Crankshaft for a six-cylinder engine.

81.42

little downward movement while in the rock position, the exhaust valve can remain open during this period and thereby permit a more complete scavenging of the exhaust gases.

Ignition timing refers to the timing of the spark at the spark plug gap with relation to the piston position during the compression and power strokes. The ignition system is timed so that the spark occurs before the piston reaches TDC on the compression stroke. This gives the mixture enough time to ignite and start burning. If this time were not provided, that is, if the spark occurred at or after TDC, then the pressure increase would not keep pace with the piston movement.

At higher speeds, there is still less time for the fuel-air mixture to ignite and burn. In order to compensate for this, and thereby avoid power loss, the ignition system includes an advance mechanism that functions on speed.

#### CLASSIFICATION OF ENGINES

Engines for automotive and construction equipment may be classified in a number of ways: type of fuel used; type of cooling employed; or valve and cylinder arrangement. They all operate on the internal combustion principle, and the application of basic principles of construction to particular needs or systems

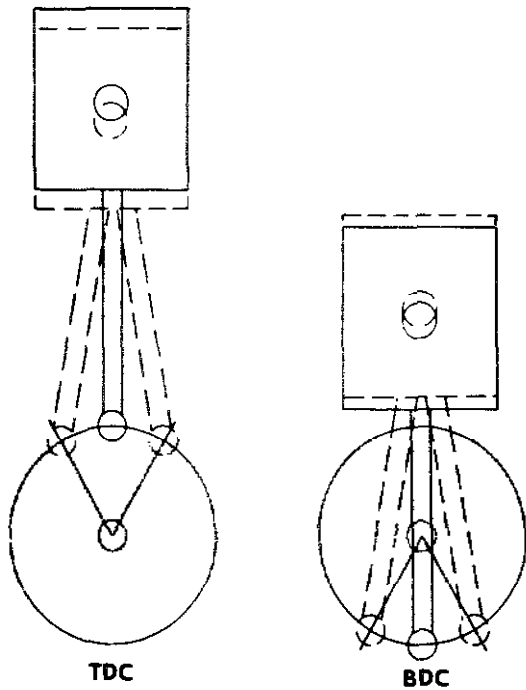


Figure 13-7.—Rock position.

81.45

## BASIC MACHINES

of manufacture has caused certain designs to be recognized as conventional.

The most common method of classification is by the type of fuel used; that is, whether the engine burns gasoline or diesel fuel.

### GASOLINE ENGINES VS DIESEL ENGINES

Mechanically and in overall appearance, gasoline and diesel engines resemble one another. However, in the diesel engine, many parts are somewhat heavier and stronger, so that they can withstand the higher temperatures and pressures the engine generates. The engines differ also in the fuel used, in the method of introducing it into the cylinders, and in how the air-fuel mixture is ignited. In the gasoline engine, air and fuel first are mixed together in the carburetor. After this mixture is compressed in the cylinders, it is ignited by an electrical spark from the spark plugs. The source of the energy producing the electrical spark may be a storage battery or a high-tension magneto.

The diesel engine has no carburetor. Air alone enters its cylinders, where it is compressed and reaches high temperature due to compression. The heat of compression ignites the fuel injected into the cylinder and causes the fuel-air mixture to burn. The diesel engine needs no spark plugs; the very contact of the diesel fuel with the hot air in the cylinders causes ignition. In the gasoline engine the heat from compression is not enough to ignite the air-fuel mixture, therefore spark plugs are necessary.

### ARRANGEMENT OF CYLINDERS

Engines are classified also according to the arrangement of the cylinders: inline, with all cylinders cast in a straight line above the crankshaft, as in most trucks; and V-type with two banks of cylinders mounted in a "V" shape above the crankshaft, as in many passenger vehicles. Another not-so-common arrangement is the horizontally opposed engine whose cylinders are mounted in two side rows, each opposite a central crankshaft. Buses often are equipped with this type of engine.

The cylinders are numbered. The cylinder nearest the front of an in-line engine is No. 1. The others are numbered 2, 3, 4, etc., from

front to rear. In V-type engines the numbering sequence varies with the manufacturer.

The firing order (which is different from the numbering order) of the cylinders is usually stamped on the cylinder block or on the manufacturer's nameplate.

### VALVE ARRANGEMENT

The majority of internal combustion engines also are classified according to the position and arrangement of the intake and exhaust valves—that is, whether the valves are in the cylinder block or in the cylinder head. Various arrangements have been used, but the most common are L-head, I-head, and F-head (fig. 13-8). The letter designation is used because the shape of the combustion chamber resembles the form of the letter identifying it.

#### L-Head

In the L-head engines both valves are placed in the block on the same side of the cylinder. The valve-operating mechanism is located directly below the valves, and one camshaft actuates both the intake and exhaust valves.

#### I-Head

Engines using the I-head construction are commonly called valve-in-head or over-head valve engines, because the valves are mounted in a cylinder head above the cylinder. This arrangement requires a tappet, a push rod, and a rocker arm above the cylinder to reverse the direction of valve movement, but only one camshaft is required for both valves. Some over-head valve engines make use of an overhead camshaft. This arrangement eliminates the long linkage between the camshaft and valve.

#### F-Head

In the F-head engine, the intake valves normally are located in the head, while the exhaust valves are located in the engine block. This arrangement combines, in effect, the L-head and the I-head valve arrangements. The valves in the head are actuated from the camshaft through tappets, push rods, and rocker arms (I-head arrangement), while the valves in the block are actuated directly from the camshaft by tappets (L-head arrangement).

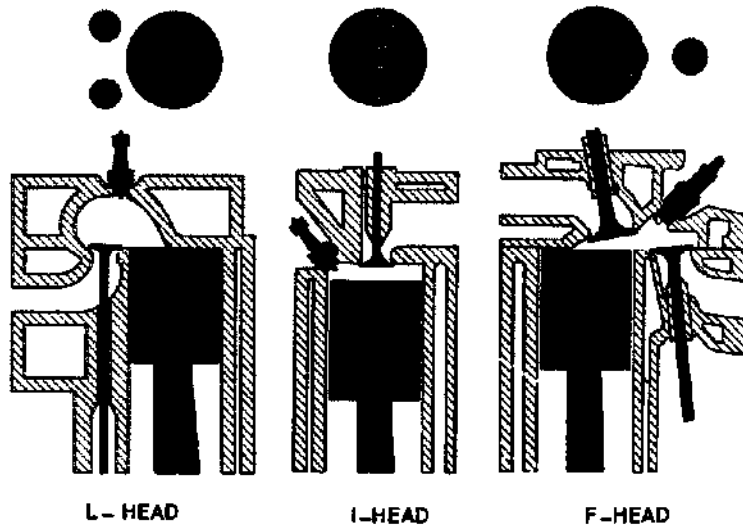


Figure 13-8.—L-, I-, and F-valve arrangement.

81.46

**ENGINE CONSTRUCTION**

Basic engine construction varies little, regardless of size and design of the engine. The intended use of an engine must be considered before the design and size can be determined. The temperature at which an engine will operate has a great deal to do with determining what metals must be used in its construction.

To simplify the service parts problem in the field, and also to simplify servicing procedures, the present trend in engine construction and design is toward what is called engine families. There must, of necessity, be many different kinds of engines because there are many kinds of jobs to be done. However, the service and service parts problem can be simplified by designing engines so that they are closely related in cylinder size, valve arrangement, etc. As an example, the GM series 71 engines can be obtained in 2, 3, 4, and 6 cylinders; but they are so designed that the same pistons, connecting rods, bearings, valve operating mechanisms and valves can be used in all 4 engines.

Engine construction, in this chapter, will be broken down into two categories: stationary parts and moving parts.

**STATIONARY PARTS**

The stationary parts of an engine include the cylinder block, cylinders, cylinder head or heads, crankcase, and the exhaust and intake manifolds. These parts furnish the framework of the engine. All movable parts are attached to or fitted into this framework.

**Engine Cylinder Block**

The engine cylinder block is the basic frame of a liquid-cooled engine, whether it be in-line, horizontally-opposed, or V-type. The cylinder block and crankcase are often cast in one piece which is the heaviest single piece of metal in the engine. (See fig. 13-9). In small engines, where weight is an important consideration, the crankcase may be cast separately. In most large diesel engines, such as those used in power plants, the crankcase is cast separately and is attached to a heavy stationary engine base.

In practically all automotive and construction equipment, however, the cylinder block and crankcase are cast in one piece. In this course we are concerned primarily with liquid-cooled engines, of this type.

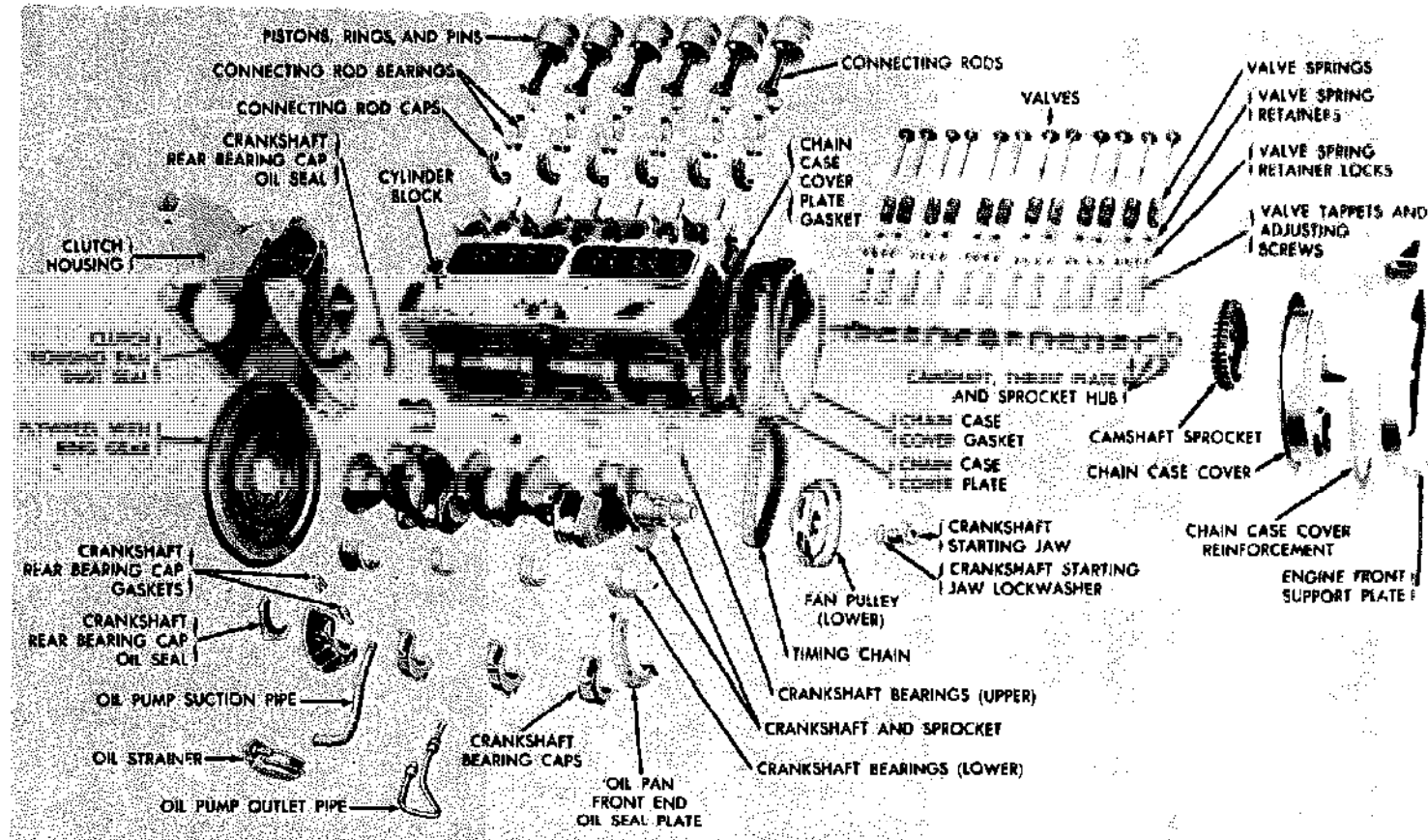


Figure 13-9.—Cylinder block and components.

The cylinders of a liquid-cooled engine are surrounded by jackets through which the cooling liquid circulates. These jackets are cast integrally with the cylinder block. Communicating passages permit the coolant to circulate around the cylinders and through the head.

The air-cooled engine cylinder differs from that of a liquid-cooled engine in that the cylinders are made individually, rather than cast in block. The cylinders of air-cooled engines have closely spaced fins surrounding the barrel; these fins provide a greatly increased surface area from which heat can be dissipated. This is in contrast to the liquid-cooled engine, which has a water jacket around its cylinders.

#### Cylinder Block Construction

The cylinder block is cast from gray iron or iron alloyed with other metals such as nickel, chromium, or molybdenum. Some light weight engine blocks are made from aluminum.

Cylinders are machined by grinding, and/or boring, to give them the desired true inner surface. During normal engine operation, cylinder walls will wear out-of-round, or they may become cracked and scored if not properly lubricated or cooled. Liners (sleeves) made of metal alloys resistant to wear, are used in many gasoline engines and practically all diesel engines to lessen wear. After they have been worn beyond the maximum oversize, the liners can be replaced individually permitting the use of standard pistons and rings. Thus you can avoid replacing the entire cylinder block.

The liners are inserted into a hole in the block with either a PRESS FIT or a SLIP FIT. Liners are further designated as WET TYPE or DRY TYPE. The wet type line comes in direct contact with the coolant and is sealed at the top by the use of a metallic sealing ring and at the bottom by a rubber sealing ring; the dry type liner does not contact the coolant.

Engine blocks for L-head engines contain the passageways for the valves and valve ports. The lower part of the block (crankcase) supports the crankshaft (with main bearings and bearing caps) and also provides a place for fastening the oil pan.

The camshaft is supported in the cylinder block by bushings that fit into machined holes in the block. On L-head in-line engines, the intake and exhaust manifolds are attached to the side of the cylinder block. On L-head V-8 engines, the intake manifold is located between the two banks

of cylinders. In this engine, there are two exhaust manifolds, one on the outside of each bank.

#### Cylinder Head

The cylinder head provides the combustion chambers for the engine cylinders. It is built to conform to the arrangement of the valves: L-head, I-head, or other.

In the water-cooled engine the cylinder head (fig. 13-10) is bolted to the top of the cylinder block to close the upper end of the cylinders. It contains passages, matching those of the cylinder block, which allow the cooling water to circulate in the head. The head also helps retain compression in the cylinders. In the gasoline engine there are tapped holes in the cylinder head which lead into the combustion chamber. The spark plugs are inserted into these tapped holes.

In the diesel engine the cylinder head may be cast in a single unit, or may be cast for a single cylinder or two or more cylinders. Separated head sections (usually covering 1, 2, or 3 cylinders in large engines) are easy to handle and can be readily removed.

The L-head type of cylinder head shown in figure 13-10 is a comparatively simple casting. It contains water jackets for cooling, and openings for spark plugs. Pockets into which the valves operate are also provided. Each pocket serves as a part of the combustion chamber. The fuel-air mixture is compressed in the pocket as the piston reaches the end of the compression stroke. Note that the pockets have a rather complex curved surface. This shape has been carefully designed so that the fuel-air mixture, in being compressed, will be subjected to violent turbulence. This turbulence assures uniform mixing of the fuel and air, thus improving the combustion process.

The I-head (overhead-valve) type of cylinder head contains not only water jackets for cooling spark-plug openings, and valve and combustion-chamber pockets, but it also contains and supports the valves and valve-operating mechanisms. In this type of cylinder head, the water jackets must be large enough to cool not only the top of the combustion chamber but also the valve seats, valves, and valve-operating mechanisms.

#### Crankcase

The crankcase is that part of the engine block below the cylinders. It supports and encloses the

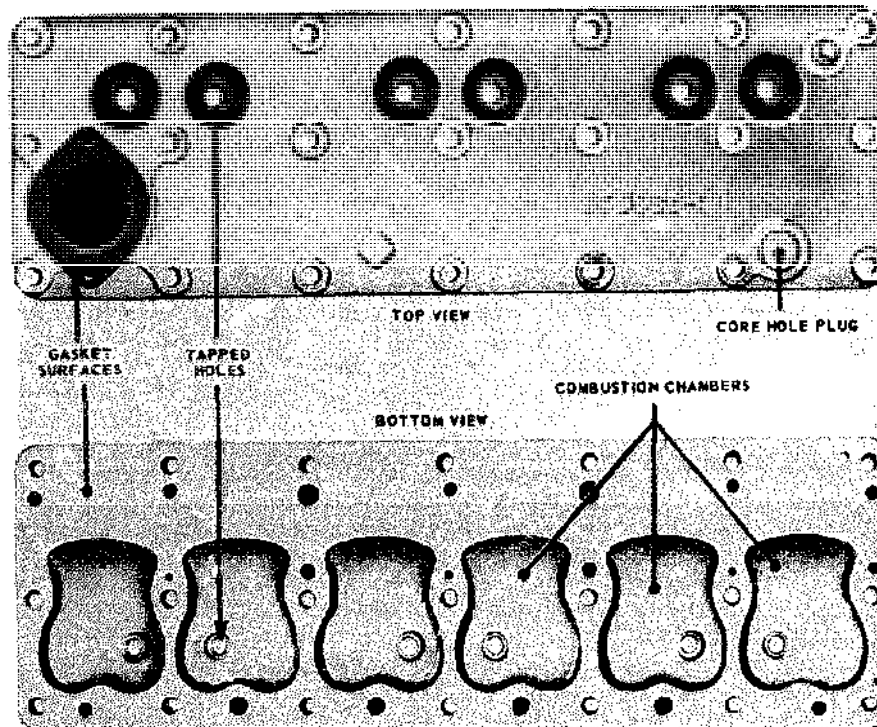


Figure 13-10.--Cylinder head for L-head engine.

81.50

crankshaft and provides a reservoir for the lubricating oil. Oftentimes there are places provided on the crankcase for the mounting of the oil pump, oil filter, starting motor, and the generator. The lower part of the crankcase is the OIL PAN, which is bolted at the bottom. The oil pan is made of pressed or cast steel and holds from 4 to 9 quarts of oil, depending on the engine design.

The crankcase also has mounting brackets which support the entire engine on the vehicle frame. These brackets are either an integral part of the crankcase or are bolted to it in such a way that they support the engine at 3 or 4 points. These points of contact usually are cushioned with rubber, which insulates the frame and body of the vehicle from engine vibration and therefore prevents damage to the engine supports and the transmission.

#### Exhaust Manifold

The exhaust manifold is essentially a tube that carries waste products of combustion from the cylinders. On L-head engines the exhaust manifold is bolted to the side of the engine block; on overhead-valve engines it is bolted to the side of the engine cylinder head. Exhaust manifolds may be single iron castings or may be cast in sections. They have a smooth interior surface with no abrupt changes in size. (See fig. 13-11.)

#### Intake Manifold

The intake manifold on a gasoline engine carries the fuel-air mixture from the carburetor and distributes it as evenly as possible to the cylinders. On a diesel engine the manifold carries only air to the cylinders. The intake



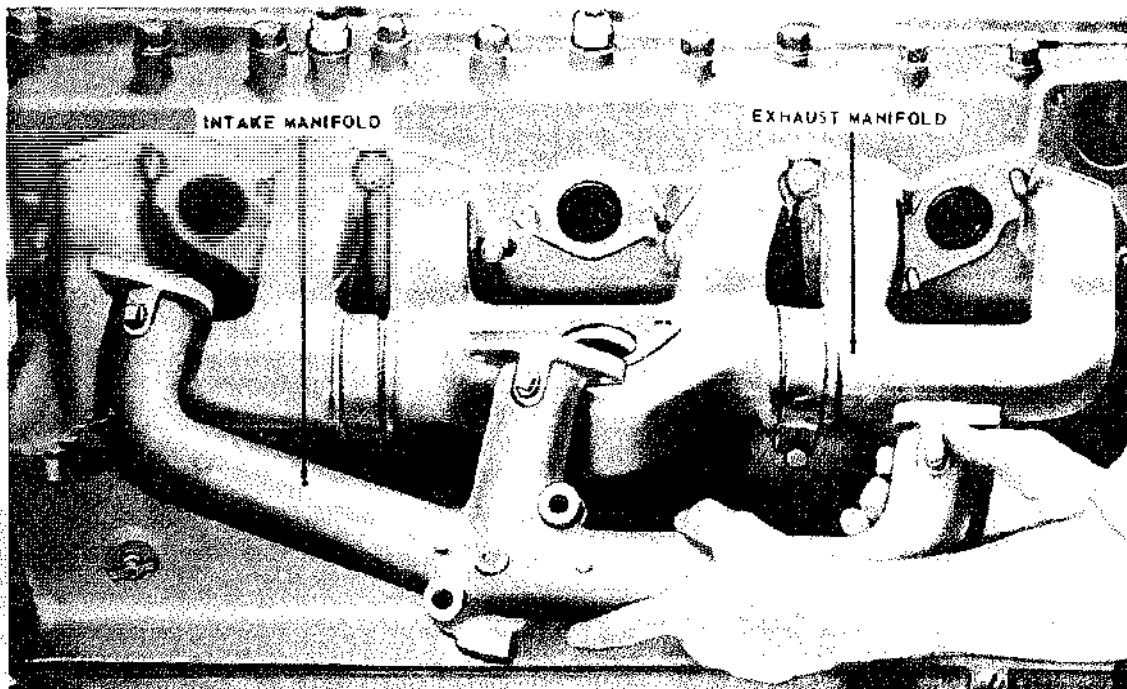


Figure 13-11.—Intake and exhaust manifolds.

65.93

manifold is attached to the block on L-head engines and to the side of the cylinder head on overhead-valve engines. (See fig. 13-11.)

In gasoline engines, smooth and efficient engine performance depends largely on whether or not the fuel-air mixtures that enter each cylinder are uniform in strength, quality, and degree of vaporization. The inside walls of the manifold must be smooth to offer little obstruction to the flow of the fuel-air mixture. The manifold is designed to prevent collecting of fuel at the bends in the manifold.

The intake manifold should be as short and straight as possible to reduce the chances of condensation between the carburetor and cylinders. To assist in vaporization of fuel, some intake manifolds are constructed so that part of their surfaces can be heated by hot exhaust gases.

#### Gaskets

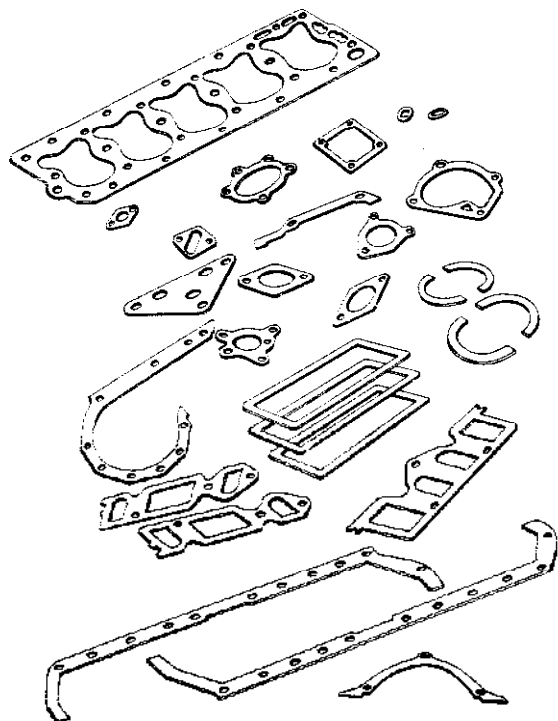
The principal stationary parts of an engine have just been explained. The gaskets (fig. 13-12)

that serve as seals between these parts in assembly, require as much attention during assembly as any other part. It is impractical to machine all surfaces so that they fit together to form a perfect seal. The gaskets make a joint that is air, water, or oil tight; therefore, when properly installed, they prevent loss of compression, coolant, or lubricant.

#### MOVING PARTS OF AN ENGINE

The moving parts of an engine serve an important function in turning heat energy into mechanical energy. They further convert reciprocal motion into rotary motion. The principal moving parts are the piston assembly, connecting rods, crankshaft assembly (includes flywheel and vibration dampener), camshaft, valves, and gear train.

The burning of the fuel-air mixture within the cylinder exerts a pressure on the piston, thus pushing it down in the cylinder. The action of



81.52

Figure 13-12.—Engine overhaul gasket kit.

the connecting rod and crankshaft converts this downward motion to a rotary motion.

### Piston Assembly

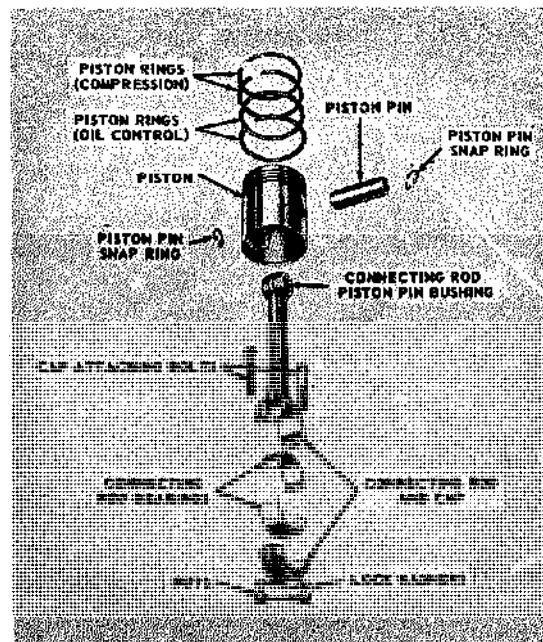
Engine pistons serve several purposes: they transmit the force of combustion to the crankshaft through the connecting rod; they act as a guide for the upper end of the connecting rod; and they also serve as a carrier for the piston rings used to seal the compression in the cylinder. (See fig. 13-13.)

The piston must come to a complete stop at the end of each stroke before reversing its course in the cylinder. To withstand this rugged treatment and wear, it must be made of tough material, yet be light in weight. To overcome inertia and momentum at high speeds, it must be carefully balanced and weighed. All the pistons used in any one engine must be of similar weight to avoid excessive vibration. Ribs are used on

the underside of the piston to reinforce the head; the ribs also assist in conducting heat from the head of the piston to the piston rings and out through the cylinder walls.

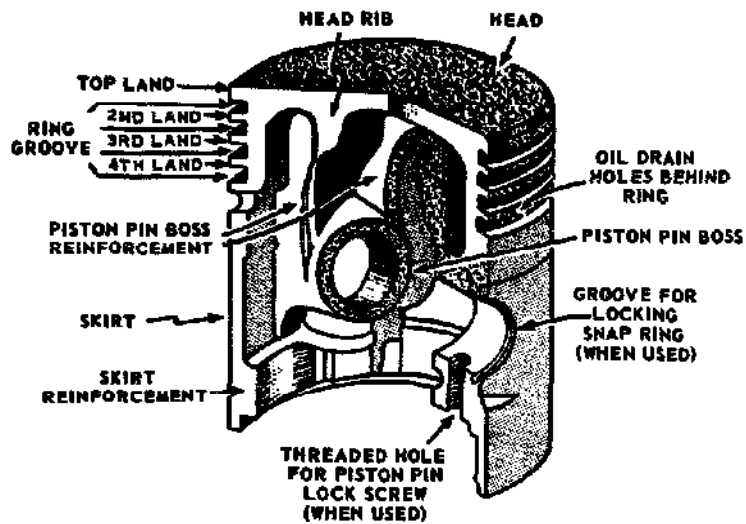
The structural components of the piston are the HEAD, SKIRT, RING GROOVES, and LANDS (fig. 13-14). However, all pistons do not look like the typical one here illustrated. Some have differently shaped heads. Diesel engine pistons usually have more ring grooves and rings than the pistons of gasoline engines. Some of these rings may be installed below as well as above the WRIST or PISTON PIN (fig. 13-15).

Fitting pistons properly is important. Because metal expands when heated, and because space must be provided for lubricants between the pistons and the cylinder walls, the pistons are fitted to the engine with a specified clearance. This clearance depends upon the size or diameter of the piston and the material from which it is made. Cast iron does not expand as fast or as much as aluminum. Aluminum pistons require more clearance to prevent binding or seizing



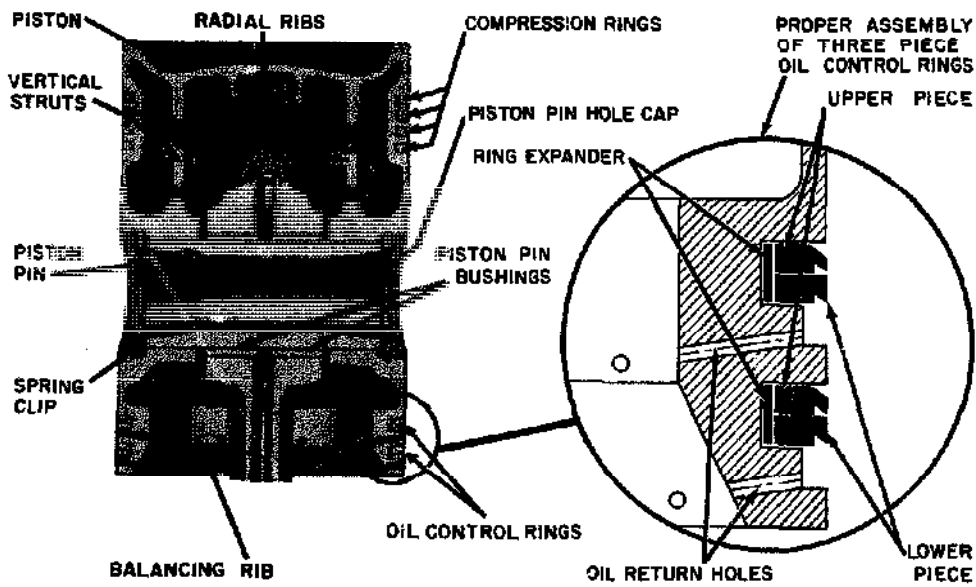
75.70

Figure 13-13.—Piston and connecting rod (exploded view).



81.53

Figure 13-14.—The parts of a piston.



81.54

Figure 13-15.—Piston assembly of General Motors series 71 engine.

## BASIC MACHINES

when the engine gets hot. The skirt or bottom part of the piston runs much cooler than the top; therefore, it does not require as much clearance as the head.

The piston is kept in alignment by the skirt, which is usually CAM GROUND (elliptical in cross section) (fig. 13-16). This elliptical shape permits the piston to fit the cylinder, regardless of whether the piston is cold or at operating temperature. The narrowest diameter of the piston is at the piston pin bosses, where the metal is thickest. At the widest diameter of the piston, the piston skirt is thinnest. The piston is fitted to close limits at its widest diameter so that piston noise (slap) is prevented during engine warm-up. As the piston is expanded by the heat generated during operation, it becomes round because the expansion is proportional to the temperature of the metal. The walls of the skirt are cut away as much as possible to reduce weight and to prevent excessive expansion during

engine operation. Many aluminum pistons are made with SPLIT SKIRTS so that when the pistons expand the skirt diameter will not increase. The two types of piston skirts found in most engines are the FULL TRUNK and the SLIPPER. The full-trunk-type skirt, which is more widely used, has a full cylindrical shape with bearing surfaces parallel to those of the cylinder, giving more strength and better control of the oil film. The SLIPPER-TYPE (CUTAWAY) skirt has considerable relief on the sides of the skirt, leaving less area for possible contact with the cylinder walls and thereby reducing friction.

**PISTON PINS.**—The piston is attached to the connecting rod by means of the piston pin (wrist pin). The pin passes through the piston pin bosses and through the upper end of the connecting rod, which rides within the piston on the middle of the pin. Piston pins are made of alloy steel with a precision finish and are case

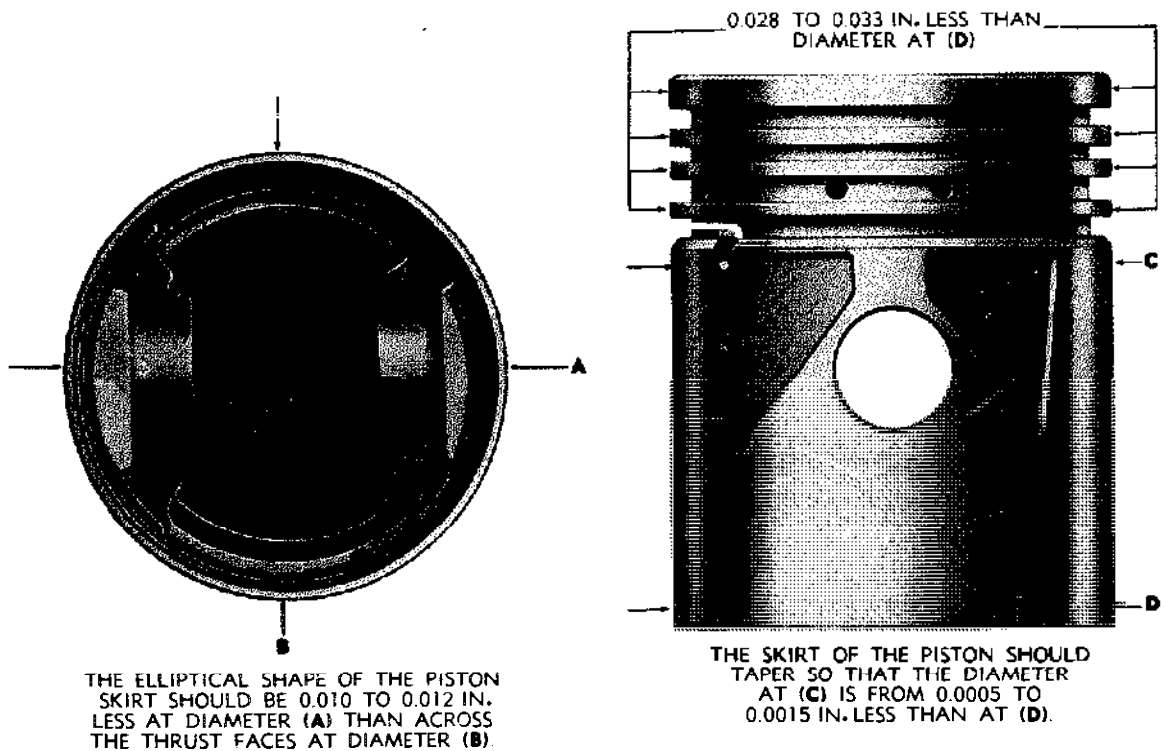


Figure 13-16.—Cam-ground piston.

81.55

hardened and sometimes chromium plated to increase their wearing qualities. Their tubular construction gives them a maximum of strength with a minimum of weight. They are lubricated by splash from the crankcase or by pressure through passages bored in the connecting rods.

There are three methods commonly used for fastening a piston pin to the piston and the connecting rod. (See fig. 13-17.) An anchored, or "fixed," pin is attached to the piston by a screw running through one of the bosses; the connecting rod oscillates on the pin. A "semifloating" pin is anchored to the connecting rod and turns in the piston pin bosses. A "full-floating" pin is free to rotate in the connecting rod and in the bosses, but is prevented from working out against the sides of the cylinder by plugs or snapping locks.

**PISTON RINGS.**—Piston rings are used on pistons to maintain gastight seals between the pistons and cylinders, to assist in cooling the piston, and to control cylinder-wall lubrication. About one-third of the heat absorbed by the piston passes through the rings to the cylinder wall. Piston rings are often quite complicated in design, are heat treated in various ways and are plated with other metals. There are two distinct classifications of piston rings: compression rings and oil control rings. (See fig. 13-18.)

The principal function of a compression ring is to prevent gases from leaking by the piston during the compression and power strokes. All piston rings are split to permit assembly to the piston and to allow for expansion. When the ring

is in place, the ends of the split joint do not form a perfect seal; therefore, it is necessary to use more than one ring and to stagger the joints around the piston. If cylinders are worn, expanders (fig. 13-15 and 13-18) are sometimes used to ensure a perfect seal.

The bottom ring, usually located just above the piston pin, is an oil regulating ring. This ring scrapes the excess oil from the cylinder walls and returns some of it, through slots, to the piston ring grooves. The ring groove under an oil ring is provided with openings through which the oil flows back into the crankcase. In some engines, additional oil rings are used in the piston skirt below the piston pin.

#### Connecting Rods

Connecting rods must be light and yet strong enough to transmit the thrust of the pistons to the crankshaft. Connecting rods are drop forged from a steel alloy capable of withstanding heavy loads without bending or twisting. Holes at the upper and lower ends are machined to permit accurate fitting of bearings. These holes must be parallel.

The upper end of the connecting rod is connected to the piston by the piston pin. If the piston pin is locked in the piston pin bosses, or if it floats in both piston and connecting rod, the upper hole of the connecting rod will have a solid bearing (bushing) of bronze or similar material. As the lower end of the connecting rod revolves with the crankshaft, the upper end is forced to

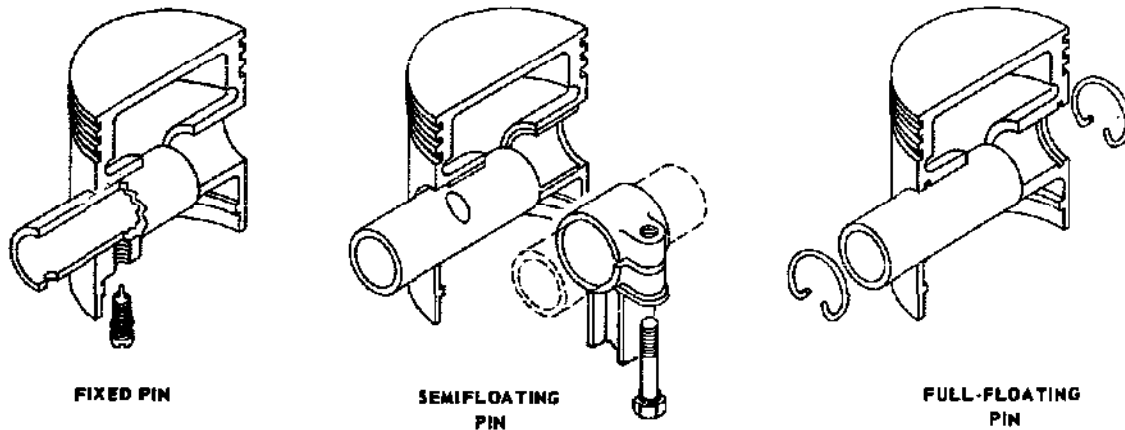
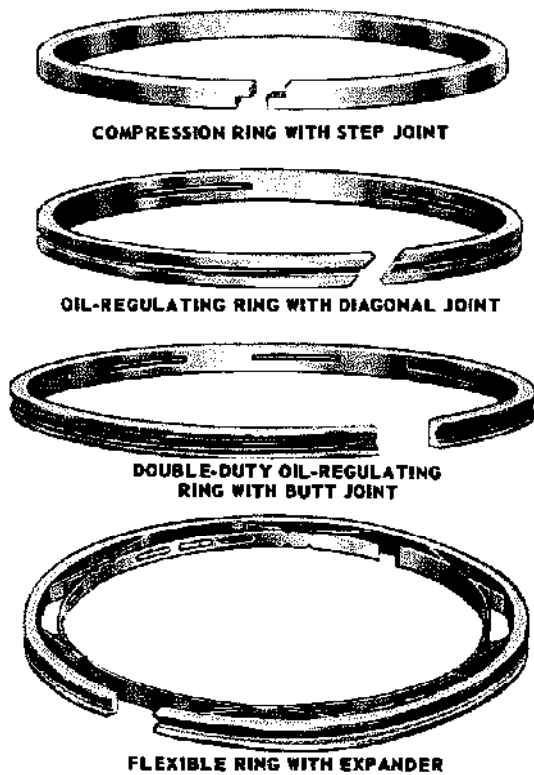


Figure 13-17.—Piston pin types.

81.56



75.51

Figure 13-18.—Piston rings.

turn back and forth on the piston pin. Although this movement is slight, the bushing is necessary because the temperatures and the pressures are high. If the piston pin is semifloating, a bushing is not needed.

The lower hole in the connecting rod is split to permit it to be clamped around the crankshaft. The bottom part, or cap, is made of the same material as the rod and is attached by two or more bolts. The surface that bears on the crankshaft is generally a bearing material in the form of a separate split shell, although, in a few cases, it may be spun or die-cast in the inside of the rod and cap during manufacture. The two parts of the separate bearing are positioned in the rod and cap by dowel pins, projections, or short brass screws. Split bearings may be of the precision or semiprecision type.

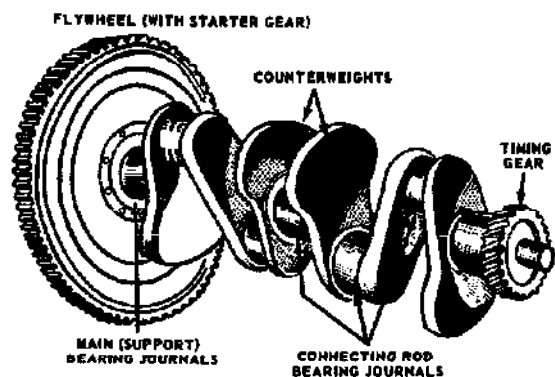
The **PRECISION** type bearing is accurately finished to fit the crankpin and does not require further fitting during installation. It is positioned by projections on the shell which match reliefs in the rod and cap. The projections prevent the bearings from moving sideways and from rotary motion in the rod and cap.

The **SEMPRECISSION** type bearing is usually fastened to or die-cast with the rod and cap. Prior to installation, it is machined and fitted to the proper inside diameter with the cap and rod bolted together.

**Crankshaft**

As the pistons collectively might be regarded as the heart of the engine, so the **CRANKSHAFT** may be considered its backbone (fig. 13-19). It ties together the reactions of the pistons and the connecting rods, transforming their reciprocating motion into a rotary motion. And it transmits engine power through the flywheel, clutch, transmission, and differential to drive your vehicle.

The crankshaft is forged or cast from an alloy of steel and nickel, is machined smooth to provide bearing surfaces for the connecting rods and the main bearings, and is **CASE-HARDENED**, or coated in a furnace with copper alloyed with carbon. These bearing surfaces are called **JOURNALS**. The crankshaft counterweights impede the centrifugal force of the connecting rod assembly attached to the **THROWS** or points of bearing support. These



75.81

Figure 13-19.—Crankshaft of a 4-cylinder engine.

throws must be placed so that they counter-balance each other.

Crank throw arrangements for 4-, 6-, and 8-cylinder engines are shown in figure 13-20. Four-cylinder engine crankshafts have either 3 or 5 main support bearings and 4 throws in one plane. In figure 13-20 you see that the throws for No. 1 and No. 4 cylinders (4-cylinder engine) are  $180^\circ$  from those for No. 2 and No. 3 cylinders. On 6-cylinder engine crankshafts each of the 3 pairs of throws is arranged  $120^\circ$  from the other 2. Such crankshafts may be supported by as many as 7 main bearings, that is one at each end of the shaft and one between each pair of crankshaft throws. The crankshafts of 8-cylinder V-type engines are similar to those for the 4-cylinder in-line type or may have each of the 4 throws fixed at  $90^\circ$  from each other (as in fig. 13-20) for better balance and smoother operation.

V-type engines usually have two connecting rods fastened side by side on one crankshaft

throw. With this arrangement, one bank of the engine cylinders is set slightly ahead of the other to allow the two rods to clear each other.

#### Vibration Damper

The power impulses of an engine tend to set up torsional vibration in the crankshaft. If this torsional vibration were not controlled, the crankshaft might actually break at certain speeds; a vibration damper mounted on the front of the crankshaft is used to control this vibration (fig. 13-21).

Most types of vibration dampers resemble a miniature clutch. A friction facing is mounted between the hub face and a small damper flywheel. The damper flywheel is mounted on the hub face with bolts that go through rubber cones in the flywheel. These cones permit limited circumferential movement between the crankshaft and damper flywheel. This minimizes the

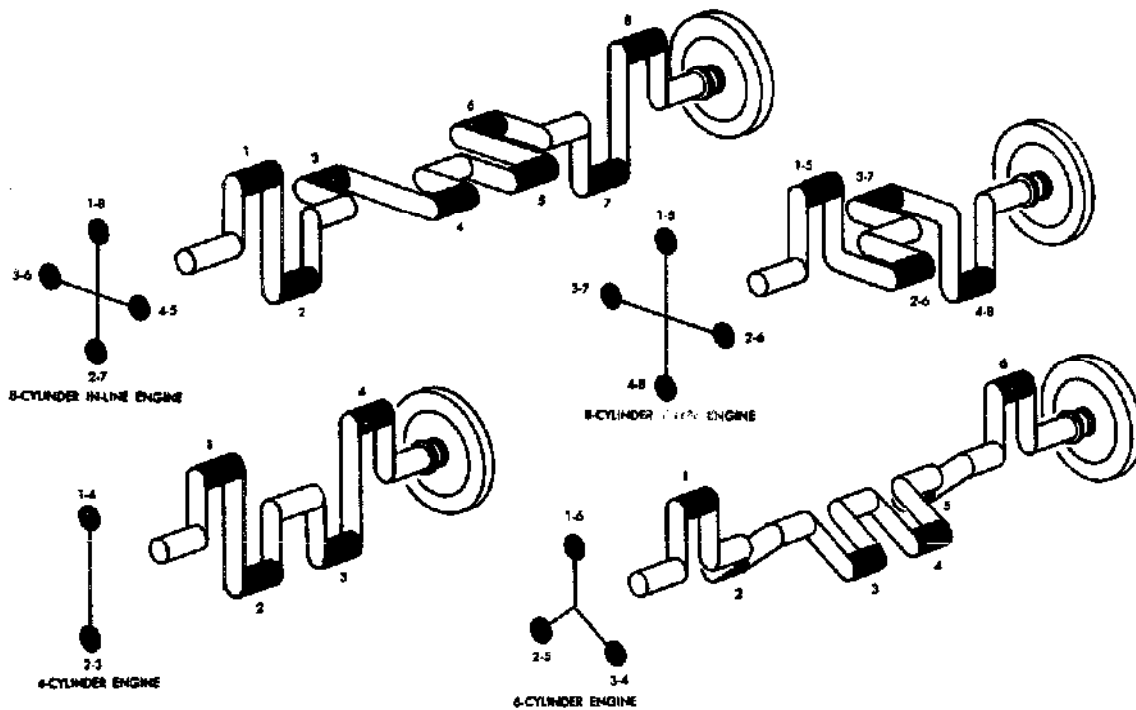
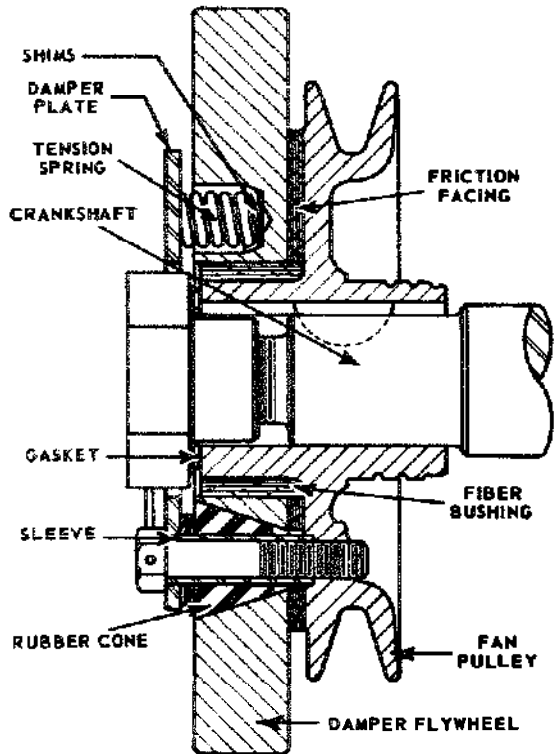


Figure 13-20.—Crankshaft and throw arrangements commonly used.

75.81



81.62

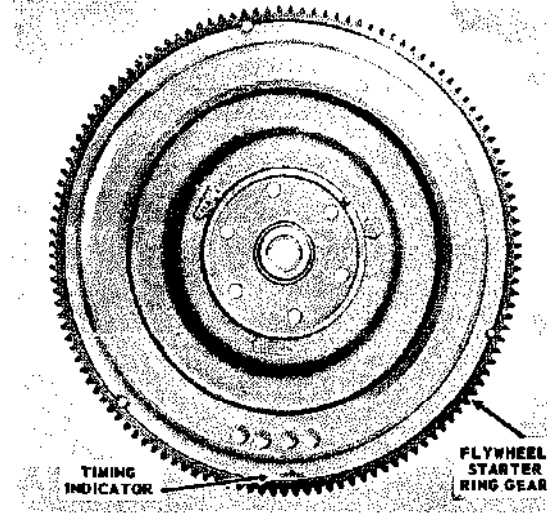
Figure 13-21.—Sectional view of a typical vibration damper.

effects of the torsional vibration in the crankshaft. Several other types of vibration dampers are used. However, they all operate in essentially the same way.

#### Engine Flywheel

The flywheel is mounted at the rear of the crankshaft near the rear main bearing. This is usually the longest and heaviest main bearing in the engine, as it must support the weight of the flywheel.

The flywheel (fig. 13-22) stores up energy of rotation during power impulses of the engine. It releases this energy between power impulses, thus assuring less fluctuation in engine speed and smoother engine operation. The size of the flywheel will vary with the number of cylinders and the general construction of the engine. With a large number of cylinders and the consequent



81.63

Figure 13-22.—Flywheel.

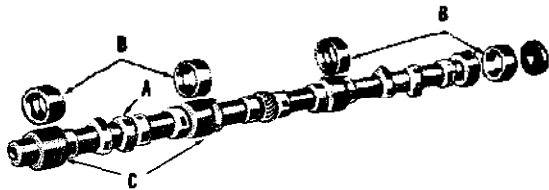
overlapping of power impulses, there is less need for a flywheel; consequently, the flywheel can be relatively small. The flywheel rim carries a ring gear, either integral with the flywheel or shrunk on, that meshes with the starter driving gear for cranking the engine. The rear face of the flywheel is usually machined and ground, and acts as one of the pressure surfaces for the clutch, becoming a part of the clutch assembly.

#### Valves And Valve Mechanisms

There are two valves for each cylinder in most engines, one intake and one exhaust valve. Since each of these valves operates at different times, it is necessary that separate operating mechanisms be provided for each valve. Valves are normally held closed by heavy springs and by compression in the combustion chamber. The purpose of the valve-actuating mechanism is to overcome the spring pressure and open the valves at the proper time. The valve-actuating mechanism includes the engine camshaft, camshaft followers (tappets), pushrods, and rocker arms.

**CAMSHAFT.**—The camshaft (fig. 13-23) is inclosed in the engine block. It has eccentric lobes (cams) ground on it for each valve in the





A - CAMSHAFT  
B - CAMSHAFT BEARING  
C - BEARING JOURNAL

81.61

Figure 13-23.—Camshaft and bushings.

engine. As the camshaft rotates, the cam lobe moves up under the valve tappet, exerting an upward thrust through the tappet against the valve stem or a pushrod. This thrust overcomes the valve spring pressure as well as the gas pressure in the cylinder, causing the valve to open. When the lobe moves from under the tappet, the valve spring pressure reseats the valve.

On L-, F-, or I-head engines, the camshaft is usually located to one side and above the crankshaft, while in V-type engines it is usually located directly above the crankshaft. On the overhead camshaft engine, such as the Murphy diesel, the camshaft is located above the cylinder head.

The camshaft of a 4-stroke cycle engine turns at one-half engine speed. It is driven off the crankshaft through timing gears or a timing chain. In the 2-stroke cycle engine the camshaft must turn at the same speed as the crankshaft in order that each valve may open and close once in each revolution of the engine.

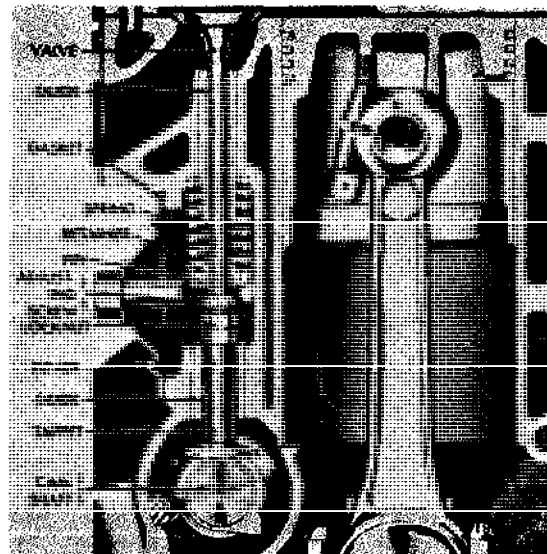
In most cases the camshaft will do more than operate the valve mechanism. It may have extra cams or gears that operate fuel pumps, fuel injectors, the ignition distributor, or the lubrication pump.

Camshafts are supported in the engine block by journals in bearings. Camshaft bearing journals are the largest machined surfaces on the shaft. The bearings are usually made of bronze and are bushings rather than split bearings. The bushings are lubricated by oil circulating through drilled passages from the crankcase. The stresses on the camshaft are

small, therefore the bushings are not adjustable and require little attention. The camshaft bushings are generally replaced only when the engine requires a complete overhaul.

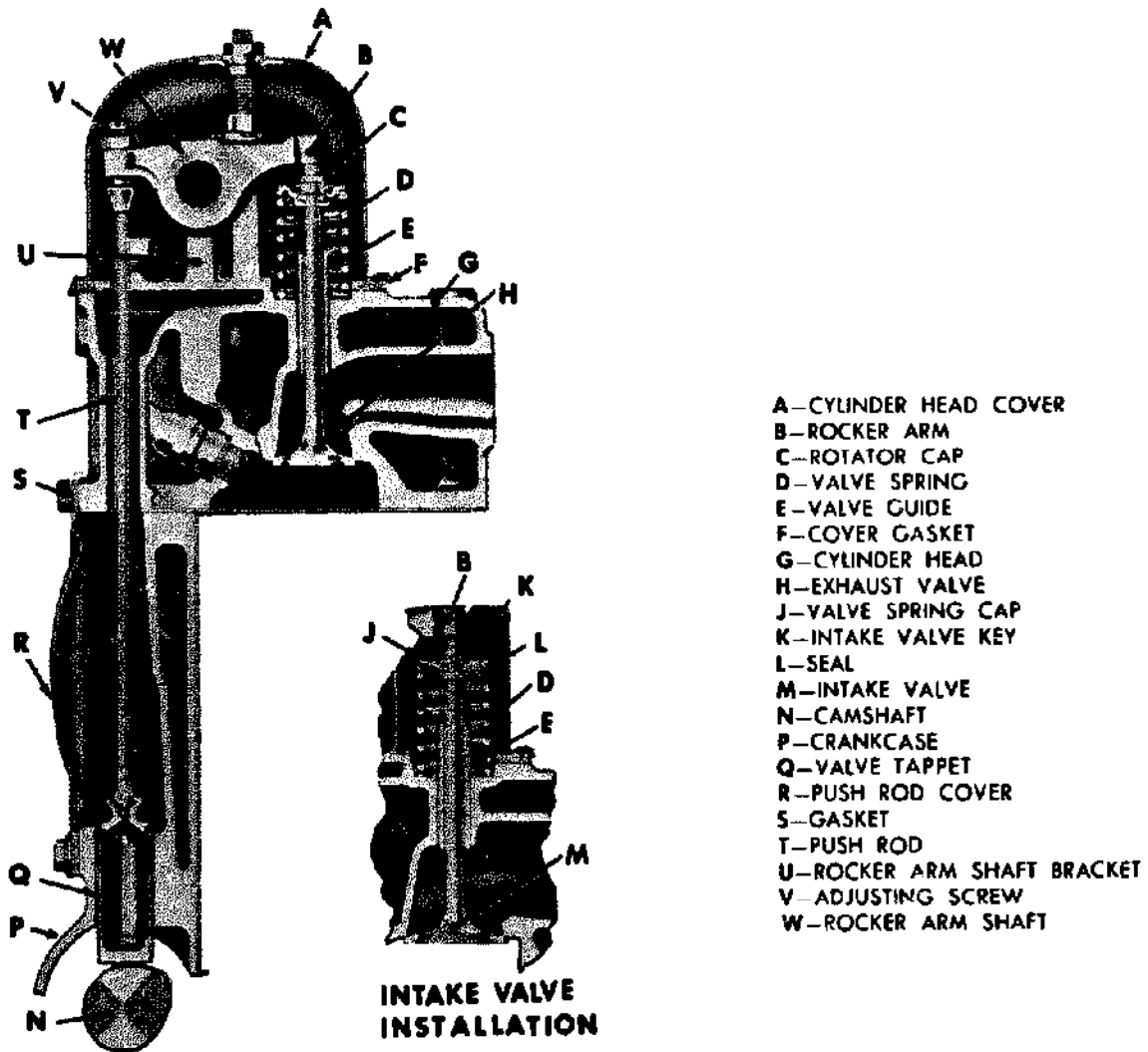
**FOLLOWERS.**—Camshaft followers (figs. 13-24 and 13-25) are the parts of the valve-actuating mechanism that contact the camshaft. You will probably hear them called valve tappets or valve lifters. In the L-head engine the followers directly contact the end of the valve stem and have an adjusting device in them. In the overhead valve engine the followers contact the pushrod that operates the rocker arm. The end of the rocker arm opposite the pushrod contacts the valve stem. The valve adjusting device, in this case, is in the rocker arm.

Many engines have self-adjusting valve lifters of the hydraulic type that operate at zero clearance at all times. The operation of one type of hydraulic valve tappet mechanism is shown in figure 13-26. Oil under pressure is forced into the tappet when the valve is closed, and this pressure extends the plunger in the tappet so that all valve clearance, or lash, is eliminated. When the cam lobe moves around under the tappet and starts to raise it, there will not be any tappet noise. As the lobe starts to



81.64

Figure 13-24.—L-head valve operating mechanism.



- A—CYLINDER HEAD COVER
- B—ROCKER ARM
- C—ROTATOR CAP
- D—VALVE SPRING
- E—VALVE GUIDE
- F—COVER GASKET
- G—CYLINDER HEAD
- H—EXHAUST VALVE
- J—VALVE SPRING CAP
- K—INTAKE VALVE KEY
- L—SEAL
- M—INTAKE VALVE
- N—CAMSHAFT
- P—CRANKCASE
- Q—VALVE TAPPET
- R—PUSH ROD COVER
- S—GASKET
- T—PUSH ROD
- U—ROCKER ARM SHAFT BRACKET
- V—ADJUSTING SCREW
- W—ROCKER ARM SHAFT

**INTAKE VALVE  
INSTALLATION**

81.65

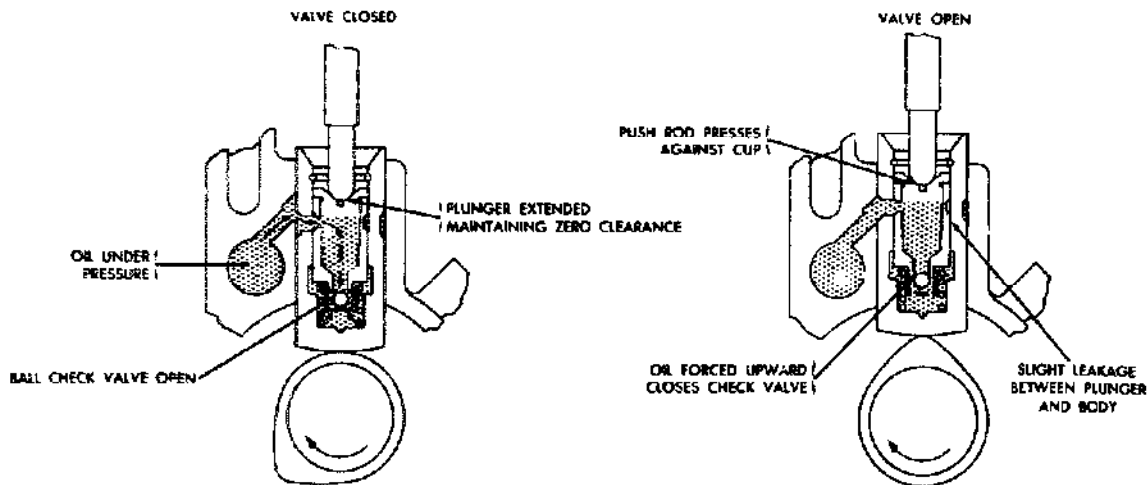
**Figure 13-25.—Valve operating mechanism for an overhead valve engine.**

raise the tappet, the oil is forced upward in the lower chamber of the tappet. This action closes the ball check valve so oil cannot escape. Then the tappet acts as though it were a simple, 1-piece tappet and the valve is opened. When the lobe moves out from under the tappet and the valve closes, the pressure in the lower chamber of the tappet is relieved. Any slight loss of oil from the lower chamber is then replaced by the oil pressure from the engine lubricating system. This causes the plunger to move up snugly

against the push rod so that any clearance is eliminated.

**Timing Gears (Gear Trains)**

Timing gears keep the crankshaft and camshaft turning in proper relation to one another so that the valves open and close at the proper time. In some engines, sprockets and chains are used.



81.66

Figure 13-26.—Operation of a hydraulic valve lifter.

The gears or sprockets, as the case may be, of the camshaft and crankshaft are keyed in position so that they cannot slip. Since they are keyed to their respective shafts, they can be replaced if they become worn or noisy.

With directly driven timing gears (fig. 13-27), one gear usually has a mark on two adjacent teeth and the other a mark on only one tooth. To time the valves properly, it is necessary only to mesh the gears so that the two marked teeth of one gear straddle the single marked tooth of the other.

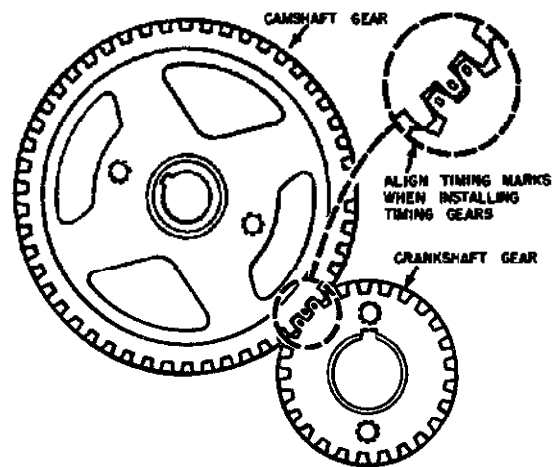
in air-cooled engines a blower is generally used to force cool air around the engine cylinders.

In addition, an exhaust system is provided to carry away the burned gases exhausted from the engine cylinders. These systems will not be discussed in this course, however. For further information on them refer to NavPers 10644D, Construction Mechanic 3 & 2.

#### AUXILIARY ASSEMBLIES

We have discussed the main parts of the engine proper; but there are other parts, both moving and stationary, that are essential to engine operation. They are not built into the engine itself, but, in most cases, are attached to the engine block or cylinder head.

The fuel system includes a fuel pump and carburetor mounted on the engine. In diesel engines the fuel injection mechanism replaces the carburetor. An electrical system is provided to supply power for starting the engine and also for ignition during operation. An efficient cooling system is necessary for operating an internal combustion engine. In water-cooled engines a water pump and fan are used, while



81.69

Figure 13-27.—Timing gears and their markings.

## CHAPTER 14

# POWER TRAINS

In chapter 13 we saw how a combination of simple machines and basic mechanisms were utilized in constructing the internal combustion engine. In this chapter we will go on from there to learn how the power developed by the engine is transmitted to perform the work required of it. To illustrate this, we will use the power train system as used by the automobile, and most trucks, as a familiar example. In this application, once again you are to look for the simple machines that make up each of the machines or mechanisms which are interconnected to make up the power train.

In a vehicle, the mechanism that transmits the power of the engine to the wheels and/or tracks and accessory equipment is called the power train. In a simple situation, a set of gears or a chain and sprocket could perform this task, but automotive and construction vehicles are not usually designed for such simple operating conditions. They are designed to have great pulling power, to move at high speeds, to travel in reverse as well as forward, and to operate on rough terrain as well as smooth roads. To meet these widely varying demands, a number of units have been added to the vehicles.

Automobiles and light trucks driven by the two rear wheels have a power train consisting of clutch, transmission, propeller shaft, differential, and driving axles (fig. 14-1).

In 4- and 6-wheel drive trucks, you will find transfer cases with additional drive shafts and live axles. Tractors, shovels, cranes, and other heavy-duty vehicles that move on tracks also have similar power trains. In addition to assemblies that drive sprockets to move the tracks, these vehicles also have auxiliary transmissions or power takeoff units which may be used to operate accessory attachments. The propeller shafts and clutch assemblies of these power trains are very much like those used to drive the wheels.

### THE CLUTCH

The clutch is placed in the power train of motorized equipment for two purposes:

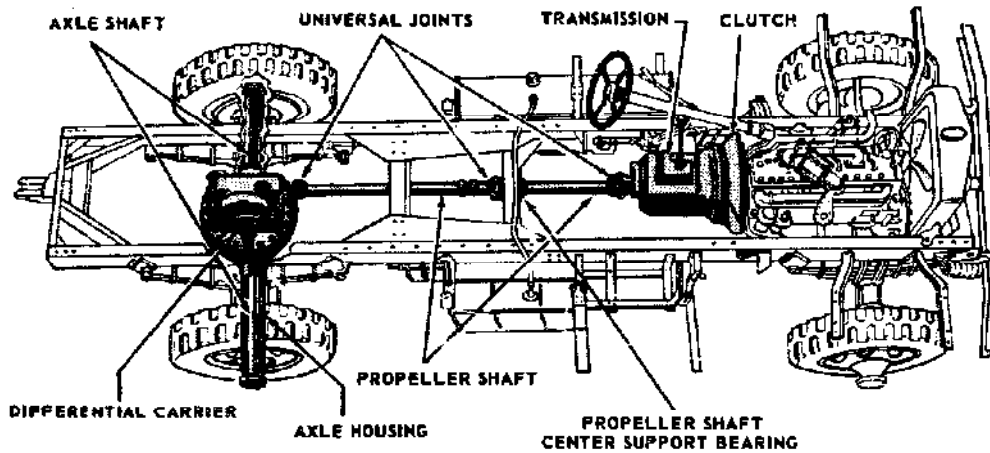
First, it provides a means of disconnecting the power of the engine from the driving wheels and accessory equipment. When the clutch is disengaged, the engine can run without driving the vehicle or operating the accessories.

Second, when the vehicle is started, the clutch allows the engine to take up the load of driving the vehicle or accessories gradually and without shock.

Clutches are located in the power train between the source of power and the operating unit. Usually, they are placed between the engine and the transmission assembly, as shown in figure 14-1.

Clutches generally transmit power from the clutch driving member to the driven member by friction. In the plate clutch, figure 14-2 the driving member or plate, which is secured to the engine flywheel, is gradually brought in contact with the driven member (disc). The contact is made and held by strong spring pressure controlled by the driver with the clutch pedal. With only a light spring pressure, there is little friction between the two members and the clutch is permitted to slip. As the spring pressure increases, friction also increases, and less slippage occurs. When the driver removes his foot from the clutch pedal and full spring pressure is applied, the speed of the driving plate and driven disc is the same, and all slipping stops. There is then a direct connection between the driving and driven shafts.

In most clutches, there is a direct mechanical linkage between the clutch pedal and the clutch release yoke lever. On many late model vehicles, and on some of the larger units which require great pressure to release the spring, a hydraulic clutch release system is used. A master cylinder (fig. 14-3), similar to the brake



81.174

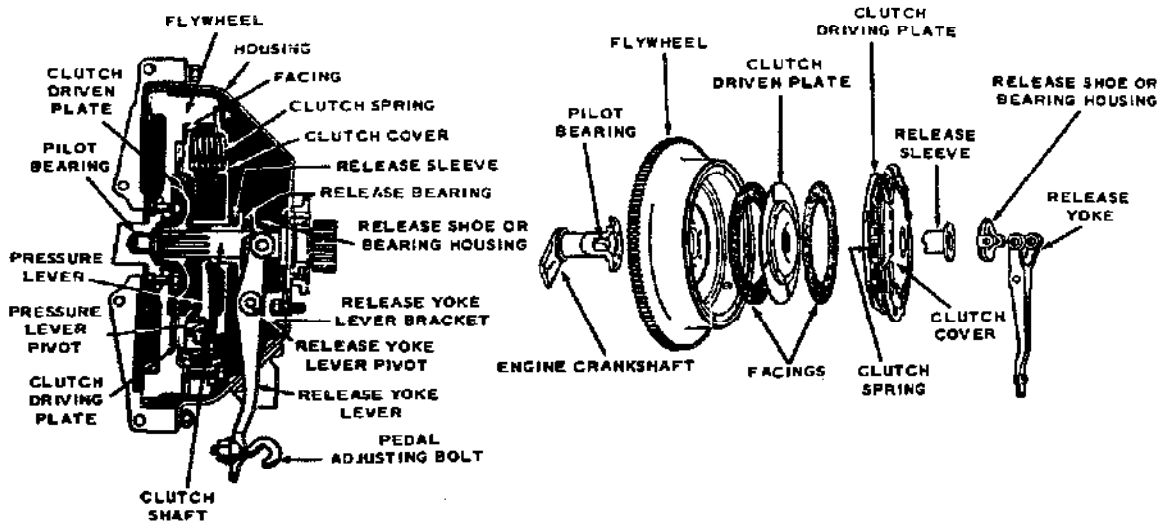
Figure 14-1.—Type of power transmission.

master cylinder, is attached to the clutch pedal. A cylinder, similar to a single-acting brake wheel cylinder, is connected to the master cylinder by flexible pressure hose or metal tubing (fig. 14-3). The slave cylinder is connected to the clutch release yoke lever. Movement of the clutch pedal actuates the clutch master cylinder. This movement is transferred

by hydraulic pressure to the slave cylinder, which in turn actuates the clutch release yoke lever.

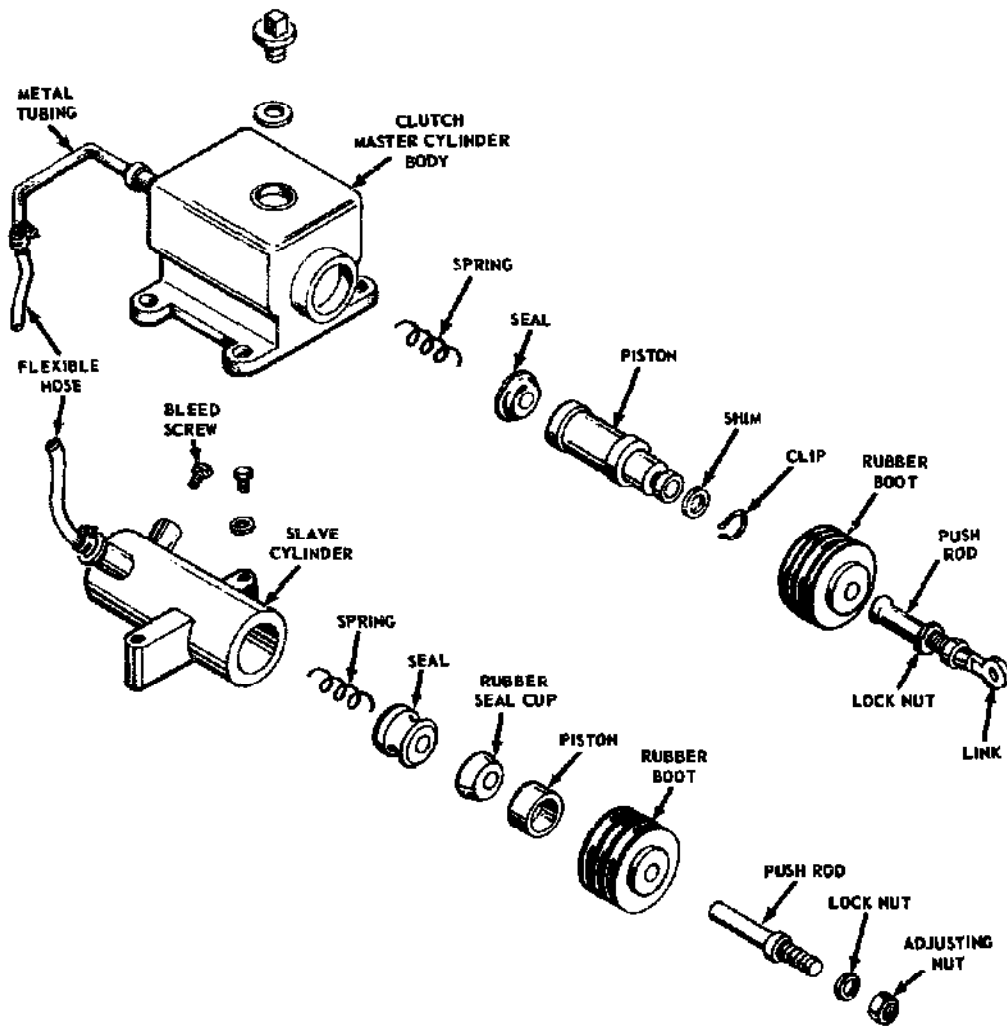
TYPES OF CLUTCHES

There are various types of clutches. The type most used in passenger cars and light



81.175

Figure 14-2.—Exploded and cross-section view of a plate clutch.



81.177

Figure 14-3.—Master cylinder, slave cylinder and connections for standard hydraulic clutch.

trucks is the previously-mentioned plate clutch. The plate clutch is a simple clutch with three plates, one of which is clamped between the other two. Exploded and cross-sectional views of a plate clutch are shown in figure 14-2.

#### Single Disk Clutch

The driving members of the single disk clutch consist of the flywheel and the driving

(pressure) plate. The driven member consists of a single disk, splined to the clutch shaft and faced on both sides with friction material. When the clutch is fully engaged, the driven disc is firmly clamped between the flywheel and the driving plate by pressure of the clutch springs, forming a direct, nonslipping connection between the driving and driven members of the clutch. In this position, the driven disc rotates the clutch shaft to which it is splined. The clutch shaft is

connected to the driving wheels through the transmission, propeller shaft, final drive, differential, and live axles.

The double disk clutch (fig. 14-4) is substantially the same as the single plate disk clutch except that another driven disk and intermediate driving plate is added.

**Multiple Disk Clutch**

A multiple disk clutch is one having more than three plates or disks. Some have as many as 11 driving plates and 10 driven disks. Because the multiple disk type has a greater frictional area than a plate clutch, it is best suited as a steering clutch on crawler type tractors. The multiple disk clutch is sometimes used on heavy trucks. In operation, it is very much like the plate clutch and has the same release mechanism. The facings, however, are usually attached to the driving plates rather than to the driven disks. This reduces the weight of the driven disks and keeps them from spinning after the clutch is released.

You may run into other types of friction clutches such as the lubricated plate clutch and the cone clutch. These types are seldom used on automotive equipment. However, fluid drive is largely replacing the friction clutches in automobiles and light trucks, and even in some tractors.

For information on fluid drives (automatic transmissions), refer to Construction Mechanic 3 & 2, NavPers 10644-D, chapter 11.

**TRANSMISSION**

The transmission is part of the power train. It consists of a metal case filled with gears (fig. 14-5), and is usually located in the rear of the engine between the clutch housing and the propeller shaft, as shown in figure 14-1. The transmission transfers engine power from the clutch shaft to the propeller shaft, and allows the driver or operator to control the power and speed of the vehicle. The transmission shown in figure 14-5 and 14-6 is a sliding gear transmission. Many late model trucks

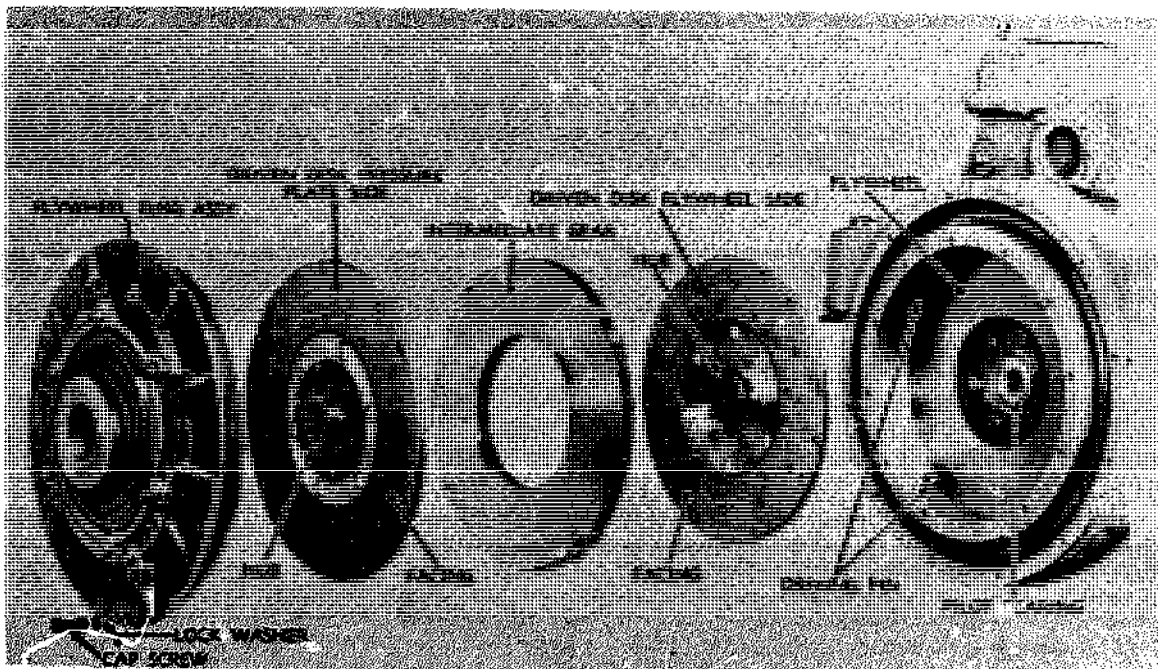


Figure 14-4.--Double disk clutch--exploded view.

81.179

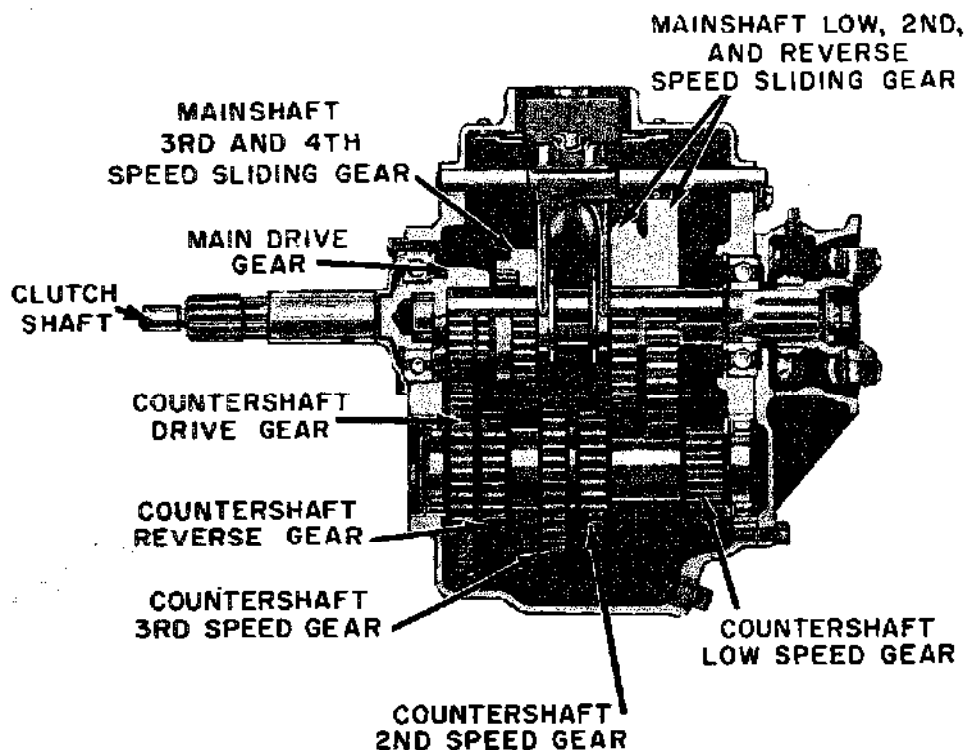


Figure 14-5.—Four-speed truck transmission.

81.181

have either constant mesh or synchromesh transmissions (explained later). However, the principles of operation and gear ratios are the same.

A review of chapter 6 of this book will help you to understand the transmissions and power transfer mechanisms described in this chapter.

#### FOUR-SPEED TRUCK TRANSMISSION

The gear shift lever positions shown in the small inset in figure 14-6 are typical of most four-speed truck transmissions. The gear shifting lever, shown at A, B, C, D, and E in the illustration, moves the position of the two shifting forks which slide on separate shafts secured in the transmission case cover. Follow the separate diagrams to learn what takes place in shifting from one speed to another. For example, as you

move the top of the gear shift lever toward the forward left position, the lower arm of the lever moves in the opposite direction to shift the gears. The fulcrum of this lever is in the transmission cover.

In shifting transmission gears it is necessary to use the clutch to disengage the engine. Improper use of the clutch will cause the gears to clash, and may damage them by breaking the gear teeth. A broken tooth or piece of metal can wedge itself between two moving gears and ruin the entire transmission assembly.

When you shift from neutral to first or low speed (A of fig. 14-6), the smallest countershaft gear engages with the largest sliding gear. Low gear moves the truck at its lowest speed and maximum power. The arrow indicates the flow of power from the clutch shaft to the propeller shaft.



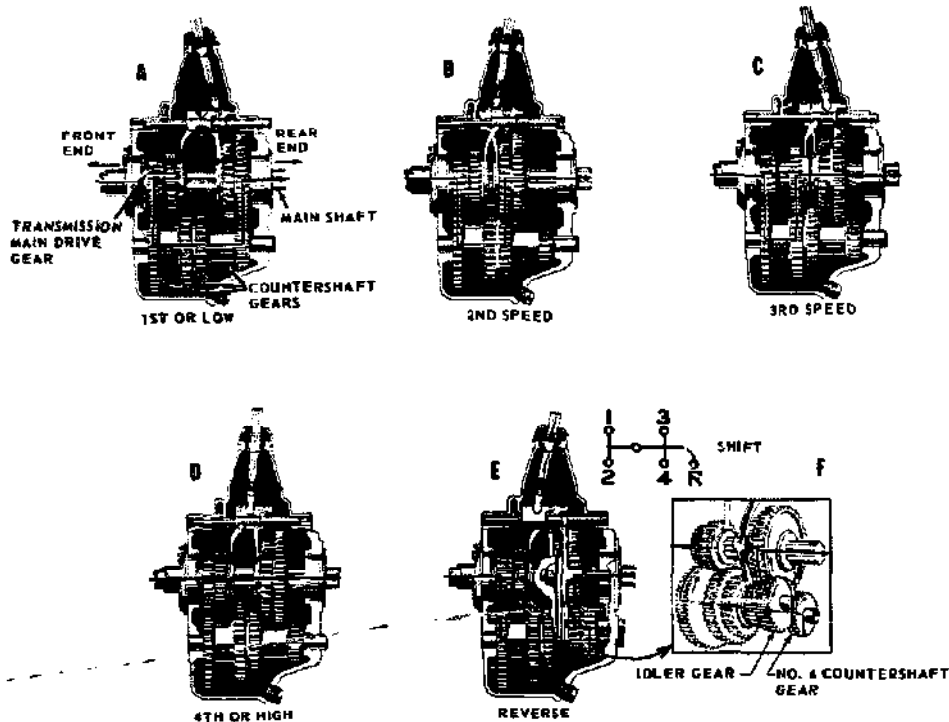


Figure 14-6.--Power flow through a 4-speed transmission.

81.182

The second speed position is obtained by moving the gear shift lever straight back from the low speed position. You will, of course, use the clutch when shifting. In B of figure 14-6 you will see that the next to the smallest countershaft gear is in mesh with the second largest sliding gear. The largest sliding gear (shift gear) has been disengaged. The flow of power has been changed as shown by the arrow. The power transmitted to the wheels in second gear (speed) is less, but the truck will move at a greater speed than it will in low gear if the engine speed is kept the same.

In shifting from the second speed to the third speed position, you move the gear shift lever through the neutral position. This is done in all selective gear transmissions. From the neutral position the driver can select the speed position required to get the power he needs. In C of figure 14-6 you will notice that the gear shift lever is in contact with the other shifting fork, and that the forward slide gear

has been meshed with the second countershaft gear. The power flow through the transmission has again been changed, as indicated by the arrow, and the truck will move at an intermediate speed between second and high.

You shift into fourth or high speed position by moving the top of the shift lever back and to the right from the neutral position. In the high speed position, the forward shift or sliding gear is engaged with the constant speed gear as shown in D of figure 14-6. The clutch shaft and the transmission shaft are now locked together and the power flow is in a straight line. In high, the truck propeller shaft revolves at the same speed as the engine crankshaft, or at a 1 to 1 ratio.

You shift to reverse by moving the top of the gear shift lever to the far right and then to the rear. Most trucks have a trigger arrangement at the gear shift ball to unlock the lever so that it can be moved from neutral to the far right. The lock prevents unintentional

shifts into reverse. Never attempt to shift into reverse until the forward motion of the vehicle has been completely stopped.

In F of figure 14-6, you can see how the idler gear fits into the transmission gear train. In E of figure 14-6, you can see what happens when you shift into reverse. An additional shifting fork is contacted by the shift lever in the far right position. When the shift to reverse is completed, this fork moves the idling gear into mesh with the small countershaft gear and the large sliding gear at the same time. The small arrows in the inset show how the engine power flows through the transmission to move the propeller shaft and the wheels in a reverse direction.

The different combination of gears in the transmission case makes it possible to change the vehicle speed while the engine speed remains the same. It is all a matter of gear ratios. That is, having large gears drive small gears, and small gears drive large gears. If a gear with 100 teeth drives a gear with 25 teeth, the small gear will travel four times as fast as the large one. You have stepped up the speed. Now, let the small gear drive the large gear, and the large gear will make one revolution for every four of the small gear. You have reduced speed, and the ratio of gear reduction is 4 to 1.

In the truck transmission just described, the gear reduction in low gear is 7 to 1 from the engine to the propeller shaft. In high gear the ratio is 1 to 1, and the propeller shaft turns at the same speed as the engine. This holds true for most transmissions. The second and third speed positions provide intermediate gear reductions between low and high. The gear ratio in second speed is 3.48 to 1, and in third is 1.71 to 1. The gear reduction or gear ratio in reverse is about the same as it is in low gear, and the propeller shaft makes one revolution for every seven revolutions of the engine.

All transmissions do not have four speeds forward, and the gear reductions at the various speeds are not necessarily the same. Passenger cars, for example, usually have only three forward speeds and one reverse speed. Their gear ratios are about 3 to 1 in both low and reverse gear combinations. You must remember, the gear reduction in the transmission is only between the engine and the propeller shaft. Another reduction gear ratio is provided in the rear axle assembly. If you have a common rear axle ratio of about 4 to 1, the gear reduction from the engine of a passenger car to the

rear wheels in low gear would be approximately 12 to 1. In high gear the ratio would be 4 to 1 as there would be no reduction of speed in the transmission.

#### CONSTANT MESH TRANSMISSION

To eliminate the noise developed in the old-type spur-tooth gears used in the sliding gear transmission, the automotive manufacturers developed the constant-mesh transmission which contains helical gears.

In this type of transmission certain countershaft gears are constantly in mesh with the main shaft gears. The main shaft meshing gears are arranged so that they cannot move endwise. They are supported by roller bearings so that they can rotate independently of the main shaft (figs. 14-7 and 14-8).

In operation, when the shift lever is moved to third, the third and fourth shifter fork moves the clutch gear (A, fig. 14-8) toward the third speed gear (D, fig. 14-8). This engages the external teeth of the clutch gear with the internal teeth of the third speed gear. Since the third speed gear is rotating with the rotating countershaft gear, the clutch gear must also rotate. The clutch gear is splined to the main shaft, and therefore the main shaft rotates with the clutch gear. This principle is carried out when the shift lever moves from one speed to the next.

Constant-mesh gears are seldom used for all speeds. Common practice is to use such gears for the higher gears, with sliding gears for first and reverse speeds, or for reverse only. When the shift is made to first or reverse, the first and reverse sliding gear is moved to the left on the main shaft. The inner teeth of the sliding gear mesh with the main shaft first gear.

#### SYNCHROMESH TRANSMISSION

The synchromesh transmission is a type of constant-mesh transmission that permits gears to be selected without clashing, by synchronizing the speeds of mating parts before they engage. It employs a combination metal-to-metal friction cone clutch and a dog or gear positive clutch to engage the main drive gear and second-speed main shaft gear with the transmission main shaft. The friction cone clutch engages first, bringing the driving and driven members to the same speed, after which the dog clutch engages easily without clashing. This process is accomplished

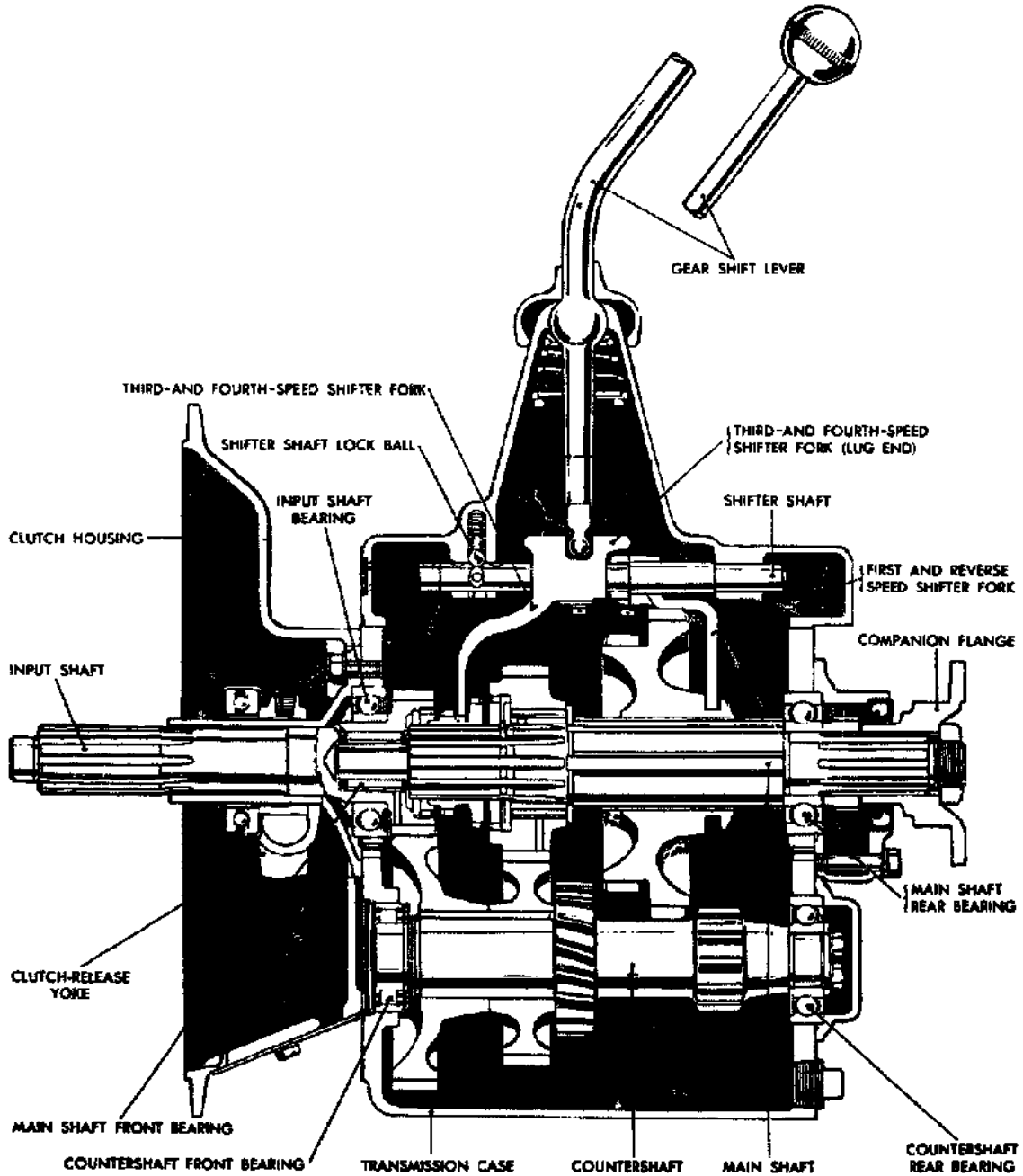
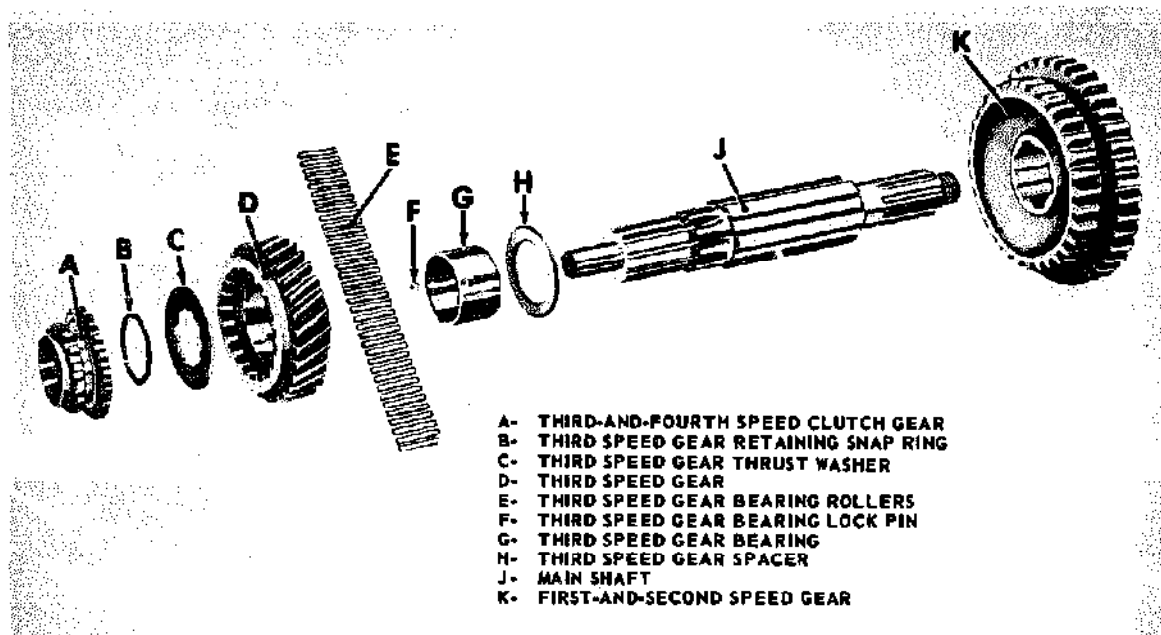


Figure 14-7.—Constant-mesh transmission assembly—sectional view.

81.183



- A- THIRD-AND-FOURTH SPEED CLUTCH GEAR
- B- THIRD SPEED GEAR RETAINING SNAP RING
- C- THIRD SPEED GEAR THRUST WASHER
- D- THIRD SPEED GEAR
- E- THIRD SPEED GEAR BEARING ROLLERS
- F- THIRD SPEED GEAR BEARING LOCK PIN
- G- THIRD SPEED GEAR BEARING
- H- THIRD SPEED GEAR SPACER
- J- MAIN SHAFT
- K- FIRST-AND-SECOND SPEED GEAR

81.184

Figure 14-8.—Disassembled main shaft assembly.

in one continuous operation when the driver declutches and moves the control lever in the usual manner. The construction of synchromesh transmissions varies somewhat with different manufacturers, but the principle is the same in all.

The construction of a popular synchromesh clutch is shown in figure 14-9. The driving member consists of a sliding gear splined to the transmission main shaft with bronze internal cones on each side. It is surrounded by a sliding sleeve having internal teeth that are meshed with the external teeth of the sliding gear. The sliding sleeve is grooved around the outside to receive the shift fork. Six spring-loaded balls in radially-drilled holes in the gear fit into an internal groove in the sliding sleeve and prevent it from moving endwise relative to the gear until the latter has reached the end of its travel. The driven members are the main drive gear and second-speed main shaft gear, each of which has external cones and external teeth machined on its sides to engage the internal cones of the sliding gear and the internal teeth of the sliding sleeve.

The synchromesh clutch operates as follows: when the transmission control lever is moved by the driver to the third-speed or direct-drive position, the shift fork moves the sliding gear and sliding sleeve forward as a unit until the internal cone on the sliding gear engages the external cone on the main drive gear. This action brings the two gears to the same speed and stops endwise travel of the sliding gear. The sliding sleeve then slides over the balls and silently engages the external teeth on the main drive gear, locking the main drive gear and transmission main shaft together as shown in figure 14-9. When the transmission control lever is shifted to the second-speed position, the sliding gear and sleeve move rearward and the same action takes place, locking the transmission main shaft to the second-speed main shaft gear. The synchromesh clutch is not applied to first speed or to reverse. First speed is engaged by an ordinary dog clutch when constant mesh is employed, or by a sliding gear; reverse is always engaged by means of a sliding gear. Figure 14-10 shows a cross section of a synchromesh transmission which uses constant-mesh helical gears for the

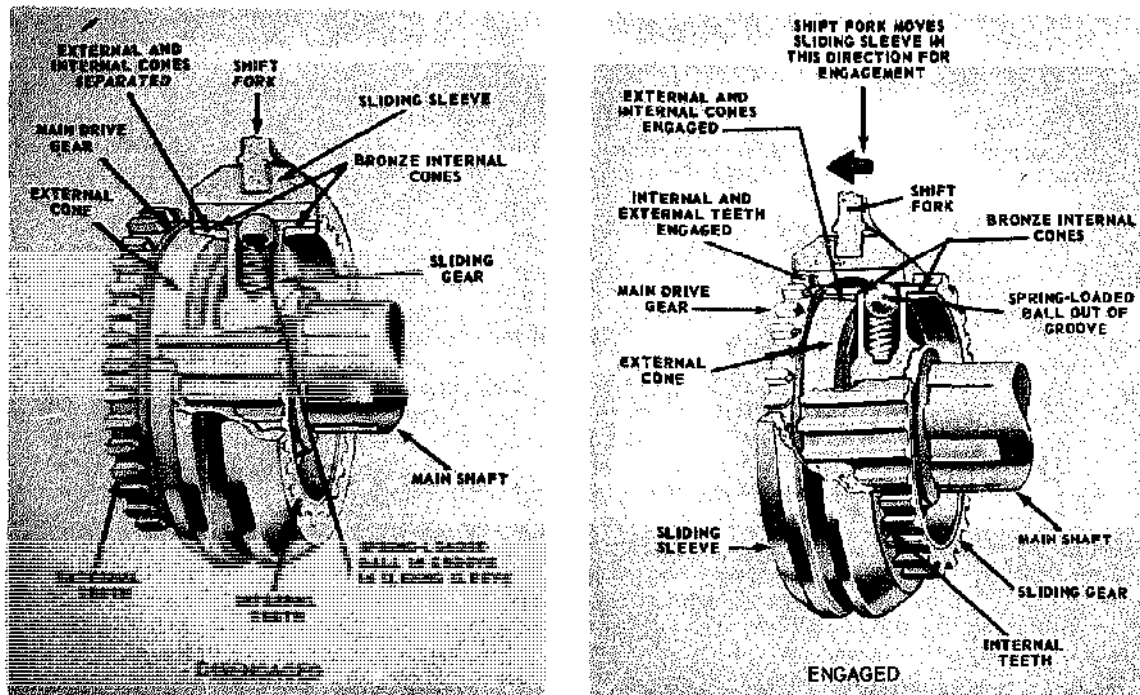


Figure 14-9.—Synchromesh clutch—disengaged and engaged.

81.185

three forward speeds and a sliding spur gear for reverse.

Some transmissions are controlled by a steering column control lever (fig. 14-11). The positions for the various speeds are the same as those for the vertical control lever except that the lever is horizontal. The shifter forks are pivoted on bellcranks which are turned by a steering column control lever through the linkage shown. The poppets shown in figure 14-10 engage notches at the inner end of each bell crank. Other types of synchromesh transmissions controlled by steering column levers have shifter shafts and forks moved by a linkage similar to those used with a vertical control lever.

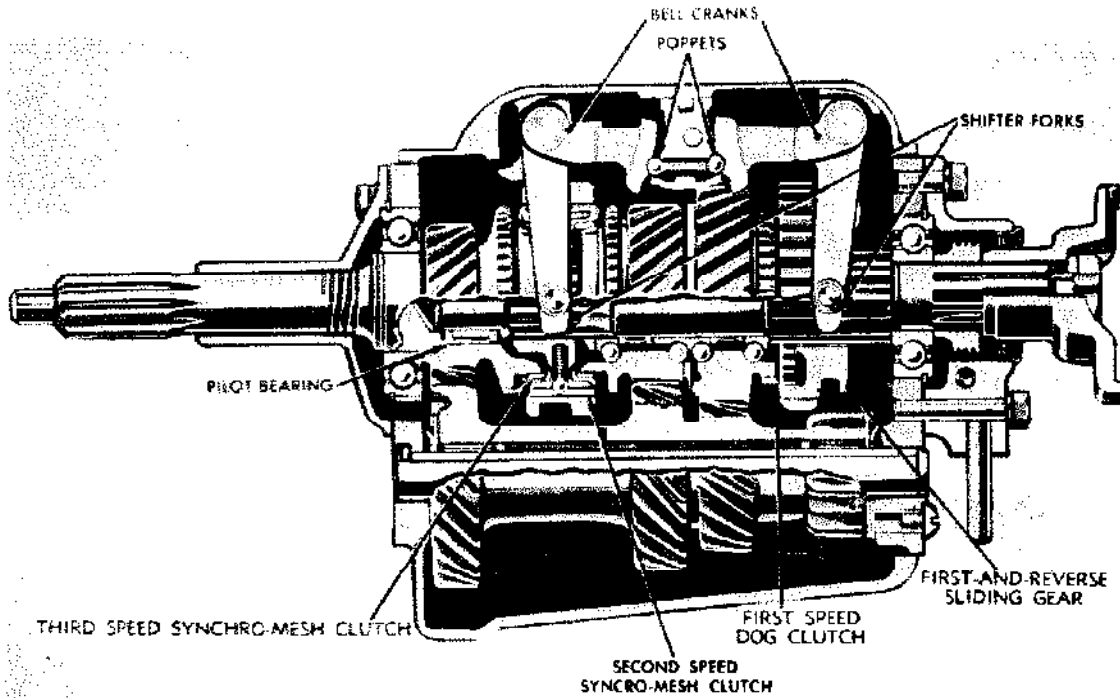
#### AUXILIARY TRANSMISSION

The auxiliary transmission allows a rather small engine to move heavy loads in trucks by increasing the engine-to-axle gear ratios. The auxiliary transmission provides a link in the

power trains of construction vehicles to divert engine power to drive 4 and 6 wheels, and also to operate accessory equipment through transfer cases and power takeoff units. (See fig. 14-12).

Trucks require a greater engine-to-axle gear ratio than passenger cars, particularly when manufacturers put the same engine in both types of equipment. In a truck, the auxiliary transmission doubles the mechanical advantage. It is connected to the rear of the main transmission by a short propeller shaft and universal joint. Its weight is supported on a frame cross-member as shown in figure 14-12. The illustration also shows how the shifting lever would extend into the driver's compartment near the lever operating the main transmission.

In appearance and in operation, auxiliary transmissions are similar to main transmissions, except that some may have two and some three speeds (low, direct and overdrive).



81.186

Figure 14-10.—Synchromesh transmission arranged for steering column control.

#### TRANSFER CASES

Transfer cases are placed in the power trains of vehicles driven by all wheels. Their purpose is to provide the necessary offsets for additional propeller shaft connections to drive the wheels.

Transfer cases in heavier vehicles have two speed positions and a declutching device for disconnecting the front driving wheels. Two speed transfer cases like the one shown in figure 14-13 serve also as auxiliary transmissions.

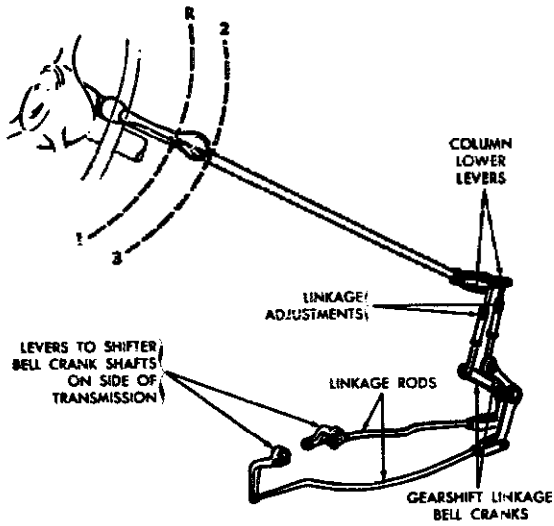
Some transfer cases are quite complicated. When they have speed changing gears, declutching devices, and attachments for three or more propeller shafts, they are even larger than the main transmission. A cross section of a common type of two-speed transfer case is shown in figure 14-14. Compare it with the actual installation in figure 14-13.

The declutching mechanism for the front wheels consists of a sliding sleeve spline clutch.

This same type of transfer case is used for a 6-wheel drive vehicle. The additional propeller shaft connects the drive shaft of the transfer case to the rearmost axle assembly. It is connected to the transfer case through the transmission brake drum.

Some transfer cases contain an overrunning sprag unit (or units) on the front output shaft. (A sprag unit is a form of overrunning clutch; power can be transmitted through it in one direction but not in the other.)

On these units the transfer is designed to drive the front axle slightly slower than the rear axle. During normal operation, when both front and rear wheels turn at the same speed, only the rear wheels drive the vehicle. However, if the rear wheels should lose traction and begin to slip, they tend to turn faster than the front wheels. As this happens, the sprag unit automatically engages so that the front wheels also drive the vehicle. The sprag unit simply provides an automatic means of engaging the



81.187

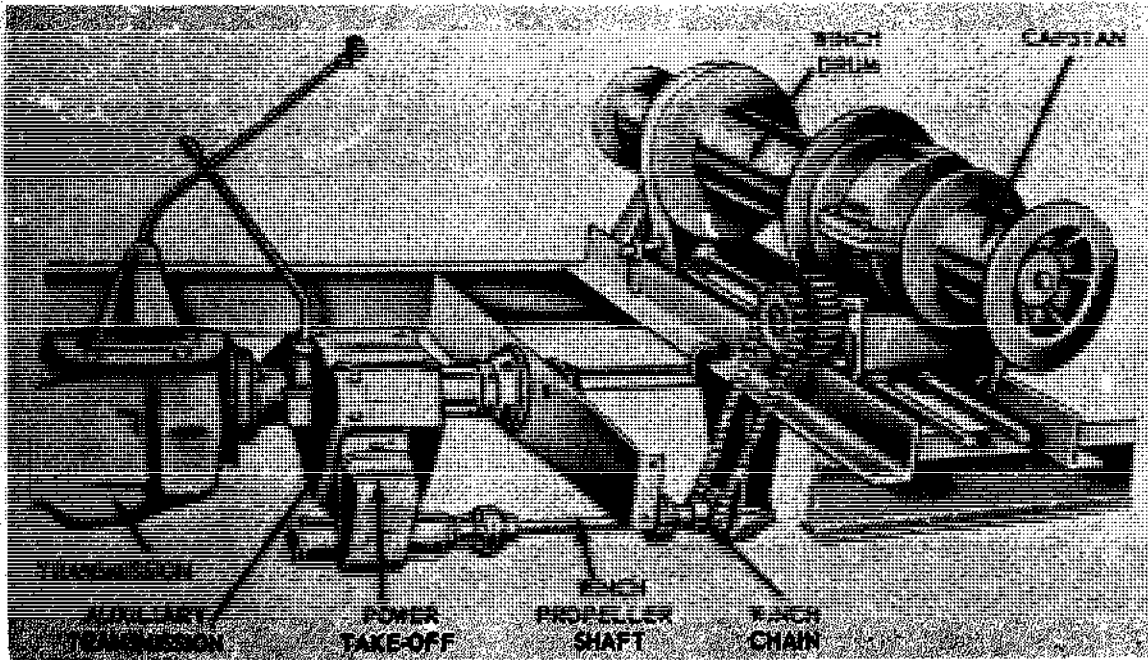
Figure 14-11.—Steering column transmission control lever and linkage.

front wheels in drive whenever additional tractive effort is required. There are two types of sprag-unit-equipped transfers, a single-sprag-unit transfer and a double-sprag-unit transfer. Essentially, both types work in the same manner.

**POWER TAKEOFFS**

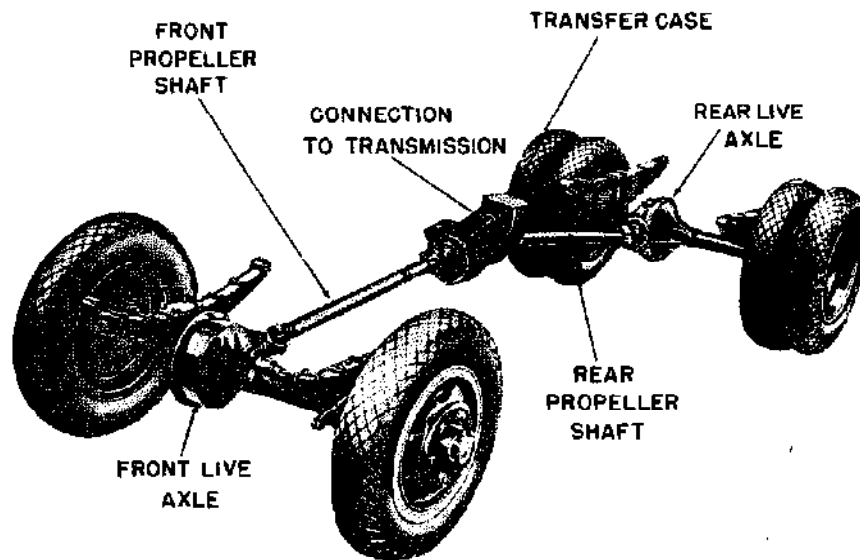
Power takeoffs are attachments in the power train for power to drive auxiliary accessories. They are attached to the transmission, auxiliary transmission, or transfer case. A common type of power takeoff is the single-gear, single-speed type shown in figure 14-15. This unit is bolted to an opening provided in the side of the transmission case as shown in figure 14-12. The sliding gear of the power takeoff will then mesh with the transmission countershaft gear. The operator can move a shifter shaft control lever to slide the gear in and out of mesh with the counter shaft gear. The spring-loaded ball holds the shifter shaft in position.

On some vehicles you will find power takeoff units with gear arrangements that will give



81.188

Figure 14-12.—Auxiliary transmission power takeoff driving winch.



81.190

Figure 14-13.—Transfer case installed in a 4-wheel drive truck.

two speeds forward and one in reverse. Several forward speeds and a reverse gear arrangement are usually provided in power take-off units which operate winches and hoists. Their operation is about the same as the single speed units.

#### PROPELLER SHAFT ASSEMBLIES

The propeller shaft assembly consists of a propeller shaft, a slip joint, and one or more universal joints. This assembly provides a flexible connection through which power is transmitted from the transmission to the live axles.

The propeller shaft may be solid or tubular. A solid shaft is somewhat stronger than a hollow or tubular shaft of the same diameter, but a hollow shaft is stronger than a solid shaft of the same weight. Solid shafts are generally used inside of a shaft housing that encloses the entire propeller shaft assembly. These are called torque tube drives.

A slip joint is provided at one end of the propeller shaft to take care of end play. The driving axle, being attached to the springs, is

free to move up and down while the transmission is attached to the frame and cannot move. Any upward or downward movement of the axle, as the springs are flexed, shortens or lengthens the distance between the axle assembly and the transmission. To compensate for this changing distance, the slip joint is provided at one end of the propeller shaft.

The usual type of slip joint consists of a splined stub shaft, welded to the propeller shaft, which fits into a splined sleeve in the universal joint. A cross-sectional view of the slip joint and universal joint is shown in figure 14-16.

A universal joint is a connection between two shafts that permits one to drive the other at an angle. Passenger vehicles and trucks usually have universal joints at both ends of the propeller shaft.

Universal joints are double-hinged with the pins of the hinges set at right angles. They are made in many different designs, but they all work on the same principle. (See chapter 11.)

#### FINAL DRIVES

A final drive is that part of the power train that transmits the power delivered through the



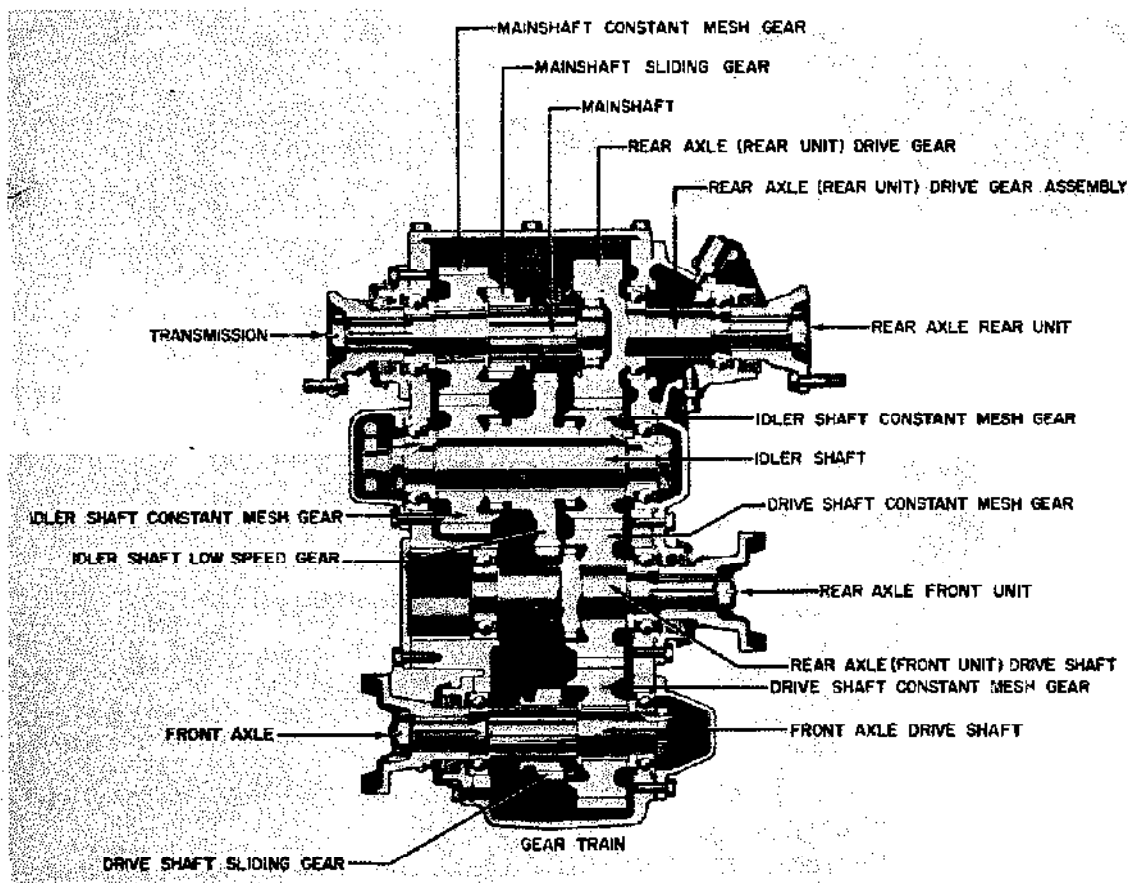


Figure 14-14.—Cross section of a 2-speed transfer case.

81.191

propeller shaft to the drive wheels or sprockets. Because it is encased in the rear axle housing, the final drive is usually referred to as a part of the rear axle assembly. It consists of two gears called the ring gear and pinion. These may be spur, spiral, or hypoid beveled gears, or wormgears, as illustrated in figure 14-17.

The function of the final drive is to change by 90 degrees the direction of the power transmitted through the propeller shaft to the driving axles. It also provides a fixed reduction between the speed of the propeller shaft and the axle shafts and wheels. In passenger cars this

reduction varies from about 3 to 1 to 5 to 1. In trucks, it can vary from 5 to 1 as much as 11 to 1.

The gear ratio of a final drive having bevel gears is found by dividing the number of teeth on the drive gear by the number of teeth on the pinion. In a worm gear final drive, the gear ratio is found by dividing the number of teeth on the gear by the number of threads on the worm.

Most final drives are of the gear type. Hypoid gears are used in passenger cars and light trucks to give more body clearance. They permit the bevel drive pinion to be placed below the center of the bevel drive gear, thereby

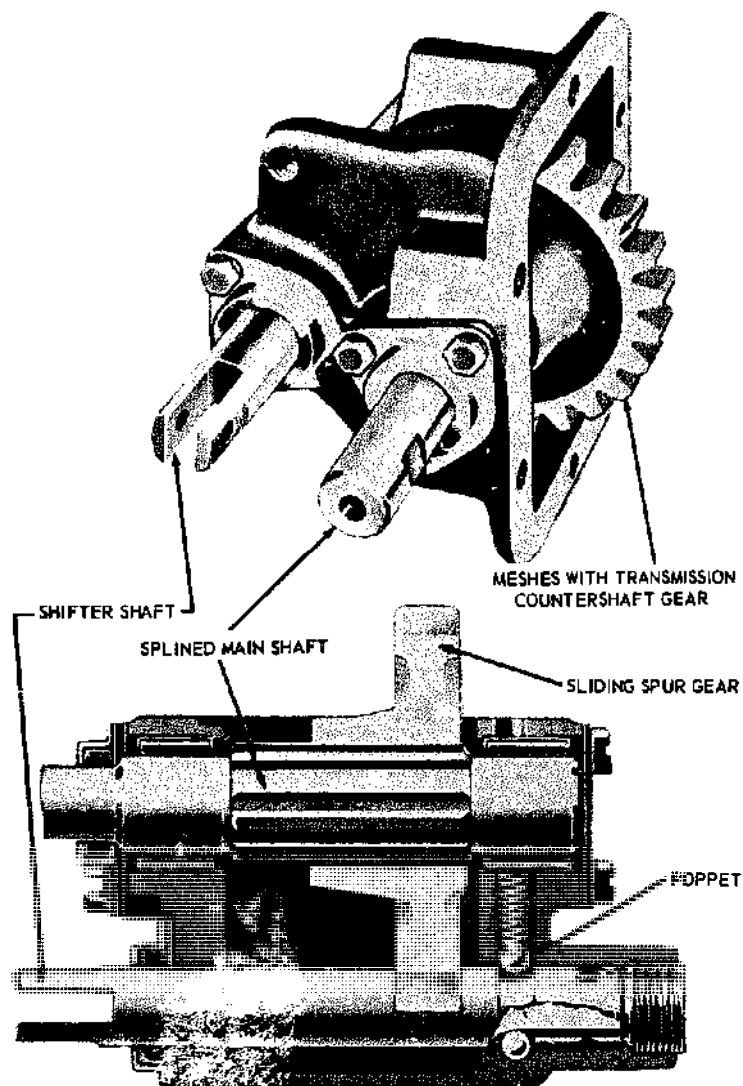


Figure 14-15.—Single speed, single gear, power takeoff.

81.192

lowering the propeller shaft (see fig. 14-17). Worm gears allow a large speed reduction and are used extensively in the larger trucks. Spiral bevel gears are similar to hypoid gears. They are used in both passenger cars and trucks to replace spur gears that are considered too noisy.

#### DIFFERENTIALS

The construction and principles of operation of the gear differential were described in chapter 11 of this book. We will briefly review some of the high points of that chapter here, and then go on to describe some of the more common types

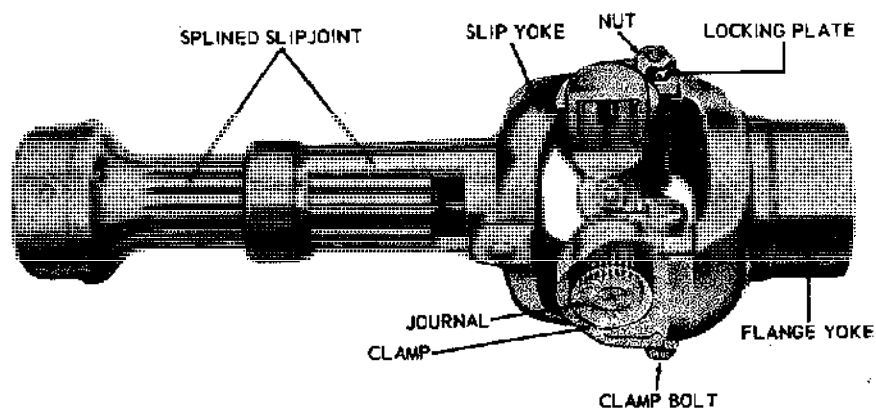


Figure 14-16.—Slip joint and common type of universal joint.

2.200

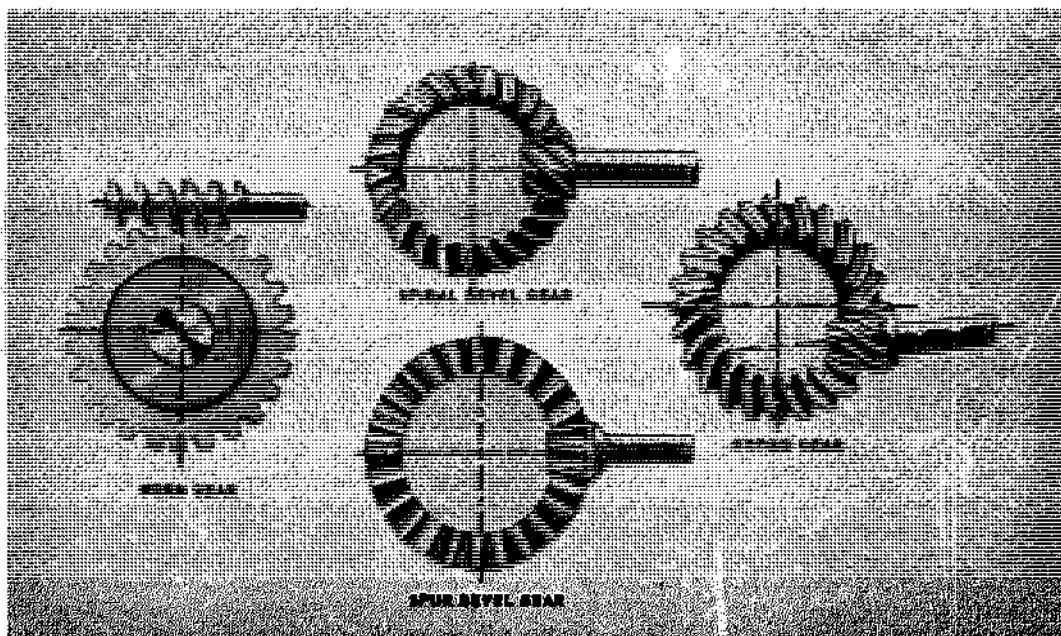
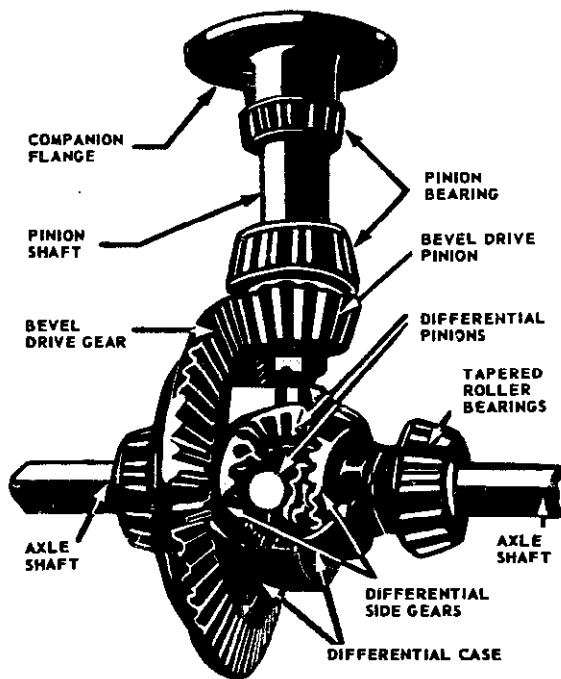


Figure 14-17.—Gears used in final drives.

81.195

of gear differentials as applied in automobiles and trucks.

The purpose of the differential is easy to understand when you compare a vehicle to a company of men marching in mass formation. When the company makes a turn, the men in the inside file must take short steps, almost marking time, while men in the outside file must take long steps and walk a greater distance to make the turn. When a motor vehicle turns a corner, the wheels on the outside of the turn must rotate faster and travel a greater distance than the wheels on the inside. This causes no difficulty for front wheels of the usual passenger car because each wheel rotates independently on opposite ends of a dead axle. However, in order to drive the rear wheels at different speeds, the differential is needed. It connects the individual axle shaft for each wheel to the bevel drive gear. Therefore, each shaft can turn at a different speed and still be driven as a single unit. Refer to the illustration in figure 14-18 as you study the following discussion on differential operation.



81.196

Figure 14-18.—Differential with part of case cut away.

The differential described in chapter 11 had two inputs and a single output. The differential as used in the automobile, however, has a single input and two outputs, the input being introduced from the propeller shaft, and the outputs going to the rear axles and wheels. In this discussion, the "spider gears" are referred to as "differential pinions," so don't let this confuse you.

The bevel drive pinion, connected to the propeller shaft, drives the bevel drive gear and the differential case to which it is attached. Therefore, the entire differential case always rotates with the bevel drive gear whenever the propeller shaft is transmitting rotary motion. Within the case, the differential pinions are free to rotate on individual shafts called trunnions. These trunnions are attached to the walls of the differential case, so that whenever the case is turning, the differential pinions must revolve—one about the other—in the same plane as the bevel drive gear.

The differential pinions mesh with the side gears, as did the spider and side gears in the differential described in chapter 11. The axle shafts are splined to the side gears and keyed to the wheels. Power is transmitted to the axle shafts through the differential pinions and the side gears. When resistance is equal on each rear wheel, the differential pinions, side gears, and axle shafts all rotate as one unit with the bevel drive gear. In this case, there is no relative motion between the pinions and the side gears in the differential case. That is, the pinions do not turn on the trunnions, and their teeth will not move over the teeth of the side gears.

When the vehicle turns a corner, one wheel must turn faster than the other. The side gear driving the outside wheel will run faster than the side gear connected to the axle shaft of the inside wheel. To compensate for this difference in speed, and to remain in mesh with the two side gears, the differential pinions must then turn on the trunnions. The average speed of the two side gears, axle shafts, or wheels is always equal to the speed of the bevel drive gear.

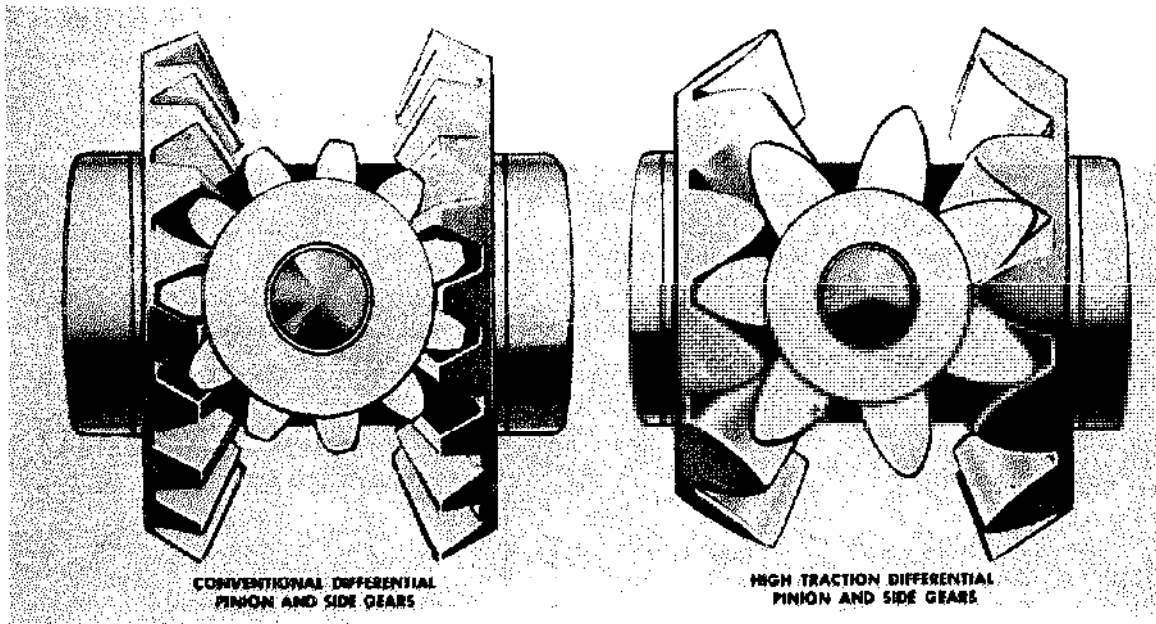
To overcome the situation where one spinning wheel might be undesirable, some trucks are provided with a differential lock. This is a simple dog clutch, controlled manually or automatically, which locks one axle shaft to the differential case and bevel drive gear. Although this device forms a rigid connection between the two axle shafts and makes both wheels rotate at

the same speed, it is used very little. Too often the driver forgets to disengage the lock after using it. There are, however, automatic devices for doing almost the same thing. One of these, which is rather extensively used today, is the high-traction differential. It consists of a set of differential pinions and side gears which have fewer teeth and a different tooth form from the conventional gears. Figure 14-19 shows a comparison between these and standard gears. These differential pinions and side gears depend on a variable radius from the center of the differential pinion to the point where it comes in contact with the side gear teeth, which is, in effect, a variable lever arm. As long as there is relative motion between the pinions and side gears, the torque is unevenly divided between the two driving shafts and wheels; whereas, with the usual differential, the torque is evenly divided at all times. With the high-traction differential, the torque becomes greater on one wheel and less on the other as the pinions move around, until both wheels start to rotate at the same speed. When this occurs, the relative motion between the pinion and side gears stops and the

torque on each wheel is again equal. This device assists considerably in starting the vehicle or keeping it rolling in cases where one wheel encounters a slippery spot and loses traction while the other wheel is on a firm spot and has traction. It will not work, however, when one wheel loses traction completely. In this respect it is inferior to the differential lock.

With the no-spin differential (fig. 14-20), one wheel cannot spin because of loss of tractive effort and thereby deprive the other wheel of driving effort. For example, one wheel is on ice and the other wheel is on dry pavement. The wheel on ice is assumed to have no traction. However, the wheel on dry pavement will pull to the limit of its tractional resistance at the pavement. The wheel on ice cannot spin because wheel speed is governed by the speed of the wheel applying tractive effort.

The no-spin differential does not contain pinion gears and side gears as does the conventional differential. Instead, it consists essentially of a spider attached to the differential drive ring gear through four trunnions, plus two driven clutch members with side teeth that are



81.197

Figure 14-19.—Comparison of high-traction differential gears and standard differential gears.

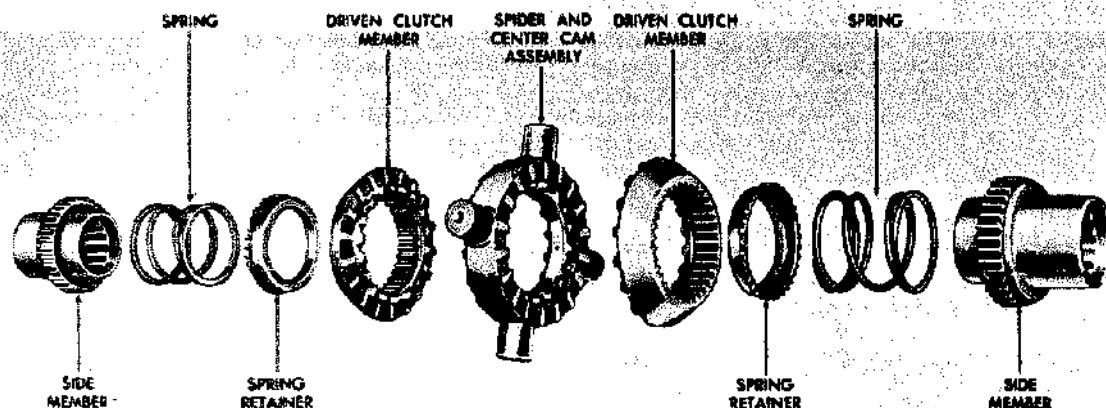


Figure 14-20.—No spin differential—exploded view.

81.198

indexed by spring pressure with side teeth in the spider. Two side members are splined to the wheel axles and in turn are splined into the driven clutch members.

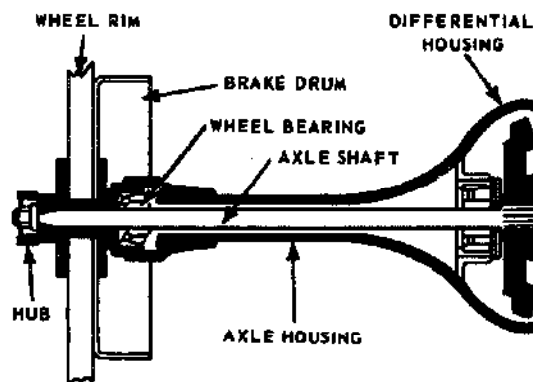
axle shafts in this assembly are called nonfloating because they are supported directly in bearings located in the center and ends of the axle housing. In addition to turning the wheels, these shafts carry the entire load of the vehicle on their outer ends. Plain axes also support the weight of the differential case.

AXLES

A live axle is one that supports part of the weight of a vehicle and also drives the wheels connected to it. A dead axle is one that carries part of the weight of a vehicle but does not drive the wheels. The wheels rotate on the ends of the dead axle.

The semifloating axle (fig. 14-21) that is used on most passenger cars and light trucks

Usually, the front axle of a passenger car is a dead axle and the rear axle is a live axle. In 4-wheel drive vehicles, both front and rear axles are live axles, and in 6-wheel drive vehicles, all three axles are live axles. The third axle, part of a bogie drive, is joined to the rearmost axle by a trunnion axle. The trunnion axle is attached rigidly to the frame. Its purpose is to help in distributing the load on the rear of the vehicle to the two live axles which it connects.



There are four types of live axles used in automotive and construction equipment. They are: plain, semifloating, three-quarter floating, and full floating.

The plain live axle, or nonfloating rear axle, is seldom used in equipment today. The

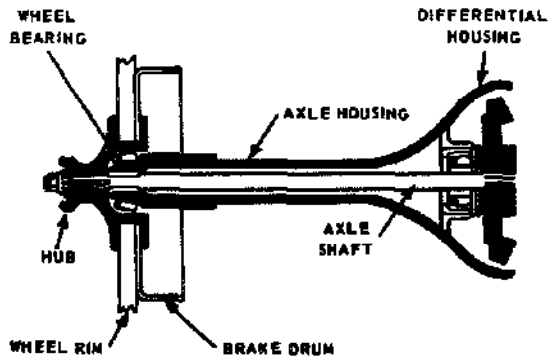
Figure 14-21.—Semifloating rear axle.

81.200

has its differential case independently supported. The differential carrier relieves the axle shafts from the weight of the differential assembly and the stresses caused by its operation. For this reason the inner ends of the axle shafts are said to be floated. The wheels are keyed to outer ends of axle shafts and the outer bearings are between the shafts and the housing. The axle shafts therefore must take the stresses caused by turning, skidding, or wobbling of the wheels. The axle shaft in a semifloating live axle can be removed after the wheel has been pulled off.

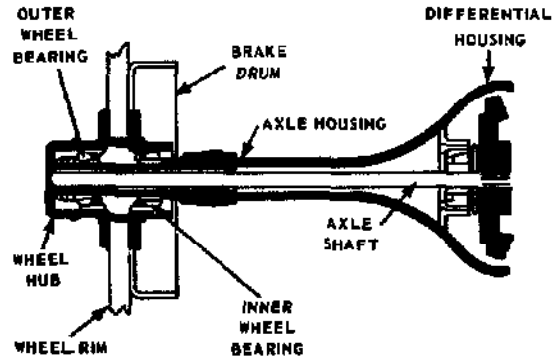
The axle shafts in a three-quarter floating axle (fig. 14-22) may be removed with the wheels, which are keyed to the tapered outer ends of the shafts. The inner ends of the shafts are carried as in a semifloating axle. The axle housing, instead of the shafts, carries the weight of the vehicle because the wheels are supported by

bearings on the outer ends of the housing. However, axle shafts must take the stresses caused by the turning, skidding, and wobbling of the wheels. Three-quarter floating axles are used in some trucks but in very few passenger cars. The full floating axle is used in most heavy trucks. (See fig. 14-23). These axle shafts may be removed and replaced without removing the wheels or disturbing the differential. Each wheel is carried on the end of the axle tube on two ball bearings or roller bearings and the axle shafts are not rigidly connected to the wheels. The wheels are driven through a clutch arrangement or flange on the ends of the axle shaft which is bolted to the outside of the wheel hub. The bolted connection between axle and wheel does not make this assembly a true full floating axle, but nevertheless, it is called a floating axle. A true full floating axle transmits only turning effort, or torque.



81.201

Figure 14-22.—Three-quarter floating rear axle.



81.202

Figure 14-23.—Full floating rear axle.

## CHAPTER 15

# BASIC COMPUTER MECHANISMS

We have already studied several examples of complex machines in the preceding chapters to learn how simple machines and basic mechanisms are utilized in their design. The analog computer, of the kind used in modern fire control systems, is a complex machine in every sense of the word. We will not attempt in this book to break down and analyze a complete computer. We will, however, examine a few of the special devices commonly used in computers. These devices have come to be known as basic computer mechanisms. They are, however, quite complex machines in themselves—as you'll soon agree. Like the engine, the typewriter, and the other machines we've studied, these mechanisms are only combinations of simple machines cleverly designed to do a specific kind of work. As before, the watchword is *Look For the Simple Machines*.

### DIFFERENTIALS

The differentials used in the analog computer are gear differentials similar to those described in chapter 11. They are different from the automobile differential in that instead of receiving a single input and delivering two outputs, they receive two inputs and combine them into a single output. Most of the differentials in a computer are quite small, averaging about 2" x 2 1/2" in size, and are designed for light loads. Some computers may have as many as 150 gear differentials in their makeup.

Figure 15-1 illustrates the symbol used to indicate the differential in schematic drawings. The cross in the center represents the spider. The arrows pointing inward represent inputs, and the arrow pointing outward is the output.

Figure 15-2 shows one of the many applications of the gear differential in a computer. In this case, the differential is being used as an integral part of a followup control. Computing mechanisms are not designed to drive heavy

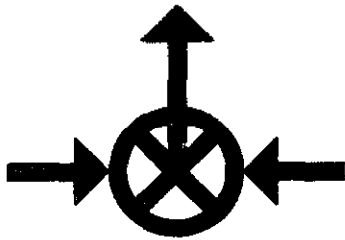
loads. The outputs from such mechanisms often merely control the action of servomotors. The motors do the actual driving of the loads to be handled. The device which makes it possible for the comparatively weak output from a computing mechanism to control the action of a servomotor is called a followup control. In this device, the differential is used to measure the difference, or "error," in position between the input and the output. The input is geared to one side of the differential. The servo output is used to do two things: (1) to position whatever mechanism is being handled, and (2) to drive the other side of the differential. This second operation is known as the servo "response."

When there is a difference between the input and the output, the spider of the differential turns. As this happens, the spider shaft operates a set of controls which control the action of the servomotor in such a way that the motor drives its side of the differential in a direction opposite to that taken by the input. That is, the servo always drives to reduce the difference, or error, to zero.

### LINKAGES FOR ADDING AND SUBTRACTING

Addition of two quantities is performed in the linkage mechanism by means of adding levers as shown in figure 15-3. In the example two quantities, designated X and Y, are to be added. Their values are represented by the movements of the two slide bars. The adding lever is pivoted at its center to another slide bar, and its opposite ends are connected through links to the X and Y slides. To illustrate the problem, scales showing the values of the quantities represented by movements of slides have been drawn in the figure, and index marks are placed on the slides. The units on the center scale are half as large as those on the other two.





12.87

Figure 15-1.—This is the symbol used to indicate the differential in schematic drawings.

If the Y slide is held in place and the X slide is moved, the adding lever pivots about its lower end. The center slide, which is connected to the midpoint of the lever then moves half as far as the X slide. If the X movement is one unit, the center slide also moves one unit since the units on the center scale are half as large as those on the X scale. Similarly, movements of the Y slide with the X slide held in place add one unit on the center scale for each unit movement of

Y. At the left of figure 15-3, the parts are shown in zero position, with the three index marks opposite the zero points of the scales. At the right, the X slide has been moved one unit, and the Y slide has been moved three.

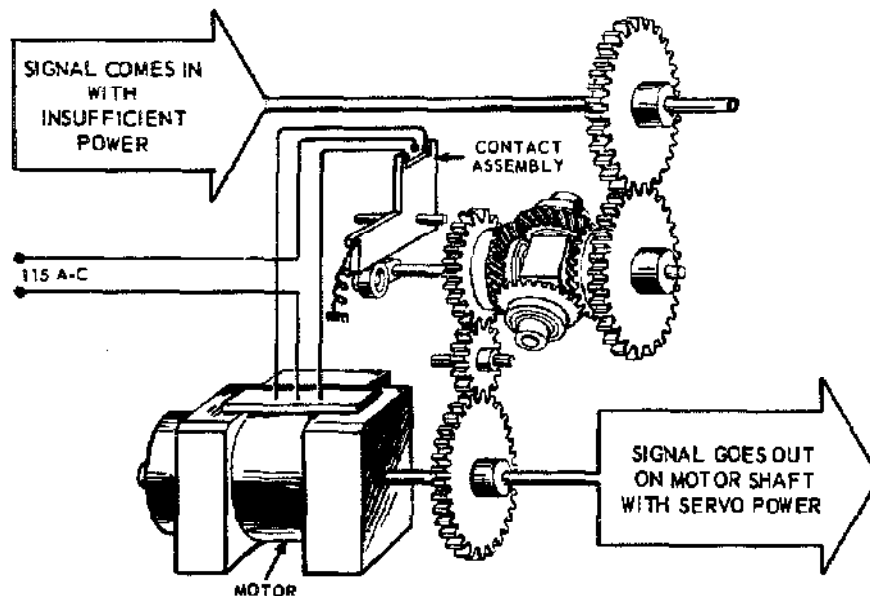
The center slide has traveled one unit in response to the X-travel and three more in response to the Y-travel, and so stands at a reading of four. Similarly, for any position of the X and Y slides, the reading on the center scale represents the quantity X plus Y.

There are several variations of the adding lever used in computing linkage, but their operating principles are the same.

### MECHANICAL MULTIPLIERS

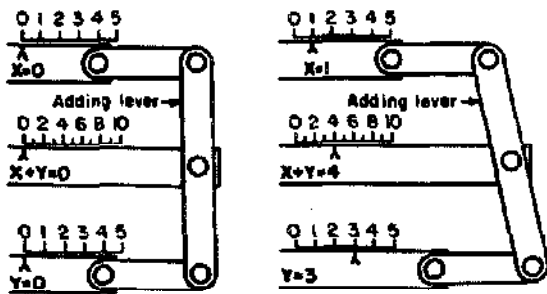
There are two basic types of mechanical multipliers—those using rotary gearing and those using linkages.

The rotary gearing type produces a solution through the use of similar triangles. There are four types of rotary multipliers in use—screw, rack, sector, and cam. Since they all operate in fundamentally the same manner, we will discuss the screw type multiplier and then compare the other types to it.



110.9

Figure 15-2.—Simplified sketch of a followup control showing application of a gear differential.

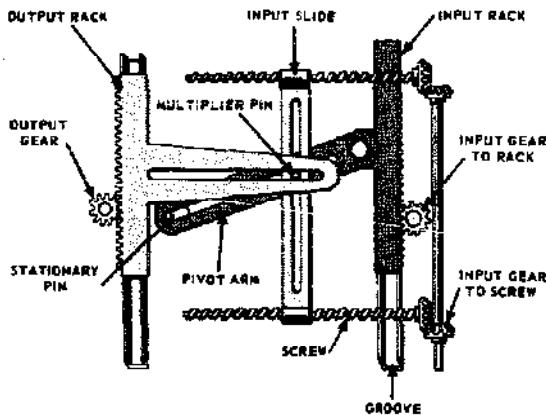


12.88

Figure 15-3.—Adding lever.

The screw multiplier, shown in figure 15-4, has two inputs and one output. The inputs are shaft values which position the input slide and input rack. The output appears at the output rack which positions the output shaft. Thus the output shaft value is always proportional to the product of the two inputs.

One input gearing is connected to two long screws. These screws pass through the threaded sleeve-like ends of the slotted input slide. As the input gears to the screws are rotated, the two screws turn to move the slide to the left or right. At the same time, the other input moves the input rack up or down, moving the slotted pivot arm around the stationary pin.



12.91

Figure 15-4.—Screw type multiplier.

The multiplier pin is mounted in the slots of the input slide, pivot arms, and output rack, connecting all three where the slots cross. As the multiplier pin moves the input slide and pivot arm, it positions the output rack and gear.

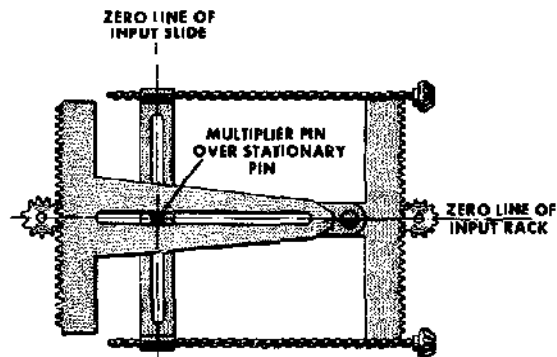
Now, consider the multiplier in the zero position shown in figure 15-5. If only the screws are rotated, the input slide moves to the right; but it will not affect the output rack. Similarly, if only the input rack is moved up or down from the zero position, the output rack will be unaffected. This is a reasonable result, for any number multiplied by zero is equal to zero.

From this we can conclude that both inputs must be removed from the zero position for an output. Such a condition is shown in figure 15-6. Notice the triangle superimposed on the device. The value a represents the amount of rack input. The value b represents the amount of slide input. K is a fixed distance, since the multiplier pin cannot move and the input rack travels in a machined guide.

Because the angles are equal, the triangles are similar. Thus the value of X can be determined if the other values are known.

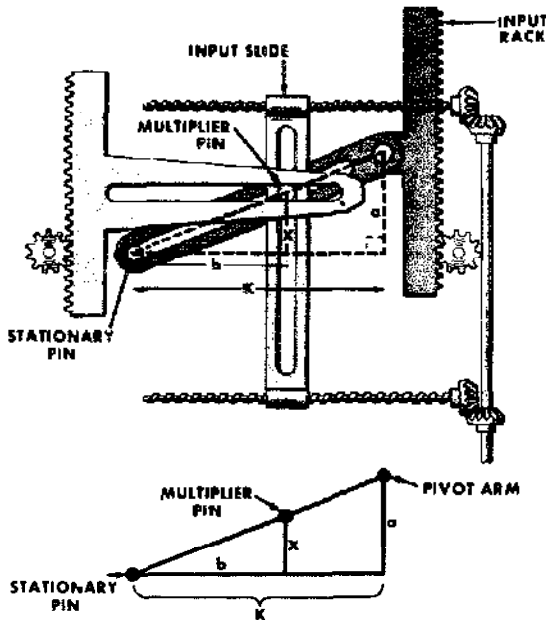
$$\text{(Actually, } X = \frac{ba}{K}\text{)}$$

This equation shows that the output (X) is always proportional to the product of the two inputs. The constant value (K) can be compensated for by the proper choice of input and output gearing for the multiplier. These



12.92

Figure 15-5.—Screw type multiplier—zero position.



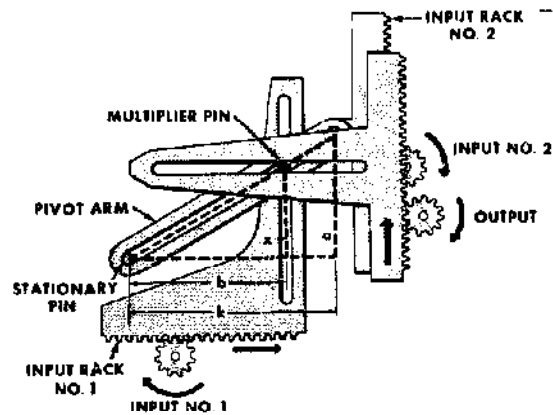
12.93

Figure 15-6.—Screw type multiplier—multiplying positive values.

multipliers can also determine the product of negative values.

The rack type multiplier in figure 15-7 performs the same task as the screw type multiplier. The differences are that (1) the screw input has been replaced with an input rack, and (2) the output rack is placed on the same side as the second input rack.

The sector type, although different in construction, also employs triangles for the multiplication of the two inputs. A sector type multiplier is shown in figure 15-8. One input positions the input sector arm and the other input turns a large screw that is mounted on the input sector arm. The bevel gear turns this lead screw through a universal joint. The use of the universal joint permits the input to drive the lead screw as the sector arm changes its angular position. Notice that the lead screw drives the multiplier pin up and down the sector arm. Thus the position of the input sector arm and the position of the multiplier on the lead screw represents the two values to be multiplied.

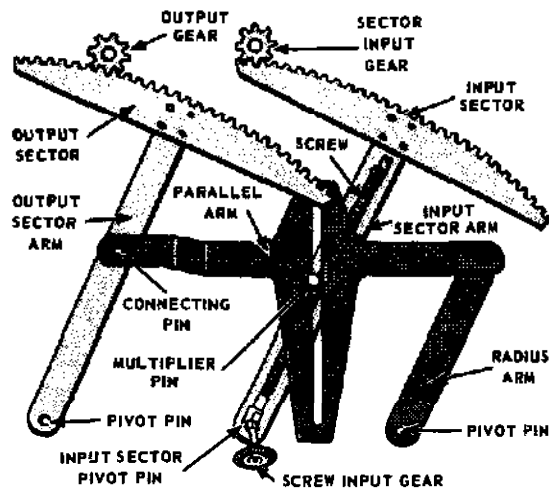


12.94

Figure 15-7.—Rack type multiplier.

A study of figure 15-9 along with figure 15-8 will reveal how the triangles are established. While the sector type multiplier can handle both positive and negative inputs on the input sector arm, the input to the lead screw must always be a positive quantity.

The cam computing multiplier is a dual operation device. It computes a function of one value on a cam and multiplies that function by a second value. It is a combination of a cam and a rack type multiplier.



12.95

Figure 15-8.—Sector type multiplier.

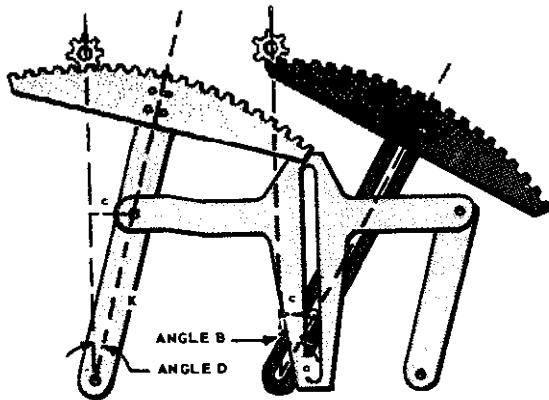


Figure 15-9.—Multiplying with the sector type multiplier. 12.96

A single cam computing multiplier is shown in figure 15-10. Notice it is like the rack type multiplier except that one of the inputs is positioned by a cam instead of a rack. The cam follower pin is mounted directly on the multiplier input slide. This cam may be cut to compute any desired function of the cam input.

One input drives the input rack through the rack input gear. The other input drives the cam

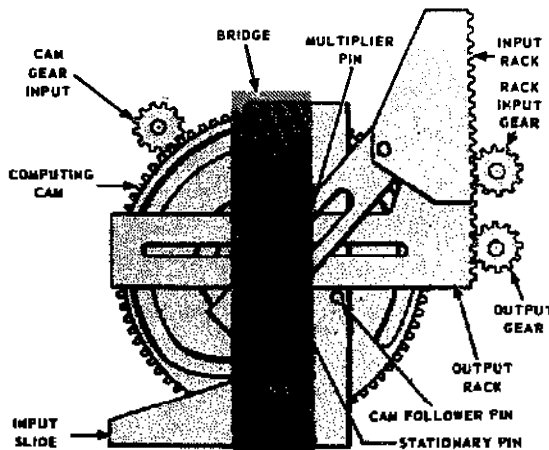


Figure 15-10.—Single cam computing multiplier. 12.97

directly. The cam positions the input slide according to the function for which the cam was cut. Thus the cam output becomes the slide input. The position of the output rack represents a value which is proportional to the product of the cam output and the rack input, just as in the rack type multiplier.

A two-cam computing multiplier computes the function of both inputs and multiplies these functions together. The output is proportional to the product of the functions of the two inputs.

Linkage multipliers of the type described here are used when one of the factors is a constant, as shown in figure 15-11. In this example we want to transform a movement representing the quantity  $X$  into one representing  $1.5X$ . One end of the multiplying lever is pivoted on the fixed frame of the computer, as indicated by the cross-hatched circle in the figure.

The input and output links are connected to the lever at different points, the connection of the output link being 1.5 times as far from the fixed pivot as the connection of the input link. The two scales shown in figure 15-11 have units of the same size; but because of the difference in lever arms, each one-unit movement of the input link moves the output link a unit and a half. Then, if the input movement represents the quantity  $X$ , the output represents  $1.5X$ .

In many cases the computing problem requires the multiplication of two variable quantities. The multiplying levers shown in figure 15-11 cannot be used for this purpose. Figure 15-12 shows a linkage designed to multiply two variables,  $X$  and  $Y$ . The levers  $AB$  and  $ED$  are pivoted on the fixed structure and are connected by links  $BC$  and  $CD$ , both of which have exactly the same length as  $AB$ . The  $X$  input is applied by a link connected at  $B$ . The  $Y$  input is applied by a link connected at  $C$ ;

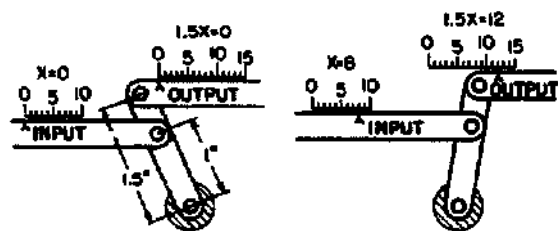


Figure 15-11.—Multiplying lever. 12.98

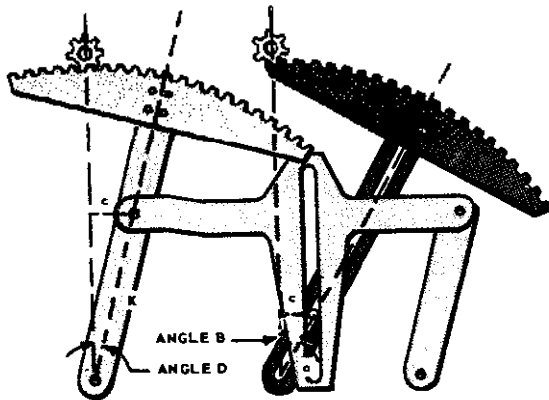


Figure 15-9.—Multiplying with the sector type multiplier. 12.96

A single cam computing multiplier is shown in figure 15-10. Notice it is like the rack type multiplier except that one of the inputs is positioned by a cam instead of a rack. The cam follower pin is mounted directly on the multiplier input slide. This cam may be cut to compute any desired function of the cam input.

One input drives the input rack through the rack input gear. The other input drives the cam

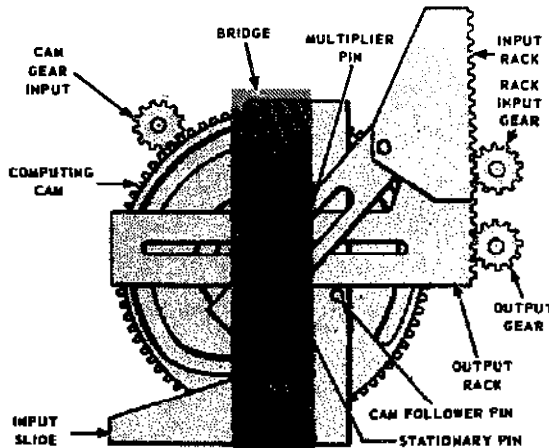


Figure 15-10.—Single cam computing multiplier. 12.97

directly. The cam positions the input slide according to the function for which the cam was cut. Thus the cam output becomes the slide input. The position of the output rack represents a value which is proportional to the product of the cam output and the rack input, just as in the rack type multiplier.

A two-cam computing multiplier computes the function of both inputs and multiplies these functions together. The output is proportional to the product of the functions of the two inputs.

Linkage multipliers of the type described here are used when one of the factors is a constant, as shown in figure 15-11. In this example we want to transform a movement representing the quantity  $X$  into one representing  $1.5X$ . One end of the multiplying lever is pivoted on the fixed frame of the computer, as indicated by the cross-hatched circle in the figure.

The input and output links are connected to the lever at different points, the connection of the output link being 1.5 times as far from the fixed pivot as the connection of the input link. The two scales shown in figure 15-11 have units of the same size; but because of the difference in lever arms, each one-unit movement of the input link moves the output link a unit and a half. Then, if the input movement represents the quantity  $X$ , the output represents  $1.5X$ .

In many cases the computing problem requires the multiplication of two variable quantities. The multiplying levers shown in figure 15-11 cannot be used for this purpose. Figure 15-12 shows a linkage designed to multiply two variables,  $X$  and  $Y$ . The levers  $AB$  and  $ED$  are pivoted on the fixed structure and are connected by links  $BC$  and  $CD$ , both of which have exactly the same length as  $AB$ . The  $X$  input is applied by a link connected at  $B$ . The  $Y$  input is applied by a link connected at  $C$ ;

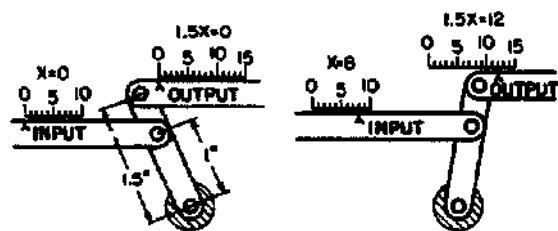


Figure 15-11.—Multiplying lever. 12.98

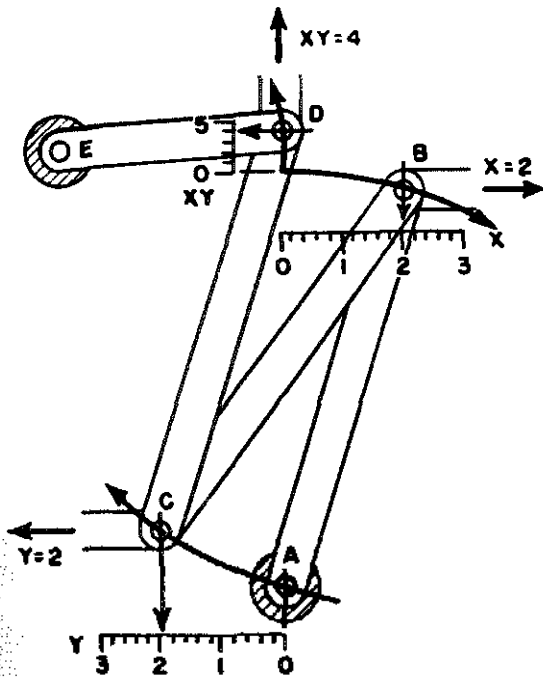


Figure 15-12.—Multiplying linkage. 12.99

and the output  $XY$  is taken off at  $D$ . In the position of the links shown in figure 15-12,  $X$  equals two units,  $Y$  equals two units, and  $XY$  equals four.

This type of linkage in the computer can be operated in reverse to serve as a divider instead of a multiplier. Two inputs are applied at the points corresponding to  $B$  and  $D$  in figure 15-12. The output taken off at  $C$  then represents the input at  $D$  divided by the input at  $B$ .

Component solvers are devices that are used in mechanical computers. The component solver takes a vector of a given magnitude and angular position, and resolves it into its two rectangular components.

There are several types of component solvers. However, this discussion will be limited to the screw type component solver. The device consists of a vector gear, two racks, two output gears, two input gears, and a screw and pin assembly. The speed input gear drives a gear train which causes the screw to turn. As the screw turns, it drives an assembly carrying the pin,

thus changing the length of the vector which is proportional to the input component, such as  $r$  (slant range). (See figure 15-13.)

In this type of component solver the pin can travel nearly the full width of the vector gear. From the pin's zero or center position it can be moved in either of two directions, which correspond to positive or negative.

The vector input gear drives the vector gear in the desired angular direction indicating target position. The pin positions the racks as it moves along the slot, thus resolving the vector into its components.

An angle resolver is a linkage mechanism which computes the sine and cosine of an angle. Figure 15-14A shows an angle resolver consisting of gear  $H$  with two crank pins  $M$  and  $N$ , mounted  $90^\circ$  apart and equidistant from the center of the gear. Attached to each crank pin is an output link which transmits the horizontal component of motion of the pin as the gear rotates. The horizontal component of the displacement of pin  $M$  is proportional to the sine of the angle through which gear  $H$  rotates. The horizontal component of pin  $N$  is proportional to the cosine of the angle through which gear  $H$  rotates.

Figure 15-14B shows the resolver in its zero position, with the radius  $OM$  perpendicular to the horizontal center line and the radius  $ON$  in the horizontal center line. Notice that link  $R$  (sine output) is at zero horizontal displacement, and that link  $S$  (cosine output) is at maximum

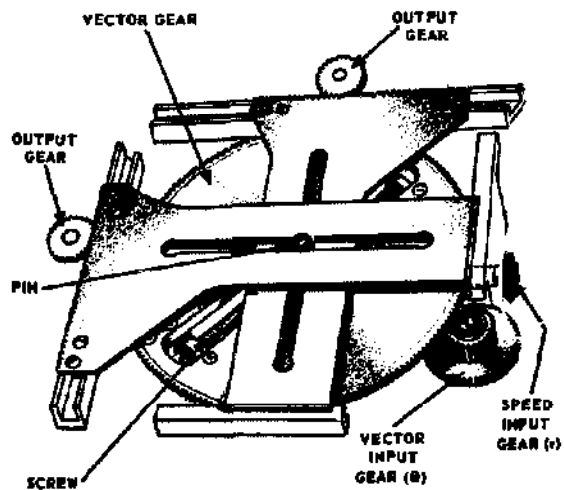


Figure 15-13.—Screw type component solver. 12.113

horizontal displacement. If we rotated gear H clockwise through an angle  $30^\circ$ , link R would move to the right and link S to the left along the horizontal center line. The linear displacement of the output links would be proportional to the sine and cosine function of the angle.

The outputs of the resolver of figure 15-14 are only approximate values. This is because the output links are not parallel to the horizontal center line. The output links have a slight angular movement that must be compensated for to eliminate distortion. This is accomplished by additional gearing, and by making the pins M and N eccentric.

Integrators, as used in computers, perform a special type of multiplication. In the disc-type integrator, illustrated in figure 15-15, a constantly changing value, such as time, is multiplied by a variable such as range rate, such as range (the rate that a target range is opening or closing), the output being a continuous value of their product which can be accumulated as shaft rotation.

The instrument consists of a flat circular disc revolved at constant speed by a motor equipped with a clock escapement; a carriage, containing two balls driven by friction with the surface of the disc, and themselves driving an output roller; and suitable shafts and gears for transmission of values to and from the unit. Rotation of the disc rotates the lower ball, which turns the upper ball, and this in turn

rotates the output roller. The balls are supported in a movable carriage so that the point of contact between the lower ball and the disc can be shifted along a diameter from the center of the disc to either edge. Spring tension on the roller provides sufficient pressure to prevent slipping. Two balls are used to reduce the sliding friction that results when only one is used.

The speed of roller rotation depends upon the speed at which the balls rotate. If the carriage is in the center of the disc, no motion is imparted to the roller. As the carriage is moved off center, the balls will begin to rotate, and will reach their maximum speed at the edge of the disc. The speed varies with the distance of the carriage from the center. Values of rotation on one side of center are considered positive, while if the carriage is moved to the opposite side, rotation will be in the opposite direction and will give negative output values.

SUMMARY

Of the many existing complex machines to choose from, you have been given only a few examples to study. The operational principles of some of them may have come to you quite easily—others may have been a bit harder to grasp. In any case, if you'll keep firmly in mind the following points that have been brought out in this book—you'll find all machines much easier to analyze and understand.

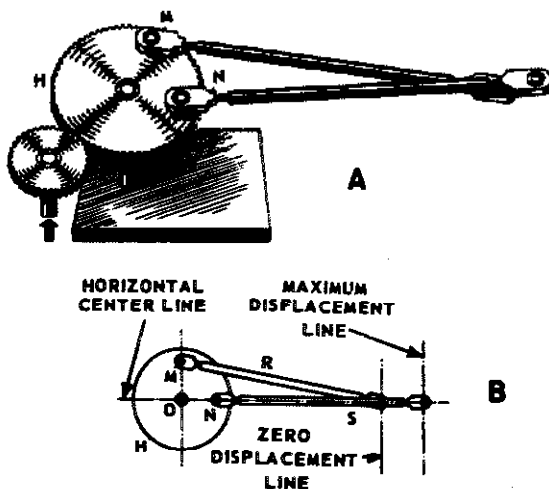
A machine is any device that helps you do work. It helps you by changing motion, magnitude, or speed of the effort you apply.

All machines consist of one or more of the six basic, or simple machines. These are the lever, the block and tackle, the wheel and axle, the inclined plane, the screw, and gears.

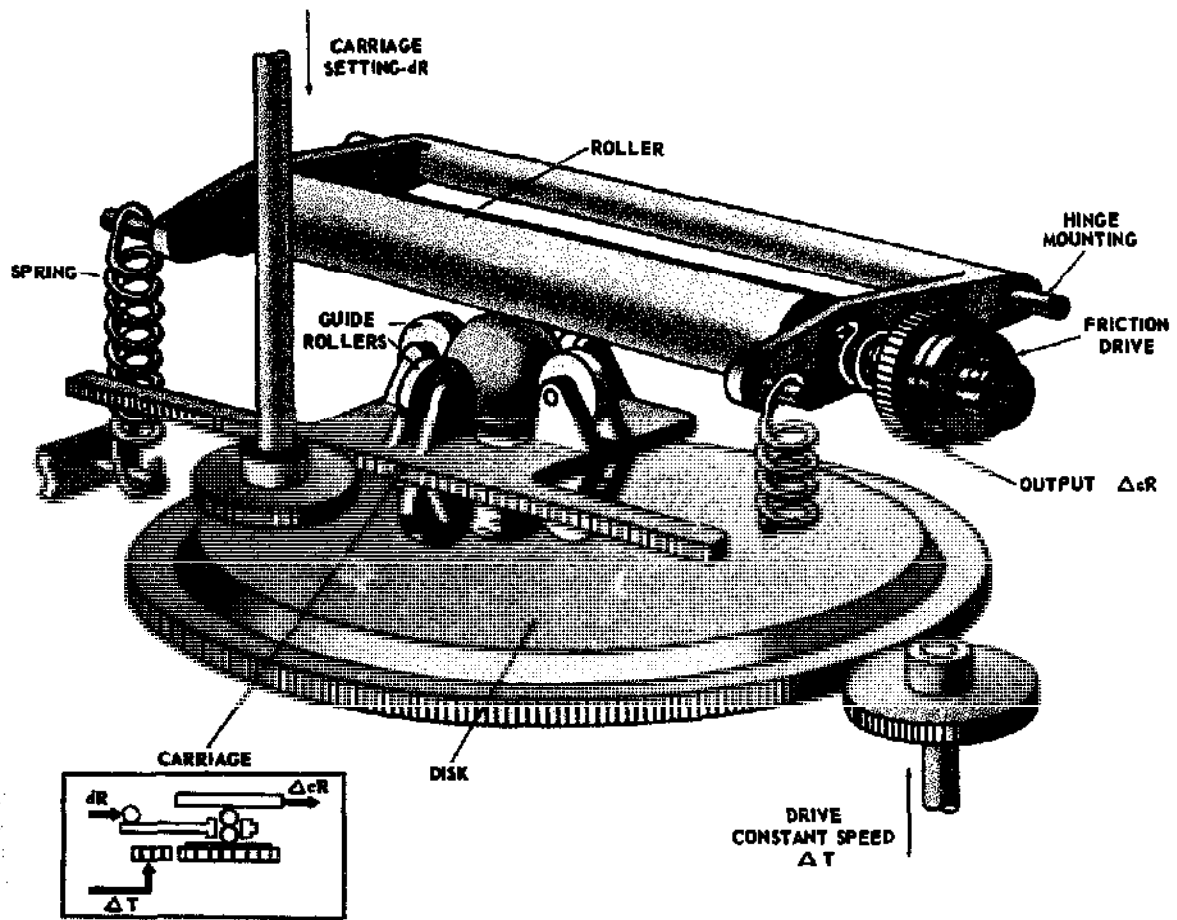
When machines give a mechanical advantage of more than one, they multiply the force of your effort. When they give a mechanical advantage of less than one, they multiply either the motion, or the speed of the force you apply.

No machine is 100 percent efficient. Some of your effort is always used to overcome friction. You always do more work on the machine than it does on the load.

You can figure out how any complex machine works by breaking it down into the simple machines from which it is made, and following the action through, step by step.



12.115  
Figure 15-14.—Basic linkage angle resolver.



110.12

Figure 15-15.—The disc type integrator.



## INDEX

- Accumulator, 67
- Anchor winch, 36, 38
- Automobile valve gear, 36
- Axles used in power trains, 148, 149
  
- Balancing moments of force, 18
- Ballast tank, 67, 68
- Ball bearings, 71, 73
- Barometer, 54-57
- Bearings, 69-73
- Bendix-Weiss universal joint, 79
- Bevel gear, 31
- Bevel gear differential, 75
- Block and tackle, 10-15, 41
  - applications afloat and ashore, 13
  - chain hoist, 15
  - flaghoist, 10
  - gun tackle, 11
  - luff tackle, 11
  - luff upon luff, 13, 14
  - mechanical advantage, 10, 15
  - runner, 10
  - yard and stay tackle, 13
- Bourdon gage, 53
- Brakes, 28, 63
  - friction, 28
  - hydraulic, 63
- Breech, 16-inch gun, 7
  
- Cams, 85
- Cam and cam followers, 80-82
- Cam-driven valve, 36
- Cam shaft, 36
  - of a 4-stroke cycle engine, 127
- Capstan bar, 17, 18
- Chain hoist, 15
- Chain stopper, 8
- Clockwise moments of force, 19
- Clutches, 82, 86, 130-133
  - power train, 130-133
- Combustion engines, 106-129
  - basic strokes, 108
  - classification of, 113
  - construction of, 115-129
    - auxiliary assemblies, 129
    - connecting rods, 123
    - crankcase, 117
    - crankshaft, 124
    - cylinder head, 117
    - engine cylinder block, 115
    - engine head, 126
    - exhaust manifold, 118
    - gaskets, 119
    - intake manifold, 118
    - moving parts, 119-129
    - piston assembly, 120
    - stationary parts, 115-119
    - timing gears, 128
    - valves and valve mechanisms, 126-128
    - vibration damper, 125
  - cycles, 109-112
  - development of power, 106
  - diesel engines, 114
  - gasoline engines, 114
  - multiple-cylinder engines, 112
  - one-cylinder engine, 106-112
- Complex machines, 87-105
  - computer mechanisms, 150-157
  - fuel-oil-hatch cover, 87
  - porthole closer-blanket puller-upper, 87, 88
  - typewriter, 89-105
  - watertight door, 88
- Computer mechanisms, 150-157
  - differentials, 150-151
  - linkages for adding and subtracting, 150-156
    - adding lever, 152
    - angle resolver, 156
    - component solver, 155
    - integrators, 156
    - multipliers, 151-156
    - multiplying linkage, 155
    - screw type multipliers, 152
- Constant mesh transmission, 136
- Counterclockwise moments of force, 19
- Couple, 20
- Couplings, 78-84
- Crane, electric, 7
- Curved lever arms, 5
- Cylinders used in power trains, 131
  
- Deep-sea diver, 60
- Depth charge, 59

## INDEX

- Diesel engine, 106, 114
- Differentials, gear, 144-148
- Dogs, 7
- Drill press, 9
  
- Electric crane, 7
- External combustion engine, 106, 107
- External mesh gears, 35
  
- Final drives, 142
- Flaghoist, 10
- Fluids, pressure exerted by, 52
- Force and pressure, 50-57
  - force, measurement of, 50
  - pressure, measurement of, 50-56
    - barometers, 54-56
    - exerted by fluids, 52
    - gages, 53
    - manometer, 56
    - scales, 50, 51
- Four-speed truck transmission, 133
- Friction, 40, 42-45
- Friction brake, 28
- Fuel-oil-hatch cover, 87
- Fulcrum, 17, 19-21
  
- Gages used to measure pressure, 53
- Gangplank, 24
- Gasoline engine, 106, 114
- Gear differential, 74-78, 144-148
  - used in automobiles and trucks, 144-148
- Gears, 30-38
  - anchor winch, 36, 38
  - automobile valve gear, 36
  - cam-driven valve, 36
  - cam shaft, 36
  - changing speed, 34
  - external mesh gears, 35
  - idler gear, 35
  - internal gear, 31
  - magnifying force with, 35
  - pinion gear, 30
  - rack and pinion as a steering mechanism, 37
  - spur gear, 30
  - types of, 30-34
  - worm gears, 32
- Gear trains, 128
- Gun tackle, 11
  
- Helical gears, 30
- Herringbone gears, 31
- Hooke joint, 79
- Horsepower, 46-48
  
- Hydraulic machines, 62-68
  - advantages of, 63
  - brakes, 63
  - liquids in motion, 62
  - Pascal's law, 62
  - press, 64
  - steering with, 65
  - used on submarines, 66
- Hydraulic valve lifter, 127
- Hydrostatic machines, 58-61
  
- Idler gear, 35
- Inclined plane, 23-26
  - applications afloat and ashore, 24
  - barrel role, 23
  - gangplank, 24
  - in spiral form, 26
  - ramp, 23
  - wedge, 23
- Internal combustion engines, 106-129
  - basic strokes, 108
  - classification of, 113
  - construction of, 115-129
    - auxiliary assemblies, 129
    - connecting rods, 123
    - crankcase, 117
    - crankshaft, 124
    - cylinder head, 117
    - engine cylinder block, 115
    - engine head, 126
    - exhaust manifold, 118
    - gaskets, 119
    - intake manifold, 118
    - moving parts, 119-129
    - piston assembly, 120
    - stationary parts, 115-119
    - timing gears, 128
    - valves and valve mechanisms, 126-128
    - vibration damper, 125
- Internal gear, 31
  
- Jack, 41
- Jack screw, 26, 27
  
- Levers, 1-9
  - chain stopper, 8
  - classes of, 2
  - curved lever arm, 5
  - dogs, 7
  - drill press, 9
  - electric crane, 7
  - oars, 2
  - pelican hook, 6
  - wrecking bar, 7

## BASIC MACHINES

- Linkages, 78
- Luff tackle, 11
- Machine elements and basic mechanisms, 69-86
  - basic mechanisms, 74
  - bearings, 69-73
    - ball bearings, 73
  - cams, 80-82, 85
    - and cam followers, 80-82
  - clutches, 82, 86
  - couplings, 78-84
  - gear differential, 74-78
  - linkages, 78
  - radial-thrust roller bearing, 73
  - springs, 71-74
  - types of, 74
  - universal joints, 79-81
- Manometer, 56
- Micrometer, 27
- Moment of force, 17, 20
- Multiple-cylinder engines, 112
- Oars, 2
- Oldham coupling, 78, 80
- One-cylinder engine, 106
- Pelican hook, 8
- Pinion gear, 30
- Pointer's handwheel, 21
- Power, 46-57
  - calculation of, 46-48
  - horsepower, 46
  - motor, 48
    - Prony brake, 48
- Power takeoffs, 141
- Power trains, 130-149
  - axles, 148, 149
  - clutch, 130-133
  - differentials, 144-148
  - final drives, 142-144
  - joints, 142, 145
  - propeller shaft assemblies, 142
  - transfer cases, 140-142
  - transmission, 133-139
- Pressure and the deep sea diver, 60
- Pressure, measurement of, 50-56
  - balances, 50, 52
  - barometers, 54-56
  - exerted by fluids, 52
  - gages, 53
  - manometer, 56
  - scales, 50, 51
- Prony brake, 48
- Quadrant davit, 29
- Rack and pinion, 37
- Radial-thrust roller bearing, 71, 73
- Ramp, 23
- Rigger's vise, 28
- Roller bearing, 71, 73
- Roller bitt, 43
- Runner, 10
- Scales, 50, 51
- Schrader gage, 53
- Screw applications, 26-29
  - friction brake, 28
  - inclined plane in spiral form, 26
  - jack screw, 26, 27
  - mechanical advantage of, 29
  - micrometer, 26
  - quadrant davit, 29
  - rigger's vise, 28
  - turnbuckle, 28
- Sleeve coupling, 78
- Spider gears, 76
- Spiral bevel gears, 144
- Springs, 71-74
- Spur gears, 30
- Steam engine, 106
- Synchromesh clutch, 138
- Synchromesh transmission, 136
- Timing gears in engines, 128
- Torpedo, 60
- Torque, 17, 21, 22
  - wrench, 21
- Transfer cases, 140-142
- Truck transmission, 133
- Turnbuckle, 28
- Typewriter, 89-105
  - backspace, 96
  - bell ringer, 102
  - construction and operation, 90
  - escapement, 92
  - external parts, 89
  - line lock, 102
  - line space, 103
  - pinion stop slide, 103-105
  - ribbon drive, 93-96
  - shift, 98, 101, 102
  - tabulator, 96-99
  - type bar, 93
- Universal joints, 79-81
- Valve lifters, 127
- Valves and valve mechanisms, engine, 126-128

## INDEX

---

Watertight door, 88

Wedge, 23

Wheel and axle, 16-25

balancing moments of force, 18

capstan bar, 17, 18

clockwise moments of force, 19

counterclockwise moments of  
force, 19

couple, 20

fulcrum, 17, 19, 20, 21

mechanical advantage, 16

pointer's handwheel, 21

rotation, 17

torque, 17, 21, 22

wrench, 21

Work, friction, and efficiency, 39-45

block and tackle, 41

friction, 42-45

jack, 41

measurement of, 39-41

roller bitt, 43

Worm and worm wheel, 32

Worm gear, 32

Wrecking bar, 7

Yard and stay tackle, 13

# **BASIC MACHINES AND HOW THEY WORK**

**BUREAU OF NAVAL PERSONNEL**

Covering thoroughly basic theory, ranging from the lever and inclined plane up through basic computer mechanisms, this extraordinarily clear book leaves nothing to be desired in its presentation. Nothing more than the most elementary mathematics is required to follow it.

Beginning with the simplest of machines—the lever—the course proceeds with the discussion of the block and tackle (pulleys and hoists), the wheel and axle, the inclined plane and the wedge, the screw, and different types of gears (simple, spur, bevel, herringbone, spiral, worm, etc.). A chapter on the concept of work discusses the measurement of work, friction, and efficiency; this is followed by investigations of power, force and pressure, explaining the uses of scales, balances, gauges and barometers. *The fundamentals of hydrostatic and hydraulic machines* (such as the hydraulic braking system and the hydraulic press) are discussed in detail. The remaining chapters cover machine elements (bearings and springs), basic mechanisms (gear differential, couplings, cam and cam followers, clutches), complex machines (water-tight door, typewriter), the internal combustion engine (its components and how it works), power trains (including explanations of various transmission systems—synchronesh, auxiliary, etc.), and basic computer mechanisms (linkages, multipliers, integrators, etc.).

Every concept is clearly defined and the discussions always build easily from elementary theory to particular applications that are familiar to anyone with the slightest interest in mechanics. Important concepts, machine components and techniques are clearly illustrated in more than 200 diagrams and drawings, cross-sections that reveal inner workings—all of these help to clarify even further an already clear and well-organized presentation. Although it was originally designed for use in U.S. Naval Training Schools, this book can be used to great advantage as a basic text in mechanical engineering in standard technical schools, and it will be immensely valuable even to the layman who desires a basic knowledge of machines.

Unabridged republication of Navy Training Course NavPers 10624-A (1965). 204 figures. Preface. Index. viii + 161pp. 6½ x 9¼.

21709-4 Paperbound

## **A DOVER EDITION DESIGNED FOR YEARS OF USE!**

We have made every effort to make this the best book possible. Our paper is opaque, with minimal show-through; it will not discolor or become brittle with age. Pages are sewn in signatures, in the method traditionally used for the best books, and will not drop out, as often happens with paperbacks held together with glue. Books open flat for easy reference. The binding will not crack or split. This is a permanent book.

# Handy Farm Devices

and How to



Make Them

**H**ANDY FARM DEVICES AND HOW TO MAKE THEM, a classic from the Golden Age of American Farming, is as useful and pertinent for homesteaders and small-scale farmers today as it was when it was first published more than seventy-five years ago. A wealth of labor- and money-saving projects fills its pages: spill-proof chicken waterers; a portable chicken coop; a lightweight orchard ladder; a small truss bridge; an easy fence-post and stump-puller; gates that don't sag; gates that lift over snowdrifts; a handy wood splitter—even a bicycle-powered washing machine.

**HANDY FARM DEVICES AND HOW TO MAKE THEM** is a rare and engaging combination of nostalgic Americana and helpful instruction, sure to appeal to everyone inclined toward self-sufficiency and the country life.

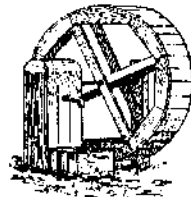
*Write for a complete list of other books on country living and the outdoors from Lyons & Burford, Publishers.*



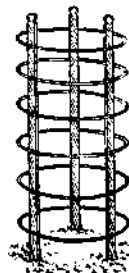
Lyons & Burford, Publishers  
31 West 21 Street • New York, New York 10010

Cover design by Lynne Amft  
Printed in the United States of America

A CLASSIC OF  
AMERICAN INGENUITY



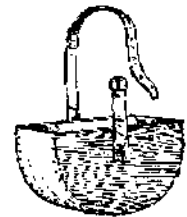
dog power pump



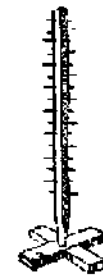
trellis



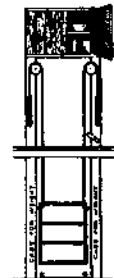
pipe twister



feed basket



rack



dumb waiter

Rolfe Cobleigh

# Handy Farm Devices and How to Make Them

*By Rolfe Cobleigh*

681  
.763  
Cob  
18

Cobleigh, Rolfe.  
Handy farm devices and how to make them / by  
Rolfe Cobleigh. --New York : Lyons & Burford, 1996  
288 p. : ill.

Originally published: New York : Orange Judd Co.,  
1909. With new foreword.  
Includes index.  
753053 LC: 95038426 ISBN:1558214321 (pbk.)

1. Farm equipment - Design and construction

## Foreword to the 1996 Edition

**I**N 1972, after a brief and unsuccessful experiment with urban living, I moved to a small hardscrabble homestead in midcoast Maine—as one of many in my generation who migrated to places like Oregon and Montana, determined to live apart from a society that seemed to value us only as producers and consumers of goods. We came to get a living with our hands, to become latter-day Thoreaus, working the soil and communing with nature—with, of course, the Grateful Dead blaring reassuringly in the background.

That few of us had been closer to nature than dozing in the sun on Boston Common or Golden Gate Park troubled us not a whit: We were brilliant, clever, omniscient. We were baby boomers.

*Mother Earth News* would show us the way. *The Whole Earth Catalog*. *Living on the Earth*. All we needed were the right books and a pair of low-back overalls. How hard could country life be?

Pretty hard, as it turned out. The hands-on experience of our generation's back-to-the-land authors could most charitably be described as recent and shallow—a fact that quickly became evident when our hand-crafted homesteads needed essentials about which our gurus knew only basics, not details: chicken coops, grain storage bins, cistern filters. So our chickens didn't stay cooped, grains didn't stay binned, and cisterns were filtered only through rose-colored granny glasses.

I had a bit more experience in country living than most, having come from farm country. But I soon found that dozing in VocAg class doesn't properly equip one for running a homestead in Maine.

Then I found *The Book*, dust-covered and neglected in a crossroads junk store, and my homestead creations quickly assumed a more professional air: the chickens stayed cooped, the grain stayed binned.

Foreword copyright © 1996 by James R. Babb

All inquiries should be addressed to Lyons & Burford,  
Publishers, 31 West 21 Street, New York, New York 10010.

First published 1909 by Orange Judd Company  
Printed in the United States of America

10 9 8 7 6 5 4 3 2 1

Library of Congress Cataloging-in-Publication Data

Cobleigh, Rolfe.

Handy farm devices and how to make them /  
by Rolfe Cobleigh.

p. cm.

Originally published: New York : Orange Judd Co., 1910

Includes index.

ISBN 1-55821-432-1 (pbk.)

1. Farm equipment—Design and construction—Handbooks, manuals, etc.
2. Agricultural implements—Design and construction—Handbooks, manuals, etc.
3. Farm buildings—Design and construction—Handbooks, manuals, etc.
4. Agriculture—Handbooks, manuals, etc.
5. Do-it-yourself work. I. Title.

S676.C7 1996

681'.763—dc20 95-38426 CIP



More important, the grain dried fast and stayed rodent-free; the chickens were healthier and produced more eggs with less feed.

*Handy Farm Devices and How to Make Them* dates from The Golden Age of American Farming, when farmers were truly self-sufficient, making what they needed from what they had. It is recent enough to be technologically pertinent and old enough to be free from the baleful influences of advertising and its artificial demands. It is both helpful instruction and nostalgic Americana.

In its pages you will find detailed instructions for building the things without which a small farm or homestead simply cannot exist, as well as valuable insights into building things in general, including the best treatise I've seen on the most useful but least appreciated tool in the box: the carpenter's square.

The projects range from the merely curious—a bicycle-powered washing machine; or a dog-powered water pump—to the absolutely essential—an improved stone boat; a portable chicken coop; a light-weight orchard ladder; a small truss bridge; an easy fence-post and stump-puller; gates that don't sag; gates that lift over snowdrifts; and—the handiest farm device I've ever found: the accurately described Handy Wood Splitter, which has saved me countless hours trying to balance a lopsided chunk of wood long enough to whack it with an ax.

Farming and homesteading are hard work, and long-term success lies in minimizing both the amount of work needed to produce a desired result and outside expenditures. *Handy Farm Devices and How to Make Them*—as succinct and accurate a book title as was ever writ—will help you do that and more.

James R. Babb

## By Way of Introduction

SUCCESS comes to the man who so works that his efforts will bring the most and the best results—not to the man who simply works hard. It is the know-how, things-to-do-with and economy that count. Labor-saving machinery has revolutionized many a trade and industry. It has made farming an industry and a science of possibilities undreamed of and unattainable a hundred years ago. But it is not enough for the modern farm to be equipped with the best tools and machinery that shops and factories turn out, to know how to use them and keep them in repair. There are many handy devices, not made in any factory and not sold in any store, that every intelligent man can make himself, which save money and labor and time. Inventive men are constantly contriving simple but valuable things to meet the needs of their own practical experience. We are all the time hunting after and gathering these ideas. Now we are putting a lot of the best ones into this book. We are trying, by words and pictures, to explain clearly just how to make each device. Everything described is tried and practical. Some are old, many are new, all are good for the purpose intended. They represent the practical, successful experience of farmers and other wide-awake workers all over the United States.

This book is broader than its title. The overflow of good measure includes a valuable chapter on the steel square and its uses. Nowhere else has this subject been handled in a way so easily understood, with confusing mathematics cut out. We especially commend this chapter to our readers. We also present some good house and barn plans, that will be appreciated by those who contemplate building.

In addition to the direct benefit to be derived from doing what the book tells how to do, we have in mind the larger purpose of education toward putting more thought into our work and doing what we have to do the easiest, the cheapest and the quickest way. Out of it all, we trust our readers will make progress toward greater prosperity, greater happiness and greater usefulness.

## CONTENTS BY CHAPTERS

---

	Page
Workshop and Tools . . . . .	7
The Steel Square . . . . .	19
In and Around the House . . . . .	37
Barns and Stock . . . . .	83
Poultry and Bees . . . . .	115
Garden and Orchard . . . . .	131
Field and Wood . . . . .	154
Gates and Doors . . . . .	174
When We Build . . . . .	189
Worth Knowing . . . . .	233



## · WORK · SHOP · · AND · TOOLS ·

### THE FARMER'S WORKSHOP



HERE is no doubt that of all the handy farm devices good tools head the list. So, in this book, we are going to start with carpenter tools and the place to keep and use them. Every farmer ought to have a workshop in which he can do odd jobs and make things when the weather prevents out-of-door work, or at times when there is little to do on the farm. Economy and thrift demand that a farmer should have and keep in good condition a few essential carpenter tools. First of all he should have a long, strong, smooth-top bench and, either on racks above the bench or in a tool chest, he should keep in order, and where he can easily find them when wanted, his stock of carpenter tools. Some of the tools that will be found useful are the following:

A rip saw, a crosscut saw, a back saw, and a compass saw; a jack plane, a fore plane, and a smoothing plane; a shave or drawing knife; two or three chisels of different sizes for woodworking and a cold chisel for metal; a gouge or two; a good hatchet; two or three hammers, including a tack hammer and a bell-faced claw hammer; a brace or bit stock with a set of half a dozen or more bits of different sizes; one or more gimlets; a mallet; a nail set, a large screw driver and a small one; a gauge; a spirit level; a miter box; a good carpenter's square—No. 100 is a good standard size;

compasses or dividers; cut nippers, a pair of small pincers and a pair of large ones; a rasp; a large, flat file; at least one medium-sized three-cornered file and a half-round file.

It is poor economy to buy cheap tools. Of course extravagance is to be avoided, but be sure that you get first-class material in every tool you buy. It is a good plan to get a good practical carpenter to assist you in selecting your tools. Keep on hand in the shop a variety of nails, brads and tacks, screws, rivets, bolts, washers and nuts, and such small articles of builders' hardware that are likely to be needed occasionally, including hinges, hasps and staples and some sand-paper. Have a good plumb line, chalk and pencils. Keep in a handy place a jar of a good liquid glue, and some cement. See to it that the shop contains a good stock of well-seasoned lumber, both hard wood and soft.

Attached to the bench should be a bench screw or vise. This need not be an expensive one, but should be of good size and strong. There should also be a pair of carpenter's saw benches, a shaving horse, a small anvil and a grindstone. Every farmer has a grindstone somewhere about the buildings, but it is a great convenience to have a good one in the workshop.

A corner of the shop should be devoted to painting supplies, including several colors of good standard ready-mixed paints and stains, raw linseed oil, boiled linseed oil, turpentine, varnish, putty, points for setting glass, several brushes of different sizes, a good putty knife and panes of glass of different sizes ready for emergency.

A farmer ought to be able to do occasional little jobs of soldering. He needs soldering iron, a bar of solder, resin, a little bottle of soldering fluid,

which can be purchased already prepared, also a small sheet-iron furnace in which to heat the soldering iron.

It would cost quite a tidy sum to buy all these things at once, but they can be gradually accumulated as one is able to purchase them, and then the outfit should be kept complete. Whenever anything in the shop is broken, worn out, or disappears it should be replaced.

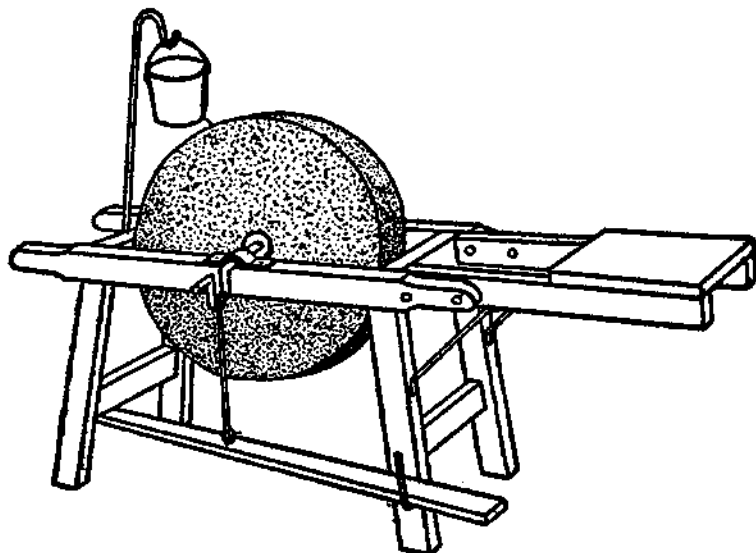
Whenever farm implements or anything about the barn or house are broken or out of order, they should be properly fixed. Often a few minutes spent at the right time will make a thing almost as good as new, while, if neglected, it may soon get beyond repair and have to be thrown away. A thrifty farmer always keeps his farm implements well housed and in repair. It is not what we earn, but what we save, that makes us rich. It is quite as important to stop the leaks as it is to figure on big profits directly.

## RUNNING THE GRINDSTONE

If the face of the grindstone is hard and glazed pour a little sand on the stone every few minutes until the glaze is worn off and the stone will cut like a new one. This condition is caused by exposing the stone to the weather. It is best to keep the stone in a shed under cover, but if this is not possible, set it under a tree and put a box over it when not in use. It is surprising how easy a little oil on the bearings will make the stone run. A few drops of kerosene will cut the gum if it runs hard and then some oil or axle grease will make it go easy.

It is hard to stand on one foot and work the

treadle with the other. The job can be made easy by bolting two boards to the grindstone frame, and extending it 2 feet, on which place a seat as shown



HANDY GRINDSTONE RIG

in the cut. An uneven stone needs to be cut down and toned up. This can be done by grinding against the end of a piece of pipe, having the stone dry.

---

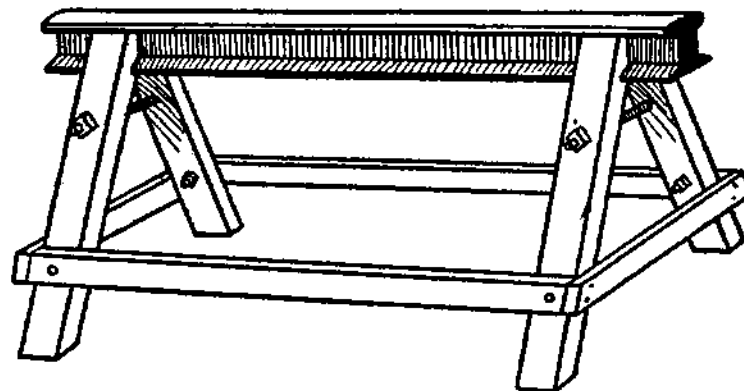
Good nature is as contagious as the measles. Put on your best smile when you get up in the morning and observe how everybody will greet you with a sunny face.

---

### A HOMEMADE ANVIL

A homemade anvil can be constructed from a 4-foot piece of railroad rail mounted on a trestle, as shown in the sketch. This affair will stand a lot

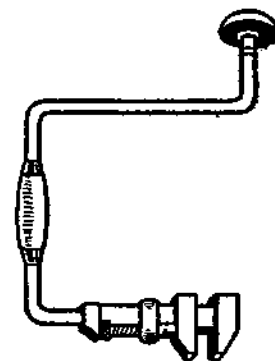
of heavy pounding, and comes in handy in many ways. The rail is just about the right shape to make an anvil.



RAIL ANVIL

### MAKING A NEW TOOL

A very handy wrench for many kinds of work, such as making gates and contrivances, where small bolts are used, is shown in the cut. From a small monkey wrench remove the wooden handle, and weld the metal part to an old bit-stock, as shown in the cut. This permits of very rapid work in screwing up small bolts. Where there are so many things to do as there are on a farm, it pays to do things in the easiest and quickest way. This is one of the real time-savers.



BIT-STOCK WRENCH

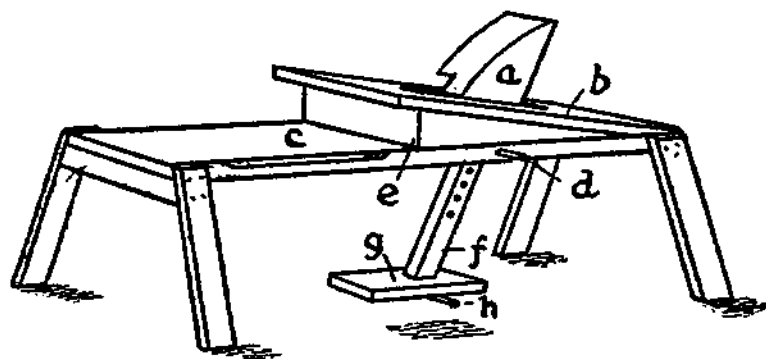
---

Learn to live, and live to learn,  
Ignorance like a fire doth burn,  
Little tasks make large return.—Bayard Taylor.

## HOW TO MAKE A SHAVING HORSE

One of the most useful devices on a farm is a shaving horse. Make a bench 18 feet high of a good 2-inch plank, *c*, level off the edges so that it will make a comfortable seat. Upon this place a slanting platform, *b*, through which is cut a hole in which the clamp, *a*, works.

The clamp must be made of heavy hard wood that is tough and will not split. The shank, *f*, must



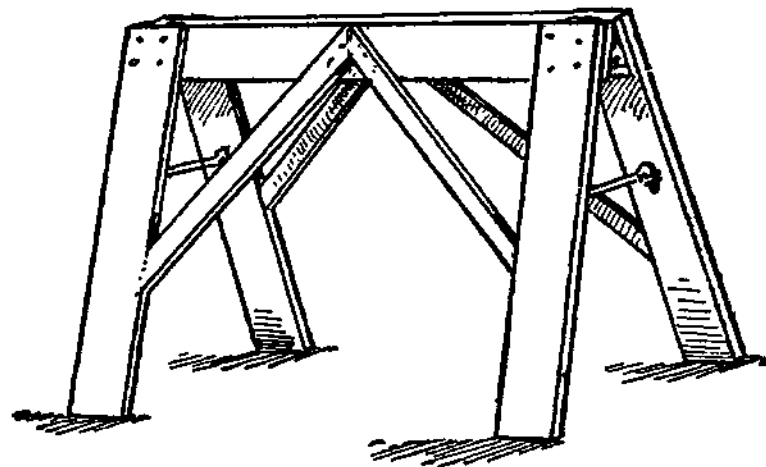
SHAVING HORSE

be an extension of the clamp, *a*. Several holes in the plank will allow the clamp to be raised so as to take in larger pieces of wood. The treadle, *g*, is kept in place by a peg at *h*. To operate this horse the workman places his foot upon the treadle, inserts the wood to be clamped under the edge of *a*, and pushes backward upon the treadle. This clamps the wood and the drawing knife can be used readily and much more rapidly than with a vise.

## A CONVENIENT FARM HORSE

On the farm there is continual use for such a horse as is shown in the drawing. Not only when

doing little jobs of carpentering, but also in many other operations, such a support is found necessary. This little horse is an improvement over the ordinary stiff affair, in that it shuts together when not in use, and so can be packed out of the way.



HORSE READY FOR USE

It is made of boards cut in strips, the two horizontal boards at the top being hinged together, as shown herewith. While in use the legs are kept apart by long hooks, as may be plainly seen in the picture.

---

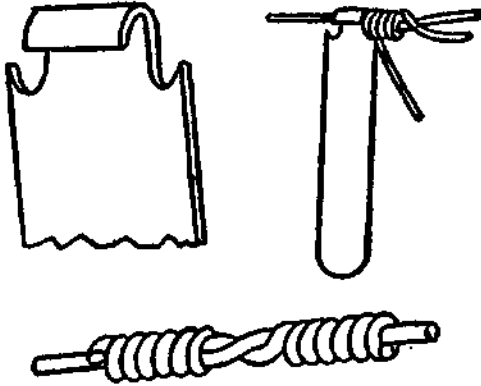
When tillage begins, other arts follow. The farmers, therefore, are the founders of human civilization.—Daniel Webster.

---

## A WIRE SPLICER

The neatest and strongest splice can be made with this little instrument. It is a strip of iron 1 inch wide and  $\frac{1}{8}$  inch thick. One end is cut narrow and is bent into a hook large enough to fit

neatly the largest wire to be spliced. At the sides of this two notches are filed, as shown at the left. At the right the splicer is seen in position on the wire. The splicer should be turned backward, as it appears in the right-hand drawing, to make the splice. A pair of large pincers or a vise should be used to hold the two wires between the coils while turning the splicer. The

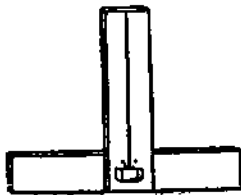


WIRE SPLICING

splice as finished appears above. The length of the handle may vary. If the splicer is to be used for net wire, of course the handle cannot be longer than the width of the mesh. Otherwise, 6 or 7 inches is about right for No. 8 wire. If it is to be used only for small wire, the length of the handle should be reduced for the sake of convenience.

### SERVICEABLE HOMEMADE LEVEL

A serviceable level is shown in the illustration. Take two 1-inch boards of rather hard wood, well-seasoned, 2 to 3 feet long, bolt or screw them together at right angles. This union must be so strong as never to be moved by ordinary pressure. At the top of the perpendicular piece cut a slit and insert a piece of strong thread. To the bottom of the thread tie a thin circular



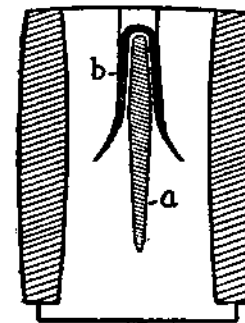
LEVEL

weight. Lay the device across two trestles of nearly the same level. Just above the weight mark the place where the string hangs. Reverse the position of the instrument by turning it end for end, and again mark the position of the string. Half way between the two marks place a third. When the string hangs over this mark the lower board will be level. A shield of tin may be placed over the weight. A nail on each side of the string, just above the weight, will keep it from swinging far out of place. It must be allowed to swing freely.

A simple level may be improvised by filling a small flat bottle with water, so that only a bubble of air remains, and attaching it lengthwise and near the middle of a straight stick or narrow board.

### TO MAKE A HANDLE STAY ON

To secure the handle of a hammer or ax is often quite a bothersome problem. A special wedge made with a piece of wood as at *a*, in the sketch, held in place by a fence staple, *b*, has been devised to meet the need for a wedge that really holds. The prongs of the staple should be bent slightly outward before it is driven in, so that they will spread in the handle. There is little danger of handles coming loose when they are attached in this manner, and



HOLDS WEDGE

it is little more difficult to set a handle as indicated than in the old-fashioned way.

## A TOOL BOX REQUISITE

Among the handiest things to have in the tool box are some small bolts about 2 inches long with thumb nuts. A dozen or so of these will prove their value many times over in the course of a year. In making tables for fairs or suppers or in any sort of knock-down arrangement, or temporary convenience where strength is essential, nothing surpasses a bolt of this description. With a brace and a bit the right size, one may be entirely independent of nails and screws.

A farmer friend of ours was once called upon to make a fence about a child's crib without any marring nails. A slot in the fence post with a thumb bolt just above the crib line gave an alligator jaw result which was very satisfactory. On another occasion a knock-down stage was carried from the storeroom in pieces and put together by two men in 20 minutes. An actual computation of its strength showed that a locomotive might safely run over it.

The man referred to above has 100 feet of tables for hall purposes, depending entirely upon the 2-inch bolt and thumb nut for their fastenings and braces. There is never any trouble about knocking out nails. To one having a brace and bit these handy things will suggest of themselves many satisfactory uses. A supply of iron washers should be kept in hand, and in time a collection of various sizes of wooden washers will accumulate.

## SOLDERING

Soldering may be done by anyone having a very simple outfit. All that is required is a copper sol-

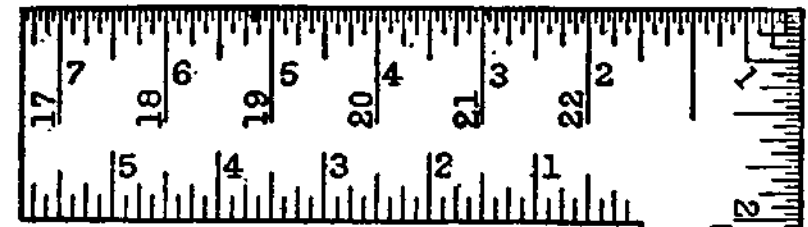
dering iron, some solder, a vial of muriatic acid and some resin. A fairly successful job of soldering a tin dish may be done by scraping the surface bright where the hole is, sprinkling on a little finely powdered resin, laying on a bit of solder and holding the dish over a flame, which may be from an alcohol lamp, until the solder melts. It will cover the hole and stick. If the dish is rusty or badly tarnished use muriatic acid in place of resin. Resin works best when tin is bright, but usually solder sticks most successfully when the acid is used.

For soldering large breaks or doing important jobs of soldering the iron must be used. In order to work well the iron has to be kept coated with solder. When it gets blackened it should be filed until bright and then rubbed upon a smooth board while hot in a mixture of melted solder and resin. When the hot iron is taken from the fire wipe it on a damp cloth before trying to use it to lift the melted solder. A soldering iron is best heated in charcoal or the coals of a wood fire. The copper should never get red hot, as that causes the coating of the point to be burned off. The metal to be soldered must always be heated before the solder will unite it.

Solder may be obtained in bars at any tin shop. It can be made by melting together 2 parts of lead and 1 of bar tin. This is the usual proportion for most purposes. Soft solder that will melt quickly and can be easily used for mending tinware can be made of pure lead and tin in equal parts. A hard solder is made by melting together 2 parts of copper to 1 of tin. Brazing solder is made by melting together brass and one-sixth its weight of zinc. When cool it should be granulated by pounding

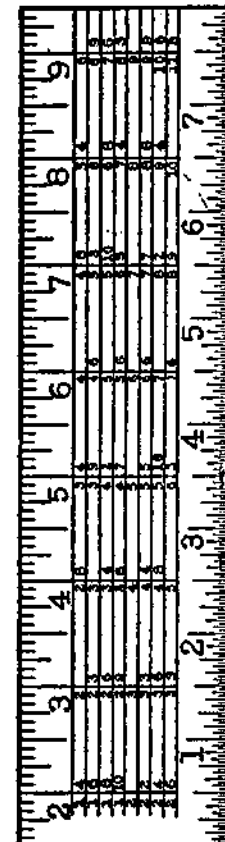


with a hammer. For soldering steel and iron to brass the following combination of metal is melted together, 3 parts tin,  $39\frac{1}{2}$  copper, and  $7\frac{1}{2}$  zinc. Before it is applied, all the metals to be jointed together must be heated to the same temperature as the soldering alloy. Gold solder is made of 24 parts gold, 2 parts silver and 1 part copper. A hard silver solder is made of 4 parts silver to 1 of copper. A soft silver solder is made of 2 parts silver to 1 of brass.



## Use of the Steel Square

BY J. HAMILTON ELLIOT



A steel square, often called a carpenter's square, can be found in almost any kit of mechanic's tools and a little knowledge of this instrument will aid the user to perform many problems easily and quickly that otherwise might prove difficult. Squares of different kinds and materials have been used by mechanics in all ages. The first were made of wood and were used in the construction of the earliest buildings of which we have historic record. The squares of today are made of steel, finely polished and stamped with many



figures, tables and rules, according to the taste of the manufacturer and the special mechanic for whom they are designed.

We will not attempt to deal with the several special kinds or makes, taking up only a few of the possibilities of the standard 2-foot square. This is 2 feet long on the blade, which is two inches wide, and it is 16 or 18 inches on the tongue or angular leg. The latter is  $1\frac{1}{2}$  inches wide. Beginning at the heel or corner of the square, inches and fractions of inches are marked. It is necessary that the marking be in this way, in order to form the different combinations desired in connection with the different problems which have to be solved. A few of these problems are explained in the following pages.

### LUMBER RULE

On the side of the blade of the square that is divided into inches and eighths is placed the lumber rule or scale. This is used for computing the number of feet in board measure contained in a given board or piece of lumber. We show a picture of a section cut from the center of the lumber rule. The space running lengthwise of the blade between the parallel lines contains the number of feet board measure for a given width of board. The first space is for boards 8 inches wide, the second for those 9 inches wide, the third for those 10 inches wide and so on. To determine the space which should be used for any given width, look under the 12-inch mark on the outside edge of the blade. These numbers give the width of the board, also the number of feet board measure. If a board is 10 inches wide and 12 feet long, it contains 10 feet board measure.

Now let it be required to find the number of feet board measure in a board 13 inches wide and 11 feet long. Find the space for boards 13 inches wide under the 12-inch mark on the square, follow this space to the left and under the 11-inch mark on the square will be found the answer desired: 11—11. This is read 11 feet and  $\frac{1}{12}$ , and is the number of feet board measure contained in a board

11	12	13	14
7-4	8-	8-8	9-4
8-5	9-	9-9	10-6
9-2	10-	10-10	11-8
10-1	11-	11-11	12-10
11-11	12-	12-1	13-2
12-10	13-	13-2	14-4
13-9	14-	14-3	15-6

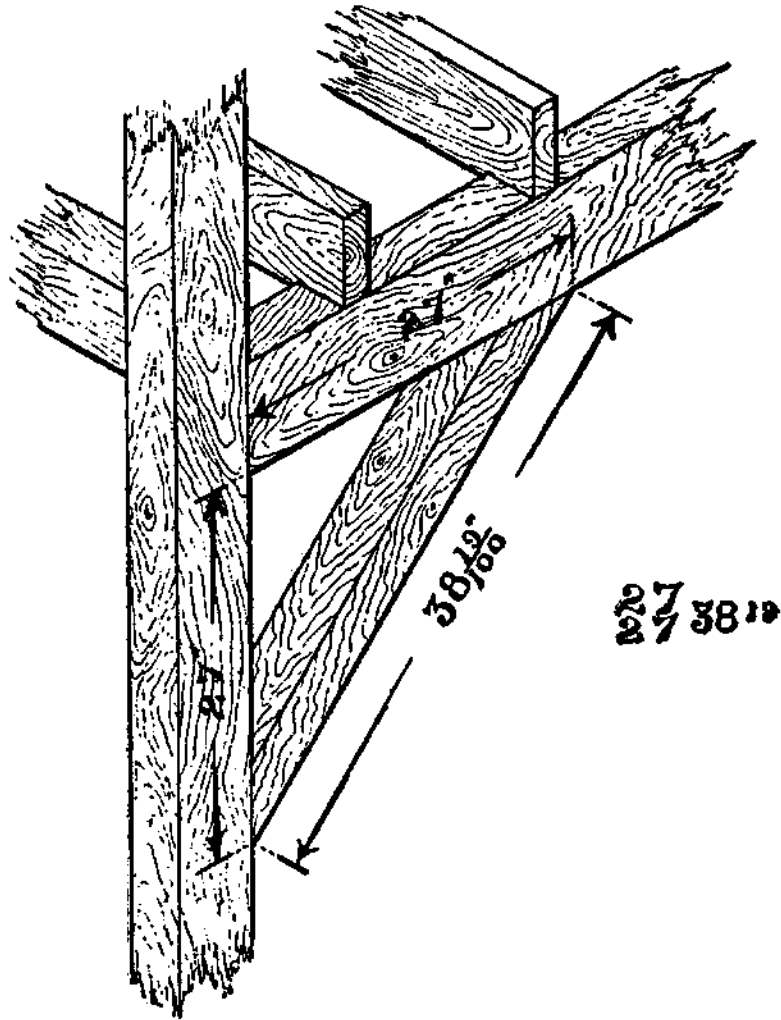
LUMBER RULE

13 inches wide and 11 feet long. With a little practice, anyone can measure lumber or timber and check up his bills for this kind of material.

Do not confound foot board measure with square feet. Square feet are in surface measure, with no reference to thickness, while a foot board measure is the equivalent of a foot square and 1 inch in thickness. The square feet of a 3-inch plank would contain 3 feet board measure.

After becoming familiar with the use of the lumber rule, as described above, you will discover that the space may be taken to contain the amounts for a given width and the different lengths in feet as represented in the different columns, or the space may be taken as containing the amounts for a

given length and the different widths arranged in columns; therefore, find either length in feet or width in inches under the 12-inch mark and follow this space until under the inch mark representing the other measurement. In this space will be found the feet board measure.



BRACE RULE

## THE BRACE RULE

The brace rule is on the tongue of the square, and has a series of figures representing the rise or vertical height, the run or horizontal reach and the true length of a brace. For example, they are written  $27/27$   $38^{19}$  and  $45/45$   $63^{64}$ . These would be read 27 inches run, 27 inches rise and a length of 38 and  $19/100$  inches, and 45 inches run, 45 inches rise and a length of 63 and  $64/100$  inches.

A glance at the illustration on page 22 will give a good idea of the application of the brace rule as it appears on almost any modern make of square.

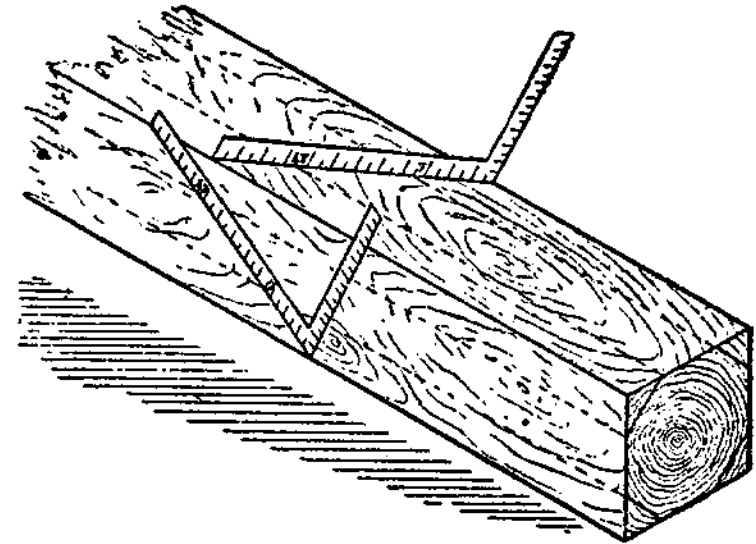


FIGURE I

## THE OCTAGON SCALE

There is an octagon scale on one side of the tongue of the square, but we will not attempt to explain its use, as there are easier and simpler methods of obtaining the same result.

One method is shown in Figure 1. To obtain the lines on a square stick where the corners should come when converted into an octagon or eight-sided stick: Lay the square on the one side of the square stick at such an angle that the end of the square will come exactly at the edges or corners of the stick, make a dot on the 7-inch mark and at the 17-inch mark. Through these dots gauge or mark a line parallel with the edge of the stick. Continue this operation on all of the four sides. This gives the lines for the corners of an octagon. In making a flag-pole or spar for a boat or to round any large stick this is the operation used by all mechanics doing the work by hand.

### THE MITER BOX

Of all homemade devices, one of the most frequently used in the shop is the miter box. After the box is put together it is a simple problem, with the use of a steel square, to make the cuts necessary to intersect two pieces of wood, as shown in Figure 2. First, the box must be straight and true and the sides form a perfect right angle or square with the bottom. Lay the steel square on the top

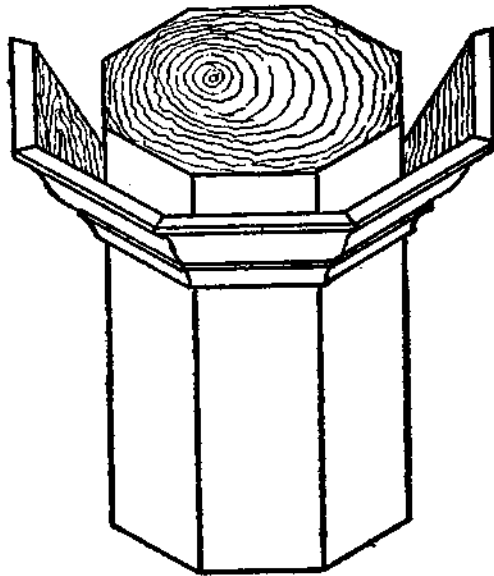
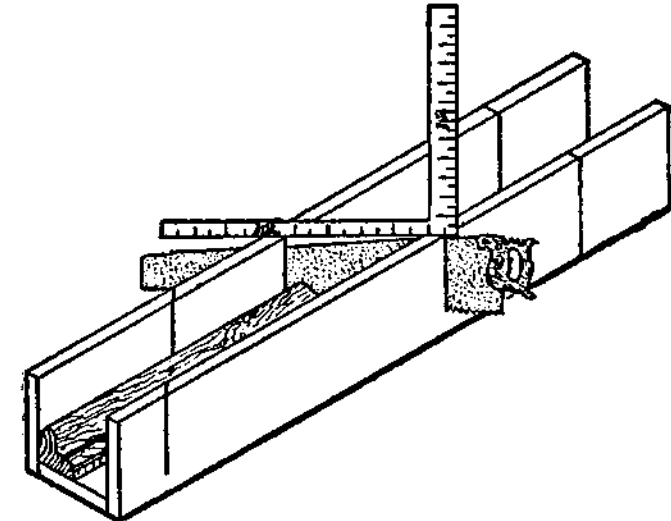
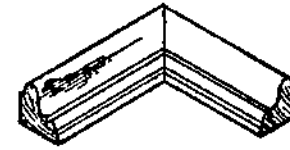
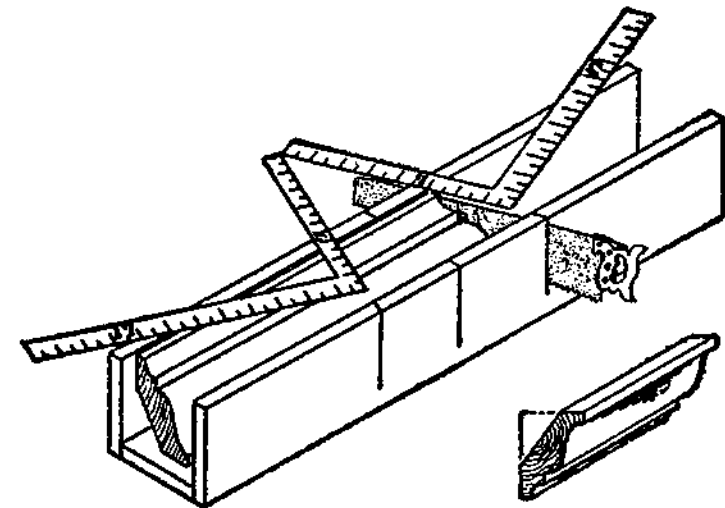


FIGURE 5A

of the box so that the 12-inch mark on the blade and the 12-inch mark on the tongue will both come



FIGURES 2 AND 3



FIGURES 5 AND 4

exactly on the edge of the box. This gives the miter cut of the intersection of the angle of a perfect square, as shown in Figure 2. Figure 3 shows the manner of placing the square on the box to give the desired angle.

A sprung molding, which is a molding not solid on the back, as shown in Figure 4, must be placed in the box bottom side up as shown in Figure 5, so as to get a solid bearing to hold it. Cuts in the box to miter around an eight-sided figure or an octagon, as shown in 5A, can be obtained by using 7 inches and 17 inches, marking the cut on the 7-inch side, as shown in Figure 5.

### TRUING THE SQUARE

After obtaining a steel square, the first and most essential thing is to test or prove it to see that it is accurate, forming the angle of a perfect square.

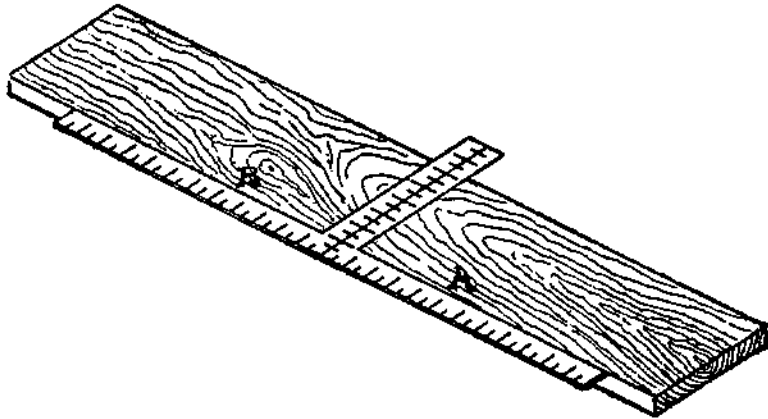


FIGURE 6

Take a board planed on one side and straighten one edge of it perfectly as described under Making a Straight Edge. Make a mark across this board

with the square, as shown in Figure 6, Position A, then reverse the square to Position B. If the square is true it should exactly fit the mark made. It is necessary to work very accurately, making the mark with the point of a knife and having the edge of the board absolutely straight.

If the square is found to be out or inaccurate, it is not necessary to throw it away; it can be made true by a simple method by any handy mechanic. If you do not possess an anvil, make a substitute by

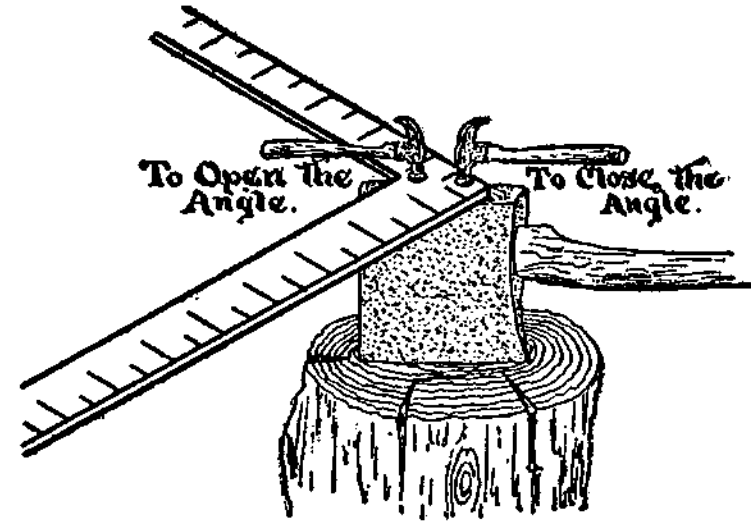


FIGURE 7

sticking the ax into a chopping block, lay the square on the head of the ax so that the bearing will come from the throat or inside angle to the heel or outside of the square. To close up the angle, strike with a hammer a sharp blow at a point near the heel; to open the angle, strike near the throat at a point indicated in Figure 7. Don't strike too hard. Use a bell-face nail hammer and the dent will not be noticed.

## A STRAIGHT EDGE

In connection with the work with the steel square a straight-edged board is necessary to have ready for immediate use. Procure a board 8 or 10 feet long of good, dry pine, free from knots and 6 to 8 inches wide. Plane the edge until it seems

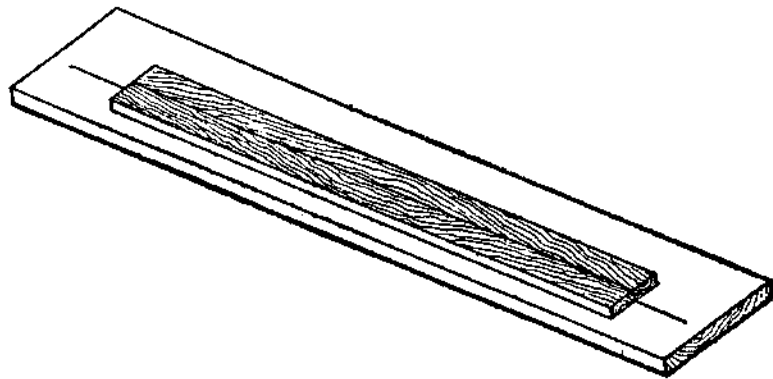


FIGURE 8

straight to the eye, then lay it on the bench or on another board and make a mark along the edge, just straight with a fine lead pencil; reverse it or turn it over and fit it to the other side of the pencil line. This multiplies any inaccuracy or deviation from a straight line. Make a new line each time you plane the edge. Work with as long a plane as you have and set the blade to take a fine shaving. When the edge will fit both sides of the line made from it while in one position, it is straight. Figure 8 will give a clear idea of this operation.

## RAFTERS

The common rafter for a pitch roof is easily laid out with the steel square. There are many methods,

but the easiest and most simple is by spacing. Two dimensions, half the width of the building and the height of the roof, are divided into an equal number of parts. The width of half the building is called the run and is usually divided into parts of 12 inches or a foot for convenience. The height is called the rise, and is divided into an equal number of parts. A glance at Figure 9 tells us that the run there shown is 10 inches rise to 12 inches run.

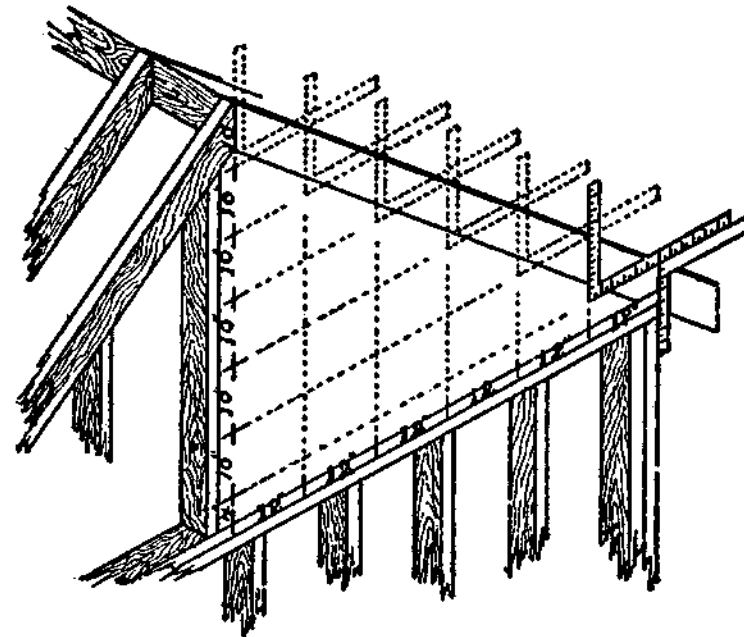


FIGURE 9

When the square is laid on the stick to be cut into a rafter, the 10-inch mark on the tongue and the 12-inch mark on the blade are held so that they come exactly even with the outside edge. The blade then takes a level position and the tongue a vertical position or plumb position. This gives the proper level for the cut at the top of the rafter and

the level cut at the top of the plate. As the square now lies on the stick make a fine mark and move the square along, marking another space. Mark as many of these spaces as the parts into which the rise and run were divided. This gives the length of a rafter from the ridge to a point exactly over the outside of the plate.

Where the rafter overhangs the plate, it is necessary to square down or in to form the notch for the plate. By studying Figure 9 you can readily see the different positions taken by the square, also, how and why the rise and run are divided into an equal number of spaces. By this method the length of the rafter is obtained without use of mathematics.

### STAIR STRINGER

The stair stringer is laid out in much the same manner as the common rafter. The total rise of height to go up is divided into parts of about  $7\frac{1}{2}$  inches, as near as possible. This makes the easiest step. The run is always divided into one less space than the rise. The reason for this can be easily understood by examining Figure 10. Lay the square on the stick to be used as a stair stringer, taking the numbers into which the rise and run have been divided, mark, and slide the square along until the required number of spaces are marked. A little experience, with allowance made for the surrounding conditions, and any handy mechanic can lay out stringers for an ordinary flight of stairs. To get an easy flight of stairs for the person of average size where plenty of room can be used, experience teaches that  $7\frac{1}{2}$  inches rise and 10 inches run or tread makes an easy flight.

From this some stair-building experts have put together the following rule, which works very well for the average stair: When the rise multiplied by the tread equals 75, the run will be an easy one, as  $7\frac{1}{2}$  inches rise by  $10\frac{1}{2}$  inches tread equals 75;  $8\frac{1}{3}$  inches rise by 9 inches tread equals

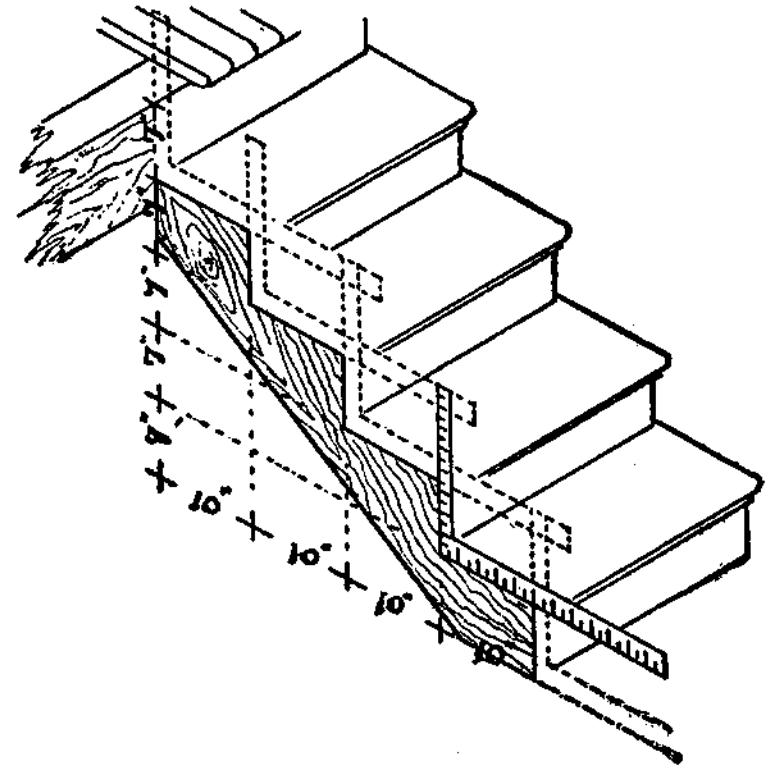


FIGURE 10

75; 8 inches rise by  $9\frac{1}{2}$  inches tread equals 76, which is very near the desired result. When the rise is 9 inches or over, the rule is not good, as the tread must be shortened up much more, and the rise should never be more than 11 inches—that is about the rise in an ordinary ladder leaning against a house.

## THE 47TH PROBLEM OF EUCLID

The problem shown in Figure 11 is known as the 47th Problem of Euclid, and is an invention by an ancient Greek geometer who sought many years for a method of finding the length of the hypotenuse of a right angle triangle in mathematics, and when the method was discovered, history tells us there was great rejoicing. Pythagoras is credited with having first proved the rule successfully applied to the problem.

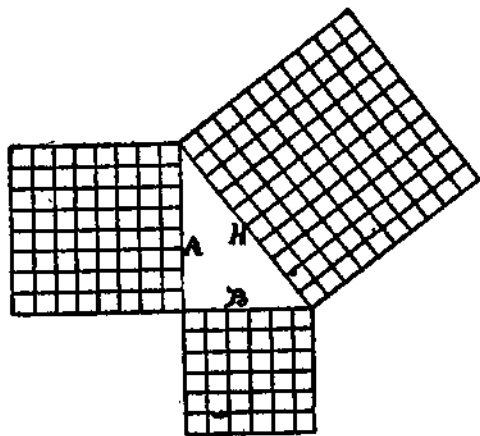


FIGURE 11

The rule is that the square of the base added to the square of the altitude equals the square of the hypotenuse. The base of a right angle triangle is the side on which it rests, marked B in Figure 11. The altitude is the height and is marked A in Figure 11. The hypotenuse is the connecting side of the triangle, marked H in Figure 11. The base, 6, squared or multiplied by itself, equals 36. The altitude, 8, squared, equals 64. By adding these together we have 100, which is the square of the hypotenuse. It remains but to extract the square root of 100, which we know is 10, therefore 10 is the length of the hypotenuse or third side of this right angle triangle. All right angle triangles can be figured in the same manner, but only multiples of the

length of the three sides come even—such as 3, 4, 5 and 12, 16, 20, as shown in Figure 12; and many others, of course.

length of the three sides come even—such as 3, 4, 5 and 12, 16, 20, as shown in Figure 12; and many others, of course.

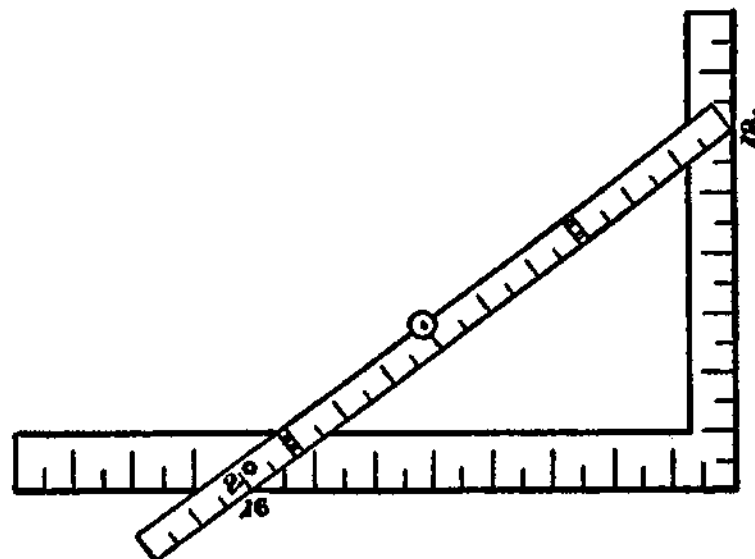


FIGURE 12

## THE RULE OF 6, 8 AND 10

This is a rule so extensively used in the building trades and others that it has finally come to be known by the above name. It is derived from the 47th Problem of Euclid, and is used in the manner shown in Figure 13.

Measure 6 feet on the end sill of a building and 8 feet on the side sill. If it measures 10 feet across the angle the building is square. This is a very useful rule and easily remembered. It is always available in running lines for batter boards for masonry or lines for walks. By starting from a corner stake into which a nail is driven, measure off on the string or line used and insert a stake to mark the place. Drive a nail into this stake and



proceed in like manner on the other side. With a little care and practice, quite a job of surveying can be done by using a few stakes, a ball of string and a tape or 10-foot pole.

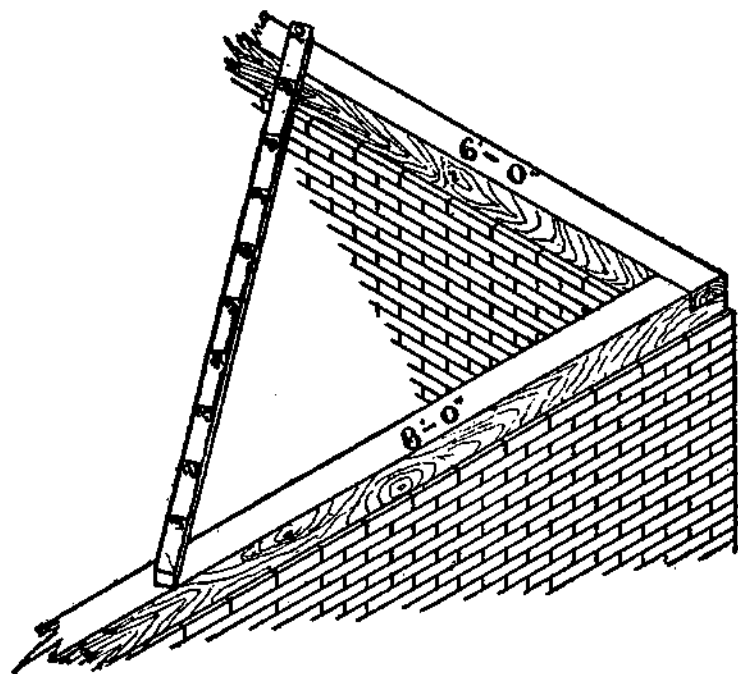


FIGURE 13

### ANGLES

An angle is the opening between two lines meeting at a point. Angles are usually spoken of as being of a number of degrees. The degrees are measured on the circumference, the center of which is on the point of the angle. There are 360 degrees of the circumference of a circle. The surface of the earth is so divided north and south by the parallels of latitude, which are numbered from the equator each way; also east and west by the meridians of longi-

tude, which are numbered from Greenwich, England. They can be seen on any map.

By the use of a protractor, the number of degrees of any angle can be obtained. Figure 14 shows one-half of a circle or 180 degrees.

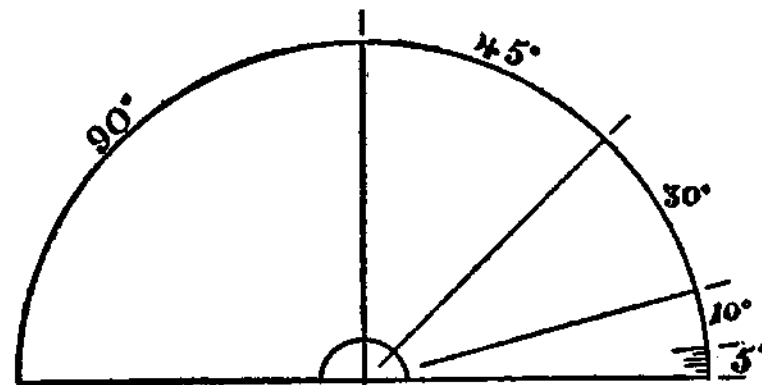


FIGURE 14

### PLOTTING ANGLES

To strike an angle in a field on a large scale where one line is given or can be obtained, measure off from the point of the angle  $57\frac{3}{10}$  feet; lay one

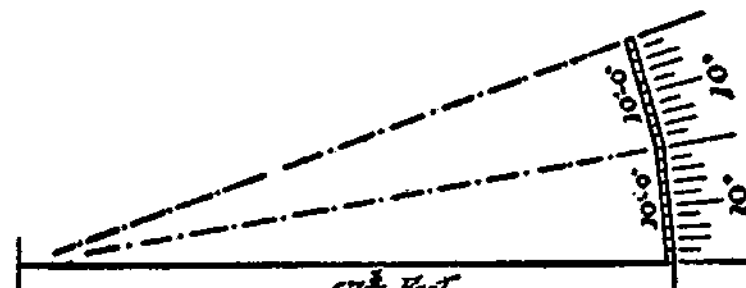


FIGURE 15

end of a 10-foot pole at this point. The other end should be swung around so that it also will be  $57\frac{3}{10}$  feet from the starting point. Each foot marks

off 1 degree on the circumference of a circle whose radius is  $57\frac{3}{10}$  feet. If more than 10 degrees are required, continue as before, keeping the ends of the 10-foot pole always on the circumference of the circle from the starting point. A clear idea of this operation can be obtained from Figure 15.

---

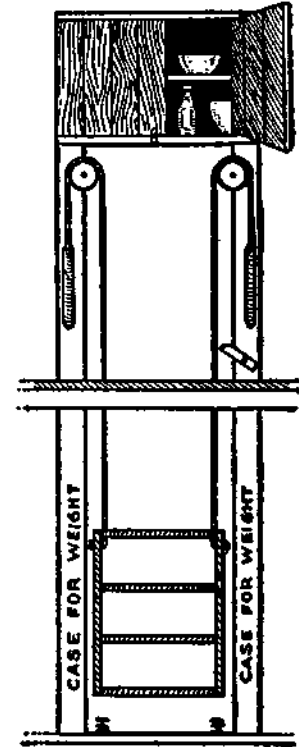
Labor is rest from the sorrows that greet us;  
 Rest from all petty vexations that meet us,  
 Rest from sin-promptings that ever entreat us,  
 Rest from world-sirens that hire us to ill.  
 Work—and pure slumbers shall wait on thy pillow;  
 Work—thou shalt ride over Care's coming billow;  
 Lie not down wearied 'neath Woe's weeping willow!  
 Work with a stout heart and resolute will!  
 —Frances S. Osgood.

# IN and the HOUSE AROUND

## THE STEP-SAVING DUMB WAITER



ONE may save many steps in every house where the kitchen is situated over the cellar, to say nothing of other considerations, with a small outlay of time, and perhaps, without the expenditure of a single dollar, by means of a dumb waiter, which may be placed in any convenient corner out of the way. A handy size for an ordinary family is 2 feet square with four shelves, counting the top, 1 foot apart. These shelves may be hung from the corners, the center or the middle of the sides, by means of manila sash cord over pulleys placed close to the ceiling of the kitchen and nearly balanced with weights, which should be confined in a little case. They should be guided in ascending and descending by means of grooves in the middle of the sides extending from top to bottom of the inclosed case. In the cellar the case may have a fine



DUMB WAITER

wire screen door and in the kitchen an ordinary cupboard door or one with a glass front, as desired.

The doors should slide upward and be balanced like an ordinary window with sash weights and pulleys. In order to prevent the waiter from descending when being overloaded a pivoted wooden latch, as shown on the right-hand side, should engage with the ends of the shelves, and to prevent any shock from too quick descent some coiled springs should be placed at the bottom of the case. If desired a small cupboard may be built at the top of the case for storing little-used articles.

Some advantages of such a waiter are that food may be placed on the shelves and lowered into the cool cellar and either allowed to stay there or removed to the refrigerator. Thus it will be unnecessary to carry anything to or from the cellar, and this will often mean a saving of several trips up and down. If the cellar is clean and cool there may be no need to use a refrigerator or an ice box.

### RACK FOR PRESERVES

A convenient rack for preserves may be made just at the turn of the cellar stairs in a house, so that the housewife need not step off the stairs, when she descends for a can of preserves. Several circular pieces of wood are pierced through the centers and nailed to a kind of wooden shaft that runs through the entire rack. Nail barrel hoops of the thick, wide variety around the edge of the shelves, so that the contents cannot fall off. The barrel hoops are soaked in water for several hours to make them pliable, so they can be fitted around the shelves.

In a socket at the bottom, the middle shaft slips,

the upper end working in a socket in the end of a stout piece of wood nailed to the beam overhead. The sockets may be purchased at the hardware store. The glass cans are arranged on the shelves, and the housewife can stand in one spot and turn the rack around until she finds the jar for which she is looking.

From the covers of large cheese boxes anyone could make a similar rack, using it in attic or kitchen, anywhere where one wants a rack which will hold an extra large number of articles for the amount of space involved.

---

Ill husbandry braggeth  
To go with the best:  
Good husbandry baggeth  
Up gold in his chest.—Tusser.

---

### TRANSFORMING A WASHSTAND

The kitchen cabinet here shown was made from an antiquated washstand and table, using old lumber, odds and ends of varnish, nails and screws, the finished article costing less than 50 cents. The only tools used were a saw, hammer, plane and square, such as can be found in any farmer's collection.

First, the shelf shown in Figure I was made, it being wide enough to reach each end of the table and deep enough for the washstand to set on it flush. To the right end was screwed a board of the same width, the shelf being so placed that it would be 2 feet above the

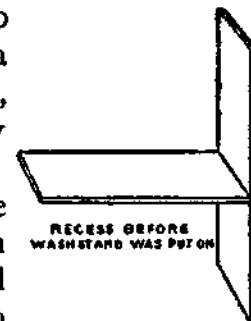
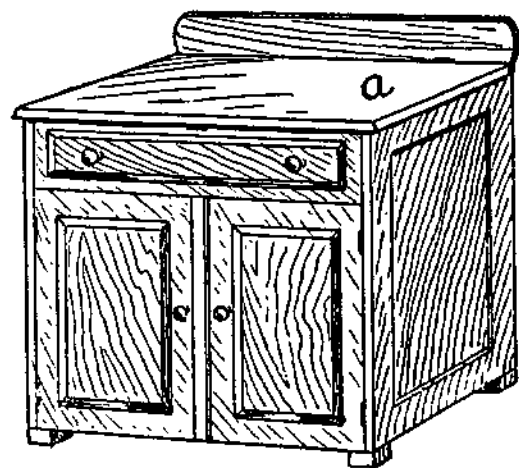


FIGURE I



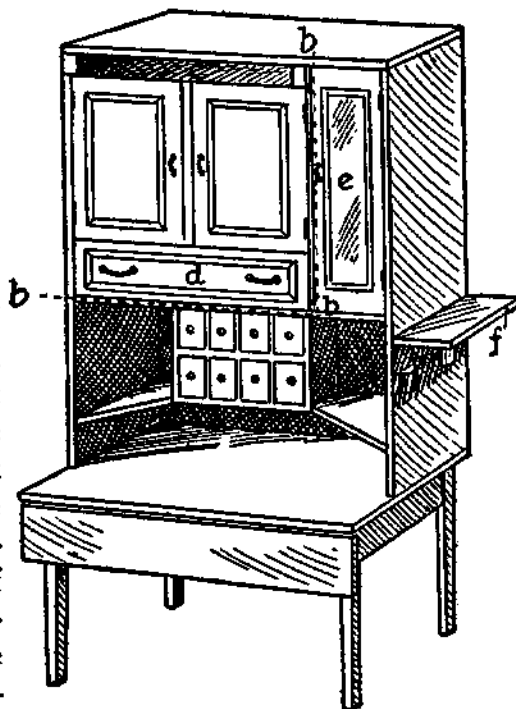
WASHSTAND AS IT WAS

of the shelf, and the two were securely fastened together. This left a narrow open space between the right end of the washstand and the right support of the shelf. A board was then nailed on top from one end to the other, and a back added.

The drawer of the washstand had to be fixed so that it would slide the other way, as it was now upside down. That necessitated a shelf inside the washstand above the drawer. Old lumber was used, and

table. A board of equal width formed the support at the other end.

Then the washstand, from which the top had been removed, was placed upside down on the shelf (*bbb*), one end of the washstand reaching to the extreme left end



THE COMPLETED CABINET

this was smoothed with a plane, then sandpapered and holes and cracks filled with putty. When the putty was dry it was sandpapered again.

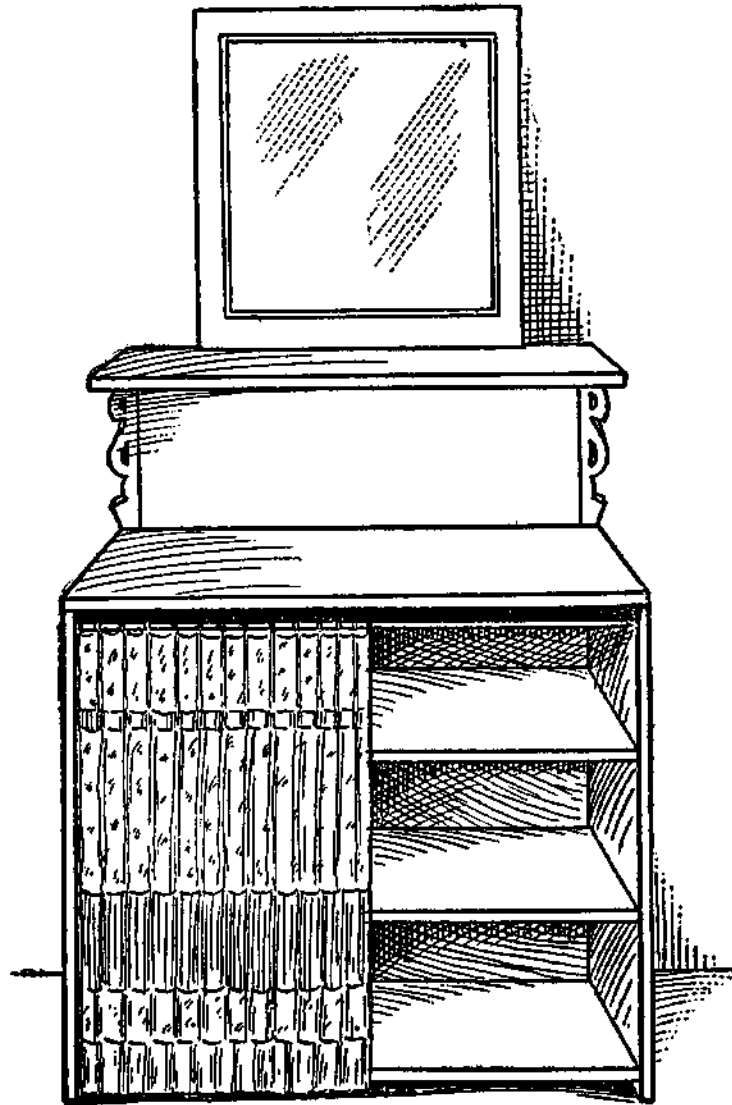
A support was then nailed to the back of the recess for a spice cabinet. This left the cabinet about 4 inches from the table. This support also did for two shelves, one in each corner of the recess. The spice cabinet contained eight small drawers and added much to the whole. A door with a glass sash (*e*) was then made for the narrow space to the right of the washstand above the recess. This made a little china closet with two shelves and containing over a dozen brass cup hooks. The space near the top on the left-hand side, between the short legs of the washstand, was left open for the crumb and draining trays. A piece of batten was nailed around the top as a finishing touch.

A leaf, which could be raised when required, added to the table room. The cabinet being placed in a corner left the front and one end free. On this end or side were placed two salt boxes, one for salt, and the other for kitchen cloths. Directly above these and reaching the length of the end was a shelf (*f*) for the clock, etc. Finally, walnut varnish stain, two coats, was applied. In each side of the recess were screwed two large cup hooks. Similar hooks were screwed on the inside of the washstand doors, to hang up biscuit cutter, corkscrew, nutmeg grater, etc.

## HOMEMADE DRESSER

Sometimes it is necessary to use homemade makeshifts in the house furnishing, and sometimes it is done through a desire to exercise one's in-

geny in fashioning simple affairs. The accompanying illustration shows a plan for making a simple dresser that when finished will not only be very useful in itself, but will also add a useful bit of furnishing to the room.



DRESSER MADE FROM A BOX

Select a drygoods box of the right size to fit well into the space to be utilized, then fit two shelves to the interior, as suggested. The whole box should be covered on the outside with some pretty cloth, the edges being drawn over and around the front edges of the box, and neatly tacked inside. Make a shelf with a length equal to the width of the box and fasten it to the wall above the box with some pretty nickel brackets, as shown in illustration. Cover the shelf with cloth, also. Now place a looking-glass above the shelf and have a curtain like the covering in front of the opening. This curtain can have little brass rings sewed to the upper edge, which will slide on a small brass rod.

---

Dost thou love life? Then do not squander time, for that is the stuff life is made of.—Benjamin Franklin.

Earth is here so kind, that just tickle her with a hoe and she laughs with a harvest.—Douglas Jerrold.

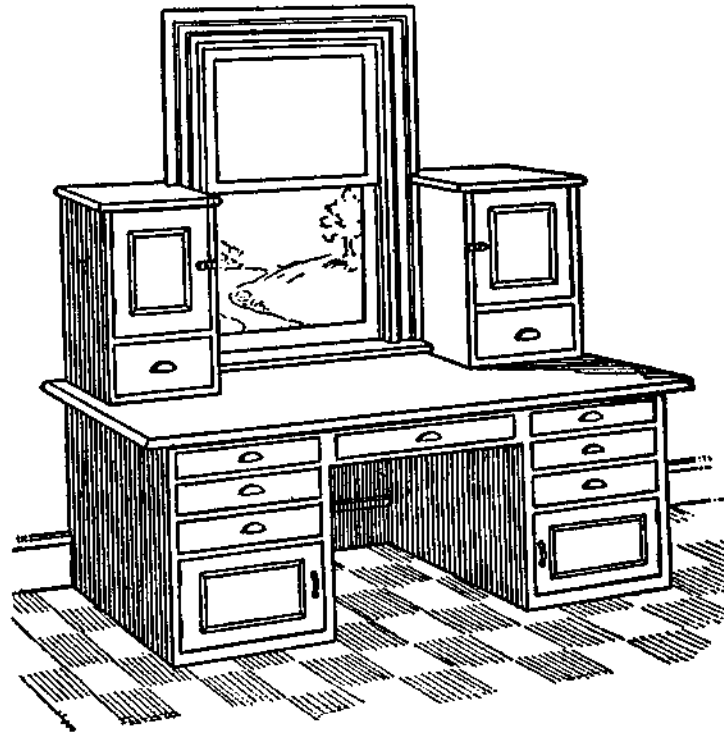
Blest is the man whose wish and care  
Is just to be happy anywhere.

---

### KITCHEN WINDOW CABINET

Nothing lightens labor so much as cheerfulness, and cheerfulness may often be secured by very simple means. In the accompanying picture is shown one way that works well. Instead of the usual kitchen table a cabinet is built below and at the sides of the kitchen window and the top made large enough to serve as a table. In this way the

wife may have a pleasant view when she looks up from her kitchen work. It is not necessary to go into details concerning the construction of such a cabinet, because no two people would be satisfied



CABINET AT WINDOW

with the same plan. The plan shown is merely suggestive for the thoughtful wife and the handy man to work out to suit their own particular needs.

### TO LET IN MORE LIGHT

Many farm kitchens and dining rooms are dark and gloomy. It is not an easy matter to cut new windows in the outside wall, though this can often

be done to great advantage; but where there is an outside door in a dark room, conditions can very easily be improved, and that, too, at small expense. Doors vary greatly in the manner of construction, some having wide panels at the top and some having two narrow ones of varying lengths. But almost every panel door that was ever constructed can be treated in the way which we will describe. The two upper panels can be removed, and their place filled with two lights of glass. If the door is of modern make it will be found that the wooden panel is held in place by a narrow molding all about it, both inside and out. Remove the molding on one side, and take out the panel. Put in the glass and replace the molding, and the work is done. If, however, the door is of older manufacture the molding on either side may be found to be a part of the door frame. In this case, cut the molding away on one side, neatly and evenly, and remove the panel. Then insert the glass, and having made, or bought, a little strip of molding, fasten it neatly in place around the glass with brads.

In the case of some doors the two panels could be removed, and also the upright between them, leaving a large rectangular opening, into which a single sash of four, or nine, lights could be inserted, the joints being made tight about it with putty and white lead. Then tack a narrow bit of molding about the sash, both inside and out, and a door that will give light to the room will be the result. An outside door looks better with glass in the upper half, and the interior will certainly be made more cheerful and healthful because of it.

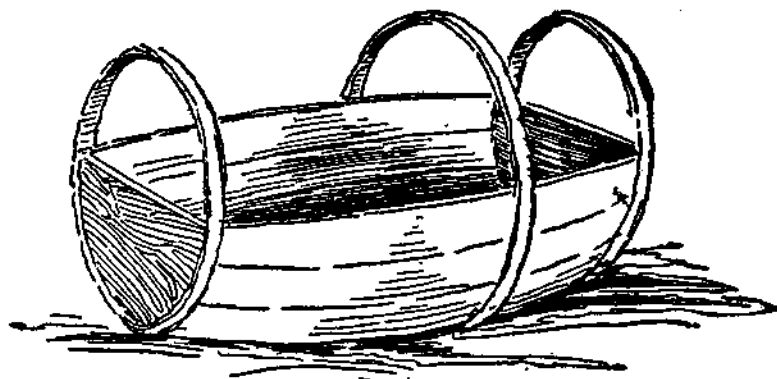
---

We know what we are, but know not, what we may be.—Hamlet.

## A BARREL CRADLE

Anyone who can use a hammer and nails and needle and thread can make this inexpensive, accessible, easily moved, and cool yet sheltering cradle.

Secure a nice white sugar barrel, clean it thoroughly and remove half of both heads. Place the barrel on its side, removing half the staves, and leaving the other half to form the bed of the cradle.

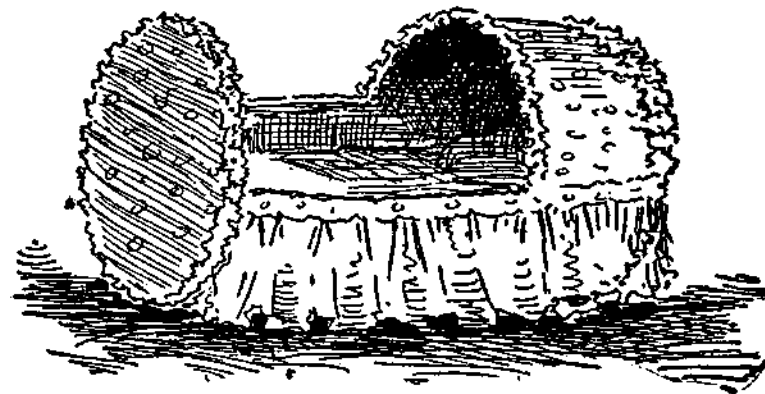


BARREL READY TO TRIM

Next remove the hoop that is second from the bottom, and then two hoops will be left at the top to form the frame for the hood, and one hoop at the bottom to form the foot. (See illustration.) Carefully nail the remaining staves to the hoops, clinching each nail securely.

Now cover the frame thus formed, as shown in the accompanying illustration. Any thin cotton goods that may be laundered can be used. Figured lawn would be very pretty, and if economy is an item, a worn bleaching sheet will do. Place a little mattress or pad and a tiny pillow within, or

the usual cradle furnishings may be used. One yard of mosquito netting stretched over the opening of the cradle will prevent insects from bothering, and the netting itself cannot touch and awaken the baby.



FINISHED CRADLE

## TO PROTECT BABY FROM HOT STOVE

Winter months mean extra care for the mother of a baby, but possibly the greatest of the additional cares that winter brings in this regard is that of keeping the curious tot from the hot stove. Build a pen around the stove to protect him from it. The pen is a simple affair. It consists of four little gates, made just large enough to surround the stove, and covered with netting. The wire netting does not interfere with the free passage of heat and is very effective in keeping baby from getting burned. The gates are made of 1¼-inch strips, mortised or neatly fitted. For netting use ordinary poultry wire of 2-foot width. The gates are held in place by hooks and screw eyes. This arrangement is better than hinges, as it makes the

taking down of the affair, for sweeping or cleaning the stove, much easier.

In the summer you may use the gate at the foot of the stairs, across the porch door, and in other places where baby is determined to go, and where he is in danger of falling and getting hurt unless protected in this way. For this pen, the lumber costs 25 cents, the netting 25 cents, and the hook and screw eyes 15 cents, making a total of only 65 cents.

### A BOX FOR CLOTHES

In many of the furniture stores one may see pretty cloth-covered boxes that are used in bedrooms as a receptacle for various articles of apparel, the inside, as well as the outside, being covered with pretty figured cloth. The inside of the cover is fitted with pockets for slippers and slumber shoes. These little chests are so light that they may be lifted about with one hand.

To make such a chest, select one of the very light and well-made grocery boxes in which cereals and various brands of breakfast foods are shipped, which may be had at any grocery store. See that the corners and the bottom are nailed securely. The top will be composed of at least two pieces of board, and these can be made into a solid cover by nailing two cleats beneath them. But these will not look very attractive when the covering is being put on, so a more workmanlike plan will be to saw off a couple of inches from each end of the top boards and supply the place of the wood removed by nailing along the ends a 2-inch strip of the same thickness. This gives a cleat at each end, but the cleats in this way form part of the cover itself.

Use long wire nails to secure these end pieces in place.

It will be a simple matter to cover and line the box when the covering material is at hand. Use very small tacks and carry the outside covering up over the top and down over the inside, which will make the use of tacks along the top unnecessary. The lower edge of the cover can be tacked on the bottom of the box, so the tacks will not be seen on the outside at all.

### SCOOPS FROM TIN CANS

Scoops for handling sugar and flour are among the most convenient utensils that one can have about the pantry; and in a short time a good supply may be made from materials that are going to waste about almost every home.

Take an ordinary tin can and either melt or cut off the top. With a pair of tinner's shears (a strong pair of household shears may be used), begin at the open end and split the side of the can to within about an inch of the bottom. Opposite this one make a similar slit. Parallel to the bottom of the can, cut from the lower end of one slit to that of the other. Round the corners of the remaining half, and the body of your scoop is finished.

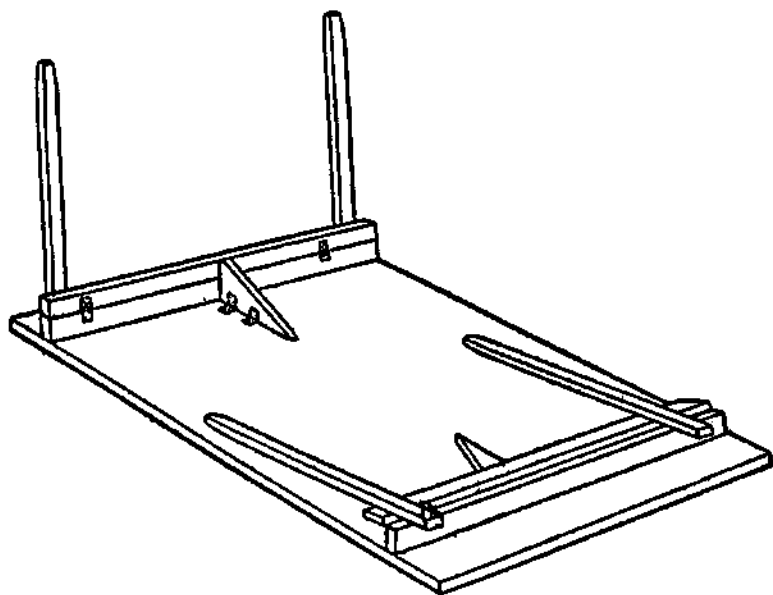
For a handle, about 4 inches off the end of an old broomstick is just the thing. If this is not available, a handle may easily be shaped with a knife from a piece of soft wood. To attach the handle, from the inside drive a small nail through the center of the bottom of the can and into the center of the handle.



Some additional strength is obtained by planning so that the seam of the can will run down the middle of the lip of the scoop, thus stiffening it. A salmon or corn can makes a very convenient sized scoop for the sugar, while tomato cans serve very nicely for flour and meals, and half-gallon paint buckets may be thus utilized for handling light materials.

### A HOMEMADE FOLDING TABLE

A handy game or sewing table may be made as follows: Take two planed boards 12 inches wide and 3 feet long. Fasten them together with two



SIMPLE HANDY TABLE

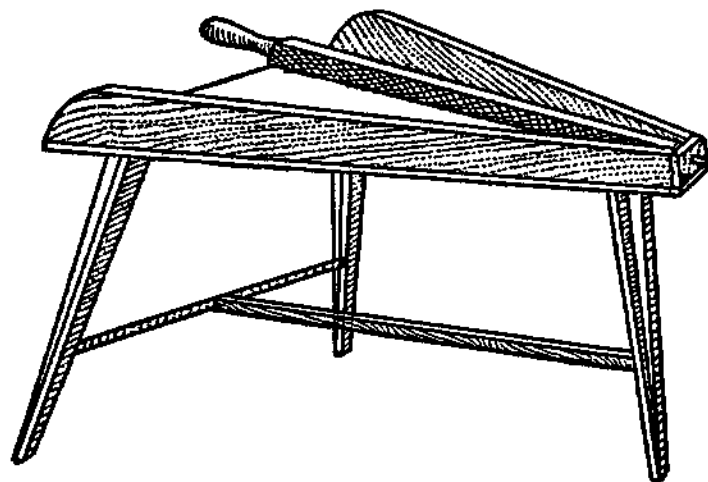
strips 2 inches wide and 24 inches long. Fasten these strips by strong screws in upright position. Now take two similar strips and fasten them by

hinges to the pieces screwed on the boards. Fasten four stout legs to these in the manner shown in the cut. Take two three-cornered boards large enough to hold the legs stiff when dropped into position, and fasten them by hinges, as shown.

The same general plan may be followed in making a much larger and heavier table or a lighter one.

### A HOMEMADE BUTTER WORKER

A butter worker is one of the handy devices that should be upon every farm. A good type is shown in the drawing. It is made of close-grained hardwood—maple or birch are recommended—tight-jointed, free from knots and perfectly smooth in size. It slopes enough to drain readily at the narrow end through a short piece of lead pipe inserted



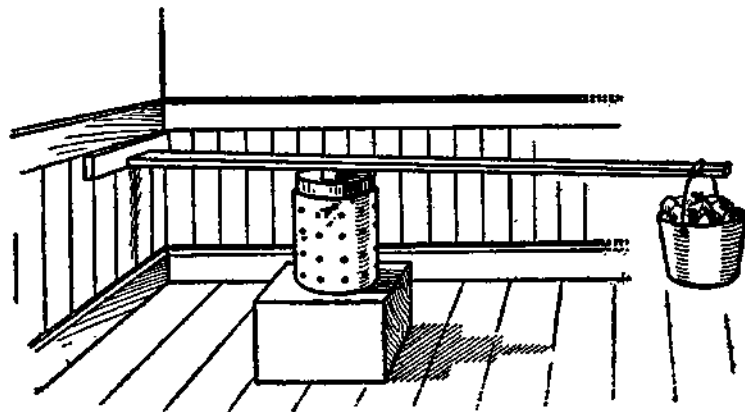
BUTTER WORKER

at the bottom. The working bar has a strong, smooth iron rod or spike at its lower end, which is easily inserted into or removed from the hole in

which it works. The part of the bar that comes in contact with the butter is half-round on one side and two flat sides meet at a right angle. Of course, it must be as smooth as possible.

## HOME CHEESEMAKING

Nearly every farm home contains, or may easily be supplied with, the necessary appliances to make cheese, and it is not a difficult task when one is once familiar with the process. For a small batch of about 12 gallons of milk the following method is a good one: Take about 6 gallons of the evening's milk and leave it covered with a cloth in a



CHEESE PRESS

temperature of 65 to 70 degrees until morning and then mix 6 gallons of morning's milk with it in a large tub or boiler. All milk may then be heated together to 80 to 90 degrees. Care must be used not to get it too hot or to expose it to a draft so that it will cool quickly.

Another good method preferred by some is to use 11 gallons of perfectly sweet morning's milk and

to this add 1 gallon of milk that has soured and thickened. The sour milk should be stirred well to get out all the lumps and left for about 15 minutes before the rennet is put in. The easiest way to heat the milk is to place it in a wash boiler right on the stove until it gets up to 86 to 90 degrees and then raise it from the stove by placing it on two bricks. The stove must not be too hot.

Rennet in the form of tablets is most convenient and useful for home cheesemaking. Dissolve one tablet in half a glass of cold water and add to the milk after it has been heated and stir well for two minutes. Some cheesemakers use two or three tablets, as it saves time, but for beginners two are usually enough. If you have liquid rennet extract, use about two tablespoonfuls.

## Cutting the Curd

The rennet will curdle the milk and the curd will be ready to cut in 20 to 40 minutes. This can be determined by noting if the curd breaks clean like jelly when raised on a knife blade. The cutting can be done with a wire toaster, a long knife or a heavy wire. Cut lengthwise of the vessel and then crosswise until the curd is in nearly uniform pieces of  $\frac{1}{2}$ -inch squares. After cutting, leave the curd on for five minutes, then heat slowly to 100 degrees, stirring all the time. Cook for about 40 minutes at as near 90 degrees as possible, stirring occasionally to prevent the curd from sticking together. Keep the heat up and do not allow the mass to cool.

To determine when the curd is ready, take a handful and squeeze it in the hand firmly and if it feels elastic and does not stick together, it has been cooked long enough. If the milk is good, the curd

should have a pleasant, slightly acid odor. As soon as the curd is cooked, draw off the whey or dip off the curd with a sieve and place in another vessel. After the curd is well drained and before it sticks together, add  $\frac{1}{4}$  pound of fine salt and mix well. After salting, let it cool for 15 minutes, stirring occasionally, when it is ready for the hoop.

### Pressing and Curing

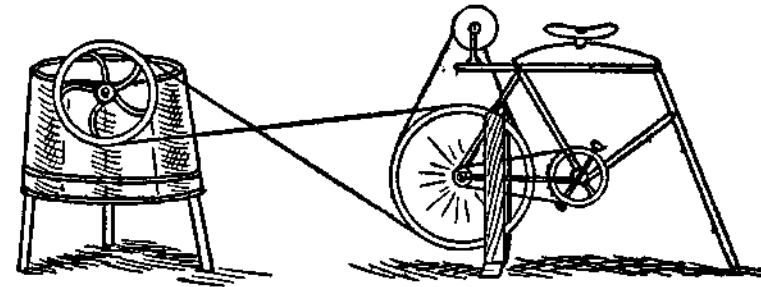
For a cheese hoop, one can use a tin hoop 7 inches in diameter and 12 inches deep or an old peck measure without a bottom if holes are punched in the sides for drainage. For a press a device shown in the sketch will serve well, the pail at the end of the lever being filled with stones. Before the curd is placed in the hoop, line it with cheesecloth, one piece the size of the bottom and another around the side. Turn the upper edge of the cloth over the edge of the hoop and fasten it tight. When the curd is packed firmly, put a piece of cloth on the upper end and fold it over tight. Make the pressure slight at first, but after an hour rearrange the cloth and make the pressure heavier. The pressing should be finished by the next day. Do not press in too cool a place, but keep the temperature about 50 degrees.

For curing, set the cheese in a damp room or cellar which has an even temperature. Turn it around daily, and if it shows signs of molding, rub occasionally with butter. It should be ready to eat in three or four weeks. Cheese will cure at 40 degrees, but it takes longer than when warmer. Twelve gallons of milk should make about 10 pounds of cheese, according to richness of milk.

After one or two attempts any housekeeper should be able to make good cheese by this method. It is necessary to keep all utensils very clean and the liberal use of boiling water with a little soda will accomplish this purpose.

### WASHES WHILE READING

Here is a way of making play of wash day. Perhaps some of our bright boys will try this to help mother. A friend of ours had an old bicycle unfit for use. He made a frame to raise the hind wheel from the floor, wound the rim with twine (tire being off) and reversed the seat. In place of the form he inserted a piece of pipe (a stick would do as well). Then he took some old belting, cut it



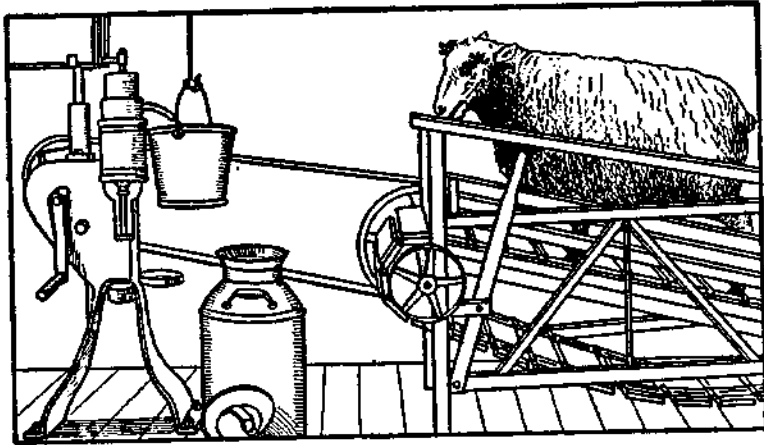
PEDAL POWER DEVICE

to  $1\frac{3}{4}$  inches wide and about 10 feet long, and with that he runs the washing machine for his wife. He can read the paper while he washes, and he does not lose much time from field work either. An emery wheel can also be run with it by bolting 1-inch strips to the top part of the frame extending over the wheel and mounting a polishing head on same.

Knowledge is power.—Bacon.

## TREAD POWER IN THE DAIRY

While the small gasoline engines adapted to running cream separators have been hailed with delight by many dairymen, the old tread power is still a very economical and reliable source of power. With a heavy sheep, dog or the dairy herd bull



SEPARATOR RUN BY RAM POWER

enough power can be produced to run the separator and churn at practically no cost except for the tread.

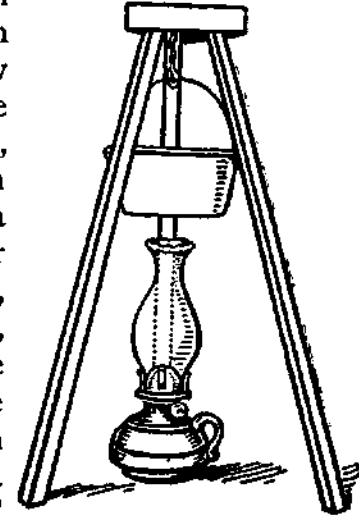
One difficulty has been to secure a uniform rate of speed, but this is solved if a heavy flywheel is attached to the tread. While the sketch shows a direct drive from tread to separator, a more desirable arrangement is to have the tread located in a room adjoining the separator room, where the milk will not be exposed to the breath of the animal.

---

A great many men wear themselves out devising schemes to sidestep honest work.

## A LAMP FOR COOKING

A lamp may be utilized for cooking purposes in the following way: Make a tripod by taking three strips of wood of equal length, putting in one end a headless nail and making slightly slanting holes in the corners of a 6-inch triangular piece of board in which to fit them. A screw hook in the center of the board, on the under side, completes the device, which has only to be stood over a lighted lamp to be ready for work. A small stew kettle, or tin pail, hung on the hook, within a half inch of the lamp chimney, enables one to have a "pot boiling" in short order. If you have a large lamp, with a round wick, it will give the heat of two or three common ones, and you can cook almost as rapidly as over a stove.



LAMP HEATER

With an ordinary lamp, food can be heated, eggs boiled, or coffee made very quickly, helping wonderfully in the getting of a meal. This is also an easy and convenient way to heat baby's milk, or water, in the night, in case of sickness. Stood on a chair by the table, the device can be used to keep the coffee or chocolate hot during meal time. A round piece of sheet iron, with chains attached to suspend it from the hook, is an additional help, to hold a steeper for tea.

As this tripod can be taken apart readily, when not in use, it will be found a good adjunct to a

camping outfit, even though you carry a camp stove, for there will be times when nothing will be wanted but a hot drink, which can be made over the lamp with less trouble than it would be to make a fire in the stove.

### HOT WATER ALL NIGHT

One of the things that must be had quickly when medicine is needed, and still more often for a bottle baby, is hot water at night. The following contrivance has been found to be worth many times the trouble to make it, for it saves annoyance at a time when baby's worrying may mean hours of sitting up.

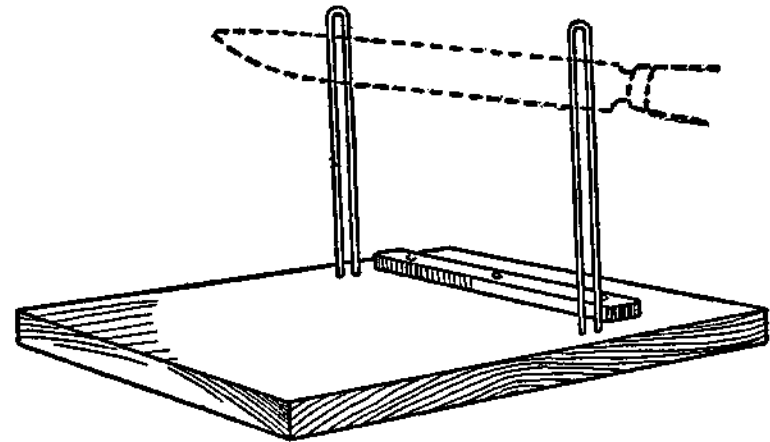
Place the socket of a wall bracket lamp just high enough above a table so that the top of a hand lamp chimney will be 5 or 6 inches below it. Make an arm of round iron or small piping long enough to extend out over the lamp and to this hang a hook, on which hang a small teakettle or pail. In this enough water for the needs of a night can be kept hot without boiling, and will be ready at an instant's notice. As a night lamp is a necessity in a house where there is a youngster, the cost of this device will be nothing, for the blaze of a small burner will provide sufficient heat. The proper height for the socket on the wall can be determined by measuring the hook and the kettle to be used. The lamp chimney should not be nearer than 2 inches to the bottom of the kettle, or the water will boil and steam away.

### HOW TO CUT BREAD EVEN

Here is one of the most useful devices to which the handy man can give his attention. It is very

rarely that a housekeeper can cut even and handsome slices of bread, however much she may desire to have the bread plate look attractive. One slice will be thin, another thick, while another will be thick on one edge and thin on the other. The drawing shows a simple arrangement by which all the slices of bread can be cut of an even thickness without any slant.

Cut a piece of pine board to about 9 x 13 inches. Near one end, on either side, insert firmly two



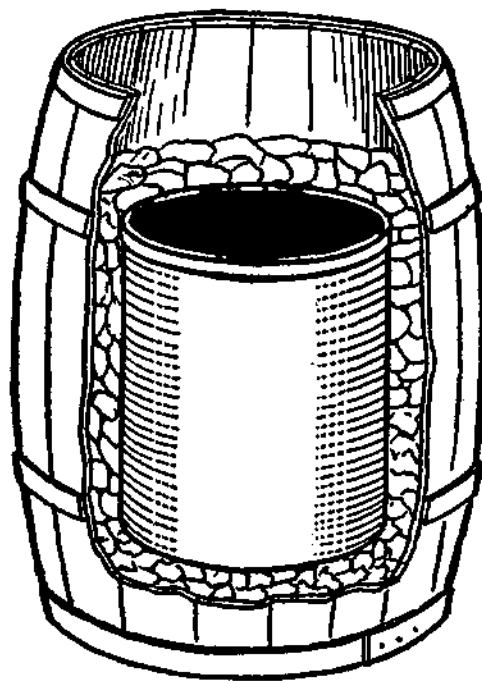
BREAD CUTTING BOARD

pieces of very stout wire, bent double, as suggested in the cut. These wire supports should be at least 7 inches high, and should have another inch of length firmly inserted in the wood. The wire should be as stout as No. 12, or larger still, and should stand exactly at right angles to the board. Put them far enough apart so the largest loaf will readily go between them, and have the opening in each wire standard just wide enough so the knife will slide up and down without "wobbling." The dotted lines show the position of the knife when

in place. Screw a little strip of wood in front of the wire, just far enough ahead to make the slice of bread the right thickness. Press the loaf up against this guide and cut off a slice, then press the shortened loaf up again, and repeat the process.

### HOMEMADE WATER COOLER

It's a mighty nice thing to have a good supply of cold water at the barn when threshers, corn



WATER COOLER

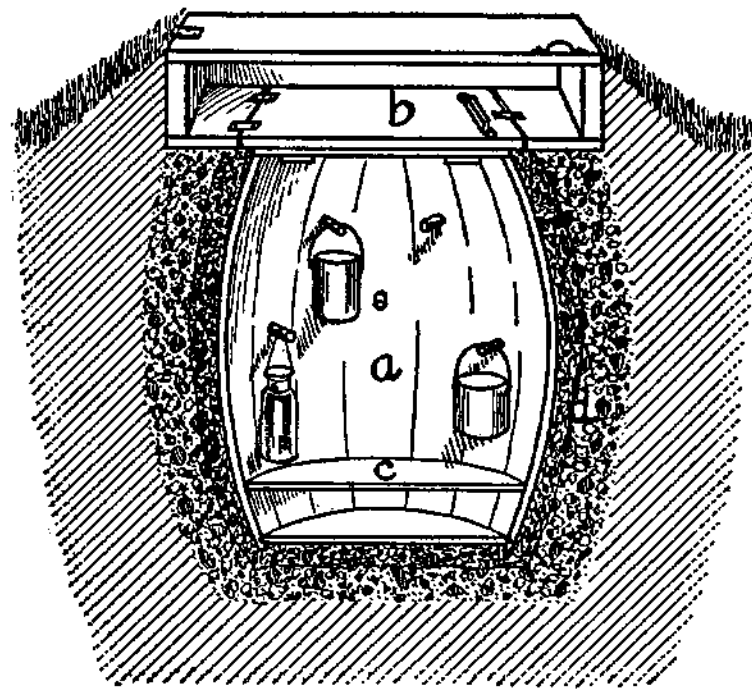
huskers, or hay harvesters are at work. A simple and effective arrangement can be made by using a flour barrel and a 10-gallon stone jar. Place the jar inside the barrel and surround it with charcoal, sawdust, or chaff, if nothing else is available. With a tight lid and a wet cloth spread over the top, water will keep ice cold in this arrangement.

### KEEP FOOD COOL IN SUMMER

A very convenient and serviceable place to keep dairy products may be formed by sinking a large

barrel in the ground. A shady spot should be chosen, or the heat of the sun will affect the temperature. Fill in around the barrel with small stones, gravel and sand, dampened in order to maintain coolness.

Construct a box around and above the top of the barrel, and bank up with solid earth, preferably



FOOD COOLER

clay. This drains off the water when it rains. It also makes the bottom of the barrel farther down from the top of the opening, which further promotes coolness. Next shape a light, inner lid to place on top of the barrel, and then make a strong, hinged lid for the box, and arrange it so it may be fastened down tightly.

Sprinkle a little dampened sand on the bottom of the barrel, and your little barrel cellar is ready for use. By being careful several vessels may be arranged one above the other in this handy little receptacle. Air out occasionally to prevent mold and odors from collecting.

### A COOLER DUMMY

Where a deep, cool well is located near the house an arrangement may be devised that will serve the purpose of a refrigerator. Construct a frame of strong boards with a groove in which a board on the side of the box of shelves can run. Attach a rope to the top of the box of shelves, pass it over a wheel on the crank shaft and balance with a counter weight.

If the frame is 16 feet long and extended down near to the surface of the water the lowest temperature may be secured. A nice looking top may be constructed for the arrangement, with a door opening into the shelves when they are drawn to the top. Most wells are almost as cool as a refrigerator, and this sort of an arrangement serves the purpose with a great deal less expense.

A wire clothesline will serve as a cable. Any old pieces of iron will do for the counter weight, and it is well to have a ratchet wheel, such as are found on old chain pumps, to prevent the elevator dropping when it is well filled. Make as many parts as possible of wood to prevent rusting. One such elevator is 42 inches high and 18 inches square.

---

Turning the grindstone is hard work; but if you use it as a muscle developer it will help out.

### AN OUTDOOR CLOSET

When the housewife has baked a pie or a pudding for dinner and wishes to cool it quickly in winter it has to be set out of doors; but there the trouble begins. It cannot be set upon the snow, since that would melt and engulf the hot dish. Moreover, the cat or dog, or some neighbor's cat or dog, is likely to be lurking about the door, ready for pie. Let the handy man make a little out-of-door cupboard for the use of the housekeeper, locating it beside the kitchen door. Get an empty grocery box of the right size and hinge the cover to the top, placing a knob on the other edge. Make a support for this closet by driving two strips of wood into the ground and screwing two crosswise strips of board to the tops. Lay the grocery box on its side on these supports and nail it to them from the inside.

Here anything hot can be placed to cool quickly, and with the cover down there will be no danger from cats or dogs or hens. If desired to give a freer access to the cold air, several holes can be bored in each end and in the bottom before putting the box in position on the supports. If the ground is frozen too hard to insert the strips of board, the closet can be placed against the side of the house, close to the kitchen door, and supported in place by two wooden brackets. Another plan to secure the same result would be to make the closet and screw a wooden handle to the middle of the top, with holes bored in ends and back. When it is to be used put the dish, or dishes, inside and set the closet out onto the snow beside the door.

---

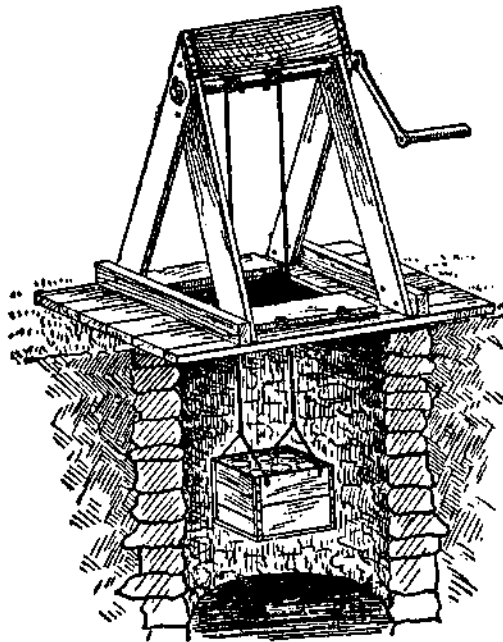
Taste the joy  
That springs from labor.—Longfellow.

## HOMEMADE REFRIGERATOR

Take two large boxes, one 2 inches smaller than the other every way, and bore two 1-inch holes in the bottom of each box for drainage. Fill up 2 inches in the large box with powdered charcoal or coal ashes. Put the smaller box inside and fill the space all around with the charcoal or ashes. Fix the lids to both boxes to fit tightly. Put shelves on both sides of inner box. Leave a place in the center of the box of ice. A rack, made of lath, can be laid at the bottom for ice to rest on.

## ICELESS BUTTER AND MILK COOLER

The accompanying picture shows how a well may be utilized during the warm months for cooling



COLD STORAGE FOR MILK

butter, milk and other perishable articles. It will be found very handy as a substitute for a refrigerator when the farmer has no ice supply. Anyone can make a triangular-shaped frame for the windlass, which is placed above the well; and anyone can also put the trap doors in the platform of the well. These doors should be pro-

vided with a lock, so children cannot fall in. A pin may be placed on the handle side of the windlass to prevent the crank from turning around when the box is lowered to the desired depth.

The picture is only suggestive. The shape and size of the various parts will depend upon the style of the well. Preferably, the box should be made of galvanized iron and have perforations in the bottom, so it may be lowered right into the water. Of course, this would not be feasible if the materials to be kept cold were not first placed in sealed receptacles. Where a well with a bucket pump or the ordinary wooden pump is the only available place to put such a cooler, the cooler may be at one side of the well. If necessary, the position of the pump may be shifted.

---

Knowledge is of two kinds. We know a subject ourselves, or we know where we can find information upon it.—Samuel Johnson.

Every addition to true knowledge is an addition to human power.—Horace Mann.

But now my task is smoothly done,  
I can fly, or I can run.—Milton.

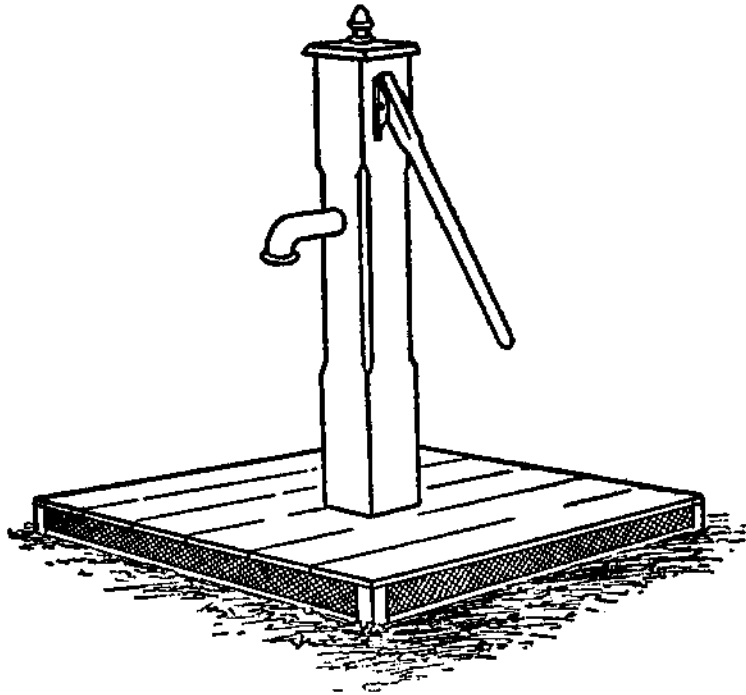
---

## A VENTILATED PUMP PLATFORM

Here is a way to keep the well clean and pure at all times. Make the frame of the platform of 2 x 4's, allowing a space 2 to 6 inches between the top and bottom parts of the sides. This space is covered on the inside with a fly screen to keep out dirt and



insects, and outside of this with a larger meshed screen to keep out large vermin. This gives good ventilation to the well, which never becomes foul. In the winter cover the platform with straw and snow.



HELPS TO KEEP WATER PURE

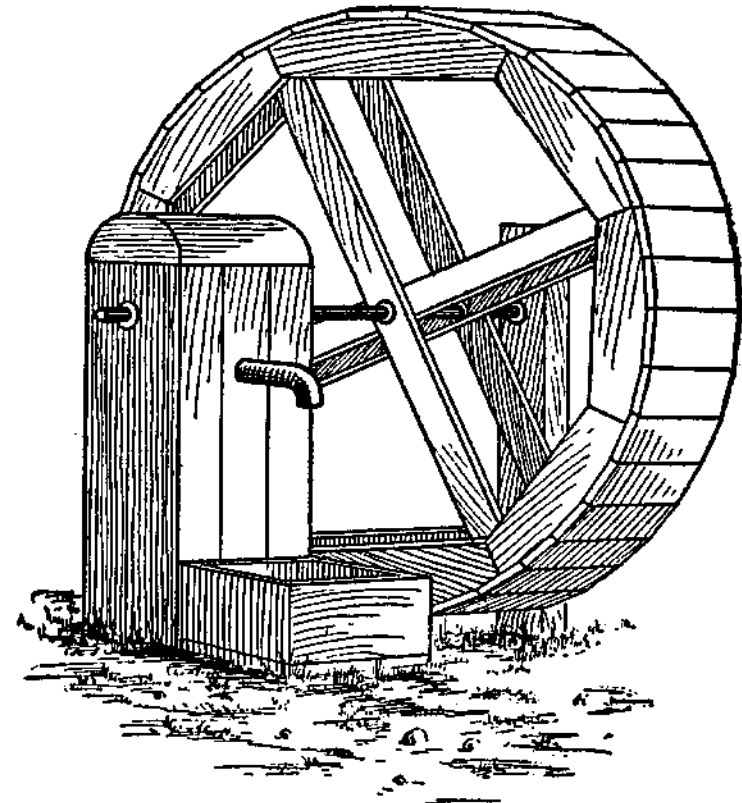
### CLEANING A WELL

To remove floating litter from a well, take an ordinary sand sieve, and, after marking off the rim into three parts, attach a wire to any of the two points and to this improvised handle attach a rope. Fasten the end of the rope to the third point in the rim and a weight to the sieve, so that it can be lowered into the well and will sink. When used, sink the sieve edgewise into the water and pull the

rope with a single attachment and it may be lifted out with all the floating sticks and timber on the surface of the water.

### DOG POWER FOR PUMP

This sketch shows an arrangement for making use of the dog for carrying water. It simply consists of a wheel 8 feet in diameter and 18 inches



DOG POWER PUMPING DEVICE

wide, with room enough inside for the dog to walk around, where he acts as a tread power, which causes the pump to revolve. In southern Califor-

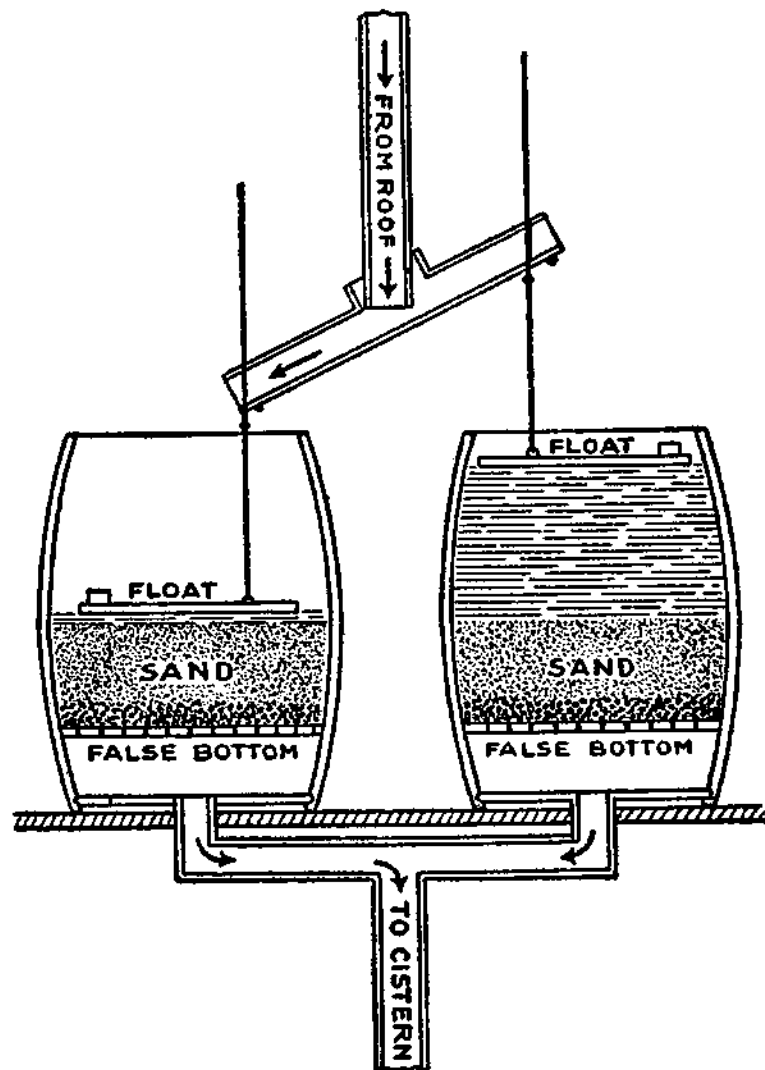
nia there are a number of these dog-power pumps, which cost less than \$15. A good-sized dog can easily earn his living in an arrangement of this kind.

### FILTER FOR CISTERN WATER

The problem of keeping water in a cistern clean is most easily solved by not allowing it to get dirty, as can be done by the device shown in the drawing on page 69. Two barrels, each with a perforated false bottom, are set side by side beneath the water spout from the roof and connected with a pipe leading to the cistern. Above the false bottoms fine gravel and then sand are packed to the depth of 8 or more inches. On top of the sand rest stout floats as large as can be let down into the barrels. From near the margin of the floats two heavy wires extend vertically upward about 2 feet to engage loosely near their centers with a tilting spout by means of knobs on both the ends of the spout and the wires.

When the barrels are empty the floats rest on the sand. As the water begins to pour in one barrel it strikes the float, but is prevented from gouging a very deep hole at the outside of the barrel by striking a strip of wood about 1 inch high, 2 inches wide and 1 foot long. This spreads the flow. A layer of gravel at this place would also help prevent gouging. If the flow is too great to filter away readily, the float will rise and the knob on the wire will engage with the spout, which will be tilted until the flow will suddenly start into the other barrel. If the delivery pipe to the cistern be large enough there should be no danger of either barrel overflowing. When the sand becomes dirty

a few minutes will serve to remove it and put in fresh. This will insure clean water in the cistern, and greatly reduce the number of times the disagreeable job of cleaning out the cistern must be done.



TWO-BARREL FILTER

## A HANDY WATER FILTER

Nearly every farm can boast of good water, but no water, either from well, spring or stream, is pure, as it all contains more or less animal or vegetable matter. The only way to make it pure is to filter it, just as is done in city supply reservoirs, or private filtering tanks.

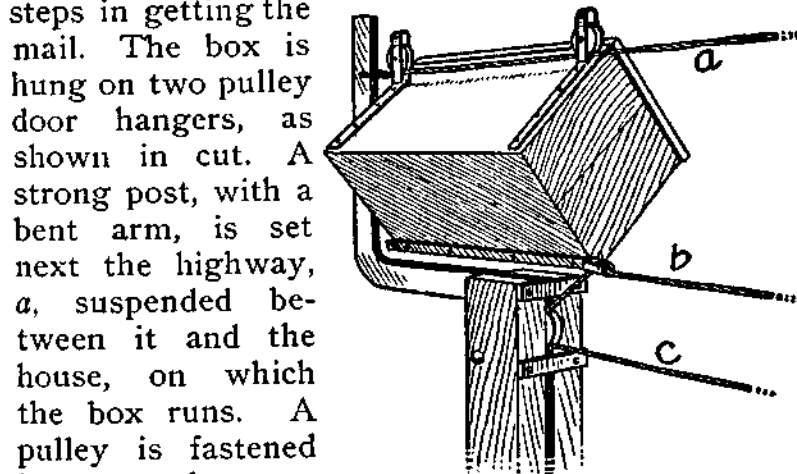
A simple water filter is very easily made that answers all purposes for domestic use. The plan of its operations is identical with that employed in large reservoirs where water is filtered on a large scale for general distribution. This filter consists, primarily, of two flower pots, set one above the other. In the bottom of the upper pot is stuffed a large sponge. A sponge is also stuffed in the bottom of the lower pot, but it is more adequately supplied with filtering material by placing above the sponge a layer of smooth pebbles, then a layer of coarse sand, and still above this a layer of pounded charcoal 3 or 4 inches in depth. It is also best to place another layer of smooth pebbles above the charcoal, to prevent it from being stirred up during the circulation of the water.

The upper pot should be the largest, and if the lower one is strong, the upper one may stand in it, or two strips of wood will serve as a base support. The two pots thus arranged are placed on a three-legged stool with a hole in it, through which the water drips through the bottom of the lower pot into the mouth of a jug set underneath. The upper pot serves as a reservoir, and its sponge stops the coarser impurities, and thus the filtering layers of the lower one may be used for a year without being renewed, though it is necessary frequently to clean the sponge of the upper pot.

The layers of sand and charcoal of the lower pot are positively effective in stopping all animal and vegetable matter, as well as many smaller impurities in the water. The only trouble one may experience with it is in neglecting the upper sponge for too long a time, or in stuffing it in too loosely, thus allowing the water to pass from the upper pot faster than it can filter through the lower one. Only a little attention, once or twice a month, is sufficient to keep this simple filter in perfect running order.

## DELIVERING MAIL BY TROLLEY

Where the house stands some distance back from the highway a trolley can be rigged up to save steps in getting the mail. The box is hung on two pulley door hangers, as shown in cut. A strong post, with a bent arm, is set next the highway,

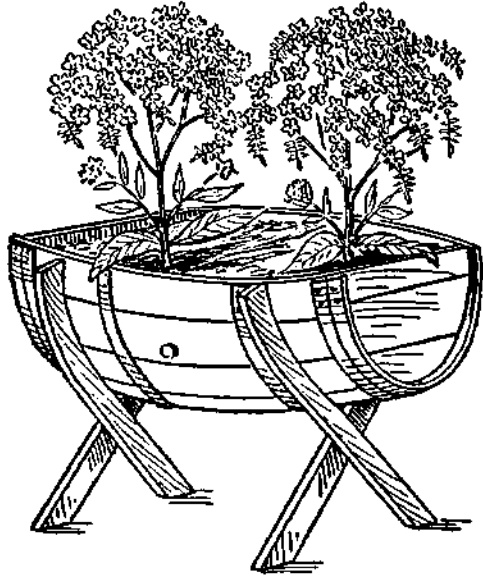


TROLLEY MAIL BOX

next the highway, *a*, suspended between it and the house, on which the box runs. A pulley is fastened in or to, the post, and over it runs a cord, *b*, *c*, to pull the box back and forth between the house and the road. The box is sent down to meet the carrier, who places the mail in it, and then it is quickly pulled back to the house.

## BEAUTY IN A BARREL

A very nice ornamentation for the lawn is shown in the picture. It is made by sawing an oil barrel



HALF-BARREL PLANT HOLDER

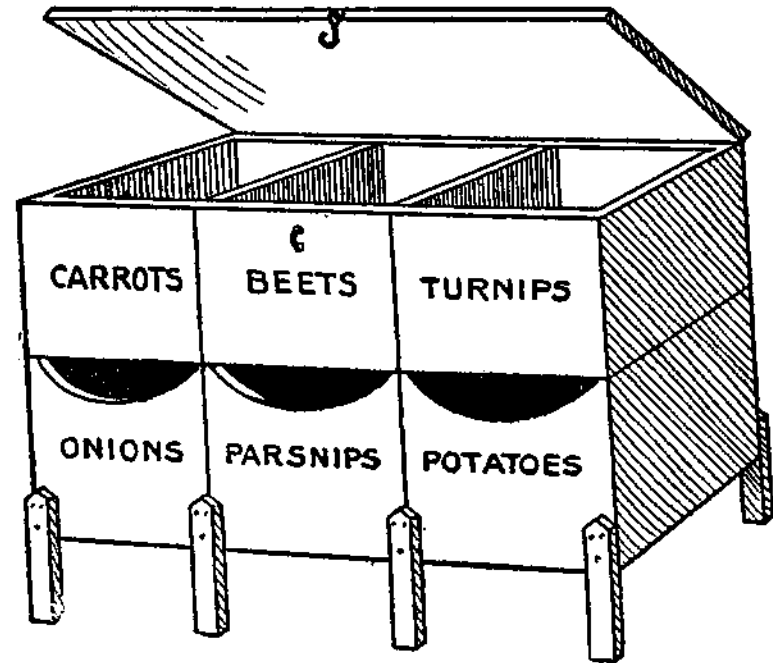
in two as shown, and mounting it on legs. Paint it and set one-half of the barrel on each side of the walk and use them for growing flowers in during the summer. Care should be taken to have the hoops thoroughly nailed to the staves and to have the heads solid. Dark green or dark red are good colors for the painting. If preferred,

the barrel may rest upon the ground, but should be securely braced or blocked to prevent rolling.

## STORAGE BIN FOR VEGETABLES

Instead of keeping the vegetables in barrels or boxes scattered all over the cellar, have a set of storage bins. Take six drygoods boxes and bolt them together as shown in the drawing. Put legs on them to hold them off the floor and a cover on the top. Then paint on the boxes the names of the

vegetables. It is most convenient to have the vegetables most frequently used in the upper boxes, which would not be true of the bin shown in the picture. If the upper row of boxes is attached to each other, but not to the lower ones, the top section can easily be moved enough to make filling the lower boxes a simple matter. Otherwise, the vegetables



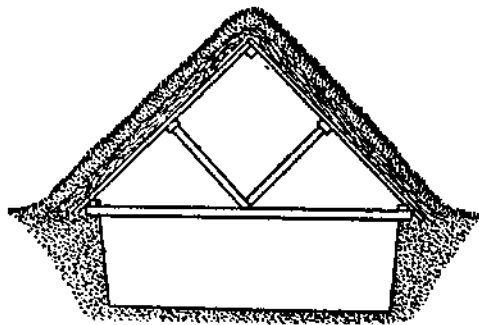
VEGETABLE BIN

would have to be put in through the openings at the top of each box a few at a time by hand, instead of pouring them in.

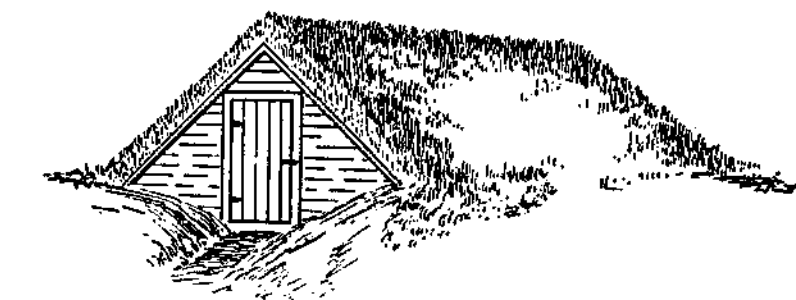
Many people would not care to keep their potatoes in such a sectional bin, preferring a large separate bin. It certainly is all right for other root vegetables, and many other products of the farm that are stored might well be kept handy for use in such a labeled sectional bin.

## AN INEXPENSIVE CELLAR

A temporary cellar is sometimes necessary in cold countries where that under the house is not sufficient for storing vegetables. A very effective and useful temporary cellar may be constructed after the following method, as shown by the drawings: Dig a pit 15 feet long, 10 feet wide, 4 feet deep in a solid, dry place where the drainage is good. Put a gable roof of 1-inch board over the hole, supported by 2 x 4-inch strips at the eaves, gable and half way up the sides. Strengthen by crossbeams and a central support if the lumber is not first class. Over this place 8 to 10 inches of dry straw



CROSS-SECTION



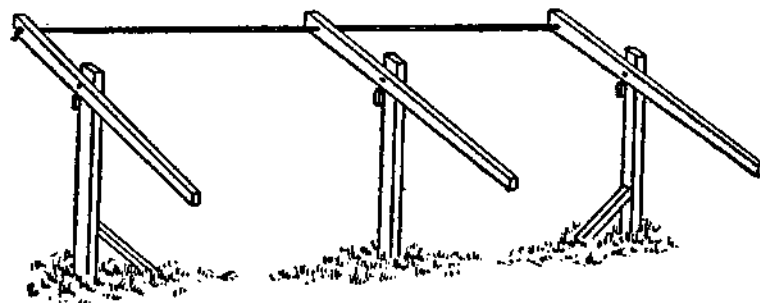
TEMPORARY CELLAR

well packed and over the entire structure, excepting one end, pack earth 12 to 14 inches deep. The surface should be smooth to shed water. It is better if plastered with mud covered with sods.

The door end must be double-walled and the space filled with straw. The door must also be double and its margin packed with cloth strips, so as to be practically airtight. If possible, the pit should be drained by a tile, the end of which is covered with a piece of wire netting to prevent the entrance of rodents. Such a cellar will prevent freezing during usual winter weather. The door should be opened on mild days and the interior aired thoroughly. The size and depth of the pit may be varied according to needs.

## CLOTHESLINE UP AND DOWN

Heavy posts should be set for the ends, 3 feet in and 3 feet out of the ground. It is not necessary for the center post to be as heavy as the end ones. Have the posts clean and smooth, so they will not soil the clothes when blown against them. Take a



ELEVATED CLOTHESLINE

piece of 2 x 4-inch hard wood 5 feet long for the lever. Fasten to the post near the top with a  $\frac{3}{4}$ -inch bolt, 2 feet next to the line and 3 feet for the lever. A block holds the lever in position while the clothes are being put on. A button holds the lever upright when the line is hoisted.

## A CLOTHES HORSE

There is no little thing that will save the household so much as a revolving clothes horse, so near the back stoop that the clothes may be hung on it without stepping out in the snow. A solid post should have a hole bored in the top and the arms may be beveled and spiked to a piece of plank through which a bolt passes into the post, or each arm may be bored to let the bolt pass through it. Three, four or five arms may be used as desired, and of any length, provided all are of one length. No skill is required in making it, as the rope holds the arms up simply by being tight enough. It is well to set the post before measuring for the arms, so that they may be sure to reach the veranda. Some laths may be nailed together at first to make a model, if you are not sure of your ability as a carpenter.

## A TOILET CLOSET

A small closet in a home, for keeping medicines and toilet articles, is a great convenience. One consists of  $\frac{1}{2}$ -inch pine, 4 inches wide, planed and put together so as to be 2 x 3 feet. It has four shelves. The door is of thin pine, free from knots, planed, hinged and with a back catch. The outside of frame and door is varnished. Being in the toilet room, it is indeed a very useful as well as ornamental piece of furniture. It has no back casing or boards; simply rests against the wall. It is held in place by four short pieces of band iron, one end of each band being fastened to back of frame, the other end fastened to the wall by a screw. All

kinds of medicines, shaving materials, soaps, wash rags, can there be kept. If there is no other looking-glass in the room, one may be fastened on the outside of door.

## REVOLVING CELLAR SHELF

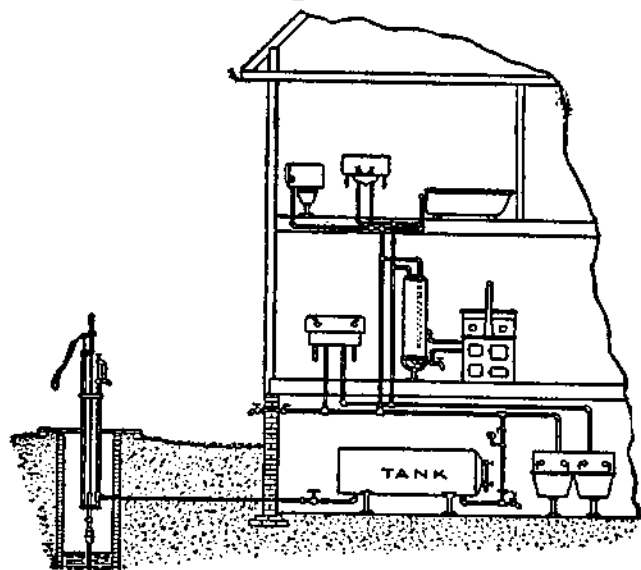
A handy cellar shelf that will save the housekeeper many steps may be arranged at the side of the cellar stairs, within easy reach upon descending a few steps. The shelf is contrived from an old axle and wheel. The axle is fastened to hang from the nearest beam to the stairway. The wheel is covered with thin, smoothly planed boards and the axle is kept well oiled, so the wheel will revolve readily, bringing all parts of the shelf within reach at need.

## WATER SUPPLY FOR FARMHOUSE

Farmers can have running water, hot or cold, in their dwelling houses at a cost of fifty dollars and up, depending upon the size of the house and the kind of equipment needed. This makes possible the bath and toilet room, protection from fire, the easy washing of windows and walks, the sprinkling of lawns, the irrigating of gardens, and all the other conveniences which a few years ago were thought possible only in cities, where big water systems were available. This is one of the things that makes farm life attractive. It lessens the work in the house, insures a fine lawn and garden, reduces danger from fire, adds greatly to comfort and convenience in every direction.

The way to secure this is to install a water supply system, with a pressure tank in the basement.

This pressure tank is so arranged that by pumping it full under strong air pressure the water is forced all over the house, and is available for the bathroom, toilet room and the garden or fire hose. The water is distributed about the house exactly as it is in city homes, by means of galvanized iron pipes. Where a small building is to be supplied and the



HOUSE WATER SYSTEM

amount of water to be used is not large, the system can be installed for \$50. For the average house \$90 is a better figure. Where the house is large, and where considerable amounts of water are needed for the lawn and garden, and possibly also for washing carriages, automobiles and horses, a larger system should be installed, costing up to \$150.

#### Installation and Operation

Its installation is easy, and its operation is exceedingly simple. Any pipe fitter or plumber can

put in the plant so that it will work perfectly. All that is needed for operating is to keep the tank pressure up to the desired point. This may be 20, 40, 60 or 100 pounds. A few strokes of the pump, if the work is done by hand, is sufficient. If a lot of water is used, of course the amount of pumping will increase. By being economical in the use of water, that is to say, wasting none, this matter of pumping is not at all a serious problem.

The most satisfactory method of pumping, however, is to use a windmill, or what is much better, a gasoline engine. Every up-to-date farm ought to have a small gasoline engine, which can be utilized not only for operating this water supply system, but for churning, sawing wood, cutting feed and doing a dozen and one other jobs about the farm. It would take only a few minutes of pumping to raise the pressure in the tank the desired height. With the engine it will not be necessary to be economical in using water, provided the well is a good one, and the supply of water large.

#### Experience with Water Supply System

C. A. Shamel of Illinois, editor of the Orange Judd Farmer, has a system of this kind in his country home. It cost \$75. He put in a bathroom, a toilet, has a hot water tank in connection with the kitchen range, and no money ever expended on that farm has given anything like the amount of satisfaction and comfort as that paid for this water supply system. Arrangement is made to take care of the waste water and sewage by running a large tile from the bathroom, one-quarter of a mile distant, to a large cistern, located in the center of a big field. This is disinfected about

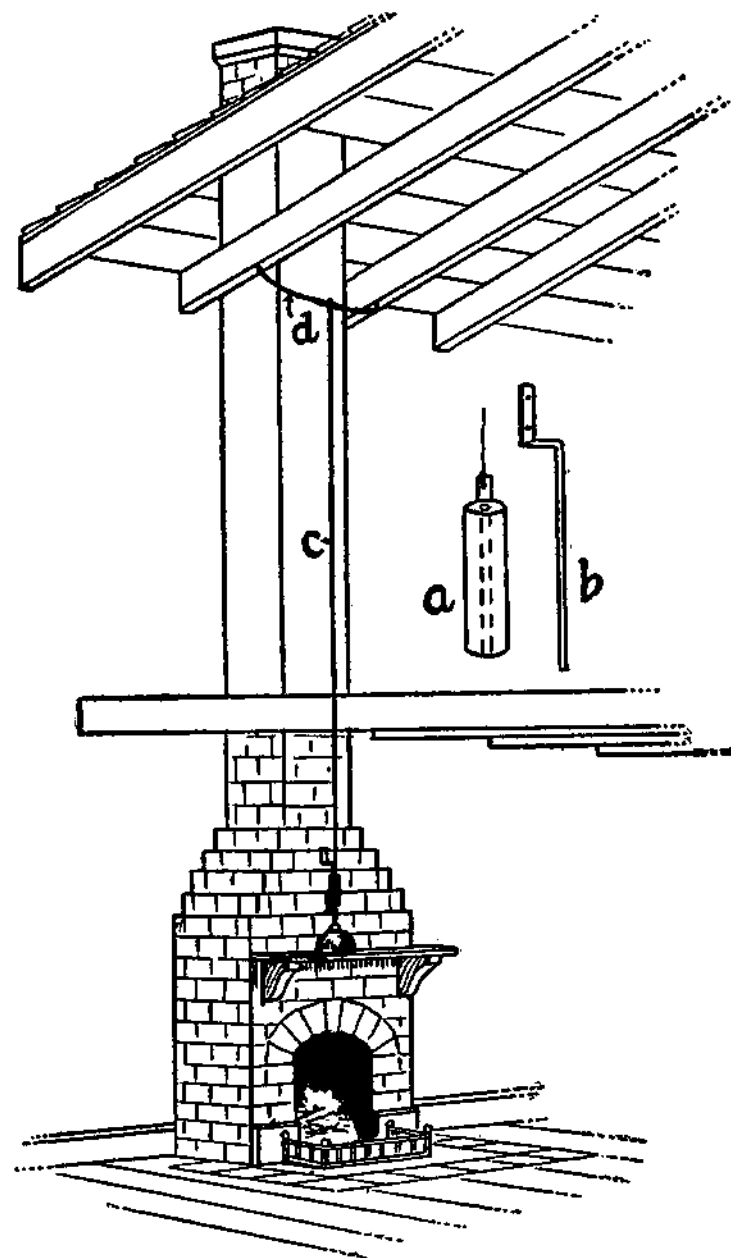
twice a year, and is easily handled. There is never any trouble with the water pipes, even during the coldest weather. Neither has there been any difficulty with the waste system. In fact, the water supply is practically perfect, and the people on that farm don't see how any farmer who can get together \$75 or \$100 can afford to be without it.

Up to date all the pumping has been done by hand. With the pump in perfect condition, this is not a laborious problem. On two occasions the pump valve became slightly defective through wear, and it was not convenient to fix it for a few weeks, being somewhat distant from the factory. With this condition it required a great deal more labor to do the pumping, but even with this disadvantage, it was not a serious proposition.

The illustration indicates the arrangement of a water supply system, and as can be readily seen, it is very simple. Notice the hand force pump tank in the basement to hold the water under pressure, and the arrangement of lavatories, bath and kitchen hot water service. The system can also be used for supplying water to stock tanks, and these may be located anywhere on the farm. The pressure developed in the tank is sufficient to force the water anywhere wanted. This use will, of course, depend entirely upon the wishes of the owner and is simply a matter of cost of pipes. It can very readily be used for delivering water to dairy or other stock barns, where it can be run into water troughs in the stalls, or elsewhere, as desired.

### WARNING AGAINST FIRE

A handy device that will give an alarm in case the roof catches fire close to the chimney is shown



A FIRE ALARM



on the opposite page. Drive a nail in two rafters on a line with the face of the chimney, to which stretch a cord close to the chimney, so that, in case of fire, the cord will burn off and release the weight hanging to it, which in turn will drop on an electric button and ring a bell. A dry battery will cost 20 cents and a bell 50 cents. Place these on a shelf above the fireplace. Place a piece of heavy wire, *b*, 10 inches long, as shown, and fasten to the wall or chimney for the weight, *a*, to slide on. The weight need be suspended only an inch or two above the bell.

### WHERE TO HANG A FIRE LADDER

A necessity on all farms and near all farm buildings are ladders and other means of getting on the roofs, and in and out of upper story windows in time of emergency. A scuttle should be left or made in the highest part of the house roof and a ladder should be at hand that will reach the eaves of the highest roof. A good place to store a ladder of this kind is under the eaves of the L or along the rear wall of the house. Have two hooks to hang it on. Make a good ladder and keep it painted.

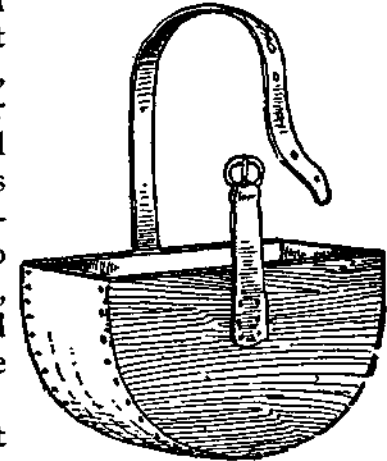
If your cellar is dark, there is danger of accidents when going down the stairs. Have the last step whitened so that you may easily know when you are at the bottom. You can see this step plainly even in a dim light.



### A HANDY FEED BASKET



PROVIDE a feed basket like this to strap upon the nose of a horse when giving the animal feed while away from the stable. It is simpler to make than the round basket, and has an added advantage. When not in use, the two sides press together and occupy scarcely any room. Cut out two semi-circular pieces of wood from a  $\frac{3}{4}$ -inch board in the shape suggested in the cut. Setting them at the proper distance apart, tack a strip of canvas, or other stout cloth, around the curved partition, as shown in the accompanying picture. Nail a strap and a buckle at the sides, to go over the head, and the feed basket will be complete.



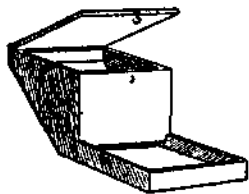
FEED BASKET

The form of this basket more nearly fits the shape of a horse's head, and besides, because of its oblong shape, gives the horse more freedom in opening his mouth than does the close-fitting round basket.

He who will not be counseled cannot be helped.

## MAKE THE HORSE EAT SLOWLY

If your horse has the habit of bolting his feed you can easily remedy it by making a self-feeder on his box. The accompanying drawing shows how a feeder may be made similar to a poultry feed hopper. The contrivance may be made of inch boards large enough to hold one feed. The horse can get the grain only in small quantities and so cannot eat it more rapidly than he should. The bottom must be made with enough slant to insure all of the feed coming out in the trough.



HOLDS ONE FEED

---

I am only one,  
 But I am one.  
 I cannot do everything,  
 But I can do something.  
 What I can do I ought to do;  
 And what I ought to do  
 By the grace of God I will do.

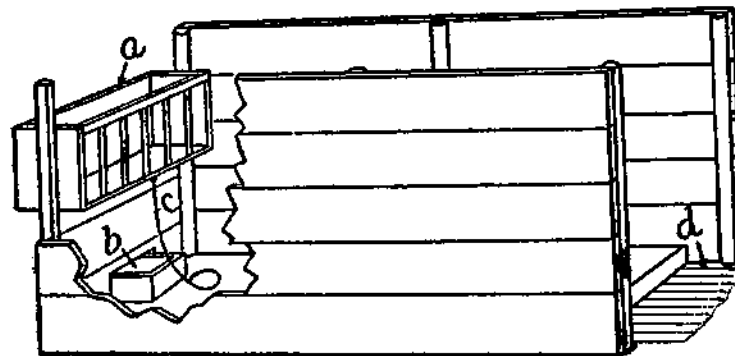
---

## STALLS BETTER THAN STANCHIONS

The only point in favor of stanchions is that they take up less room than stalls, but the increase in milk is a reward for allowing more space and convenience to each cow. The cut shows one kind of stall. The rack, *a*, is of hardwood 30 inches high, with the slats wide enough so the cow can thrust her nose through up to her eyes.

The bottom of the rack is 18 inches wide, extending into the stall toward the cow. The feed

box, *b*, slides through an opening in the stall on the barn floor. It can be drawn into the feedway, cleansed out and a new feed put in without being disturbed by the cow. The halter strap, *c*, is just long enough to allow the cow to lie down comfortably. The gutter, *d*, is 8 inches lower than the



PLAN OF COW STALL

stall floor. When she lies down she will put her head under the rack in kneeling and when she gets up, she will move backward so that she can look through the rack. The length and width of stall can be made to suit the cows. Small breeds, like Jerseys and Ayrshires, will need about 6 inches less each way than Holsteins and Shorthorns.

---

Knowledge is proud that he has learned so much;  
 Wisdom is humble that he knows no more.

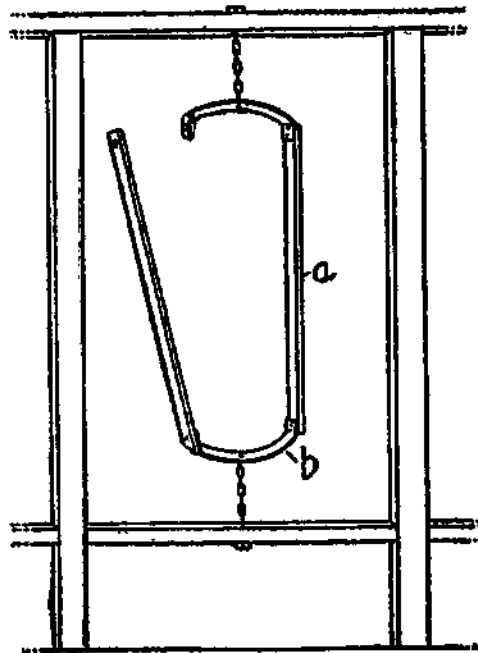
—Cowper.

The man who is always poking his nose into other folks' business rarely has any of his own worth attending to.

There is no knowledge that is not power.—  
 Emerson.

## GOOD TIES FOR COWS

The merits of stanchions and other forms of cow ties have been debated by dairymen for a long time.

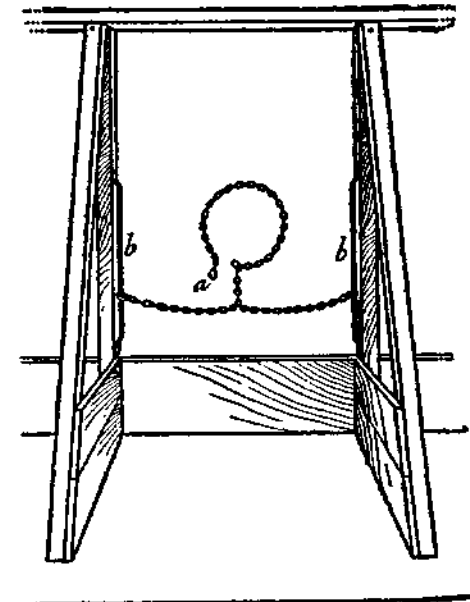


SWINGING STANCHIONS

The mass of experience is in favor of the tying arrangement which will give the cow the most freedom of movement. The old-fashioned solid stanchion fails in this respect. In many cases it is difficult for the cow to lie down or get up with her head fast in one of these stanchions. The heavy swinging stanchions have advantages over this, but it also must be criticised in many cases, because of its weight and of the consequent lack of freedom on the part of the cow. A very light swinging stanchion is the best type of that form. It is easy to fasten, as the cows will in most cases put their heads in position as they go into the stall. There is not so much danger of the dairyman being struck by the horns of the cow in fastening these stanchions. Many modern barns are equipped with this kind.

The chain tie is favored in many sections. This consists simply of a crosschain with considerable slack, attached to a ring at each end which runs over a perpendicular iron rod about 18

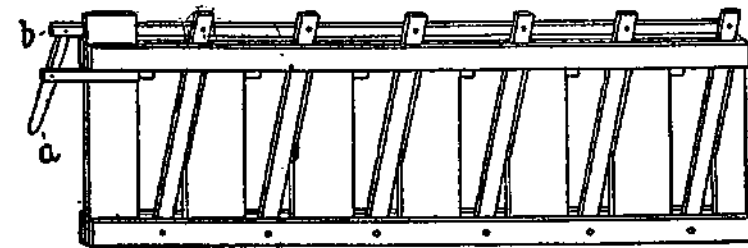
inches long. In the center of this chain is a loop with a snap which goes around the cow's neck. This arrangement gives the greatest freedom, and allows the cow to lie down and get up without difficulty. If light partitions are used between the heads of the cows no difficulty will be experienced in their striking each other with their horns. This is by far the least expensive of cow ties, and is at the same time one of the most satisfactory.



NECK CHAIN

## HANDY CALF-FEEDING DEVICE

To feed a half-dozen calves at once is entirely possible if one uses the device shown here. A man



STANCHIONS FOR CALVES

who has one reports no more trouble with calves since he has used this. He rattles a couple of

buckets together, the calves come running up to the fence and soon have all their heads through the stanchions, to which they are easily fastened by throwing down lever, *a*, which draws the bar, *b*, into position. Then one may feed each calf without difficulty.

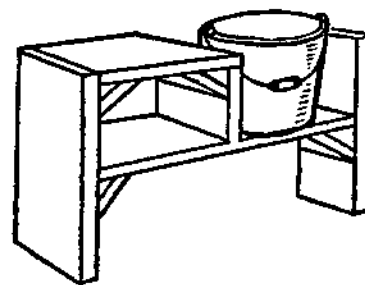
Leave a 4-inch space for the calves' heads. Make the rack of 1-inch lumber and it can be moved from one pasture to another and attached to the fence or a couple of posts. It can also be used for holding ewes at lambing time.

### MANAGEMENT OF KICKING COWS

Make a slatted stall just high enough so the cow can't jump out, and wide enough to hold her comfortably, with nothing to spare, and narrower at the end, where her feed box should be placed as high from the ground as is comfortable for her to eat out of. This slatted stall should be long enough to have cleats through which a bar or two should be run behind the cow to keep her from backing out, and also places to run a bar in front of her hind legs about the hock joint, or as high up as possible so as not to interfere with milking. A hole about 18 or 20 inches wide is left open for this purpose from the ground up to the cow's flank, which allows easy and safe access to the udder, while the cleat and post prevent the cow from kicking outwardly at the milker, thus insuring safety.

### A HANDY MILKING STOOL

Milkers who have trouble with restless cows that invariably either upset the pail or get a quantity of

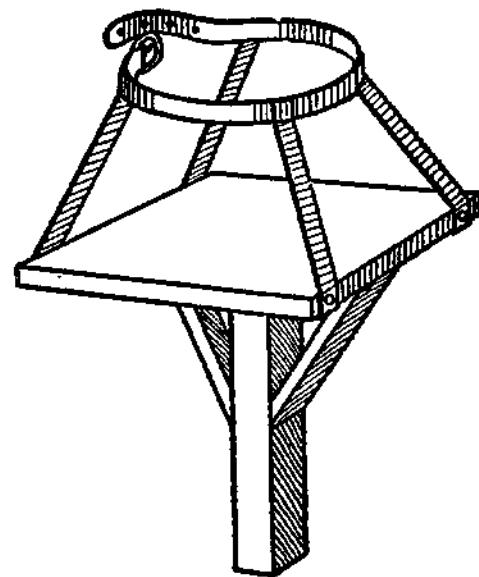


STOOL TO HOLD PAIL

dirt in it will find the stool shown here a remedy for their troubles. It is also very serviceable in fly time. The upright pieces forming the legs and ends of stools are made of 2 x 8-inch pieces about 1 foot long. The supports for the bucket and the seat are made of inch boards. To secure rigidity it is well to put three-cornered blocks under the seat and bucket board as brace stays. The most restless cow is not likely to upset the bucket from this stool.

### THE EVER READY STOOL

A very convenient stool for use in milking the cow in yard or field is shown in the cut. It is merely a one-legged stool to which is attached four straps connecting with a broad strap that is buckled around the waist. The stool is quickly fastened to the milker and is always in a position so one can sit down anywhere. Such a stool with a short leg would also be useful in the garden. Of course, if one pre-

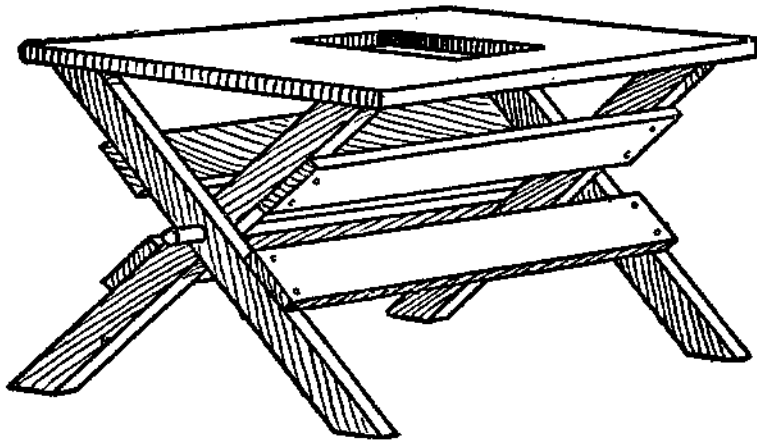


MILKING STOOL

ferred four legs instead of one, the stool could be so made, but experience proves that the one-legged kind serves well.

### CHEAP MILKING STOOL

A cheap and very useful milking stool is made of the reel from which barbed wire has been removed. Saw off the ends so it will set level and



REEL STOOL

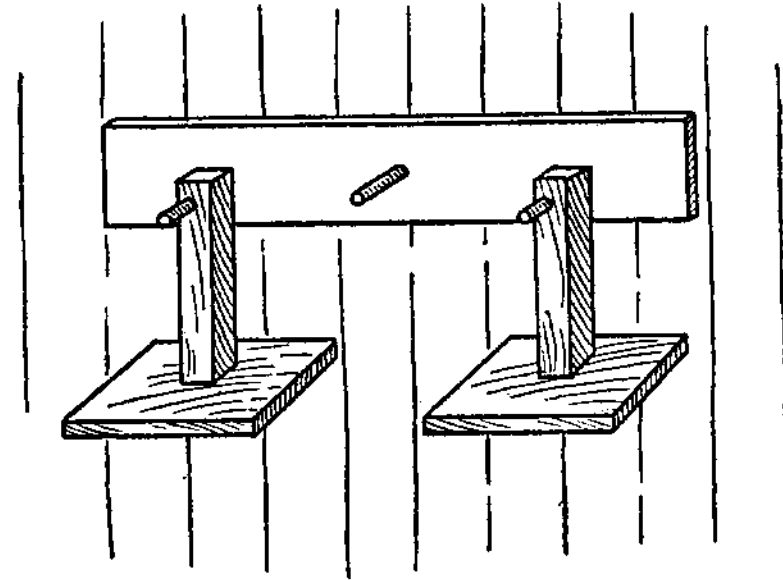
cut a board to fit on top. Make a hand hole through the board as shown in the illustration and the stool is ready for use.

### KEEP STOOLS CLEAN

Much milk contamination is undoubtedly due to the careless handling of the milk stools. When the milker is through milking one cow he gives the stool a toss, then he picks it up again when he starts to milk the next cow and his hands become more or less contaminated from the stool and from

them the dirt drops into the milk pail during the milking.

When the milking is over, the stool is left in the yard or on the barn floor. It is so easy to make a small rack and to bore holes in the legs of the



STOOL RACK

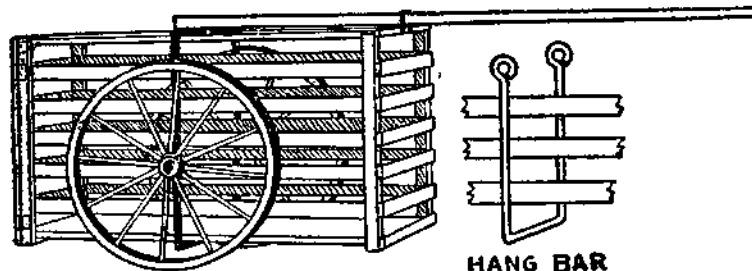
stool, so that they may be hung up. This keeps them out of the dirt and it is only necessary to brush them off carefully once in a while to keep them scrupulously clean.

The man who is constantly changing his mind usually has little to change.

### A USEFUL STOCK CART

Here is a handy transfer cart, made with wheels and crossarch of an old corn plow to carry a hog

or sheep, pigs or a calf. Raise the tongue, which lets the rear end on ground, then drive in the animal,

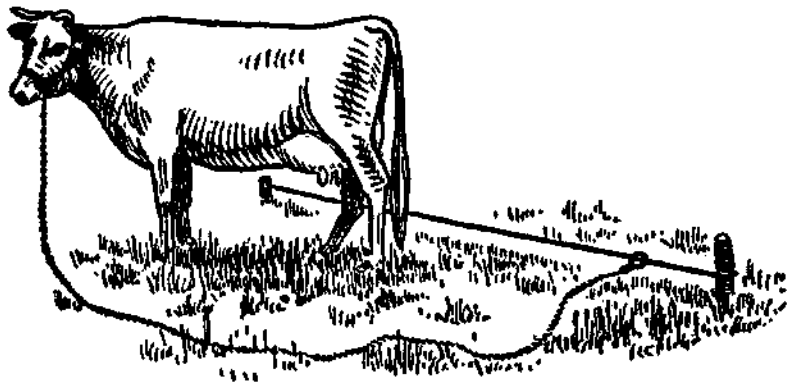


TRANSFER CART FOR SMALL ANIMALS

shut the gate, pull tongue down and you have your load ready to fasten to a wagon.

### HOW TO STAKE OUT STOCK

A convenient and simple contrivance so that no harm can come to the animal is to drive two stakes several feet apart and stretch a rope or wire on

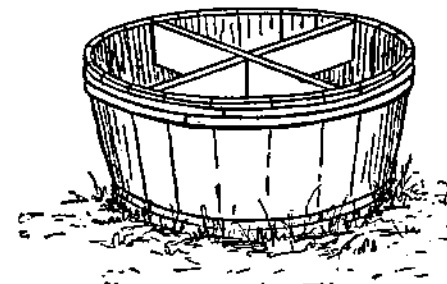
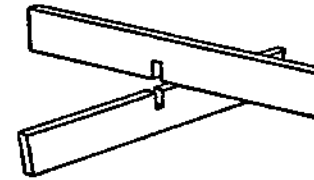


COW TIED OUT TO FEED

which a ring is placed. To this ring fasten halter strap. The animal can graze up and down on both sides without tangle or injury. The ring slides, and the stretched wire will give some.

### FEED BOX FOR FIELD

A handy feed box for use in open lots or when steers are being fed upon grass is shown in the



TUB FEED BOX

cut. Cut a barrel in two and strengthen the halves by placing a frame of two boards across the inside, as shown in this sketch. This will prevent the tub being smashed and will allow four animals to eat out of the trough without bothering each other unnecessarily.

It is important that a very strong barrel be selected and that the hoops be nailed to each stave.

Be advis'd;

Heat not a furnace for your foe so hot  
That it do singe yourself: we may outrun,  
By violent swiftness, that which we run at,  
And lose by over-running.—Henry VIII.

Have more than thou showest,  
Speak less than thou knowest,  
Lend less than thou owest,  
Ride more than thou goest,  
Learn more than thou trowest,  
Set less than thou throwest.—King Lear.

Use or practice of a thing is the best master.

## CHEAP SHEDS OF STRAW

It would pay every farmer to put up in the pastures some kind of protection for his sheep, hogs and cattle. Where labor is scarce and hay and straw is plentiful and cheap, a condition which prevails in many large sections, straw sheds and barns are very profitable. Put up a framework of posts 8 feet high, 16 feet wide and as long as needed; 30 feet is a good length.

The posts are hewed evenly on two sides and set so that a bale of straw will fit snugly between them. They are cut off at a uniform height and a 2 x 6 spiked securely on top. Rafters are nailed to this and covered loosely with poles. Baled straw is used for the sides.

After the sides are up the roof is covered 2 feet deep with loose straw held in place with a few poles that are tied together in pairs and placed over the ridge. Several of these sheds have been built for five years and have not needed any attention.

---

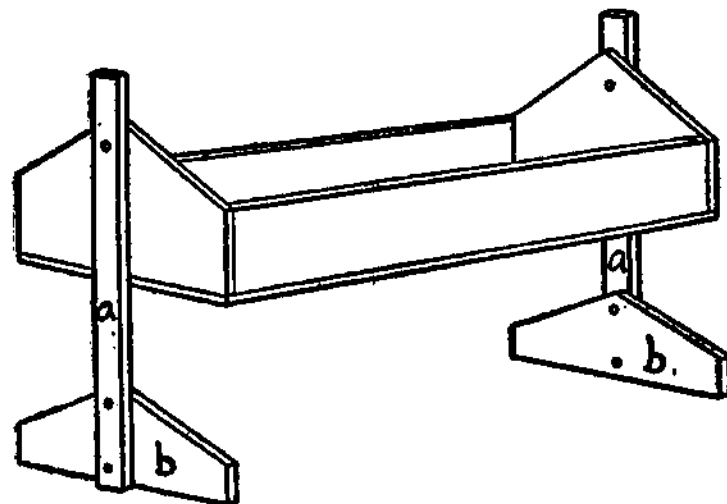
Life is made up not of great sacrifices or duties, but of little things, in which smiles and kindness, and small obligations given habitually, are what win and preserve the heart and secure comfort.—  
Sir H. Davy.

You must cut your coat according to your cloth.

## FEED TROUGH FOR SHEEP

For a sheep trough procure two 6-inch boards, *a*, about 3 feet long and at the bottom of each fasten another board, *b*. Make a flat trough and let the

ends project above the top. Bore a hole through each end and also through the standards, *a*, and hang the trough on bolts. After the sheep eat and



SWINGING SHEEP TROUGH

leave the cobs, or if it rains, the trough can be turned bottom side up and quickly cleaned.

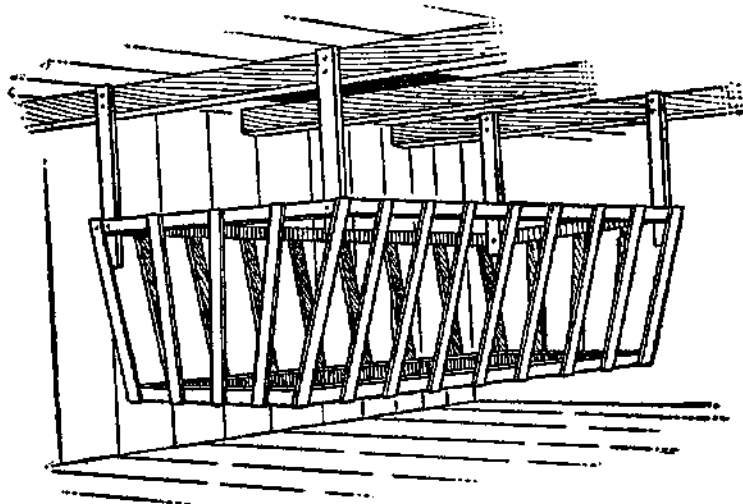
---

The luck that I believe in  
Is that which comes with work,  
And no one ever finds it  
Who's content to wish and shirk.  
The men the world calls lucky  
Will tell you, every one,  
That success comes, not by wishing,  
But by hard work, bravely done.

## A NOVEL FEED RACK

An overhead manger, as shown in the sketch, is excellent for sheep or calves. It should hang just high enough so that they will pass under with-

out rubbing their backs. When filled with hay from above they will eat of it at their pleasure, and at the same time it will not take up floor space.

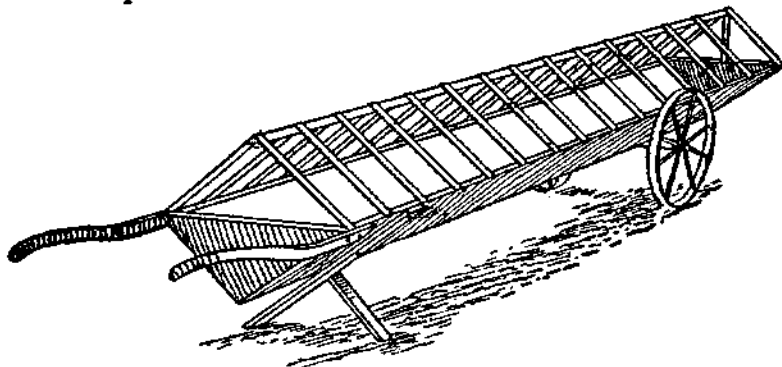


HANGING RACK

Such a manger is not suitable for grains or fine cut fodders, as too much may be wasted.

### A WHEELBARROW SHEEP TROUGH

It very often happens that one wishes to run the sheep on several different pastures during the



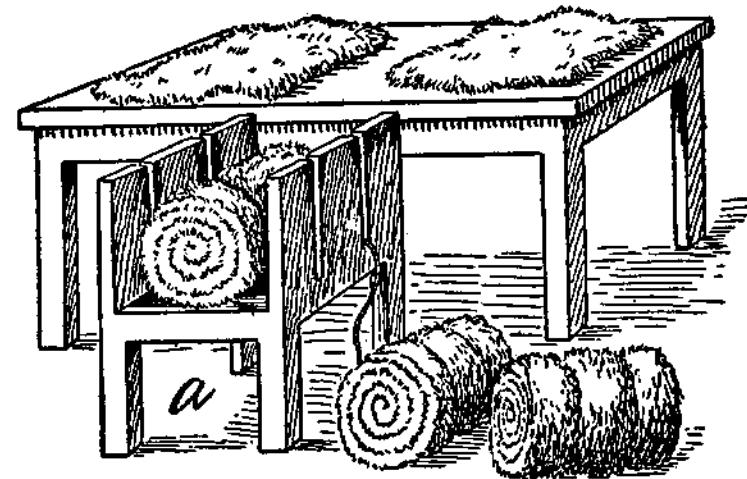
PORTABLE RACK FEEDER

season. If heavy feed racks are used it is quite a task to move them. The drawing shows a rack that can be easily moved from one field to another by one person. It is simply mounted upon a pair of wheels and has handles on the other end.

If the rack is made very large, it can be easily attached to a wagon, and thus drawn from place to place. The one shown is mounted on old cultivator wheels.

### PACKING THE FLEECE

One of the best ways to pack a fleece is to lay it upon a table, turn in the head and tail, then the



FLEECE TYING BOX

flanks. After this roll it up into a neat roll and tie firmly, using such a device as here illustrated.

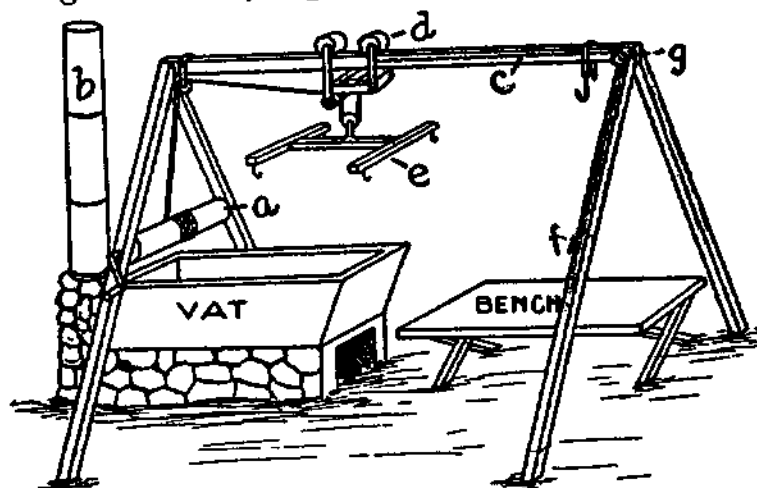
The tying box is made from light lumber with slots, as shown, through which the rope is passed. The fleece is placed upon this rope and the roll easily tied. Wool buyers prefer to have the fleece



loose, light to handle and elastic and tied up so that it can be opened if needed.

### EASY TO HANDLE HEAVY HOGS

The old fashion of having a lot of help around at hog-killing time is going out, owing to the use of better appliances for handling the animals after killing. You may rig up a simple arrangement so



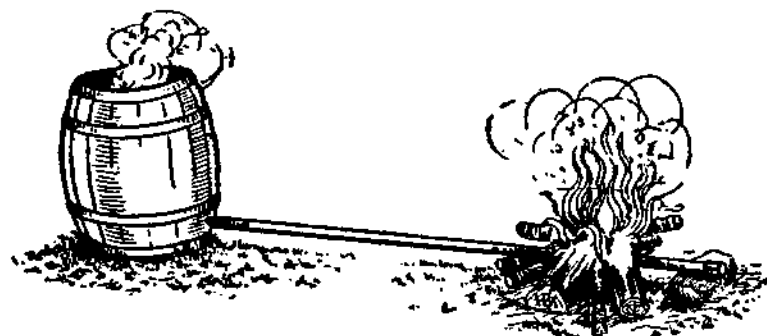
ONE-MAN BUTCHERING RIG

that you can handle heavy hogs without assistance. Build a fire box with a flue, *b*, of three joints of old stovepipe. The vat is made of heavy galvanized iron 4 feet long by 2 feet wide and 18 inches deep.

Over this erect a frame of 2 x 4-inch strips, upon which place an old traveler from a hay carrier, or construct one similar to *d*. With the windlass arrangement, *a*, and the tackle, *e*, to which are attached the four feet of the hog, you can convey it from the vat to the bench. A rope, *c*, passing over the pulley at *g*, serves to pull the carrier, *d*, over the bench from the vat.

### HEATING WATER FOR HOG KILLING

A device which is superior to the old iron kettle for heating water is shown in this sketch. Take a piece of 2-inch iron pipe 8 feet long and have it securely screwed into the bottom of a stout vinegar barrel. In the other end of the pipe screw a large wooden block.



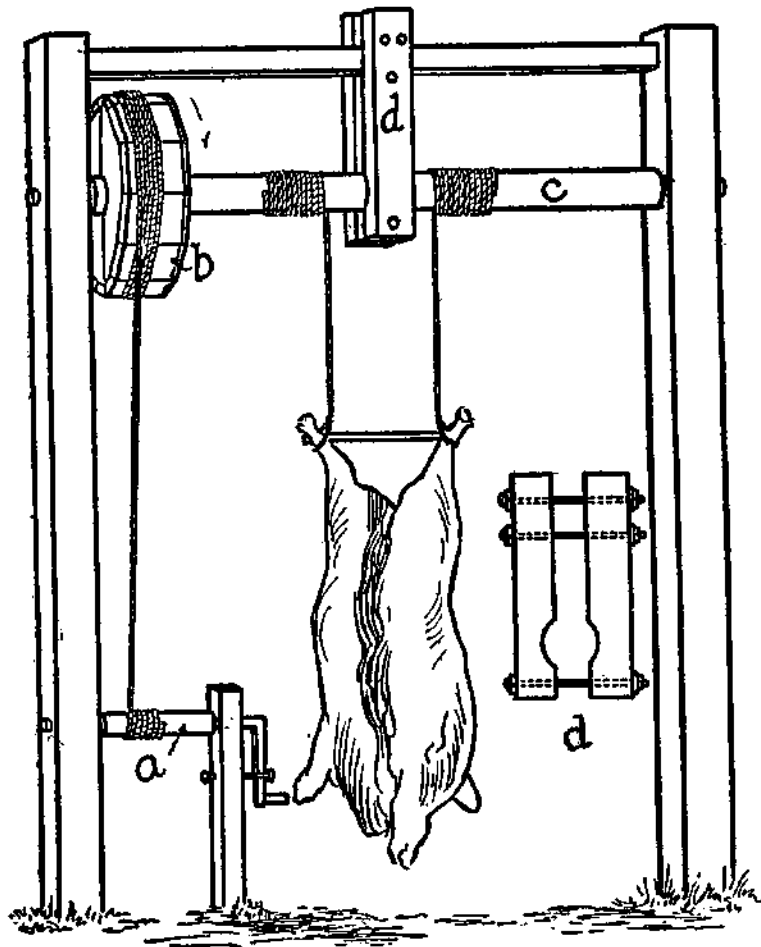
SIMPLE WATER BOILER

By arranging the affair as shown in the sketch water in the barrel will be heated rapidly and can be removed as desired without bothering the fire. Do not make the mistake of putting a metal cap on the end of the pipe, or the steam may sometimes burst the piping before the cap will come off. The wooden block acts as a safety valve and will fly out if pressure is too great.

### A FARM SLAUGHTERHOUSE

If one butchers his own stock on the farm he would do well to fix up a small building for a slaughterhouse. This can be done so easily and at such small expense that almost any farmer can afford one. It is generally most convenient to have

it near the hog yard, for then the refuse can be easily conveyed to the hogs. Indeed it would not be a half bad idea to have it in some instances a part of the hog house. The room in which to kill



CARCASS DERRICK

cattle and hogs should not be less than 15 feet square. This will give plenty of space for the work. As much of the room should be kept clear from fixtures as possible.

The floor should be made of concrete graded so that it will all drain to a central opening. A pipe should carry the liquid from this opening to a trough in the hog yard. The ideal way would be to make the walls of concrete for about 3 feet from the ground. This will make it much easier to keep the place clean. It is quite necessary that a good supply of water be close at hand. If possible, a water pipe with hose attached should be in the house. This will enable one to flood the floor at any time.

On page 99 is a picture of a very good device for handling the carcasses. It is made of a heavy roller, *c*, 5 to 6 inches thick, and long enough to reach across the width of the room. It is supported in the middle by a bracket, *d*, detail of which is shown in the drawing. This makes it possible to lift a carcass of any weight. A drum, *b*, is attached to the roller at one end, over which is run the rope that communicates with the crank, *a*, at the floor. Any man handy with tools can make this derrick.

In order to simplify matters one may use a barrel cart water heater. This barrel has a valve attached at the bottom. To this is fastened a rubber hose that communicates with a small coil of pipes. This coil of pipes in turn communicates with the top of the barrel by another rubber hose. The coil of pipes is placed over a fire built in a hole in the ground, and the valve is opened.

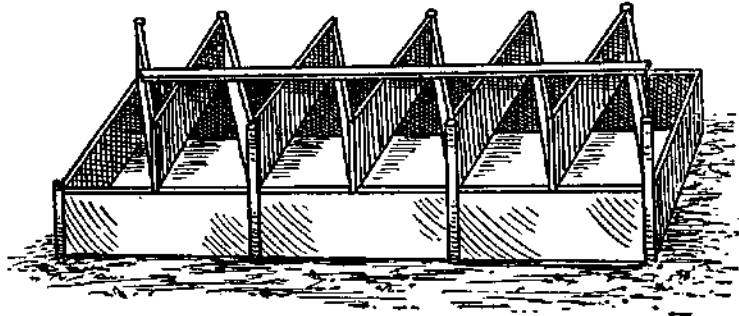
As soon as the water in the coils becomes hot it is forced through the rubber hose, and a circulation is started. This device will heat water very rapidly and easily. When the water is heated the rubber hose is detached and the barrel wheeled under the

derrick on which the hog is hung. By means of a crank the carcass is let into the water to be scalded.

With simple devices one man can very easily do the butchering alone. It will be found convenient to have a table that folds up against the side of the building on which to cut up the meat.

### KEEP PIGS OUT OF FEED TROUGH

To prevent hogs crowding and getting in the trough with their feet the accompanying plan will be found practical. You can nail the Vs, or rick-



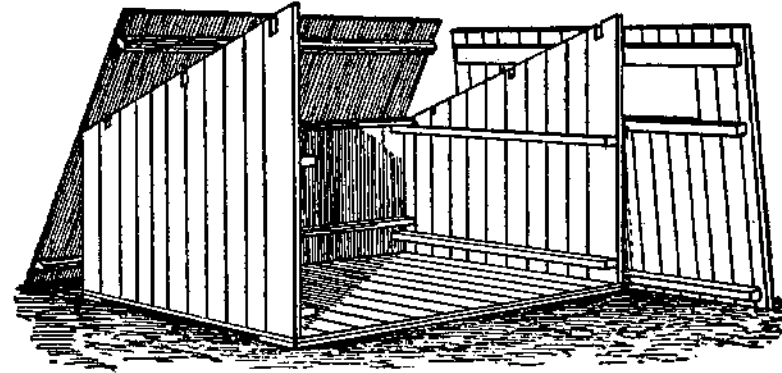
PARTITIONED HOG TROUGH

rack work, on any shaped trough. They fit on a pointed or flat-bottomed trough equally well. Nail a strip lengthwise along the top of the Vs to strengthen them. Stakes driven at intervals and nailed securely to the angles will hold the Vs and trough both solid.

### MOVABLE HOUSE FOR BREEDING SOWS

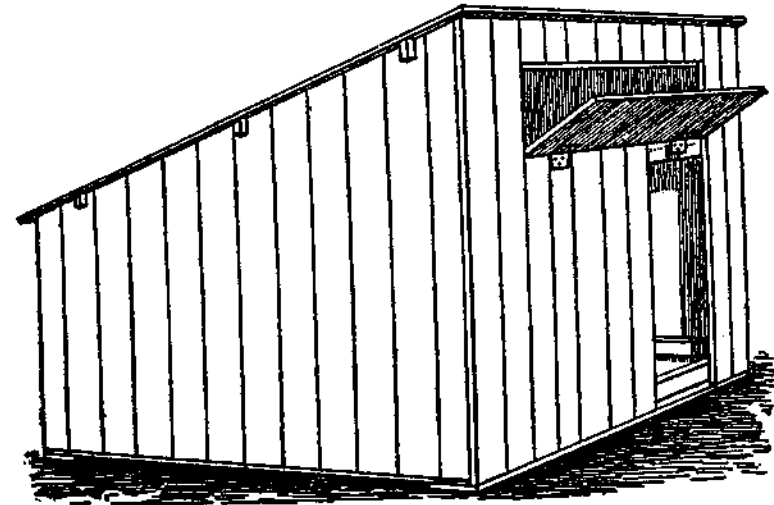
Individual hog houses may be constructed with four upright walls and a shed roof, as shown below. The walls and the roof are separate and can be easily taken down and replaced. These small

houses can be moved about very easily. The size of the house will depend upon conditions. The



CONSTRUCTION OF THE HOUSE

construction is shown, so that any farmer with tools can easily put up one of these houses. With the individual houses the sow at farrowing time may be kept alone and away from all disturbance and there will not be too large a number of pigs in a

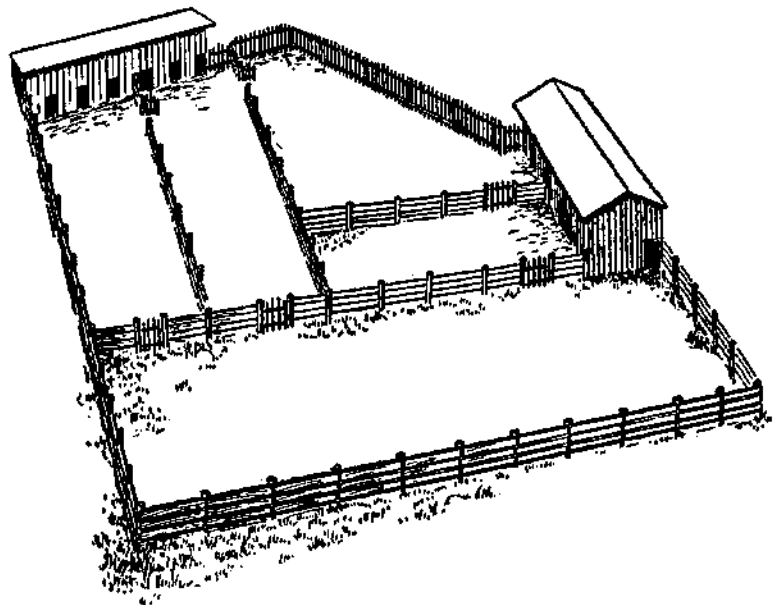


THE HOUSE SET UP

small lot if kept in this way. The danger of spreading diseases among the animals is also reduced to a minimum where swine are kept more isolated. When properly bedded and cared for no disastrous disease need be feared. Much depends upon the sanitary conditions.

### WELL-ARRANGED HOG LOTS

An Indiana farmer keeps his pigs in long houses which are divided into compartments opening into small lots. The sketch shows how they stand. Breeding hogs and fattening shotes are allowed the run of their own lots, as well as occasional

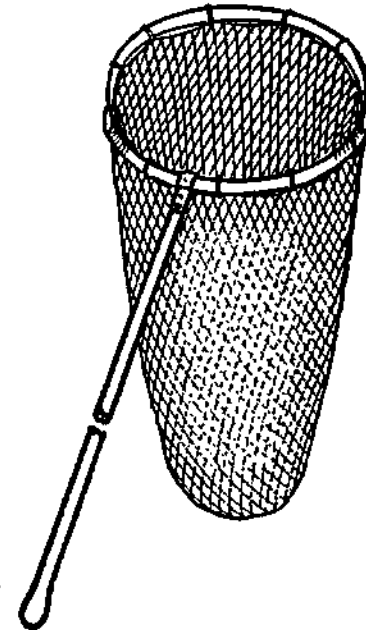


PIG HOUSES AND PENS

changes into the larger field, shown at the bottom of the sketch, which is a timothy and clover pasture. It is better to have pigs in separate quarters in small bunches, for in this way they can be better attended to and the growths are more uniform.

### HANDY PIG CATCHER

Here is a homemade device for catching small pigs which saves much time and annoyance. The net may be made from a discarded lawn tennis net, the rim from a bicycle wheel, and the handle is a heavy rake handle. The net is securely fastened to the rim with some copper wire, while the rim is fastened to the handle with two pieces of band iron. Small pigs caught in the net will not squeal and struggle as when chased around the pen and caught by one leg. The element of excitement is greatly reduced by use of the net, and some would find less fun in the net method. On the whole, however, we recommend it.



PIG NET

---

The weakest arm is strong enough that strikes with the sword of justice.

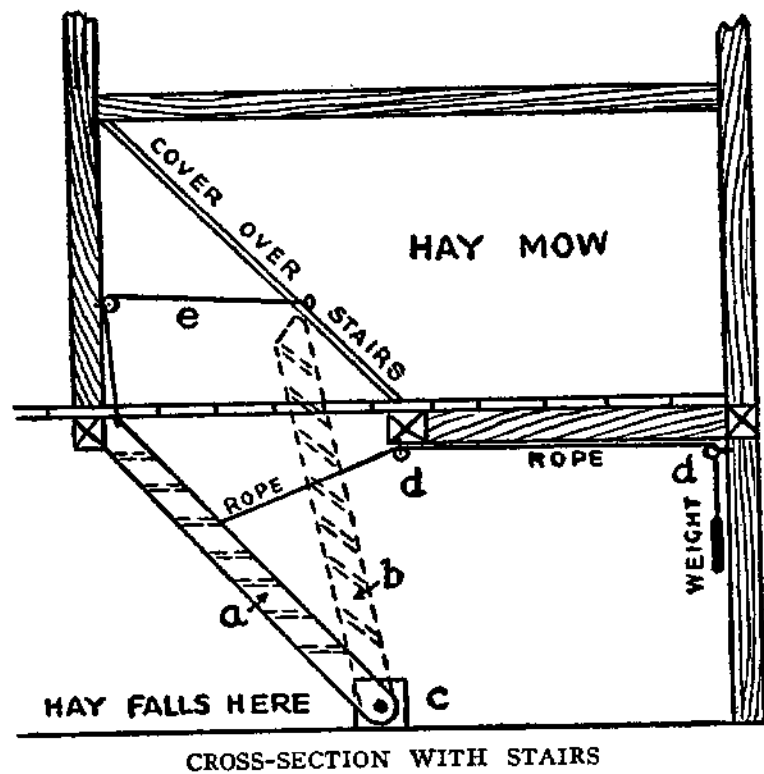
Our knowledge is the amassed thought and experience of innumerable minds.—Emerson.

---

### STAIRS FOR THE BARN

A lot of time is saved if one has handy stairs which can be used for throwing down hay as well as a passageway. These steps are made of light

material and instead of putting on a lower step, use a block, *c*, and attach the stringers of the stairs to it at each end with a pin. A rope passes over the

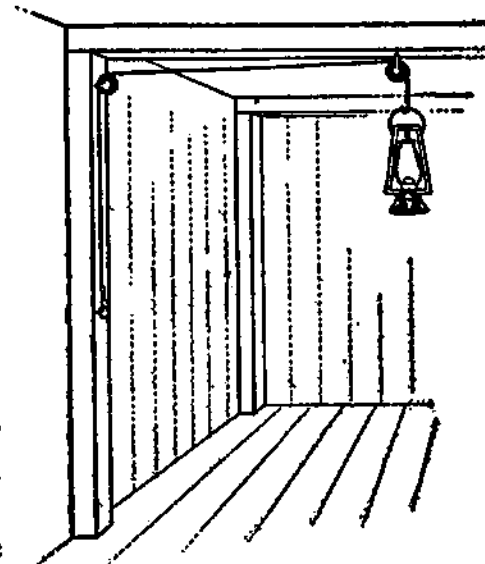


pulleys at *d*, to a weight, which allows the stairway to be held upright while the hay is being put down. The rope, *e*, is handy to pull the stairs into position.

### HANG UP THE LANTERN

Here is a good idea for hanging a lantern over the barn floor. Get two pulleys with screw stems, and screw on in beam over head, the other at top of post. Have a bracket lower on the same post. Take a piece of small but strong cord, and at

one end fasten a snap and pass the other end through the pulleys. Put your lantern on the snap and draw it high enough so it will be out of reach of forking hay, and you can see all over the barn floor. You can raise the lantern high enough to pitch hay from the top of the mow with no danger of turning the light over and burning the building and contents.



PULLEY-HUNG LANTERN

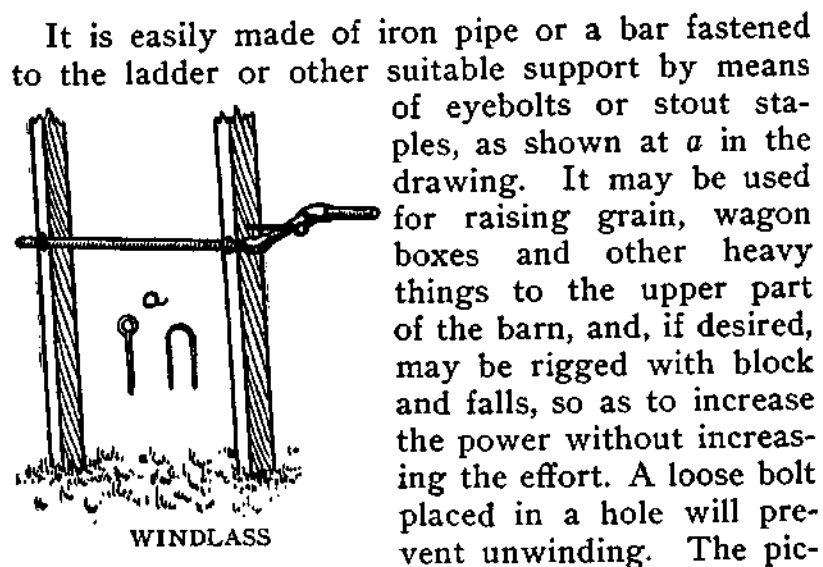
The end of the cord opposite the lantern may be fastened with a snap, or more length may be allowed for adjusting the height of the lantern, and the cord may be secured by a hitch or a few turns around a button or two spikes driven halfway in and bent over in opposite directions.

### ARRANGEMENT FOR WEIGHING

A homemade balance may be constructed with a joist loosely attached, so as to just balance over the rounded top of a heavy block. It will be useful in weighing hay and other bulky substances for feeding purposes. For weights, use small wooden boxes or bags of stone and sand which have been weighed on other scales. Place the required weight upon the balance and then place feed on the other

end until it balances the weight, and it will be accurate enough for all ordinary purposes.

### A BARN WINDLASS



It is easily made of iron pipe or a bar fastened to the ladder or other suitable support by means of eyebolts or stout staples, as shown at *a* in the drawing. It may be used for raising grain, wagon boxes and other heavy things to the upper part of the barn, and, if desired, may be rigged with block and falls, so as to increase the power without increasing the effort. A loose bolt placed in a hole will prevent unwinding. The picture shows how simple this device is. Every farmer knows how useful a barn windlass may be.

### GRAIN BOX EASY TO EMPTY

The trouble with most grain boxes is to get out the last third of the grain. Bending over the edge jackknife fashion is neither pleasant nor healthful. A box or bin may be made with half its front on hinges, so that it can be let down and all the contents scooped out without difficulty. The bin may be made from a piano box with a partition in the middle for two kinds of grain.

Leave your son a good reputation and an employment.

### EASILY CONSTRUCTED GRAIN BINS

Grain bins with compartments for different kinds of feed are handy in barn or stable. By procuring a number of dry-goods boxes, all of the same size and shape, and nailing them together side by side, so that they will appear as one, the bin is easily made. The cover should extend the entire length of the bin, and though leather hinges will answer, it is better to attach it with iron ones, for then, with a good staple and hasp, the contents can be kept under lock and key if desired.

### A CONVENIENT BARN TRUCK

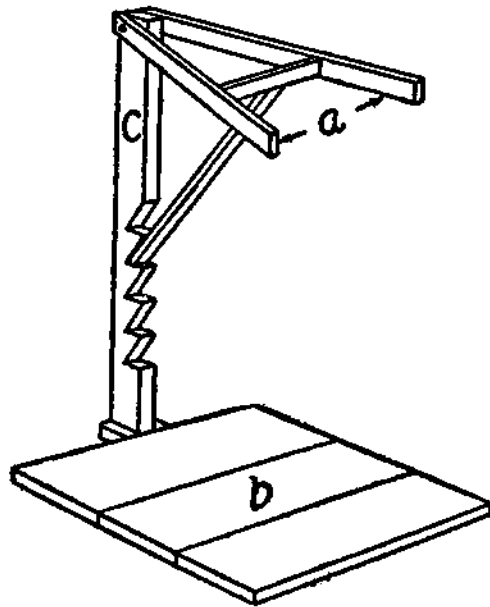
No dairyman can afford to ignore that which will lighten his labor in any way whatever. Be his stable ever so conveniently constructed, he has enough to do. Hence the importance of his considering a feeding truck or car if he does not have one. Made of good lumber, the only iron about it need be the handle at each end, by which to push or pull it along the feeding alley in front of the cows which are to be fed, and the small trucks on which it is mounted. The wheels procured, any good blacksmith can make these, so that the truck is by no means difficult to construct. The box body should be about 2 feet wide, 20 inches deep and 4½ feet long. Silage can be conveyed in it from the silo to the mangers very readily. If the silo is some distance away, it will save much hard work.

If little labor, little are our gains:  
Man's fortunes are according to his pains.

—Herrick.

## TAKES A MAN'S PLACE

In most cases it takes two men to fill a sack of



SACK HOLDER

man or enables a man to work twice as fast as he could without it is worth while.

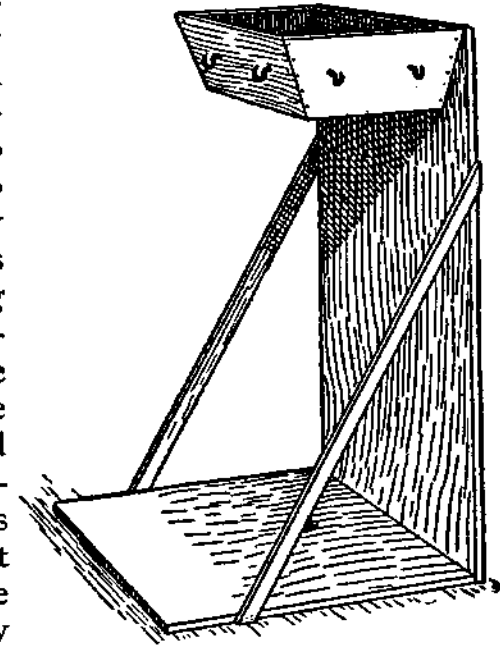
A wise old owl sat on an oak,  
The longer he stayed the less he spoke.  
The less he spoke the more he heard.  
Why are not more of us like that wise old bird?

There are but two ways of paying debt: increase of industry in raising income, increase of thrift in laying out.—Carlyle.

If it were done, when 'tis done, then 'twere well  
It were done quickly.—Macbeth.

## A HANDY BAG HOLDER

It is constructed with two good boards 1 inch thick and 15 inches wide. The perpendicular one is 3½ feet long, and the horizontal one 2 feet long. These are joined together and braced as



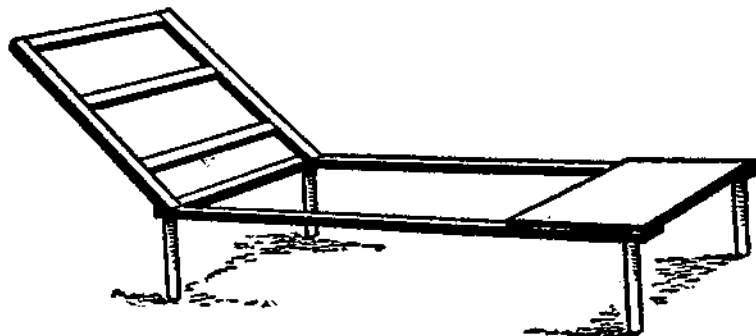
BAG HOLDER

shown in the drawing, and the hopper is attached, wedged out from the perpendicular board so the bag may wrap it all the way round. The hooks for holding the bag in place can be secured at a hardware store. As the whole affair, if composed of thoroughly seasoned lumber is light to handle, it can easily be carried to any spot where grain is to be put up.

Here is another scheme that saves time and labor and makes it possible for one man to do the work that usually requires two. This one is as good and perhaps better than any device that has been invented in the bag-holder line. In making it, an important point is to attach all parts very securely where they come together, especially the hopper and the braces. Otherwise, with hard usage the holder will get loose and break down.

### A CORN HUSKING RACK

Many who husk their corn by hand find it very tiresome to sit on the floor or ground in a cramped position. A rack made as shown in the drawing

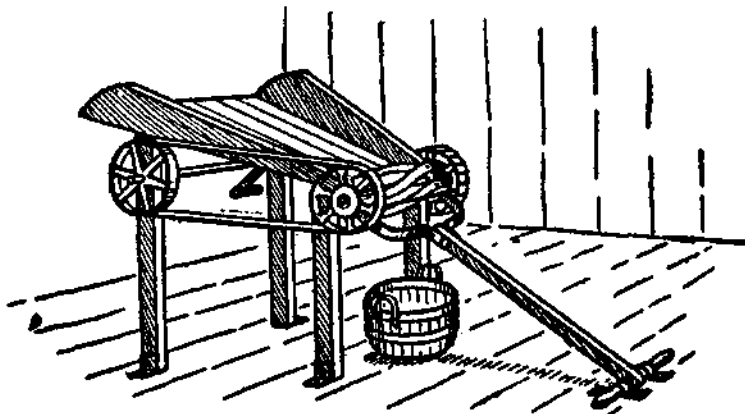


RACK FOR CORN HUSKING

will hold two or three shocks and gives a better place for the husker to sit. Place the stalks cross-wise of the bench in front of you.

### A HOMEMADE FEED CUTTER

An old lawn mower can be arranged to make a fairly satisfactory straw or feed cutter. One must

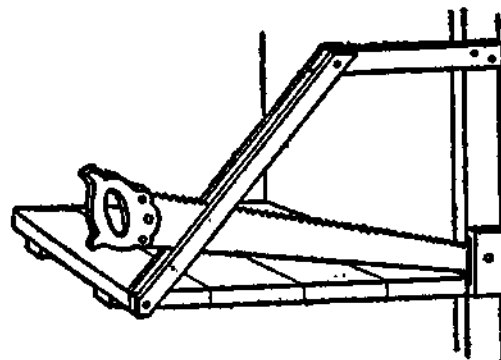


WORKING THE LAWN MOWER

rig up a hopper, as shown in the sketch, and attach the mower to the lower end of it so that the straw or grain will just strike the knives where the grass usually comes into the mower. A crank and a belt arrangement makes it easy for one man to feed and turn the cutter. This is a good use for a lawn mower in the winter time when it is not working outdoors.

### SAW ROOT CUTTER

Those who have cut roots in the winter time with a butcher knife or hatchet will fully appreciate something better for a root cutter. A Wisconsin farmer has found a serviceable homemade lever cutter very efficient for all roots. For hard ones, like rutabagas, it is about the best thing available.



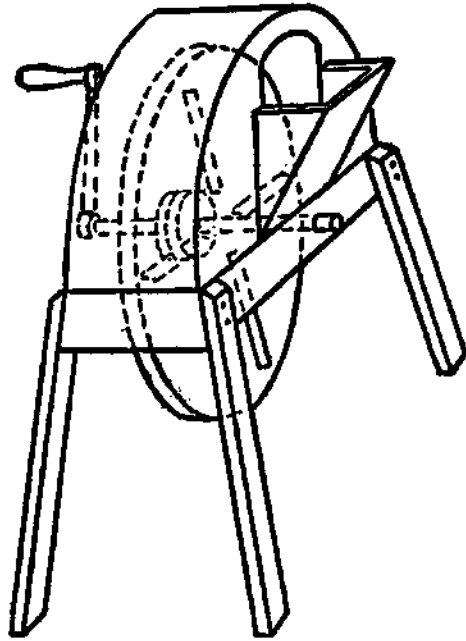
ROOT CUTTER

His is made out of an old hand saw, sharpened on the back, fastened by means of a bolt passing through a hole punched at the small end, and held by a guide formed of two pieces of wood secured upright, so as to have a slit for the saw to work in. This contrivance is a success, and with a little practice the roots may be cut very rapidly. See accompanying illustration. The cutter may be mounted upon the wall wherever it will be most convenient. The bench or platform should be at about the height of a common table.



## HOMEMADE CABBAGE CUTTER

A cheap and easily made cabbage and root cutter is shown in the drawing. Take two



CABBAGE CUTTER

12-inch boards and nail them strongly together. With dividers mark around a circle, then saw out and mark in quarters. Cut four slots 7 inches long on a slant, as shown by dotted lines, so the cabbage will fall through easily. Next cut two circles 4 inches in diameter. Nail one to the large wheel on the back and leave the other loose on the shaft to act as a bearing.

Make a frame to admit the wheel, leaving 2 inches clear, and just wide enough so the knives do not strike the side. Make a top over the wheel and put a hopper on the opposite side from the crank. The knives are 8 inches long and can be made from an old bucksaw and ground down sharp, with a bevel on one side. Screw these on the wheel at a slant according to the thickness the cabbage is wanted. A square hole should be cut through the center of the wheel for the shaft.

## A SUBSTANTIAL DRIVEWAY

A plank driveway to the barn is usually made steep in order to save planks. It is continually wearing out and breaking. A substantial driveway with an easy grade can be made by driving down stakes close together on either side, and filling in between with stones, rubbish and earth, packing all down firmly. When full to the top, pack some earth against the outside of the stakes and sod over the sides. This driveway will form an easy rise and will prove very durable.

---

Kindle not the fire that you cannot extinguish.

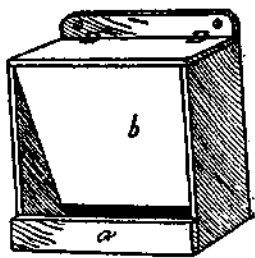


## FEEDING DRY GROUND GRAIN



**S**OME of our friends have found that a poultry feed hopper for feeding ground grain has proved very satisfactory. Make a box 18 x 18 inches and 6 inches deep, then take off one end and fasten to the back with hinges, which forms the cover.

Nail a strip, *a*, 3 inches wide across the open side at bottom, which forms the box for the poultry to eat from. Take a board, *b*, the width of inside of box, 14 inches long, and insert in front of box, nailing as shown in cut, with the upper end even with front edge of box and slanting in until a space of 2 inches is left between bottom of board and back of box to allow the feed to pass through.



FEED HOPPER

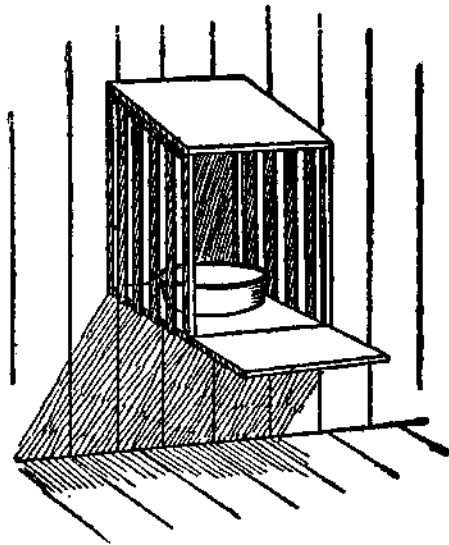
The feed is poured into this hopper and runs down into the box at the bottom as fast as needed. The size of the hopper can be varied to suit the size of the flock. It should be screwed to wall of poultry house about 12 inches from floor. By using this hopper one may keep a dry mixture consisting of wheat bran and middlings and occasionally corn meal, or a small amount of linseed meal, always before the fowls. In addition, some people feed a mixture of whole corn, oats and wheat in the litter morning and evening, also ground green bone and beef scraps.

## KEEPING THE WATER CLEAN

Few drinking fountains are more successful than a large bottle or jug filled with water and inverted. It can be fastened wherever convenient with straps. If a small pan is placed close beneath it the water will flow out as it is used and will remain clean and cool. Place it high enough above the floor of the house so the fowls will not scratch litter into the pan.

## A WATERING RACK FOR HENS

Build a crate of lath 2 feet square, 3 feet high, with a slanting cover to keep the hens off the top. Then tack an 8-inch board in front, level with floor of crate. Nail the rack to post or side of henhouse about 2½ feet from floor, and put your water pan in crate. The hens will quickly learn to fly up and drink by putting corn on the lighting board. This contrivance keeps the hens from spilling their water or scratching dust or chaff into it. Be sure to nail the rack securely to the wall or post where it is put up.

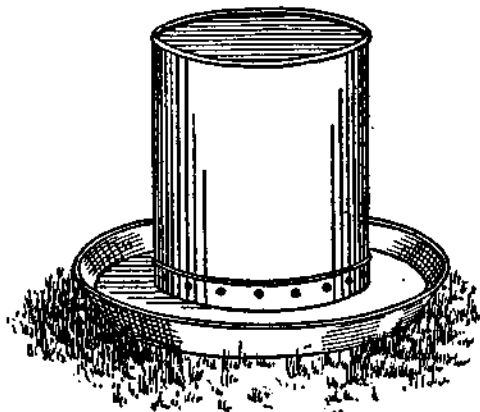


RACK IN PLACE

Keep your shop and your shop will keep you.

## DRINKING FOUNTAIN

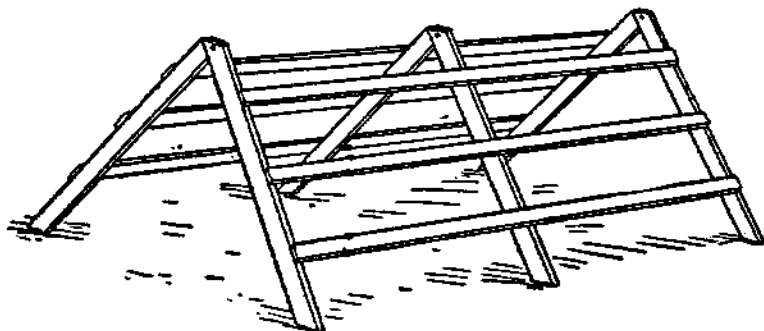
The best drinking fountain, in that it is impossible for small chicks to get drowned, and they cannot stand in the water to befoul it, is made by inverting a can or pail in a pan a trifle larger. Tomato cans with the edges pounded down, leaky pails with the ears bent up, in fact anything with a smooth top and in which a hole can be made, can be used. Punch a hole or holes in the side just a little less distance from the top than the depth of the pan to be used. Fill with water, invert the pan over the top, and turn over quickly.



CHICKEN FOUNTAIN

## FOLDING CHICKEN ROOST

This roost is made of 3-inch boards cut any desired length. A small bolt fastens the upright

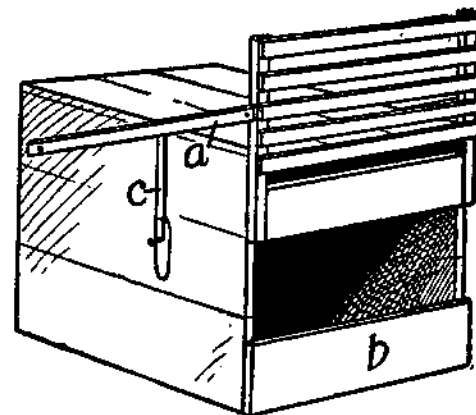


MOVABLE ROOST

pieces at their top ends, and the horizontal pieces are fastened on with nails. This roost can be kept at any angle, and may be quickly taken out of the house when it is time to clean up. This sort of roost will accommodate more fowls in the same space than the flat kind, but it should not be made very high.

## A GOOD POULTRY NEST

A useful trap nest can be made of grocery boxes. They should be at least 12 inches each way. The illustration shows how they are made. In the cut the trap is set ready for the hen to enter. A cleat, *c*, is fastened to a small piece of cord, which is tied to a nail on the side of the box. Set the trap by raising it and resting the cleat on the nail, with the other end under the arm marked *a*. This leaves an opening from 4 to 6 inches wide, which is not enough for the hen to enter. In going into the nest she will be obliged to raise the trap door, which will let the cleat fall, thus closing the trap after the hen has gone in.



TRAP NEST

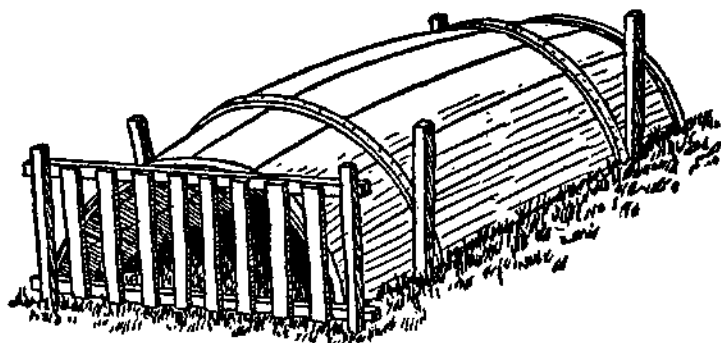
The trap door, the arms and the cleats may be made out of lath. Leave a little space between the boards in the walls, so the heat can escape, otherwise it will be too warm in summer. The bottom

The trap door, the arms and the cleats may be made out of lath. Leave a little space between the boards in the walls, so the heat can escape, otherwise it will be too warm in summer. The bottom

board, *b*, in front should be 3 or 4 inches wide, and the lower piece of the trap door should rest against this so the hen cannot get her head through, raise the trap and get out.

### TWO COOPS FROM A BARREL

Very good coops can be made at small cost from empty barrels, as shown in this picture. First, drive shingle nails through the hoops on both sides of each stave and clinch them down on the inside. Then divide the barrel in halves, if it is big enough, by cutting through the hoops and the



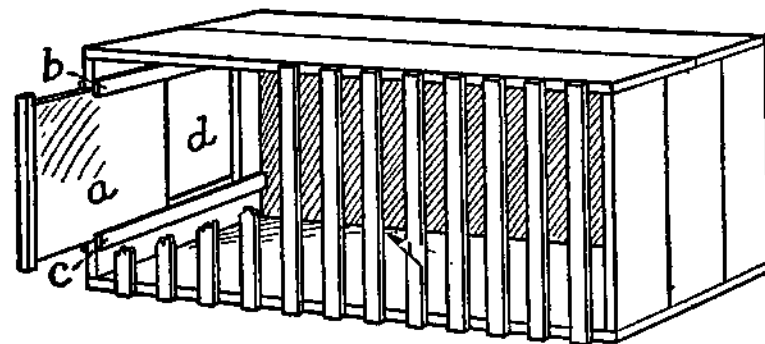
BARREL CHICKEN COOP

bottom. Drive sticks into the ground to hold the coop in place, and drive a long stick at each side of the open end just far enough from coop to allow the front door to be slipped out and in. The night door can be made of the head from the barrel or any solid board, and the slatted door, used to confine the hen, by nailing upright strips of lath to a crosslath at top and bottom.

Weak men wait for opportunities; strong men make them.—Marden.

### A BOX CHICKEN COOP

The diagram shows a convenient way to make a coop for the poultry yard, of which the special feature is its door. Procure a box of the right dimensions and saw a hole, *d*, in one end. Then strengthen the box with narrow strips of wood, *b*, *c*, on each side of the hole *b*, *c*. This acts as a



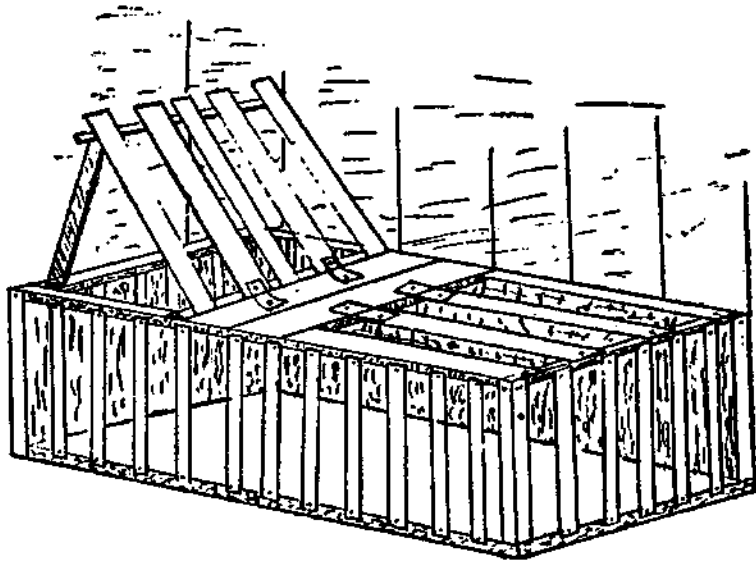
HINGELESS DOOR IN COOP

groove for the door, *a*, to slide in. Thus you have a sliding door, which opens and shuts with the greatest ease. The front of the coop is inclosed with lath, or narrow strips, placed  $2\frac{1}{2}$  to 3 inches apart. The top should be covered with a good grade of roofing paper to make it waterproof. A coop of this sort should be 2 to  $2\frac{1}{2}$  feet long, 16 inches deep and 2 feet high.

### A LOW POULTRY RUN

A safe and secure run that requires less material than a high pen can be made from laths sawed in two, which would make the sides 2 feet high, making the frame of scantlings and the top of sawed laths, box boards or similar material. The top of

the run should consist almost entirely of trap doors, using bits of old harness for hinges, which will look well if cut neatly. The picture shows one of the doors propped up to show the construction more plainly. The doors are 4 feet long, the length of a lath, and may be 8 to 10 feet the other way and still not be clumsy, being constructed of such light material. This trap door is an important feature,



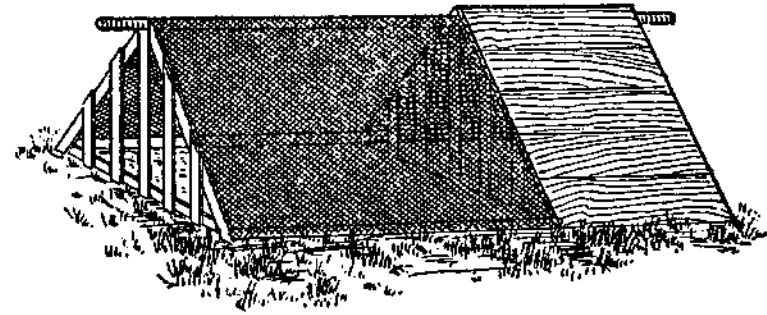
TRAP-DOOR POULTRY COOP

as it permits the tender to enter easily for removing top soil and replacing with fresh earth, or otherwise caring for the birds. The frame material is of 2 x 2-inch scantling at the corners, while the side strips are made of inch boards sawed 2 inches wide. The earth under this run should be slightly mounded for the sake of dryness.

Whatever is worth doing at all is worth doing well.—Earl of Chesterfield.

## A PORTABLE CHICKEN COOP

One of the annoyances about an ordinary chicken coop is that it is not easily moved from place to place, nor provided with a yard. To obtain a yard the coop must be moved separately, and thus require the loss of more or less time. In the drawing shown herewith is a simple, homemade coop,



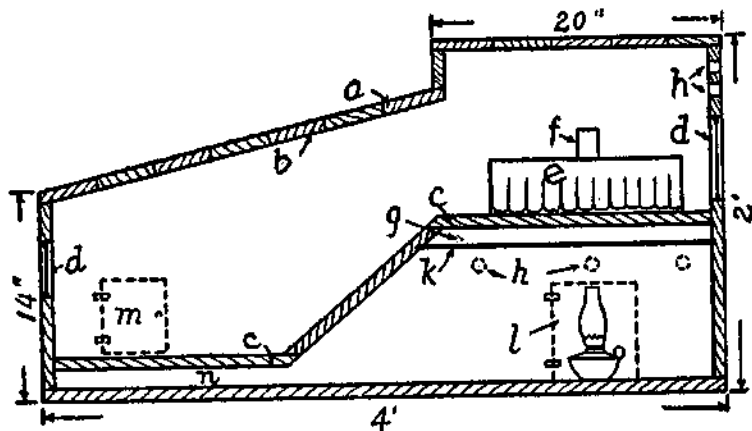
COOP EASILY MOVED

which can very easily be moved by the aid of the handles at the apex at each end. The coop is built of ordinary material on a base frame, and with a V-shaped roof and side frames. The ridge pole is extended, as shown at each end, to form a handle. A convenient length is about 2 feet for the coop and 3 or 4 feet for the yard. If desired, the hen may be allowed the freedom of the yard or may be held in by slats, as shown in the drawing.

## A HOMEMADE BROODER

The material costs about \$2 and a handy person can build one in a day. The gas from the lamp does not go into the chick apartment at all, but filters around under the floor, making it dry and warm. The lamp flame is about 3 inches from the

sheet iron. The heat flows up gently through the drum, *f*, which is perforated with holes in the side, thus letting part of the heat out into the hover and the balance in the brooder above. The heat reservoir, *g*, between the sheet iron, *k*, and the floor, *c*, is about 1 inch deep. The tube, *f*, should not touch the sheet iron, merely extending through the floor, *c*. It takes very little oil.



DETAILS OF BROODER

In the cut, *a*, is the paper roofing over inch-matched boards, *b*; *c* is board floor of same material; *d* are small windows, *e* is the hover, *h* are holes in each side of the brooder for the escape of gas and fumes, *l* shows door to reach the lamp, *n* air space below the floor.

### MOVABLE BROODER HOUSE

The type of house shown in the cut is one of the best for raising poultry. It may be built on runners, with a tight board floor of matched boards. A convenient size is 6 feet wide and 10 feet long, 6 feet high in front and 4 feet at the rear. The

door is in the middle, and there is a window on each side, with two openings below. The roof should be covered with a good quality of prepared roofing.



HOUSE ON RUNNERS

The same material used to cover the sides will make the house warmer. Roosts may be put in after the brooders are taken out, and the chickens easily protected from foxes and other animals.

### A VERY CHEAP HENHOUSE

It was built by a "down east" Yankee. The studs and rafters were made of two pieces of 1 x 2-inch stuff nailed together T shape. These were set up 2 feet 10 inches apart on centers and covered with wire netting drawn taut. This was then covered with tarred paper, which made the only material between the fowls and the outside air. They have wintered in these houses without discomfort, and gave a good egg yield. The wire netting prevented the paper from sagging when the house was covered with snow.

They can who think they can.

## A DAYLIGHT CHICKEN CATCHER

Do you, when you want fried chicken on short notice, run it down, provided it doesn't run you down? Here is a better way. Fasten a barrel hoop securely to a handle about 6 feet long, and to it fasten a bag about 3 feet deep. A piece of an old hammock is fine for a bag, or horse net or fish net—anything the chicken cannot get out of. Lay it on the ground, call the chicken and throw the corn over the bag, and when one suitable goes on lift up the hoop and you have it. If the bag is made not over 1 foot deep it can be dropped down over the chicken while eating.

## A SIMPLE HAWK TRAP

Make a box 4 inches deep, 6 inches square and nail to a 4-foot pole with cleats at the bottom to keep from turning over. Cover top of box with 1-inch mesh wire. Place a little chicken in the box; then put a steel trap on top of box and set it out under the trees where the hawks lodge to watch for the chickens. If there are hawks around, it is pretty sure to catch them.

## SCARE AWAY CROWS AND HAWKS

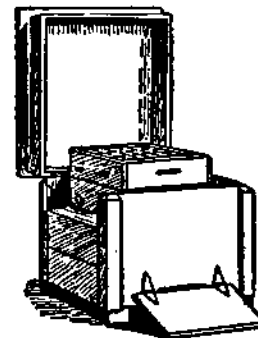
For keeping hawks and crows away from the poultry yards, get a few bright tin shingles, link them together with wire, and hang upon an arm extending from the top of a high pole, where sun and wind strike fairly. The jingle and glitter is sufficient to keep these pests at a safe distance. You will also find them useful in the corn and melon fields where crows are troublesome.

## PRACTICAL HIVES AND HIVE MAKING



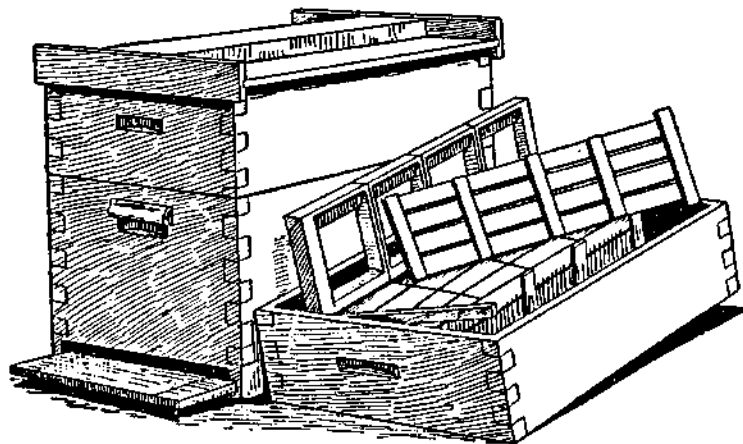
EVERY apiarist knows that there is no item in bee keeping of more practical importance than the hive and brood frame. The Langstroth, or Simplicity size of frame has become almost standard, for there are more frames of this size in use than all others combined. The frame proper is  $17\frac{5}{8}$  inches long,  $9\frac{1}{8}$  inches deep, and the top bar is 19 inches long. There are several styles made, but many prefer what is known as the Hoffman. This has a heavy top bar in depth, as well as width. The ends, or end bars, are made  $1\frac{3}{8}$  inches wide for about 3 inches down and one side is worked off to a knife edge, which comes against the square edge of the next frame, making them self-spacing, but not a closed-end frame, and allowing the proper bee space between the top bars. This works fairly well without the use of the honey board, though one is preferable.

The hive for this frame, to be best adapted to the production of comb or extracted honey, should contain 10 frames, the inside dimensions being 15 inches wide, 10 inches deep and  $18\frac{3}{8}$  inches long. A follower can be used at one side to assist in removing frames by first removing the follower or division board. This arrangement leaves  $\frac{3}{8}$  inch between the top of the frames and the top of the brood nest, so that when the surplus cases are put on the proper bee space is



DOUBLE-WALLED  
HIVE

preserved. This hive is made of scant  $\frac{1}{2}$ -inch lumber for the outside, ship-lapped together in a manner to make a perfect joint. It is 20 inches wide, 24 inches long, about 20 inches high to the eaves, or roof, outside measurements, and weighs complete about 50 pounds. The inside dimensions of the brood nest should be the same as any 8 or 10-frame hive, as the bee keeper may prefer. The brood nest is raised sufficiently to admit of packing between it and the hive proper, also a space for packing at ends and sides.



DOVETAILED HIVE

The lower portion of the hive being well protected against the cold, the warmth of the bees will care for the upper portion. To avoid condensation cover the brood nest after removing the surplus cases with a porous substance, or chaff cushion. Make a wooden rim about 4 inches deep, covering the top and bottom with burlap and filling with wheat chaff or cut straw. Many prefer the cut straw both for cushions and packing the

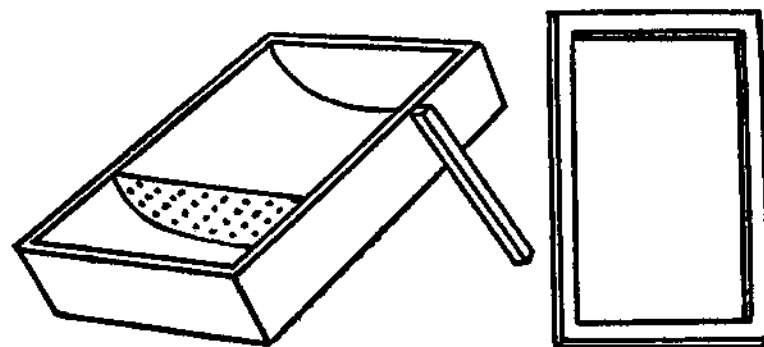
hives. This rim should be made a little smaller than the inside of the hive.

In extremely warm weather the cover can be raised a few inches in front, giving a circulation of air all around the surplus department, and shading it at the same time. The cover is hinged at the back end, and when raised, as shown in cut, makes two shelves for the use of the operators, which are highly appreciated; besides, there is no lifting on or off of covers, as is the case in other hives. The alighting board is hinged and can touch the ground, which is of great advantage to the bees during a heavy flow of honey.

Perhaps there are more single-walled hives used in the United States than double-walled or chaff hives, but in northern states a double-walled hive is preferable.

### DEVICE FOR EXTRACTING BEESWAX

Wax, as produced by the bees and worked into comb, is almost pure white, but, on being melted



SOLAR WAX EXTRACTOR

and cooled, is yellow. A man who knows advises every beekeeper to use the solar wax extractor.



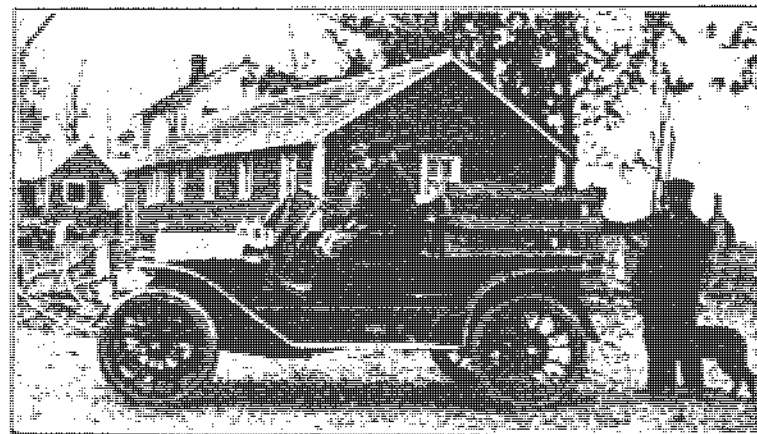
All that is necessary is to have a box with glass to fit over it, as shown in the drawing. To melt combs, put in the box an old dripping-pan, having a hole at one corner, and that corner the lowest, with some kind of a dish set under to catch the wax. Set in the sun. To get the most out, break up the combs into fine pieces, then soak in water for a day or two longer before rendering.

### SELF-FEEDER FOR BEES

A very simple device for feeding bees on syrup may be made if you take an ordinary fruit can, fill it full of syrup and over the top tie a thick rag with a string. Then invert the can in a small pan or dish. The syrup will seep out through the rag around the edges of the jar just fast enough for the bees to keep it cleaned up.



A HANDY DEVICE OF THE ORIENT



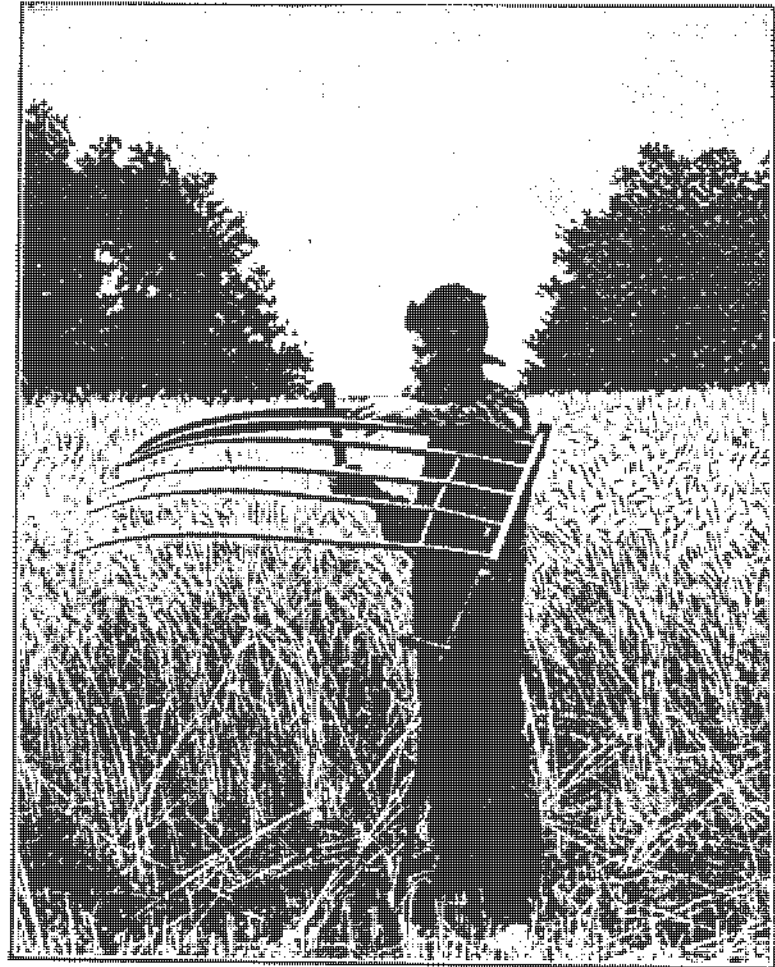
QUICK DELIVERY FROM THE FARMS

Hundreds of farmers are today making profitable use of automobiles, although their first appearance upon country roads caused only fear and anger.



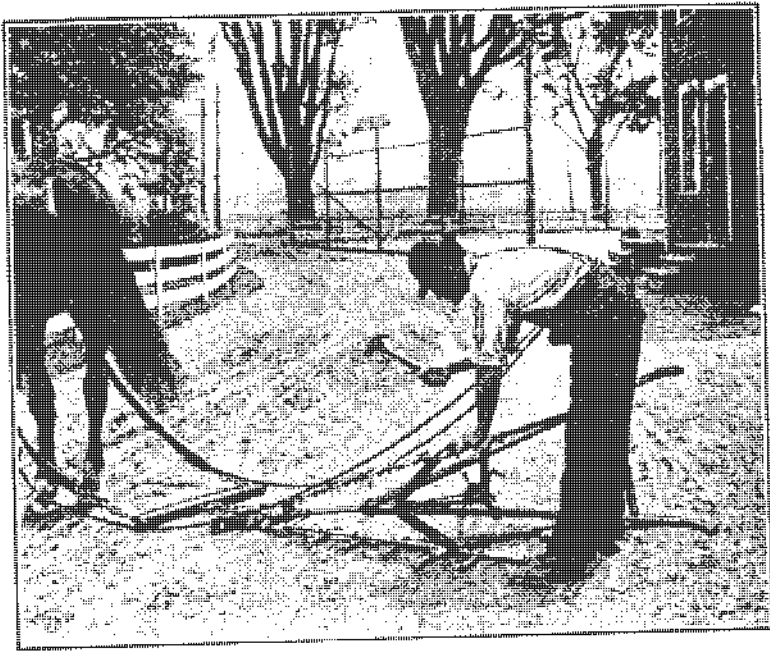
### SAVE THE BARRELS

Barrels, barrel hoops and barrel staves may be worked into many useful things upon a farm. From the few described in this book your ingenuity will lead you to others.

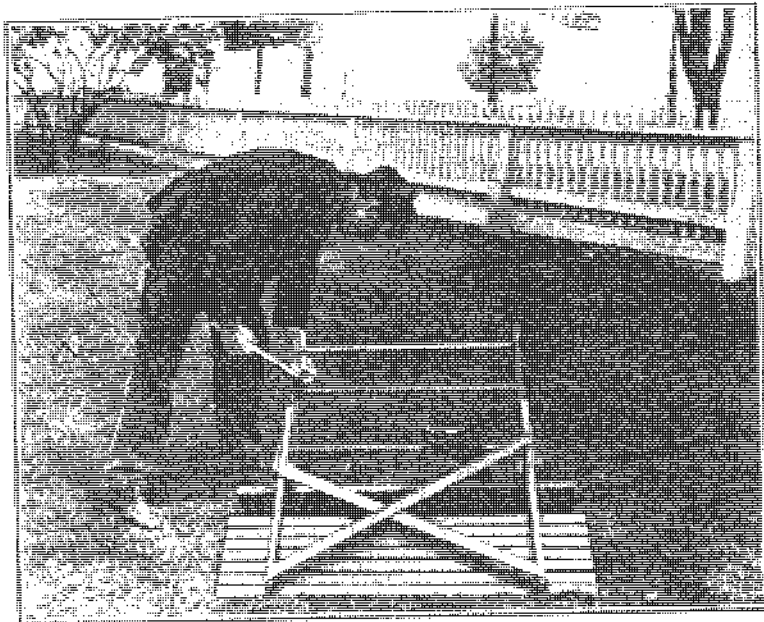


### AS IN DAYS OF YORE

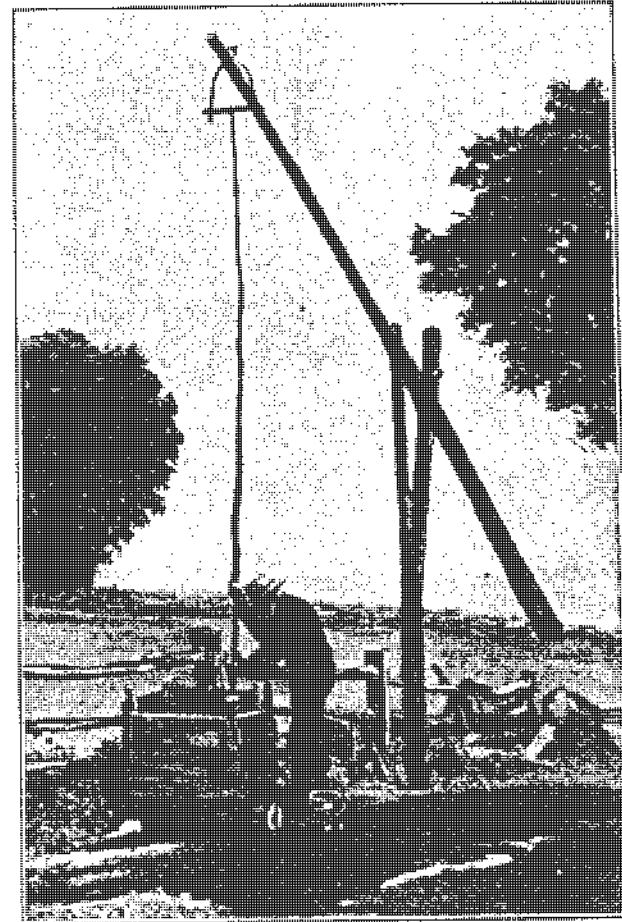
Modern harvesting machinery has come to take the place of old-time hand tools on the big farms; but many a reaper of the ancient type still swings through the golden grain, a relic of the days when men worked harder and accomplished less than they do today.



**KEEP THE HAMMER BUSY**



**A NAIL IN TIME**



**A TIME-HONORED HANDY DEVICE**

### AN IRON HOOP TRELLIS



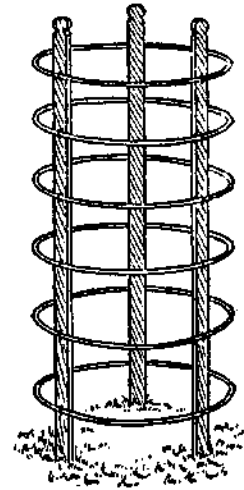
**THE BIG BROTHER TAKES A HAND**

He's a city chap now, but when he comes home, he proves that his early training has not been forgotten. Teach your boy to use tools and use them right.



**T**HIS trellis is made of the iron hoops that are now used so commonly upon sugar and other barrels. They are of stout wire, welded into a complete circle, and, as barrels are constantly going to pieces, one can get together quite a collection of these, when they can be assorted into uniform sizes.

An attractive trellis is shown. Three strips of wood, pointed at the lower end and finished with a knob at the top, are provided, the length being a matter for individual taste. A trellis for tomato plants will need not more than two hoops, while one for sweet peas may require a half dozen. The strips of wood should be of inch board, 2 inches wide. The hoops are secured to the uprights by small staples made for putting up wire fencing. The wooden posts may be oiled or painted some attractive color. This trellis will be greatly appreciated both in the vegetable and flower gardens, for its strength and attractiveness.

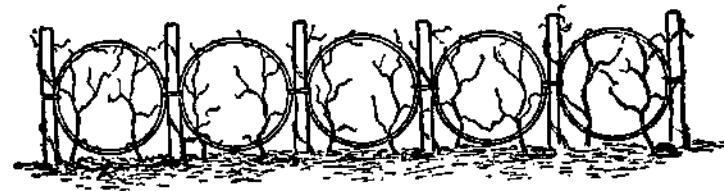
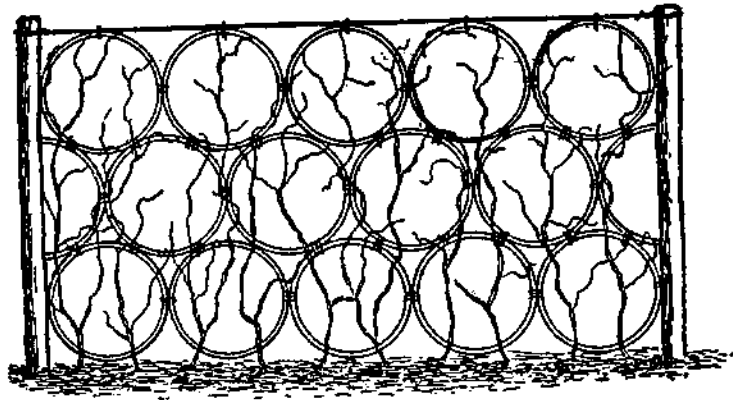


**THE TRELLIS**

Diligence is the mother of good luck.—Franklin.

## PLANT SUPPORTS OF BARREL HOOPS

The ordinary wooden hoops from barrels may be made into an attractive trellis for grapes or a support for smaller twining plants by being arranged



HOOP TRELLISES

as shown in the sketch. Attach them firmly to heavy stakes with some No. 7 smooth wire and you have an arrangement which will last for several years and is not unattractive to the eye.

## A FOLDING TRELLIS

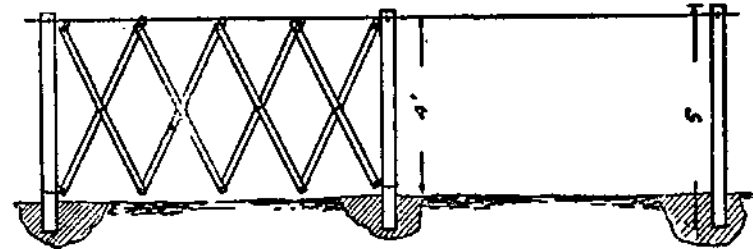
A good way to pole beans is to make a folding trellis out of plastering lath, as shown in the cuts.



TRELLIS FOLDED

Bore three small holes through each lath, as shown in the first cut and fasten them together with common wire nails well clinched.

Five-foot posts are set 1 foot in the ground and a wire strung at top and bottom. The lath are fastened to the wires with string, as shown in the second cut. The trellis is made in sections so as to be



TRELLIS IN PLACE IN THE GARDEN

easily handled. When not in use it is folded up and laid away under shelter. The posts are spaced evenly so that one section of trellis will just go between two posts.

## EASY WAY TO POLE BEANS

Set posts at convenient distances apart and stretch a wire at the top. This may be done as soon as ground is plowed. Plant and cultivate one row each side of line until beans begin to vine, then

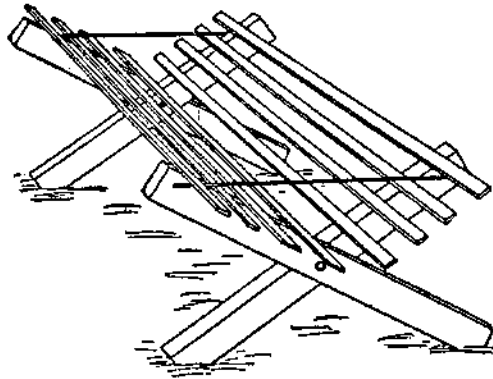


TRELLIS FOR BEANS

set poles slanting, tying them together where they cross at the wire. This braces the whole row and beans can be cultivated with hoe. Hills 3 feet apart in row with one vine to hill are better than two vines.

## TRELLIS THAT STANDS ALONE

A plant support or garden trellis, such as shown in the drawing, is very handy in the garden. This



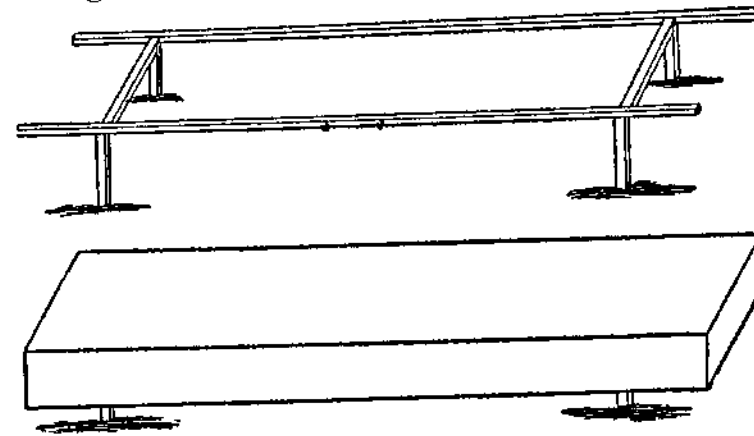
DOUBLE FORM OF TRELLIS

double form of trellis can be folded up and takes very little room in storage. All trellises and stakes should be gathered as soon as the crop is harvested and stored under cover until the next season. They are useful for tomatoes, beans, peas, cucumbers and other plants that need some support. The double trellis is built of narrow  $\frac{1}{2}$ -inch slats and pieces of 2 x 3, which are bolted together for the legs. The top may be held in place by pieces of string or wire attached at the points indicated in the drawing. The length, width and height of this trellis should depend upon the use to be made of it. A large one will be wanted for a large spreading plant and a small one for a small plant. It is important to have trellises just the right size to give proper support.

## PROTECTING NEWLY SET PLANTS

Plants newly transplanted always demand more or less protection from the blighting effects of too much sun and wind. It is best achieved by making a shelter such as is shown in the cut. Two 10-

foot poles and two 3-foot pieces of any convenient thickness for the crosspieces, with four 14-inch weather-strips for the legs, constitute the frame. In the middle of it two hooks should be inserted on each side, and upon these the covering fastened, which can thus be adjusted very quickly. The covering may consist of burlap or any kind of rough sacking.



FRAME OPEN AND COVERED

Being so simple and economical to make, it is advisable to have enough frames to protect the number of tender plants that are set out in a garden at one time. They possess other advantages than sheltering the young things from the direct rays of the sun. They allow slow evaporation, and so keep newly watered ground moist for hours, whereas if exposed to the sun and wind it would soon become dry and caked. On windy days it is only necessary to let the sacking down on the windward side of the shelter. In case of frost the protection that they afford is of inestimable value.

Love thy neighbor, yet pull not down thy hedge.

## MAKING THE HOTBED

The value of every vegetable garden can be greatly increased and the time during which a supply of fresh vegetables may be secured for the table greatly lengthened by the use of the common manure hotbed and the cold frame. These indispensable adjuncts of the good garden are so easily made and cost so little that it is surprising they are not more common. A good hotbed made the latter part of February or in March can be made to yield an abundant supply of lettuce, radishes, spinach, etc., for table use by the time such crops are being planted out of doors, and the supply of cabbage, tomatoes and other plants for the home garden can be secured ready to transplant several weeks earlier than if plants grown in the open were depended upon.

As a source of heat fresh horse manure is used. About half manure and half fine straw mixed together should be piled in square piles 2 or 3 feet in depth, and 4 or 5 feet in width and long enough to contain the amount necessary for the beds desired. After heating has well started, the piles should be forked over, turning the outside of the old pile to the inside of the new, and when heating again is well under way the material is ready for use. In the meantime select a well-drained spot, sloping to the south, if possible.

Dig a trench  $6\frac{1}{2}$  feet wide, 2 feet deep and as long as desired, running east and west. Now place the manure in the trench, tramping and packing in thin, even layers until level with the surface. Make a frame 6 feet wide and as long as desired, but some multiple of three, because the hotbed sash are always made 3 feet wide. The end piece should

be 9 inches high in front and 15 inches high in the back. The front side board should be 9 inches wide and for the rear it will require two boards, preferably 12 and 3, with the wide one at the top.

A frame 12 or 15 feet in length will be quite large enough for the ordinary farm garden. Set this frame on top of the manure with the slope facing the south and secured by stakes. On top of the manure put 6 inches of good garden soil and cover the frame with common sash or windows 6 feet long by 3 feet wide. At first the heat will run very high, but in a few days it will fall to 80 or 90 degrees, when it is safe to plant the seeds.

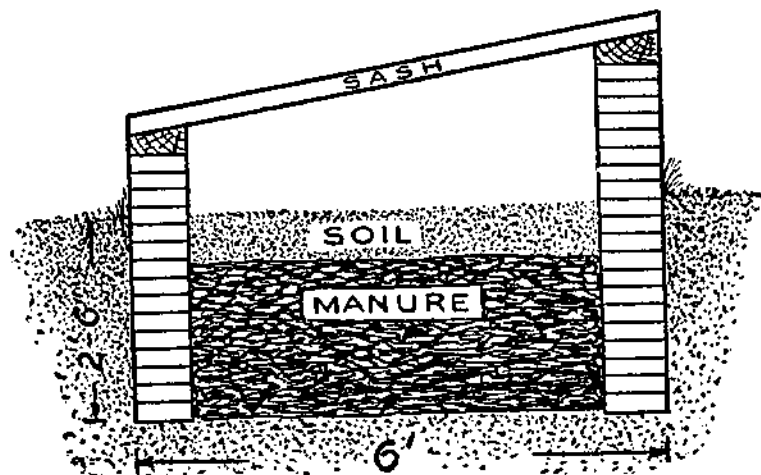
## MAKING PERMANENT HOTBEDS

Hotbed sash should be constructed of white pine or of cypress, and the sash bars should run in one direction only, and that lengthwise of the sash. The bars may be braced through the middle by a transverse bar placed through the long bars below the glass. The two ends of the sash should be made of sound timber, 3 inches wide at the top and 4 inches wide at the bottom end, mortised to receive the ends of the sash bars, and with a tenon at the ends to pass through the side pieces, which should be  $2\frac{1}{2}$  inches wide.

A permanent hotbed should be so constructed as to be heated either with fermenting manure or by radiating pipes from the dwelling or greenhouse heating plant. For a permanent bed, in which manure is to supply the heat, a pit 2 to  $2\frac{1}{2}$  feet deep, according to the latitude in which the work is to be done, should be provided.

The sides and ends may be supported by a lining of plank supported by posts 4 feet apart, or, what

is better still, a brick wall 9 inches thick, as shown in the drawing, may be used. In either case the pit lining should come flush with the surface of the soil. The site for the pit should be on naturally well-drained land, and a tile drain from the bottom of the excavation should be provided to prevent the



HOTBED WITH BRICK WALLS

water from accumulating in the pit and stopping the fermentation of the manure during the period the hotbed is in use.

Standard hotbed sashes are 3 by 6 feet. The pit, therefore, should be some multiple of 3 feet in length, and the width should be the same as the length of the sash, 6 feet. The plank frame, or the brickwork of the pit, may be extended above the surface of the ground sufficiently to allow for placing the sash immediately upon these permanent structures.

### HEAT FOR HOTBEDS

Make an excavation 5 x 16 feet on the surface, and about a foot deep. Lengthwise along this

space lay three rows of tiling, one along the center and one about a foot from each side. The tiles should be 4 inches inside measure, and 1 foot long. These are placed end to end so as to fit closely, and earth is pressed around them so as to hold every piece exactly in place. Then the excavation is filled with rich soil until level with the surface, excepting at the end the tiles are left bare for a few inches. The board frame, 5 x 15 feet, is next put in place so as to leave 6 inches of each row of tiles projecting beyond the ends of the frame.

At the east ends of the bed, a hole should be dug 3 x 4 feet on surface and 2 feet deep; in this hole a crude fireplace may be made of loose brick and the flue connected with the three ends of projecting tile. At the west end of the frame a brick chamber should be made into which the three tiles enter, giving them a common flue for outlet. Cover the top of this chamber closely, excepting a 6-inch circular hole, into which a single length of stovepipe is fitted. A sloping door is hung over the fireplace cavity to keep out the rain; and the earth raised high enough around to prevent surface water from running into the hole. Bank soil about the frame. You may happen to have on hand six old storm window sashes of that size. Of course the sashes slope to the south in the usual way.

When the fire is kindled in the fireplace the smoke comes freely from the stovepipe. The tiles are covered with soil to a depth of about 6 inches. With a good fire, you can quickly warm up the earth on the coldest days of spring. And when once well heated, the earth and tiling hold the heat for a long time, provided the draft is closed. Unlike beds heated with manure, the heat supply can thus



be regulated to suit the demand of the prevailing weather.

## COLD FRAMES AND THEIR MANAGEMENT

In the South cold frames are in use all winter. The principal winter crops grown are lettuce, radishes, beets, cauliflower and occasionally cabbage, while these crops are commonly followed in spring by cucumbers, cantaloups and sometimes Irish potatoes. The frames are easily made. Rough inch lumber (heart pine is best in the South, and hemlock in the North) and 2 x 4 or 2 x 3-inch scantling are all that is required. For the double frames, strips 3 inches wide and  $\frac{3}{4}$  or  $\frac{1}{2}$  inch thick, long enough to extend across the frame, should be provided for rafters. The back or north side of the single frame should be 12 or 15 inches high, while the front should slope down to 8 inches. In Southern practice, where canvas covers are used, the back should be 2½ feet and all cracks should be well covered with building paper, held in place by laths tacked over it.

Good treatment for the posts used in construction is to dip them in kerosene over night. This will preserve them indefinitely. Drive the posts into the ground 18 inches and let them extend upward to the top of the boards, putting a post at the union of each pair of boards and nailing them to it. All ends and rafters may be made so that they can be quickly removed, so that the frames can be plowed and the ground prepared with a mule. The sides of the double frames are best made 1 foot high, with the ends sloping upward to 2½ feet. Down the center of the frame, a row of 2 x 4-inch posts 2½ feet above ground are set 8 feet apart.

Over each one of these a rafter is bent and fastened to the sides of the frames.

For cold frames in the North, glass is the only covering to be thought of. By all means, put the frames up facing the south or southeast and to afford protection against the north and northwest winds, cold the country over, a high wall, a thick hedge, or a piece of thick woodland should be close at the back of them.

The soil in the frames should be thoroughly prepared, rich and pulverized thoroughly. An abundance of well-rotted stable manure should be used; if thoroughly decomposed, at the rate of 75 to 100 tons an acre is not excessive, unless the soil is already very rich. Whether glass or canvas is used as a covering great attention must be given to water and ventilation. The land should be well drained that no water will stand, or the soil become water logged; that is one side of the water question, but in addition, the plants should be carefully watered from time to time to provide sufficient for their needs.

If the coverings are kept down too constantly, the growth of the plants will be weak and spindling and such diseases as damping off, Botrytis and drop will work havoc with them. Careful attention to watering, ventilation and keeping the surface of the ground stirred are the genuine secrets of controlling these pests. Watch the temperature, do not let it rise too high, lower it by raising the sash or drawing back the covers. The canvas covers should be drawn back a portion of every day when the temperature is not too low, and at other times the ends may be raised, to allow the air to circulate under them. A sharp eye must be kept on the

frost item. Sometimes steam heat is provided, oil stoves may be used and glass covered frames should be covered with burlap or straw mats, securely held down either by tying them in place or by weighting them down. Both canvas and the glass covering should be well fastened to prevent their being lifted off by strong winds.

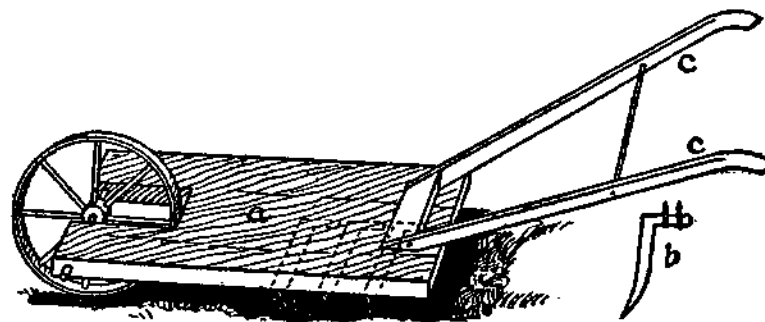
The upper end of glass sash may be held down with a hook and staple, a hook being placed on the back of the frame at the center of each sash with the staple in the end of the sash. Canvas covers are best held down by nailing along the center to a board run lengthwise on the center of the rafters, in the case of double coverings, or along the back in the case of single ones and by placing marbles or small pebbles in the cloth and tying about these every 4 or 5 feet, along the ends and sides, slipping the looped ends of the twine used in tying them over nails driven into the ends and sides of the frame.

### A HAND GARDEN CULTIVATOR

Now that garden crops are planted almost exclusively in rows a tool that will clean out the weeds, stir the soil around the plants, and, by making a good surface mulch, prevent the loss of moisture to some extent, is essential for the proper care of the garden. The wheel hoe of our cultivator is usually used for this purpose by the professional gardener, but the price is generally considered rather high by the ordinary farmer or amateur.

This machine, although homemade and not very handsome in appearance, does the work as well as a \$6 or \$8 tool, and cost not more than 40 cents

to make. For a wheel, take the fly wheel of an old sewing machine, about 1 foot in diameter, and put a round bolt tightly through the axle. Then a piece of plank, *a*, 20 x 10 inches, and cut as shown, boring holes for the axle where marked. After the wheel is set in place, it should turn easily and steadily, if balanced properly. For the handle, *c c*, cut out and round from a piece of plank two pieces, or use any that may be otherwise obtained. Then get a blacksmith to make three teeth, *b*, out of a



HAND CULTIVATOR

piece of spring steel 1 inch wide and 8 inches long, bent as shown. Two-inch holes are drilled through them for screws.

One tooth should be placed about 6 inches behind the wheel and directly in the center, the other two being 4 inches behind the first, and the same distance from the center tooth. When this cultivator is pushed through the rows it should run with little pressure from the operator, clearing out the weeds and stirring the soil at the same time. This contrivance does the work well, and if given two coats of brown and green paint it will be improved in appearance.

Know thy opportunity.—Pittacus.

## A CONVENIENT GARDEN STOOL

This device will prove useful in doing hand work in the garden. It is made from two barrel staves upon which is mounted a low stool. This should be narrow, so that it may be drawn between the rows of vegetables. The holes in the seat are large enough for the fingers to go through and render the stool more easily handled. The device is especially convenient for the women.



WEEDING STOOL

## WATERING SEED SOIL MADE EASY

To avoid disturbing small seeds by watering, when planted in forcing boxes, a plan has been devised which not only insures against the disturbance of the seed, but keeps the soil of the entire box in a moderate state of moisture, which is an essential feature in early growth.

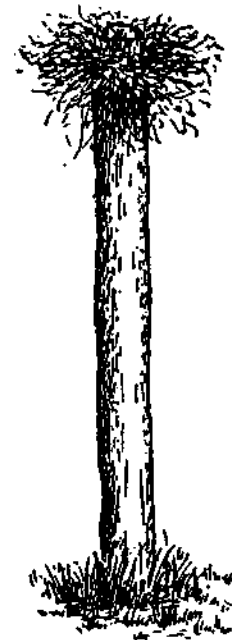
Make a box of any desired size to suit the occasion, and about 3 inches deep. Then get a few small unglazed flower pots and place same on stove until quite hot. With a short piece of candle, seal drain hole in bottom of pots, taking care not to put wax over the entire bottom of pot. Place pots in box about 9 inches apart on a thin layer of sand, and overlap pieces of broken pots, to convey by capillary attraction the water to the entire soil of the box, which soil should be sifted and box filled to within  $\frac{1}{4}$  inch of the top of the pots.

Cover the box with glass, and heat from above will draw the water up to the roots. By this method you will not have surface baking, which is so troublesome with surface watering. If so desired,

you can cover the pots with circular pieces of paste-board or tin, and avoid surface evaporation from the pots. Always fill pots with warm water.

## CATCHING OWLS AND HAWKS

A friend of ours captured a large owl and fastened him securely with a small chain to a stake in the middle of an open field. He set three posts 5 feet tall and 4 to 5 inches in diameter 20 to 30 yards from the owl, and on each post placed a small steel trap with a bunch of hay or grass tied to the post just under the trap, to hide it, as shown in cut. At night, the owl called. Others came, and seeing nothing near, alighted in the trap on the post. During the day hawks came, and were caught in the same way. In two months two owls and 17 hawks were caught. In some places a bounty is paid, so there is a profit in two ways. The owl may be fed on the hawks caught and on rabbits or chickens that may die around the premises. The most difficult part of this scheme is often the capture of the first owl, but if you are a good hunter you will find a way.



TRAP ON POST

---

Make no absolute promises, for nobody will help you to perform them.

Money is a good servant, but a bad master.

## MOVING A LARGE TREE

To move a large tree one may find it very satisfactory to use a rig similar to that shown in the picture. Make a three-sided standard of 2 x 4-inch stuff. Loosen the dirt around the roots of the tree



RIG FOR MOVING TREE

and wrap the tree firmly at the base with old carpet or burlap to prevent injury. Place the standard firmly in the ground and tie the cross-piece to the body of the tree with strong rope to each side of the standard and hitch a horse to the

other end. With a slow pull the tree can be drawn onto the drag and then hauled to the new location. It can be placed in the ground again by using the standard in the same way it was used to load it upon the drag.

---

A penny saved is two pence clear,  
A pin a day's a groat a year.—Benjamin Franklin.

The man who builds, and wants wherewith to pay,  
Provides a home from which to run away.—Young.

---

## TRANSPLANTING TREES

Here is a way to transplant large trees that is not so difficult as such transplanting is by many supposed to be. The first move to make is to dig all round the tree, leaving a large ball of soil, which is carefully wrapped in sacking or canvas to hold it on the roots and prevent drying. When this is well tied in place a chain is passed round the ball two or three times and hooked, as shown in Figure 1.

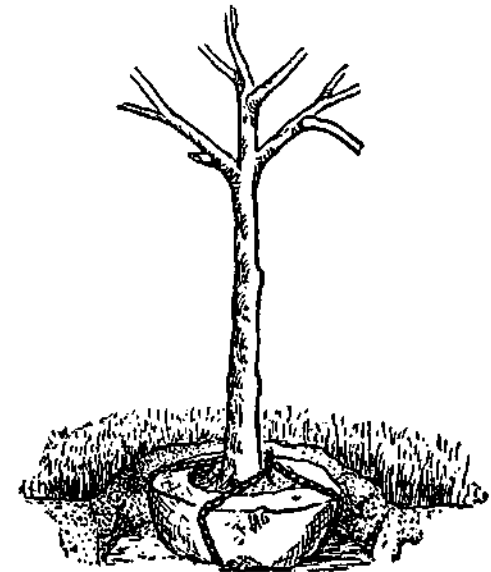


FIGURE 1—BALLED

Then with a pair

of heavy wheels on a short axle and a strong pole laid across it, with a massive iron hook fastened to the pole, it is easy to back up to the tree. The sketch, Figure 2, shows the truck with its lever raised ready to hook into the chain. The rope at the end of the pole brings it down and the tree up, when the pole is fastened under a second pair of wheels. The young trunk must be kept from contact with the machinery by the free use of blankets and bags. The secret of success in transplanting trees is to injure the roots as little as possible.

FIGURE 2—HOOK AND TRUCK

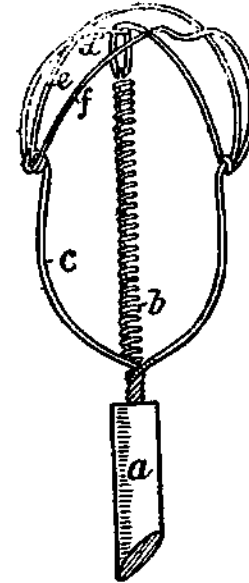
The manly part is to do with might and main what you can do.—Emerson.

Many things difficult to design prove easy to performance.—Samuel Johnson.

### HOMEMADE FRUIT PICKER

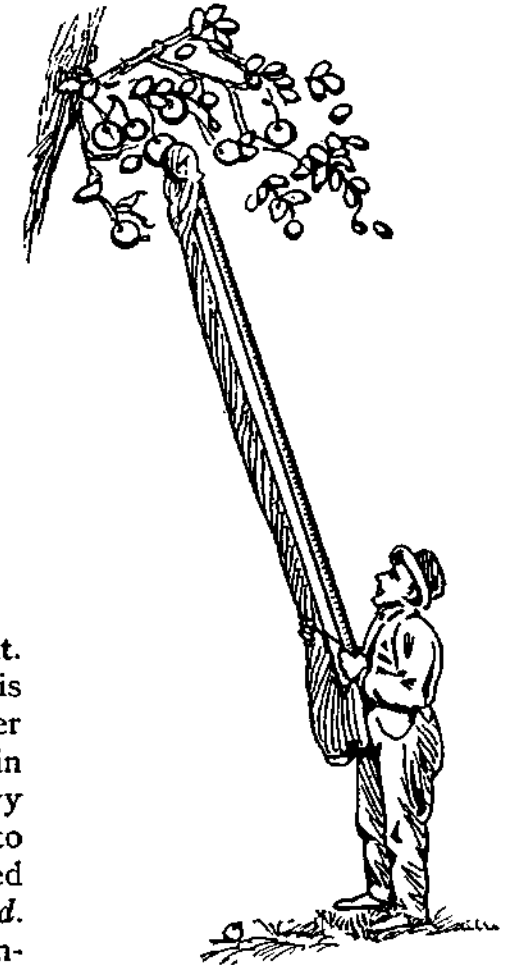
This is a device that is hard to beat for reaching fruit at the top of tall trees. After a little

practice, a man can operate it rapidly, far outstripping hand pickers and at the same time not



WIRE DETAILS

injuring the fruit. The construction is shown in the upper drawing. The main frame is of heavy copper wire, to which is attached the strong spring, *d*. The end, *a*, is inserted into a wooden handle as long as



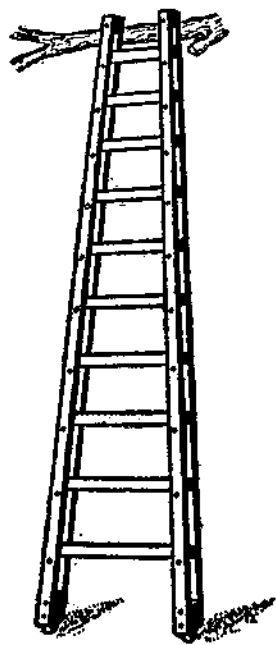
THE PICKER IN USE

needed. When the muslin sack is attached, as shown in the picture of the picker in use, the jaws of the picker are easily closed by pulling slightly on the cloth. The fruit falls through the sack or long cloth tube into the hand of the operator. Many

devices have been made for this sort of service, but it will be hard to find one that works better than this one if constructed in the exact shape indicated.

### A TRUSS LADDER

For a 14-foot ladder select four pieces of 1 x 2 hard wood, using two pieces for each side. Place rungs of 1 x 2 between the side pieces. Make ladder 12 inches wide at top, 14 inches at center, and 30 inches at the bottom. Put a 1/4-inch bolt through the side pieces just below the rungs, and a 6d nail through the end of each rung to prevent them from slipping out. Keep all bolts tight. A ladder made as above, of Oregon pine, 14 feet long, supported on trestles at each end, deflected but 1 inch when 150 pounds were placed on the center. It is light, yet strong, and it is almost impossible to spring it. The special advantage of a truss ladder is lightness, which is a very great advantage, when strength is combined, as in the case of this particular ladder.



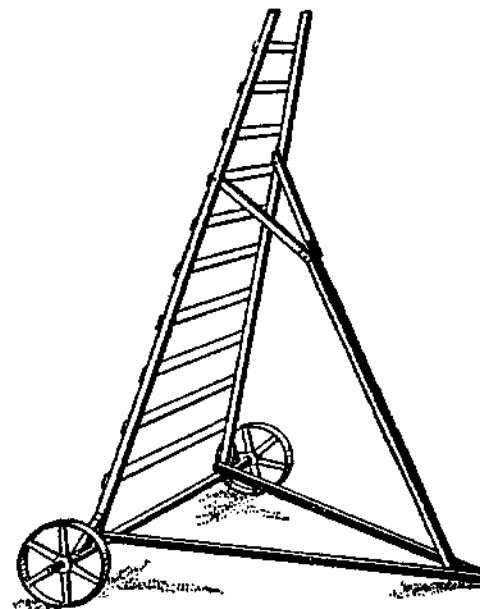
THE LADDER

Let us have faith that right makes might; and in that faith let us to the end do our duty as we understand it.—Lincoln.

Never spend your money before you've earned it. Never buy what you do not want; it is not cheap.

### ORCHARD LADDER ON WHEELS

The accompanying sketch shows the manner of construction. Any farmer or orchardist can build it. Secure two old mower wheels and one piece of 2 x 4 scantling for an axle. Place the ladder upon this scantling. To keep it upright use poles, two at the bottom and one near the top of the ladder, extending to the ground. The upper one should be forked at the top so as to hold the ladder firmly. This ladder is 18 feet high, and as the foundation is broad, there is no danger of it falling over. The brace is so made that it can be adjusted, thus enabling one to place the ladder at any angle.

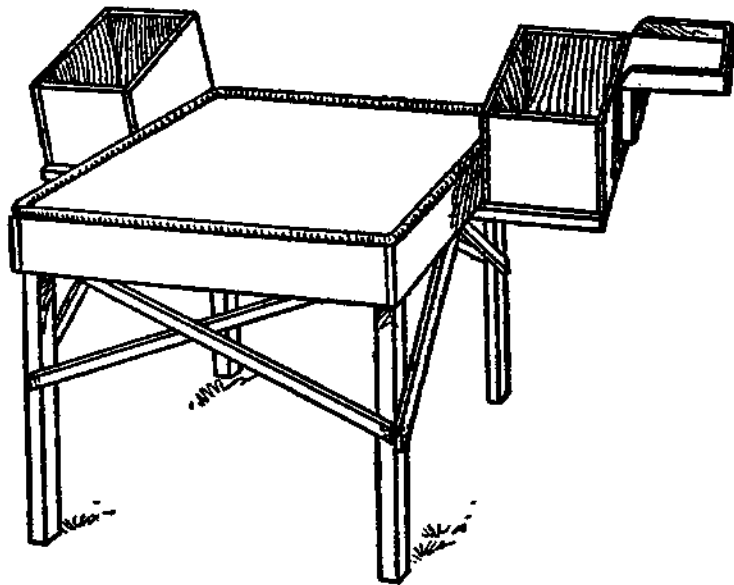


LADDER FOR FRUIT TREES

### CONVENIENT SORTING TABLES

Where fruit is packed from the trees a sorting table will always be found convenient. It generally saves time and labor to do the packing right in the orchard. A handy table is one mounted on wheels which may be of any size desired and should be large enough to hold at least four barrels. The

wheels can be picked up from discarded machinery or quickly made by nailing together crosswise two boards to prevent them from splitting, boring a hole in the center for the axle and rounding them off with a key hole saw. One end of the table should be made several inches higher than the other, so that the culls will roll into a pile at the lower end.



OREGON SORTING TABLE

In the Hood river district of Oregon a table such as shown here is commonly used. This is made to accommodate two packers. To make such a table take four standards about 3 feet high. It is made 3 x 4 feet in size, the top covered with strong burlap or canvas and allowed to hang rather loosely. Saw off the tops of the legs on a bevel so as not to have the sharp corners push into the burlap, and make points that will bruise or cut the fruit.

A piece of old garden hose is generally nailed around the top of the table to protect the fruit. Besides the braces shown in the cut it is also well to wire the legs and braces together firmly, as there is a heavy load to support. The shelves on each side are for holding the boxes, as all the good fruit in this region is boxed. The height is only relative, the point being to construct it so each packer can work with the greatest comfort, avoiding back bending in all cases. The top should not be greater than 3 x 4 feet, as anything larger would not allow two packers to reach all points of it without unnecessary stretching.

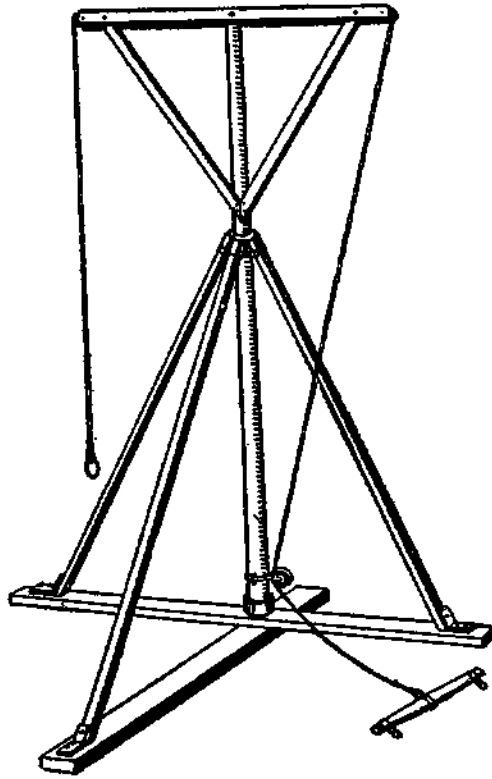


## PORTABLE HAY DERRICK



**A** VERY satisfactory derrick for stacking hay is shown in the sketch. The base pieces are 6 x 6 inches by 16 feet. For the center pole we use a straight round pole 7 inches in diameter at the base and 5 inches at the top about 24

feet long. We put an iron band around the base and insert the peg upon which it turns. About half-way to the top is an iron collar, which has three loops to it that form an attachment for the braces, which are fastened about 15 feet from the bottom of the central pole. This allows the pole to turn readily when in upright position. The top framework is made of 2 x 6-inch pieces

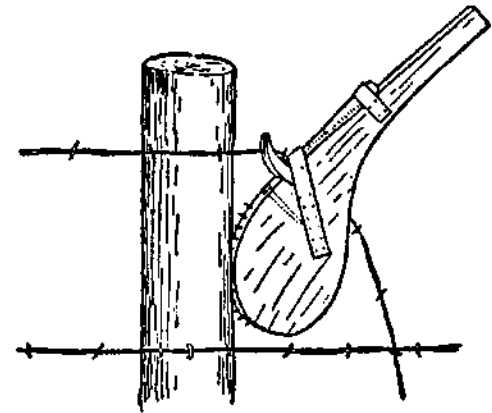


HAY DERRICK

12 feet long. The rigging, consisting of three pulleys and the hay rope, is attached as shown in sketch. By having the lower pole attached near the base of the upright the arms will make half a turn when the hay fork is lifted, thus swinging around from the ground or wagon onto the stack.

## A WIRE TIGHTENER

Here is a device easily made and very convenient to use in tightening barbed wire when stringing it upon the posts. Cut out a piece of inch board in the shape shown in the picture with a notch to let in the face of a hammer. Insert a long bolt at the point indicated by the light dotted lines, to prevent splitting. Fasten on the hammer with leather straps. The sharp brads should stick out about half an inch. Carefully finish the handle so that it will be smooth and not hurt the hands when you are using the device. It should be made of tough hardwood.



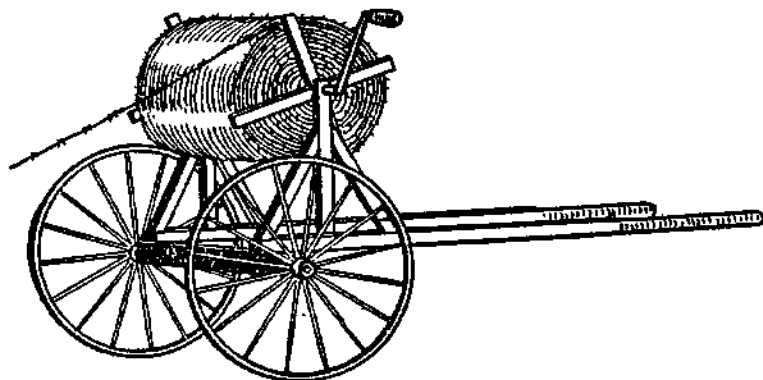
TIGHTENER IN USE

## FENCE WIRE REEL

Here is a device on which one can wind barbed wire that is much better than an old barrel. The reel is mounted on a truck made of old buggy wheels with short shafts. The cart may be drawn



along by a man while a boy steadies the reel to keep it from unwinding too rapidly. For winding up wire, the machine is best pushed just fast enough



WIRE REEL ON WHEELS

to keep up with the wire as it is being wound on the reel. A crank placed upon the reel proves serviceable in winding up.

---

Never sign a writing till you have read it; neither drink water till you have seen it.

One part of knowledge consists in being ignorant of such things as are not worthy to be known.

Get the work habit.

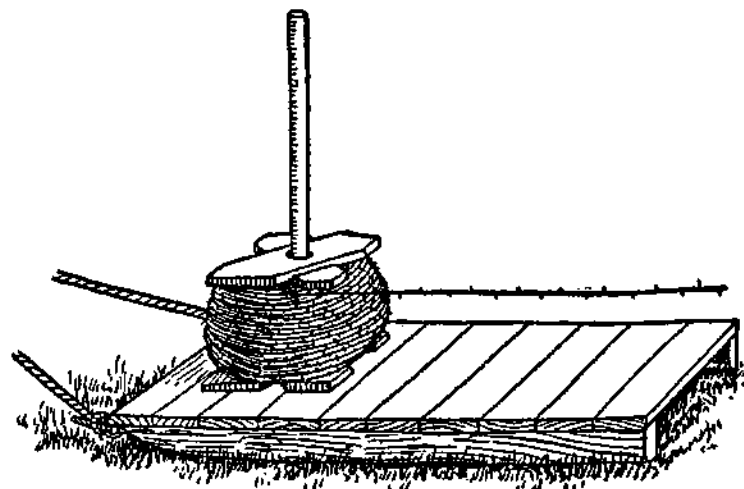
---

### SAFE WAY TO STRING BARBED WIRE

One of the most satisfactory ways to unreel barbed wire is to make a contrivance similar to the one shown on page 157. Fasten a short piece of plank to the front end of a stone boat. Bore a 2-inch hole in this plank and set the spool

of barbed wire on top. Run a piece of gas pipe about 5 feet long through the spool and let the bottom end rest in the hole made in the plank.

Attach the stone boat to the rear end of the wagon and have an assistant sit in the wagon and hold the top end of the pipe. If the wire becomes kinked the assistant simply lets go of the pipe and the spool rolls off the boat without breaking the wire.



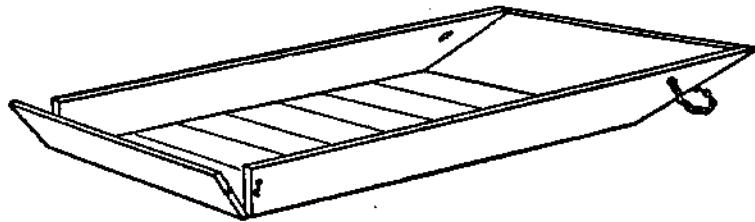
WIRE REEL ON BOAT

### A BOXED STONE BOAT

A flat stone boat or drag is convenient for many purposes, but its uses are limited because it has no great capacity. On page 158 is shown an arrangement for increasing the utility of a stone boat 100 per cent. It is made of plank and has sides 1 foot high. It may be used for the purpose for which the ordinary drag is employed, and in addition is very convenient for hauling apples, potatoes, or other root crops from the field.

By increasing the size of the box, manure can be

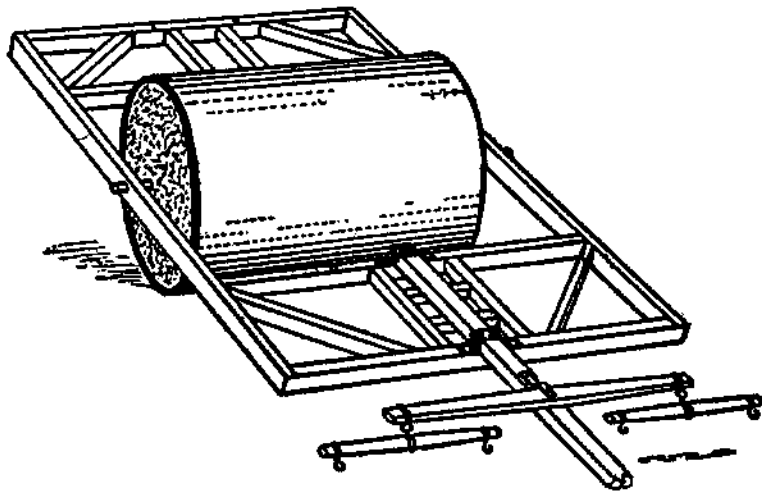
hauled out from stables as it is dumped into it from wheelbarrows without having to reload or wheel up an incline. It is low on the ground and very convenient for loading. All light, bulky articles, as well as heavy stones, bags of fertilizers and seed, can easily be hauled on this contrivance.



CAPACIOUS DRAG

### A HOMEMADE ROAD ROLLER

If you need a road roller get a heavy sheet iron cylinder, stand it on end and place a length of  $1\frac{1}{2}$



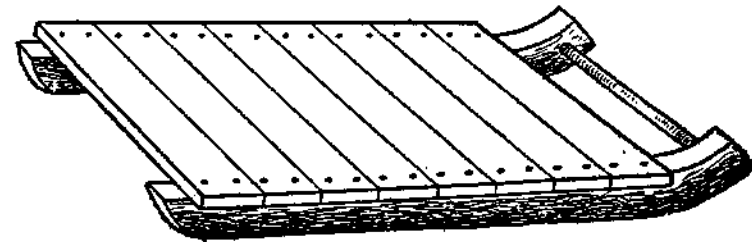
ROAD ROLLER

or 2-inch pipe through the center. The end should be placed on planks which are well soaked or are

well oiled, and the pipe braced to keep it exactly in the center. Fill the cylinder with good concrete, and when it has set tip it over and build a frame for it, so you can hitch a removable tongue at either side. The frame should be made of good strong hardwood well braced. The cuts show plainly just how the roller is made and put together.

### AN OLD-FASHIONED DROGUE

Drogue is an old-fashioned word applied to a low drag or sled, something like the stone boat in general use now. The word is seldom heard today.



HOMEMADE HANDY DROGUE

So accustomed are we to the regulation stone boat that most of us do not know that there is still a more handy arrangement that is fully as easy to build and better to use, because it cannot slide sidewise on a hill. Select a small tree that has a bend in it the shape of a sled runner and split it with a sharp saw while it is green. It saws fastest and easiest while frozen. Saw or hew the bottom and top flat, so planks about 4 feet long may be pinned to it. Bore the front ends so a heavy stake with a shoulder may be inserted to prevent the runners from drawing together, and the drogue is done. It is handy for all work, but may need side rails spiked to it, if small stones are to be drawn.

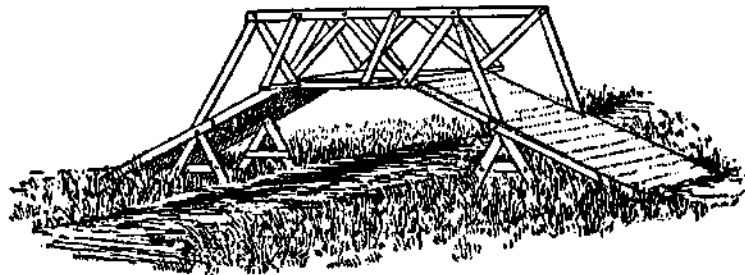
Regular boat planks are not easy to obtain now that the old up and down saws are not in use.

### A DITCHING SCRAPER

There should be a ditching scraper on every farm. They can be purchased made of steel, but a homemade one costs little and is quite serviceable. Take two planks, each 10 inches wide and 3 feet long, of good 2-inch hardwood. Bolt to them securely a pair of old plow handles. To the bottom bolt an old crosscut saw blade which will make a sharp edge. Let this project about an inch at the bottom. Attach two singletree hooks near each end of the lower board and your scraper is ready to use. With this scraper and two men a ditch can be cut one-quarter mile long and as deep as it could be plowed with a turning plow in two days' time. It is also very useful in filling holes in the highway.

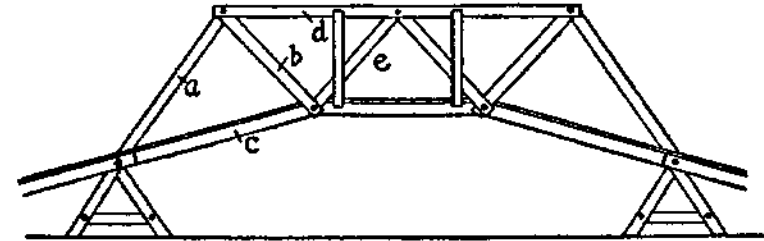
### BRIDGE FOR A SMALL STREAM

For crossing a small creek or deep ditch a cheap bridge can be built as shown in the illustration. The lumber used is 6 inches wide and 2 inches thick, except for the floor and four side braces.



A BRIDGE OF TRIANGLES

Saw 11 pieces the length required for each of the two sides, then bore bolt holes  $1\frac{1}{2}$  inches from each end. Use  $\frac{5}{8}$ -inch bolts  $8\frac{1}{2}$  inches long where four pieces come together and  $6\frac{1}{2}$ -inch bolts where

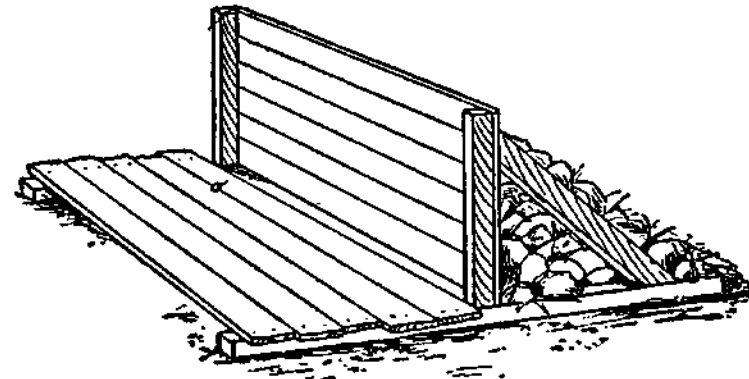


FRAMEWORK OF BRIDGE

three pieces meet. The A-shaped supports and the pieces for the approaches are bolted on at once, and then the side braces are put on. The sides of the bridge are made entirely of triangles. The first triangle is made of pieces, *a*, *b* and *c*. The second triangle of the pieces, *b*, *d* and *e*. The piers may be posts, stone or concrete.

### DAM FOR FARM POND

A small pond held by a good-sized hydraulic dam supplies water for house, barn and two acres

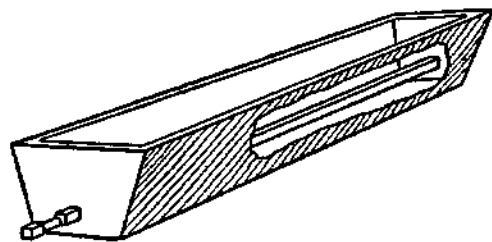


EASILY BUILT DAM

of garden and fruit, also floods a cranberry meadow when needed. A section of the dam is placed 6 feet apart and covered with plank fitted tight. The apron is of 12-foot plank spiked to the sills so as to break joints. The bottom is made tight with brush and clay. Stones are piled in behind the plank coverings, as shown in cut.

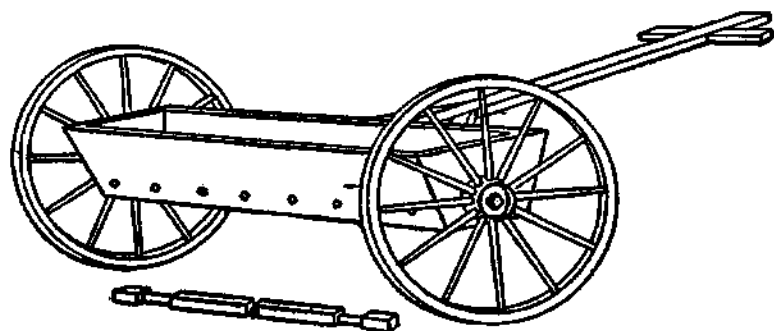
### SOWING SEED EVENLY

These drawings show the construction of a wheel seeding device that can be easily made at home.



THE SEED BOX

The axle is tightly fitted into the wheels so that it turns when the wheels do. This agitates the grain or other seed and helps to keep the seed running out of the holes at the lower back side of the box. The quantity of flow may be regulated at pleasure by making the holes large or small and increasing or diminishing the number of holes.



A SOWING MACHINE

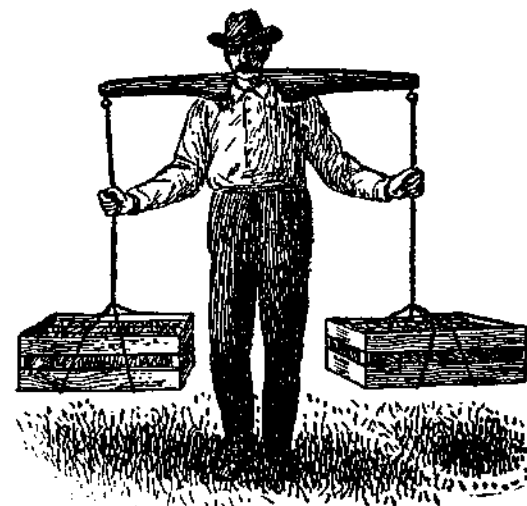
It may be found desirable to have a considerable number of holes and then having plugs, for alternate ones, perhaps, which may be removed to make the seeding thicker. From 4 to 6 feet is suggested for the length of the box. Any old wheels will do if they are not too heavy to be easily drawn by hand.

### BERRY CRATE CARRIER

One of the most convenient appliances for use in the strawberry field is illustrated in the picture shown herewith. It shows a novel use for the old-fashioned yoke used so commonly on the old-

time farms. The picture is so readily understood that no description need be given. This also suggests the many purposes for which a yoke may be used on a farm. Every farmer ought to have one, to make more easy the task of carrying things. In

some places yokes may be found for sale, but if you cannot buy one, make one yourself. Take a piece of strong, tough wood, shape it out to fit around the neck and shoulders and taper off the ends to what you consider the right size. Usually a groove is cut around about  $1\frac{1}{2}$  inches from each end and

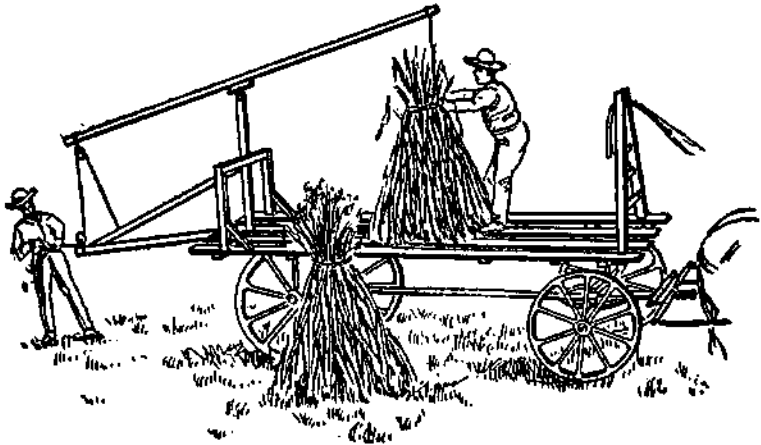


YOKE CRATE CARRIER

a rope is securely tied. At the other end of the rope a hook is attached the right size to go around the bail handle of any ordinary pail. The hook may be iron or may be formed from a strong, branched stick.

### HANDY LOADING DEVICE

Here is a rig simple and strong that works well for loading corn in the field. The picture shows



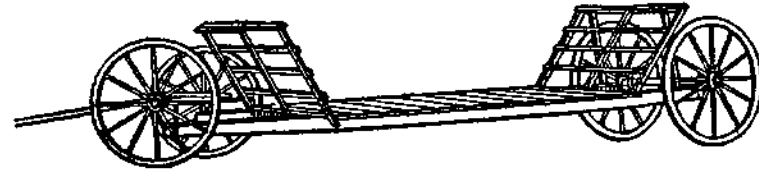
LOADING RIG IN USE

the construction of the rack and hoisting device with pulley attachment. Such a rig will be found useful for loading many things on a farm.

### RACK FOR HAULING FODDER

A handy rack for hauling fodder from the field is shown in the drawing. It may be used for any kind of corn, of course, for sorghum, and may be found useful in moving brush. Each end of the

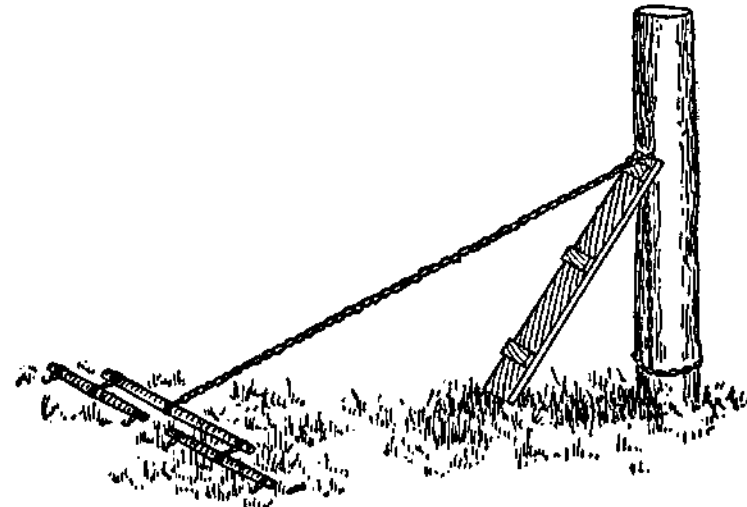
rack is hung from the axles by two straps of iron that can be obtained from any blacksmith at very little expense.



FODDER RACK

### PULLING FENCE POSTS

An easy and practical method of pulling fence posts, by which all digging and hand labor is eliminated, is here shown. Take a plank 4 feet long,



POST PULLER IN POSITION

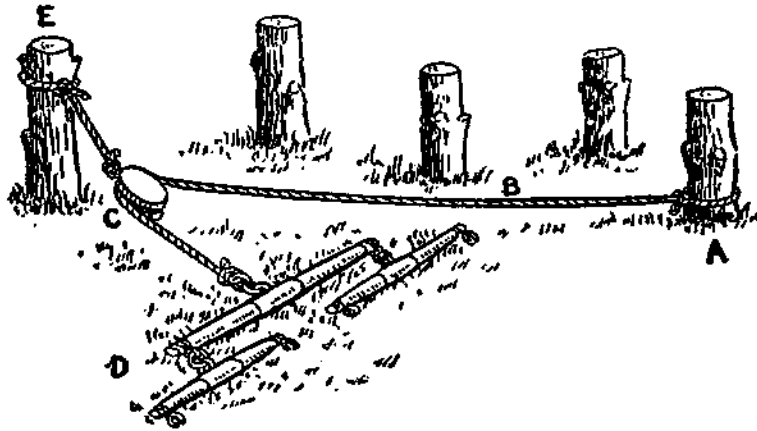
1 foot wide and make a V-shaped notch in one end, nailing on several crosspieces to prevent splitting. This plank is used to change the horizontal draft to the vertical.

Place one end of chain around the post close to ground. Incline the plank against the post so the lower end of the plank will be about  $1\frac{1}{2}$  or 2 feet from the base of the post. Place the chain in the notch of the plank, start the team and the post in a few seconds will be clear of the ground.

In moving fences the chain should be attached to the rear axle of the wagon, so the posts may at once be loaded and hauled to the new location of the fence.

### ONE WAY TO PULL STUMPS

A Connecticut man has a very handy device for pulling peach stumps from old orchards, and can



TACKLE FOR STUMP-PULLING

pull 200 or more a day by this means. The limbs are cut off and the stumps, E, left as long as possible. A short rope or chain with a single pulley is attached to the top of the stump. The anchor rope, B, which runs through the pulley, is fastened to the bottom of a stout stump, A.

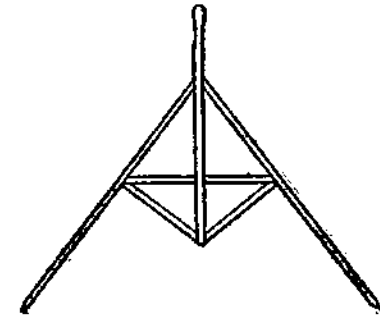
A pair of steady horses is attached to the rope and always pull toward the anchor stump. With

a steady pull there is no jumping or jerking, and they will walk right off as if pulling a loaded wagon. Use about 60 feet of 1-inch rope, which costs \$2.40, and the pulley, \$1.75, making a total cost of \$4.15.

### SIMPLE LAND MEASURE

Having much land measuring to do that requires greater accuracy than just "stepping it off," make a simple affair like this.

The manner of construction is made plain. Use hardwood pieces;  $\frac{5}{8}$  or  $\frac{3}{4}$  x 1 inch is heavy enough. Have lower points exactly 5 feet 6 inches apart. Make a round head on the handle. Grasp the top lightly in hand, holding at the side, whirl handle to bring rear point to front, moving off in direction to be measured. Continue to revolve measure, changing points in advancing. It takes three lengths to the rod.



THE MEASURE

### STORING WATER

An easy way to make a reservoir at the spring is to throw up a bank, perhaps laying a wall first, founding it below the surface. Should the soil be such that water percolates through it, face the soil with loam on top and puddle it well. If this leaks, face it with clay and puddle the clay. These rules apply to all dams made of stone and earth.

Pipes entering reservoirs should enter at the bottom and the soil be well puddled around them

to prevent the water working through beside the pipe. Each pipe must have a strainer over its supply end and have no air holes in its entire length.

A good strainer can be made from a piece of large lead pipe punched full of holes. One end may be flattened or turned over and the other drawn on over the end of the water pipe. Let nobody suppose that simple, inexpensive arrangements are faulty because primitive. If constructed correctly and in line with natural laws, they are not only all right, but are preferable to fancy, complicated devices that get out of order easily or in a year or two and require a master mechanic to put them into working condition again.

### GETTING A SUPPLY OF FUEL



**A** PLAN for getting up the year's supply of fuel is suggested as follows: Fell the trees on the ground with a small sapling under them, so a log chain can be passed beneath. Then a logging bob (Figure 1) is tipped up on its side near the end of the log; a chain is hooked to the bolster near the ground, passed under the log and over the top runner of the bob and the team hitched to the end of the chain. A quick pull of the team and the bob comes down on both runners, with the log on the top of the bolster.

The log is now drawn to some sheltered place near the woodhouse and sawed into stove lengths with a 6-inch crosscut saw on the skidway shown in Figure 2. The limbs are trimmed in the woods, drawn on a pair of bobs to the shop, where there

is a three-horse power boiler and two-horse power engine, and are sawed at the rate of  $1\frac{1}{2}$  cords an

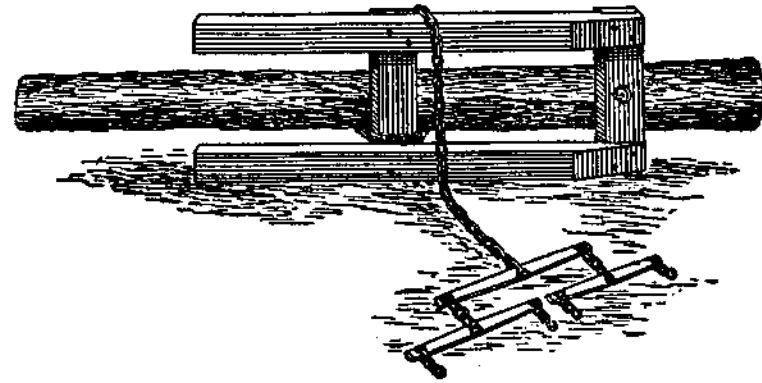


FIGURE 1—LOGGING BOB

hour with a buzz saw. A handy device can be made of two crotched limbs, as shown in Figure 3, to saw large limbs on. A 2-inch auger hole is

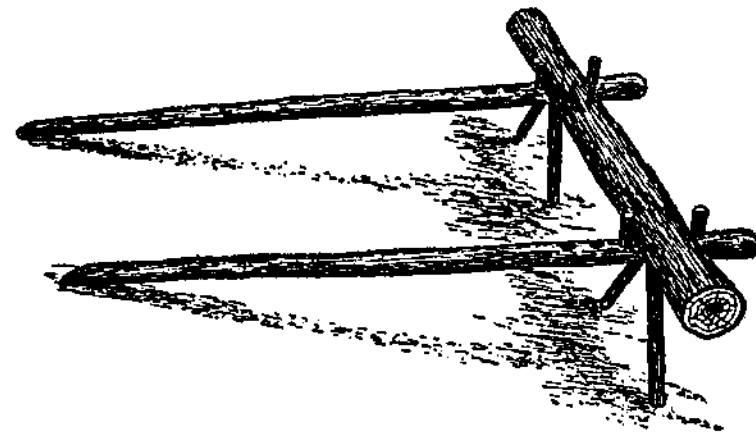


FIGURE 2—SKIDWAY

bored where the limbs branch, and a hardwood limb driven tightly into the hole.

The following described device (Figure 4) is very handy to hold and lower the tree after sawing

the stump off. [*a*, planks with holes bored in them; *b*, log; *c*, chain; *d*, crotched limb; *ee*, lever; *f*, iron pins.] It is made of two hardwood planks about 8 x 5 inches and 1½ inches thick bolted together at the top and bottom, with a 2-inch space between

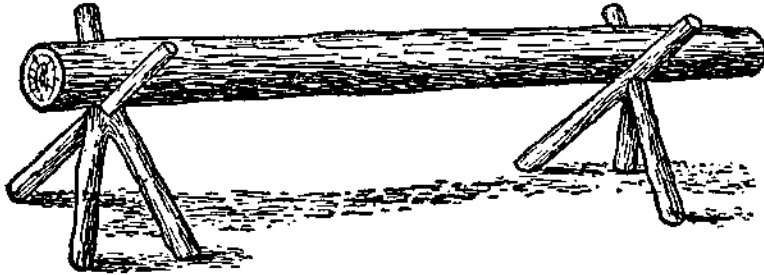


FIGURE 3—HANDY SAWHORSE

for the lever to work in. One-inch holes are bored through the sides of both planks, in which iron pins are placed for the lever to pry over. The lever is made of white ash, and has two notches near the large end, with a chain link attached midway be-

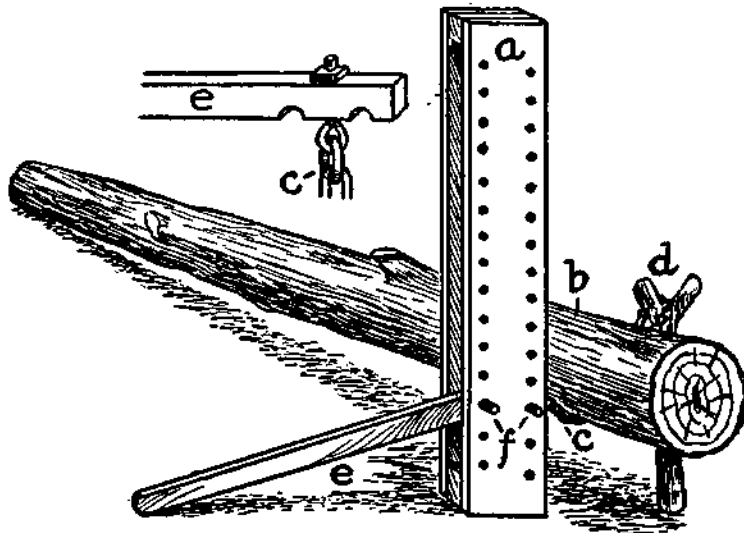


FIGURE 4—LOG JACK

tween notches. A stout chain is hooked in the link, passed under the log, and attached to a crotched limb leaning slightly against the opposite side of the log. By working the small end of the lever up and down and moving the pins up one hole at a time, a good-sized tree can be raised from the ground high enough to be sawed easily without a backache.

### SIMPLEST OF ALL CAMPING TENTS

The great trouble with camping-out tents is the weight of the frame, but the weight of the latter in

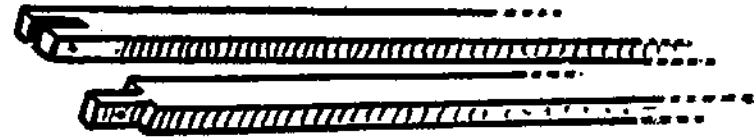


Fig 1

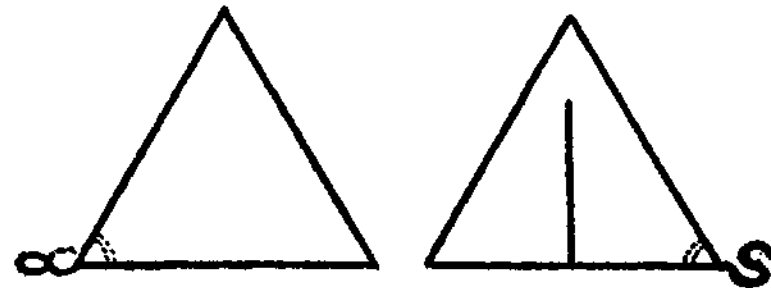


Fig 2

DETAILS OF TENT

the case of the tent figured herewith will hardly prove a burden to anyone, as only two light sticks are used, such as are shown in Figure 1. These



are pressed into the ground 8 or 10 feet apart, according to the size of the tent, and brought together and fastened at the upper ends with such a joint as is shown, or with a string passing through a screw-eye in each pole, if a simpler method is preferred.

The tent is made from four triangular pieces of cloth, as suggested in Figure 2. One of these is cut up the center and hemmed, to afford an entrance to the tent. The triangular pieces are sewed together at the edges and at two of the opposite



THE TENT SET UP

corners pieces of stout cord are sewed into the corners of the cloth, the cloth being reinforced as suggested in the cut.

Two stout pegs of wood and two lighter ones are provided. To pitch the tent, put up the two frame poles A-fashion and draw the tent cloth over them, opposite seams and corners fitting over the poles. Draw out the other two corners and tie by the ropes to the stout pegs which have been driven into the ground. The two lighter pegs are

used to fasten back the flaps of the front. It may be found well to hem a light cord into the bottom of the side having the opening, leaving the flaps free from the cord. The position of the cord is shown by the dotted line. It will not be in the way when lying across the opening of the tent on the ground and will strengthen the whole when the outer corners are drawn tightly up to the stout pegs.

This makes a practically square tent and the size can be as large or small as may be desired. To cut the side pieces, decide on the width of the sides and the height you wish the tent to be. Then draw a triangle (Figure 2), having the base as long as desired for the side of the tent, and a perpendicular 2 feet longer than the height desired for the tent, since the four sides of the tent are to be inclined, and must, therefore, be enough longer to make up for this.

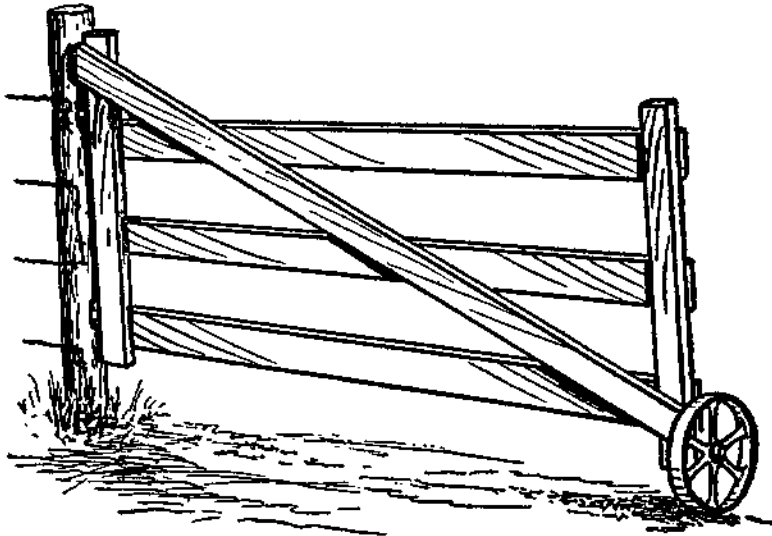
This will prove a very satisfactory tent for boys who are camping out, and it has the merit of being easily made and very easy to carry about.



### KEEPING A GATE FROM SAGGING



THE average farm gate is heavy, and after a little time it sags. When they get this way it takes a strong man to open and shut one. Here is a remedy. Get a wheel, either big or little, from an old piece of machinery, and bolt it to the front end of the gate in such a way that the gate will be held level. Now the smallest child can open

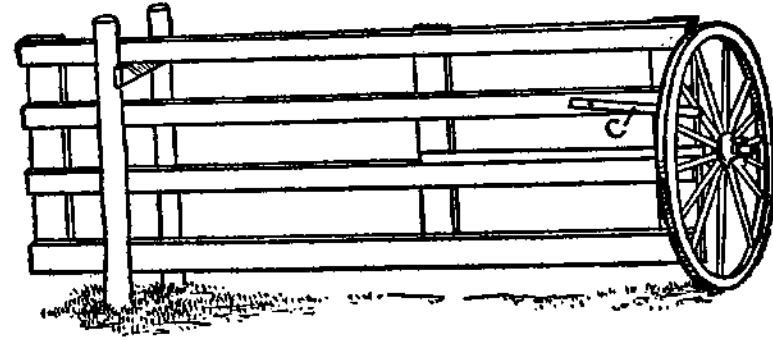


OLD PLOW WHEEL DOES THE TRICK

the gate for you. Try it, for it is a saver—saves your patience, your back and the gate.

### AN EASILY OPENED GATE

Take an old buggy wheel and fasten it as shown in the drawing to the gates that are opened often. The piece of board indicated by *c* drops between



GOOD USE FOR A WHEEL

the spokes of the wheel and holds the gate either open or closed. A child can easily operate the heaviest gate with this attachment.

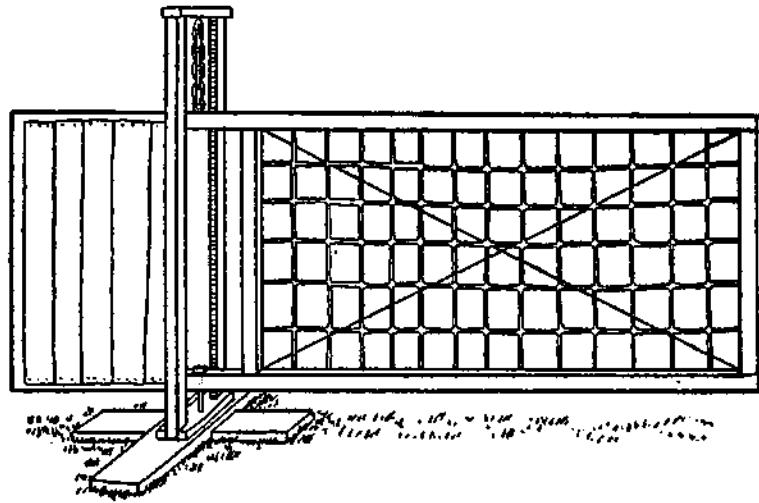
### A GATE THAT NEVER SAGS

A farmer has used this gate for many years and never spent five minutes repairing it. Countersink



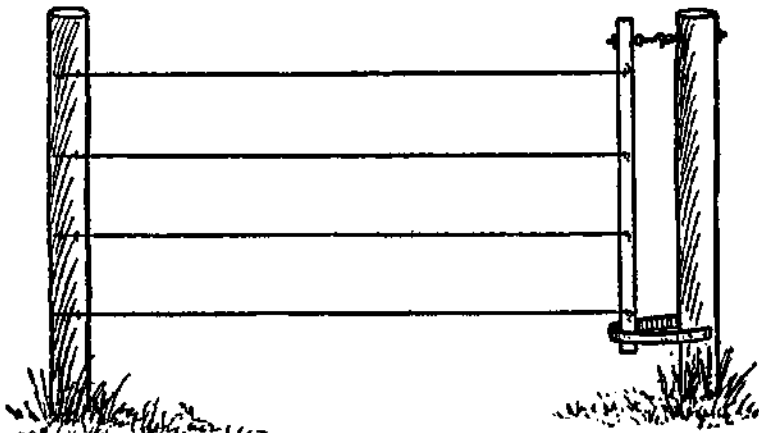
CROSSPIECE

two pieces and pin them together. Then set up two 2 x 4 pieces 2 feet higher than the gate so it can be raised in winter. Mortise and set in between the crosspieces, which are 12 inches apart, the board, *a*, and fasten a cap to the top of the frame. The gate is 16 feet long, 12 feet being for the gateway and 4 feet for the weights to balance it. The frame is of 2 x 4s. Cover the 4-foot end with boards and fill with enough stones to balance it when hung.



BALANCED WIRE GATE

Cover the gate with wire fencing and hang by a chain. Put a bolt through the lower part of the frame into the crosspiece, *a*.

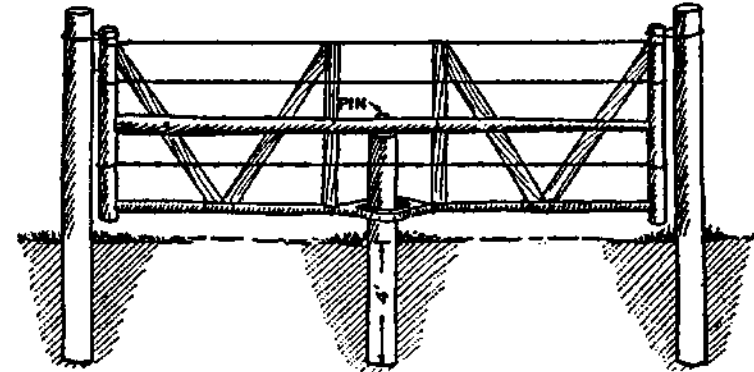


WIRE GATE THAT SPEAKS FOR ITSELF

### A CHEAP GATE

A light, useful and durable gate can be made of sassafras poles and barbed wire, as shown in the

cut. Set a strong post 4 feet in the ground in the middle of the gateway and balance the gate on it.

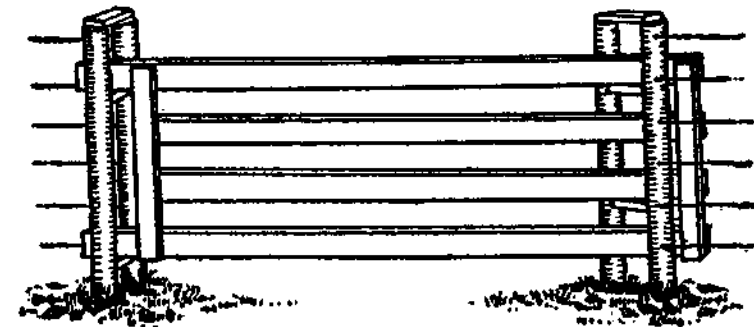


POLE AND WIRE GATE

The lower rail is made of two forked sassafras poles securely nailed together so as to work around the post.

### A SIMPLE FARM GATE

Many like such a gate as that shown in the cut. Material to be used depends largely on the purpose for which the gate is made. For a paddock or pasture gate, make it out of seasoned boards 1 x 6 inches, 12 or 14 feet long. The posts supporting

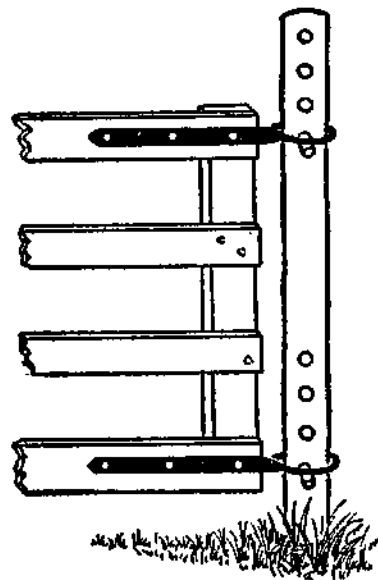


GATE SIMPLE AND STRONG

the gate are about 5 inches apart, the one on the inside being about 8 inches ahead of the other. They are joined together by cleats or rollers which support the gate and allow it to be pushed back and swing open. If rollers are not obtainable, cleats made of any hard wood are good. They need not be heavier than 1 x 4 inches. If the gate is to be used for a hog pasture, the lower cleats on both sets of posts should be placed just above the lower board to prevent the hogs from lifting it up.

### AN EASILY REGULATED GATE

The gate hanger illustrated in the drawing is very handy for use where it is desired to let hogs



ADJUSTABLE HANGER

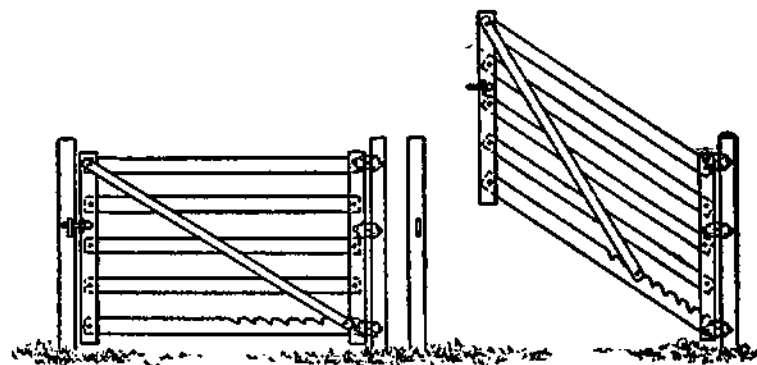
pass from one pasture to another while cows are confined to one. As shown, the hanger is a piece of strap iron bent around the post and supported by pegs. These pegs may be inserted in holes at varying heights. Raise the gate to let the hogs through and lower it to keep them in, of course. This is also a good device for raising the gate above the snow in winter. Many would find this use of the adjustable hanger prefer-

able to the gates made to raise only one end for snow. Of course it is desirable that there should be the least play as possible while the hanger

slides up and down freely, and special care should be taken to set the post firmly. Otherwise the gate would sag.

### GATE TO OVERCOME SNOWDRIFTS

In the picture is shown a gate which can be readily adjusted to swing over snowdrifts. It is easily made from ordinary lumber. A 1 x 6-inch upright is used for the lower boards, 1 x 4 for the upper ones. The uprights at the hinge post are double 1 x 4, one piece outside and the other inside

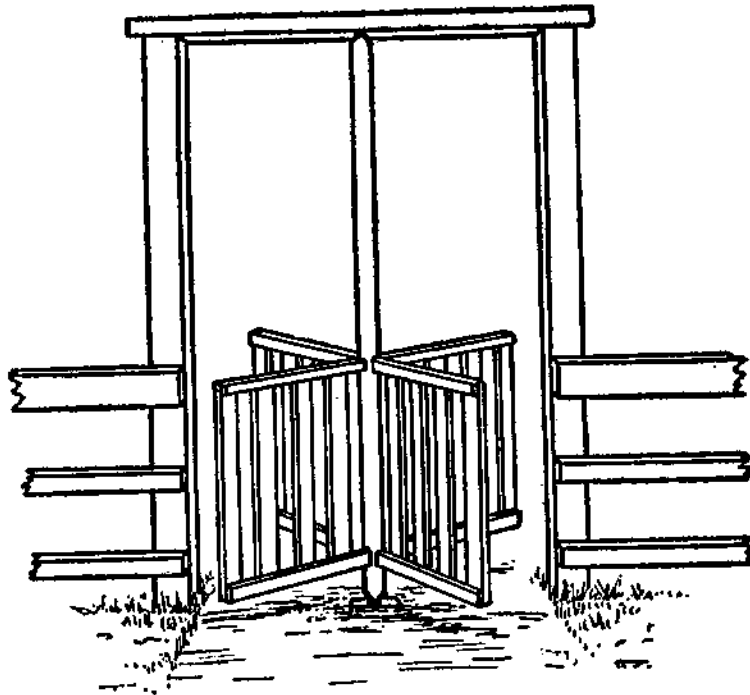


GATE SHUT AND OPEN

the bars. The upright at the latch side may be the same weight of stuff or slightly lighter, and fastened in the same way. Instead of nailing the bars to these uprights, bolts are used, one for each bar at each end. The lowest board is notched as shown, and the double brace used from the top of the latch post to the bottom of the hinge post. For the brace, 1 x 3 stuff is strong enough. They are joined near the bottom with a bolt, which engages with the notches when the gate is raised, as shown at the right.

## A TIME SAVER

To open and close gates that stock may be kept within bounds the year round is one thing which uses up a great deal of time, and makes no return. Every gate should be so made that it will fall into



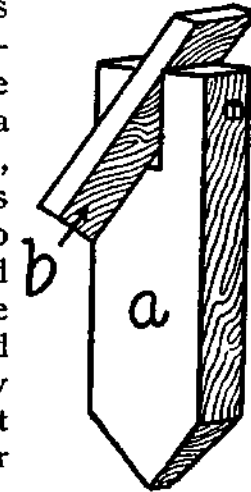
TURNSTILE GATE

place of its own weight and stay closed and open without hitch or bother. The cut illustrates a convenient thing that should be in larger use on farms. It is always open and always closed against stock. Put up and well painted, it will last for many years.

He who keeps company with great men is the last at the table and the first at any toil or danger.

## KEEP THE GATE OPEN

A simple and handy device which serves to hold the gate open is shown in the cut. To make it, procure a board, *a*, 1 x 4 x 12 inches and saw out a portion in the center, leaving a space on each side  $\frac{1}{2}$  inch wide, and bore holes for a bolt. Next get an 8-inch stick, *b*, and bore a hole through it 3 inches from the top. Bevel the top so that the gate will pass over it, and it will then fall back and hold the gate open. When one's hands and arms are full of things, as they often are on a farm, it is a great convenience to have a gate or door held open automatically. No simpler or more effective device for the purpose can be found. A similar device can be adapted to use as a latch to catch and keep a gate or door closed.

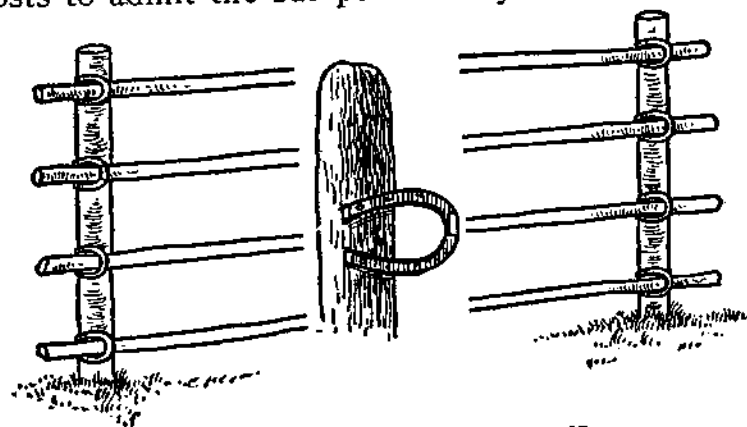


GATE CATCH

## GOOD BARS FOR THE FARM

It is an important matter to the farmer that his farm should be well equipped with good, substantial bars. Some farmers go to as much trouble in a year's time in moving a poor gate or bars back and forth as they drive in and out of fields, and in chasing cattle about, as making dozens of such bars as are represented here. Use round poles about  $2\frac{1}{2}$  or 3 inches in diameter. Set two good-sized posts one on either side of the barway, and to each one, an equal distance apart, nail large horseshoes, al-

lowing the round part to stand out far enough from posts to admit the bar poles easily.



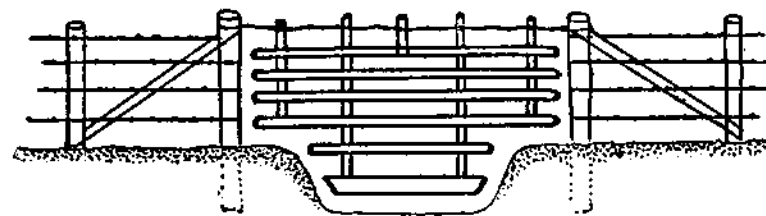
BAR WITH HORSESHOE CATCH

### DURABLE FLOATING FENCE

This is a cheap and easy way to make a good, strong cable on which to hang a water gate, when it becomes necessary to have a fence cross a stream: Set two good, large posts about 3 feet deep in the ground and about 6 feet from the banks of the stream. Get a piece of wire (barbed wire will do, but smooth wire makes a much better looking job), long enough to go from one post around the other and back again about six times, being careful to fasten each end securely at the proper height from the ground. Then get a strong piece of wood about 1 x 3 inches and about 4 feet long, stand as near the middle of the space between the two posts as possible, and place the stick between the two sets of wires. Turn around until all the wires are well twisted together, being careful not to twist too much.

On withdrawing the stick, the wires will only untwist two or three times. After the gate is hung, the stick may be again inserted in the same place

and several more twists given to take up the sag caused by the weight of the gate. Then fasten one end of the stick to the top of gate and it will be im-



SUSPENDED GATE

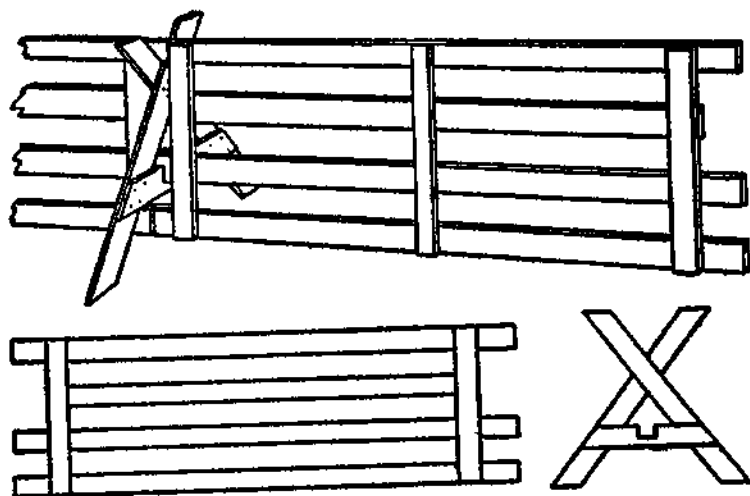
possible for the cable to untwist any more. This has been found to answer all the purposes of an expensive cable and looks and lasts just as well.

### FENCE ACROSS A STREAM

To construct a fence across a creek or small stream, set a post on each bank and brace well. If a tree happens to be near at the right place, so much the better. Then fasten wire securely on posts, leaving enough slack so a weight in the middle will draw the wires toward the bed of the stream, thus making it impossible for stock of any size to get through. A large stone makes a good weight. It can be blocked up to desired height and fastened in position with smooth wire.

### TEMPORARY SHEEP FENCE

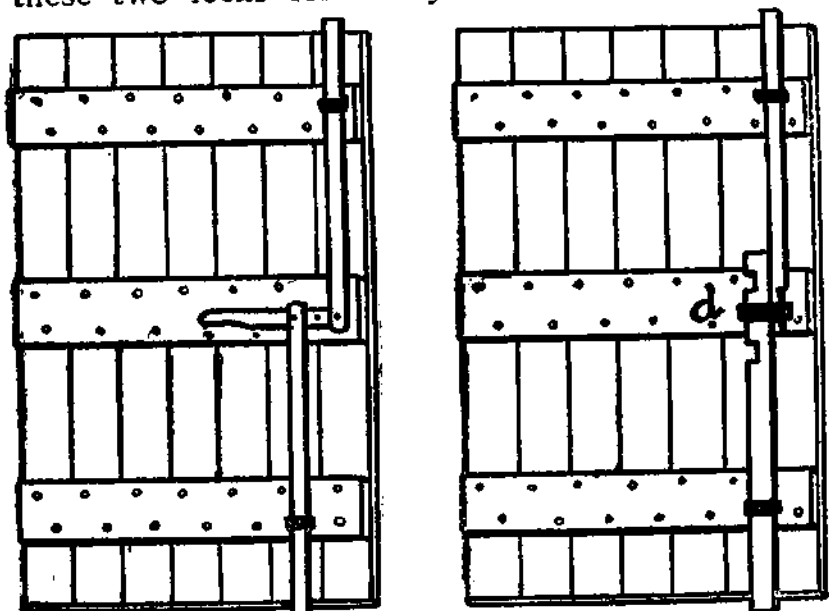
One of the best portable fences for use in soiling sheep is made in panels with supports, as shown on next page. Panels are 10 feet long, made of 4-inch board solidly nailed together. After this fence is once put up, sheep are not likely to overturn it. A fence 3½ feet high will turn most flocks.



MOVABLE FENCE AND PARTS

### FASTENING HEAVY DOORS

There is little difference in the effectiveness of these two locks for heavy doors. The left-hand



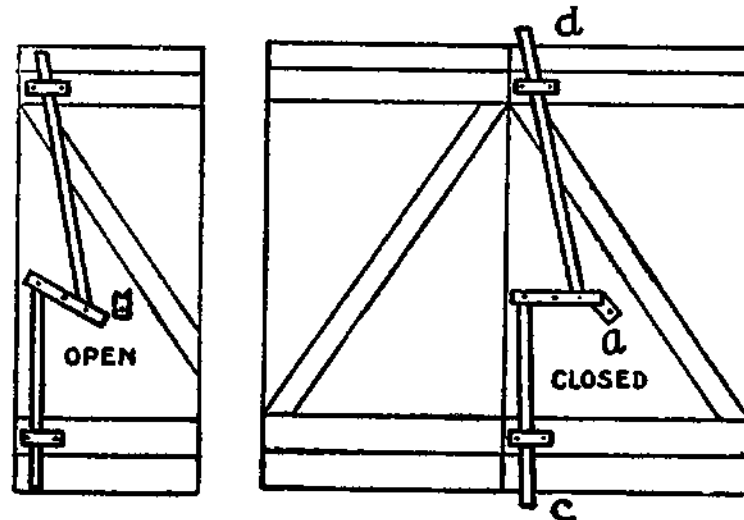
TWO BIG DOOR LOCKS

device is extremely quick and handy; the other very neat and substantial. The lock to the left has both bars pivoted to a lever handle, which is pivoted to the door midway between the ends of the arms. Moving the lever handle up moves both arms out of slots above and below the doors. The fastening may be also worked from the inside by cutting a slot through the door and setting a pin in one of the arms, so that it can be moved in the slot.

The right-hand fastening is worked by raising the lower arm so that the notch incloses the middle staple at *d*. Then the upper arm can be pulled down. Both arms stay firm and snug whether the door is shut or open.

### HOLD THE BARN DOORS SHUT

A latch that will hold double doors shut is shown in the cut. This is put on the inside of the door that is closed first. It is made of hardwood 4



LATCH FOR DOUBLE DOORS

inches wide and 1 inch thick. To open the door, turn the piece, *a*, to the right and pull down on the crosspiece which is fastened to the door by a bolt in the middle. This will raise the latch, *c*, and lower the latch, *d*, as shown in the cut to the right.

Open your doors to a fine day, but make yourself ready for a foul one.

Prosperity is the thing in the world we ought to trust the least.

### FASTENING THE STABLE DOOR

A handy stall door fastener is shown in Figure 1. It consists of a piece of oak or other hard wood 4 inches wide by  $\frac{7}{8}$  inch thick and 2 inches longer than the width of the door. It is fastened to the door by a  $\frac{3}{8}$ -inch bolt through the middle and it works like a button. Cleats, *b*, are sawed out and fastened to the door jamb on each side to hold the fastener in place. Another handy fastener that can be worked from either side of the door is shown in Figure 2.

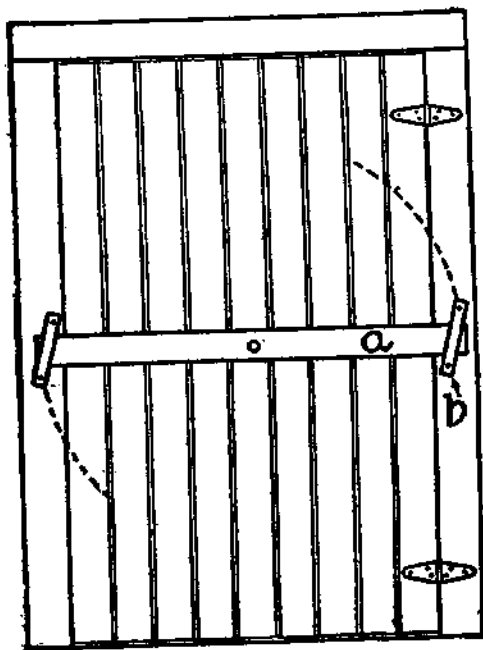


FIGURE 1—LONG FASTENER

There are three upright pieces, *a*, two of which are on the door and one on the door jamb or casings. Another piece, *b*, slides through these and holds the door shut. A pin, *c*, goes through the bolt and through the door to open or shut it from the opposite side. The bolt is kept shut by the spring, which can be made from a piece of hickory, or other tough hardwood, whittled down to the proper thickness. The spring feature is the chief advantage, and a very important one it is, of this excellent fastener. It is also a good point that the fastener works nicely from the opposite side of the door.

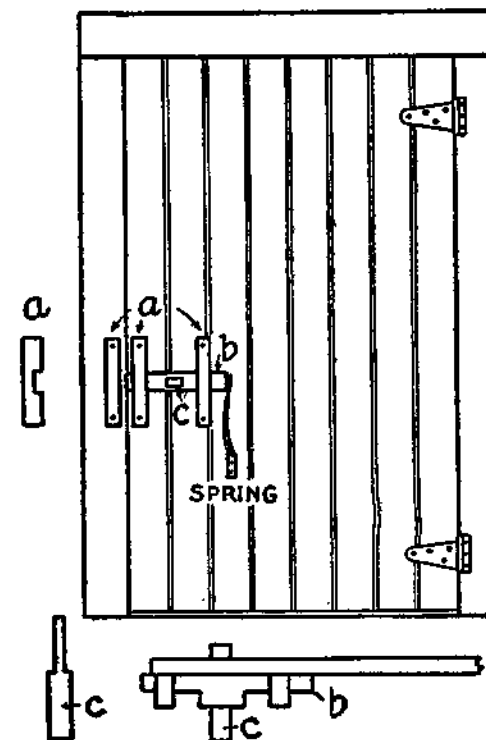


FIGURE 2—SPRING FASTENER

Sell cheap and you will sell as much as four others.

They must hunger in frost that will not work in heat.

'Tis easier to build two chimneys than to maintain one.

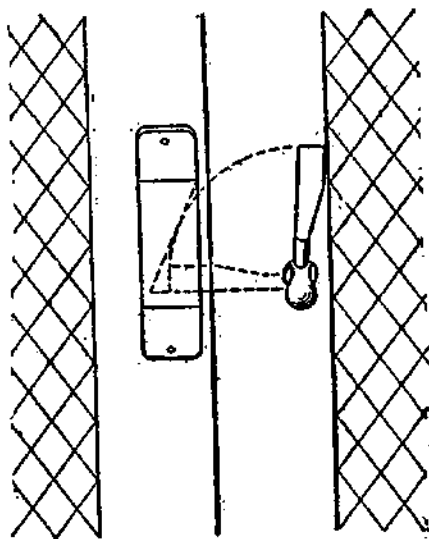


## HOMEMADE DOOR LATCH

This consists of three pieces of oak or other good hardwood, as shown in the drawing. For the handle use a piece 8 x 2 x 1 inches. Shape a flattish knob on one end 3 inches long. Work down the rest so as to pass through a 1-inch auger hole. Shape a knob on the other end by flattening the sides. The latch is made of a piece 5 x 1 x  $\frac{3}{8}$  inches. The catch is 8 x 2 x  $\frac{3}{4}$  inches. Bore a 1-inch hole for the handle 3 inches from the edge of the door. Push the handle through the hole and mark on it the thickness of the door; then bore in the handle a  $\frac{3}{8}$ -inch hole for the latch. Now assemble the parts according to the finished figure, which shows the latch thrown back. A little peg may be used to keep the latch from falling down when the door is open. By taking pains to shape and finish this latch nicely it will look well enough to please the artistic eye of the most fastidious.



DETAILS OF LATCH



LATCH IN PLACE



## IMPORTANT POINTS IN HOUSE BUILDING



THE following points in building a house are considered of the greatest importance by a well-known architect: Carefully watch that the foundation walls are substantially laid, and accurately leveled on their upper surfaces, so that the doors shall not strike the floor or carpets in opening, nor the tables, chairs, or other furniture be obliged to stand on three legs.

The framework, when raised, should be plumb, so that all on or in the building can be cut square, and applied without tedious fitting. The siding should be thoroughly seasoned in the open air before using, and carefully applied with close joints, and well nailed. The edges of all water tables, corner boards, and window frames should be painted before setting.

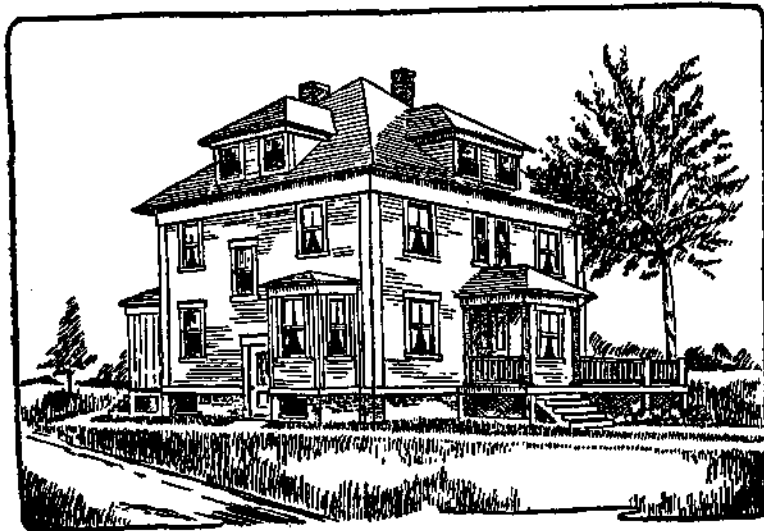
The shingles should be carefully laid, breaking their joints at one-third of their width and double nailed. The flooring should be dry, close laid, and nailed with two nails to each beam. The partitions should be set with studding of selected width, and their angles or corners should be anchored firmly together to prevent the walls from cracking in those parts when finished. The chimneys should be carefully constructed, all points between the brickwork should be well filled with mortar to prevent sparks from passing through to the framework.

All mortar for plastering should be properly mixed, and allowed sufficient time (at least a week) for the thorough slacking of the lime, and a complete permeation of the caustic properties. Thin coats of plastering are better than heavy ones. A mortar that does not crack in setting or drying is sure to be good.

The interior wood finish should not be begun until the plastering is completely dried out, and all loose mortar is removed from the building. All woodwork usually painted should be primed as soon as in position.

### A VERY CONVENIENT HOUSE

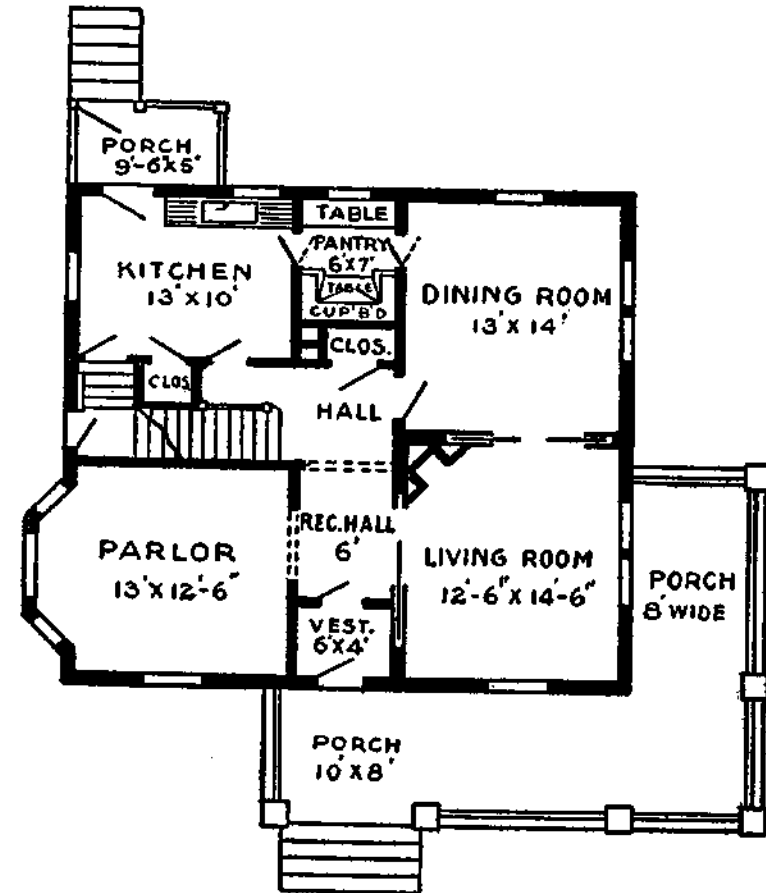
The accompanying picture and plans show the outside and interior arrangements of a very convenient home built the past year by one of our



AN ATTRACTIVE HOME

agricultural editors. It is 34 feet wide by 30½ feet deep, with a 7-foot cellar underneath. The house

contains 10 rooms, including two in the attic, besides a storeroom in addition to those shown. All the rooms are of good size and have two or more large windows, which make them light and sunny and supply plenty of good air.

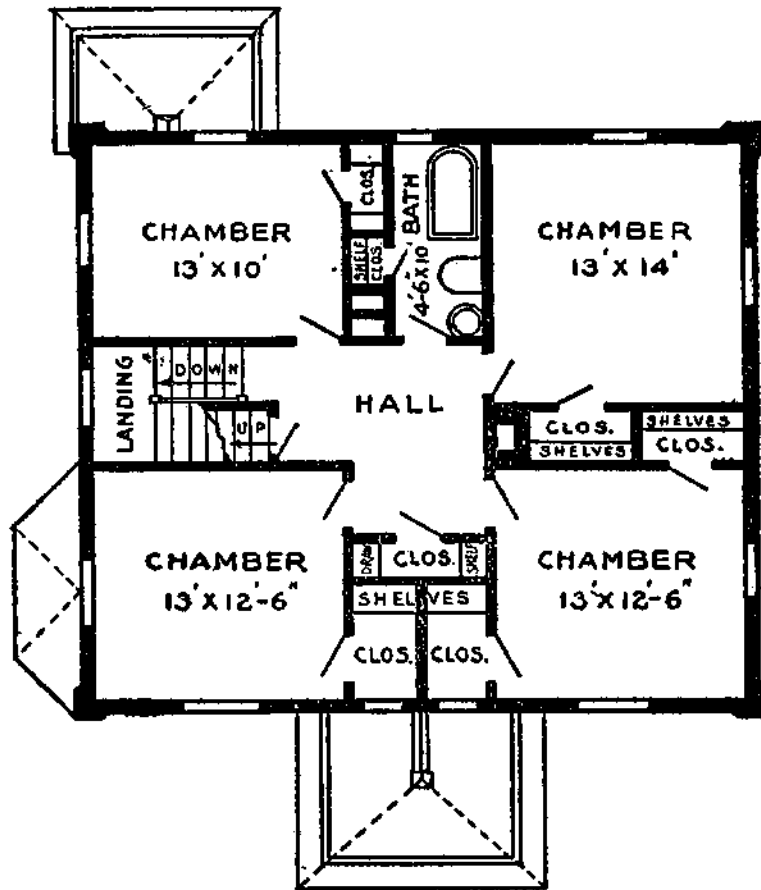


PLAN OF FIRST FLOOR

Economy of construction, as well as of doing the work, was kept in mind in the planning. The location of the stairs is somewhat unusual in a house of this sort, but is such that only one light

is necessary from first to second floor. There are plenty of large closets on the second floor, which are greatly appreciated.

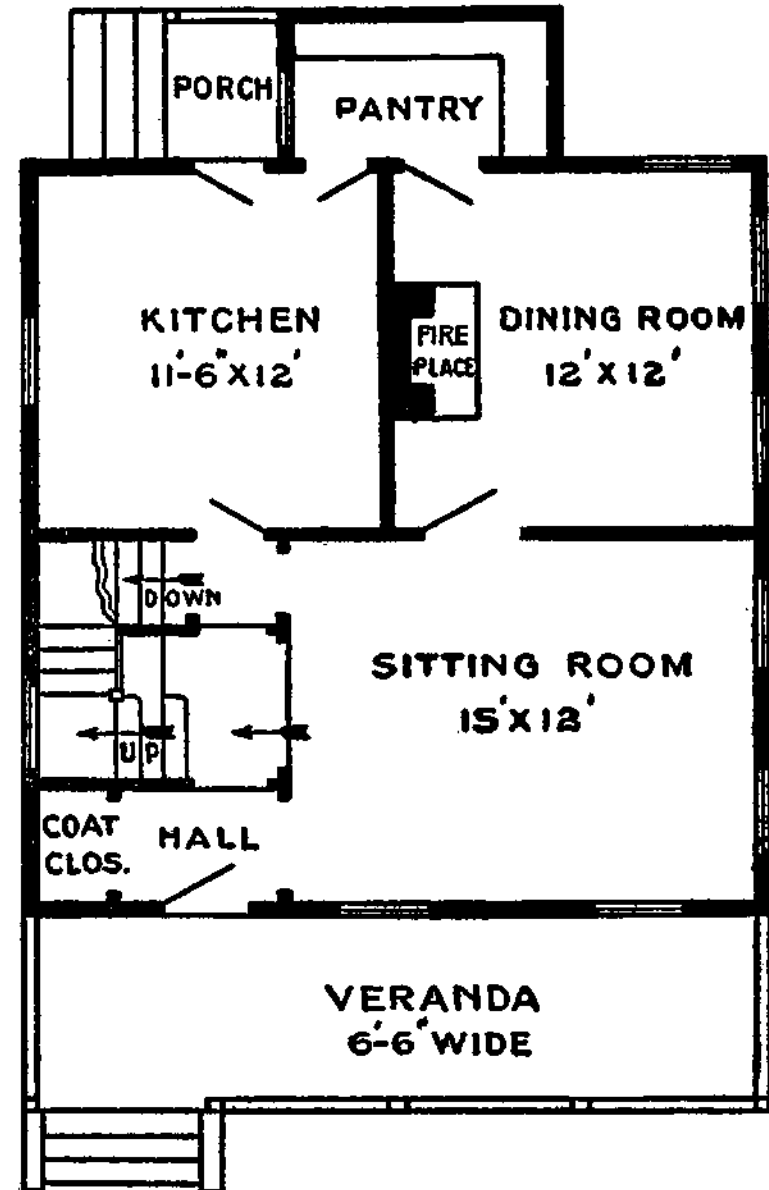
The porch is not roofed except over the door, but



PLAN OF SECOND FLOOR

an awning, which is taken down in the fall, makes it cool and shady in summer, and allows the sunshine to reach the living room in winter. The first story is 9 feet from floor to ceiling, the second 8 feet and the third 7 feet 6 inches. The house

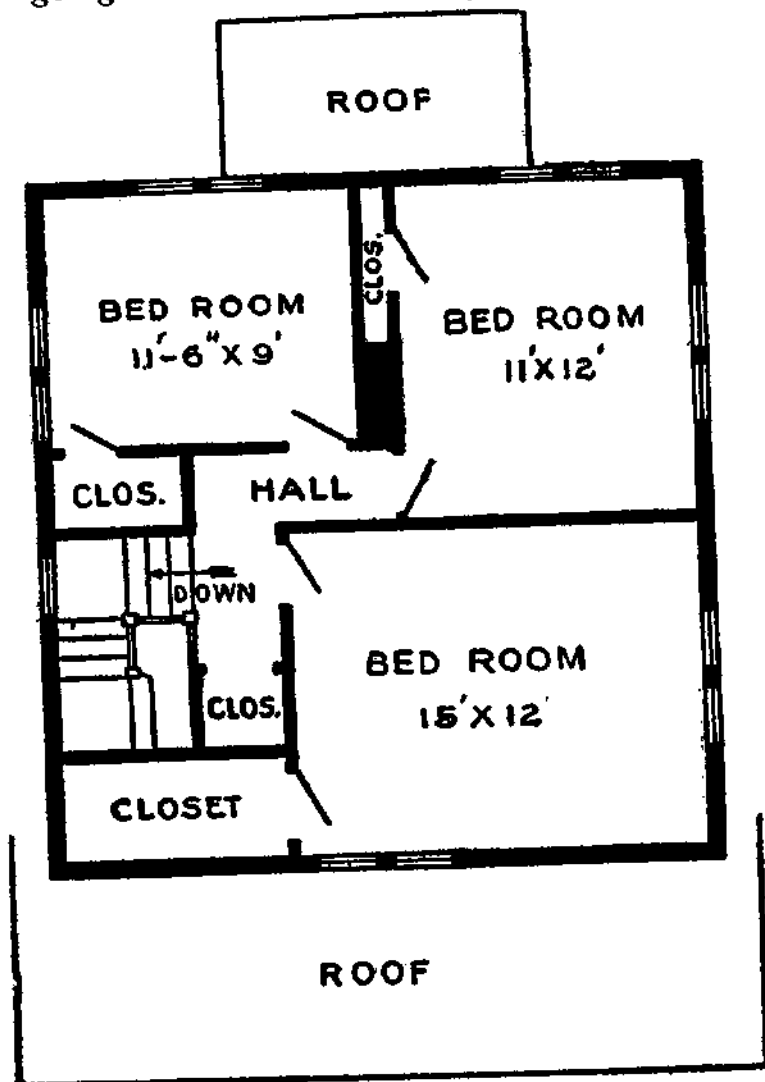
is piped with gas and wired for electricity, provided with the best quality of sanitary plumbing



FIRST FLOOR COTTAGE PLAN

and heated with hot air furnace. A similar house can be built for about \$4,000, more or less, according to finish and locality. Occupancy proves it to be a model of convenience.

If a bigger kitchen is desired, it can be obtained by going back farther. Many would prefer a

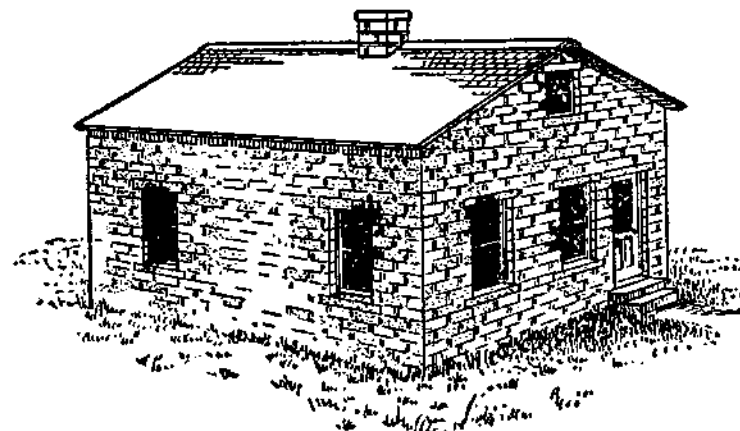


SECOND FLOOR COTTAGE PLAN

wider bathroom. A foot taken from the back chamber on the right would greatly improve the bathroom and still leave a large chamber. If desired, a large roofed piazza can be added.

## BUILDING A BLOCK HOUSE

A Kansas farmer needed a house on his farm, but had very little money. He found that only a little was needed for a cement block house. He ordered a cement block machine and bought 12 boards 10 inches wide and 12 feet long, which were cut in seven pieces of equal length. Two cleats were

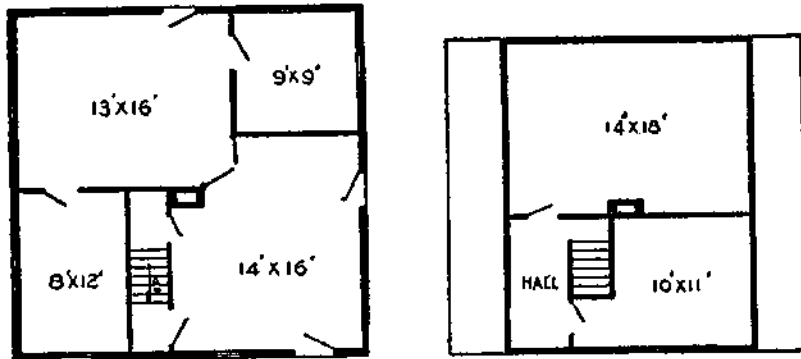


\$400 CEMENT BLOCK HOUSE

nailed on each, about 3 inches from the ends. These were for pallets and cost about 7½ cents each. The cement blocks were 8 x 9 x 18. As the block machine had no attachments, some contrivances were made for making half stone, three-quarter and others.

For caps and sills for doors and windows 9-inch boards were taken, using three for each mold, and

two holes 2 inches from the edges and 3 or 4 inches from the ends of two of them were bored. Then the farmer made cement blocks for the ends 9 x 8 inches, laid the other board on the ground, placed one of the others on each side of it edgewise, put in the end blocks, and through the holes put long bolts and bolted it tight together. Then it was ready to fill with concrete. These boards were as long as were needed to make the caps or sills. A sprinkler, sand shovel, plasterer's trowel, and a wire sieve of  $\frac{1}{4}$ -inch mesh were obtained.



FIRST AND SECOND FLOOR PLANS

The sand cost nothing except hauling. The machine was set up near a spring. A box something like a wagon bed with both ends out was made of boards, the block machine placed in one end and the pile of sand at one side. Three shovels of sand and one of cement were placed in a tub and mixed thoroughly. Then a boy took the sprinkler and sprinkled it while another mixed, until it was dampened evenly all through. Then they spread 35 shovels of sand in the mixing box and shook one sack of cement over it, which made a five-to-one mixture. This was thoroughly mixed

by shoveling and sprinkling until it was good and damp, but not wet. This quantity made ten blocks.

A pallet was placed on the open machine, the machine closed, and some of the richer mixture of concrete placed on the face about 1 inch thick. The mold was then filled with the five-to-one mixture, while one of the boys tamped it, put in the core, and smoothed off the top with a trowel. The core was then carefully lifted out, the machine opened, and the pallet with the stone on it placed on a level piece of ground.

In three or four hours the blocks were ready to sprinkle. When 30 hours old they were placed on end and the pallets used for more stone. After standing for two days, during which time they were sprinkled frequently to keep them damp, they were dumped in the creek, where they were left until ready for use. The foundations were made by first putting into a trench about 6 inches of broken rock, then 4 inches of concrete.

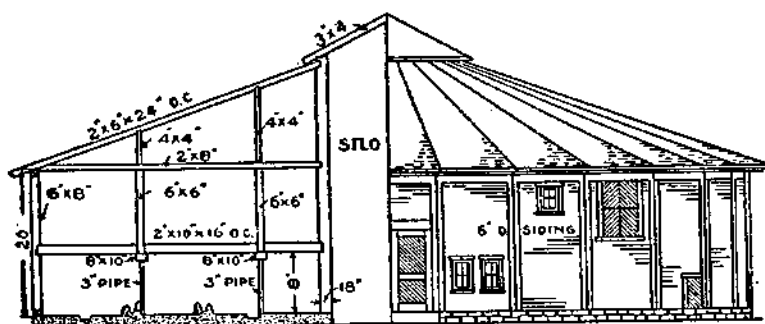
The house is 26 feet square, the walls 12 feet high, with gables north and south. The picture of the house and arrangement of the two floors are shown in the illustrations. We used 12,400 pounds of cement, which cost 60c per 100, or \$74.40. Doors and windows were brought at a cost of \$33.75. Chimney, plastering and lumber for floors, roof, partitions and finishing, all of the best, cost \$240. The hardware was \$30, making the total cost of house \$378.15, not counting cement machine or labor, all of which was done by the family.

Art imitates nature, and necessity is the mother of invention.—Richard Franck.

Consider the end.—Chilo.

## A PRACTICAL ROUND BARN

There is no economy in building a round barn, that is, strictly round. The barn here illustrated has 26 sides nearly 12 feet long, making a barn 94 feet in diameter. The sills, plates and roof in a strictly round barn are very expensive, and the work will not last as well as when built as shown. The floor space of the first floor is nearly the same as if round, and the hay loft is very little smaller. If the building is round, the walls should be lathed

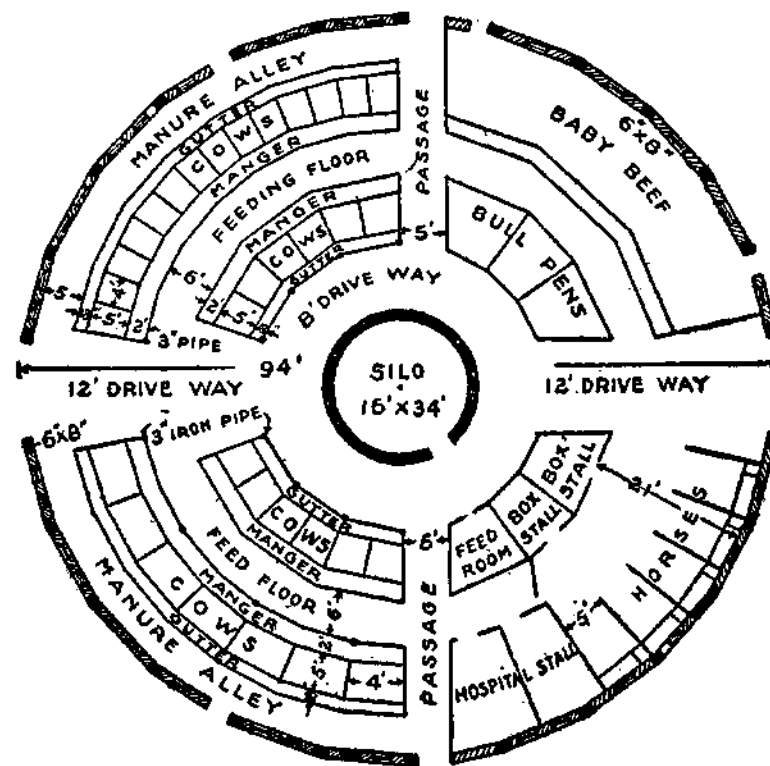


CROSS-SECTION OF BARN

with metal lath, over rough boxing, and plastered with two coats of portland cement. In fact, this finish is to be preferred in building any shaped barn, as it requires no paint and practically no repairs.

The floor plan of the barn shown is self-explanatory. It has stalls for 40 milch cows, three bull pens, two hospital stalls, pen for baby beef that will accommodate about  $2\frac{1}{2}$  cars of calves, stalls for seven horses, including the two box stalls, and the feeding room and silo. The silo is 16 x 34 feet, will hold about 140 tons of silage, and requires about ten acres of average corn to fill.

The hay loft has 166,500 cubic feet of space, and deducting the silo and bins for ground feed will hold 300 tons of loose hay. The ground feed is stored in hopper-shaped bins above the feed room, and drawn down through small spouts as wanted. The hay is handled with hay forks, and to locate



FIRST FLOOR PLAN

the trolleys as near the roof as possible, trap doors are left in the loft floor, and the hay hoisted from the driveways. A circle trolley may be installed, or two straight ones. Several large hay doors are also built in the outside walls above the loft floor. The silo, the floors of the cow stalls, including

the gutters and mangers, also the 8-foot driveway around the silo, are of cement, and, while it is intended to install litter and feed carriers, it is also intended to drive around the entire barn, or the feed floor with a cart if desired. The interior arrangement of first floor may, of course, be changed in several ways, and the cows faced in the opposite direction, etc., or stalls and other equipment arranged for different stock.

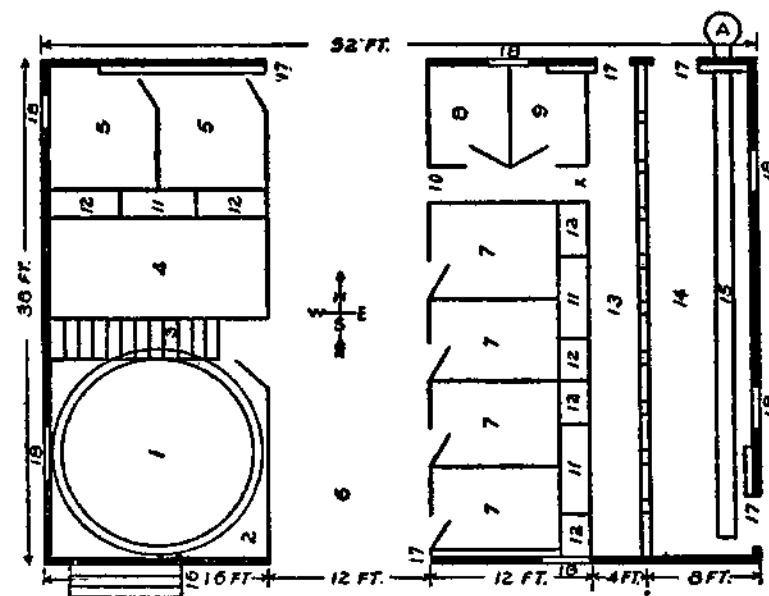
The barn, as shown, has about the same floor space as a barn would have 36 feet wide and 180 feet long. The ventilation is always much better in the round barn, the work of caring for and feeding may be accomplished with less labor, there are never any drafts on the stock, the building may be built for less money, and is much stronger. As shown, the barn has a stone foundation, the roof is covered with asbestos roofing felt, and the walls covered with 6-inch drop siding. Everything is of the best, and all exposed woodwork painted two coats. This building would cost about \$4700 without the cow stanchions. Where home labor is used, and the lumber can be secured for less than \$30 per thousand, the barn may, of course, be erected for less.

### A WELL-ARRANGED BARN

This Kentucky barn has a frame of oak, 6 x 6 inches. Center posts 23 feet 9 inches; shed posts 16 feet tall; studding and braces 2 x 6-inch poplar; joists 2 x 10-inch poplar, oak and pine. The sheeting is of poplar, beech and ash. The bevel siding is select poplar. Cornice and base, white pine. All doors are two thicknesses, front is dressed cypress and the back dressed white pine. The

lower windows are 10 x 12-inch, 12 lights and upper ones inside the building. The joists are set 20 inches from center to center. The loft is 8½ feet from lower floors.

The floor plan shows the arrangement as follows: Number 1, icehouse, 18 feet deep, walled up with stone; 2, carriage house, 16 x 18 feet; 3, stairs, leading to lumber room over carriage room; 4, corn



GROUND PLAN OF A KENTUCKY BARN

crib, 8 x 16 feet, over which are the grain bins for wheat and oats. These bins have chutes running down into the corn crib, from which grain is filled into sacks. Numbers 5, 5, are box stalls, 8 x 12 feet; 6, driveway, 12 x 38 feet; 7, 7, 7, 7, box stalls, 6½ x 12 feet; 8, harness room, 6 x 8 feet; 9, feed mixing room, 6 x 8 feet, with spouts running from cutting box and bran bins overhead; 10, alleyway running from driveway to feed alley; 11, 11, 11, hay

chutes, with openings near the bottom, 1 x 2 feet. These openings are directly over the feed boxes and any hay that falls while horses are feeding goes into the boxes and none is wasted. Number 12, feed boxes, 1 x 2 x 2 feet; 13, feeding alley, 4 x 38 feet.

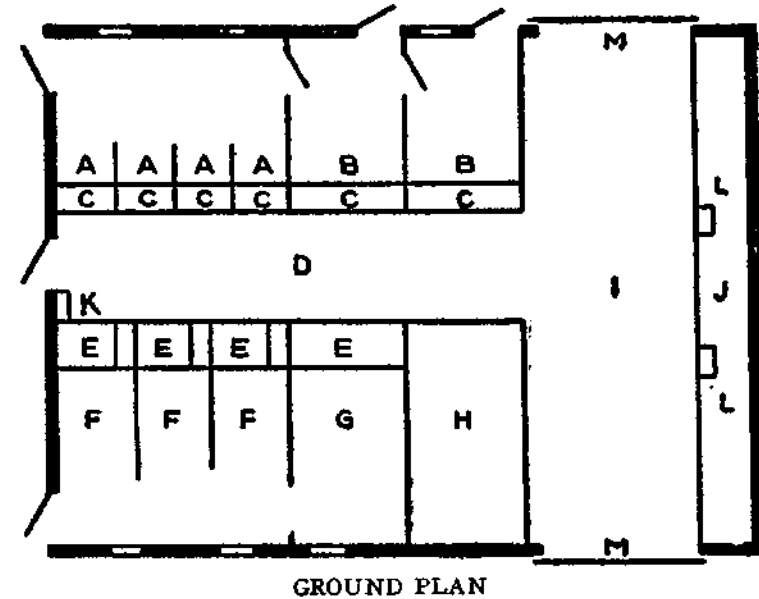
Overhead at X is an opening from the hay loft where alfalfa, clover, cowpeas and hay are kept for the cows; 14, cow shed, 8 x 38 feet. Cows are fastened with stanchions and fed out of boxes on alley floor. The cow shed has concrete floor, with a fall of 2 inches from stanchion to Number 15, the drain basin, which is 1 foot 2 inches wide and 1 foot deep at A, where it runs into a basin made of concrete, 6 x 6 feet and 2 feet deep; 16, driveway into carriage room; 17, openings in which siding doors hang when open; 18, windows.

The roof is of tin, standing seams, with Yankee gutters made on the lower edge of the roof. An opening 10 x 10 feet in the center of the driveway loft is allowed for hay and other feed taken up by an unloader that runs on a track in comb of roof. The barn will cost about \$1500—more or less, according to cost of building material where it is erected.

### A HANDY SMALL BARN

This barn is arranged to meet the needs of a small farm. It can be built in most localities at a cost not to exceed \$500, and if a farmer has his own timber, at even less cost. The outside dimensions are 36 x 48 feet, and it is 16 feet to the eaves, with a curb roof. The stables should be about 8 feet high, which allows plenty of loft room above for hay.

In the floor plan the cow stalls, A, can be made of any width desired,  $3\frac{1}{2}$  feet being best for general purposes. At B are two large box stalls for cows with young calves. The mangers, C, are 18 inches wide, with a rack for hay or fodder above. At D is the feed room and alley, which is 8 feet wide. At E are the mangers for the horses, with



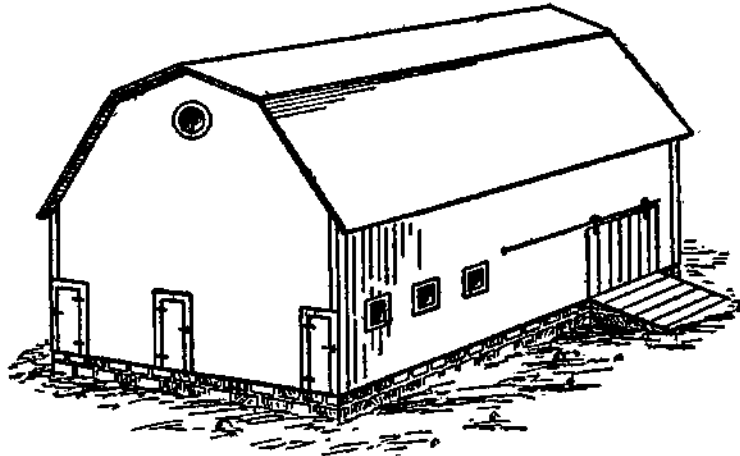
a feed box at the right side. At F are three horse stalls 4 feet wide, in which horses can be tied. At G is a large box stall for mares and colts.

At H is provided the granary, which can be subdivided into bins as necessary. The portion I is the driveway, which affords ample storage space for tools, wagons, etc., and is used as a driveway when hay is being elevated into the loft above.

There is a large corn crib, J, at the end, which can be filled from the outside and emptied from the inside. It is narrow and so arranged that the



corn will dry out quickly. Chutes from this bin should be provided at L. A ladder to the hay loft at K is a convenience which should not be omitted.



VIEW OF COMPLETED BARN

## THE FARMER'S ICEHOUSE

In a properly constructed icehouse, and when the ice is properly packed and cared for, no waste should take place from the inside of the pile of ice. The melting from the sides, bottom and top is caused by insufficient insulation. The waste from the bottom is generally the greatest. The amount of ice melted in the bottom of the icehouse varies from 1 to 6 feet during the year, depending upon the construction of the floor. If the icehouse is provided with an airtight floor, with the ice laid on at least 18 inches of dry sawdust, the bottom waste rarely exceeds 12 inches during the year; on the other hand, if the ice is piled in the icehouse on the bare ground without any insulation under it, or any provision made for drainage, the meltage fre-

quently is 6 feet. The side and top meltage is not so great, but it frequently ranges from 1 to 3 feet, depending upon the insulation.

## Location and Building

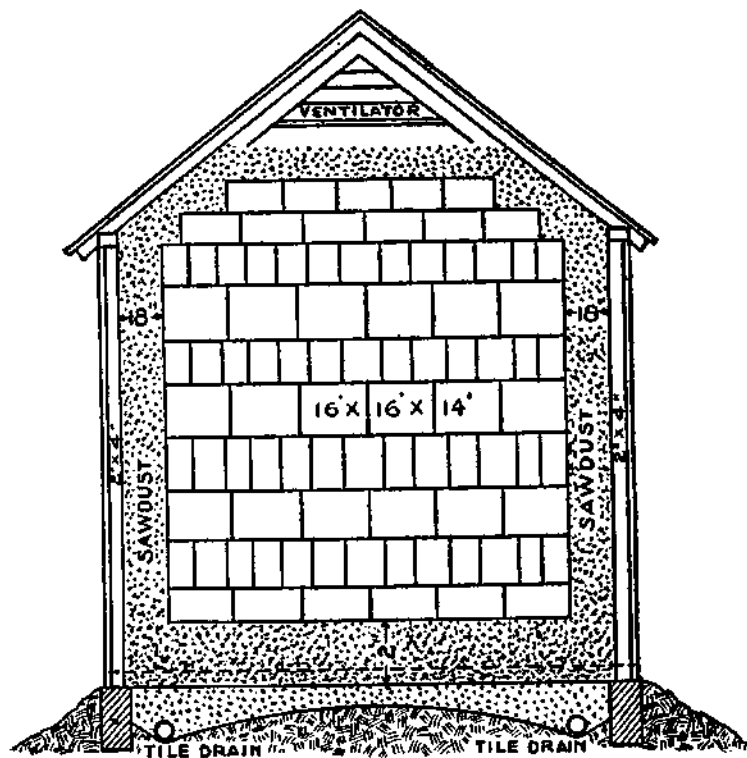
The location should be where the ice can be removed and delivered with the least amount of labor; however, it is very important that the icehouse should be located in the coolest place, in as dry a place as possible, and always above ground. The lowest layer of ice should always be at least 6 inches above the outside level of ground.

The size of the building must be determined by the amount of ice used during the year. For instance, a dairy farm upon which 35 cows are kept, and from which the milk is sold, needs an icehouse 16 x 16 and 14 feet high. If the cream is to be sold and skim milk fed to the calves, immediately from the separator, an icehouse 14 x 14 and 12 feet high is of sufficient size. In both cases we make allowance for the use of 25 pounds of ice per day during the summer months for household purposes. For a man who keeps about 20 cows and sells the milk, an icehouse 14 x 14 and 12 feet high is of sufficient size; however, in no case should an icehouse be smaller than 12 x 12 and 10 feet high, because the outside surface is too great, compared with the volume, and, therefore, too much ice is wasted in proportion to the amount used.

The building should be as near the shape of a cube as possible, for the cube contains the greatest amount of volume with the least amount of surface exposed other than circular forms. It is not always practical to build as high as we build square,

owing to the amount of labor and the inconvenience of storing the ice; therefore, the dimensions given are really the most practical.

If the icehouse is not built upon a sandy surface and where rapid drainage is natural, it is



CROSS-SECTION OF ICEHOUSE

necessary to cut a space to a depth of 12 to 18 inches, where the icehouse is to be located, lay a tile drain to drain this, and fill it with sand or finely crushed stone. Put a 6-inch foundation of concrete of the size you wish to build your icehouse in this pit, and fill around the outside.

### Framing the Icehouse

The framework is made by laying 2 x 4-inch sill on the concrete foundation; fasten this to the foundation by cementing a few bolts into the concrete and allowing them to extend through the sill; 2 x 4 studding are then placed upon the sill, 16 inches apart from center to center. The rafters for the roof are likewise made of 2 x 4's, placed the same distance apart as the studding, but the purlin plate upon the studding should be at least 6 inches wide. The outside of studding may be boarded either with common sheeting and paper, upon which poplar siding is nailed, or with patent siding or ship-lap siding, the latter being the cheapest and requiring only a single thickness of board.

The roof should be made with not less than one-half to one-third pitch, and preferably covered with shingles, for shingles are better insulators than either slate or metal. Paper may sometimes be used to good advantage. A cupola or flue should be built upon the roof to allow for the removal of the warm air from the top of the ice. A ventilator may be placed in the gable end,

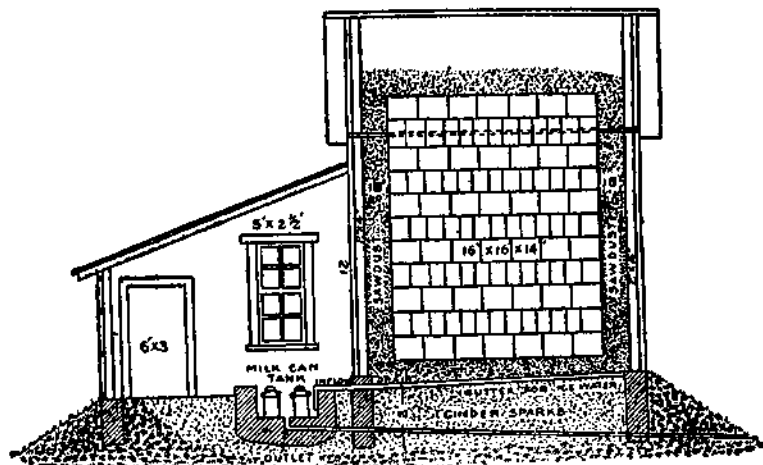
A continuous door should be cut in one end to allow the ice to be put in. This door may extend from the gable down to within 5 feet of the bottom.

Before putting in the ice place from 18 inches to 2 feet of sawdust or dry peat upon the floor. The ice should be harvested in regular shape, oblong, rather than square, and not less than 18 inches in width and 30 inches in length.

### Ice and Milk Houses Combined

The side elevation of an icehouse with milkhouse attached is presented in the drawing. It shows the

advantage of utilizing the water from the icehouse for cooling the milk. No ice needs to be removed from the icehouse. It operates automatically. If the weather is warm the ice melts more rapidly and keeps water in the tank at the required temperature.



A GOOD COLD COMBINATION

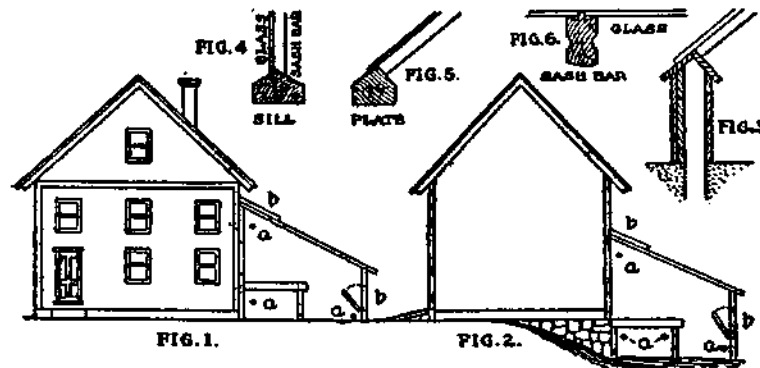
### SMALL GREENHOUSES

The farmer who would make his crops of vegetables most profitable, or the small gardener who would have an early supply of early vegetables for home use or market must employ some kind of glass structures to hasten these crops. The hot-bed or cold frame have been much in use in the past, but the cost of sash, shutters and mats is nearly as much as the materials needed for a permanent structure, while the labor of caring for cold frames or hotbeds is often much more than that of the small greenhouse. In the latter one may work with comfort no matter what the weather may be outside. It requires much more skill to run hotbeds successfully.

Small greenhouses may be built against the south side of the house or stable, Figures 1 and 2, or they may be built entirely away from other buildings, but the shelter of larger buildings on the north or west will be found of great advantage. If one has a basement to the house or stable, a lean-to house may be built, and heat from the open cellar in a large measure will heat the greenhouse in the mild weather of fall and spring.

### Material for Construction

A cheap and efficient house may be made by setting chestnut or cedar posts in the ground, covering the sides with lining boards, then two thicknesses of tarred building paper and sheathing



DETAILS FOR SMALL GREENHOUSES

outside, Figure 3. Cement, stone or brick will be cheaper in the end. The durability of glass structures will depend much upon the form of the materials. Clear cypress is now more used than any other material. Sills should be of the form shown in Figure 4. Plates may be made of plank as in

Figure 3, or as in Figure 5. Sash bars should have grooves along the sides to catch the drip from the glass, as in Figure 6.

The glass for ordinary work may be No. 2 double thick, large sizes, 16 x 20 inches or 20 x 24 inches, being much used. Smaller sizes will be cheaper in price, but more sash bars will be needed, and they cut off much of the sunlight. The glass should be put in with putty, made with about one-third white lead in it, and firmly tacked with triangular zinc tacks of large size, or the double-pointed tacks, which are so bent as to prevent the glass from slipping down.

### Set Glass in Warm Weather

Glazing should be done during the summer or early fall, as putty will soon become loose if frozen before well hardened.

In building there should be no mortises, but all joints be made by toeing in with long, slender nails. All woodwork should be thoroughly painted before fitting, and all joints filled with white lead paint. After all is done the frame should be painted before the glass is put in.

The most important and expensive feature of the small greenhouse is the heating. If one has a hot water or steam heater in the house, to which the glass house is attached, it will be a very simple matter to carry pipes through, as at *a, a*, Figures 1 and 2. Hot air also may be let into such houses, or a small kerosene heater in very cold weather may be used, if the house is built opening into the cellar.

Ventilators must be located as shown in Figures 1 and 2, at *b, b*. Very small structures may be

run without much heat if opening into cellars or other heated rooms by having shutters or curtains to draw down at night and in very cold, cloudy weather.

### Covering with Hotbed Sash

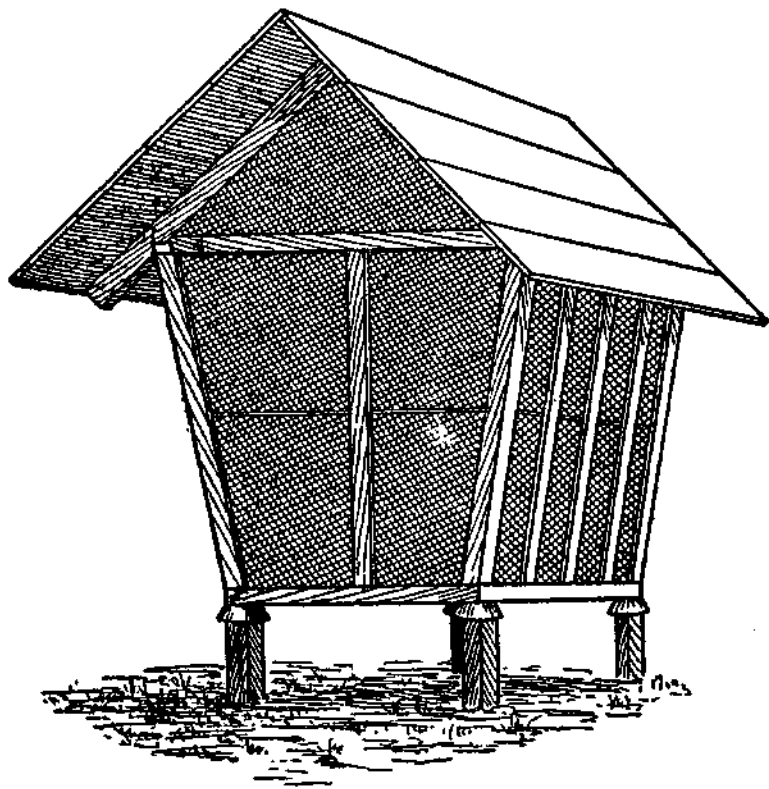
Houses of small size may be made by building a frame upon which hotbed sash may be screwed. If one has the sash this is a cheap way of building, and such a house has the advantage that the sash may be entirely removed during the summer, but it is very difficult to make a close house with such sash.

The woodwork of greenhouses and hotbed sash should have a coat of thin linseed oil paint every second year. Much of the success to be obtained from any glass structure will depend upon the skill of the operator, and the thermometer, both outside and in, must be watched very closely. The temperature should be maintained as nearly as possible like that in the open air under which the plants grown thrive the best.

### WIRE FENCE CORN CRIB

In the drawing is shown a handy, inexpensive corn crib, which possesses several advantages not possessed by the ordinary slat corn crib. It is made on 4 x 4-inch posts, with pans at their tops, to prevent rats from climbing in. The sills are 4 x 4-inch, the scantlings 2 x 4, and 2 feet apart. The fencing is nailed to these on all sides, and the door frame is similarly covered. The roof is made wide, so as to shed all possible water. The height, length

and width may suit the farmer's convenience. A convenient width is about 5 feet at the floor, widening to 7 feet at the eaves. Owing to the very open



THE CORN CRIB

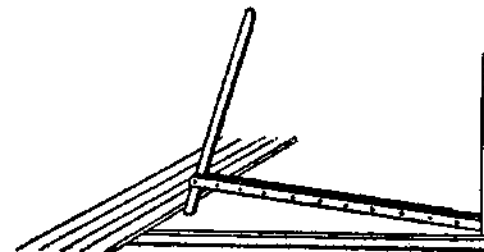
nature of this crib, corn dries more quickly than in a slat crib, and as there is less chance for water to lodge in the cracks, the crib will be more durable than if built entirely of wood.

---

Want of cure does us more damage than want of knowledge.

## HOW TO LAY A FLOOR

To lay a floor or board ceiling just right, and do the work fast, use a good lever, as in the illustration, taking for the supports two 1 x 4-inch pieces as long as the width of the room. The upright arm is 4 feet long with a hole 4 inches from the lower end and through which it is pinned loosely between the ends of the supports. With a little practice, a good carpenter's job can be done on floor or ceiling.



FLOORING LEVER

## AN INEXPENSIVE VERANDA

A vine-covered veranda is a great comfort, but in many cases the expense seems greater than the owner of the plain little farmhouse feels able to stand. A farmer in Arkansas wanted one, and he set to work in this fashion. First he went to the woods and got a load of straight poles about 1½ inches in diameter and from 8 to 12 feet long. He next procured a number of nice, smooth boards for the flooring of the veranda, making it about 6 feet wide and 10 feet long and strengthening it with the necessary timbers. He securely nailed the poles about 8 inches apart around the flooring to form an inclosure, leaving an opening in front about 5 feet wide.

The poles in front were 7 feet from the floor to the roof and 12 feet at the house. About midway of their height the poles were straightened by a row

of poles nailed horizontally and another row was placed at the top. To make all secure against rain, the slanting roof poles were next carefully covered with overlapping rows of bark. All this required but small outlay of cash and even less of work. It was then ready for the vines.

Being in haste for immediate results, the builder planted some roots of the hard native woodbine, which will soon cover any space with its rapid growth. It is an easy matter to sow seed of the morning glory, hardy annual gourd, or any one of several hardy climbers and the result will soon be a mass of shade and lovely blossoms besides, all of which makes the summer evenings pass far more pleasantly.

### CONCRETE ON THE FARM

The progressive farmer must not overlook the economic value of portland cement concrete. Today is the age of concrete. It is crowding wood and steel into the background, and bids fair to become the most universal of building materials. Concrete is extensively used by the largest landholders, and can be used by the men of more moderate means to equal advantage. It is to be recommended for general use by reason of its durability, sanitary qualities and moderate cost. Molded solid, it has no joints nor seams to afford a lodging for dirt and foster the growth of noxious fungi; it can be swept, washed, scrubbed and scalded, without injury to its texture. Further, it does not possess the disagreeable quality of absorbing gases and odors. Add to these qualities, coolness in summer, warmth in winter and we have one

of the most logical building materials in present-day use.

Concrete is not expensive when compared with other materials of construction, such as stone, brick and wood. To be sure, the initial cost of wood is less than that of concrete, but when we consider the life and quality of the finished product, concrete is easily cheaper than wood.

Portland cement of the most approved brands costs about \$1.60 per barrel,  $1\frac{1}{4}$  barrels of cement being required for each cubic yard of concrete. Sand and gravel may be had from the farm or bought nearby at 10 cents a load. Add the cost of the forms and the labor of mixing and laying the concrete, which should be done at an expense not exceeding 75 cents per yard, and we have a total expense ranging from \$2.75 to \$3 per cubic yard, but under very favorable circumstances the cost may be reduced close to \$2. Experience both in practical work and in the laboratory has proved beyond a doubt that the best brands of cement, as in all other goods, are the cheapest in the end, and should be insisted upon by all prospective purchasers. Atlas, Alpha, Saylor's, Edison and Giant cements are among the leading brands. The sand should be clean, coarse and sharp and free from all foreign matter that would in any way tend to weaken the concrete. Broken stone with sand and cement makes an ideal mixture, but it is objected to on account of the cost of the broken stone. Gravel may be substituted for the stone, however, with excellent results. The gravel should be washed and cleaned, and, if very coarse, passed through a screen. The gravel should range from  $\frac{1}{4}$  inch to  $2\frac{1}{2}$  inches in diameter, but should not exceed  $2\frac{1}{2}$

inches and to obtain the very best results the major portion should be between the limits of 1 and 1½ inches.

### MIXING THE CEMENT

In mixing concrete for general use the following proportions are perhaps the best: One barrel cement to 3 barrels sand and 5 barrels gravel. In this mixture the spaces between the stones are entirely filled and when hardened the concrete virtually becomes a solid monolith.

To secure the best results mix the concrete as follows: Have the gravel washed and in readiness, usually on a platform of planking or boards, to permit easy shoveling and insure against waste. Add enough water to the cement and sand, which have been thoroughly mixed in a mortar bed, to make a thin mortar, not too thin, however, to permit easy shoveling. Spread the mortar on the gravel and thoroughly mix by turning with shovels. Then, without delay, shovel the batch of concrete into the forms or spread it on the floors as the case may be, being careful not to exceed layers of 8 inches at each filling. Each layer must be tamped and rammed till water flushes to the top.

Proceed in this manner till the forms are filled. In hot weather damp cloths or boards should be placed over the top of the concrete to keep it from checking after the final layer has been placed in the forms. The forms must necessarily be water tight and the concrete worked back from the boards with a spade, so the softer material may flow to the outside and insure a smooth surface. If this last is not done holes will surely result and the work will be disappointing. Let the concrete rest four to six days before removing the planking, concrete

being somewhat brittle until thoroughly hardened, and while in the "green" state easily broken.

### MAKING CONCRETE BLOCKS

Concrete building blocks are ideal as building material on the farm. The cost to purchase these blocks has been beyond the reach of the farmer who desired to use them for all purposes; but by the use of the simple machine or mold described anyone can make the best quality of hollow concrete building blocks at an average cost of less than 6 cents each, the mere cost of sand and cement.

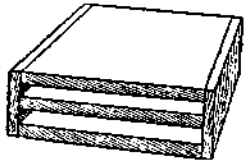
As the standard size block is 20 x 8 x 7½ inches, instructions are given for making the machine to build that size, but it can be constructed to turn out any size of block by changing the dimensions accordingly.

Take two boards 20 inches long by 7½ inches wide and 1 inch thick. These are for the sides. For the ends use lumber 10 inches long by 7½ inches wide. Care must be used to have the boards free from large knots and with an even grain, so as to avoid warping.

The above four boards were joined at three corners with six hinges; two hinges at top and bottom of each corner. In putting together have the two end boards set up against the sides as shown in Figure 1. At the fourth corner place a strong hook and eyelet to hold the machine together when making block, and by unhooking this allows the machine to be folded back away from the finished work, etc.

This makes a mold or form that is, inside measurements, 20 inches long, 8 inches wide and 7½ inches high, with top and bottom open.

For the core, take two boards of 1-inch lumber, cutting them 13 inches at the top and slanting to 11½ inches at the bottom with a width of 7½ inches. These make the sides of core. For the ends, use 2-inch strips cut 7½ inches long. These are fastened together,



as shown in Figure 1. This makes a slanting box which is set inside of the machine, as illustrated in Figure 2, and forms the hollow in the block. To the top of the core a round stick is fitted into place the length of the core, so it will set down level with the top for a handle to lift the core from the block when operating the same.

### To Operate the Machine

First set it on a board somewhat larger than the machine, as shown in Figure 2. This makes the bottom of machine and holds the block until dry. Enough of these boards must be provided for the

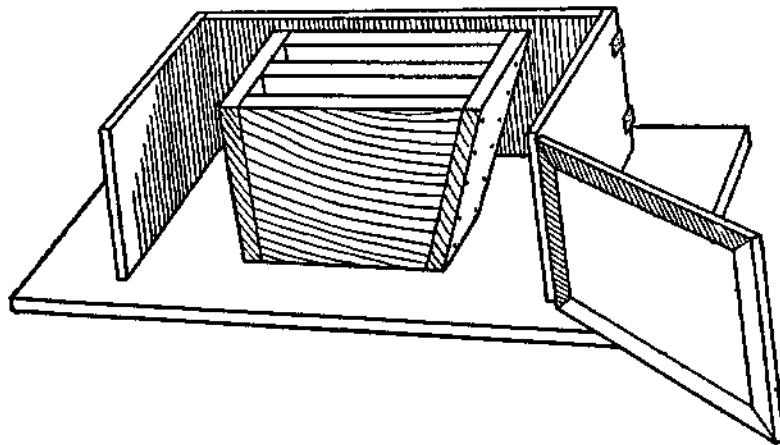


FIGURE 2—CEMENT BLOCK MACHINE OPEN

blocks made each day. Close the machine and fasten catch, then set the core in the center and fill the space around the same with the concrete mixture, tamping it in thoroughly. When full level off the top with a flat stick and carefully lift out the core, setting it on another board ready for the next block, unhook the catch and fold the machine back away from the finished block and you have the completed block ready to dry and cure. This method requires no handling and so has no danger of breaking while the block is yet "green," as it remains on the board or "pallet" until dry enough to be piled up, which they will be in three or four days.

When the blocks are to be laid in a side wall, between corners, take two 1½-inch strips 7½ inches long and attach with screws to the center of each end of machine on the inside. This molds a groove in the block, which is filled with mortar when laying the block in the wall and so securely ties it. By fastening with screws these strips can be easily removed when molding corner blocks.

### Blocks of Different Shapes

A neat panel block can be molded by taking the common half-round strips, cutting to the right lengths and fastening to the outside of the face of machine, as shown in Figure 1. For corner blocks they can be attached to either end of machine. By using small screws these can be removed when not desired and also enable you to panel either right or left end of block as needs require.

For making half-size blocks, have a piece of board that is exactly 8 inches wide and 7½ inches high, or so it will just fit into machine when core



is removed. Set this in place in the middle half-way between the ends and fill with material. This will make two half-size blocks for use in breaking joints when laying wall. If desired to have these hollow, two small cores of proper size can be made to set in place when molding blocks of this size.

Rock face effects can be produced very easily by taking a 2-inch plank the size of the face of machine or the end as desired. On this draw a border  $1\frac{1}{2}$  inches all around, then take several irons, heat them red-hot and burn out the center in irregular shape, at least  $1\frac{1}{4}$  inches deep. By making ridges and hollows in this burning process of different depths and as broken as possible, you will secure a face plate that will mold a very excellent imitation of a rock face. This, of course, can be made to suit any fancy.

One may follow the practice of making several faces and ends from plain and panels down to different rock effects, having these extra face plates the same size as given for the machine above. Then by using hinges as used on doors or any pin hinge, you can easily change the style of block by putting one face plate or end on machine in a moment's time. One machine can thus be used for any style of block and a great amount of time be saved in changing from one style to another.

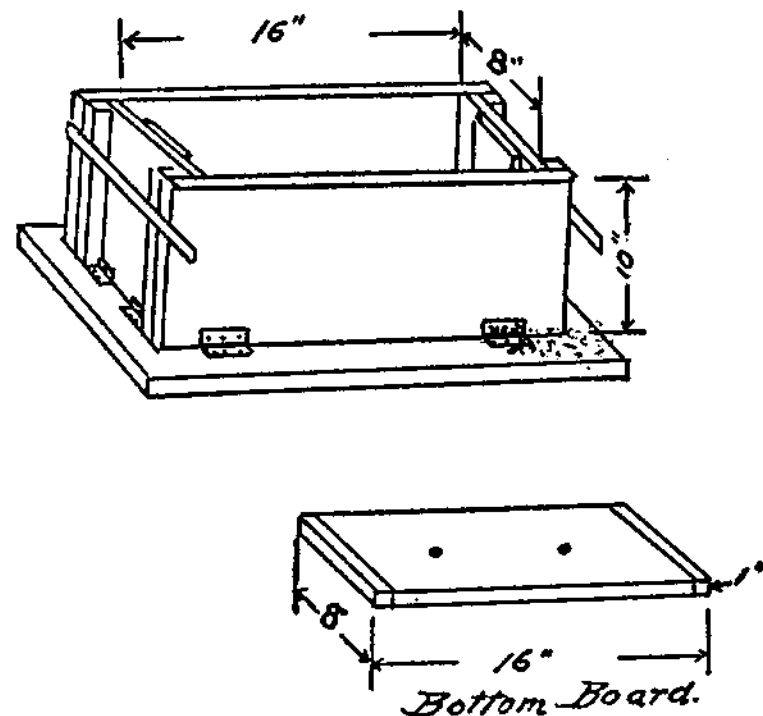
This machine, in addition to being simple in construction and operation, is very rapid. With but little practice one man can make from 75 to 100 blocks daily and have each one perfect, as he does not break any by handling them after they are molded

---

According to her cloth she cut her coat.—Dryden.

### ANOTHER STYLE OF MOLD

All the lumber necessary to make this mold should be selected white pine or hardwood, free from knots and sap. The platform on which this mold rests should be 14 x 24 inches and be well battened together. The sides are made as shown



THE FINISHED MOLD

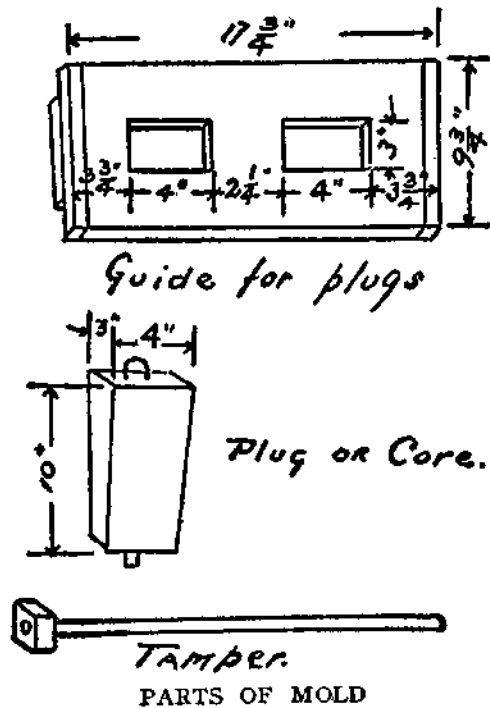
by the drawings, with a cleat on each end, which overlaps the end pieces and holds them in place. Both ends and sides are fastened to the platform as shown, with hinges, which permit them to be turned down to take out the completed block.

On each end is placed a flat iron bar with a notch in to fasten the whole mold together. These

bars are the same as hooks, only the ends are prolonged to act as handles for convenience.

### Regulating the Height of the Blocks

The bottom board is intended to be fitted in the bottom of the mold loosely and should be blocked up from the bottom to give the required height of



the finished block. The end pieces of mold have a thin piece of board running up and down to form a key between blocks and should run down to top of bottom board.

The plugs are made as shown, with a taper both sides, so that when they are removed they clear all the way out. The pins in the bottoms of the plugs

are to fit in the holes in the bottom board, which will steady them and hold them in place.

When the plugs are removed the board with the two square holes is placed over the top of mold and the handle of tamper is run through the rings in top of plugs and they are lifted up. This board is used as a guard and prevents the block from being broken when plugs are removed, and should not be used until the block is finished and ready to take out of mold. The tamper is made of a large iron nut and a piece of iron rod about 18 inches long.

### Filling the Molds

To make these blocks use one part of portland cement and three parts of good sharp sand, mix well and put enough water on to simply dampen the whole. Now close up the mold, put plugs in place, fill the mold one-fourth full and tamp down hard. Repeat this until the mold is filled. Scrape off surplus material, remove the plugs, then turn down sides and lift out finished block which is to remain on the bottom board until hard enough to lift off.

It will be necessary to have a number of these bottom boards. After a number of blocks are made they should be sprinkled from day to day for from 15 to 20 days to properly cure them before using. A barrel of cement will make about 50 blocks and one man can make a block in 12 minutes.

### MIXING CEMENT FOR BRICK

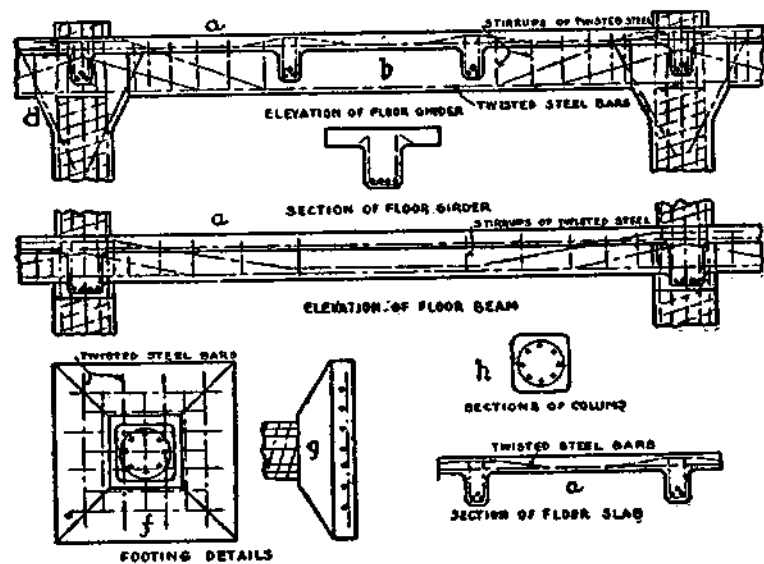
Many have found mixing the sand and cement the hardest part of cement brick making. An old

vinegar barrel may be put to use by placing a grindstone crank on one end and a pinion on the other. Two strong posts are set in the ground and the barrel hung over two pieces of round iron driven into the posts. A square hole is cut on side of barrel and covered with a piece of sheet iron hinged and a bottom to fasten.

The sand and cement are dampened, shoveled into the barrel and a boy may turn the crank. The mixing is done as fast as two men can mold, with a boy to sprinkle the brick to prevent drying too fast.

## REINFORCEMENT FOR CONCRETE

For heavy construction work involving beams and columns, reinforcement with steel rods is needed. Reinforced concrete is rapidly coming to be the most approved kind of construction of large



DETAILS OF REINFORCEMENT

buildings. Our own great building is one of the most noteworthy examples, being of reinforced concrete throughout. For any building where reinforcement seems desirable the following details will be found useful:

Plan of the footing or foundation of each column is shown in *f*; *g*, side view of footing and part of column above. The steel rods that run up through column are shown by dots in *h*, and the wire spiral by diagonal lines in *g*. *h* is cross-section of column filled with cement, the shaded part being the concrete. *a*, section of floor slab,  $4\frac{1}{2}$  inches thick; it is also shown on top of the floor girder and floor beam (crossbeams between girders). *b*, girder; *c*, cross-section of girder, the dots showing twisted steel bars that take up the tensile stress—compression stress is carried by the concrete. The steel bars, *d*, stuck into the column at an angle, are to prevent the girders from breaking off or “shearing” at column.

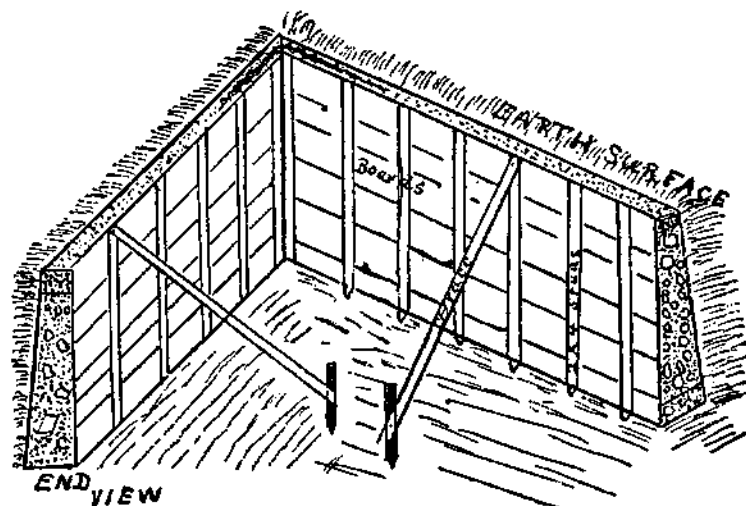
## MAKING A FROSTPROOF CELLAR

Some farmers build their own concrete cellar walls and chimneys with inexperienced help. Lay out your foundation the same way you would for any building. Have outside line of excavation plumb. Then use 2 x 4-inch studs the length required. Point one end, drive in ground, on line of inside of cellar wall, brace top of stud by driving stake in ground, and nail brace to stake and each stud. You must make everything firm. Then take square edge boards and place horizontally against the studs. (See illustration.)

Do not try to go around the whole cellar wall, take one side at a time to the height of earth sur-

face, but turn your corner. Pay no attention to outside, let the stone and cement push up against the earth. It is the best plan to finish the whole wall up to the earth surface line before making the elevation above the ground line.

Above the earth surface line do just the same on the outside as you have been doing on the inside, but now you must use boards and studs, as up to



CONCRETE CELLAR WALL

this point the earth took the place of them. Plumb every stud you drive, and place them 24 inches apart. Have cellar window frames ready and place them as you come to them. Be sure and make extension for hatchway when building your main wall. For the corners use baled hay wire in wads, bending it around the center of wall, and a reinforced concrete corner will be the result.

Get cobblestones or any stone from the size of a goose egg to the size of your head, and put them in bottom of wall to depth of 1 foot. Make a mixing bed, say, about 12 x 36 x 72 inches. One man

used an old wooden sink as near watertight as possible. Use one water pail of cement to three of fine gravel sand. Put one and one-half pails water in the mixing bed, then add the cement. Be sure and mix water and cement well before using sand. Throw sand in one shovelful at a time. Have one person mixing with a good-sized hoe, while another throws in the sand. Mix well.

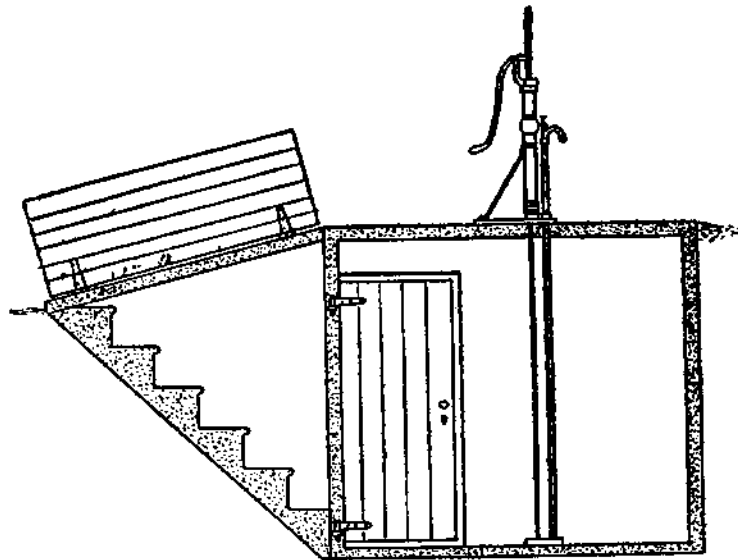
Have it about the same as thin mortar, so it will leave the pail easily when pouring into the foundation. Cover the stones and then put in another lot and do the same to height of wall up to within a couple of inches. Do not put stones to full height of wall. To bring wall up to line, mix cement and water together (or one part sand and one cement) so it will run, and after wall is hard pour it on top and it will find its own water level and your sills will fit exactly. It is a good plan to have wall thicker at bottom than at top—perhaps 18 inches at bottom and 12 inches on top.

Now for hatchway steps. Put in the stones, as they save cement. Before the cement gets hard, drive in some large spikes, leaving them projecting about 2 inches on line of hatchway sills. Your hatchway doors will stay in place if sills are well-fitted on to spikes. One of the most important things is to be sure of the sand you use. If there is more than 10 per cent loam in the sand, your work will be a failure.

### A SUMMER COOL ROOM

A simple method of constructing a cool, outdoor cellar in localities where the common house cellars are too warm for use during the summer time, is shown in the accompanying sketch. It is a cellar

made under the pump, so that the water pumped by the windmill has a very cooling effect. In places where it is difficult to obtain ice, it will prove indispensable to the dairyman who keeps a few cows. Another important item is the fact that a man does not have to pull up all of the pipes every



CONCRETE OUTDOOR CELLAR

time that he finds it necessary to repair the pipes and pump.

It is constructed of concrete. The top is reinforced with  $\frac{1}{2}$ -inch steel rods placed 1 foot apart each way and the concrete work is about 6 inches thick. The sides are made by using a form, and the stairs are also made of concrete and are reinforced by small steel rods. The cost, including the labor, is about \$50. In the west and southwest it will also answer the purpose of a storm cave, which is considered a fixture on all farms.

## A CONCRETE SMOKEHOUSE

The structure is about 8 x 10 feet and 7 feet high. It will keep the meat inside and thieves out. For a building of this sort 8-inch walls will be thick enough. Excavate to the proper depth below frost, which will be two feet or less, and use a mixture of one part portland cement, three parts sand and six parts gravel or broken stone.

Make the forms of matched boards, although square-edged boards could be used for this purpose. The forms must be well braced and may be raised as the work of laying the wall progresses. Space for a doorway must be left and two eye-bolts inserted in the concrete for the door to swing on. The door jamb can be molded in cement if it is desired. An eyebolt for the lock and latch should also be placed in the wall.

The roof will no doubt be of boards or shingles. The plates should be placed on the concrete and held to it with bolts properly imbedded. An arched concrete roof can be made if desired, in which case it will be necessary to leave suitable vents in each end, or build a small flue to allow the smoke to escape. To make the house absolutely proof against fire a steel or iron door should be used.

## LAYING A CONCRETE FLOOR

A concrete floor should be level with the top of the sill, where there is much passing in and out with stock or wagons. There should be about 4 inches of concrete. If the earth is leveled off and tamped down hard, it would be unnecessary to put any crushed stone under the concrete in a building

where frost or water does not get underneath. It is generally recommended to put several inches of stones, gravel or cinders on top of the earth, but many floors are laid without such a bottom. Partitions for horse stalls and cattle stanchions can be held in place on a cement floor by putting down iron belts or pieces of gas pipe when the floor is laid. Let them project 2 or 3 inches above the floor.

### MAKING A CONCRETE WALK

The best way is to dig a trench 16 inches deep, put in a foot of loose gravel or stone, leveling it off with fine material. On top of this spread 3 inches of concrete made of one part portland cement, two parts sand and four parts crushed stone or gravel. On this put a granolithic finish 1 inch thick mixed in the proportions of 1-2-3. Trowel it down smooth and hard. Joints  $\frac{1}{4}$  inch thick and filled with sand should be left every 5 feet to prevent walk from cracking

### CEMENTING A CISTERN WALL

In making a surface waterproof, a mixture of about one part portland cement to two of sand will shed water from a roof or wall, but to make a surface perfectly watertight, so that it will keep out standing water, it is better to use neat cement only, that is, cement with no other material but the water with which it is mixed, and it will cost less to put on a coat  $\frac{1}{4}$  inch thick of neat cement than one 1 inch thick, one-half or two-thirds sand, as the neat cement mixed with plenty of water is waterproof.

### SPECIAL USES FOR CEMENT

A sack of portland cement is a very useful thing to have for making quick repairs about the farm. A hole in a drain pipe can be stopped in a few minutes with a little cement, mixed with water, thick as putty. A crack in a barrel can be stopped this way. Hardwood floors may be patched and nail holes filled so they will not leak.

A waterproof floor can be laid over an old board floor in a short time. Sweep the old floor clean and dry and nail down all loose boards. Cover with a layer of heavy wire netting, tacking it down occasionally. Over this lay a layer of concrete of one part portland cement, three parts clean sand, mixed with water to a thin paste.

Smooth thoroughly, but if it is to be used by stock, brush with an old broom to make it rough, then let it dry thoroughly before using the floor. Gutters may be put in where necessary. Holes in an old shingled roof can be quickly stopped by forcing a little cement putty under the shingle where the leak appears.

Some special uses to which cement is being put are the making of bee hives, brick for pavement and ordinary foundations, cement shingles for roofing, grain bins in the form of square boxlike and round barrel-like receptacles. The use of this excellent material for farm structures is only just opening up and it is destined to become the most important material for general farm building.

---

A wooden reinforcement in the center of a concrete fence post is worse than useless. It does not make a bond with the concrete, and thus weakens,

instead of strengthens, the post. Of course, the same is true of wooden reinforcement of any concrete work.

## A TIME-HONORED HANDY DEVICE

(SEE FRONTISPIECE)

How dear to my heart are the scenes of my childhood,  
 When fond recollection presents them to view!

The orchard, the meadow, the deep-tangled wild-wood,  
 And every loved spot that my infancy knew!

The wide-spreading pond and the mill that stood by it;

The bridge, and the rock where the cataract fell;  
 The cot of my father, the dairy-house nigh it;

And e'en the rude bucket that hung in the well—  
 The old oaken bucket, the iron-bound bucket,  
 The old moss-covered bucket that hung in the well.

How ardent I seized it with hands that were glowing,  
 And quick to the white-pebbled bottom it fell!

Then soon, with the emblem of truth overflowing,  
 And dripping with coolness, it rose from the well.

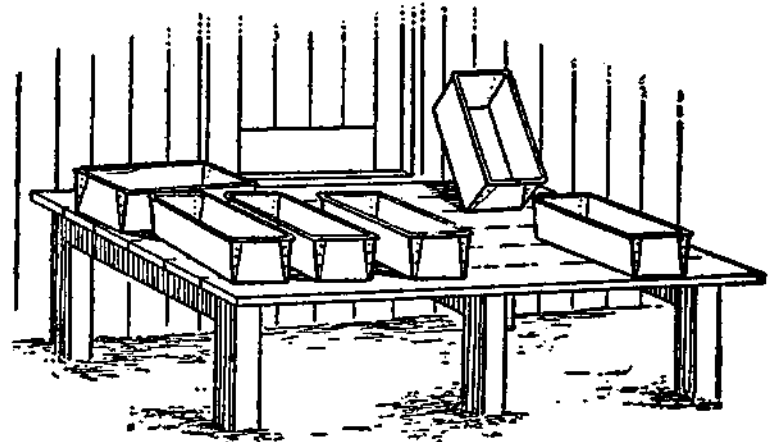
—Samuel Woodworth.



## FREEZING ICE IN BLOCKS



HERE a pond or stream is not handy from which to get the year's supply of ice, blocks can be frozen in forms with comparatively little labor. A supply of pure water is essential. The forms are best made of galvanized iron of any size desired. A convenient size is 16 inches wide, 24 inches long and 12 inches deep inside measure. The sides and ends should be made to taper  $\frac{1}{4}$  inch, so



HOMEMADE ICE MOLDS

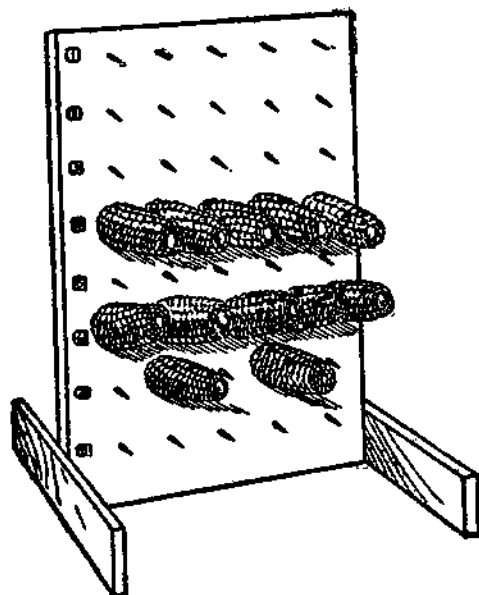
that the frozen block will drop out easily. The top of the mold should be reinforced with wire for the sake of strength and durability.

With a dozen or 20 forms one can put up quite a supply of ice during the winter. The forms should

be set level on joists or boards and placed a few inches apart. Fill them nearly full with pure water and let them freeze, which they will do in one or two days and nights in suitable weather. When frozen solid, turn the forms bottom side up and pour a dipper of warm water on them, which will release the cake of ice. The form can then be lifted off, the ice put away in the icehouse and the form filled with water again.

### SAVING THE SEED CORN

Here is a handy device for preserving select ears of seed corn. It consists of a wide board



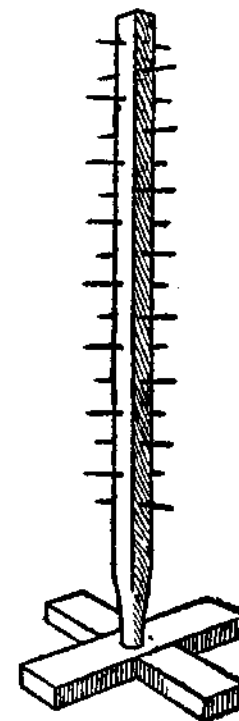
SEED CORN RACK

fastened between two supports nailed to the edges. The board stands upright on one end and may be as long as desired. Drive heavy spikes through it from the opposite side and stick an ear of corn upon each spike. This allows for the passage of air, and the ears can be examined without removing them from the rack. It

is much to be preferred to expensive wire racks, as each nail may be numbered and a record kept of the ears in this way. This rack was designed at the Idaho experiment station.

### RACK FOR SEED CORN

Here is a simple arrangement for keeping choice ears of seed corn. Take a 2-inch square timber for the upright, and make a solid base by boring a hole through the two base pieces, then drive the timber into it. Drive 4-inch spikes through the upright at intervals of 6 inches from four sides, and stick the ears of corn on these spikes by thrusting the same into the butt of the cob. Numbers may be placed above each spike, so that records can be kept of all of the corn. The corn should be placed on this rack as soon as picked and husked, and may be left there until planting time if the rack is placed in a dry room where rats and mice cannot get at it. A large post strongly mounted on a heavy pedestal may be used in a manner similar to the small upright described above. The bigger the post and the larger the number of spikes used, the greater the capacity of the rack, of course. It is a good plan to make the pedestal heavy and strong in order that it may not be tipped over too easily.



RACK

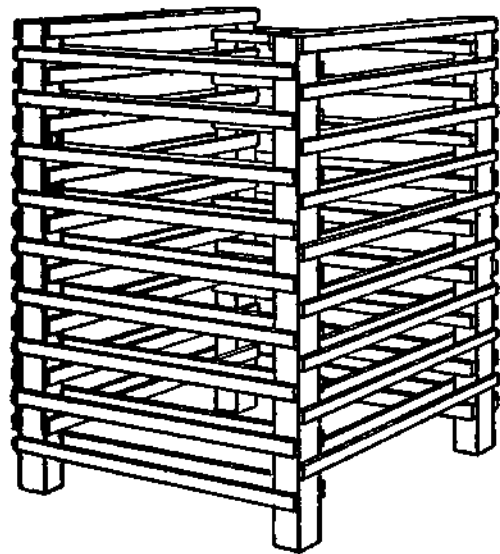
The first years of man must make provision for the last.—Samuel Johnson.

Put your trust in God, my boys, and keep your powder dry.—Colonel Blacker.



## DRYING AND KEEPING SEED CORN

Never let it freeze before it is dry. Farmers have had seed corn exposed to a temperature of 30 degrees below zero without injuring its vitality, and have had it ruined at 10 degrees above zero. We would not recommend kiln-drying for the general farmer, as this is only practicable where a grower is in the seed business. A very convenient way is to take four pieces 4 x 4



CORN DRYING RACK

6 feet long, set them up in a square, and nail laths on them two and two opposite. Leave a 6-inch space between the laths, so the corn will have plenty of ventilation. Lay your corn on this to dry, and if thoroughly dry it can lay there all winter.

Knowledge is worth nothing unless we do the good we know.

It is better to give one shilling than to lend twenty.

Keep your mouth shut and your eyes open.

FIG. 1



FIG. 2

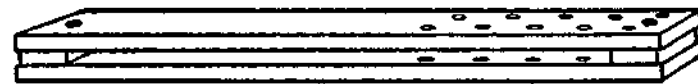


FIG. 3

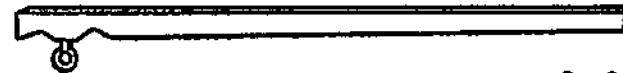
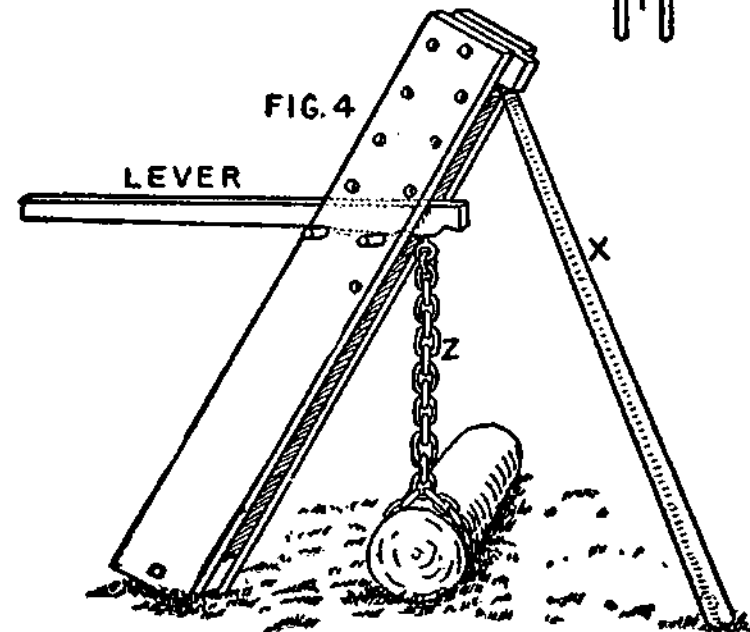


FIG. 4

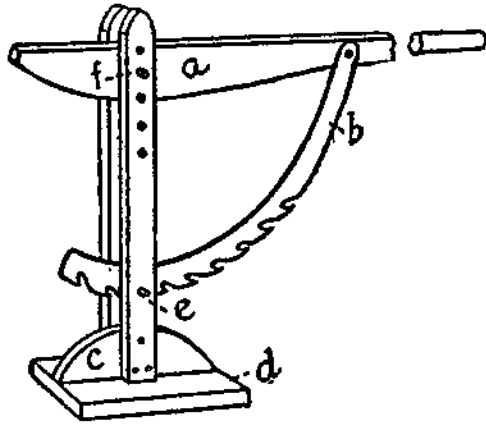


WEIGHT LIFTER AND DETAILS

The drawings show the different parts and one of the many uses of this device.

## STRONG AND SIMPLE WAGON JACK

Here is a good, practical wagon jack suited to almost all kinds of vehicles. The whole thing is made of wood with the exception of the curved piece, *b*, which is of iron and hooks over an iron bolt, *e*. It is well to have a strong  $\frac{1}{2}$ -inch bolt at *f*, so as to support the heavy weight on the lever, *a*. The bottom, *d*, and the piece, *c*, are each 2 inches thick. In using the jack, the axle is lifted by simply pressing down on the handle of the lever. The teeth of *b* catch and hold on *e* automatically. The height of lever is regulated by moving *f* up and down.



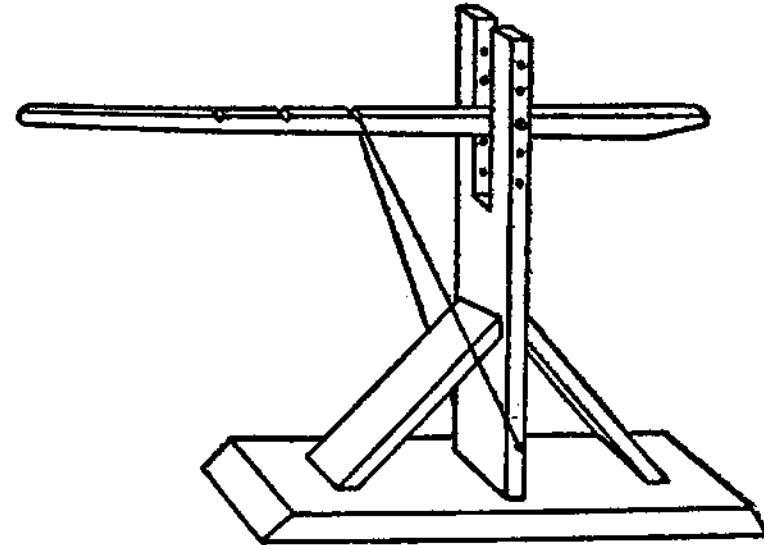
WAGON JACK

Write down the advice of him who loves you, though you like it not at present.

## A JACK FOR HEAVY WAGONS

Many lifting jacks which are designed for light vehicles would not work well in the case of a heavy log wagon. Here is one that will stand a lot of hard usage and is simple and effective. Make the base and upright of heavy 2-inch oak plank and insert a  $\frac{3}{4}$ -inch bolt through the lever for a support. Have a good, strong hemp rope attached to the base, pass-

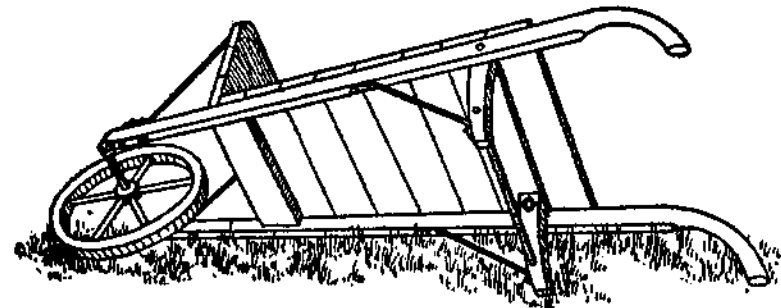
ing over the handle end of the lever, so that as it is drawn down and the wagon is lifted it can be hooked in a notch to hold it in position.



HOMEMADE WAGON JACK

## A CHEAP WHEELBARROW

The construction of this barrow is very simple. Get a pair of old plow handles, two gate hinges about 1 foot long, and a wheel, which may be found at the junk dealer's. The legs of the wheelbarrow

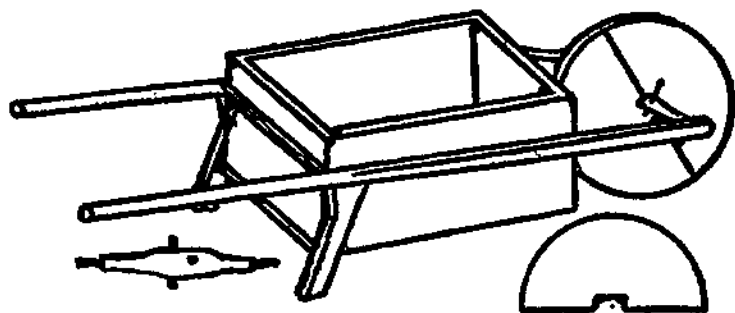


MADE FROM OLD MATERIAL

are those of an old chair, braced with a piece of iron. These articles in themselves are worthless, but in their combination we create something very useful.

### A WHEELBARROW CHEAP AND STRONG

Here is a picture of a handy, strong wheelbarrow that any farmer can make on a rainy day. Take a dry-goods box 30 inches long, 24 or 26 inches wide and 20 inches deep, and two sticks  $5\frac{1}{2}$  to 6 feet long and  $3 \times 3\frac{1}{2}$  inches for handles. Nail or screw



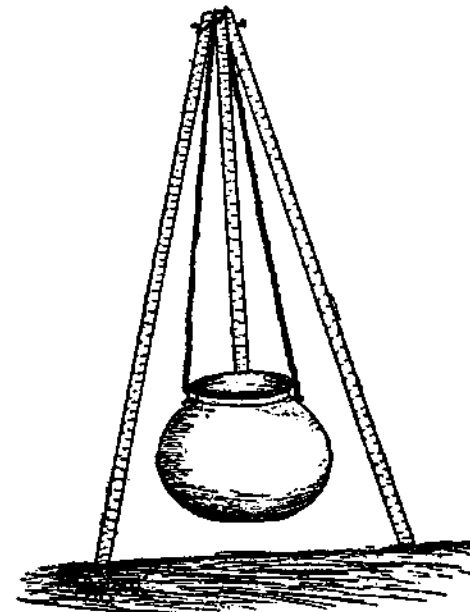
BOX WHEELBARROW

on crossbrace in front and rear, and pieces with brace as shown for legs. Cut four half circles from inch hardwood board and a notch in center to fit around axle. Nail these securely together for the wheel.

For the axle, take a stick  $3\frac{1}{2}$  inches square. Trim and band each end or wrap with wire. Bore holes and drive a 6d. wire nail in each end. Just 2 inches apart in center, bore two 1-inch holes on opposite sides to hold the wheel in place. A band of hoop iron around the wheel will make it last longer. When it is put together, you have a very substantial wheelbarrow that cost but little.

### HOW TO HANG A KETTLE

Using stones for a kettle support seems handiest oftentimes, but let the heat crack one of the stones and tip the kettle over, as it frequently will, does not tend to improve a man's language, let alone the loss sustained. It is much better to make a support such as is presented in the cut. The three uprights, of suitable length to correspond with the size of the kettle, may consist of any good wood. Through the top of these a hole is bored for the bolt to hold them together, which



TRIPOD-HUNG KETTLE

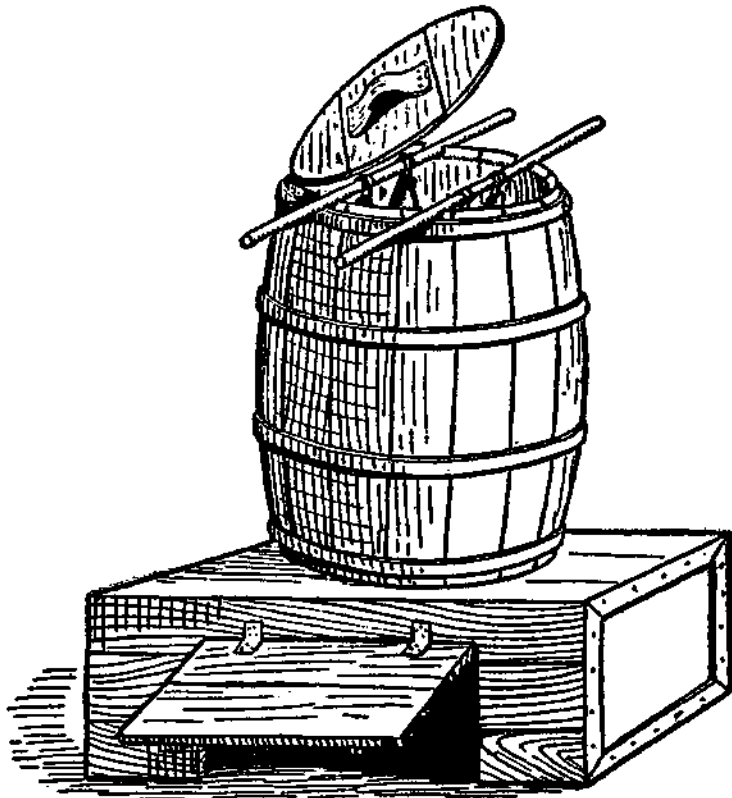
must be long enough so they will have play to set up easily. All that is necessary then is to suspend two chains from the top and letting them extend downward to the proper distance, attach the ears of the kettle into the hooks on them. When not in use, the device can be folded together and laid away.

### A SNOW PLOW

No person not owning a snow plow can appreciate how useful one is after every storm. A horse, or if the snow be a heavy one, a span or a yoke of cattle and this simple homemade arrangement, and

in less time than is required to tell it there is a path, and no back-breaking work either. It is only a big V braced so the snow is pushed both ways by it. It must be made of 2-inch planks at least 1 foot wide and not less than 6 feet long. If shorter it wobbles and does not stay on the ground well.

To make a good road for teams, chain it to one side of the wood sled and drive up and down. It spreads 2 feet, and will make your farm front look as if somebody of pluck lives there. For foot-paths draw it from a ring at the top of the front so it will root.



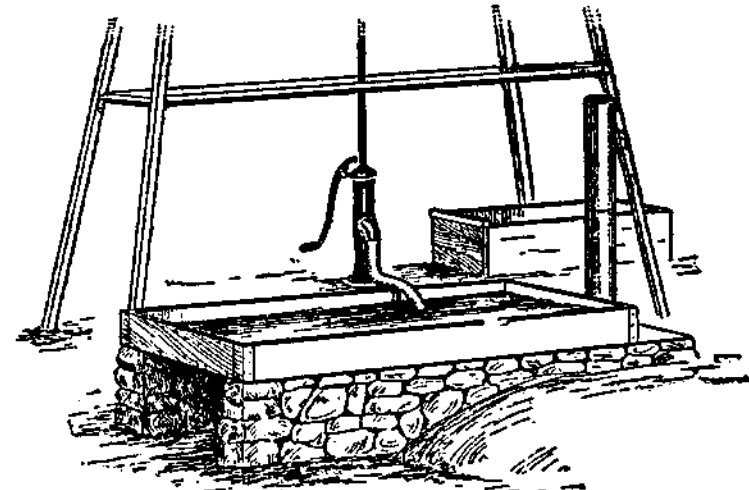
SMOKEHOUSE SUBSTITUTE

## TEMPORARY SMOKING DEVICE

If one butchers only once a year it is not necessary to build an expensive smokehouse, for almost as good results can be obtained from a device such as that shown on page 242. It is made by taking both ends out of a barrel and mounting it upon a box or above a fireplace in the ground. The meat to be smoked is hung from the sticks laid across the top of the barrel, the fire built underneath and the lid put on.

## HOMEMADE HEATER AND COOKER

A cheap and economical heater may be of home construction. Make a frame of 2 x 8-inch pine 7 feet long and 27 inches wide. Put a bottom on



TANK AND COOKER

this of No. 18 galvanized iron, letting it project  $\frac{1}{2}$  inch on each side and 14 inches at one end for a stovepipe fitting. Spike the frame together and

cover the corners with heavy tins to prevent any leaking. Nail the bottom on with two rows of nails.

Make a fireplace on the ground of stone and blue clay or brick and cement of mortar if preferred, 2 feet wide by 3 feet long and 18 inches high. Pile up dirt 1 foot high and 3 feet wide at the end of the fireplace for a flue, put stone on the earth the length of the galvanized iron, place the tank on this foundation and bank it up with dirt. In cutting a hole for the stovepipe, turn up strips of the galvanized iron for a collar, then drive an iron rod into the ground, put on two lengths of stovepipe and wire it fast to the rod.

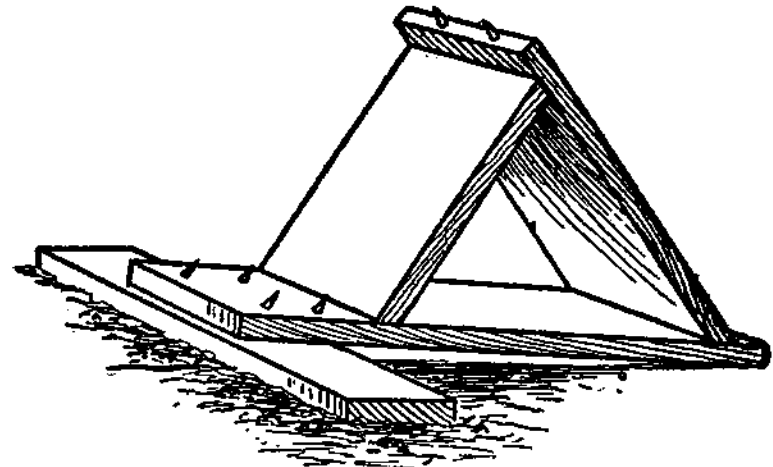
A piece of sheet iron should be set up before the fireplace to control the draft and keep the fire. Such a heater, on one farm, is located near the windmill and storage tank and can be filled from either. The water can be heated quickly with cornstalks, straw, cobs or brush. One may boil pumpkins and small potatoes for fattening the pigs, and cook ground feed by pouring scalding water on the meal in barrels and covering with old blankets or carpets. A light fire will take the chill from ice water for the milch cows.

### USE FOR A TOUGH LOG

Most farm wood piles have two or three old logs lying about which nobody cares to tackle with an ax or blasting powder, and are too short for the sawmill. If straight, they will make good water troughs. Square the ends, mark off about 10 inches from each end, chop out the inside and trim the edges. An inside coat of oil or pitch tar will increase wearing qualities.

### A HANDY WOOD SPLITTER

For splitting wood a farmer in eastern Massachusetts uses a device as shown in the cut. Take a 2 x 8-inch plank about 3 feet long and an upright of the same material about 20 inches long. Set this upright at an angle of 20 degrees and use a brace of



WOOD SPLITTING DEVICE

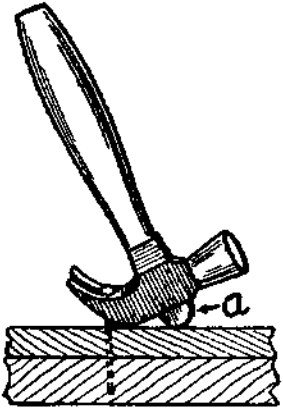
the same material. The sharp points shown in the cut are 40d wire nails. Set the wood against these spikes in splitting it.

### HOW TO SPLIT WOOD

Wood splits much more readily in the direction up from the root of the tree than when the blow of the ax is downward. In other words, to split a chunk place it upside down—contrary to the direction in which it grew. It is much easier to split by slabs than to try to cleave through the center. This means to split off pieces near the edge.

### A PULLING HAMMER

If you want to make your old claw hammer do more work and do it better and easier, have the handle projecting a little beyond the head. You will find it much more convenient in drawing a nail, as it makes a right angle for pulling the nail without bending it to one side. It takes the place of a block and is always on hand and ready in the right place for immediate use. The handle is simply whittled a little more than usual and driven through to the required distance. Don't drive it through too far, but about as shown at *a* in the picture. If it sticks out too much, it will be in the way when driving nails. Whittle it off rounding, and give it a finished appearance.



### MOUNTING THE FARM ANVIL

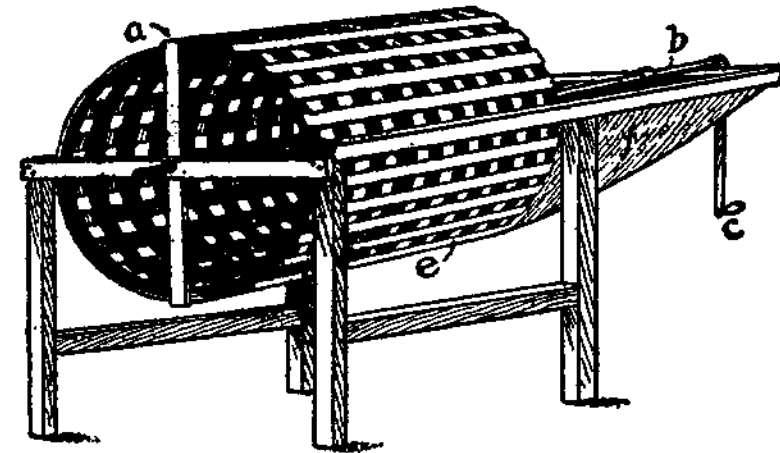
To make a solid foundation for an anvil, build a form of boards 14 x 18 inches square at the base, 18 inches high, tapering to 8 x 10 inches at the top. Fill this mold with rich concrete and fix a bolt in the center of the top of it to fasten the anvil. Afterward, melted lead can be poured around the base of the anvil, completing a very nice pedestal.

### SORTING POTATOES QUICKLY

The sketch shows a homemade potato cleaner and sorter. It consists of a number of hoops to which are fastened  $\frac{1}{2}$ -inch slats so as to make holes

$1\frac{1}{2}$  inches square. Two heavy pieces, *a*, are placed inside the cylinder to hold the axle, *b*, which extends entirely through the machine and is turned by a crank, *c*. The frame made is 4 inches lower at the opening end of the cylinder so that the potatoes will run through freely.

At the crank end is a hopper, *f*, into which the potatoes are poured. The cylinder is  $2\frac{5}{8}$  feet long



POTATO SORTER AND CLEANER

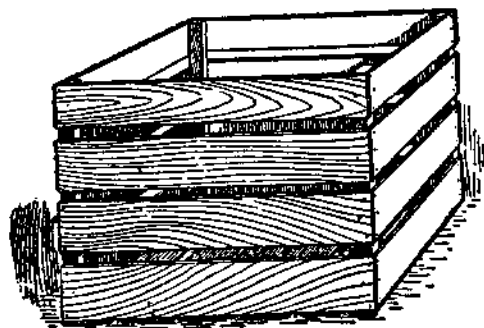
and 3 feet in diameter. It will not bruise the potatoes, and the dirt and small ones run through on to the floor or crate and the marketable ones run out at the open end of the cylinder into another crate. With one man to turn the crank and another to fill the hopper, from 700 to 800 bushels can be sorted in a day.

---

An indiscreet man is more hurtful than an ill-natured one; for as the latter will only attack his enemies, and those he wishes ill to, the other injures indifferently both friends and foes.—Addison.

## HANDLING POTATOES EASILY

A bushel crate is often more convenient to use in handling ear corn, potatoes or other vegetables



STORAGE BOX

than a basket. Crates that will hold a bushel when level full may be piled upon one another and thus stored in less space than baskets. At the same time they can be just as easily and just as quickly

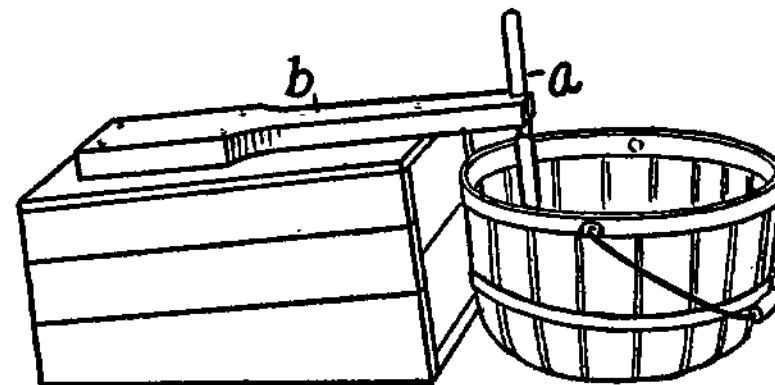
moved. They may be of light material. Pieces of wood 2 inches square are used for the corner posts. The slats may be made of  $\frac{1}{2}$ -inch boards 3 inches wide nailed securely to the corner posts. There should be just room enough between the two upper slats so that the fingers can be inserted when lifting the box. The box will be more durable if the upper slats are an inch thick. A handy size for the completed box is 16 inches long, 14 inches wide and 12 inches deep, outside measurements.

## CUTTING SEED POTATOES

In the principal potato growing sections, medium to large seed is used for planting and cut to two eyes. In the famous Greeley district of Colorado, cutting is done by hand. Potatoes are shoveled into a bin or hopper, made of a dry-goods box raised on legs. The back is made higher than the front, so that potatoes will run down to the open-

ing and the bottom is slatted to let out the soil shoveled up with the potatoes.

The cutting is simple. An old case knife, *a*, is fastened to the end of a plank or board, *b*, in such



SEED POTATO CUTTER

a way that potatoes can be pushed against the knife and fall from it into the basket beneath. The operator sits on the box to which the board is fastened and can work very rapidly.

## ANOTHER SEED POTATO CUTTER

A wide bench is boxed in on both ends and one side. It is divided into two or three compartments, these being open in the front which corresponds to the side boxed in. To each of the compartments is attached a sack on hooks, and along one side of the bench in the middle of each compartment and right over the opening of the sack is fixed, in an upright position, a shoemaker's or common steel table knife.

Potatoes to be cut for planting are shoveled into the compartments of the box and in front of each compartment a man takes his position, being seated

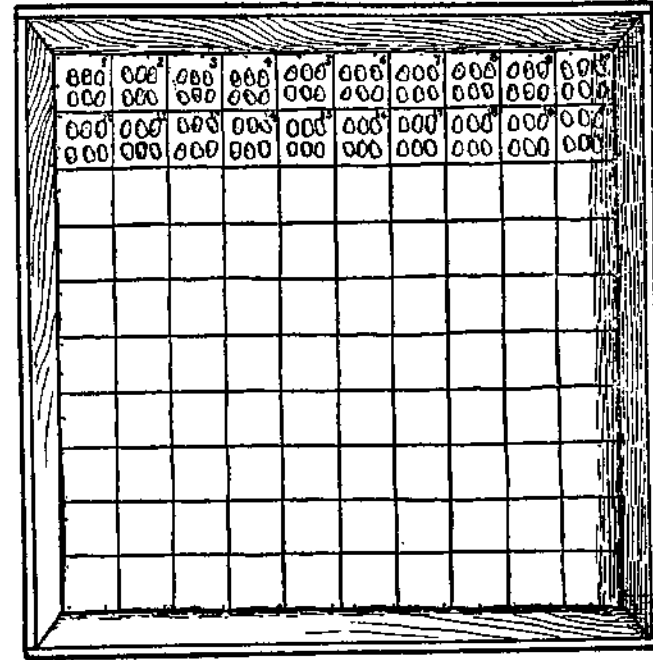
on a box or stool for comfort's sake. He seizes the tubers in rapid succession and by pulling them against the blade quickly cuts each one into as many pieces as desired; the pieces are then dropped into the open sack. It is claimed that by this indirect method of using the knife two fairly good cutters can cut each day all the potatoes ordinarily required for the use of one planter.

### HOW TO TEST SEED CORN

Of the different methods for testing seed corn, the most convenient and satisfactory is a shallow box provided with wet sawdust to furnish the moisture and a marked cloth on which to lay the kernels. The most convenient box is one 2 feet square. This will accommodate 100 ears. It is best to make it about 6 inches deep. Fill a sack half full of clean sawdust and soak it for three or four hours in water. Then spread this sawdust in the bottom of the test box to the depth of 1 inch. Take a smooth brick and pack the sawdust down all over the box, making it as level as possible. Be sure to get it packed firmly around the edges and in the corners.

Then take a piece of white muslin 25 inches square. Stretch this tight on a table so that it can be marked. Rule off on this cloth with a heavy blue pencil 100 squares 2 inches each way. Beginning at the upper left-hand corner number these squares in rotation from left to right. When the ruling is done, pack the cloth in the germination box so that it will rest firmly on the sawdust. This can be done by pointing the tacks in the edge of the box downward, and as the tack is driven in it will draw the cloth tight over the sawdust.

Of course, there is no advantage testing any ears that are of undesirable shape or conformation, therefore the first step is to pick out those nearest to the type wanted. Lay these out in rows upon a plank or upon the floor, separating each ten ears with a nail driven into the plank or floor. Starting at the left-hand end of the row call the first ear No.



GERMINATION BOX

1, then the first ear beyond the first nail will be No. 11, the one beyond the second nail No. 21 and so on.

Remove six kernels from ear No. 1 and place them in square No. 1 in the test box. Put six kernels from ear No. 2 in square No. 2 and so on through the row. In removing the kernels from the ear take a pocketknife in the right hand and the ear in the left. Place the blade at the side of the



kernel you wish to remove and pry it gently. The kernel will come out easily and should be caught in the palm of the left hand. First remove a kernel from near the butt of the ear; turn the ear a quarter turn in the hand and remove a kernel from the center; turn the ear another quarter turn and remove a kernel from near the tip; another quarter turn and remove a second kernel from near the butt; another quarter and remove the second kernel from the center; another quarter turn and remove a second kernel from the tip. This makes six kernels from six different rows and representing the butt, middle and tip.

In placing the kernels in the box it will be found of advantage to point the tips all in the same direction, and also to lay the kernels with the germ uppermost. If the kernels are laid in the squares promiscuously, they may be thrown out of their places when the sprouts begin to grow. When the kernels are all in place, take a second piece of white cloth fully 24 inches square, moisten it and lay it carefully over the kernels. This will hold them in place while the top layer of sawdust is being put on. Take a third piece of cloth about 48 x 30 inches and lay it over the box so that the edges lap about equally. Then in this cloth put another inch of wet sawdust and pack it down firmly, especially around the edges. When this is done turn the edges of the cloth over the sawdust to keep it from drying out too rapidly and place the test box where it will not be subjected to cold below a living-room temperature.

### Reading the Results

After seven days carefully roll back the cloth containing the top layer of sawdust and lift the

second cloth off the kernels. This must be done with care, because sometimes the sprouts grow through the cloth and the kernels will cling to it.

Observe the results in square No. 1. If all six of the kernels have vigorous sprouts, from  $\frac{3}{4}$  to 2 inches long, you can be sure that ear No. 1 is thoroughly good. If in square No. 2 only two of the kernels have sprouted, you may know that ear No. 2 will make much better hog feed than seed corn. As soon as you have determined that ear No. 2 is really bad, pull it out from the row about half its length, leaving the other ears in place. After you have gone through the whole line, you may then go back and pick out the bad ears and discard them.

Of course, we would all prefer to use only those ears that gave a perfect germination, and if one has enough, that is the thing to do. But experience has taught that it is quite safe to use an ear, four of whose kernels grow strong sprouts. Or, if seed corn is scarce, one should not hesitate to use one that gave three strong sprouts and two weaker ones.

This testing may be done at any time after the ears are dry. It is generally more convenient to do it in winter, when there is not much outside work to be done. The box may be set behind the stove or any other convenient place, where it is sufficiently warm; in many cases, where there is an attic above the kitchen that room is a sufficiently warm place for testing.

Some put sand in an ordinary dinner plate, flood with water, and then drain the excess water off, place the seed on top of the sand, and cover with another dinner plate. Others use a saucer made

of porous clay. The seeds are placed in this, the saucer set in a pan of water, and the pan covered.

These methods may be used for other grains as well as corn. In case of sowing grasses, alfalfa or wheat, it is often of great advantage to test the seed.

---

Every man has two educations—that which is given to him and the other, that which he gives to himself. Of the two kinds, the latter is by far the most valuable. Indeed, all that is most worthy in a man he must work out and conquer for himself. It is that that constitutes our real and best nourishment. What we are merely taught, seldom nourishes the mind like that which we teach our selves.—Richter.

---

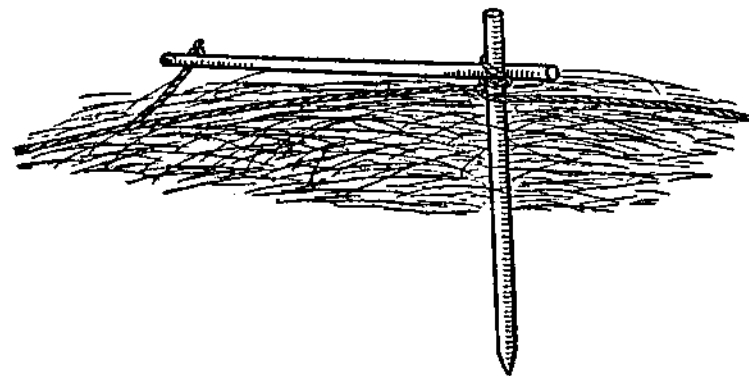
### KILLING INSECTS IN GRAIN

If one has not time to make a substantial box for fumigation of seed grain for insect destruction, barrels may be utilized for the purpose. Get two tight, strong barrels, such as coal oil barrels, and make water tight. Put in the seed to be fumigated, cover with a blanket and close-fitting cover. Before covering pour carbon bisulphide, which is explosive, over the grain, at the rate of 3 to 4 ounces for 5 bushels of grain. If it is not desirable to pour this poison on grain, set a saucer on it, and pour the poison in the saucer. Place a small block near the saucer to hold up the blanket 1 or 2 inches higher, lay blanket over the

barrel, and place cover securely in place and weight with stone. This will kill the weevil in peas and beans.

### BINDING PINS FOR HAY

Every person moving hay ought to have a set of binding pins. They are made in a minute and serve an excellent purpose for a lifetime. The sketch shows a rope stretched over the top of a load of hay or straw. The upright pin is worked down into the load and the other twisted in the rope and turned around the upright until the load



BINDING LOAD OF HAY

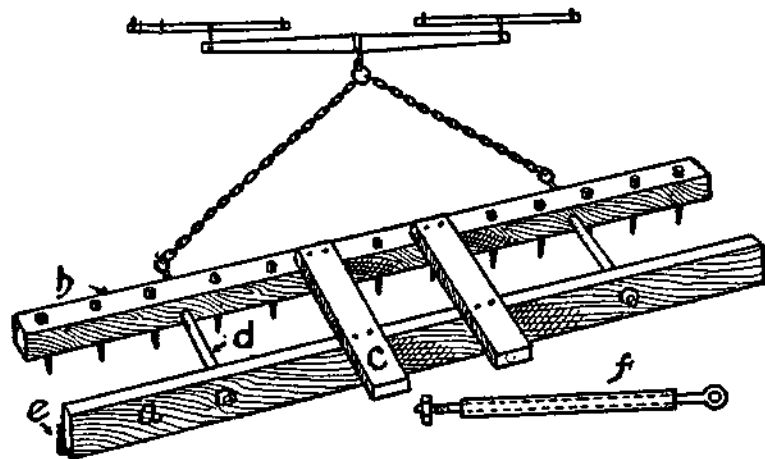
is tightly bound. Then a small rope that is kept tied in end of the horizontal pin is tied to the binding rope and the pressure is held. Each pin is  $3\frac{1}{2}$  feet long. One is sharpened and the other has a  $\frac{1}{2}$ -inch hole bored through one end. Old fork handles are just the thing to make them of. One pin only may be made and a fork used to bind in the manner shown after the load is on.

---

Nothing is impossible to industry.—Periander.

## COMBINED DRAG AND HARROW

This road drag is all right. The front piece consists of a 4 x 4 oak strip, *b*, 10 feet long, through which are driven ordinary harrow teeth about 3 inches apart. This is attached to the rear piece, *a*, which is a 2 x 6 oak timber 10 feet long faced with



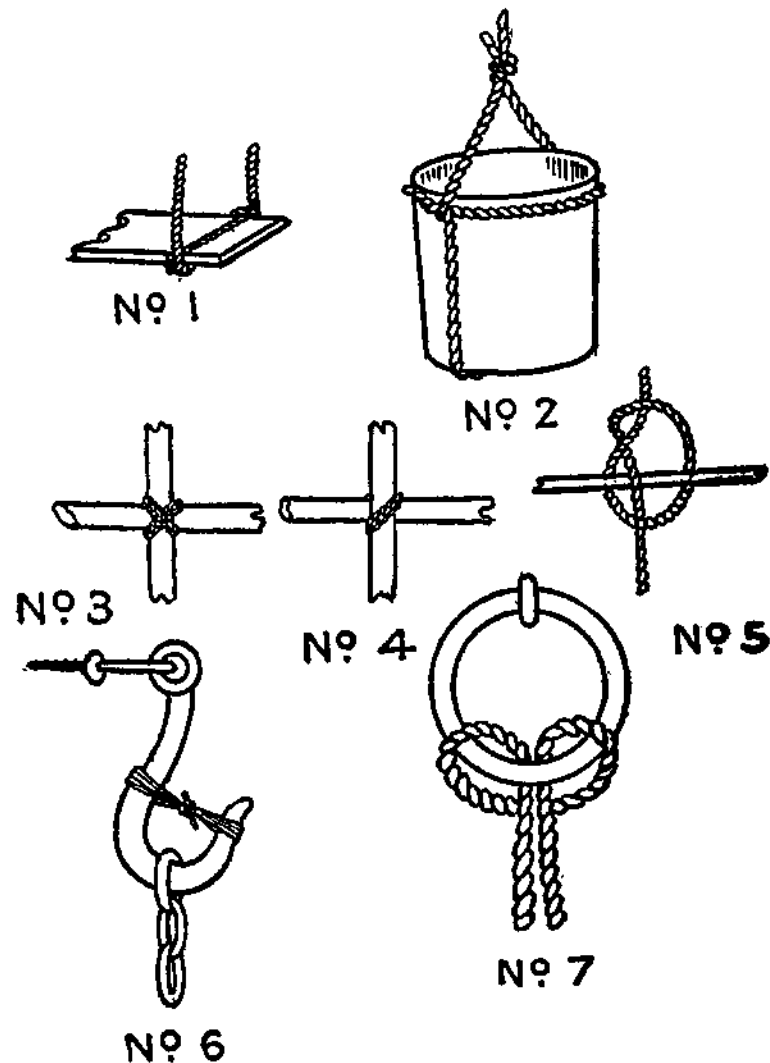
HARROWS AND LEVELS AT ONCE

3 inches of  $\frac{1}{4}$ -inch metal on the bottom, *e*, which projects 1 inch. These pieces are kept apart by wooden blocks, *d*, upon the bolts, *f*, and by the top strips, *c*, each 2 x 6. This makes a fine level road, as it harrows it and scrapes it at the same time.

## HOW TO HANDLE A ROPE

A rope is one of the most useful articles that are constantly needed about the farm; but too many farmers are not familiar with the many uses to which the rope may be put. The various sailors' knots may often be used to great advantage. To sling a plank for painting or other purposes make

a bight of rope as shown in Figure 1, bringing the rope entirely around the plank, so as to prevent its turning and throwing the workman down. One-half to  $\frac{3}{4}$ -inch rope is usually sufficient for all practical purposes. A hemp rope is more generally used and stands wear better than other kinds.



SOME ROPE HITCHES

A useful way to sling a can or pail from the end of a rope is shown in Figure 2. Prepared in this way the vessel is secure so long as the rope is not slipped off from the bottom. Secure the knot firmly at the top to allow no slipping and so that the pail may not become lopsided.

Scaffolding may often be erected by tying poles together as shown in Figure 3. This sort of lashing will not slip if made tight. In many cases a chain may be used as shown in Figure 4, in which case the weight should be on the side of the upright where the chain is lowest. All of these lashings must be drawn very tight so as not to allow any play, which may result disastrously.

An excellent hitch knot is shown in Figure 5, readily made, easily loosened and valuable for many purposes on the farm. This knot is readily untied by slackening up the drawing strand. It does not become tight and hard as many ordinary knots after heavy usage.

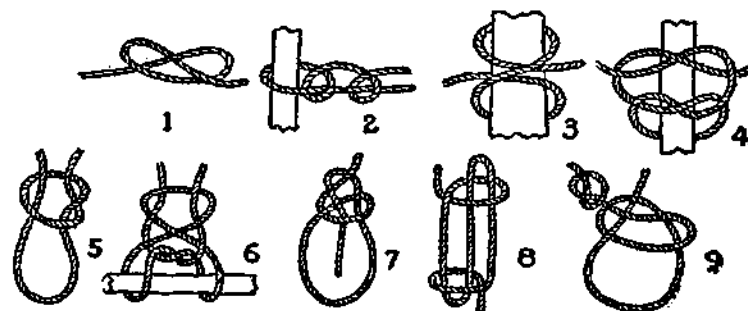
In many cases where heavy hooks are used they are liable to come unfastened unless a cord is affixed, as shown in Figure 6. A few turns of heavy twine or light wire in the middle will frequently prevent any loosening of the chain.

A ring hitch, shown in Figure 7, is a very effective and safe method, which may be made on short notice. The loose end of the rope is allowed to hang free or may be tied with a slip knot to the drawing strand.

### TYING SOME USEFUL KNOTS

A sailor judges knots for their holding qualities and also their ability to be quickly unfastened, without regard to the strain they have been sub-

jected to. A knot's main office is to hold, without working loose or slipping, yet they do occasionally fail absolutely to accomplish this, when made by inexperienced hands. The accompanying diagrams show some of the simpler knots that may be of everyday use. In these, the mode of formation can be readily discerned, because the rope's position is shown before tightening. The overhand knot, Figure 1, is probably the simplest of all. It is used only for making a knot at the end of a rope to keep it from fraying or to prevent another knot from slipping. If a slight change in formation is



A FEW GOOD KNOTS

made, as in Figure 5, it develops into a slip knot or, as it is sometimes called, a single sling, and its purposes are obvious. A double sling is represented in Figure 6, and though it is slightly more complicated, it is considerably more useful for any purpose where a rope is to be attached to a bar or beam and stand a steady strain.

Probably for convenience and emergencies no knots equal the bow-line, Figure 7, because it will not slip or give, no matter how great the tension; in fact, the rope itself is no stronger, and the instant the strain ceases it can be untied as easily as

a bow. When the end of a rope is to be secured, the two half-hitches or clove hitch, Figures 2 and 3, are of great importance, for either of these bends can be attached instantly to almost anything, and their holding powers are exceeded by none. The square knot, Figure 4, can be used for infinite purposes, from reefing a sail to tying a bundle, the advantage being, if made properly, of resisting any separating strain on either cord, and yet can be untied immediately by pulling one of the short ends.

One of the best and safest slip knots is shown in Figure 9, made with the overhand at the end, which, until loosened by the hand, maintains its grip. When a rope requires shortening temporarily the sheep shank, Figure 8, affords a means of so doing. This knot can be applied to any part of the rope without reducing its strength of rectilineal tension.

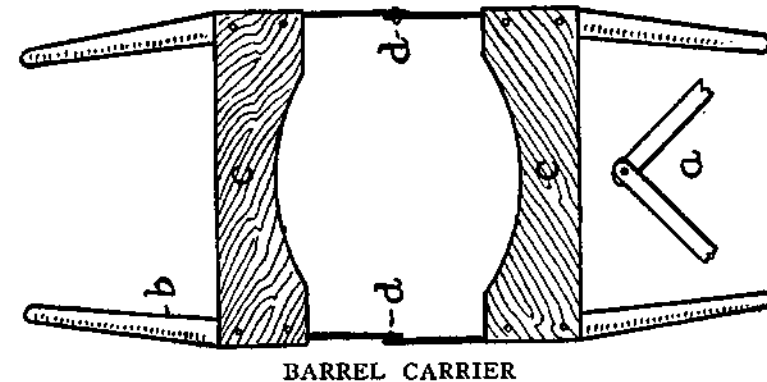
### CARRYING A BARREL MADE EASY

In the cities the ash collectors use a simple device, which farmers might make and often find handy, as barrels often become dried, weak and will not stand rough handling. The device is made of six pieces of wood; four pieces are about 2 feet long and 4 inches in thickness and width. Handles may be whittled on one end of each. About 10 inches from the other end, boards about 2 feet long and 8 inches wide are nailed as shown at *c, c*, in figure. Pieces *c, c*, are then cut in circular form so as to fit the outside of a barrel.

An old wheel tire may be straightened and four pieces cut to be fastened to the ends of each of the four handle pieces, as at *d*. These are then riveted

together so as to make hinges as shown at *d, d*. The tire need be only long enough to fasten securely to the handle pieces. Of course, the blacksmith should drill holes in them, that they may be securely riveted.

To use this device, drop it over the barrel. One man lifts on the two front handles and another



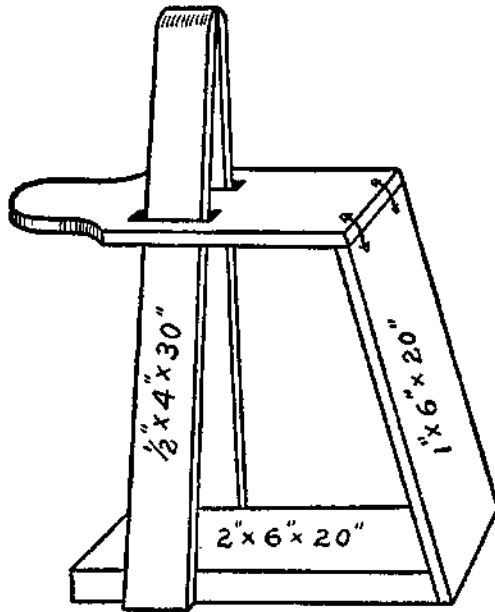
man on the rear handles. Boards *c, c*, close up in circular form, just beneath the lowest hoop round the upper end of the barrel, and cling tightly. The barrel is then lifted and readily carried without jar to its contents or straining the barrel. Of course, if all the barrels on the farm are of uniform size, the device could be made without hinges, and the barrels headed up could be rolled on pieces *c, c*.

---

The best part of one's life is the performance of his daily duties. All higher motives, ideals, conceptions, sentiments, in a man are of no account if they do not come forward to strengthen him for the better discharge of the duties which devolve upon him in the ordinary affairs of life.—Henry Ward Beecher.

## HARNESS CLAMP

The accompanying drawing represents a very handy harness mender which anyone who can use



THE CLAMP

a saw and hammer can make in a few minutes. It is made of lumber of the dimensions indicated in the drawing. The clamp is tightened by the worker sitting upon the seat, which should extend at least 2 feet from the clamps. The drawing shows the device with a shorter seat than that. It would doubtless be better to have the seat extended to twice the length shown from the left of the clamps and to have the base extended in a similar manner, so that the device will not tip over too easily. The joint at the upper right-hand corner may be hinged with heavy wire run through holes and twisted together underneath, or real strap hinges of iron may be attached.

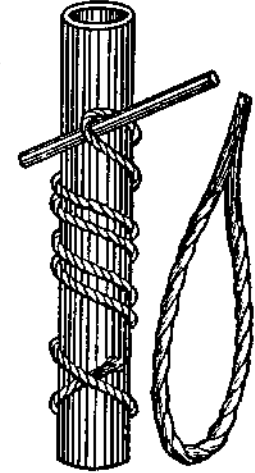
They who provide much wealth for their children, but neglect to improve them in virtue, do like those who feed their horses high, but never train them to the manage.—Socrates.

a saw and hammer can make in a few minutes. It is made of lumber of the dimensions indicated in the drawing. The clamp is tightened by the worker sitting upon the seat, which should extend at least 2 feet from the clamps. The drawing shows the device with a shorter seat than that. It would doubtless be better to have the seat extended to twice the length shown from the left of the clamps and to have the base extended in a similar manner, so that the device will not tip over too easily. The joint at the upper right-hand corner may be hinged with heavy wire run through holes and twisted together underneath, or real strap hinges of iron may be attached.

## SUBSTITUTE FOR PIPE WRENCH

The drawing shown here illustrates a useful device for twisting pipe off or on its connections.

Three or 4 feet of new rope is frayed out at both ends, which are put together and wound tightly around the pipe to be turned, so that the first coil twists over the loose ends and continues around the pipe, two or three times, ending in a loop, through which a bar of iron is slipped, to be used as a lever. This simple plan will be found very effective in ordinary requirements for the pipe wrench, and is worth a trial. A more durable wrench may be made by using wire instead of rope. The loop can be formed by closely twisting the ends of the wire with pincers. The rope is rather easier to handle because more flexible.



PIPE TWISTER

## MARKET WAGON CONVENIENCES

Farmers who regularly haul produce to market or deliver direct to customers will find the conveniences described to be of much value.

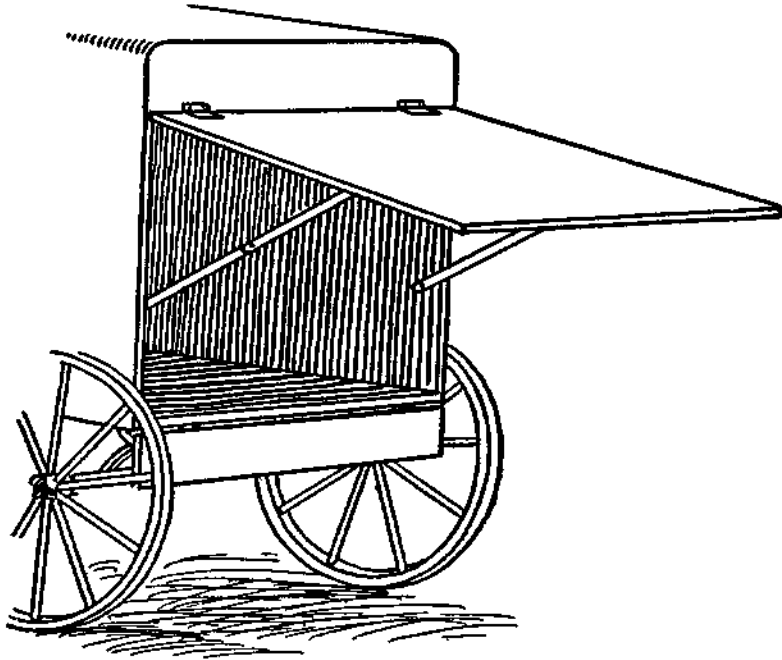


REIN CLIP

They save much time and considerable trouble and cost but little effort to make them. Instead of wrapping the reins about the whip, or letting them lie over the dashboard, a hook, such as shown in the first sketch, may easily be made of stiff fencing wire and secured to the top of the wagon or the dashboard.

Two other hooks may be arranged at the sides of the wagon to hold an umbrella, which would be kept there rain or shine, and never forgotten and left at home. This will save a drenching some time and perhaps some valuable produce.

Another convenience is a rear curtain of oilcloth stretched over a light board frame and hinged at



REAR SHADE FOR WAGON

the top, as illustrated. Two old stays from a buggy top will serve to support it, when it must be left open, and it will protect the driver from sun and rain while taking things from the wagon.

### CARRYING BUTTER TO TOWN

A refrigerator that one farmer uses in which he takes butter to town nine miles away in hot weather

is made thus: Get two clean, tight boxes of some odorless wood, one 12 x 15 x 13 inches deep, and the other 9 x 12 x 10 inches deep. Slip one inside the other with a notched block in each corner to hold the inside box in place. Fasten the covers together so as to leave an air space of about 1 inch between them all around. The inner box will hold 20 pounds of butter nicely. It will carry butter solid in wagon all day in 90-degree weather.

### TO SHARPEN SCISSORS

Do you know that you can sharpen scissors, and easily, by passing the blades over glass jars? Take a bottle or jar, make believe you are trying to cut it (have one blade in and the other outside of the top of the bottle) and then allow the scissors to glide off the hard surface naturally, just as if you were trying to cut the glass. Use firm but not too hard pressure, and repeat the operation several times.

### HOW TO PAPER A ROOM

If a room has been papered several times, tear off all the loose parts you can and with a sponge and water loosen what remains on the walls, removing as much as possible, so as to have a smooth, even surface. If the room has never been papered, first go over it and fill all large cracks and holes with a paste made of whiting and water, or plaster of paris and water. When using the latter, mix only a little at a time, have it rather thin, and use quickly. Then, give the room a coat of sizing, which is made of common glue, three or four handfuls dissolved in a pail of boiling water. The sizing is applied with a large brush and should be allowed to dry overnight.

### Choose Judiciously

For very sunny rooms, select cool-looking papers, such as blues, greens and browns in various shades,



HANGING WALLPAPER

while for dark rooms pinks, reds, terra cottas and yellows are best. When selecting papers, pay care-

ful attention to the color scheme of your room, and don't have an inharmonious mixture, which will offend good taste. Small, plain patterns are the most economical, and the easiest to match. The cheap, trashy papers, costing only a few cents a roll, are not worth the trouble of putting up. Gold paper is not to be recommended for wear.

No borders should be used for rooms having a low ceiling. For such, a striped paper of pretty design running right up to the ceiling is best. The ceiling may be papered in a plain or very small-patterned design, to harmonize with the side walls, or treated with several coats of tinted kalsomine or paint. A picture molding of appropriate color is used to finish the side walls, being placed scarcely 1 inch from the ceiling. The ceiling whether papered, painted or kalsomined, should be done first. It is a very difficult matter to paper the ceiling, and, unless you can have help, it would be better not to attempt it. Plain tints in paint or kalsomine are always pretty and in good taste. If, however, you want to risk papering the ceiling yourself, get some handy body to help you.

### Paste and Tools

The paste is made by simply boiling flour and water together, and adding a very little alum, salt and glue—about a tablespoon of each to a pound of flour. It should be of a consistency thick enough to apply easily, and not so thin that it will run.

Provide yourself with a good-sized paste brush, another one (a whitewash brush will do) to use dry over the paper, sharp scissors and a knife,



plenty of clean rags, two barrels, two long, smooth, clean boards, each about 10 inches wide, and a step-ladder.

Make a long table by placing the two barrels about 8 or 9 feet apart and on top of these the boards.

### Trimming and Cutting

The first thing to do is to cut the necessary number of strips of paper long enough to allow for waste in matching, and lay them all face downward on the "operating" table, one on top of the other. Next spread the paste evenly over the top or first strip of paper, being very sure to have the edges well pasted. Then turn top and bottom parts down, bringing pasted sides together, so that they meet, and none of the paste part is exposed, and carefully trim off edge on one side, with large, sharp scissors. Lift up the part thus trimmed and folded, and mount the ladder, which should previously have been placed convenient to the place where you intend to begin operations—the largest wall space is best, next to a door or window.

### Hanging the Paper

Now take hold of the top end which was doubled over (it will open and hang by its own weight) and adjust to its proper place on the wall. Then, with a large clean rag in your hand, rub downward, never up or sideways, and take great care to keep the edge straight. If you find that you didn't start straight from the top, loosen paper and do it over again. A "straight eye" is needed to do the work neatly. Don't rub too hard and always rub down-

ward, doing a little part at a time, and lifting paper occasionally, so that no air bubbles are left under it. When the upper part is done, dismount from ladder, undo the folded part at the bottom of the width, and proceed in the same manner to adjust to the wall. When you are sure it is on straight and smooth, trim with a sharp knife along the base-board. Then give the strip another smoothing by going all over it again with a dry, clean brush. Proceed in this way until all the full length parts are covered, and then match in the small spaces over and below windows and doors. All the matching must be done with great care.

### Practical and Economical

Wainscoting in living or dining rooms are nice, and very practical, especially where there are small children. For this purpose burlap, or the less expensive dark, heavy papers that come in wood-grain imitation are good. Matting is sometimes used with very good effect, too. A narrow wooden molding is used to finish the top of the wainscoting, and in that case the work of papering the side walls is so much easier, the lengths being short.

### THE FARM BLACKSMITH SHOP

A blacksmith shop is of immense practical value on a farm. To those who have one it is almost as essential as live stock, farm tools and crops. One does not need to be a professional blacksmith. The elementary practice in welding, upsetting and tempering is easily learned with a little practice. Nor is it necessary to have many tools. An entire equipment may cost but a few dollars.

An old railroad rail will do for an anvil. But after getting the real article one is better satisfied and can do the work with greater ease. The forge should be obtained at the start. With it almost anyone can heat any small iron to welding point with as much ease as a regular blacksmith.

In the equipment of an Ohio farmer are a pair of tongs that he made himself, two other tongs and a large pair of pinchers picked up in a junk shop. He got the hammer and sledge from a hired man who had worked in a car shop. The anvil and vise also came from the junk shop, and both were in good repair. These cost \$8, the hammer and sledge, \$1.15, and an old, second-hand forge, \$1.80. Not a large outlay to be sure, but a wise expenditure. If purchased at first hand the cost would be greater, but cheap at any price when you consider what you can do in the way of making and repairing with such a list of blacksmith tools.

In addition to the above list this man, Frank Ruhlen, has chisels, pinchers, fullers and other small tools, all of which he has made out of old pieces of steel taken from old worn-out machines. By figuring and planning just a little, any farmer can make the greater part of his own tools and at a very small cost for materials and labor.

### Why the Shop Pays

Mr. Ruhlen says: My shop was not started to replace the town blacksmith shop; and it will never do so. But it does serve for repair work, and it saves many trips to town. It is helpful in other ways, also. Last winter a sudden ice spell came on, so severe that I could not get the horses out to the field to feed the flock. Only one thing was

possible: to have sharpened shoes put on the horses. But it was a disagreeable trip ahead to walk and lead the horses to town; so I decided to do the work myself. I had never set a shoe myself, but that trip before me quickly decided. The horses were brought into the shop, the old shoes pulled off and sharpened, and within an hour the feeding was done. Had I gone to town for the work it would have required time going and coming, and then, maybe a long wait ahead for my turn at the shop.

Last year I sharpened the shoes on the corn planter, and both cultivators, six shovels each. We wore out a steel point or shear, and never had it to shop but once, and then it was to get a new nose or point. I do not try to put steel points on anything, as it is too particular work for anyone who just picks tools up when something breaks. A sharp harrow is a luxury on most farms, because the average smith does not draw the teeth out enough, and they are dull in a few days.

And I do not believe the average smith can harden the farm tools as good as a farmer who has had some experience in tempering, as the farmer is the one who works with the tools, and soon learns when they are too hard or not hard enough. I sharpened my smoothing harrow last year before we commenced on our corn crop of 64 acres, used it on all the land, on some more than once, and my harrow is sharper now than my neighbor's, who paid \$1.50 at the shop for the same work. We never use a dull mattock or pick now as we did before we had a forge. Welding chains, making chain hooks, open rings, clevises, are all easy to do on rainy days. I could not tell all the different uses I make of my shop.

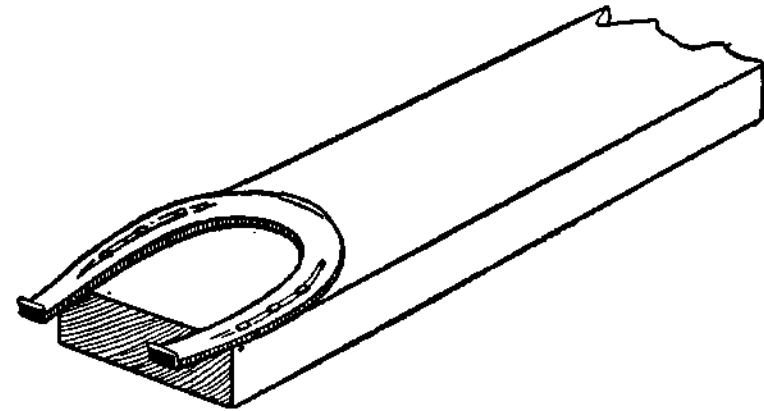
## Blacksmithing Not Hired Man's Work

I do the work in the shop myself, finding other chores for hired men. You cannot afford to break them in, for the reason that they may soon leave and all the teaching and trouble would be for nothing. By doing the work myself, I have learned a little more each year, have acquired the knack of it, and really enjoy doing what is to be done. Had we had a shop when I was a boy all of the repair work could have been done by the boys, and I would at the same time have had splendid training for my own needs now.

My experience is all in favor of the shop on the farm. It pays well. Get the forge first, and then gradually add other tools as you can. I used a claw hammer for some time before getting a smith's hammer. I did not equip my shop all at once. Start in a small way, build up gradually, learn slowly, and the shop will develop itself. Get a shop, and you will believe in it because of its help to you.

### HORSESHOE LEVER

A handy lever for prying up boxes or barrels may be made by nailing an old horseshoe on the end of a 2 x 4, letting the ends of the horseshoe extend about an inch or two beyond the end of the timber. A more finished device may be constructed by cutting the upper part of the lever down to the form of a rounded handle. A horseshoe should be selected with fairly long and well-sharpened heel calks.



HORSESHOE FOR A TOOL

### HOW TO PAINT TIN ROOFS

Remove all rosin and other loose substances from seams and have roof clean. Paint immediately after laying is finished; do not allow the tin to rust—you coat the base plate with tin and lead to prevent rust, and paint the finished goods to prevent oxidation of the coating. Use only the best red or brown oxide of iron, mixed with pure linseed oil all raw, or half raw and half boiled. Use litharge only as a drier. Litharge makes paint adhere hard to coating, so that when thoroughly dry you cannot scrape it off. Don't use any turpentine or patent driers.

Apply all paint with hand brushes and rub in well. This is very important. Don't put paint on thick—one coat that covers well, and is thoroughly rubbed in, is better than three put on thick. Let roof stand two weeks to a month before applying second coat. Six months or so after applying second coat put on a third coat. After this you do not have to paint roof more than once every two or three years. Too much paint injures a tin roof.

Keep paint well stirred up; put on thin and rub well in. By following these directions you will have a roof that will last many years.

### PRESERVING WOOD

Creosote, or sulphate of copper or iron, are effective for preserving wood. There are objections, however, to their use for floorings or ornamental woodwork. Creosote leaves a permanent, disagreeable smell. The sulphates discolor the wood. Borax is excellent for keeping wood from decay. The preparation of it is simple, and consists in immersing the wood in a saturated solution of borax, which is then heated to 212 degrees Fahrenheit. The wood is left for 10 or 12 hours, the time depending upon the density and size of the pieces of wood. When taken out, the wood is stacked until dry, then reimmersed in a weaker solution of the borax for a brief time, dried again, and are then ready for use. Boards thus prepared are practically indestructible from rot, and are nearly incombustible.

Another preservative is a compound of one part silicate of potassa and three of pure water—the wood to remain in the solution 24 hours, then dried for several days, then soaked and dried a second time and afterward painted twice with a mixture of one part water-cement and four of the first-mentioned mixture. Thus prepared, it will not decay in the ground, and will be incombustible out of it.

Another process for preventing decay of wood is by use of a paint which possesses the advantages of being impervious to water. It is composed of 50 parts of tar, 500 parts of fine white sand, 4 parts

of linseed oil, 1 part of the red oxide of copper in its native state, and 1 part of sulphuric acid. The tar, sand and oil should be first heated in an iron kettle; the oxide and acid are then added very carefully. The mass is thoroughly mixed and applied while hot. When dry, this paint is as hard as stone.

Decay in wood may be prevented by the following method: Take 20 parts of resin, 46 parts of finely powdered chalk, some hard sand, and a little linseed oil and sulphuric acid; mix and boil for a short time. If this is applied while hot, it forms a kind of varnish, thereby preserving the wood.

### TO PRESERVE SHINGLES

Following is an effective method to prevent the decay of shingles: Take a potash kettle or large tub and put into it one barrel of lye of wood ashes, 5 pounds of white vitriol, 5 pounds of alum, and as much salt as will dissolve in the mixture. Make the preparation quite warm, and put as many shingles in it as can be conveniently wet at once. Stir them up with a fork, and, when well soaked, take them out and put in more, renewing the preservative solution when necessary. Then lay the shingles in the usual manner.

After they are laid, take more of the preservative, put lime enough into it to make whitewash, and, if any coloring is desirable, add ocher, Spanish brown, lampblack, or other color, and apply to the roof with a brush or an old broom. This wash may be renewed from time to time.

Salt and lye are excellent preservatives of wood. Leach tubs, troughs and other articles used in the

manufacture of potash never rot. They become saturated with the alkali, turn yellowish inside and remain impervious to the weather.

### TO RENDER WOOD FIREPROOF

Rendering the woodwork of houses secure against catching fire can be done at an insignificant cost, and with little trouble. Saturate the woodwork with a very delicate solution of silicate of potash as nearly neutral as possible, and when this has dried, apply one or two coats of a stronger solution.

Another method is simply to soak the wood with a concentrated solution of rock salt. Water-glass will act as well, but it is expensive. The salt also renders the wood proof against dry rot and the ravages of insects. Still another method is to immerse the wood in a saturated solution of borax, heat being gradually applied until the solution reaches 212 degrees Fahrenheit. It is then left for 10 or 12 hours, according to the nature and size of the wood.

### FIREPROOF WASH FOR SHINGLES

A preparation composed of lime, salt and fine sand or wood ashes, put on like whitewash, renders the roof 50 per cent more secure against taking fire from falling cinders, in case of fire in the vicinity. It pays the expense a hundredfold in its preserving influence against the effects of the weather. The older and more weather-beaten the shingles, the more benefit derived. Such shingles generally become more or less warped, rough and cracked; the application of the wash, by wetting

the upper surface, restores them at once to their original form, thereby closing up the space between the shingles, and the lime and sand, by filling up the cracks and pores in the shingle itself, prevents warping.

### PETRIFIED WOOD

Mix equal parts of gem salt, rock alum, white vinegar, chalk and Peebles' powder. After the mixture becomes quiet, put into it any wood or porous substance, and the latter becomes like stone.

### HOW TO SEASON WOOD

Boiling small pieces of non-resinous wood will season them in four or five hours—the process taking the sap out of the wood, which shrinks nearly one-tenth in the operation. Trees felled in full leaf in June or July, and allowed to lie until every leaf has fallen, will then be nearly dry, as the leaves will not drop off themselves until they have drawn up and exhausted all the sap of the tree. The time required is from a month to six weeks, according to the dryness of the weather.

### BLEACHING WOOD

Sometimes it is more feasible to bleach a small part of a wood surface, especially in repairing, than to darken a larger portion of the work. This can be done by brushing over the wood a solution composed of 1 ounce oxalic acid in a pint of water, letting it remain a few minutes and then wiping dry. The operation may be repeated if necessary. A few drops of nitric ether, or a quarter of an ounce of tartaric acid, will assist the operation; or

a hot solution of tartaric acid may be used alone. Lemon juice will also whiten most woods. Cut the lemon in half and rub the cut face upon the wood.

When the bleaching has been done and the wood is dry, give a thin coat of shellac or French polish, as the light and air acting upon the bare wood will bring back the original color.

If the wood obstinately resists bleaching, it may be lightened by mixing a little fine bismuth white, flake white or ball white (the cleansing balls sold by druggists) with the shellac, and give it a thin coat. This whitens, but it also somewhat deadens or obscures the grain and is, therefore, not so good as the bleaching method.

### WOOD POLISH

Rub evenly over the wood a piece of pumice stone and water until the rising of the grain is cut down; then take powdered tripoli and boiled linseed oil and polish to a bright surface.

### FURNITURE POLISH

Take equal parts of sweet oil and vinegar, mix, add a pint of gum arabic finely powdered. This will make furniture look almost as good as new and can be easily applied, as it requires no rubbing. The bottle should be shaken, and the polish poured on a rag and applied to the furniture.

### SIZE STAINS

By the aid of glue in the solution, the colors are fixed in size stains. They are employed for the

purpose of giving a color to cheap work in soft woods, such as chairs, bedsteads and common tables and ordinary bookcases. The colors usually wanted are walnut, mahogany, cherry color, oak and even a rosewood.

For Mahogany—Dissolve 1 pound of glue in a gallon of water, and stir in  $\frac{1}{2}$  pound venetian red, and  $\frac{1}{4}$  pound chrome yellow, or yellow ocher. Darken with the red and lighten with yellow, as desired. If the venetian red does not give a sufficiently dark look put in a pinch of lampblack. Apply hot.

For Rosewood—Same as mahogany, omitting the yellow, and using  $\frac{3}{4}$  pound venetian red (or more) instead of  $\frac{1}{2}$  pound. Give one coat of this and then add lampblack, one pinch, or more, to the color; with the latter put in the figure or dark parts of the rosewood.

For Oak—In a gallon of glue size (as above) put  $\frac{3}{4}$  pound powdered burnt umber. Lighten with yellow (chrome or ocher), if need be. Hot.

### DARK WOOD STAIN

White woods may be given the appearance of walnut by painting or sponging them with a concentrated warm solution of permanganate of potassa. Some kinds of wood become stained rapidly, while others require more time. The permanganate is decomposed by the woody fiber; brown peroxide of manganese is deposited, which afterward may be removed by washing with water. The wood, when dry, may be varnished, and will be found to resemble very closely the natural dark woods.

## RED STAIN FOR WOOD

Boil chopped Brazil wood thoroughly in water, strain it through a cloth. Then give the wood two or three coats, till it is the shade wanted. If a deep red is desired, boil the wood in water in which is dissolved alum and quicklime. When the last coat is dry, burnish it with the burnisher and then varnish.

## LIQUID GLUE

Dissolve 1 pound of best glue in  $1\frac{1}{2}$  pints of water, and add 1 pint of vinegar. It is ready for use.

## CEMENT FOR METAL AND GLASS

Take 2 ounces of a thick solution of glue, and mix it with 1 ounce of linseed-oil varnish, and half an ounce of pure turpentine; the whole is then boiled together in a close vessel. The two bodies should be clamped and held together for about two days after they are united to allow the cement to become dry. The clamps may then be removed.

## CEMENT FOR BROKEN CHINA

Stir plaster of paris into a thick solution of gum arabic till it becomes a viscous paste. Apply it with a brush to the fractured edges, and draw the parts closely together.

## CEMENT FOR CROCKERY AND GLASS

Take 4 pounds of white glue,  $1\frac{1}{2}$  pounds of dry white lead,  $\frac{1}{2}$  pound of isinglass, 1 gallon of soft water, 1 quart of alcohol, and  $\frac{1}{2}$  pint of white

varnish. Dissolve the glue and isinglass in the water by gentle heat if preferred, stir in the lead, put the alcohol in the varnish and mix the whole together.

## MENDING GLASSWARE

Broken dishes and glassware may be easily mended as follows: Fit the pieces in their proper places and tie a string around the vessel to keep the parts from slipping out. Then boil the entire dish for two or three hours in sweet milk. This will firmly glue the vessel together and it will last for years with proper care.

## ARMENIAN CEMENT

This will strongly unite pieces of glass and china, and even polished steel, and may be applied to a variety of useful purposes. Dissolve five or six bits of gum mastic, each the size of a large pea, in as much rectified spirits of wine as will suffice to render it liquid; and, in another vessel, dissolve as much isinglass, previously a little softened in water (though none of the water must be used), in French brandy or good rum, as will make a two-ounce vial of very strong glue, adding two small bits of gum galbanum of ammoniacum, which must be rubbed or ground till they are dissolved. Then mix the whole with a sufficient heat. Keep the glue in a vial closely stopped, and when it is to be used set the vial in boiling water.

## JAPANESE CEMENT

Thoroughly mix the best powdered rice with a little cold water, then gradually add boiling water until a proper consistence is acquired, being par-

ticularly careful to keep it well stirred all the time; lastly it must be boiled for one minute in a clean saucepan or earthen pipkin. This glue is white, almost transparent, for which reason it is well adapted for fancy paper work, which requires a strong and colorless cement.

### ROOFING PREPARATION

Take 1 pint of fine sand, 2 of sifted wood-ashes, and 3 of lime ground up with oil. Mix thoroughly, and lay on with a painter's brush, first a thin coat, and then a thick one. This composition is not only cheap, but it strongly resists fire.

### FIRE KINDLERS

Take 1 quart of tar and 3 pounds of resin, melt them, bring to a cooling temperature, mix with as much sawdust, with a little charcoal added, as can be worked in; spread out while hot upon a board, when cold break up into lumps of the size of a large hickory nut, and you have, at a small expense, kindling material enough for one year. They will easily ignite from a match and burn with a strong blaze, long enough to start any wood that is fit to burn.

### MENDING PIPES WITH WATER ON

Many farmers have had trouble in repairing pipes where the water could not be shut off conveniently. A lead pipe which has been cut off accidentally in making an excavation, for instance, may be repaired by the following plan: The two ends of the pipe are plugged, and then a small pile of broken ice and salt are placed around them; in five minutes the water in the pipe will be frozen, the

plugs removed, a short piece of pipe may then be inserted and perfectly soldered. In five minutes the ice in the pipes may be thawed and the water set to flowing freely again.

### TO JOIN WATER PIPES

Water pipes may be united by using a preparation made by combining four parts of good portland cement and one part of unslaked lime mixed together in small portions in a stout mortar, adding enough water to permit it to be reduced to a soft paste.

### WELDING METALS

Welding together two pieces of metal of any kind can be accomplished only when the surfaces to be joined are equally heated, and both surfaces must be brought to such a temperature that the particles will form a perfect continuity between the pieces united. This embraces the entire theory of welding, soldering or brazing metallic substances of any kind. In addition, however, to the equal and adequate heating of the surfaces to be united, every particle of coal dust, cinders or scales of oxide must be removed, so as to present two perfectly clean surfaces at the very moment when the union is to be effected.

The piece of metal that would fuse at the lower temperature must be the guide, when bringing the surfaces of conjunction up to the proper heat. If, for example, two pieces of wrought iron are to be welded, the part that will melt at the lower temperature must be brought just to a welding heat, and the surface of the other piece must be heated quite



as hot, or a trifle hotter than the first piece. Then, if the surfaces are clean when the parts are brought together, the union will be satisfactory. The degree of heat aimed at must be, not to produce a fluid, but simply to bring the metal into a condition between the fluid and plastic.

## GRINDING TOOLS

All steel is composed of individual fibers running lengthways in the bar and held firmly together by cohesion. In almost all farm implements of the cutting kind the steel portion which forms the edge, if from a section of a bar, is welded to the bar lengthwise, so that it is the side of the bundle of fibers hammered and ground down that forms the edge. So, by holding on the grindstone all edge-tools, as axes, scythes and knives of strawcutters, in such a manner that the action of the stone is at right angles with the edge, or, this is to say, by holding the edge of the tools square across the stone, the direction of the fibers will be changed, so as to present the ends instead of the side as a cutting edge. By grinding in this manner a finer, smoother edge is set, the tool is ground in less time, holds an edge a great deal longer, and is far less liable to nick out and to break.

Plane irons should be ground to a level of about 35 degrees—chisels and gouges to 30. Turning chisels may sometimes run in an angle of 45. Molding tools, such as are used for ivory and for very hard wood, are made at from 50 to 60 degrees. Tools for working iron and steel are beveled at an inclination to the edge of from 60 to 70 degrees, and for cutting gun and similar metal range from 80 to 90.

## INDEX

	Page		Page
<b>A</b>			
Angles, Measuring.....	34	Carrier, Barrel .....	260
Angles, Plotting.....	35	Carrier, Yoke .....	163
Anvil, Mounting.....	246	Cart for Stock.....	91
Anvil, Rail .....	10	Catch, Gate.....	181
Ax Handle, How to Secure.....	15	Catcher, Pig .....	105
<b>B</b>			
Bag Holder.....	110, 111	Cellar, Concrete Outdoor .....	227
Balance for Weighing .....	107	Cellar, Temporary.....	74
Barn Driveway.....	115	Cellar Shelf, Revolving.....	77
Barn Plans .....	200	Cellar Stairs, Hint for.....	82
Barn, Round.....	198	Cellar Wall, Concrete .....	225
Barn, Small.....	202	Cement Block House.....	195
Barn Stairs.....	105	Cementing Cistern Wall .....	230
Barn Truck.....	109	Cements for Mending.....	280
Barn Windlass.....	108	Cement, Mixing for Brick.....	223
Barrel Carrier.....	260	Cement, Special Uses for.....	231
Barrel Coolers.....	60	Chain Tie .....	87
Barrel Coop.....	120	Cheese Making.....	52
Barrel Cradle .....	46	Cheese Press.....	52
Barrel Hoop Trellis.....	132	Chicken Catcher.....	126
Barrel Plant Holder.....	72	Chicken Coop, Box .....	121
Bars with Horseshoe Support .....	181	Chicken Coop, Portable.....	123
Bee Feeder .....	130	Chicken Fountain .....	118
Bee Hives.....	127	Chicken Roosts .....	118
Beeswax Extractor.....	129	China Cement.....	280
Bench, Corn Husking .....	112	Cistern Wall, Cementing.....	230
Bicycle for Power.....	55	Clamp, Harness .....	262
Binding Pins for Hay.....	255	Cleaning a Well .....	66
Bin for Vegetables.....	72	Closet for Toilet Articles.....	76
Bins, Grain.....	109	Closet, Outdoor .....	63
Bin, Hinged Grain.....	108	Clothes Box .....	48
Blacksmith Shop, Farm.....	269	Clothes Horse .....	76
Bleaching Wood.....	277	Clothes Line Elevator.....	75
Boat, Boxed Stone.....	157	Cold Frames.....	140
Bolts, Use for.....	16	Concrete Anvil Foundation.....	246
Box for Clothes .....	48	Concrete Block Machine.....	218
Box for Potatoes.....	248	Concrete Blocks.....	217
Box for Tying Fleece.....	97	Concrete Cellar Wall.....	225
Box Wheelbarrow .....	240	Concrete Mixing.....	216
Brace Rule .....	23	Concrete Floor.....	229
Bread Cutting Board.....	59	Concrete On the Farm.....	214
Brooder .....	123	Concrete Outdoor Cellar.....	227
Brooder, House.....	124	Concrete Reinforced with Wood.....	231
Bridge, Small.....	160	Concrete Reinforcement.....	224
Building, House.....	189	Concrete Smokehouse.....	229
Butchering Derrick.....	100	Concrete Walk.....	230
Butchering Rig.....	98	Cooker, Tank .....	243
Butter Wagon Refrigerator.....	264	Cooler in Well .....	62, 64
Butter Worker.....	51	Cooler, Water.....	60
<b>C</b>			
Cabbage Cutter .....	114	Coop, Barrel .....	120
Calf Stanchions.....	87	Coop, Box.....	121
Camping Tent.....	171	Coop, Portable Chicken .....	123
Cans, for Scoops.....	49	Coop, Trap Door .....	121
		Corn Crib, Wire.....	211
		Corn Drying Rack.....	236
		Corn Husking Rack.....	112
		Cottage Plans.....	193
		Cow Stall.....	84

	Page	G	Page
Cow Stanchions .....	86		
Cows, How to Stake Out .....	92		
Cows, Stalls for Kicking .....	88		
Cradle, Barrel .....	46		
Crate, Vegetable .....	248		
Crows, How to Scare .....	126		
Cultivator, Hand Garden .....	142		
Cutter, Feed .....	112		
Cutter, Seed Potato .....	248		
Cutter, Root .....	113		
Cutter, Vegetable .....	114		
<b>D</b>			
Dam .....	161		
Derrick, Carcass .....	100		
Derrick, Portable Hay .....	154		
Ditching Scraper .....	160		
Dog Power for Pump .....	67		
Door Fastener, Stall .....	186		
Door Fasteners .....	184		
Door Latch .....	188		
Doors, Glass Panels for .....	44		
Doors, Double Latch for .....	185		
Drag and Harrow Combined .....	256		
Dresser .....	41		
Drinking Fountain for Chicks .....	118		
Drinking Fountain, Poultry .....	117		
Drogue .....	159		
Dumb Waiter .....	37		
<b>E</b>			
Euclid, 47th Problem of .....	32		
Extractor, Solar Wax .....	129		
<b>F</b>			
Fastener, Stall Door .....	186		
Fasteners for Doors .....	184		
Feed Basket .....	83		
Feed Box .....	84		
Feed Box, Partitioned .....	93		
Feed Cutter .....	112		
Feed Hopper, Poultry .....	116		
Feed Rack .....	95		
Feed Rack, Portable .....	96		
Feeder for Bees .....	130		
Fence, Movable .....	183		
Fence, Over Stream .....	182		
Fence Wire Reel .....	155		
Filter .....	70		
Filter for Cistern .....	68		
Fire Alarm .....	80		
Fire Kindlers .....	282		
Fire Ladder .....	82		
Fireproofing Shingles .....	276		
Fleece Tying Box .....	97		
Floating Fence .....	182		
Floor, Concrete .....	229		
Floor, How to Lay .....	213		
Flowers in Barrel .....	72		
Fodder Rack .....	164		
Folding Table .....	50		
Food Cooler .....	60		
Fruit Picker .....	148		
Fruit Sorting Table .....	151		
Fuel, How to Haul .....	168		
Fumigating Seed Grain .....	254		
Furniture Polish .....	278		
<b>G</b>			
Garden Stool .....	144		
Gate, Adjustable .....	179		
Gate, Balanced Wire .....	175		
Gate Catch .....	181		
Gate Hanger, Adjustable .....	178		
Gate, Pole and Wire .....	176		
Gate, Sliding .....	177		
Gate, Suspended .....	182		
Gate, Turnstile .....	180		
Gate with Wheel .....	175		
Germination Box .....	250		
Glass Cement .....	280		
Glass in Doors .....	44		
Glue, Liquid .....	280		
Grain Bins .....	109		
Grain Box, Hinged .....	108		
Grain, Killing Insects in .....	254		
Grain Sack Holder .....	110, 111		
Greenhouses .....	208		
Grinding Tools .....	284		
Grindstone Rig .....	9		
<b>H</b>			
Hammer, Pulling .....	246		
Harness Clamp .....	262		
Harrow and Drag Combined .....	256		
Hay Derrick .....	154		
Hay Binding Pins .....	255		
Hawks, How to Scare .....	126		
Hawk Trap .....	126		
Hawks, Trap for .....	145		
Heat for Hotbed .....	138		
Heater, Lamp .....	57		
Heating Water .....	99		
Hen House .....	125		
Hitches, Rope .....	256		
Hives, Bee .....	127		
Hog Butchering Rig .....	98		
Hog House, Movable .....	102		
Hog Pens .....	104		
Hog Trough, Partitioned .....	102		
Holder, Grain Sack .....	110, 111		
Hoop Trellis .....	131		
Horse, Feed Basket .....	83		
Horse Feed Box .....	84		
Horse, Folding .....	12		
Horse, Shaving .....	12		
Horseshoes for Bars .....	181		
Horseshoe Lever .....	272		
Hotbed, Heat for .....	138		
Hotbed, How to Make .....	136		
Hotbed, Permanent .....	137		
House Building, Hints for .....	189		
House, Cement Block .....	195		
House, Plans for .....	190		
Houses, Hog .....	104		
<b>I</b>			
Ice House .....	204		
Ice House and Milk House .....	207		
Ice Molds .....	233		
<b>J</b>			
Jack, Log .....	170		
Jack, Wagon .....	238		

	Page	K	Page	L	Page	M	Page
Kettle Tripod .....	241			Ladder on Wheels .....	151	Mail Box, Trolley .....	71
Kindlers, Fire .....	282			Ladder, Place for .....	82	Market Wagon Conveniences .....	263
Kitchen Cabinet .....	39			Ladder, Truss .....	150	Measure, Land .....	167
Kitchen Cabinet at Window .....	43			Lamp Heater .....	57	Measuring Angles .....	34
Knots, How to Tie .....	258			Land Measure .....	167	Medicine Closet .....	76
<b>L</b>							
Lantern Hanger .....	106			Mending Water Pipes .....	282	Metal Welding .....	283
Latch, Door .....	188			Milk and Houses Combined .....	207	Milking Stool .....	88, 89, 90
Latch for Double Doors .....	185			Miter Box .....	24	Mold for Concrete Blocks .....	221
Lawn Mower Feed Cutter .....	112			Molds, Ice .....	233		
Level, Homemade .....	14			<b>N</b>			
Light, More for Rooms .....	44			Neck Chain for Cattle .....	87	Nests, Trap .....	119
Liquid Glue .....	280			<b>O</b>			
Loading Rig .....	164			Octagon Scale .....	23	Old Oak Bucket .....	232
Logging Bob .....	169			Outdoor Closet .....	63		
Log Jack .....	170			<b>P</b>			
Log Water Trough .....	244			Painting Tin Roof .....	273	Papering a Room .....	265
Logging, Rig for .....	168			Petrified Wood .....	277	Pickering Fruit .....	148
Lumber Rule .....	20			Plans, Barn .....	200	Plans for Cottage .....	193
<b>M</b>							
Mail Box, Trolley .....	71			Plans for House .....	190	Plant Protector .....	134
Market Wagon Conveniences .....	263			Platform for Pump .....	65	Porch, Vine-Covered .....	213
Measure, Land .....	167			Preserving Wood .....	274	Pig Net .....	105
Measuring Angles .....	34			Pipe Twister .....	263	Plotting Angles .....	35
Medicine Closet .....	76			Plow, Snow .....	241	Pole and Wire Gate .....	176
Mending Water Pipes .....	282			<b>R</b>			
Metal Welding .....	283			Rack, Corn Husking .....	112	Rack, Fodder Hauling .....	164
Milk and Houses Combined .....	207			Rack for Corn .....	236	Rack for Hanging Feed .....	95
Milking Stool .....	88, 89, 90			Rack for Milking Stool .....	90	Rack for Preserves .....	38
Miter Box .....	24			Rack for Seed Corn .....	235	Rack, Portable Feed .....	96
Mold for Concrete Blocks .....	221			Rack, Water for Hens .....	117	Rafters, How to Lay Out .....	28
Molds, Ice .....	233			Reel, Clothes .....	76	Reel, Wire on Boat .....	156
<b>N</b>							
Neck Chain for Cattle .....	87			Reel, Wire on Wheels .....	155	Refrigerator .....	64
Nests, Trap .....	119			Reinforced Concrete .....	224	Rein Clip .....	263
<b>O</b>							
Octagon Scale .....	23			Reservoir, Storage .....	167	Right Angles, How to Figure .....	32
Old Oak Bucket .....	232			Roller, Road .....	158	Rope, How to Handle .....	256
Outdoor Closet .....	63			Roof, Painting Tin .....	273	Roofing Preparation .....	282
<b>P</b>							
Painting Tin Roof .....	273			Roosts, Folding .....	118	Root Cutter, Saw .....	113
Papering a Room .....	265			Round Barn .....	198		
Petrified Wood .....	277			<b>S</b>			
Pickering Fruit .....	148			Saw Horse .....	170	Seasoning Wood .....	277
Plans, Barn .....	200			Seed Corn Rack .....	234	Seed Corn Trestle .....	250
Plans for Cottage .....	193			Seed Potato Cutter .....	248	Seed Sower .....	162
Plans for House .....	190			Seed, Watering .....	144	Separator, Run by Tread Power .....	56
Plant Protector .....	134			Scissors, How to Sharpen .....	265	Scraper, Ditching .....	160
Platform for Pump .....	65			Scoops from Tin Cans .....	49	Sharpening Scissors .....	265
Porch, Vine-Covered .....	213			Shaving Horse .....	12	Sheep Fence, Movable .....	183
Preserving Wood .....	274			Sheep Feed Trough .....	94	Sheds, Straw Covered .....	94
Pig Net .....	105			Shelf, Revolving .....	77	Shelter, Plant .....	134
Pipe Twister .....	263			Shingles, Preserving .....	275	Size Stains .....	278
Plotting Angles .....	35			Skidway .....	169	Slatted Stall .....	88
Plow, Snow .....	241			Slaughter House .....	99	Smokehouse, Concrete .....	229
Pole and Wire Gate .....	176			Smoking Device .....	243		

	Page		Page
Snow Plow .....	214	<b>V</b>	
Solder, How to Make .....	17	Vat, Butchering .....	98
Soldering .....	16	Vegetable Storage Bin .....	72
Sorter, Potato .....	246	Veranda, Vine-Covered .....	213
Sorting Table .....	151	<b>W</b>	
Sowing Machine .....	162	Wagon Jack .....	238
Square, How to True .....	26	Wagon, Market .....	263
Square, the Steel .....	19	Walk, Concrete .....	230
Stall for Cows .....	84	Wall, Cementing .....	230
Stains, Wood .....	279	Wall Paper, How to Hang .....	265
Stair Stringer, How to Lay Out ..	30	Washing Machine, Pedal Power ..	55
Stairs, Barn .....	105	Water Bottle, Poultry .....	117
Staking Out Stock .....	92	Water Cooler .....	60
Stanchions, Swinging .....	86	Water Filter .....	70
Stanchions for Calves .....	87	Water Filter for Cistern .....	68
Steel Square, Use of .....	19	Water Heating for Butchering ...	99
Stock Cart .....	91	Water Pipes, Mending .....	282
Stone Boat, Boxed .....	157	Watering Rack for Hens .....	117
Stool, Garden .....	144	Watering Seed .....	144
Stool, Milking .....	88, 89, 90	Water Stove .....	167
Stool Rack .....	90	Water Supply for House .....	77
Stove, Fence Around .....	47	Water Trough .....	244
Straight Edge, How to Make .....	28	Wedge Staple .....	15
Straw-Covered Sheds .....	94	Weighing Balance .....	107
Stream, Fence Across .....	183	Weight Lifter .....	237
Stump Pulling .....	166	Welding Metals .....	283
Surveying, Rule for .....	33	Well .....	Frontispiece
Suspended Gate .....	182	Well Cooler .....	62, 64
Swinging Sheep Trough .....	94	Well, How to Clean .....	66
<b>T</b>			
Table, Folding .....	50	Wheelbarrow .....	239
Table, Fruit Sorting .....	151	Wheelbarrow Sheep Trough .....	96
Tank Heater .....	243	Wheel Gate .....	174
Tent, Camping .....	171	Windlass, Barn .....	108
Testing Seed .....	250	Windlass for Butchering .....	98
Tool Grinding .....	284	Wire Gate .....	176
Tools Needed for Workshop .....	7	Wire Reel on Boat .....	155
Transplanting Large Tree .....	146	Wire Reel on Wheels .....	155
Trap for Owls .....	145	Wire Splicer .....	13
Trap, Hawk .....	126	Wire Tightener .....	155
Trap Nests .....	119	Wood Bleaching .....	277
Tread Power for Separator .....	56	Wood Fireproofing .....	276
Trees, How to Move .....	146	Wood, Hauling .....	168
Tree, Transplanting .....	147	Wood, How to Split .....	245
Trellis, Folding .....	132	Wood, Petrified .....	277
Trellis, Barrel Hoop .....	132	Wood Polish .....	278
Trellis for Beans .....	133	Wood, Preserving .....	274
Trellis, Iron Hoop .....	131	Wood, Seasoning .....	277
Trellis, Self-Supporting .....	134	Wood Splitter .....	245
Trolley Mailbox .....	71	Workshop, The Farmer's .....	7
Trough, Sheep .....	94	Wrench, Bit-Stock .....	11
Trough, Partitioned Hog .....	102	<b>Y</b>	
Truck for Barn .....	109	Yoke Crate Carrier .....	163
Truing the Square .....	26		
Tub Feed Box .....	93		
Turnstile Gate .....	180		

## Pioneer Methods

The "Good Old Days" were those of just recent decades past. In the 1800s and centuries previous the pioneer folk had it unimaginably difficult. People grew soft - and had no idea. City folk could not even begin to do the work of the real farmers who still ran small farms.

A US candidate for president once promised 40 acres and a mule. I always said that the only way I would have possibly made it through the first winter was to eat the mule. The pioneers were survivalists and had survival skills beyond any that we can imagine.

In addition to not having the "toughness", work habits and skills of the early pioneers - we do not have their resources. There are no buffalo herds and there is nowhere near that the deer and antelope play in sufficient number to support most survivors. Those who have taken survival courses that have taught them to go out into the woods and survive will be sorely disappointed. Such animals that have survived the radiation will be in very short supply relative to the survivors that would be in competition for them.

One will not have the horses, wagons or other implements that were necessary to pioneer survival. There will be a far larger population survive than there were pioneers a few centuries ago and there will be far fewer resources of the kind that sustained them. The early settlers of our village were confident in their ability to find in a few minutes enough fish in the stream to make supper. Even in my early days in the village a person could promise the night before that they would go out on the bridge out our back door and get fresh fish for breakfast - and make good their promise. But those days are gone. Fished out and poisoned out by salt on the roads and pesticide run-off from the farmer's fields. At this writing fish no longer come safe even from the farmer's markets without warnings that they are hazardous to expectant mothers.

No, we can't return to the old days - even if we want to. But fortunately we have many, many other advantages. We don't have to cut the forests to gain agricultural ground. We know many things the pioneers did not. Childbirth was a great hazard to pioneer women - simply because people did not know to wash their hands. We have a great advantage in modern knowledge - but we may well need to supplement that, at least for a while, with some of the pioneer knowledge and skills that we have forgotten about. That is the purpose of this page.

This page does not stand by itself, anymore than do any of the others. There may be some duplication on some items that will be found in the pages on simplified machinery and small farming but all that information will probably be just as important to know - if not more so.

The files on this page are all locked until after the nuclear war. Those who have to wisdom to gather the information ahead of time will have to go to other sources but all these pages can be thought of as a

checklist of types of information one may wish to gather together.

## Table of Contents:

### [SEALED: Making the Best of Basics.](#)

This is a SEALED 188 page .pdf file that won't be opened until after The Great Catastrophe. This 1975 book is by James Talmadge Stevens. It covers sprouting, food drying, game cleaning, recipes for different home products and a variety of similar subjects.

### [SEALED: Cloudburst - Handbook of Rural Skills and Technology.](#)

This is a SEALED 126 page .pdf file that won't be opened until after The Great Catastrophe. The book is edited by Vic Marks and is Published in the US by: Cloudburst Press of America, Inc. 2116 Wetern Avenue, Seattle, Washington 98121 and in Canada by: Cloudburst Pres Ltd., Mayne Island British Columbia V0N 2J0 - The book covers a variety of technologies including overshot and undershot waterwheels, juice presses, beehive management, cheese making, a hand operated washing machine, a solar drier, and many other things.

### [SEALED: Cloudburst Two.](#)

This is a SEALED 128 page .pdf file that won't be opened until after The Great Catastrophe. This is a second volume of the above book and is also edited by Vic Marks and is Published in the US by: Cloudburst Press of America, Inc. 2116 Wetern Avenue, Seattle, Washington 98121 and in Canada by: Cloudburst Pres Ltd., Mayne Island British Columbia V0N 2J0 - This volume covers a many, many additional technologies including various forms of construction, hand and foot operated machinery, kilns, hydraulic rams, spinning wheels, looms and associated machinery, and many, many other pioneer subjects.

### [SEALED: Foxfire One.](#)

This is a SEALED 388 page .pdf file that won't be opened until after The Great Catastrophe. This series of books is edited by Eliot Wigginton and is published by Anchor Press | Doubleday 501 Franklin Avenue - Garden City, NY 11530. Volume One covers many subjects from hog dressing to cabin building.

### [SEALED: Foxfire Two.](#)

This is a SEALED 410 page .pdf file that won't be opened until after The Great Catastrophe. This series of books is edited by Eliot Wigginton and is published by Anchor Press | Doubleday 501 Franklin Avenue - Garden City, NY 11530. Volume Two covers many subjects from midwifery to burial.

### [SEALED: Foxfire Three.](#)

This is a SEALED 512 page .pdf file that won't be opened until after The Great Catastrophe. This series of books is edited by Eliot Wigginton and is published by Anchor Press | Doubleday 501 Franklin Avenue - Garden City, NY 11530. Volume Three covers many subjects from animal care to hide tanning and making musical instruments.

**SEALED: Foxtire Four.**

This is a SEALED 480 page .pdf file that won't be opened until after The Great Catastrophe. This series of books is edited by Eliot Wigginton and is published by Anchor Press | Doubleday 501 Franklin Avenue - Garden City, NY 11530. Volume Four covers many subjects from gardening to traps to knife making and horse trading.

**SEALED: Foxtire Five.**

This is a SEALED 515 page .pdf file that won't be opened until after The Great Catastrophe. This series of books is edited by Eliot Wigginton and is published by Anchor Press | Doubleday 501 Franklin Avenue - Garden City, NY 11530. Volume Five covers many subjects from iron making and blacksmithing to gun making and hunting.

**SEALED: Foxtire Six.**

This is a SEALED 513 page .pdf file that won't be opened until after The Great Catastrophe. This series of books is edited by Eliot Wigginton and is published by Anchor Press | Doubleday 501 Franklin Avenue - Garden City, NY 11530. Volume Six covers many subjects from shoe making to wooden locks and toy making.

**MENU: [HOME](#) » [Reconstruction](#) » [Recovery](#) » [Renewal](#) » [Survival](#)**

---

---

# The Renewal of Religion After Nuclear Holocaust

## Table of Contents:

### [Prolog: Why God would permit a nuclear war.](#)

Here there is given an answer to a question that will concern many. If God is All Powerful and All Good - then why would He permit a nuclear war?

### [Essays: Series of Religious Essays - Premises](#)

This is the introduction to the following series of religious essays. It contains the author's premises of religion but the premises are recommended for reading only by those who wish to discuss the subject of religion with him.

### [POP: Problems of Prophecy](#)

Here the author describes his own experiences in seeking true prophetic sources.

### [Four Souls: The Four Types of Souls](#)

An examination of the concept that there are four types of souls that helps one to determine their own type.

### [Four Paths: The Four Paths to Truth](#)

The Four Paths to Truth are the four paths that every seeker of truth must tread.

### [MGP: The Most Clear Proof](#)

"The Most Great Proof", is a step by step examination of the largest, most important and most accurate prophecy ever given.

### [Seven Churches: From the Book of Revelation](#)

This is essay discusses the The Seven Churches (mentioned in the Book of Revelation) and

presents what many people find as an astounding explanation.

## **Ocean: The Revealed Word of God available as NEVER before!**

The most marvelous source for searching religious writings starting with the Judaic Tradition. It includes the Old Testament, Gospel, Koran, Baha'i Scripture and many, many others. Over 900 books at the time of this writing. I have spent many hundreds of dollars over the years for the best search programs I could find but none have been nearly as good as this one - and it is FREE.

## **Meditation: and The Path of Prayer**

A discussion of prayer and meditation along with some special Baha'i prayers and a rare translation of a Chant by Abdu'l-baha.

## **Stars: Prophecies in the Stars**

Astrological predictions, as regards individual day to day events, are a superstition. Nevertheless, many people feel that there have been notable signs in the heavens, such as that regarding the Bethlehem Star and the birth of Jesus. Here we examine a more recent and even more astounding phenomena, the fulfillment of an ancient tradition in the Millennium Star.

[Click here to return to the top of this Table of Contents](#)

[Click here to return to the top of the Main Front Page](#)

---

## **Why God Would Permit a Nuclear War**

In times of great stress some people turn naturally to God. Others question how He could exist and permit the tests, trauma, terror, that they are witnessing or experiencing. The Problem of Pain and evil has always been a challenge to every theological thinker. Some see it as the central question of religion and the human experience.

The questioners ask, "How could an Infinite, All Powerful God, that is Good, permit something like a nuclear holocaust?" "Never mind that Armageddon was predicted in centuries old religious prophecy. That is just another problem", they would say, "because if it was foretold and unavoidable, then what does that do for human free will?"



Man's search for Reality and his relationship to God, is the purpose of human life. These then are not just troubling questions, but central questions, in a sense the ultimate questions with which the seeker must wrestle.

It is unlikely that the present writer will answer, satisfactorily for all, that which centuries of religious volumes have failed to communicate unto the majority of mankind. Namely, that God is Good and that His Purpose is being worked out. Still, I will share with you my own thoughts about why the world wide nuclear war was both inevitable and necessary. Because of its inevitableness, some readers will note that at the time of this writing I speak of it as having been a thing that has already occurred.

First one must wrestle with the nature of God and Man. The Creator and the Creature. The Uncreated and the created. The One Being Infinite the other being finite. The One Being beyond time, space, matter, the other involved in the appearance of time, space, matter. However one views it, maya, illusion, duality, it still seems to be a relationship of opposites.

Because of infinite difference in station between the Creator and the created the only way that the latter can come to know The Former is in the manner and to the degree That Former chooses to reveal Itself to the latter. All the Great Divinely Revealed Religions have said that this has been through a Messenger, Prophet, a Chosen One. It is to Them that every reasonable thinker turns for the answers. No reasonable man would think that he could figure out the great ideas of literature, art, mathematics, or science all on his own - and how much less religion, that is to say the proper practice of his relationship to the Nature and Purpose of God and His Creation.

Thus it is that we turn unto Those Infinite Source of Light. Single in Purpose multiple in appearance, Who have come unto man to reveal God's Divine Purpose. Without exception we are told that God loves man and wishes him well. We are told further that God has bestowed many great bounties upon man, to a degree not shared by any other creature. Particularly the bounty of intellect and abstract thought and the bounty of free will. It is this latter that permits man to choose to recognize and serve God - or not.

The two capacities, intellect and will, the ability to know God and to worship (that is serve) Him, are the two defining characteristics of the human soul. They are what make a man a man. If a person loses the ability to think, reason, imagine, believe, then they are no longer in the human state but have entered a vegetative state. Likewise if they no longer have the capacity to desire, wish, feel, love or hate, then they have no more motivation than a rock. But the two capacities together - that which we think and that which we wish - that which we know and that which we will - are what defines each of us individually. That is who we are. Our very existence. When those capacities depart from the body - the body is dead and then decomposes. The Prophets have all told us that the essence - the ability to know and will - continues on separate from the body and that is why the soul is said to be eternal.

If either of these two faculties, either the ability to think / know / reason, or the ability to will are removed or subverted in man - then he ceases to exist as man. For this reason all men have the freedom and choice to believe in God - or not. If the idea, thought, knowledge of God was simply imprinted upon

them as the recognition of its mother is imprinted upon a baby chick - then man too would be a mere creature of instinct having no more free will to accept or reject God than an automaton or computer programmed with certain facts in its data base and memory.

Likewise, should man not have the freedom to sin, that is to say - to not do the Will of God, then again he would be but an automaton, a robot, a creature completely controlled by instinct and patterning. It is this freedom of being able to recognize and know God combined with the degree of choosing whether or not to be obedient to His Will - that defines and separates the saints, sinners, and satans.

Individually, and collectively, man exhibits and implements these two abilities. We are all individually a product of our genes, culture, and free will. The innate capacities between individuals differs greatly. Those innate capacities are then greatly affected by the education which they receive, which is something that is often largely culturally determined. Nurture versus nature is not a choice because it is nurture, nature AND free will that determines the individual accomplishment. The least of men, have the capacity to recognize God and to be obedient to Him, otherwise they are deprived of that which is truly human. The degree that they do recognize and obey God under adverse circumstances such as genetic or social deprivation may well be indicative of hidden spiritual strengths and qualities. God alone can be the Judge of that.

Nations and cultures to a large degree form individuals - but individuals also change and form cultures. Those who most positively affect the direction of a cultural should be duly honored. Unfortunately, cultures can likewise be affected negatively by other individuals. The collective conscience and consciousness is a mighty force to be dealt with. The overall direction and pattern of development, however, has a Divine Destiny. The Creation remains the purview of the Creator.

To return to the question of why evil and disaster occur. In part it is because there is an interplay between humanity and the rest of creation. Spiritual forces do interact and effect the actions of nature. This is a natural interaction, indeed designed by the Creator, and so to say that some of these natural events are "acts of God" is not far wrong - but the degree to which they are precipitated by human action is hidden from most of mankind.

Other events, such as war, depression, conflict, are more obviously the result of the actions of men. Still, we may ask, as to why God permits them to occur. The answer is that to prevent them would be to violate the principle of the Permissive Will of God which is to allow man to have his own free will. To subvert the free will of man would do more harm than good, because it would mean that man was no longer free and no longer man - but simply again as an automaton or rock.

The human race has long endured, and its destiny has long been seen. To say this does not subvert the free will of man. To give an example, most any elementary school teacher can see in her pupils the overall nature of the child, dullness to brilliance, willingness to rebelliousness, and although the teachers are sometimes surprised or disappointed, in later life, seeing the pupil's development - most often they are not. How many an insightful person can look at the habits and behavior of a teenager and predict for

the disobedient sluggard a life of failure and for the industrious performer a life of accomplishment. These are hardly matters of prophecy. The seeds of the future are evident. So has it been with the human race as a whole. The Prophets of old were able to see the rebellious and warlike nature of man and to see that as he gained more scientific knowledge that his wars would increase in intensity and ferocity. Indeed the Infinite Divine Omniscience would see these things far beyond the ken of man.

To foresee something is not to will something. While God Wills the good of man just as parents will the good of their children whom they can see that they must allow to make their own mistakes. One must be careful in attributing to God some anthropomorphic "motivation" but nevertheless it is the nature that has been created in us that gives us what perception we have of the Divine attributes because we do see these in ourselves and in the creation about us.

Mankind collectively followed such a path of rebellion that a major magazine headlined on its cover years ago that God was dead. Materialism and immorality increased after that date, to such a degree, that it would probably have astounded even those editors. Man's greed and lack of concern for his fellowman grew by immense proportions as evidenced through those years of repeated billion dollar scandals in the business community and the ever increasing proportion of all production and wealth that went into weapons and the means of destruction.

Still, all of this was reflective of the free will of man to choose the Path of God or to choose his own unwisdom and ills. While the chosen path led to destruction, to prevent mankind from choosing it would have been to truly destroy mankind because it would have meant subverting the free will of man and man would therefore no longer have been man. But evil contains its own punishment. The results are as sure as the law of gravity. The headache and hangover follow the drunkenness and while the it is fair to characterize the results as Divine Chastisement and Retribution it still remains of man's own doing.

If it were not for the pain which is the punishment for sin and evil, then man would simply always continue in the path of his own destruction which is the turning away from the Purpose of God. Man's collective ills continued to mount until the Day of Destruction, the Day of Holocaust, the Day of the Great Catastrophe, the Day of Armageddon - all as long predicted and prophesized. If it had not been for That Day then nothing would have turned man back around and once again toward God and His Purpose which is the true happiness of mankind. Consequently, the worse thing that could have occurred was for That Day to not have come - for there to have been no nuclear war.

Some will observe that in addition to the shortcomings of man that I have cataloged, that religion itself has been a major cause of suffering and contention. This is quite true. Dogmatic religions of every stripe have increased man's hatred against man. Also the same can be said of rampant nationalism and racism. Those very things that many men have seen as the highest ideals - their love for their religion, country and culture have in their perverted form been the basis for hate. God loves all mankind and in every part of the world provided for his religious guidance but men perverted that love for man to hatred of those who do not share their religion, country or culture.

The ills of religionism, racism, and nationalism became deeply embedded in mankind as a whole and when these were topped with rampant materialism and immorality mankind was already in hell. The direction that mankind was taking was obvious for many centuries, indeed millennium, and the end results were therefore predictable. The solution was also seen and God has always provided mankind with guidance through His Prophets. The Prophet for this Day and Age has revealed to mankind God's Program for the solution of their ills and the establishment of the Kingdom of Heaven on earth - but it is up to mankind to implement the Plan. For God to do it for man would once again deprive man of his free will and thus destroy him as man.

The message for mankind's darkest hour is that God has created for mankind a Destiny that is very Great, if mankind will choose to accept it. For those who would like to discuss with me further this view of the future and this view of religion I welcome their contacting me. I would ask that you first examine [my premises of religion](#) and let me know of any points in which we differ so that we may have a mutual understanding of what we are discussing.

Peace and love,  
Bruce  
DawnSayer@webpal.org

Click here to return to the  
top of this  
[Table of Contents](#)

**MENU:** [HOME](#) » [Reconstruction](#) » [Recovery](#) » [Renewal](#) » [Survival](#)

---

---

# Premises of Religion

**I will be most gratified to correspond  
about these ideas  
with anyone who is interested in doing so.  
If you would like to correspond with me you may  
do so at:  
[DawSayer@webpal.org](mailto:DawSayer@webpal.org)**

---

**For anyone who would like to discuss religion with me -  
there are some points that I would like to first list -  
to determine if we agree.**

**If you do NOT agree about one of the following points -  
PLEASE let me know,  
and also WHAT your position is.  
Otherwise, anything that I might say  
would be wrongfully based upon the assumption  
that it would be understood in a particular way -  
and likewise I would be misunderstanding statements  
made by yourself.**

**I first list the points  
and then give examples  
so that you can hopefully  
clearly understand what I mean.**

**I call these first points "premises".**

**Premise One.**

**There is but One God (Creator) -  
(in the Universe, anywhere, anytime -  
in any manner of true concept.  
Beyond what we call space or time -  
or any other qualification that one might make  
to say that there is or could be any but**

**the One True God.)**

**Premise Two.**

**God is separate from His Creation.**  
(meaning that God the Creator is something different than the Creation and apart from it. The opposite belief, called "pantheism" being that He is in His Creation and that creation itself is god).

**Premise Three.**

**Both God and His Creation are Infinite (and Eternal) -**  
(meaning without end - beyond definitions of size, or limitations imposed by concepts of space and time).

**Premise Four.**

**God is Infinite Spiritual REALITY and Truth**  
(but mortal man is subject to illusions, and delusions, about the appearances of reality and truth.)

**Premise Five.**

**God being Infinite and men being finite -**  
men cannot comprehend God on their own.  
(This means that God has to make Himself known to man).

**Premise Six.**

**God makes Himself known**  
**through His Prophets and Revealed Word.**

**Premise Seven.**

**God, and His Creation, being Infinite -**  
means that there always has been -

**and always will be MORE for man  
to learn about God and His Creation.**

**As examples of the above (by the same number as the premises) -**

- 1. Many people in the past have been polytheists,  
and many in the world are still so today -  
but few avowed Christians, aside from Mormons,  
proclaim themselves to believe in more than one god.  
A great many people, indeed most people,  
actually have difficulty accepting that there is REALLY  
only one God and they make in their minds idols  
of other powers separate from God.**
- 2. The concept of God and His Creation being one,  
which is defined as pantheism,  
is more usually found among what we call  
New Age Religion.**
- 3. Most people do not really wrestle with  
or try to grasp the meaning of the concepts  
Infinite and Eternal.**
- 4. Again, the Mormons see God as a physical being,  
and that all is matter. Monality versus duality,  
like Infinite and Eternal, is another one of those concepts  
that many people have not really wrestled with.**
- 5. Man's relationship to God in that man  
is completely subservient to God  
offends a great number of people today -  
who feel that they can figure out anything  
through what they call "science"  
and that in reality God is unnecessary to them.**
- 6. Recognition of the Prophets  
and the Revealed Word -  
is almost anathema to many people today.  
Their view is, if Jesus existed,  
He was "just" a man -  
and that Scriptures are simply  
a collection of myths, ancient stories,**

**and outdated beliefs from early times.**

**7. On the other hand -  
many people hold an opposite view  
regarding Scriptures.  
They feel that they have in THEIR scriptures  
ALL knowledge and that there is none other.**

**Thus the Jews hold onto only the Old Testament - saying to Jesus -  
"What need have we of You. -  
We have Abraham and our Fathers (the Prophets).  
And the Christians are not about to accept  
Mohammad and the Koran,  
because they feel the Bible is the FINAL Word of God,  
although Jesus said -  
that He could not reveal unto them many things  
that they were incapable of understanding at that time.  
And the Moslems feel that the Koran is the Final Book -  
and that Muhammad was the "Seal of the Prophets" -  
so that they persecute Those Who follow Him.**

**In discussion with Christians,  
a beginning point often is that I say that  
Christians hold too small an idea of Jesus.  
In response to their question of how that can be -  
I respond:**

**1. Many Christians hold Jesus to be God.  
"The Father and I are One".  
If this is true,  
then with God being Infinite  
any comprehension about the nature of Jesus  
would then need to be Infinite also -  
and equally impossible to encompass  
as would it be impossible to encompass  
the understanding of God.**

**2. While many Christians will repeat phrases  
such as -  
"Under no other Name under heaven,  
shall man be saved,  
except through the Name of  
the Lord Jesus Christ" -**



**they do not really look at the immensity  
that we see today of the Galaxies -  
and comprehend what that means.**

**3. Many Christians in talking about Jesus  
place Him at one point in time and space -  
2,000 years ago on this single planet.  
THAT is a very limited idea.**

**The most difficult concept for most person's to comprehend about Baha'i-  
is what is meant by the term "Manifestation of God".  
This is most often where we need to begin -  
but I am willing to discuss instead any other issue  
that correspondents wish to discuss.**

**I welcome your emails.**

**Peace and love,  
Bruce  
[bruce@webpal.org](mailto:bruce@webpal.org)**

**MENU: [HOME](#) » [Reconstruction](#) » [Recovery](#) » [Renewal](#) » [Survival](#)**

---

---

**MENU:** [HOME](#) » [Reconstruction](#) » [Recovery](#) » [Renewal](#) » [Survival](#)

# Essays on the Problems and Power of Prophecy

by Bruce Beach

In these essays I describe some of my own experiences in seeking true prophetic sources. These essays and experiences were a series of an email newsletter and if you wish to get right to point that I was driving at - you can just skip to the last one, or even go on to the next series regarding the Four Paths to Truth.

If you have some suggestions or comments you would like to pass on to me about these pages you may do so at:

[DawnSayer@webpal.org](mailto:DawnSayer@webpal.org)

If you wish to enter into a discussion with me regarding religion - I highly welcome that. I have some [religious premises](#) that I would like you to review first, and let me know regarding any about which you disagree to help me better understand any points that you are making.

---

## The Essays

POP01 - [Mother Shipton](#)

POP02 - [Ouiji](#)

POP03 - [Plants One](#)

POP04 - [Plants Two](#)

POP05 - [Straight Arrow](#)

POP06 - [The Iching](#)

POP07 - [The Seeker](#)

POP07a - [My Declaration](#)

**MENU:** [HOME](#) » [Reconstruction](#) » [Recovery](#) » [Renewal](#) » [Survival](#)

---

---

**MENU:** [HOME](#) » [Reconstruction](#) » [Recovery](#) » [Renewal](#) » [Prophecy Directory](#)

# POP01 - Mother Shipton

If you have some suggestions or comments you would like to pass on to me about these pages you may do so at: [DawnSayer@webpal.org](mailto:DawnSayer@webpal.org)

---

**This POP (Power of Prophecy or Problems of Prophecy) series that I am presenting, shares some of my own experiences in that search.**

**Those who are not interested in the subject or who feel that they already Know ALL Truth or at least the source for all Truth will find it tedious, and probably will also feel that I am ill-informed. And those who feel that it is impossible to find Prophetic Truths will consider these accounts silly.**

**I have carefully investigated many claims of prophetic ability, and in the series I will be reporting on some of those investigations. I am beginning this series with my investigation of a famous prophetess by the name of Mother Shipton.**

**Mother Shipton was born Ursula Sontheil in 1488 in a cave beside the river Nidd in North Yorkshire, England. The location remains today as a popular visitor site, attracting great numbers of visitors annually.**

**Since 1641 there have been more than 50 different editions of books about her and her prophecies and a great amount of information about her can be found on the Internet.**

**Many people feel that many of her visions came true within her own lifetime and in subsequent centuries. Mother Shipton is said to have predicted important historical events**

**many years ahead of their time -  
the Great Fire of London in 1666,  
the defeat of the Spanish Armada in 1588 -  
as well as the advent of modern technology.**

**She is said to have even forecast her own death in 1561.  
She died in 1561.**

**Today many find her prophecies are still proving uncannily accurate.**

**She wrote her prophecies like poems  
and after the following poem**

**I present my own research about her -  
prior to the time of the Internet.**

**-----A Version of One of Her Poems-----**

**And now a word, in uncouth rhyme  
Of what shall be in future time  
Then upside down the world shall be  
And gold found at the root of tree**

**All England's sons that plough the land  
Shall oft be seen with Book in hand  
The poor shall now great wisdom know**

**Great houses stand in far-flung vale  
All covered o'er with snow and hail  
A carriage without horse will go  
Disaster fill the world with woe.**

**In London, Primrose Hill shall be  
In centre hold a Bishop's See**

**Around the world men's thoughts will fly  
Quick as the twinkling of an eye.**

**And water shall great wonders do  
How strange. And yet it shall come true.**

**Through towering hills proud men shall ride  
No horse or ass move by his side.**

**Beneath the water, men shall walk  
Shall ride, shall sleep, shall even talk.**

**And in the air men shall be seen  
In white and black and even green**

**A great man then, shall come and go  
For prophecy declares it so.**

**In water, iron, then shall float  
As easy as a wooden boat**

**Gold shall be seen in stream and stone  
In land that is yet unknown.**

**And England shall admit a Jew  
You think this strange, but it is true  
The Jew that once was held in scorn  
Shall of a Christian then be born.**

**A house of glass shall come to pass  
In England. But Alas, alas  
A war will follow with the work  
Where dwells the Pagan and the Turk**

**These states will lock in fiercest strife  
And seek to take each others life.  
When North shall thus divide the south  
And Eagle build in Lions mouth**

**Then tax and blood and cruel war  
Shall come to every humble door.  
Three times shall lovely sunny France  
Be led to play a bloody dance**

**Before the people shall be free  
Three tyrant rulers shall she see.  
Three rulers in succession be  
Each springs from different dynasty.**

**Then when the fiercest strife is done  
England and France shall be as one.  
The British olive shall next then twine  
In marriage with a German vine.**

**Men walk beneath and over streams  
Fulfilled shall be their wondrous dreams.  
For in those wondrous far off days**

**The women shall adopt a craze  
To dress like men, and trousers wear  
And to cut off their locks of hair  
They'll ride astride with brazen brow  
As witches do on broomstick now.**

**And roaring monsters with man atop  
Does seem to eat the verdant crop  
And men shall fly as birds do now  
And give away the horse and plough.**

**There'll be a sign for all to see  
Be sure that it will certain be.  
Then love shall die and marriage cease  
And nations wane as babes decrease  
And wives shall fondle cats and dogs  
And men live much the same as hogs.**

**In nineteen hundred and twenty six  
Build houses light of straw and sticks.  
For then shall mighty wars be planned  
And fire and sword shall sweep the land.**

**Footsteps will be seen in every room,  
Left by none other than the man on the moon.  
One man's heart shall be given to another,  
Blood shall be shared by sister and brother.**

**Voices shall rise in the land of the black,  
And the Holy Land shall come under attack.  
China will rise as some have foretold,  
But the wall that falls will not be so old.**

**When pictures seem alive with movements free  
When boats like fishes swim beneath the sea,  
When men like birds shall scour the sky  
Then half the world, deep drenched in blood shall die.**

**For those who live the century through  
In fear and trembling this shall do.  
Flee to the mountains and the dens  
To bog and forest and wild fens.**

**For storms will rage and oceans roar  
When Gabriel stands on sea and shore  
And as he blows his wondrous horn  
Old worlds die and new be born.**

**A fiery dragon will cross the sky  
Six times before this earth shall die  
Mankind will tremble and frightened be  
for the sixth heralds in this prophecy.**

**For seven days and seven nights  
Man will watch this awesome sight.**

**The tides will rise beyond their ken  
To bite away the shores and then  
The mountains will begin to roar  
And earthquakes split the plain to shore.**

**And flooding waters, rushing in  
Will flood the lands with such a din  
That mankind cowers in muddy fen  
And snarls about his fellow men.**

**He bares his teeth and fights and kills  
And secrets food in secret hills  
And ugly in his fear, he lies  
To kill marauders, thieves and spies.**

**Man flees in terror from the floods  
And kills, and rapes and lies in blood  
And spilling blood by mankind's hands  
Will stain and bitter many lands**

**And when the dragon's tail is gone,  
Man forgets, and smiles, and carries on  
To apply himself - too late, too late  
For mankind has earned deserved fate.**



**His masked smile - his false grandeur,  
Will serve the Gods their anger stir.  
And they will send the Dragon back  
To light the sky - his tail will crack**

**Upon the earth and rend the earth  
And man shall flee, King, Lord, and serf.  
But slowly they are routed out  
To seek diminishing water spout**

**And men will die of thirst before  
The oceans rise to mount the shore.  
And lands will crack and rend anew  
You think it strange. It will come true.**

**And in some far off distant land  
Some men - oh such a tiny band  
Will have to leave their solid mount  
And span the earth, those few to count,**

**Who survives this and then  
Begin the human race again.  
But not on land already there  
But on ocean beds, stark, dry and bare**

**Not every soul on Earth will die  
As the Dragons tail goes sweeping by.  
Not every land on earth will sink  
But these will wallow in stench and stink  
Of rotting bodies of beast and man  
Of vegetation crisped on land.**

**But the land that rises from the sea  
Will be dry and clean and soft and free  
Of mankind's dirt and therefore be  
The source of man's new dynasty.**

**And those that live will ever fear  
The dragons tail for many year  
But time erases memory**

**You think it strange.  
But it will be.  
And before the race is built anew  
A silver serpent comes to view**

**And spew out men of like unknown  
To mingle with the earth now grown  
Cold from its heat and these men can  
Enlighten the minds of future man.**

**To intermingle and show them how  
To live and love and thus endow  
The children with the second sight.  
A natural thing so that they might  
Grow graceful, humble and when they do  
The Golden Age will start anew.**

**The dragon's tail is but a sign  
For mankind's fall and man's decline.**

**And before this prophecy is done  
I shall be burned at the stake, at one  
My body singed and my soul set free  
You think I utter blasphemy  
You're wrong. These things have come to me  
This prophecy will come to be.**

-----  
**My mother-in-law, who lived to be 90,  
during the whole of her adult life,  
was a gatherer of newsprint curiosities.  
These amounted to many thousands of items  
which in her retirement she spent many hours,  
days, weeks and months in sorting.**

**I gathered together empty cereal boxes,  
covered them in various shades of wall paper,  
and lined the walls of a room with shelves  
to aid her in her task.  
Eventually, I purchased over ten thousand dollars  
of microfilming equipment**

**and hired three ladies for a summer  
to microfilm all the material she had categorized.  
There is sufficient resource in  
the material for several books  
and I may someday donate it to a library.**

**In reviewing this material on prophecy  
I found a number of versions  
of the poem by Mother Shipton.  
This raised my curiosity  
as to which version was correct  
and so I made a trip to Chicago and  
visited the Central Public Library on Michigan Avenue  
where I inspected the listings in the main catalogue.**

**Some references to rare books  
led me from one librarian to another  
until I reached the chief librarian  
who gave me a letter of introduction to the  
Rare Books Archives located on the north side of Chicago.**

**Because of the lateness of the hour  
I hailed a cab and informed the driver of my hurry,  
which in retrospect proved to be an erroneous and incautious act.  
I thence braced myself between the seats  
and endured with white knuckles and clinched teeth  
the most horrifying ride of my life.  
This from one who has flown upside down in fighter jets,  
ridden with high speed police escorts,  
survived several auto crashes, and flown in antiquated aircraft  
through the air pockets of arctic storms.**

**Upon arrival the driver turned to me and said,  
"I thought you were in a hurry?"  
"But not to reach the next Kingdom", I replied.**

**The building before which I was deposited was  
an ordinary apartment house of a half dozen stories  
and indistinguishable from the dozens of others  
that lined the street.  
The front entrance was unlocked and the foyer empty  
so I passed through them**

**and a second set of doors into a gallery empty  
except for a single uniformed policeman who immediately halted me.**

**Upon my presentation of the letter of introduction  
he opened an elevator,  
pushed a button for another floor and sent me on my way.**

**When the elevator doors opened I found myself in a gallery  
similar to the first  
and again occupied by a single uniformed policeman.  
Once again my credentials were reviewed  
and then I was escorted through a set of doors  
to a receptionist who still again examined the credentials, interrogated me as to my purposes,  
relieved me of my overcoat and briefcase  
and finally led me away to a fish bowl sort of room  
surrounded on all sides by clear glass paned windows  
and in which there was but a single table and a single chair.**

**There shortly appeared another lady  
who took in detail my request  
and I was then left for another twenty minutes  
to examine my fingernails.**

**Upon her return she brought with her a stack  
of about a dozen old volumes  
and pointed out a button that I was to push  
when I was ready to depart.  
I was then left alone to examine the treasure.**

**The volumes before me were truly ancient.  
I am told that modern printing will not last near so long  
because of the sulfur content of the paper.  
The ages of the volumes spanned back over several centuries  
and the most recent of them leapt frogged back  
by many decades the earliest version that, until then,  
I had been able to find upon the subject.**

**I first arranged the volumes in the order of their antiquity  
and then set about to examine them.  
The earliest volumes were of course set in Old English type  
with the what appears to us as the f for s symbols,  
and the quality of handset type was of course quite different**

**from what we are used to today,  
as was also the nature of the prose.  
Nevertheless, an hour and a half of study  
afforded me numerous insights.**

**To my disappointment I found that in no case  
which I could determine were the prophetic references to events  
which have occurred  
printed prior to the occurring of those events.  
In these versions, in the ones that I had examined previously,  
and in the many that I have examined subsequently,  
there are often references to contemporary events  
not found in all the versions.**

**In the version above  
the lines starting from:**

**Footsteps will be seen in every room,  
to----  
But the wall that falls will not be so old.**

**are of my own creation.**

**About the only reference that I found consistent,  
was that regarding snow in the streets and on the housetops,  
a symbolic reference that does give one pause to think.**

**I do not wish to be totally disparaging about the poem  
for I do not feel that it is entirely without merit  
but I do feel that it is an excellent example  
of the caution with which one  
must approach these matters.**

**There is really little of benefit  
that can be communicated by prophetic writings  
to anyone who does not have a pure spirit of  
scientific inquiry and a mature method of historical analysis.**

**Much of what passes for education today,  
even from the universities,  
is pseudo scientific.  
The true spirit of inquiry**

**into the underlying reality of things is most often missing.  
The most advanced scientific thinkers  
and the most advanced religious and mystical thinkers are of a kin  
but their imitators dogmatically fall  
into the morasses of materialism and  
superstition, respectively.**

**I hope that I have not overly bored you  
with this meandering of a raconteur,  
and that you may be curious  
about some of the other experiences  
that I shall recount in this series.**

**Peace and love,  
Bruce Beach  
DawnSayer@webpal.org**

**MENU: [HOME](#) » [Reconstruction](#) » [Recovery](#) » [Renewal](#) » [Prophecy Directory](#)**

---

---

**MENU: [HOME](#) » [Reconstruction](#) » [Recovery](#) » [Renewal](#) » [Prophecy Directory](#)**

# POP02 - Ouiji

If you have some suggestions or comments you would like to pass on to me about these pages you may do so at: [DawnSayer@webpal.org](mailto:DawnSayer@webpal.org)

---

**This is a continuation of the POP  
(Power of Prophecy or Problems of Prophecy) series  
that I am presenting,  
in which I am sharing some of my own experiences  
in that field of search.**

**I had long researched in this area  
when my wife and I  
had occasion to stay overnight with friends  
on our way to Hollywood  
where I was to see my book agent.**

**While our hostess was preparing supper  
I took down one of a large number of 3 ring binder volumes  
that were on a shelf above the sofa on which we were sitting.  
There were numerous typed accounts  
with dates and names  
of great numbers of sessions with individuals.**

**Therein I read a dialog with a particular individual,  
in which it was foretold that he would die in an airplane accident.  
Hmmm, said I, to myself.  
Taking the volume I went out to the kitchen  
and addressed my hostess.**

**"What are these?", said I.**

**"Oh, those are Ouiji Board readings", said she.**

**"But we don't do them anymore", she continued.**

**(Knowing that I would know that it was dis-recommended  
by her current religion.)**

**"Hmmm", said I, "Would you happen to remember whatever happened to this particular individual?"**

**"Oh, he was killed in an airplane accident", said she.**

**I continued ---**

**"Really? That is what it says here will happen to him!  
I have often heard of Ouiji Boards but I have never seen one.  
Do you still have one?"**

**"Yes", she replied, "But we don't use it anymore".**

**"Well, I would like to see how it is done."**

**"Okay, I can show you after supper, but we won't do it ourselves, because like I said, we don't do it anymore."**

**(More philosophical discussion about its use and accuracy and then after supper my wife and I sit down with the Board between us, and direction from our host and hostess from across the room.)**

**"Put you hands on the device. Have your wife put her hands on yours. Say a prayer and call on the name of a Spirit Guide".**

**(I called upon the name of a well known Spiritual Leader, I might say a prophet (with a small p) that had ascended into the next world.)**

**"Now, start asking questions".**

**"Where are we going?"**

**(To my surprise the device began to spell out a word).  
SALEM.**

**(Now that was ridiculous. I knew there was a Salem Massachusetts and a Salem in the Carolinas where they had burned the witches, but we were in Utah and headed West. The OPPOSITE direction. So, how in the world was I going to end up in Salem? I asked.)**

**"How are we going to get there?"**



## **BY THE NORTHERN ROUTE.**

**(More ridiculous still. So it thought we were going to Massachusetts, but we were heading for Hollywood by the Southern route. I was now ready to reject this non-sense, so I asked a sarcastic question.**

**"Does this thing really work?"**

**YES, BUT YOU DON'T NEED IT.**

**(And so we had a good laugh about it and put the silly thing away).**

**Less than two weeks later,  
through a very odd set of events,  
we ended up without any choice  
in Salem, Oregon  
that I didn't even previously know to exist.**

**I took the VERY GOOD ADVICE  
(knowing the Source)  
and never used such a thing again.**

**In previous years,  
I had read books about phrenology,  
palm reading,  
tea leaf reading,  
crystal ball gazing  
and so forth,  
but this was my only personal experience  
or experimentation.**

**The problem with these things  
(and other things like drugs and channeling)  
is that they work -  
in the beginning.  
But eventually they lead you down a wrong path  
of dependence and ineffectuality.**

**I could go into much more detail about these matters,  
along with other subjects such as  
Brain Washing**

**Deprogramming  
and a variety of other phenomena  
but that is not the purpose of this presentation.**

**Common sense will tell you,  
if you look upon abusers of these phenomena  
(any use is abuse)  
that their practitioners benefit no more  
than alcoholics do from alcohol.**

**Practicing alcoholics BELIEVE they benefit from alcohol,  
as fortune tellers believe they benefit from fortune telling,  
but you only need to look at the quality of their lives.  
If they could really derive such benefits as they claim,  
they would pick the winning lottery tickets,  
or at least good investments in the stock market,  
and would live a much different lifestyle  
from than that in which one usually finds them in.**

**I only report this incident to you  
that you may know that I have traveled  
all these avenues.**

**Today I know many people, personally,  
who are dependent on astrology, channeling and such.  
I now have a large accumulation of evidence  
that it is not beneficial.**

**It is like trying alcohol or drugs.  
If you never take the first drink  
you will never become addicted.  
But like with smoking,  
it may be hard to get started,  
but it is a lot harder to stop.  
So, just don't do it.**

**Peace and love,  
Bruce Beach  
DawnSayer@webpal.org**

**MENU: [HOME](#) » [Reconstruction](#) » [Recovery](#) » [Renewal](#) » [Prophecy Directory](#)**



**MENU: [HOME](#) » [Reconstruction](#) » [Recovery](#) » [Renewal](#) » [Prophecy Directory](#)**

# POP03 - Plants One

If you have some suggestions or comments you would like to pass on to me about these pages you may do so at: [DawnSayer@webpal.org](mailto:DawnSayer@webpal.org)

---

**This is a continuation of the POP (Power of Prophecy or Problems of Prophecy) series that I am presenting, in which I am sharing some of my own experiences in that field of search.**

**This time I am going to write about something a little different. A scientific experiment, but at the end I hope you will see the relevance. I actually conducted three series in this area, the last with government funding but at this time I will tell you only about the first two series.**

**They are with a growth inducer and a growth retardant. I hope that you will carefully read the description of the method and see that it was a carefully controlled experiment. I, and many other hundreds of researchers, have done the same experiment and you are welcome to repeat it yourself.**

**First came the preparation of the subjects. We bought a dozen brand new aluminum pie pans taking them out of their original plastic wrapping so that we could be sure that none of them had been contaminated.**

**We then took bags of sterilized soil, purchased from the store, and put the soil in the pans, leveling it off at the top with the blade of a ruler so that we could be sure that every pan had the same amount of soil.**

**Next we drew a line through the middle of the soil in each pan and took red fingernail polish and painted the edge of the pan one-half way around on one side.**

**We used the fingernail polish so that it could not be erased or moved, and so that we could always tell which half was which half of the pan.**

**Next, in each pan, we put from the same seed packages, of non-hybrid seeds, two types of seeds - corn and bean, about two inches apart and two inches from the rim of the pan.**

**Because the pan was round and we measured the distance between each seed there were two longer rows toward the center with 5 seeds two inches apart then progressing outwards in each direction two other rows with 3 seeds and 2 seeds, for a total of 10 seeds on each side of the pan.**

**If you have the picture in your mind there were six rows in the pan with a total of 20 seeds and an imaginary line down the middle between the two longest rows. This was done exactly the same with each of the 12 pans.**

**Now we took a water sprayer and gave each of the pans the same number of squirts of water.**

**And then we took the fingernail polish and numbered each of the twelve pans. So far as we could tell, everything was now identical.**

**We then wrote the 12 numbers on separate identical pieces of paper, turned the papers upside down on a table and shuffled them as randomly as we could.**

**Then we called another person into the room and asked them to randomly select 6 of the pieces of paper, and the numbers of the pans on those pieces of paper we put in the control group.**

**Next we took two chess pawns, one black and one white, shook them behind and held out two hands, each one containing a pawn and saying which ever one the person selected that is the one that would receive the growth retardant. (They happened to select the dark one and so the red side of the pans with the fingernail polish received the retardant and the other side received the inducer).**

**The pans were then set on the table in front of the window, and each day they each pan received the same number of squirts of water all from the same water container and each day the pan on one end was removed and taken to the other end and all the pans were moved down one place in the row**

**so that each would receive approximately the same angle of light throughout the experiment.**

**The only difference was that twice each day, once in the morning and once in the evening the plants in the experiment received growth inducer on the plain side and growth retardant on the red fingernail polish painted side. The pans in the control group received nothing else than the measured squirts of water.**

**I hope that you will agree that this was a thoroughly controlled experiment. Now let me tell you the results.**

**Two weeks later, the 120 plants in the control group (6 pans with 20 plants) were all up one and a half to two inches tall. All healthy green looking - all very nice and even looking like a good farmer's field.**

**The plants that had received the growth inducer were however very sickly. Only about half had come up at all. Some of these had actually turned down and grown back down into the soil.**

**The plants that had received the growth retardant were, however, all there. Tall gangly and strange looking. Some over four inches tall - much taller than the control group.**

**What can we conclude from this experiment? Think about it.**

**That the growth inducer and the growth retardant had become mixed up?**

**That each side had received the opposite of what we intended?**

**This may all seem very off topic, but let me assure you that it isn't.**

**The reason will be given in my next email.**

**I just want to give you the time to think about the experiment.**

**Remember,  
our goal is to find, if we can, a true source of prophecy,  
and we have yet, many things to examine.**

**Peace and love,  
Bruce Beach  
DawnSayer@webpal.org**

**MENU: [HOME](#) » [Reconstruction](#) » [Recovery](#) » [Renewal](#) » [Prophecy Directory](#)**

---

---

**MENU: [HOME](#) » [Reconstruction](#) » [Recovery](#) » [Renewal](#) » [Prophecy Directory](#)**

# POP04 - Plants Two

If you have some suggestions or comments you would like to pass on to me about these pages you may do so at: [DawnSayer@webpal.org](mailto:DawnSayer@webpal.org)

---

**This is a continuation of the POP (Power of Prophecy or Problems of Prophecy) series that I am presenting, in which I am sharing some of my own experiences in that field of search.**

**Now, to explain what the growth inducer and the growth retardent were (in the previous email). They were prayer.**

**Yes, that is correct - PRAYER.**

**The plain side had received nothing else except prayer for its growth and the red side nothing else except prayer that it would not grow.**

**If you find this latter strange, please do remember that Jesus cursed the fig tree and that it withered.**

**And that such a prayer could be very effective against cancer, plagues of locusts and such.**

**But no matter, the experiment did go strangely, (the side receiving the prayer for growth - withering, and the side receiving the opposite - growing astoundingly strange). and later I shall explain to you why.**

**As I have said, these experiments, of the Power of Prayer on Plants, (there is a book by that name) have been conducted at Red Stone University, and elsewhere (I think perhaps Duke) and I know at the University of Wichita, because I later did them there myself.**

**The experiments have been thoroughly controlled**



**and there is no statistical possibility that the results are attributable solely to chance.**

**POP this time stood for the Power of Prayer on plants, but we shall get around to the relationship between prayer and prophecy.**

**My interest in prayer had been long standing. I am a class taught student of the Massachusetts Metaphysical College which is the training received by Christian Science Practitioners. I had already served as a volunteer War Time Minister, and although I am no longer a Christian Scientist I still have a deep respect for its teachings and can give many testimonies to its effects.**

**Thus it was, at that time, I approached the Botany Department at the University of Wichita and asked permission to repeat my experiments there. I was granted use of the entire green house, and with the aid of the Department Chairman undertook the experiments on a much grander scale.**

**We emptied and scrubbed the green house. New flats were obtained along with wheel barrows of sterilized soil. The Chairman insisted that we use hybrid seeds known for their consistent response and even growth. A planting device was devised to assure that all were planted at the exact same depth. A more accurate watering method was stipulated, and so forth.**

**I won't go into the details, but the end result was that we had rows and rows and rows of the most evenly grown plants that one might imagine.**

**To my mind the outcome was the result of the exact same cause that had contributed to the reversed results in the first experiment.**

**What in Christian Science is called mental malpractice.**

**I won't go into all the philosophical details,  
but there is good reason that Jesus said,  
"That whatsoever ye ask for secretly  
will be awarded to you openly."**

**Similar results had been reported in the Redstone experiments.  
What I think happened in the first case  
was that my former wife,  
who was quite distraught with me at the time,  
was present with the plants on the table all day long,  
and she was quite aggravated with me, them, and the experiment,  
and consequently the inverted result,  
as with much else in my life at that time.**

**In the University green house,  
many people made the trip down to the green house,  
having heard about the experiment,  
to laugh about it.  
Their cumulative mental influence  
and trust in the power of hybrid seeds  
far exceeded mine.  
Probably the world's most even crop ever.**

**Miracles are only miracles  
to the person for whom they occur.  
If by a miracle we mean the repudiation of natural law,  
there is no such thing,  
but rather there is application of supranatural (not supernatural) law.**

**Jesus said that if you have the faith of a mustard seed  
you can move mountains,  
but if one claimed this faith to a non-believer  
and they asked you to prove it,  
and you pointed at a mountain and prayed  
and it jumped into the sea  
they would simply say,**

**"You were just lucky that an earthquake came along right then."**

**From years of experience**

**I know the power of prayer.  
I am no longer a Christian Scientist  
but it doesn't make any difference who prays.  
The sun shines on all,  
and God loves all.**

**Many do not know how to pray effectively.  
Myself included.  
It has been said that God punishes us in two ways.  
Either by not answering our prayers,  
or by answering them.  
I really don't have the wisdom to know what is good.  
Jesus plead to be delivered from the cross,  
but in the end He said, "Thy will be done".  
And that is where I always end up at,  
because I never know that what I wish  
is necessarily what God wishes.**

**Even my grandchildren pray with more direct desire  
than I do.  
And I think that is well.  
When I have gone to Christian Science practitioners for help  
it has been immediately forthcoming for health problems  
and all sorts of other problems.**

**On two occasions I was so broke that I had not eaten for 3 days.  
Both times I immediately received more affluence than I had previously had in my life.  
On the one occasion the next morning.  
A very dramatic story, but I won't tell it  
and on the other some the next day  
but within two weeks I had in my pocket over fifty million dollars.  
Literally.  
A cashier's check for \$50 million dollars,  
plus a one hundred dollar bill that I took and placed with it,  
so that I could say that I had over \$50 million dollars  
in my pocket at one time.**

**There are MANY other things that I could tell you about,  
but once again miracles are only miracles to those to whom they happen.  
And I don't like relying upon Christian Science practitioners.  
It is sort of like relying upon the Ouiji Board.  
It works.  
But we don't need it.**

**We are supposed to walk these journey's on our own.  
Not that I am saying it is not good to pray with others,  
and to ask others for help with prayer when you need it,  
because that is a very good thing to do.  
But what I am saying is  
that I don't have it anywhere nearly all figured out as yet.**

**More to come.  
And it all does tie into the subject of prophecy -  
eventually.**

**Peace and love,  
Bruce Beach  
DawnSayer@webpal.org**

**MENU: [HOME](#) » [Reconstruction](#) » [Recovery](#) » [Renewal](#) » [Prophecy Directory](#)**

---

---

**MENU: [HOME](#) » [Reconstruction](#) » [Recovery](#) » [Renewal](#) » [Prophecy Directory](#)**

# POP05 - Straight Arrow

If you have some suggestions or comments you would like to pass on to me about these pages you may do so at: [DawnSayer@webpal.org](mailto:DawnSayer@webpal.org)

---

**This is a continuation  
of the POP series  
(Power of Prophecy or Problems of Prophecy)  
that I am presenting,  
in which I am sharing some of my own experiences  
in that field of search.**

**For a number of years  
after I left Christian Science  
(actually, I was excommunicated,  
when my former wife informed them  
that I had become a nudist -  
in my volley ball and sunshine days),  
anyway in those years following -  
I became a Buddhist.**

**Attended a Buddhist Church for about a year,  
and then got into Zen.  
(Traveled to temples in China,  
and all that sort of thing).  
Was much attracted to the teachings in a book called -  
"Zen and the Art of Archery".  
(Was also very much into Sufi,  
and other teachings -  
but I have never been that much of a purist -  
about anything).**

**For years, after moving beyond Buddhism,  
I continued to practice  
"Zen and the Art of Archery".  
Also taught my children.  
Rented a corner lot cat-a-corner across from the house,  
on the main corner of our village,**

**and set up an archery range with 4 target butts,  
of various distances, so 3 children and I could shoot  
at the same time.**

**Each of their special bows,  
sized as to weight, left or right hand, and so forth,  
still hang on our wall after years of usage.  
We sometimes attracted quite a crowd of onlookers,  
but I was never much of an archer.  
Wrong type muscles to properly pull a bow,  
and not really physically adept or coordinated  
at anything**

**But the idea of Zen,  
is not so much one of physical adeptness,  
as that of mental (actually spiritual) mastery.  
The question is -  
what guides your arrow?**

**The stories are numerous  
such as the old Zen Master,  
who sent the acolyte out to the garden  
to pin the target on a tree,  
and then shot the arrow through  
the Japanese papered wall of the house  
and the acolyte then goes back to the garden  
to find it implanted in the bulls eye.**

**Indeed, what is it that guides our arrow?  
After years of practice,  
I too felt that I was becoming somewhat adept.  
The arrows continuously landed in the bullseye.  
Finally I summoned wife to come and watch a demonstration.**

**I placed my arrow in the bow.  
Raised it to my chin and let it fly.  
It did something that it had never done before.  
It flipped out of the bow,  
tumbled forward and high into the air  
above the hill behind the target and to one side  
to come down on our dog who was lying peacefully there.  
Of all the places to land.**

**The dog was shocked.  
So was I.  
Fortunately it was a spent arrow  
and the dog wasn't hurt,  
but what had guided my arrow?  
A lack of humility.**

**There are two great tests for each of us in this life.  
Self and passion.  
Self is the greater test.  
Trying to serve God - without self.**

**"Oh, God, if I do this -  
how great I will be in Thy sight."**

**The Walter Mitty dreams always plague us,**

**"How great I will be".  
"How people will be astounded with me".  
"What great things I will have accomplished".**

**Getting beyond this is very, very difficult.  
We must learn to serve God -**

**Neither in hope of heaven  
Nor in fear of hell.**

**How willing are we to serve God?  
I have a test that I often give people.  
Look at the following choices -**

- a. Would you like to be rich and famous for serving God?**
- b. But what if you were given the choice,  
that you could provide some great benefit to humanity,  
and that while it would make you rich still,  
humanity would not recognize you for the benefit.**
- c. Or that you could provide some great benefit for humanity  
but that you would always be in great poverty.**

**d. Or that you would provide some great benefit to humanity  
but not only would you be in poverty  
and not recognized for the benefit  
but that people would revile and despise you  
because they did not recognize the benefit or that you were the source.**

**e. Or even that you came to understand  
that while what you suffered to do  
and for which you were reviled  
while it was a benefit to humanity  
while it was God's wish that you perform it  
that you would still go to hell.**

**At which level would you be willing to provide the benefit to humanity?  
If you think the latter case strange,  
you must remember that the Book says,  
"Even in hell will I set my angels to look over them",  
so some angels have to serve in hell.  
If that is where God wanted you to serve,  
is that where you would be willing,  
even want to go,  
if it were God's will?  
You say,**

**"You would want to go to hell?"**

**Indeed, I look at some of the hells on this earth,  
and there I find angels and saints looking after the inhabitants.  
Not my bit, I tell myself.**

**"Oh, Lord", I say,  
"deliver me from that!"**

**And probably he finds me unworthy (I hope)  
(that old self will)  
of that.  
But we never know.  
We will have to do that which we will have to do.**

**But, what does all this have to do with POP  
(the Path of Prophecy)?**



**Oh, my brother,  
Oh, my sister,  
if thou would's't step upon the Path  
thou must first purify thy soul,  
so that not the least trace of self or passion remains.**

**And thus it is  
that I am but an observer -  
and not a prophet.**

**Peace and love,  
Bruce Beach  
DawnSayer@webpal.org**

**MENU: [HOME](#) » [Reconstruction](#) » [Recovery](#) » [Renewal](#) » [Prophecy Directory](#)**

---

---

**MENU:** [HOME](#) » [Reconstruction](#) » [Recovery](#) » [Renewal](#) » [Prophecy Directory](#)

# POP06 - The Iching

If you have some suggestions or comments you would like to pass on to me about these pages you may do so at: [DawnSayer@webpal.org](mailto:DawnSayer@webpal.org)

---

**Through the decades  
I have conducted many classes  
on the subject of meditation.  
At one time traveling a circuit  
on weekends week after week  
through small communities  
where I had placed newspaper ads  
in Northern Ontario.  
Never have I charged a dime  
(nor taken a donation)  
for these courses.**

**At another time I had large classes  
in what was the then popular  
"free college movement"  
at a large university.  
There came to these classes  
week after week  
an individual who repeatedly pleaded with me  
to allow him to cast the I-Ching for me.  
I declined.**

**But, finally I agreed,  
on one condition -  
that it be cast in the dark.  
If you are not familiar with this method,  
it is similar to that related in the Book of Daniel  
where the king called in his astrologers and soothsayers  
and asked them to interpret his dream  
without his telling them what the dream was.**

**My fortune teller,  
was equally well astounded at my suggestion**

**(you must read Daniel to see the king's fortune tellers' response)**

**but at last he agreed to proceed.**

**What we did in this method,  
is that I wrote the question on a piece of paper,  
folded the paper so the question could not be seen  
or changed  
and placed it in the middle of the mat  
on which we were about to cast the I-Ching.**

**Assuming the traditional positions,  
and offering the traditional prayers,  
we began the process.**

**If you are not aware of how the I-Ching is cast  
I shall briefly explain the process.**

**A die is cast,  
and a marker is positioned.  
There are something like ten groupings  
of five each (as I remember).**

**The arrangement would look something like this:**

**10100\_\_11000\_\_00110\_\_01101\_\_11101  
11011\_\_01100\_\_01011\_\_00110\_\_10111**

**The actually arrangment of the ones and zeroes  
in the above example  
is coincidental.**

**I just picked them randomly as an example.**

**The thing to notice here is that there are two rows**

**The top row represents**

**HEAVEN**

**and the bottom row represents**

**EARTH.**

**Each of the groupings has an interpretative meaning,  
and the interpretations are given according to long tradition  
as found in Interpretative Books written about the I-Ching.**

**The actual position of the ones and zeroes,  
is determined in a ritualistically prescribed order  
by casting the die.**

**It takes a while to go through the whole process,  
but in the end here was our ACTUAL result.**

11111\_\_11111\_\_11111\_\_11111\_\_11111  
00000\_\_00000\_\_00000\_\_00000\_\_00000

**The getting of all the ones in a line  
and all the zeroes in another  
is the equivalent of flipping a coin  
and first getting fifty heads,  
and then getting fifty tails all in a row.**

**I was teaching statistics in the college  
and I can tell you that the probability of this happening  
is much, much less than than of picking all seven numbers  
in the lottery.**

**Now the real significance of this comes in regards to the question.  
Sort of like that quiz show on TV called Jeopardy  
where they give you the answer  
and you formulate the question.  
This was the answer.  
What was the question?**

**First to examine the meaning of the answer.  
In this answer  
all the ones in heaven  
means that heaven is ruling  
over all the zeroes on earth.  
I won't go into all the mystical significances.**

**But now we opened the paper  
so my fortune teller friend could see the question -  
It was -**

**"Is the Prophet that I am trying to teach you about  
the True Prophet?"**

**He never returned.**

**Peace and love,  
Bruce Beach  
DawnSayer@webpal.org**

**MENU:** [HOME](#) » [Reconstruction](#) » [Recovery](#) » [Renewal](#) » [Prophecy Directory](#)

---

---

**MENU: [HOME](#) » [Reconstruction](#) » [Recovery](#) » [Renewal](#) » [Prophecy Directory](#)**

# POP07 - The Seeker

If you have some suggestions or comments you would like to pass on to me about these pages you may do so at: [DawnSayer@webpal.org](mailto:DawnSayer@webpal.org)

---

**This letter in the POP series  
is the last one in which I will be talking about  
my own experiences.  
The next several should be much more interesting  
to you,  
because they will be talking about YOU.**

**My purpose in talking about my own experiences  
has been two fold.  
So, that you could know something about me, but,**

**While it is good to know the teacher,  
It is better to know thyself.**

**Secondly, I wanted you to know  
that I have examined many, many paths to Truth  
and while I won't say that there are any false paths  
some of them are very, very circuitous.  
I am hoping to show to you what I have found to be  
The True Path.**

**Many people send me all sorts of information today.  
And I am very appreciative to receive it.  
Information about all sorts of  
dreams  
visions  
prophets  
predictions  
and many other interesting things.**

**I have a very Fast Filter  
so I can deal with all of these very rapidly.**

**But the problem is  
that other people have fast filters also.**

**They say to me -**

**"Beach, do you believe X about \_\_\_\_\_ ?"**

**"And if you don't then you are  
wrong, wrong, wrong."**

**You can fill in your own words for the blank,  
but just yesterday some them would have been  
the Rapture  
the NWO  
Christ  
Resurrection  
Reincarnation  
and twice about the White Buffalo  
and twice about the Environment  
and one of the fellows wanted to be removed from the list  
because my answer was not the right one about the environment.**

**Many times too,  
the blank is about which church  
and this can be  
Catholic  
Mormon (LDS)  
or just Christianity itself.  
Millions of people out there  
have such fast filters  
that they would not even be on this list in the first place.**

**The real issue is not  
how FAST one's filter is,  
but how ACCURATE it is.  
Better accurate than fast,  
but we get so much information today  
that you need to be able to sort out what you are going to examine.**

**Here is a good test.  
You have a lot of experience in your life  
and have hopefully already sorted out lots of baloney.  
As a result you have developed a system of thought,**

**perhaps even a philosophy that you trust.**

**When someone comes with something new,  
then your natural and proper response is,**

**"How does this fit in  
with what I already know".**

**If the person has no idea of what you believe,  
then they can't explain their belief from your perspective.  
It just boils down to:**

**"I believe this - you believe that",**

**about superficial matters with no understanding of why.**

**Okay, so they have a great and complicated system,  
about physics or whatever,  
but they need to be able to put it in terms  
that you can understand.**

**It is a long journey to understand a complicated system  
but every journey must begin from where you are  
and in terms that you understand.  
That is the teacher's responsibility  
to meet you on the path at the point where you are.  
It is then your responsibility  
to take the next step on the path  
in which the teacher points.**

**If someone shows up at my door in the next few minutes  
and says:**

**"Beach, you are full of baloney,  
and I can prove it to you."**

**I will say,**

**"Welcome, welcome in.  
I have been waiting for you.  
What took you so long to come?"**



**Now, this person, to know that I am wrong,  
"full of baloney"  
is going to have to know what I believe.  
Otherwise, it is as if he says,**

**"Beach I have something WONDERFUL in this box  
that you should have."**

**and I look in the box and I say -**

**"Oh, THAT is wonderful,  
but I have something even more WONDERFUL  
in my box."**

**and he replies,**

**"No, no, no, this is the MOST wonderful thing  
that there is. There can't be anything more wonderful."**

**and I say,**

**"Yes, that which you have IS wonderful,  
but I have looked in both boxes,  
and I know that what is in my box is MORE wonderful."**

**still he replies,**

**"No, no, no, I have a lot of experience with what is in my box  
and there just can't be anything more wonderful."**

**At this point, we can't go forward.**

**If the person is a Christian**

**I tell them,**

**"Yes, Christ is WONDERFUL,  
and I would not have you to have Christ any less,  
but I want you to have Christ more,  
because God is Infinite and there is always more."**

**But, it is often the case that people can only look in their box,  
or if they will even glance in another box**

**it is not really to see what is in it  
but just so that they can "prove" that what is in their box is better.**

**All this will never do.**

**One must lay aside their prejudices  
no matter what they are  
to step forward on the True Path.**

**People are born into all sorts of prejudices.**

**You are whatever color skin you are -  
because your parents were that color skin.**

**You speak whatever language you speak -  
because your parents spoke that language.**

**You are probably whatever nationality your parents were,  
and a member of whatever religion (Christian, Moslem, Buddhist, Hindu)  
that your parents were.**

**You are in the box that you were born in.**

**Oh, we make small changes,  
from one denomination to another.  
Learning a "foreign" language,  
changing from one political party to another,  
but all within the culture of which we are a part.**

**If you were born in America  
it is very unlikely that you will end up  
as a Buddhist in Japan speaking Japanese  
or as a Hindu in India speaking Punjabi.  
And why would you want to.  
You know that what you have is good.  
But it is just that a dramatic change  
that I am inviting you to,  
because it is to something BETTER.  
MUCH BETTER.**

**There is really no need for you to read further  
in this particular email.  
If you are committed to the journey,  
then I have had said enough.  
The rest is too much,  
because it is again just about my personal experiences.**

**Many the tale**

**that I would like to share with you -  
about a number of mystical experiences in the Arctic,  
about my UFO encounters -  
(that alone takes over an hour to relate verbally),  
but briefly I was a control tower operator  
at one of the five experimental Air Force Bases in the U.S.,  
and actually sent planes in pursuit.**

**I would like to tell you about my publishing  
(for another writer)  
lengthy books on Pyramidology  
(I was a publisher for some years).**

**I would like to tell you about  
many strange astronomical phenomena that I have studied  
(I set up a professional observatory at one college)  
and you might like to look at my [millenium star](#).**

**I would like to tell you about studies  
on the Bible Code  
(a way of counting and arranging the letters  
in the original Bible Texts  
so as to create prophecies).  
Or about a study that a friend of mine did  
on the Celestine Prophecies,  
that really impressed me.**

**I would like to talk further about Bibliomancy,  
the various methods of turning randomly  
to Scriptures for guidance.  
(One method that I am considerably more inclined towards).**

**I could tell you about experiences  
in many different Ashrams,  
with the Moonies,  
and the Hari Krishnas,  
with Dianetics and the E-meter  
-yep, read the whole book - did the tests.**

**Yes, I took the courses,  
received the secrets,  
of most every Guru that you can name -**

**from TM (the Beatles favorite)  
to the (young at the time) Guru Maharaji  
(just checked that he is still around).  
All very interesting.**

**Met all sorts of interesting people.  
Weekly luncheons with one group  
that had several UFO abductees  
(so they claimed or believed).  
Most of them realized that they were schizophrenic,  
having at sometime been hospitalized,  
but one may have been one of the few real charlatans  
that I have ever met.  
He made, and I guess still makes,  
a substantial living from his books  
which are particularly popular in Japan.  
Most of these people are simply self deluded.  
Doesn't mean that I don't still like them,  
and also that they don't sometimes (mixed in)  
have amazing insights -  
because they often do.**

**Just like drug and alcohol addicts.  
Often amazing insights  
about everything except their own problems.  
Too often we are quick to call groups cults.  
They are just people  
who have gotten off the path of reality  
more commonly accepted.  
Usually the paths have many erroneous elements,  
but so then is the path followed  
by most "normal" people.  
That of knowing all the latest sports scores,  
what the popular brand names are for clothing,  
knowing who the stars are in the latest movies ,  
and all the materialistic hype of modern CULTure,  
is another path equally divorced from reality,  
as is all the dogmatic conformance to churchianity,  
patriotism, or for that matter any other fanaticism  
of the current "CULTural revolutions".**

**We should not envy the powerful or rich  
(I have been in the same room**

**with a number of U.S. presidents),  
nor despise the poor and downtrodden,  
for God leads each on their own way.  
I have taught volunteer college courses  
to lifers in prison,  
and have served as a psychiatric social worker,  
in several institutions,  
and I know that many of these people are  
more sincere in their struggle to find reality,  
than are masses of people  
that freely wander the earth.  
I at one time lived a block and a half  
from the corner of Haight and Ashbury.  
You have to be ooolld  
to understand the significance of that.**

**My purpose in reciting all this to you,  
is that you may know that  
I have examined every avenue,  
in the search for Truth.  
And as lengthy as is this accounting  
it does not begin to exhaust all that I have done.  
Strange Rosicrucian experiences.  
Serving as Chauffeur and Guard for Ezra Taft Benson,  
then Secretary of Agriculture of the United States,  
and later Prophet of the Mormon Church  
(I put this in for my LDS friends),  
and still the list goes on and on.  
Who else among you has had your life threatened  
in Philadelphia Mississippi  
(where three voting workers bodies  
were found buried in the dam),  
or have lain on the floor with your family  
as the gun battles went on in the street  
one floor below and a block and a half  
from the Black Panther Headquarters.**

**But enough of this.  
Too much already,  
although I could go on and on.  
I receive many emails each day  
(all of which I try to answer)  
from people with a great variety**

**of different belief systems.**

**The purpose of the previous emails was to show  
the spirit of search  
with which one must seek.**

**But, as Jonathan Livingston Seagull once said,  
"It is good to be a seeker,  
but it is better to be a finder."**

**And in my searching-  
I did find.**

**I found not only how to identify the True Prophet,  
but I also found the True Prophet.**

**The time is now too short to continue with tales.**

**The time has come for the Truth to be Told,  
and I shall tell you how to find it for yourself.**

**But, you must be willing to make the journey yourself.**

**No one else can make it for you.**

**Just as every student of mathematics  
must work the mathematics out for themselves,  
because no one else can do it for them.**

**Oh' we can show the formula,  
go through the exercise,  
but in the end each one must think it out for their self.**

**Because we live in a Christian Culture,  
the proofs that I am going to present are  
Christian proofs.**

**If we lived in a**

**Buddhist,**

**Moslem,**

**Hindu,**

**or other culture,**

**then I would use proofs from those cultures.**

**It makes no difference  
if you consider yourself a Christian or not,  
because you live in a Christian culture,  
you will be able to understand the proofs  
from a Christian perspective.**

**Yes, we will look in the Bible,  
and if you do not currently believe in the Bible,  
then afterwards, if you follow the presentation,**

**you will come to a new appreciation of its significance.**

**So now, our search for the True Prophet,  
and the True Prophecies,  
has taken this turn.  
Bear with me if you will,  
or depart in peace.**

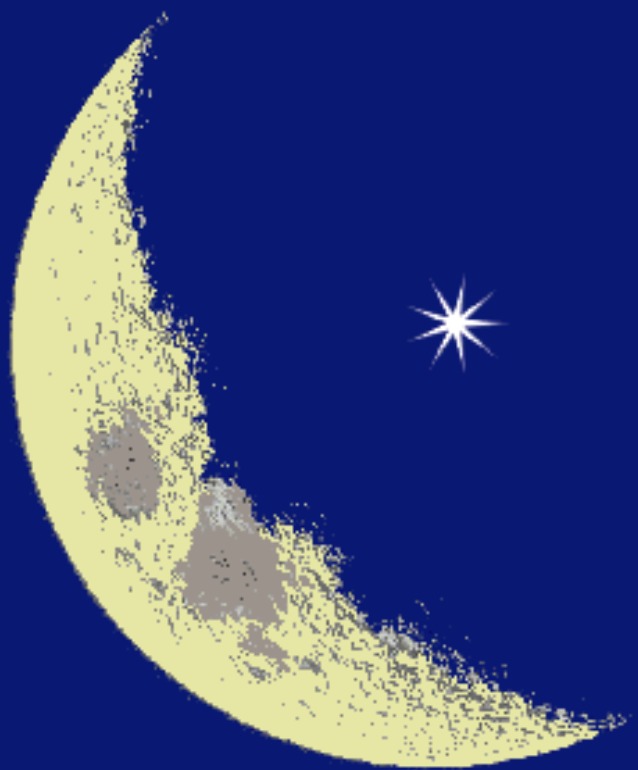
**Peace and love,  
Bruce Beach  
DawnSayer@webpal.org**

**MENU: [HOME](#) » [Reconstruction](#) » [Recovery](#) » [Renewal](#) » [Prophecy Directory](#)**

---

---

**MENU:** [HOME](#) » [Reconstruction](#) » [Recovery](#) » [Renewal](#) » [Star Directory](#)



*Millennium*  *Star*

# Millennium Star



## Fulfillment of an Ancient Prophecy

This oft-told ancient prophecy,  
with roots back in the Sufi and Illuminati teachings,  
is reflected in the Tale of the Ancient Mariner,  
with its "star dogged moon"  
and in the ancient symbolism on the flags of  
many modern Moslem countries.

What the prophecy says is that:  
at the Time of the End,  
a Star will appear between the Crescent Points of the Moon.

Now, all astronomers KNOW that this is impossible.  
Stars are generally very large astronomical phenomena like  
our sun.

The closest being our sun,  
and the others many light years away.  
For one, to appear in the orbit,  
between us and the Moon,  
would be IMPOSSIBLE, they would say,  
and WOULD destroy the earth should it occur.

And yet, this phenomena,  
this end of the old - beginning of the new,  
millennial event - of a Star appearing between the Crescent

Points of the Moon,  
WILL OCCUR this very month.

Let me explain:

To the ancients, there were two types of stars,  
fixed stars,  
and moving stars,  
and they both looked alike to them,  
since they did not have a telescope.

The only distinction was that the one small group of stars  
moved,  
and for this reason they called them planets (travelers),  
which to them simply meant moving stars.

Now, today we have a different view of planets,  
but nevertheless, it is a planet that will appear  
between the Crescent Points of the Moon.

But, whoa, hold up you may say, if a planet  
is going to change its orbit  
and pass between the earth and moon,  
that TOO is certainly going to be a catastrophic event.

Well, actually, still some further explanation is needed.  
To any primitive people,  
that would happen to be occupying the earth at this time,

if they were out tending their flocks on a clear night,  
they would notice that new stars,  
new traveling stars (planets),  
have appeared in the sky.

We call them satellites.

Now, the fact is,  
that a Traveler will appear between the  
Crescent Points of the Moon.

And I would like to have a photograph of the event.

When and where will it happen?

Well, probably about every month,  
from some advantage point on the earth.

To observe and photograph it,  
one needs a cloud free night,  
(or to be above the clouds)

and for the satellite to be **AT THE CORRECT ANGLE**  
between the observer,  
and a Crescent Moon.

DawnSayer@webpal.org

**MENU: [HOME](#) » [Reconstruction](#) » [Recovery](#) » [Renewal](#) » [Star Directory](#)**

---

---

**MENU:** [HOME](#) » [Reconstruction](#) » [Recovery](#) » [Renewal](#) » [Prophecy Directory](#)

# POP 07a - My Declaration

If you have some suggestions or comments you would like to pass on to me about these pages you may do so at: [DawnSayer@webpal.org](mailto:DawnSayer@webpal.org)

---

**Baha'i's use the term "declaration" regarding their belief in and commitment to Baha'u'llah. Here I will tell you about the event that led to my declaration.**

**I had been aware of the Baha'i Faith for many years and had visited the Temple in Chicago a number of times.**

**Then, back in my native Kansas I saw an ad in the Sunday paper with a picture of the Temple and called out of curiosity that there were Baha'i's there.**

**At the local Baha'i's insistence I visited with the group that morning but told them I had no time to read a book. Their reply was:**

*"God will give you time."*

**During next week a major Evangelical Crusade was planned for the City of Wichita. Everywhere one looked one saw banners that proclaimed -**

## **"Hear Haggai"**

**the evangelist.**

**The banners were in store windows,  
on car bumpers,  
on telephone poles,  
and on two big banners  
strung across the main street  
at both ends.**

## **"Hear Haggai"**

**On the radio,  
in the newspapers,  
everywhere one looked  
or heard - it was:**

## **"Hear Haggai"**

**The newspapers reported  
the week long event.  
Many thousands in attendance -  
the gigantic choir -  
the moving sermons.**

**Each evening a Baptist friend  
would come and ask me to go  
but I was too busy.**

**The final evening he came  
and insisted and insisted  
telling me that the night before  
over a hundred and fifty people  
and gone forward to be baptized,  
and that this was my last chance to -**

## **"Hear Haggai"**

**In consideration for my friend -  
I finally went with him.  
The coliseum was packed.**

**The main floor  
which was the city basket ball court  
was filled with chairs.**

**At one end of the court was a stage  
with 150 robed members of the choir  
comprised of the joint choirs of  
a number of the cities churches.**

**Three of the four balconies surrounding  
three sides of the basket ball court  
were also filled with only some vacant seats  
in the fourth balcony.  
Thousands in attendance.**

**It looked something like a political convention  
with lettered signs held up on tall poles  
showing the seating location  
of each of the city's many churches.**

**East Side Baptist,  
Rosedale Alliance,  
Central Bible Church,  
Broadway Church of God,  
"Hear Haggai"**

**The church with the largest percentage attendance  
was being given new hymnals for the church.  
The winning church  
had 300% in attendance.  
It was a large meeting.**

**The choir and congregation concluded a hymn  
and all sat down  
and Haggai rose to speak.  
Indeed a powerful sermon.**

**I still remember from the sermon  
how he pointed out  
the number of beneficial institutions of mankind  
that have been started  
because of the teaching of Christ.**

**There are hospitals,  
and schools,  
orphanages  
and relief organizations of all sorts.  
The list goes on into the tens -  
as he gave it,  
and the numbers of each  
in the tens of thousands or more.**

**What man,  
he asked,  
has ever done more to benefit mankind?  
One can look at all sorts  
of political organizations  
and political philosophies.  
Personal organizations,  
and personal philosophies  
but what has done more  
than the teaching of Christ  
to benefit mankind?**

**Then he pointed out.  
One is either for  
or against  
this movement that has so benefited mankind.  
One cannot say  
that they are neutral or indifferent -  
because they are either part of the solution  
or part of the problem.  
Many were the points  
that Haggai made of this sort.**

**I concluded that  
well it doesn't really do any harm  
in supporting Christ -  
and better this source of good  
than none.**

**When the altar call was given -  
no one went up  
although over a hundred and fifty  
had gone the night before.**

**Even more were expected this night -  
but I guess the crowd had thought  
to beat the rush.**

**Several times Haggai paused the choir -  
and urged sinners to come forward.  
One time he gave an exhortation  
that those there would be standing  
on one side of the Pearly Gates  
and that husband, brother, sister, friend  
next to them would not be  
because they had not turned to them  
and offered to go forward with them.**

**My friend stood next to me  
like a statue of rock,  
but I must have dropped a shoulder  
or something  
because an usher came up from behind  
and asked if I would like to go forward.**

*"Well, yes."*

**At the front I found myself  
and one other fellow who eventually came forward  
standing there looking up at the choir.  
Haggai finally stopped the music  
and looking down at this poor catch said -**

*"Well, the Lord is looking for quality - not quantity".*

**He assigned to each of us  
two deacons (or guards as I called them)  
and told them to take us to an upper room  
where he would come shortly.**

**And so we marched out -  
I and my two guards leading,  
and the other fellow and his two guards trailing.**

**Up the broad cement and steel stairways  
behind the auditorium**



**and into a team dressing room.**

**Red brick walls and wooden floors  
with windows two feet above one's head.  
Fold-down windows with opaque  
chicken wire-embedded glass.  
Hanging from the 15 ft ceiling  
down the middle of the 50 ft room  
five single light fixtures on stranded cord  
with green shades and 150 watt bulbs.**

**Except for one table -  
the otherwise unfurnished room  
had lining down the walls on each side  
a half dozen 7 ft benches  
with patches of white showing through peeling green paint  
worn out from a generation of showered athletes  
having been sitting upon them.**

**Being first through the door -  
my guards and I proceeded forward  
several benches and sat down  
with one guard on each side.**

**With a couple of benches in between  
my companion captive was also similarly seated.  
And thus we sat -  
in total silence  
none of our guards  
having every spoken a single word  
to either of us.**

**Through the thick walls of the fortress  
and away in the distance  
we could dimly hear the voices of thousands  
raised in praise to the Lord of the Ages.**

**And then -  
total silence  
as there must have been being offered upon them  
a final blessing.**

**And suddenly -  
a loud clamor and commotion  
as thousands rose from their seats  
and moved towards the exit.**

**Bit by bit,  
the clamor died away  
until again there was total silence.**

**Wait.**

**Wait.**

**And then from the distance -  
*thump, thump, thump*  
growing louder -  
*thuMP, tHUMP, THUMP,*  
and the door burst open  
and in marched Haggai with  
twenty or more ministers behind him.**

**He stopped in front of the other prisoner,  
whose guards IMMEDIATELY  
split away from him and departed  
as the ministers formed a semi-circle  
around behind Haggai, who said -**

*"Have you made your decision for Christ?"*

*"Well, I was b..b..b.. baptized before -  
but it d..d..didn't take."*

*"Having you been attending church?"*

**At this point one of the ministers said  
that the conversant had been attending his  
and stepped forward and put his hand on his shoulder  
and then with a glance over towards me -  
seeing that he did not know me,  
led the petitioner from the room.**

**Haggai then turned towards me.  
THUMP, THUMP, THUMP,  
and the semi-circle formed behind him.  
SUDDENLY my guards were GONE!**

*"Have you made your decision for Christ?"*

*"Well, I have one question that concerns me.  
May I ask it?"*

*"Yes?"*

*"Well, you see I have been attending this  
Buddhist Church in Chicago -  
and what I want to know is -  
'Are my Buddhist friends ALL  
really going to go to hell?'"*

**At this point  
Haggai glances back over his shoulder  
and about a fourth of the ministers**

**are standing there shaking there heads up and down -**

**and about a fourth of the ministers**

**are standing there shaking there heads side to side-**

**and about a fourth of the ministers**

**are standing there sort of shrugging-**

**and about a fourth of the ministers**

**are standing there with blank expressions on their faces.**

**And Haggai says,**

*"I tell you what I want you to do -"*  
**and he tells one of ministers to hand him  
from the table in the corner  
a copy of a pamphlet  
of the Gospel of St. John -  
(which I have to this day - over forty years afterwards,)  
and he says to me -**

*"I want you to take this home,*

*and each night  
and each morning  
read a chapter of it  
and get down on your knees  
and pray to God to show you His Will."*

**And then he says,**  
*"And I want you to call me tomorrow  
at my motel  
and I will meet with you."*

**So, I did as he said.  
And the next morning,  
I called at his motel,  
and the operator said he had gone for breakfast -  
and when I called again -  
a little later she said that he had left -  
and so I never got to talk to him.**

**But, I did exactly as he said,  
and I want to testify to the efficacy of Christian prayer.  
Each evening and morning  
I read a chapter of the Gospel of St. John  
and each morning and evening  
I got down on my knees  
and I prayed to God to show me His Will.**

**A few nights later -  
I was asleep in my room -  
when a figure appeared through  
the darkened doorway.**

*"Arise -  
and dress!"*

*"Wha, wha, what?  
Who is that??"*

*"Never mind!  
Arise and dress!"*

**I fumbled over and turned on the night stand lamp.**

**There in the room stood another friend -  
from the Christian Science Church.**

*"Uh, what's up doc? -  
It is after midnight!"*

*"Get up and get dressed."*

*"Why?"*

*"Never mind - do it."*

*"What should I wear?"*

*"Those pants, that jersey,  
and a warm jacket."*

**Thus it was that I descended the stairs -  
in my good suit pants and non-matching garb,  
to find his new motorbike parked at the curb.**

*"Come on -we'll go for a ride."*

*"Neat. But no thanks,  
I have been on a motorcycle before  
and we had an accident."*

**(Same happened with my father,  
and one of my sons was nearly killed on one,  
and a friend's son is paralyzed -  
I do not care for them.)**

**But my friend insisted.**

*"Okay, but just around  
to the all night restaurant  
on the other side of the block."*

*"Well, okay."*

**We didn't make it.  
We were on a one way street.**

**Putt, putt, putt,  
slowly up to the stop-light at the corner,  
waiting for it to turn green,  
which it does  
and a car on the four lane road ahead  
pulls up on the center lane and stops  
to wait at their now red light  
and we speed up to go across in front of it and turn -  
when a car load of drunks comes through  
on the curb lane and hits us.**

**I sail completely across the street -**

*"Take this one first,"*

**someone is saying to the ambulance driver.  
A phrase which is repeated at the hospital.**

**I ask that a call be placed to my Christian Science Teacher,  
(I am what they call a class taught student)  
as they take me down to X-ray,  
for 14 breaks where the car had hit me -**

*"Wrap it up -  
and I will take it home with me."*

**I tell the attendant.  
(The other fellow only had a broken shoulder bone.)**

**And so I ended back at my office -  
when my father shows up from our home  
30 miles south -  
having heard about it on the radio.  
He arrived at the same time  
as one of the Baha'i's I had met.**

**My father and the Baha'i insisted  
that I accompany my father home,  
where my father summoned a local physician.  
Although there were three hospitals in the  
town the physician decided  
I should be sent back by ambulance to the city,**

**where I was confined to a bed  
although I still declined surgery.**

**The next day the Baha'i came with a book.**

*"See, I told you God would give you  
time to read."*

**I had never felt pain  
from the moment my CS Teacher was called,  
and all the bones set themselves  
and healed without surgery,  
although I was released a week later  
with a leg cast  
but the fellow in the next bed was REALLY sick -  
and there I was  
reading the Baha'i Book  
and in exaltation -**

*"I Found It!"  
"At Last I Have Found IT!"*

**That alone could have killed him.**

**My favorite song became,  
Jeanette McDonald and Nelson Eddy singing -**

*"Ah, Sweet Mystery of Life -  
at last I have found you!"*

**I played it over and over and over.**

**Each person's experience in their religion  
is a mystery.  
Each person finds the mystery of life and love  
in their own experiences.  
For some my experience  
may seem more story teller than story -  
but we all seek the mystery of life.**

**There are always deeper Truths  
and we can always grow deeper to God.**

**Many are the paths  
and some may wonder how one can say  
that one path is better than another.**

**One never has the FINAL answer  
and all that one can do is compare what they have  
with what they are given the opportunity to examine.  
You have a box --  
and I have a box.  
You KNOW that what is in your box is beautiful and wonderful.  
You just can't imagine  
that there can be anything better.**

**You say to me -**

*"Look in my beautiful box."*

**And I LOOK and say,**

*"Yes, that is WONDERFUL! -  
but what I have in my box,  
is more wonderful."*

**Unless you look in my box -  
you will never know.  
God is Infinite  
and His Creation is Infinite.  
If you live 10 million years -  
(and you will and many times that more)  
you will never begin to exhaust  
what you can learn about God and His Creation.**

**But, those who are haughty before God -  
and refuse to look in another box,  
will never know.  
They can progress but only within their box  
and as wonderful as that may be  
it is still confining  
and that is all that they will have  
from Eternity unto Eternity -  
while there is Infinitely more to God  
and His Creation.**



**What we are meant to gain and set in this life  
is our attitude of openness to the Holy Spirit -  
and not some limited amount of finite knowledge  
or dogma.**

**If there is good in all religions,  
one may ask -  
then what difference does it make  
which religion one chooses.  
The difference is that one must choose  
to do the Will of God -  
and they must always be open  
to making comparisons and choices  
as He leads us on the path.**

**Many a Christian,  
many a Mormon,  
has borne me their testimony.  
Because I lived in Provo, Utah  
and would always welcome the practicing Mormon Missionaries  
I am sure that I have had more Mormon Testimonies  
borne unto me  
than any other single individual on earth.**

*"Before I leave -  
I want to bear you my testimony."*

*"Oh, no, no -  
not that again -  
please!"*

*"Nope, I am going to do it."*

*"No, really, you don't have to do it."*

*"Yes, I do."*

*"Well, okay, I suppose so,  
if you have to."*

**And I am glad that they -**

**and the many hundreds of other  
truly devout Christians that I have met -  
have a Testimony.**

**But I do wish -  
that they could also look into my box,  
and see then which they think  
it is the Will of God that they should choose.**

**Peace and love,  
Bruce Beach  
DawnSayer@webpal.org**

**MENU: [HOME](#) » [Reconstruction](#) » [Recovery](#) » [Renewal](#) » [Prophecy Directory](#)**

---

---

**MENU:** [HOME](#) » [Reconstruction](#) » [Recovery](#) » [Renewal](#) » [Survival](#)

Essays on the  
**Four Types of Souls**  
by Bruce Beach

This is a continuation of the POP series which were originally an email series of essays.

The intent of the series was to lead the reader through such subjects as the nature of the soul and how it recognizes God through the Four Paths to Truth, and then on to presenting The Most Great Proof.

If you have some suggestions or comments you would like to pass on to me about these pages you may do so at:

[DawnSayer@webpal.org](mailto:DawnSayer@webpal.org)

If you wish to enter into a discussion with me regarding religion - I highly welcome that. I have some [religious premises](#) that I would like you to review first, and let me know regarding any about which you disagree to help me better understand any points that you are making.

---

The Essays

POP08 - [The Four Types of Souls](#)

POP09 - [The Soul of Self](#)

POP10 - [The Soul of Love](#)

POP11 - [The Soul of Reason](#)

POP12 - [The Soul of Spirit](#)

---

**MENU:** [HOME](#) » [Reconstruction](#) » [Recovery](#) » [Renewal](#) » [Survival](#)

---

# POP08 - The Four Types of Souls

If you have some suggestions or comments you would like to pass on to me about these pages you may do so at: [DawnSayer@webpal.org](mailto:DawnSayer@webpal.org)

---

**Good morning Seekers of the True One,**

**Now that you have stepped upon  
the Path of Search  
for the True Prophet  
it is important to know first the Seeker.**

**Who are YOU?  
Well I can tell you that  
you are a soul,  
but as a teacher and traveler  
we need to know what kind of soul.**

**There are only four kinds of souls.  
I know that this may surprise you.  
Some people think that there may be  
only one kind of soul.  
Others think that every soul is different  
and that there are therefore infinite kinds of souls.  
But no, there are only four kinds.**

**Recognition of this fact  
is to be found in Aristotle, Shakespeare,  
and many other classical thinkers  
down through the ages.  
It was acknowledged in the work of  
William James, Americas greatest psychologist  
and intimated in that of Pavlov,  
which was Russia's. Many thinkers and teachers,  
of the East were also aware and today  
there is a large body of study on the subject.  
But still it is not common knowledge  
and most people are not aware that there are only**

## **four types of souls.**

**My source for this information is of course  
the True Prophet,  
but I have mentioned the above because  
Truth is Universal and can be universally found.  
2+2=4 in both Russia and the US  
or anywhere else one may go  
no matter by what name the numbers are called.  
So it is with other Truth such as religious truth.**

**Types of things come in limited numbers.  
Water can be seen as a**

- **Liquid**
- **Vapor (clouds, fog, steam)**
- **Solid (sleet, hail, ice, snow)**

**and while every snow flake may be unique  
it is still one of the three states of water.**

**Each person has blood of some particular type.  
You may know yours.  
While there are variations within the types,  
we still say that there are only so many types.**

**As one last example -  
Suppose that we said that there were only  
four kinds of animals.**

- **Insects**
- **Birds**
- **Fish**
- **Mammals**

**Among the insects there would still be great variety -**

**from the tiniest ants to the giant beetles,  
and from scorpions to the butterflies.**

**And among the birds**

**from the humming birds  
to the ostriches and the eagle to the parrot.**

**In the fish**

**from the gold fish  
to the Great Blue Marlin,**

**and among animals**

**from the tiny shrew  
to the elephant.**

**With great, great numbers of varieties among all the species,  
but still for our convenience we listed them as four categories.**

**And no matter how great the variety,**

**and the fact that every individual specimen is unique  
just as each snow flake is unique**

**there remain a limited number of categories.**

**And so it is with the soul -  
there are but four types.**

**Not to say that there is not great variety in the types,  
or that you are not individual and unique,  
because both of those things are true.  
But it is still true that you have one of the four types  
of soul.**

**It is important to know the type of soul.  
Otherwise we will end up  
putting the canary in the aquarium  
and the goldfish in the bird cage.  
Yet the world as a whole remains blind to this fact.**

**When you take your child to the kindergarten,  
to enroll them in their first day of school  
they may ask you a hundred questions  
regarding**

- **sex**
- **age**
- **height**
- **weight**
- **even blood type**
- **and IQ**

**but never on the form will you find  
the most important of all questions for a teacher -**

**what kind of soul will I be teaching?**

**In my next four letters  
I will be discussing the four types of souls.  
It is important to identify and understand  
your own type of soul,  
but it is also useful to know and understand  
the other types.**

**It will much help you**

- **in teaching your children -**
- **understanding your spouse**
- **getting along with co-workers,**

**and the dozens of other situations  
that you meet in life.  
It is well to understand others,  
even if they do not understand themselves.**

**For a teacher it is essential  
to understand the kind of soul  
that they are attempting to teach.  
And in this I have a problem,  
because I cannot know each of you individually.**

**I have taught before through email  
on a one to one basis  
but I have never tried to do mass teaching  
through email  
and I know of no other teacher  
who has tried to do it either.**

**So perhaps it can't be done.  
But perhaps it can.  
So it appears that you are a part of an experiment.**

**Somethings can be learned out of a book.  
But for other things a teacher appears to be necessary.  
Probably no great musician or mathematician  
has ever been self taught.**

**In the past I have seen attempts  
to teach mathematics by computer.  
In fact I was VERY enthused about the idea  
and was involved in some very substantial programs  
to do so.  
Didn't work out.**

**Turns out that you can give printed example  
after printed example with a computer  
but successful teaching requires interaction  
between a pupil and the teacher.**

**The teacher stands at the blackboard and explains  
but needs to watch the eyes of the students,  
and when they start to glaze over,  
the teacher must slow down and wait for them  
to catch up.**

**At some point the pupils may just not get it  
and the teacher will stand at the blackboard  
and tap with the chalk  
at some particular point in the formula.  
And then the gleam of recognition  
will appear in the pupil's eyes  
and the teacher can proceed on.**

**Readiness to read,  
readiness to learn,  
readiness to comprehend,**

**is something comprehended among all primary teachers,  
consciously or unconsciously.**



**Many are the stories of the Zen Teaching Masters,  
or of the Abbots in the Catholic Monasteries,  
who suddenly performed some action  
like reaching over and tweaking the pupil's nose,  
grasping their ear and not letting go,  
or thumping them on the head,  
at the moment that they called satorie,  
and that the pupil suddenly saw the light.**

**Yes, every student is unique,  
and every step along the path is unique,  
and every student must make every step for their self.  
And therein is the problem,  
because I must address a general need,  
speaking at one moment to one type of soul  
and at another moment to another.  
Addressing some with a particular level  
of concern or comprehension at one moment,  
and those with another at the next.  
We shall have to see if this will work.**

**In all communication there are three elements.  
There is**

**the SOURCE  
the MEDIUM  
the RECEIVER.**

**It makes little difference what we are talking about.  
It could be light.**

**The source (a bulb, the sun, or a fire)  
The medium (light waves - I won't get into the subject of aether.)  
The receiver (a mirror or any matter).**

**It could be sound.**

**The source (a drum or other instrument)  
The medium (a gas or liquid such as air or water)  
The receiver (an ear or transducer).**

**It could be radio.**

**The source (a transmitter or star)  
The medium (radio waves)  
The receiver (a walkman or a radio telescope)**

**The principle remains the same.**

**In this case we have:**

**The source (the teacher)  
The medium (email)  
The receiver (the pupil)**

**In each case there is also the MESSAGE.**

**The MESSAGE is quite separate from the signal or datum.  
The Message should contain Information.  
Otherwise, as in writing it is just empty marks, scribbling on paper.  
Many people can see the signal  
but not get the Message.**

**They can see the notes written on the musical score,  
but not hear the Music.  
They can even hear the sounds of the orchestra  
but not hear the Music.  
The Message and the Music  
are something separate from the Signal.  
The Message and the Music  
are something heard in the soul,  
not in the ear or in the instrument.**

**For this reason some can pick up the Bible or Koran  
or other Book of Revelation  
and just have the words sing off the pages to them  
while someone else will just see the smudges of words on paper.**

**The problem of lack of communication  
rests in either**

**the Transmitter  
the Medium  
or the Receiver**

**In this case  
the MESSAGE  
comes from a perfect source.  
If you do not GET IT  
then the problem rests in**

**the Transmitter (the teacher)  
the Medium (email)  
or the Receiver (the pupil - YOU).**

**I shall do my best to communicate it to you,  
but I assure you  
the problem is not in the Message.**

**Peace and love,  
Bruce Beach  
DawnSayer@webpal.org**

**MENU: [HOME](#) » [Reconstruction](#) » [Recovery](#) » [Renewal](#) » [Four Souls Directory](#)**

---

---

# POP09 - The Soul of Self

If you have some suggestions or comments you would like to pass on to me about these pages you may do so at: [DawnSayer@webpal.org](mailto:DawnSayer@webpal.org)

---

**The first of the four types of souls  
that I shall discuss  
is the type that there are the most of..**

**This is the Soul of Self.  
This type of Soul well loves God,  
and is well beloved of God.**

**The possessors of this type of soul  
are the very backbone and foundation  
of society.**

**As with all types of souls  
their strengths can become their weaknesses  
if they are misused.**

**As with all types of souls  
they have their preference as to type of religion,  
type of employment,  
type of enjoyment and association.**

**These souls delight in order,  
and when properly trained and educated  
are highly respectful of authority.**

**Every religion whether Christian, Moslem, Jewish,  
or any other,  
has branches (sects) that provides a haven for these souls,  
just as they have branches  
that provide havens for other types.**

**Some may consider the Catholic church**

**to be a monolithic sect  
but it is not  
and that is why there are many different Orders  
within it  
so as to provide havens for the different types of souls.**

**The same is true of every religious system  
and since things are never black and white  
but rather a continuum and spectrum  
from the brightness of the noon day sun  
to the darkness of night -  
a spectrum that includes dawn and dusk,  
sunrise and sunset,  
there is naught that one can speak on  
but that some will eagerly point out the exceptions.**

**Birds fly,**

**but then so does the bat which is a mammal.**

**Fish swim, and live in the water**

**but then so does the whale which is a mammal.**

**Those who would be argumentative  
can always find some evidence to bolster their position.  
Nothing is pure in this world.  
All is relative.**

**All men contain some feminine characteristics,  
and all women some masculine characteristics.  
The brightest among us will have some intellectual blind spots,  
the dullest will occasionally have a brilliant insight  
whether they will recognize it or not.**

**Still we can distinguish noon from midnight,  
and the cold of winter  
from the heat of summer.  
And in like manner  
we can make the distinction between the types of souls.**

**Although many organizations**

**attract several types of souls**

**Within those organizations that attract a single type  
there is often a division of activities  
that still further singles out those with some degree  
of the qualities found predominately in the other types.**

**By this latter, I mean, that in organizations  
that serve those of the Soul of Self,  
there will be some individuals who will still fill  
administrative or creative functions  
although these are not primary qualities of this type of soul,  
but those individuals will have those qualities (in a mixed degree)  
more than others in the organization.**

**In discussing this first type of soul,  
I am also discussing some generalities that apply to all types.  
One thing that should be noted  
is that soul characteristics do not appear to be inherited,  
like blood type or skin color.  
Any couple may have offspring  
of any soul type.  
(Among my half dozen children and dozen grandchildren,  
I have had every type that there is).**

**Thus comes the danger  
of trying to force children into your own paths.  
Though you may be musically inclined  
a child may not be at all,  
or vice versa - very inclined in that way  
where you are not at all.**

**The examples that I could give in this regard  
are so numerous, but also so obvious,  
that I will not even begin to list them.  
Nevertheless, so very, very often,  
children are directed into paths that do not really suit them,  
and consequently they neither find the joy in life that they might,  
nor do they begin to fulfill the potential that they might  
in another field.**

**The nature of a child  
needs to be recognized at a very young age,**

**because the training to gain full potential  
needs to begun very early.  
Once the child has been forced into a path  
unnatural to its proclivity  
it has no choice but to mature in that path  
the best that it can  
because a full turn around  
cannot be accomplished.  
But that is the nature of our present world.**

**So much for generalities.  
Back to the soul of self.  
This soul, in its search for order,  
seeks that order in its family,  
its government,  
its schools and education,  
and its employment.**

**These souls can become skilled technicians.  
Learning, knowing, applying  
in great depth  
the rules, regulations, formulas and details  
of their disciplines and professions.**

**They also can find fulfillment  
as craftsmen, merchants, tradesmen.  
Our society, and all societies,  
are very dependent upon their contributions.  
Their employment is often as electricians,  
and plumbers, carpenters, and mechanics.  
Farmers and soldiers.  
Indeed they are the backbone of the military,  
filling the ranks  
and the roles of the non-commissioned officers.**

**Unfortunately, souls of other types  
can also be found in those positions.  
They often do a satisfactory job,  
but they themselves are never truly satisfied,  
because the positions do not match and fulfill their needs.**

**Community service clubs, and veteran's organizations**

**have great numbers of members of souls of this type.  
They most often have a very similar social and political outlook.  
They would prefer to see more order in society,  
and are often distressed (and angry) at the disorder that they see,  
at the lack of obedience to established rules,  
and the lack of conformity to the standards that they admire  
and appreciate.**

**As I have stated before,  
each soul can turn its capacities for good  
in the opposite direction  
and thus it is that we also find  
the major occupants of our prisons  
to be souls of this type.**

**In their misdirected pursuits  
they often fill the lower types of bars  
involve themselves as participants or observers  
in the more violent sports.  
Indeed their interests in every activity  
from work, to entertainment, to sex, to diet,  
can become oriented towards the most base and physical.  
They make up the class of petty criminals,  
and are the main statistic behind violent crime.**

**Every type of soul likes**

- **music**
- **food**
- **sex**

**and participates in**

- **family**
- **work**
- **employment**
- **religion**

**and becomes a part of**

- **society,**
- **government,**



- **war**

**but the distinction can be seen in  
the varieties and types of responses  
between the various types of souls.**

**For each type of soul,  
there are types of music, food, entertainment,  
participation in government, religion, work and family,  
that are beneficial and specific to that type of soul,  
and there also other types of  
music, food, entertainment  
and so forth  
that are not beneficial.**

**In future discussion of other types of souls,  
I shall make some comparative references  
to the nature of this soul in regards to its search for Truth  
and also to some of the requirements for the  
spiritual training of this type of soul.**

**But, enough for now.**

**Next time on to the second type of soul.**

**Peace and love,  
Bruce Beach  
DawnSayer@webpal.org**

**MENU: [HOME](#) » [Reconstruction](#) » [Recovery](#) » [Renewal](#) » [Four Souls Directory](#)**

---

---

# POP10 - The Soul of Love

If you have some suggestions or comments you would like to pass on to me about these pages you may do so at: [DawnSayer@webpal.org](mailto:DawnSayer@webpal.org)

---

**The second type of the four types of souls  
that I shall discuss  
is the Soul of Love**

**This type of Soul loves God well,  
and God well receives that love.**

**The possessors of this type of soul  
breath the very spirit of life into society.**

**As with all types of souls  
their strengths can become their weaknesses  
if they are misused.**

**As with all types of souls  
they have their preference as to type of religion,  
type of employment,  
type of enjoyment and association.**

**These souls delight in beauty,  
and when properly trained and educated  
help direct society in the path of compassion,  
mercy, and justice.**

**These souls need to be trained  
with particular tenderness and sensitivity.  
As they mature they must be guided  
in experiences that give them appreciation  
of the qualities of the other types of souls.**

**These souls can become musicians,  
poets and artists.**

**They are also a proper source for healers,  
teachers, social workers,  
and a wide variety of other occupations.**

**In misdirected pursuits  
they create decadent music and art,  
associate themselves with others  
of weak moral discipline,  
and misdirect society as strongly  
as they might have morally directed it.**

**In future discussion of other types of souls,  
I shall make some comparative references  
to the nature of this soul in regards to its search for Truth  
and also to some further requirements for the  
spiritual training of this type of soul.  
But, enough for now.  
Next time on to the third type of soul.**

**Peace and love,  
Bruce Beach  
DawnSayer@webpal.org**

**MENU: [HOME](#) » [Reconstruction](#) » [Recovery](#) » [Renewal](#) » [Four Souls Directory](#)**

---

---

# POP11 - The Soul of Reason

If you have some suggestions or comments you would like to pass on to me about these pages you may do so at: [DawnSayer@webpal.org](mailto:DawnSayer@webpal.org)

---

**The third type of the four types of souls  
that I shall discuss  
is the Soul of Reason.**

**This type of Soul seeks God through Reason,  
and God showers great bounties upon it.**

**All men of course possess a rational soul,  
as well as a soul with the capacity  
for love and obedience.**

**What determines the type of one's soul  
is the predominance of one quality.**

**Society as a whole possesses a collective soul.  
I don't want to make a major philosophical point of this,  
because I don't have a major philosophical point,  
but we do appear to have a collective consciousness,  
and a collective conscience.**

**Society as a whole goes through stages and cycles.  
Maturing or retrograding spiritually.  
Most people recognize that we are at the perigee  
or low ebb in our present cycle.**

**But the stage of the maturation of  
present day society as a whole  
is approximately that of adolescence.**

**It is interesting to observe how  
ontogeny recapitulates phylogeny  
(that is to say how the individuals history  
recapitulates that of the human race).**

**Yes, there is evolution,  
but it is also true that man is a special and unique creation.  
The purpose here  
is not to get into the theological battles  
that so greatly stir the emotions of some souls  
but rather to make some observations.**

**Man (yes man - not some other creature)  
began as a single cell in the sea,  
and progressed through stages  
of multiple cell division.**

**So also does each individual in his ontogeny  
that recapitulates that phylogeny.  
First as a single cell then as a multiple cell,  
in a private sea,  
that has the same saline content as the oceans.  
And so shall we continue to ever find it  
in our blood and our sweat and our tears.**

**Through progressive stages in the womb,  
having states similar to that of the tadpole,  
salamander, and other creatures,  
the embryo travels the path of nature,  
to obtain the human form.  
At one time having this appendage,  
and at another time that,  
but growing on to what we are today.**

**In some percentage of births today,  
the child is still born with a tail,  
but the obstetrician simply separates it from the tailbone,  
before sending the infant home.  
But, what the physician sends home is a human child,  
and such it was from the moment of its conception.  
It was never going to grow into a rose or a tiger,  
but always into that which it was conceived to be.  
Thus it is that the argument between  
the Creationists and the Evolutionists is irrelevant,  
because while we evolve  
we always are, always were, and always will be  
what we were created to be.**

**And the race has continued to progress outside of the womb.  
Color blindness has decreased  
but centuries ago it was quite common  
and in the time of the early Greeks almost universal.  
We can tell this from their poetry  
that under the bluest skies of the Mediterranean  
that in their poetry they took no notice  
of the azure blue of the skies  
in distinction to the green verdure of the fields.**

**We know also that the knights of old were relatively short  
to the warriors of the present day.  
This is visible in the small suits of armor  
still displayed in the castles of Europe.**

**Indeed, induction statistics, from the First World War,  
to the Second and later conflicts,  
tell us the same, about both these examples.  
The race has been, and is, changing (evolving) physically.  
But these are not the matters of import to us.  
What we are examining here is the spiritual evolution of man.**

**The race as a whole,  
and each individual also,  
(through the rules of ontogeny recapitulating phylogeny)  
follows certain paths of development.**

**And so it that an individual child,  
first develops the qualities of the Soul of Self.  
Seeks gratification in the physical senses,  
and the obedience to authority,  
the first word it probably making real use of  
being the word "No".**

**The child soon becomes sensitive to emotions,  
music and love.  
How sensitive a child can be!  
And then there begins to develop reason,  
the prime facet of this third type of soul.  
Psychologists have observed and mapped  
the development of the reasoning faculty.  
The degrees or relationship and abstractness,**

**that will be apparent in the child  
at mental progressive ages of development  
and in what order and stages.**

**Such is the development of every soul,  
from the point of conception and its coming into existence,  
on through to its maturity at around the age of fifteen.  
Once mature, the soul continues to spiritually develop, or not,  
through Seven Stages - through the choice of its will,  
and the guidance of its teachers.**

**These seven stages of spiritual development,  
recognized or unrecognized,  
take place regardless of the religion to which one belongs  
or the church of which one is a member.  
But the Seven Stages are another subject,  
and one that I shall not cover in this series,  
for our purpose here is simply to discover the True Path  
and the Source of the True Prophet  
so that each one can unravel and discover the Mysteries of Life  
for their self.**

**In this particular letter  
it has been my purpose to describe  
the third type of soul.  
The possessors of this type of soul  
provide guidance and reason to society.  
While they are not so much its conscience  
as those of the second type  
they nevertheless are the providers of order  
for all.**

**But as with all types of souls  
their strengths can become their weaknesses  
if they are misused.**

**And as with all types of souls  
they have their preference as to type of religion,  
type of employment,  
type of enjoyment and association.**

**These souls delight in reason and logic,**

**and when properly trained and educated  
help direct society in the paths of science,  
and discipline.**

**These souls can become engineers,  
lawyers, philosophers and theologians.  
They are also a proper source for doctors,  
teachers, lawyers, scientists of every sort,  
both in the social and physical fields.**

**In misdirected pursuits  
they lead humanity into materialism,  
and greed and inharmony.  
They can be the source of great benefit  
or great evil, for they bear  
the authority of control in society.**

**In the next and final discussion of the four types of souls,  
I shall describe the fourth type of soul  
and then go on in later letters to some matters about  
the nature of the soul itself  
and how it finds Truth.**

**Peace and love,  
Bruce Beach  
DawnSayer@webpal.org**

**MENU: [HOME](#) » [Reconstruction](#) » [Recovery](#) » [Renewal](#) » [Four Souls Directory](#)**

---

---



# POP12 - The Soul of Spirit

If you have some suggestions or comments you would like to pass on to me about these pages you may do so at: [DawnSayer@webpal.org](mailto:DawnSayer@webpal.org)

---

**The fourth of the four types of souls may be called the Mystical Soul or the Soul of Spirit.**

**Those of the Mystical Soul, walk the Path of Intuition, and are potentially of the highest and most enlightened type. This type of Soul seeks God through Intuition, and God informs it of its relationship to God.**

**But the danger of this soul is that it can also most readily fall most deeply into the abyss of vain imaginings.**

**Substantial numbers of them used to inhabit our mental institutions, until the recent open door policy, and now they often wander the streets.**

**Among some I have as personal friends, is one who claims to be Jesus, another Sarah the Wife of Abraham. One believes that he is from Venus, (how many Venetians do you count among your friends?), and numerous ones have been UFO abductees and so forth.**

**The Mystical Soul is a Beautiful Gift, but oftentimes,**

**I feel not one to be envied.  
Nevertheless, among strange,  
and even the irrational ones  
they often have insights  
that have often astounded me.  
For this reason alone,  
I count them as dear friends.**

**As a percentage of present day society,  
about 60% are souls of self,  
20% souls of love,  
and 20% souls of reason.  
I recognize that adds up to 100%,  
and it is the "abouts" that make the difference,  
because they leave some small percentage  
that are the souls of spirit.**

**I myself am a soul of reason.  
It makes no difference.  
Each of us are what we are.  
In a sense we are all born equal  
- just different.  
It does no good for one who is a male  
to wish that they were female,  
or vice versa.  
Nor one who is of one race  
to wish that they were of another.  
We are what we are,  
but all loved by God.  
None of us will rise  
to the full potential and opportunity  
that God has provided for us  
no matter what state that we are in.**

**The soul of spirit,  
must travel the same paths to Truth,  
as anyone else.  
Those Paths are also Four,  
and I shall describe them  
in the following four emails.**

**The souls of spirit  
have their particular gifts**

**and their particular hazards  
like every other type of soul.**

**This is a particularly difficult  
and dangerous time for them,  
if they are living in the present day  
because the darkness of the age  
can easily mislead them.**

**They should properly be  
the light unto the world,  
but when they themselves are dark  
then it is darkness upon darkness.**

**In their occupations,  
they are often poets,  
and some of the more successful,  
(although they do not seem to often be successful,  
by the world's monetary definitions),  
have been in occupations like psychologists.**

**But, for the most part,  
in the terms of this world,  
they appear to be among the alienated.  
Most of the alienated,  
come from other types,  
particularly the first type,  
but nevertheless I have most usually,  
found the Mystical Souls among them  
as bag ladies, mental patients, hobos and transients,  
sometimes living as hermits,  
other times in communes, monasteries, and ashrams.**

**Likewise,  
Be assured that most of the individuals,  
in those situations and locales  
are not among the Enlightened,  
or even of this type of soul,  
but we must be careful not to judge them  
by the eyes of the world,  
because God says that He leads them on their way,  
and sees them with different eyes than we do.**

**There is of course much more that I could say  
about these souls, and  
there are many other things  
that I might discuss with you  
about the different types of souls  
and about the nature of soul itself.  
Many questions that people have  
about the purpose of life  
and life after death.  
Indeed the questions would become endless.**

**However, as I have stated many times,  
the purpose of this series is none of that,  
but rather its purpose is to show you the Path  
to the True Prophet  
so that you may discover all those things  
for yourself.**

**Until my next letter,  
when we shall step forth,  
on the first of  
the Four Paths to Truth.**

**Peace and love,  
Bruce Beach  
DawnSayer@webpal.org**

**MENU: [HOME](#) » [Reconstruction](#) » [Recovery](#) » [Renewal](#) » [Four Souls Directory](#)**

---

---

**MENU: [HOME](#) » [Reconstruction](#) » [Recovery](#) » [Renewal](#) » [Survival](#)**

# Essays on the The Four Paths To Truth

by Bruce Beach

These essays are a continuation in the POP series which which were originally sent out in an email newsletter.

The intent of the series was is to lead the reader through such subjects as the nature of the soul and how it recognizes God through the Four Paths to Truth, and then on to presenting The Most Great Proof.

The essays presented here deal with nature of the search for Truth on the The Four Paths to Truth.

If you have some suggestions or comments you would like to pass on to me about these pages you may do so at:

[DawnSayer@webpal.org](mailto:DawnSayer@webpal.org)

If you wish to enter into a discussion with me regarding religion - I highly welcome that. I have some [religious premises](#) that I would like you to review first, and let me know regarding any about which you disagree to help me better understand any points that you are making.

POP13 - [Authority](#)

POP14 - [The Senses](#)

POP15 - [Reason](#)

POP16 - [Intuition](#)

**MENU: [HOME](#) » [Reconstruction](#) » [Recovery](#) » [Renewal](#) » [Survival](#)**

---

---

# POP13 - Authority

If you have some suggestions or comments you would like to pass on to me about these pages you may do so at: [DawnSayer@webpal.org](mailto:DawnSayer@webpal.org)

---

**In this next four letters,  
of the POP Series,  
I am discussing  
the Four Paths to Truth.**

**There are ONLY four possible paths.  
Each and every type of soul,  
must travel each and everyone of the paths,  
if they are to find the True One.**

**The most used,  
the most useful,  
Path is  
Authority.**

**This path  
is the most beloved path,  
of the Self Type of Soul,  
and yet it must too travel  
the other paths also.**

**And all the other types of soul,  
must most certainly travel this path.  
All souls learn over 90%,  
way over 90% of what they learn,  
through this path of authority.**

**If we were isolated in a closed room,  
or were on an island by ourselves,  
and had no teachers,  
from the present or the past,  
we would unlikely never even learn**

**how to turn the door knob or means  
of getting out of the room or off the island.  
So we are taught by authorities.**

**First it is our parents,  
then our teachers,  
and ministers and Sunday School teachers.  
We learn from books,  
and magazines,  
and newspapers,  
and the TV, and movies,  
and many other places  
that we hear people say things.**

**For the most part,  
we do not have time to check it all out,  
for ourselves,  
so we most often separate conflicting opinions,  
by asking the source,  
and accepting the source we respect.**

**Who said that?  
The doctor, the lawyer, the minister,  
the teacher, our parents.  
Ahh then, that must be right,  
because they are our authority.**

**We can do no otherwise.  
Even the doctor and pharmacist,  
must rely upon the Pharmaceutical Book,  
because they do not have time to go check out  
the effect of every drug personally.**

**The Engineer must rely upon the Engineering manual,  
because he cannot test the strength of everything himself.  
EVERY profession relies upon its authorities,  
whether medical, scientific, or religious,  
because no one has time to check it all out,  
for themselves.**

**I could go on at much greater length about  
how AUTHORITY is so important as our source of Knowledge,**

**BUT, on the other hand,  
AUTHORITY is the main block and obstacle,  
to any new advances in knowledge.**

**EVERY new idea,  
scientific invention,  
discovery of a law of science,  
is the repudiation of Authority,  
which previously had said,  
that it was not THAT way,  
or otherwise the new idea is nothing new,  
but simply the application of old existing principles.**

**So, there we have the First, and Foremost,  
Path to Truth.  
Authority.**

**Tomorrow,  
the Second Path.**

**Peace and love,  
Bruce**

**MENU: [HOME](#) » [Reconstruction](#) » [Recovery](#) » [Renewal](#) » [Four Paths Directory](#)**

---

---



# POP14 - The Senses

If you have some suggestions or comments you would like to pass on to me about these pages you may do so at: [DawnSayer@webpal.org](mailto:DawnSayer@webpal.org)

---

Here now in the POP series  
I am presenting  
the Second Path to Truth.

Each of the Paths are preferred  
by one of the Four Types of Soul.  
But each type of soul  
must travel each of The Four Paths.

The four paths develop in the individual,  
somewhat in the progressive order  
that I have named the four types of souls.

The second path is the path of the senses,  
and is the one preferred by the Loving Soul.  
It is expressed in their art and music,  
in their love for nature and life  
and yes in the expression of love called sex.

The senses are generally listed as five.  
Sight, Sound, Taste, Odor and Touch.  
If it were not for the senses,  
we would be senseless.

Some are so convinced of this  
that they think that when the body  
ceases to sense,  
we cease to exist,  
or that we then become so nebulous,  
as to be practically non-existent.

But, that is another matter.

**In this world,  
we test everything by the senses.  
For the physical scientist  
if it cannot be seen, or heard,  
touched or tasted or smelled,  
it does not exist.**

**Sometimes, oftentimes,  
the scientist uses instruments  
to extend his senses,  
and there is no sense possessed  
by humans  
but that some kind of animal  
possesses it 10 fold.**

**But no matter how refined the sense  
or instrument  
the senses can always deceive.  
Examples can be given for each of the senses,  
but I shall let one suffice here.  
We look at the dawn or sunset,  
and the sun appears to move,  
but most people today believe  
that it is the earth that is moving  
and that the sun is standing relatively still.**

**Illusions, mirages, and their like are numerous.  
No astronomer can see what is.  
The observed pattern in the sky  
is made up of light from the stars.  
Some from stars at one distance,  
and other from stars where the light left there  
thousands of times earlier than from the first star,  
but all the light arrives to the astronomer at the same time.  
Not showing where it is,  
relative to the other stars at this moment,  
not even showing where it was,  
in actual physical relation to the other stars,  
of for that matter whether it even still exists,  
but rather showing an illusion  
of what could never have collectively been.**

**This line of thought extends**

**into the work of the physicist.  
The psychologist knows that all we know  
is perception in the mind.  
So, while the senses are necessary to that perception,  
we know that they are fallible,  
and can never be considered  
an infallible path to the Truth.**

**The world of sense  
is what the Hindu religion calls Maya,  
that is to say  
the world of illusion.  
In western philosophy and metaphysics  
such as that of Immanuel Kant  
it is recognized not to be the "ding ang sich",  
"the thing in itself".**

**Advanced thinkers,  
physicists,  
philosophers,  
all who strive to reach beyond illusion  
from matter unto mind,  
recognize the limitations of the senses  
and the human mind.**

**While we could discuss this subject for hours,  
and it is a very popular subject today,  
our purpose here has been only to recognize  
that the Path of the Senses,  
is a fallible path  
and that while we must travel it  
we must still seek Truth elsewhere.**

**And thus,  
tomorrow,  
on to the Third Path.**

**Peace and love,  
Bruce  
DawnSayer@webpal.org**

**MENU: [HOME](#) » [Reconstruction](#) » [Recovery](#) » [Renewal](#) » [Four Paths Directory](#)**



# POP15 - Reason

If you have some suggestions or comments you would like to pass on to me about these pages you may do so at: [DawnSayer@webpal.org](mailto:DawnSayer@webpal.org)

---

**In this POP Series,  
I have so far discussed  
Authority and the Senses.  
What else is there?**

**Reason.  
The beloved path of the third type of souls.  
The Reasoning Souls.  
One can figure out the truth by REASON.  
REASON is God's GREATEST gift to man.  
It is what most distinguishes man from the animals.  
His ability to hold and manipulate abstract thoughts.**

**But, reason is only logic.  
Like found in a computer.  
Give a particular set of premises,  
it can prove anything that follows from those premises.**

**However, human reasoning is not even as good as machine reasoning.  
It is often faulty.  
Given the few rules of a chessboard,  
which is limited to 64 squares,  
look at how often humans make mistakes,  
in playing chess.**

**Life is MANY, MANY, MANY times  
more complicated than a chessboard.  
There are a great number MORE parameters,  
so when we go to reason about economics,  
politics, religion, or any thing else of this world,  
we are much more likely to make a mistake.**

**And we make mistakes all the time.  
Look at a computer program.  
Very few rules as compared to life.  
Yet how often is a computer program  
of any length written with out bugs?  
Just bugs regarding the computer rules,  
so that it will not run at all.**

**And then there are very often bugs  
regarding the purpose of the program itself.  
Reasoning is often very inaccurate.**

**But the real problem is that  
even if it is accurate,  
it depends upon the premises with which it begins.**

**So, Reason Alone, is not a sure guide to the Truth.  
Indeed, while it is God's greatest gift to man,  
it is VERY fallible.  
Thus we are left with the  
Fourth Path.**

**And that tomorrow.  
Peace and love,  
Bruce  
DawnSayer@webpal.org**

**MENU: [HOME](#) » [Reconstruction](#) » [Recovery](#) » [Renewal](#) » [Four Paths Directory](#)**

---

---

# POP16 - Intuition

If you have some suggestions or comments you would like to pass on to me about these pages you may do so at: [DawnSayer@webpal.org](mailto:DawnSayer@webpal.org)

---

Now in the POP Series  
we come to The Fourth Path to Truth.  
It is the chosen path of the  
of the Fourth Type of Souls.

We can call it by many names -  
Testimony of the Holy Spirit,

- Conscience
- Inspiration
- Intuition
- Enlightenment

or any one of its many other attributes.

It is the BRIGHTEST Path to Truth.

Without this Divine Spark,  
no discovery,  
religious or  
scientific  
can be made.

Without it,  
the processing of reason  
and the human brain  
would be as dead  
and unimaginative  
and uncreative  
as a computer or  
any other machine.

**Every scientific discovery,  
every advance in human thinking,  
comes from In-sight,  
sight from with-in.  
Sight from beyond,  
beyond the boundaries,  
that existed before.**

**That Divine Spark  
rests within each of us,  
so long as we breath,  
and have life.**

**Every student of mathematics,  
draws upon it to initially comprehend  
that  $2+2=4$ , or any higher concept.  
For every learner,  
each and every concept,  
comes as a new insight,  
a new manifestation of the intuitive.**

**This power of the mind,  
soul,  
like all others  
is developed through practice.  
The power of reasoning,  
using the brain,  
like any other muscle,  
must be developed through exercise.  
The storing up of knowledge,  
from authority  
does not come in a minute.  
All the skills of the senses,  
being able to sing  
like an opera star,  
or observe  
like a diagnostic physician,  
or to listen, or feel,  
require a degree of training  
that most never master  
or even realize exists.  
Most particularly is this true  
of man's highest mental capacity,**



**intuition.**

**Concentration,  
Contemplation,  
Meditation,  
are skills still largely undeveloped,  
in the majority of mankind.  
Yet, these are the disciplines needed  
to develop intuition.**

**It seems to come  
unheralded and unbidden,  
but be assured  
never to the unprepared.**

**Intuition is the brightest,  
most joyful,  
most beautiful path to Truth.**

**And yet,  
intuition is the DARKEST,  
most misleading,  
path of stupid superstition  
and vain imaginings.  
In this path,  
as many are led astray,  
with the possible exception of  
authority,  
as in all the others combined.**

**As great a barrier  
as may be the senses,  
with its false sense of reality,  
and its inducements of idle pleasures,  
As faulty as man's reasoning  
may ever be,  
intuition alone can sweep the soul  
into the paths of error  
with a degree of confusion  
from which only by the  
Grace of God  
will one ever be recovered.**

**For it is intuition  
that whispers into the ear  
of every convinced believer,  
ONLY my truth is real,  
all the others are false.  
Only you are safe and saved,  
all others have gone astray.  
But reason stays its claim,  
because how can there be  
so many different claims  
to be the one and only truth?**

**And so,  
we have examined the  
Four Paths to Truth,  
and have found none  
to be infallible.  
Some would say there is  
a fifth path.  
The eclectic path  
of combining all four.  
But while this is the proper thing to do,  
and the SUREST path,  
it too still remains fallible.**

**And so,  
in the human condition,  
we remain BELIEVERS,  
NOT KNOWERS  
of ABSOLUTE CERTAINTY.**

**And so,  
some become discouraged,  
and say,  
since I can know nothing  
of a certainty,  
I will believe nothing.  
I will be a skeptic  
and a scoffer.  
Let others be subject  
to their idle fancies  
and vain imaginations,**

**I will remain steadfast  
in my knowledge  
that they can know NOTHING.**

**But, my dear friend,  
THAT is the path to DEATH,  
UNBELIEF,  
Dissolution,  
and Chaos.  
Nothing becoming nothing,  
yielding nothing,  
attaining nothing.  
Nothing.**

**Every Vibrant Soul,  
must grasp reality,  
as it is presented to us.  
It must travel each  
of the Four Paths  
to the best of its ability,  
and remain always open to change,  
in recognition of the fact that it  
is fallible.**

**For this is the Path of Power  
of both Science and Religion.  
Building upon the Four Paths,  
and discovering reality,  
TESTING it,  
USING it,  
Re-examining it,  
Improving upon our comprehension of  
IT.**

**For while our feet remain anchored  
in the mud and morass of DOUBT,  
our spirits soar upon the  
Paths of Truth.  
Building bridges and skyscrapers,  
traveling to stars,  
observing the Macrocosm  
and the Microcosm,  
evidencing the Power of**

## **Accomplishment.**

**And then,  
we have it upon the Best of  
Authority,  
from those Divine Prophets,  
that if that soul asks,  
it Will receive,  
if that soul knocks,  
it Will be opened unto it,  
and THAT seeker  
will be guided from shoals  
of insecurity and Unbelief,  
to the secure safety of the bay  
of Belief in God,  
and that which He has Revealed.**

**Thus have I concluded  
my explanation of  
the Four Types of Souls  
and  
the Four Paths to Truth.  
In my next letter  
I shall proceed onto what is called  
The Most Clear Proof  
in our journey to discover  
the Source of Truth  
and  
The True Prophet.**

**Peace and love,  
Bruce  
DawnSayer@webpal.org**

**MENU: [HOME](#) » [Reconstruction](#) » [Recovery](#) » [Renewal](#) » [Four Paths Directory](#)**

---

---

# Essays on the The Most Clear Proof

by Bruce Beach

"The Most Clear Proof" as presented here in a continuation of the POP Series which was originally a series of email essays whose intent was to lead the reader through such subjects as the nature of the soul and how it recognizes God through the Four Paths to Truth, and then on to presenting The Most Great Proof about who Jesus really was.

In these essays we examine some tests for reality and sanity. And a different paradigm regarding location and time than you were taught in school - plus the definition of "Manifestation", which is key and most difficult concept to comprehend.

The concepts presented here completely changed my world view and the world view of many others who took the time to master them. I hope that you will take the time to carefully study through these 14 essays. Some are just a matter of reading them. Others among them take careful thought and calculation. You need take out pencil and paper and "do the numbers" for yourself.

If you have some suggestions or comments you would like to pass on to me about these pages you may do so at:

[DawnSayer@webpal.org](mailto:DawnSayer@webpal.org)

If you wish to enter into a discussion with me regarding religion - I highly welcome that. I have some [religious premises](#) that I would like you to review first, and let me know regarding any about which you disagree to help me better understand any points that you are making.

---

## The Essays

The Proof that Jesus was the Christ

POP17 - [Most Clear Proof - Introduction](#)

POP18 - [Most Clear Proof - Numbers](#)

POP19 - [Jesus](#)

POP20 - [2300 Days](#)

## Expectation of the Return of Christ

POP21 - [Year 1844](#)

## A New Paradigm

POP22 - [Responses](#)

POP23 - [Where](#)

POP24 - [When](#)

POP25 - [Manifestation](#)

POP26 - [Revelation](#)

## The Mathematical Proof

POP27 - [First Step](#)

POP28 - [Next Steps](#)

POP29 - [Final Step](#)

POP30 - [The Final Analysis](#)

**MENU: [HOME](#) » [Reconstruction](#) » [Recovery](#) » [Renewal](#) » [Survival](#)**

---

---

# POP17 - Most Clear Proof - Introduction

If you have some suggestions or comments you would like to pass on to me about these pages you may do so at: [DawnSayer@webpal.org](mailto:DawnSayer@webpal.org)

---

## Intro to the MCP

**This is an introduction to the Most Clear Proof.  
I am going to pause here a moment  
and recap where we have been  
and to map out where we are going.**

**First I described the Four Types of Souls  
and invited you to introspectively determine your type.  
This is important so as to understand  
how and why you will make the responses that you do  
on the journey to Truth.**

**Secondly, we described the Four Paths of Truth,  
and saw that while each of them are fallible,  
that we must use each of them  
on the journey to Truth.**

**What I am going to do now will be a shock  
to many of my non-Christian readers.  
If you subscribe to a New Age Religion  
or No Religion,  
please follow, nevertheless, what we are going to do.**

**Almost all my readers were raised in a  
"nominally" Christian culture  
and therefore you will have no problem  
in following the presentation  
if you will just make the effort.**

**What I am going to present is a  
mathematical proof**

**that Jesus was (is) the Christ  
and that the Bible is a reliable source of prophecy.**

**This is not going to hurt you in any way.  
Do not be afraid -  
I am not trying to turn you into  
a flaming Fundamentalist.  
Believe me, I get flamed many times a day.**

**As traumatic as you may feel  
that such a change in viewpoint  
might be for you,  
you may rest assured  
that the things to follow  
will be even more of a challenge  
for our Christian Friends.**

**The growth in Truth is  
always a challenge  
for all of us.  
Myself included.**

**After the mathematical proof  
about Jesus  
we will take a small pause  
and look at the  
Three Spheres of Reality  
used by psychiatrists  
to determine whether one is sane or not.**

**From there we will pass on to the  
New Paradigm  
that will undoubtedly completely change your life  
if you comprehend it and accept it.**

**It is on the basis of that paradigm  
that I have my own expectations  
about the future.  
At that point you will understand  
why it would have done no good  
to explain to you the source of my expectations  
without your having understood the paradigm.**



**To begin the journey,  
I am going to ask you to read two chapters  
in the Bible.  
This is not a terribly arduous thing to do.  
If you don't have a Bible,  
they aren't hard to come by in our society.  
It really makes no difference which version you use.  
I was raised on the old King James Version -  
but whatever you have or get will be fine.**

**The two chapters that I wish you to read are:  
Matthew 24  
and  
Daniel 9**

**We will start into this next time.  
Not verse by verse,  
but on a mathematical thread.**

**If you follow it through  
I can promise you that it will be an experience  
that you will remember the whole of your life.**

**How many things can you remember from the past,  
that were truly significant to your life  
and that you will never forget.  
On the other hand,  
how many TV shows, Movies, Books,  
conversations, events and so forth  
have you forgotten.**

**Then take the time,  
to do something that will be so significant in your life  
that you will never forget it.**

**Till tomorrow,  
peace and love,  
Bruce  
DawnSayer@webpal.org**

**MENU: [HOME](#) » [Reconstruction](#) » [Recovery](#) » [Renewal](#) » [Most Clear Proof - Dir](#)**



# POP18 - Most Clear Proof - Numbers

If you have some suggestions or comments you would like to pass on to me about these pages you may do so at: [DawnSayer@webpal.org](mailto:DawnSayer@webpal.org)

---

**In the POP series we are now going to examine the math used in the Bible.**

**Matthew 24 is possibly the single most read chapter of the Gospels among Christian's today, possibly surpassing the Sermon on the Mount and the Christmas and Resurrection stories.**

**The reason for this is that it is the chapter in which Jesus prophesizes His return.**

**In the opening verses the Disciples come to Him and ask Him**

**"What will be the signs of His Return".**

**And He answers them, and among those answers is the directive to read and understand The Book of Daniel. (Matthew 24:15)**

**This was what brought us to the Book of Daniel.**

**A remarkable Book in itself, and containing many interesting prophecies, particularly about "the Time of the End".**

**However, our purpose here, is not to examine such prophecies, but rather to show mathematical proof that Jesus was (is) the Christ, and that the Bible is an accurate source of prophecy.**

**Later we shall use the same mathematical techniques in a much more remarkable way**

**and to a much more remarkable degree  
to look at other prophecies in the Bible.**

**The reason that we are using the Bible  
is because it is the cultural underpinning  
of most of you readers  
whether you consider yourself Christians,  
or even religious, or not.**

**If we were in another culture  
such as Hindu, Moslem, or Buddhist,  
then we would use the Scriptures of THAT culture,  
because the TRUTH that we are examining is universal.  
But we are in THIS culture  
so we will use THIS cultures Scriptures  
to restore an appreciation of the Spiritual Foundation  
that underlay this culture but which has become  
temporarily weakened.**

**The basis of time translation in interpreting Bible prophecy is  
well established. The basis of using a day as a year comes from  
Num. 14:34 and Ezek 4:6 and that a week is seven days is of  
course based upon the Creation account. The fact that an average  
month is thirty days is found in the account of the flood.**

**If you wish to confirm to yourself such a detail you can look at:  
Genesis 7:11 and you will find mentioned there  
the Second Month and the Seventeenth Day of the month  
and later in  
Genesis 8:3 there is mentioned 150 days  
and immediately after in  
Genesis 8:4  
the Seventh Month and the seventeenth day of the month.**

**Consequently the above covered a period that was EXACTLY 5 months to the day, (7 months  
minus 2 months equals 5 months)  
which divided into the 150 days gives us an AVERAGE of 30 days per month.  
(5 divided into 150 = 30).**

**The point of all this is NOT to convince you to believe in the story of Noah and the account of The  
Flood,  
but just to show you the NUMERIC Integrity of the Bible and the system that we are using.**

**The math that we will be using is no more difficult than this, but with the following I will conclude today's presentation to allow you to absorb the math up to this point.**

**It is important that we do this in a step by step fashion.**

**Leave out a step**

**and the end result will be questionable.**

**Comprehend them all and it will be unquestionable.**

**Okay, our formulas are as follows:**

- **a. 1 day = 1 year**
- **b. 1 week = 7 days = 7 years**
- **c. 1 month = 30 days = 30 years**
- **d. 1 year = 12 months = 360 days = 360 years**
- **e. dividing of time - 1/2 time**

**a. comes from Numbers 14:34 and Ezekiel 4:6 as mentioned above and is referred to as "prophetic time". Some people refer to references that a 1000 years is as a day for the Lord. This latter does have a scriptural and spiritual meaning but when used in the formulas gives lengths of time so long as to be meaningless to our human experience. Consequently, we use the calculation that a Prophetic Day is a year.**

**b. comes from the Creation account of the 7 days of creation, and that on the 7th day the Lord rested. Without getting into any arguments about whether that was Saturday or Sunday it is still the source of the week having 7 days in our culture.**

**c. the calculation to determine that an average month, or a Bible Prophetic Month has 30 days has been given above in the account about Noah and the Flood with the appropriate Scriptural References.**

**d. The determination of "d" derives from "a" and b and "c" above. That a Prophetic year is 360 Calendar years is simply an extension of the above math. If one Prophetic day = one year and a month is 30 days a Prophetic month is therefore 30 calendar years and the 12 months in a year are therefore 12 times 30 or 360, which is to say that there are 360 Prophetic Days or 360 calendar years in a Prophetic year.**

**e. this is an equivalency example which we will examine in its proper place.**

**To repeat,  
the purpose here,**

**has not been to convince anyone of any of the Bible Stories,  
but rather to simply show the integrity and consistency of Bible Math.**

**Tomorrow -  
an application of these principles  
to begin to demonstrate by this math  
that Jesus was the Christ.**

**Peace and love,  
Bruce  
DawnSayer@webpal.org**

**MENU: [HOME](#) » [Reconstruction](#) » [Recovery](#) » [Renewal](#) » [Most Clear Proof - Dir](#)**

---

---

# POP19 - Jesus

If you have some suggestions or comments you would like to pass on to me about these pages you may do so at: [DawnSayer@webpal.org](mailto:DawnSayer@webpal.org)

---

**One of the most amazing things about Bible Prophecy is the prediction of the re-establishment of Israel. Futurists today have difficulty making predictions 50 years into the future.**

**Look at these:**

-----  
"Computers in the future may weigh no more than 1.5 tons."  
- Popular Mechanics,  
forecasting the relentless march of science,  
1949

-----  
"I think there is a world market for maybe five computers."  
- Thomas Watson, chairman of IBM,  
1943

-----  
"I have traveled the length and breadth of this country and talked with the best people, and I can assure you that data processing is a fad that won't last out the year."  
- Editor in charge of business books for Prentice Hall,  
1957

-----  
"But what... is it good for?"  
- Engineer at the Advanced Computing Systems Division of IBM,  
1968, (commenting on the microchip).

-----  
"There is no reason anyone would want

**a computer in their home."**

**- Ken Olson, president, chairman  
and founder of Digital Equipment Corp.,  
1977**

-----  
**"This 'telephone' has too many shortcomings  
to be seriously considered  
as a means of communication.  
The device is inherently of no value to us."  
- Western Union internal memo,  
1876**

-----  
**The prophecies in the Bible,  
that many people are concerned about  
being fulfilled today,  
were made MANY CENTURIES ago.  
Is it possible  
that there can actually be this kind  
of accurate prophecy?**

**And yet, there in the Bible  
was the Prophecy and Promise for the Jews  
that they would return to Israel and  
it came true CENTURIES later.**

**I am going to tell you now about another prophecy  
that was made to the Jews  
centuries before it came true.**

**Prophecy and the Prophetic Times associated with it  
are difficult for many people to see,  
and therefore  
many people do not recognize its fulfillment  
even when it has occurred.**

**Such was the case with Jesus.  
He claimed to be the Messiah promised to the Jews.  
In fact that was the BASIS of His claim to fame.  
If He was not that ONE then,  
so far as they were concerned,  
it made no difference who he was.**



**But, for TWO THOUSAND years the Christians were not able to prove to the Jews who Jesus was while the mathematical PROOF lay RIGHT THERE in the Jews' own Book of Daniel.**

**This is the reason that we are examining the 4 verses in**

**The Book of Daniel 9:24-27.**

**It is surely not too much to take and comprehend**

**four Bible verses.**

**(Read them for yourself - as Jesus commanded).**

**Verse 24 mentions 70 weeks  
comprised of in  
Verse 25**

**7 weeks  
3 score weeks and  
2 weeks and**

**Verse 27**

**1 week  
-----**

**Everyone should know,  
from the Abraham Lincoln's Gettysburg Address -  
"Four score years ... ago  
our fathers brought forth on this continent....."**

**that a score is 20  
so 3 score is 60.**

**What we have therefore is:**

**7 weeks  
60 weeks  
2 weeks  
1 week**

-----

**70 weeks total as stated in Verse 24.**

**"Seventy weeks to seal up the vision and prophecy  
and to anoint the Most Holy"**

**70 weeks**

**x7 days is of course**

-----

**490 days in Prophetic Terms,**

**(or as we discussed last time)**

**490 calendar Years**

**To measure a time, one must know from where to begin  
and verse 9:25 tells us that this time begins from:**

**"the going forth of the commandment  
to restore and build Jerusalem".**

**That historical date you can obtain  
from a number of different sources.  
Some encyclopedias  
(especially Bible encyclopedias)  
or the marginal notes of some Bibles,  
or other similar references.  
(I have looked it up in many places.)**

**The event is referenced is in Ezra 7:13  
and most scholars (Christian, Jewish and otherwise)  
agree that it occurred in 457 BC.**

**The prophetic date of 70 weeks is broken up into blocks.  
Basically, if we look at 69 weeks  
plus the one last week  
we can see the dates that interest us.**

**69 weeks**

**x7 days is**

-----

**483 Prophetic days or 483 calendar years.**

**483 calendar years minus**

**457 BC takes us to:**

**-----**

**26 AD (or 27 AD depending on how you count in the zero year).**

**Again a Bible Reference will tell you  
that this is when Jesus began His ministry.  
(He was born in 4 BC and 26 plus 4 makes Him 30 years old -  
when He began it,  
which is the age, under Rabbinical Law  
that a man could become a Rabbi or Teacher).**

**Again look in a reference and you will find  
that Jesus was crucified 7 years later in 33 AD  
Seven years is the same as one Prophetic Week  
and this means that He fulfilled the Covenant (The Promise)  
to the Jews for one week  
and just EXACTLY at the TIME  
as the Scriptures had prophesized.  
(Do read the whole 4 verses in Daniel -  
the tell about the Messiah being cut off -  
but not for Himself -  
because He was a sacrifice for the whole of mankind).**

**But down through the centuries,  
the Christians were never able to show this prophecy,  
to the Jews,  
because as The Book of Daniel says,  
it was a SEALED BOOK  
and the MEANING was not opened  
until the Time of the End.**

**That too is an interesting story -  
but for next time.**

**There are many details about this prophecy  
that I could talk about for hours.  
In fact I used to conduct courses on it that took weeks.  
But we are not going into details here.  
The following is a chart that I have made up to give you  
an overall view.**

**Ezra 7:13**

**457 BC**

**Dan 9:25 | 7 weeks 408 BC completion of rebuilding**

**| (49 years)**

**Dan :25 | 7 weeks & 62 weeks = 69 weeks 26 AD John**

**| (49 years) & (434 years)= (483 years) the Baptist**

**Dan 9:27 | 69 weeks & 1 week= 70 weeks**

**| (483 years) 7 years=490 years**

**Dan 9:24 | 70 weeks 33 AD**

**| (490 years) Christ**

**The Prophecy of the Time of Christ**

**Peace and love,**

**Bruce**

**DawnSayer@webpal.org**

**MENU: [HOME](#) » [Reconstruction](#) » [Recovery](#) » [Renewal](#) » [Most Clear Proof - Dir](#)**

# POP20 - 2300 years

If you have some suggestions or comments you would like to pass on to me about these pages you may do so at: [DawnSayer@webpal.org](mailto:DawnSayer@webpal.org)

---

**So, there was mathematical proof for the Jews,  
all along,  
that Jesus was the Christ.  
But they never saw it,  
and they never accepted Jesus for other reasons.**

**The reasons are listed in the New Testament,  
and they are many, many.  
Basicly, He did not fulfill their expectations.  
They had THEIR tests  
and He did not meet them.**

**Of course they said that their tests  
were from Scripture  
and that since He did not fulfill them  
that He was a false prophet.**

**Just as the Jews expected their Messiah  
to come and Establish an Earthly Kingdom  
so too today  
do the Christians expect Him to come and set up a throne  
where every knee shall bend and every tongue shall confess,  
in some similar earthly fashion.**

**Just as the Jews expected a time of Milk and Honey,  
so do many Christians today  
expect a Millenium of a Thousand Years of Peace  
with Lions literally lying down with Lambs.**

**Some then and now expected phenomena  
similar to what is called the Ressurrection,  
or Rapture,**

**or other Marvelous Miracles.**

**They had then,  
and Christians have now  
quick little tests -  
Is the person claiming to be The Return**

**living or dead**

**- some Christians require  
that He comes down from heaven  
with nail prints in His hands,  
and that He not be buried anywhere.**

**The Jews had believed that Elijah,  
(who the Bible said had never died but had been translated),  
would come first.**

**"Where is Elijah, (who was to come back down from heaven),  
they asked."**

**"John the Baptist", said Jesus.**

**"Can't be - he was born of a woman", they replied.**

**Where did you come from, they asked Jesus.**

**Nazareth.**

**"The Book says no good will come out of Nazareth',  
said they, quoting their Scripture.**

**What happened to Jesus, they asked for centuries later.**

**Crucified.**

**"Only those accursed of God are crucified", said they,  
again quoting their Scripture.**

**And for century after century,  
the Rabbis pointed out,  
that the promise of the Messiah, their saviour,  
was that:**

**He would gather the Jews together,  
"as a mother hen gathers her chicks"**

**as promised in Isaiah.**

**But the very opposite happened.  
At the time Jesus came,  
the Jews WERE together in Israel  
although under Roman prosecution  
and then they were banned from the country  
and never allowed to return again  
until the Edict of Toleration was given  
in 1844.**

**So what other proof would a young Jew need  
from his rabbi,  
that Jesus was not his Messiah,  
not the saviour of the Jews.  
But the rabbi could and did present him  
with much more proof and evidence.**

**And now this story takes a strange, strange twist.  
Because in the last century their grew up  
among the Christians and Moslems  
what was called  
The GREAT Expectation  
about the Return of Christ.**

**These numbers that I am telling you about  
became WIDELY known.  
There is evidence that they were first developed by one  
whom many even today recognize as the greatest scientist  
the world has ever known. - Isaac Newton.  
His literary assistant, Edmund Halley,  
discoverer of the periodicity of comets  
and after whom Halley's Comet was named  
contributed much to the authenticating of calendars.**

**As a result of these numbers,  
many, many people began to expect the return of Christ,  
in a particular year.  
That year was 1844.  
They arrived at that number because if one takes the verse -**

**Daniel 8:14**

**And he said unto me,  
Until two thousand and three hundred days;  
then shall the sanctuary be cleansed.**

**[We are not dealing here with how these verses  
have been interpreted  
or might be interpreted  
but as before are only interested in  
the mathematics and the dates.]**

**This date, and using the same starting point as we used before,  
yields -**

**2300 Dan 8:14  
-457 B.C.  
-----  
1843 A.D.**

**1844, rather than 1843,  
is taken as the year of the GREAT EXPECTATION  
and the Great Disappointment  
for the return of Christ.  
There are several reasons for this.  
One is that there is no year zero.  
The other reasons are the differences between lunar  
and solar calendars so that 1843 actually ends in 1844.  
And still other explanations are given  
as to which month in the year actually begins the year.**

**[It used to be that New Year's Day was in March.  
A quick proof can be given.  
The fifth and sixth months  
were changed to the names July and August  
after the Roman Emperors Julius and Augustus Caesar.  
Sept means seven and hence September.  
Octo means eight and hence October.  
Like in octave, octogon or octopus,  
an eight legged sea creature.  
Novem means nine and hence November.  
Deca means ten and hence December.  
Like in decade, decalog and even decimal.  
January was the eleventh month**



**but was renamed in honor of the Roman God Janus.  
February was the last month and this is why  
we always put any extra days of a year,  
like in a leap year, or leap century,  
at the end of February.  
So the new year begins in March.  
Actually on March 21st, at the Spring Equinox.]**

**Prior to 1844 there were many millennialist groups.  
With the possible exception of the year 1000  
there had never been such intense expectation  
in Christendom at one single time.  
But the really phenomenal matter is  
that similar expectations were  
equally intense at that time in some Moslem sects.  
Today, the Seventh Day Adventists,  
the Latter Day Saints  
(hence these two groups' names)  
and some fundamentalist groups  
still maintain that interest.  
The interest was not by any means confined  
to either Protestant Christianity  
or the United States.  
Both the Christian Templars from Germany  
and the Carmelite nuns went to Israel  
prior to 1844  
in expectation that Christ would appear there in 1844.**

**The single largest and most active group  
in the United States,  
with the possible exception of the Latter Day Saints,  
was the Millerites,  
the predecessor of the Russelites, Bible Students,  
Millennial Dawn, and Watchtower,  
all synonyms for the Jehovah's Witnesses  
which took the latter name in 1931.  
Their disappointment  
in the original 1844 expectations  
led them to formulate a new date of 1914,  
about which their literature still  
concedes "wrongful expectations".**

-----

**The thesis here is that  
Christiandom's original interpretation (expectations)  
of the dates were absolutely correct,  
just as were the Jewish interpretations (expectations)  
for the first quarter A.D..  
What was wrong was the nature of their expectations.  
1844 was again a repeat of what happened  
in the first century of the Christian Era.**

**But enough for one letter.  
Perhaps too much.  
God willing, we shall continue again tomorrow.**

**Peace and love,  
Bruce  
DawnSayer@webpal.org**

**MENU: [HOME](#) » [Reconstruction](#) » [Recovery](#) » [Renewal](#) » [Most Clear Proof - Dir](#)**

---

---

# POP21 - Year 1844

If you have some suggestions or comments you would like to pass on to me about these pages you may do so at: [DawnSayer@webpal.org](mailto:DawnSayer@webpal.org)

---

**Yesterday's presentation was so paradigm shaking that many undoubtedly could not believe what was said.**

**That the 1844 GREAT EXPECTATION of the Christians was fulfilled and that Christ returned.**

**However, the Christians failed to recognize The Return just in the same way and practically for the same reasons as the Jews failed to recognize Jesus at the beginning of the first century.**

**Many Christians would say, "Well, if it didn't make any more difference than that - if my expectations about rapture, the graves opening, and the Kingdom of Heaven on Earth, were not any more fulfilled than that it doesn't make any difference to me."**

**Just as many Jews said, "Well if that is the way it turned out for God's Chosen people and we ended up being booted out of Israel and going through the Holocaust at the hands of a nation that called itself Christian - then who needed Him?"**

**To answer some quick questions:**

**"Where did Christ return?"**

**In Persia.**

**"When?"**

**1844**

**"What was His Name?"**

**The Bab, Meaning the Gate**

**or Forerunner,**

**declared Himself on May 22, 1844.**

**"Where is he now?"**

**He and His Successor,**

**Baha'u'llah are buried near each other**

**at Mt. Carmel in Haifa, Israel.**

**"How many people know this?"**

**There are now over 10 million Baha'i's  
world wide.**

**There is much more  
that can be said about Them.  
Particularly regarding Their prophecies  
for the present and future.**

**But I realize that this paradigm  
is so shaking  
I shall pause here for my next 3 POP emails  
while many go screaming for the exits  
quoting the same kinds of quotes  
as were quoted about  
Jesus' appearance at the first century.**

**So a pause or intermission to allow a mass departure,  
and during which we will examine  
the Three Tests of Reality  
used by psychiatrists to determine if a person is sane.**

**Because I am sure that many will wonder how  
a sane person can believe that Christ has returned.  
But you must remember that this proof started out  
for those who did not particularly believe  
in Christ and the Bible  
in the first place  
although they had been raised in a Christian culture.  
Our purpose was to raise their confidence in the Bible**

**as a source of Prophecy  
through this mathematical proof that  
Jesus was the Christ.**

**After the following 3 letter intermission,  
we will return to SIMPLER but even more astounding,  
indeed,  
MUCH MORE ASTOUNDING mathematical prophecies  
from the Bible  
that have gone TOTALLY unrecognized by the Christians.**

**Eventually, I will explain and summarize  
the paradigm upon which all this has been based.  
Those who can comprehend and accept that paradigm  
will then be able to comprehend  
the nature of the prophecies  
that I have mentioned before  
but have not been able to present  
because people knew nothing of  
the paradigm upon which they are based.**

**Peace and love,  
Bruce  
DawnSayer@webpal.org**

**MENU: [HOME](#) » [Reconstruction](#) » [Recovery](#) » [Renewal](#) » [Most Clear Proof - Dir](#)**

---

---

# POP22 - Responses

If you have some suggestions or comments you would like to pass on to me about these pages you may do so at: [DawnSayer@webpal.org](mailto:DawnSayer@webpal.org)

---

A slight detour.

I have decided to share with all of you four responses that I have received and my answer to two of them.

I have selected these as being typical of quite a number.

I also very much appreciate the affirmative responses I have received. They mean a lot to me.

-----  
From D.  
-----

*It has been interesting to know your views over the past 2 years. As you expected, many will leave your list after your last mailing. I choose to be one.*

*I feel that you have been deceived with one of many false messiahs that the Bible prophesied would be appearing during these last days. I hope and pray that your eyes will be opened to the fact that JESUS will appear again just as he said and will take his church to be with him. I believe it will be very soon. Trust in Him only for the forgiveness of your sins and then I can look to meeting you in heaven.*

-----  
From K.  
-----

To save me from deciphering anymore of you paradigms let me cut straight to the point....do you believe that Jesus was/is the Son of God...and am I to understand that you believe Jesus returned in 1844 and is now dead and buried at Mt. Carmel.

-----  
My Answer to K.

-----  
**The questions that you ask K,  
are impossible to answer to you meaningfully.**

**That is the point of a paradigm.  
It is a view of the world.**

**Someone who lived in a very hot country  
and who had never heard of or seen ice  
would find miraculous  
the story of someone walking across a river.  
The explanation that it had frozen  
would be incomprehensible to them.**

**Likewise would be the explanation  
to someone who had never seen or heard of a microscope  
that the small little bugs that were harming them  
were not really invisible  
or some type of evil spirits.**

**Your statements  
that you want to understand the answers  
but not understand the paradigm  
would mean that the answers would seem  
impossible  
ridiculous  
illogical  
or otherwise out of touch with reality.**

**Whereas, as in the above examples,  
a new paradigm gives one a higher sense of reality  
and permits them to understand things  
that they have not understood before.**

**A new and higher paradigm  
explains all that was believed before  
and explains WHY it was believed in that way before.**

**As regards Christ Jesus,  
the problem with the Christian view  
is that Christians have too small a view of Him.  
You may think this a strange statement  
when you think that you put Him at the center of everything,**

**Preceding everything, the Purpose of everything.  
But the statement remains true - too small a view.  
But you cannot know what I mean -  
without a paradigm shift.**

**Paradigm shifts are as necessary in Religion as they are in Science.  
In Science, the Einstein Theory of Relativity was a Paradigm Shift.  
The very idea that two parallel lines could meet,  
or that a clock traveling in space at a high rate of speed  
would reflect that Time had slowed down,  
or that light could bend when passing a large gravitational lens or sink,  
such as our sun,  
or a variety of other such phenomena (he had five proofs)  
was a paradigm shift that many still do not understand.  
It has not penetrated the consciousness of the man on the street.  
Still, for those scientists who have grasped it,  
it has permitted the development of atomic and nuclear energy,  
new methods of constructing materials used in electronics and computers,  
calculations for space travel and explanations for phenomena of astronomy,  
and other control over our physical world  
that did not exist before.**

**The Einsteinian Paradigm did not destroy the Newtonian Paradigm.  
It merely provided a HIGHER explanation and showed the latter  
to be a SPECIAL case.  
Many of my readers believe that Science deals with relative knowledge  
but that religion deals with absolute knowledge.  
However, they are wrong.  
God's REALITY is ONE.  
Science and Religion are the TWO wings of the One Bird,  
seeking to explain the ONE REALITY.  
That Reality is Absolute,  
but because God is Infinite  
our understanding is always relative and can always become greater  
through REPEATED Paradigm shifts,  
so one may as well get used to it  
or they will stop growing through eternity.**

**Do you know what the one unforgivable sin is?  
It is blasphemy against the Holy Spirit.  
This does not mean taking the Name of the Holy Spirit in vain  
like we hear many people use the word God or Jesus,  
but they don't use Holy Spirit in that way**



**(although some Batman followers would try in saying - Holy Smoke).**

**No, this means failure to listen to the Holy Spirit.  
That is to say  
failure to listen to the small calm voice of Truth.  
But rather to remain dogmatic and argumentative.  
With that attitude then one cannot ever understand the Truth.  
Although one may be in error  
so long as they are willing to examine with an open spirit  
something new that is presented to them  
then they can eventually learn to better know the Truth,  
but if they close their mind  
and won't listen and examine  
then they will never find the Truth  
and that is why Jesus said blasphemy against the Holy Spirit  
is the one unforgivable sin.**

**It is time for you to examine  
and to try to comprehend.  
When you understand the paradigm  
well enough that you can explain it to someone else  
then you can say that you understand it.  
Until then you are criticizing that which you do not understand  
and you have no basis for comparison.**

**I have looked in both the boxes.  
I know that what is in both of them is very good.  
But having seen in BOTH of them I can make a comparison.**

**You need to be able to do the same.**

-----  
**These communications from P  
who was apparently forwarded the Four Paths  
but I am not certain that they were read.**  
-----

### ***The First Path***

***There is Only ONE PATH and that is Jesus Christ, and his One holy and apostolic Church. Outside the Church there is no salvation. Today the Church***

*is hard to find so one may say the only ark available is Mary His Mother who does know the way to His Church. P.*

***The Second Path***

*All of this is outside the teaching of the one holy and apostolic Church. Outside the Church there is no salvation. The easiest way to the Church today is through Mary and the Rosary. None else is needed. P.*

***The Third Path***

*Reason is subject to Grace. Grace of God not reason is the greatest gift God has given to men. Without grace, reason is what made Eve and thence Adam take of the forbidden KNOWLEDGE tree. P.*

***The Fourth Path***

*All of this ... comes from the tree of knowledge that was forbidden to Adam and Eve. It begets PRIDE THE ULTIMATE SIN.*

*Reason must be subject to Grace, or faith in Jesus Christ and His Church.. NOTHING ELSE IS NEEDED FOR SALVATION. OTHER THAN TO REMAIN A LOYAL AND FAITHFUL SUBJECT OF JESUS AND HIS CHURCH.*

*The most foolish or unintelligent man, the most unreasoning and humble being, the man of simple faith, THE CHILD is the most assured of heaven. P.*

-----  
**My Answer to P.**

-----  
**Dear P.**

**Your responses show that you believe that there is really only ONE PATH to Truth, that which has been identified in these four essays as The Fourth Path which you would call the Path of Grace, or others might call the Path of the Holy Spirit, or they might call it by some of the other many names besides those that were listed in the essay.**

**Still, the fact abides,  
that you have gotten most of your knowledge,  
and that upon which you base your beliefs  
comes from AUTHORITY  
in this case much from the Bible  
and what you call the  
One holy and apostolic Church.**

**Your type of thinking is what I refer to as Fundamentalist thinking.  
It is often reflected in what I have, in discussion with others,  
identified as "black and white" thinking.  
Very often it is referred to as Dogmatic Thinking.  
Dogma simply means the Teaching of some Authority.  
In your case what you call the One holy and apostolic Church.  
This type of thinking is not, however, restricted to any one sect,  
or even any one religion  
(it could equally well be Christian, Moslem, Hindu, Buddhist or other)  
and most definitely does not need to even be restricted to religious belief,  
as demonstrated in my following response to the following correspondent.**

-----  
**The following correspondence is from F.  
Who has only heard about our discussions  
and has never received copies of the Four Paths.**  
-----

*Why am I not at all surprised that another proponent of prophecy  
"fulfillment" refuses to defend his positions in an open public forum? You  
are all alike. You preach to the choir and hide from having your absurd  
claims answered by an informed opposition.*

*I have a point to contribute that you may want to consider now. Neither you  
nor anyone else can prove a single, verifiable case of prophecy fulfillment.  
If you ever find the courage to put your faith where your mouth is, please  
contact me. I have an internet forum where the debate can be published.*

-----  
**My answer to F.**  
-----

**Can you not see that you are bitter and angry,  
and not open to calm and reasonable discussion.**

**When you make prejudiced and judgmental decisions like -**

*"You are all alike."*

**When you have never even examined this paradigm,  
and have no idea what it is like.**

**Or that I am even alike in that I**

*"preach to the choir"*

**because the audience that is being addressed  
has absolutely no knowledge of the paradigm either.  
Most of them will be resolutely opposed also  
because it does not come from a Fundamentalist background  
or other paradigm with which they are familiar.**

*"and hide from having your absurd claims"*

**You have absolutely no knowledge of the claims of this paradigm  
because you know nothing about the paradigm itself  
and therefore you have no way of knowing whether there are absurdities or not.**

*"answered by an informed opposition."*

**How could you possibly be informed -  
when you know nothing about the paradigm?**

**And why are you in opposition to something that you know nothing about?  
That is an entirely biased, bigoted, and closed minded attitude.  
If another synonym came to my mind I would use it.**

*"Neither you nor anyone else"*

**It is against this type of close mindedness that I am presenting the paradigm -  
the very idea that one can judge the unknowable -  
because neither I nor anyone else can know in advance -  
the capabilities of everyone, or anyone else.  
I realize that in that statement that I also have invoked  
the "paradox of the absolute skeptic".**

*"can prove a single,"*

**In our previous correspondence,  
I explained the limitations of proof,  
and the distinctions between "belief" and "knowledge"  
based upon evidence.  
Did you miss the point?  
If you didn't miss the point,  
then your now stating this,  
is evidence that you are not open to calm rational inquiry.  
If you did miss the point,  
then that demonstrates that you are not capable of such inquiry.  
In either case, then,  
what would be the benefit of trying to pursue such inquiry with you?**

*"verifiable case of prophecy fulfillment"*

**Once again, I have previously pointed out to you  
the nature of evidence and verification.  
It is a matter that was examined at some depth in the Four Paths to Truth.  
Since you have not availed yourself of that presentation  
you do not even know what criteria has been established there  
in this POP series which I call the "Power or Problems of Prophecy".  
The first P stands for Power or Problem -  
one is free to make their own choice between the two.**

*I have an internet forum where the debate can be published.*

**Debate is useless,  
when it is conducted with people who are NOT informed  
and who are NOT of good will.**

**The good will that is necessary is that one must be willing  
and desiring  
of seeking the Truth  
in an unbiased way.**

-----

**I plan to go on to the 3 spheres of reality -  
tomorrow.**

**Peace and love,**

**Bruce Beach**  
**DawnSayer@webpal.org**

**MENU: [HOME](#) » [Reconstruction](#) » [Recovery](#) » [Renewal](#) » [Most Clear Proof - Dir](#)**

---

---

# POP23 - Where

If you have some suggestions or comments you would like to pass on to me about these pages you may do so at: [DawnSayer@webpal.org](mailto:DawnSayer@webpal.org)

---

**Psychiatrists have a quick test  
which they determine  
whether a person is sane or not.  
They determine whether a person is oriented  
to the three spheres of reality.**

**Do they know -**

- **Who they are?**
- **When they are?**
- **Where they are?**

**"Who are you?"  
The psychiatrist asked.**

**"Jesus Christ,"  
was the reply.**

**"Who told you that?"  
asked the psychiatrist.**

**"God",  
was the reply.**

**"No, I didn't",  
came the voice  
from the next cell.**

**We all have our reality tests.  
We do it in accordance with our paradigms -  
that is to say our world views.**

**In these next three emails I am going to present  
a new paradigm about**

- **who,**
- **when and**
- **where we are.**

**The idea here is NOT for you to believe the paradigm.  
It is for you to understand it.  
Proofs will be presented later.**

**First we will begin with  
"where" you are in-**

### **1. A paradigm of the origin of this world.**

**The people asked Moses,**

**"when did the world begin?",**

**and He wrote the story of Creation,  
in the Book of Genesis.**

-----  
**What He gave them  
was a paradigm  
(a view of the world)  
that was comprehensible to them.**

**He did NOT tell them that there were  
other planets in the solar system,  
other galaxies,  
about the immensity that the Hubble shows to us.**

**Ever since the development  
of the telescope  
Astronomers have thought  
with just a bit more powerful telescope  
(the general plea today is for one 15% more powerful)  
they would be able to see to the edge of the universe,  
(or the origins of The Great Bang,  
as they put it.)**



**They have just never mastered the concept of INFINITE.**

**What is to make them think,  
that just as if one gets beyond this solar system,  
that there are other solar systems, in this galaxy,  
and if one gets beyond this galaxy,  
there are other galaxies,  
and that if one got beyond this "island universe"  
there wouldn't be "other" island universes?**

**INFINITE is something Different from BIG or MORE.**

**Even then, the astronomers deal  
with only the PHYSICAL (visible) universe.  
The SPIRITUAL REALITY,  
of which the physical reality is only a shadow,  
is INFINITELY (that word again) more immense.**

**And so where are YOU,  
in all this IMMENSITY?**

**Short answer:**

**Planet Earth.  
Physical Shadow.**

**Locating one's self  
is sort of like the school child problem  
of sending a return address to God.**

**Name,  
street,  
city,  
province,  
country,  
planet,  
solar system,  
galactic arm,  
galaxy,  
galactic cluster,  
island universe,**

**island cluster,**

**where does it end?**

**Doesn't.**

**The problem is that one is dealing with an illusion.**

**The illusion of space.**

**The illusion is that it is reality,**

**but the REALITY is much more IMMENSE than the illusion.**

**In fact, the concept if Immensity is inadequate,**

**so long as it denotes size.**

**Even Einstein and the advanced thinker physicists,**

**say that no matter how real it seems**

**we must remember that Time, Space and Matter,**

**are illusions in our minds.**

**NOT that there isn't a REALITY.**

**A MUCH DEEPER REALITY.**

**But, for the man on the street,**

**these ideas have been incomprehensible.**

**Of course they have been discussed by all philosophers,**

**down through time, way back to the Greeks,**

**and Plato and Socrates.**

**They have been dealt with more in Eastern Religions,**

**and in a few Western Religions, such as**

**Christian Science, and to some degree by Swedenborg.**

**But, for the most part, the man in the street,**

**while he hears about these ideas,**

**he really has just not caught on.**

**The idea still abounds,**

**that the earth is the center of the universe.**

**The center of creation.**

**That all of creation revolves around the descendants of Adam.**

**Physically created in seven days.**

**That it is going to end,**

**and everything with it.**

**That the center of it all**

**is the advent about 2,000 years ago**

**of one particular individual (Jesus),**

**on this one particular rock,**

**whirling about this one particular star.**

**When infants first become aware,  
their Universe centers around their momma,  
and their bassinet.**

**Later to their nursery and members of their family.**

**Eventually to their community and school.**

**Gradually to their citizenship in their country.**

**Most people, today, have not yet grasped the idea  
of their citizenship in The World.**

**Their relationship to a Universe and Cosmos beyond that -  
completely eludes them.**

**Children, in their infancy, naturally have infant concepts,  
of creation and the world about them.**

**This applies to mankind as a whole.**

**An infant race, like the human race**

**(we only have a few thousand years of recorded history)**

**has infant concepts.**

**Young people and teens,**

**often think they have all the answers and understand everything.**

**That is the way many people are,**

**with their pat answers, "The Bible says".**

**For a child, everything revolves around them.**

**For a childish race, everything revolves around it.**

**In its mind,**

**God created everything for It.**

**The purpose of everything is It.**

**The question is,**

**where are YOU in the universe.**

**To answer that**

**you have also to answer the question of**

**when**

**and**

**who.**

**Next time -**

**when.**

**Peace and love,**

**Bruce**

**DawnSayer@webpal.org**

**MENU: [HOME](#) » [Reconstruction](#) » [Recovery](#) » [Renewal](#) » [Most Clear Proof - Dir](#)**

---

---

# POP24 - When

If you have some suggestions or comments you would like to pass on to me about these pages you may do so at: [DawnSayer@webpal.org](mailto:DawnSayer@webpal.org)

---

We are examining a new paradigm of who, when and where we are. We have already looked at where, we are now going to examine *when*.

## 2. An examination of the History and Purpose of Mankind.

Again, in the Bible we see a History set down. The first five books of the Bible, are attributed to Moses.

Just as He wrote an understanding, suitable to the people of the time of how the world was created. So, did he also write an understanding, suitable to the people of the time, of when the world was created.

Some people reject The Bible, because they feel they have a longer view of history. (Others still insist on taking The Bible literally, - creation a few thousand years ago). Both positions are in error.

The Bible is SPIRITUALLY correct. Any seemingly literal statements are RELATIVE. They MUST of necessity be, because they are attempting to describe the INFINITE. To suppose that we are CAPABLE (or indeed may have today ABSOLUTE answers from say science) is at just as infantile a mental stage,

**as believing that the Bible should be believed literally.  
Understanding of the ABSOLUTE,  
always has been,  
and always will be,  
RELATIVE.**

**So, what I am about to present,  
is a new RELATIVE paradigm,  
suitable to mankind's present stage of growth.  
It is simply a HIGHER  
more INCLUSIVE understanding.  
Don't belabor the literalness of it.**

**If you prefer a different paradigm  
about which I have not heard  
that is fine.  
Share it with me.  
I am always on the lookout for enhanced paradigms.**

**Anyway, in this paradigm,  
we first posit the existence of cycles.  
We see them about us everywhere.  
Day and night,  
the seasons,  
life and death,  
generation upon generation.  
Astronomers even pose them for sunspots,  
and the wheeling of the galaxies.  
(The latter being too slow - taking billions of years,  
for us to have actually observed one).**

**Over billions of years,  
stars too are born and die.  
But since man has only observed them  
with telescopes for a few hundred years  
and in recorded history for a few thousand years,  
we have never seen the event,  
from beginning to end.  
Oh, we have seen supernovas,  
and with the Hubble  
some think we have seen star nurseries,  
but we have been around too short a time  
to observe a billions-of-years-long process**

**from beginning to end.  
We can only Hypothesize  
or have Revealed to us the overall process.**

**We do hypothesize that stars go through cycles.  
From white dwarf to red giant.  
For that matter, for all that we have seen,  
because the cycle would be beyond the duration  
of the human race,  
they might repeat their cycles, repeatedly.**

**The earth is in relationship to the sun,  
in its cycle.  
Were the earth 10% further from the sun,  
it would be so cold  
that all its water would freeze,  
at its poles,  
like Mars.  
And if the earth were 10% closer to the sun,  
it would be so hot  
that all its water would evaporate  
and cover it in thick clouds,  
like Venus.**

**If the sun were to shrivel further  
towards becoming a white dwarf,  
Venus would cool,  
and its clouds would fall to the surface,  
creating seas.  
Earth would then become like Mars.**

**Indeed, this is the destiny of the earth,  
(why I believe these things  
is the subject of another essay).  
But even during the time of its fruition  
there come and go upon the planet  
numerous races of men.  
Much like a tree,  
passing through its seasons,  
blossoming in the spring,  
bearing fruit,  
and becoming dormant in the winter,  
to eventually after many seasons**

**wither and die.**

**There have been past races upon this planet.  
There shall be future races.  
Although it is possible  
for a race to destroy the planet.  
(Observe the missing planet in our solar system,  
in what we call the asteroid belt,  
as possible evidence of this).**

**It is the destiny and purpose of every star,  
to have planets,  
and of every planet,  
to have its races of men.  
Just as it is the destiny (fulfilled or not)  
for every tree to be fruitful.**

**There are multitudes of questions  
that one can ask about the appearance of the race.  
The old arguments  
between the Creationists and the Evolutionists.  
Both error in fundamental premises.  
One as to their materialist  
and mechanistic concepts of cause and effect,  
and the other as to their dogmatic  
literal interpretation  
of the Spiritual Analogy  
related in the Bible plus their misconceptions  
regarding the realities of Time, Space and Matter.**

**It is a curiosity that man has the same saline ratio  
in his blood, sweat and tears,  
as does the sea.  
And one does well to contemplate  
the philosophical concept that  
Ontogeny Recapitulates Phlyogeny.**

**That the individual starts off as a single cell,  
becoming at conception multiple cell in a saline sea, (the womb)  
and proceeds through various stages,  
having a tail and other appendages,  
that atrophy before being born.**



**Nevertheless, this is not a proof of devolution,  
(descent from other creatures),  
because man has always been man,  
whatever his form,  
individually or collectively.**

**But as far as evolution is concerned,  
the evolving of the species,  
as I have stated before,  
there is evidence for any observer to see,  
by simply looking at the armor of the knights of old,  
or the statistics for military induction,  
between WWI and WWII.  
Whatever.**

**If the paradigm presented here,  
is more meaningful to you  
than one of creation a few thousand years ago,  
and you can bear the idea,  
that when you are is -  
within this diminishing cycle  
of the star that we call the Sun,  
in this particular revolution of the galaxy,  
that we call the Milky Way,  
in this particular expansion  
of what we see as our island universe,  
etc.  
then you have a very different idea of when you are  
than someone who feels that all the purpose of ALL life,  
revolves around a SINGULAR event,  
that happened upon this one rock,  
circling this one star,  
approximately 2,000 years ago.**

**Next time -  
as to who you are.**

**Peace and love,  
Bruce  
DawnSayer@webpal.org**

**MENU: [HOME](#) » [Reconstruction](#) » [Recovery](#) » [Renewal](#) » [Most Clear Proof - Dir](#)**

---

---

# POP25 - Manifestation

If you have some suggestions or comments you would like to pass on to me about these pages you may do so at: [DawnSayer@webpal.org](mailto:DawnSayer@webpal.org)

---

**And now  
to my final explanation of the paradigm.  
Next time on to the proofs,  
but remember the only goal now  
is to comprehend -  
not to necessarily believe.**

**I have covered where and when we are,  
and now on to who we are.**

**This is:**

### **3. An analogy of "Manifestation"**

-----  
**This deals in part,  
with who we are,  
as a race.**

**And who we are  
ties into when we are.  
To clarify the Biblical Paradigm.**

**Adam was the first man.  
In actuality, there were a Thousand Adams.  
Simply lost to history.  
In fact, all the Adams,  
were pre-historic.**

**The question is what is an Adam.  
Or for that matter what is a man.  
To be a first man.  
To be distinguished from the animals.**

**Man has certain unique characteristics.**

**Language.**

**Humor.**

**Abstract thought.**

**These are all facets of man's unique intellect,  
that distinguishes him from the animal.**

**No animal could have explained to it,**

**that the sun stands relatively still,**

**and the earth circles about it,**

**nor even that 2+2 equals four.**

**(Yes, I have seen the trick  
of counting horses and dogs.)**

**The GREATEST of all abstract thoughts,**

**is the comprehension of God.**

**This is what truly distinguishes man**

**from the animals.**

**Therefore, the first to Recognize God,**

**is who we call the First Man.**

**Because God is Infinite, and Man finite,**

**it is God that must Reveal Himself to Man.**

**Man is incapable of discovering his Creator on his own.**

**The pot can never comprehend the potter.**

**Thus it is, in the scheme of things,**

**that God chooses One to reveal Himself through.**

**This One we call a Manifestation of God.**

**To give an analogy.**

**Consider Betelgeuse.**

**The largest known star.**

**A red giant.**

**If someone were to point into a telescope mirror,  
and say:**

**"There is Betelgeuse",**

**someone else of a literal mind might reply.**

**"That cannot be,**

**because Betelgeuse is a red giant,  
larger than that glass,  
larger than this whole planet,  
even many times larger than our sun.  
It is NOT possible THAT could be Betelgeuse."**

**And then if the first one were to break the mirror,  
and on a subsequent night  
pick up a different mirror  
and say to the skeptic:**

**"Look again,  
there is Betelgeuse."**

**The skeptic could reply,**

**"Even if I were to concede  
that what you showed me before,  
had been Betelgeuse,  
this could not be it,  
because that glass has now been broken.  
Moreover  
if you are going to give me some abstract argument,  
about it having been the rays of light  
within the glass,  
that too is not possible,  
for those rays are no longer here.  
They have long passed."**

**Many analogies of this type could be given.  
The image that you see on this TV or on another.  
The light that appears in this lamp,  
or another.  
All being the same energy.  
All having come from the same source.**

**To say that is Bob Hope on this TV,  
and Bob Hope on that TV is understandable.  
To say that it is Betelgeuse in this mirror,  
and Betelgeuse in that mirror is understandable.  
To say that the light in this lamp,  
and the light in that lamp,**

**are both from the same source is understandable.**

**And so it is with the Manifestation of God.**

**There is but one God  
(as there is but one Betelgeuse)  
and whether He selects one Mirror,  
or another,  
in which to appear,  
He remains the One God.**

**God is Infinite.  
(There is no comparison between God and Betelgeuse).  
There is no way that Betelgeuse  
could be contained in a mirror,  
and no way that God  
could be contained in a Mirror.**

**Yet, all we know of Betelgeuse or other stars,  
is what we see in the mirror.  
And all that we know of God  
is what we see in the Mirror  
(the Manifestation).**

**To look at the mirror and say,**

**"There is Betelgeuse,  
is not illogical.**

**To look at the Mirror (the Manifestation)  
and say,**

**"There is God",  
is not illogical.**

**But to think that Betelgeuse  
can be "contained" in the mirror,  
is illogical.**

**And to think that God can be "contained"  
in the Mirror (Manifestation)  
is illogical.**

**But, nevertheless,  
this is what those who believe in Incarnation, believe.**

**Those who believe that Jesus, was God incarnate.  
But, what Jesus, was,  
was the MANIFESTATION of God.  
Not God incarnate.  
If the distinction is not important to you  
then not to worry about it.  
None of us comprehend the nature of God  
nor our relationship to Him,  
and certainly not the Manifestation's relationship  
to Him.**

**But any way, according to this paradigm,  
God MANIFESTS Himself,  
(Makes Himself known unto men)  
through some individual that He selects.  
The distinction here,  
between Christian Theology is that God can  
Manifest Himself as often as He likes.**

**The Manifestations have told us that  
God selects only one individual at a time  
(on any given planet)  
and usually about once every thousand years.  
Since God makes Himself known  
to all His Creatures,  
given the billions of planets throughout the Universe,  
it is possible, even probable,  
that many Manifestations,  
must be occurring simultaneously.**

**The key to all this is,  
that the ONLY thing that we can know about God,  
is what He tells us about Himself,  
through His Manifestations.**

**But, the key also is,  
that we must RECOGNIZE the Manifestation.  
Individuals recognize the Manifestation,  
and because of His influence on their lives,  
whole civilizations  
come to pay at least lip service to His Station.**

**Those who do not Truly see the Light,  
confuse the Light with the Lamp.  
They begin to worship the Messenger,  
instead of the Message.**

**If the Light appears in a different Lamp,  
the Blind will not see it,  
but may continue to do obeisance to the Lamp,  
that has now been extinguished.**

**Each of the Manifestations  
have bestowed upon Them Innate knowledge.  
They know ALL the answers.  
But Their hearers are not capable of hearing them.  
The teacher of First Grade students,  
may know just as much  
as the teacher of Sixth Grade students,  
but the students are just not ready to understand.**

**Each of the Manifestations,  
bring two sets of Teachings.**

- **Eternal Spiritual Teachings and**
- **social teachings**

**suitable for the people and the Time.**

**Thus it is that Adam taught that there was a God.**

**The first teaching of the Manifestations.  
Why we call Him the first man.**

**He also gave social teachings regarding**

**the establishment of the family  
(The story of Adam and Eve),  
the command to labor for one's livelihood  
(The story of being cast from the Garden),  
the command against murder  
(The story of Cain and Abel)  
and so forth.**



**Later, there came another Manifestation of God.  
He reinforced and ENLARGED upon  
the Spiritual Teachings of Adam.  
He said, Yes, there is God,  
but God must be worshipped as a Spirit,  
not as the idols that you make with your own hands.**

**There is an interesting story regarding this in the Koran.  
Abraham's father's profession was as an idol maker.  
One day when the father returned he found that Abraham  
had destroyed all the idols, except the largest one.**

**"Abraham! Why did you do this?",  
he said with great anger.**

**"It wasn't I father,  
it was the Big One, ask him".**

**"You know that he can't speak  
and couldn't have done this".**

**"Then, father,  
why do you worship that which is dumb  
and has no power?"**

**We call that form of worship  
practiced by the followers of Abraham - animism.  
Like with the North American Indians,  
the Spirit is in the Trees, the Wind,  
the Water, and so forth.**

**There are many interesting things  
that I could write about Abraham,  
but I suspect my essays are too long already.**

**The Bible tells how he had three wives.  
And each was promised  
to become the mother of nations.  
The Bible tells about  
the descendants of one wife, Sarah.  
But other nations  
track their lineage to the other wives.**

**Abraham established a new social order.  
He sent his brother in one direction  
with His brother's sons and their wives and flocks,  
and He Himself went the other with His.  
This was the beginning of Nomadic Tribes.  
A much advanced social order  
over that of the Adamic period,  
with one male and many wives.  
When an organization of the new social order  
with many males,  
met an organization of the old social order  
with one male.  
it was a wipe out for the old social order.**

**Later came Moses.  
The people had returned to idol worship.  
(The story of the Golden Calf).**

**He taught a new Spiritual Teaching.  
Yes, there is a God, as Adam taught.  
Yes, God is to be worshipped as a Spirit  
as Abraham taught.  
But the Jews were to have Only ONE God.  
(Not that other people didn't worship  
other gods.)  
"The Lord God of Israel is One".**

**Moses also taught a larger social order.  
Rather than just nomadic family tribes,  
the Children of Israel were organized into 12 Tribes.  
There were thousands in each Tribe.  
When an organization of the new social order  
with thousands of males,  
met an organization of the old social order  
with a few males,  
it was a wipe out for the old social order.**

**Moses also gave many other social teachings,  
both in the Ten Commandments,  
and Books of the Law.  
But I will pass over these.**

**In due time,  
there came as promised by Moses,  
the next Manifestation.**

**Jesus.**

**For Who was He,  
if not the one Promised to the Jews?  
And He taught a new Spiritual Teaching,  
that God is a God of Love.  
And he taught a new social teaching,  
upon which there were built city states.  
(Render unto Caesar that which belongs unto Caesar,  
and unto God that which belongs unto God).  
Leading unto a much stronger social order,  
that allowed for the organization of people  
who were not even related to each other,  
as were the 12 Tribes of Israel.  
And He, Jesus, promised unto them another,  
the Paraclete,  
as understood by those who recognized Mohammed.**

**And Mohammed brought a new  
and Higher Spiritual Teaching.**

**That yes, as Adam taught,  
there is God.  
And yes, as Abraham taught,  
He is Spirit.  
And yes, as Moses taught,  
we are to worship One God.  
And yes, as Jesus taught,  
He is a God of Compassion.  
And yes, something new.**

**That there is No God but God  
(Allah - The Only - the meaning of Allah).**

**Monotheism.  
Philosophically comprehended  
by the Christians and Jews of Europe,  
as a result of the Crusades,  
and then spread to Judaism  
and most of Christianity  
(The Mormons are still not monotheistic).**

**Mohammed also brought new social teachings.  
The establishment of Nations.  
Even secular historians recognize Him for this.  
The law that we call Blackstone Law,  
or the Common Law of Europe  
is not to be found in the Bible,  
but rather is in the Koran.**

**When organizations of the new social order,  
met organizations of the old social order,  
it was of course a wipe out  
for the old social orders.**

**I could write volumes  
on all these matters.  
But have probably written too much already.**

- **Each of the Manifestations promises a successor**
- **Each brings new Spiritual Teachings**
- **Each brings new Social Teachings**
- **Each reveals a Book**
- **Each starts a new calendar**
- **Each revitalizes the Religion of God**
- **Each revitalizes Society**

**The latest of the Manifestations to come,  
are the Twin Manifestations  
(One immediately after the Other)  
of the Bab and Baha'u'llah.**

**They have brought a new Spiritual Teaching,**

**that there is but One Religion,  
The Religion of God,  
and that all Religions,  
(that is to say that All the Manifestations)  
have always come to renew THAT religion.**

**They have also brought new social teachings.**

**That there is but One race,**

**the human race.  
That there is but One nation, the World,  
and Mankind is its Citizens.**

**There is so much more that I could write,  
about Other Manifestations.  
Buddha, Krishna, Zoroaster.  
There is so much more that I could write,  
about the New Teachings,  
and the Destiny of the Human Race.**

**But the time has come for  
you to think about this new paradigm.  
About who we are.**

**A race of people,  
receiving Progressive Revelation from God,  
through His Manifestations,  
as we now make the transition  
from Spiritual Childhood,  
through Adolescence,  
into Spiritual Maturity.**

**A view quite different from the Christian view.  
This is a view in which we are at The Beginning,  
rather than at the Ending.**

**A view in which  
we are having our relationship to God,  
being Progressively taught to us  
by the Manifestations of God,  
rather than a view  
in which all truth has already been revealed.  
A view in which we are at the beginning of maturity,  
rather than at the end.**

**A view in which,  
once again the Manifestation of God,  
has come to Mankind,  
and it is the responsibility of every individual  
to recognize Him and serve Him.  
This is the ONLY salvation for us.**

**Individually or collectively.  
Because, whether we desire it or not,  
who we ALL are is  
the servants of God.  
(Obedient or disobedient, and that is who we are).**

**This is the paradigm  
that I have asked you to comprehend.  
The matter of acceptance and belief  
comes next.  
For that there needs to be proof.  
And for that I shall continue next -  
with the Most Clear Proof.**

**Peace and Love,  
Bruce  
DawnSayer@webpal.org**

**MENU: [HOME](#) » [Reconstruction](#) » [Recovery](#) » [Renewal](#) » [Most Clear Proof - Dir](#)**

---

---

# POP26 - Revelation

If you have some suggestions or comments you would like to pass on to me about these pages you may do so at: [DawnSayer@webpal.org](mailto:DawnSayer@webpal.org)

---

**There are as many paradigms  
as there are people.  
We all view the world differently.**

**Some people view the world  
as having been created a few thousand years ago -  
others think that it may have been  
millions or billions of years ago.**

**Whatever one imagines  
it is too little  
because we are dealing with  
the Infinite and Eternal  
and that is a different concept.  
A different paradigm.  
A different way of looking  
at the world and Reality.**

**Some people see Creation in a "magical" way.  
Others feel that they have a "scientific" appreciation of Creation.  
But no matter what our concepts  
the best that we can know today is that  
they are limited and relative to the Absolute Reality.**

**There are many speculations held by people  
about the nature of reality,  
the nature of creation,  
the source and purpose of our being.**

**I hear a great variety,  
about reptilian evolution,**

**seeding from the stars,  
special creation from the dust,  
and many others that I won't delve into.**

**The two extremes which I challenge are  
scientific materialism  
that says man has all the answers in his intellect  
with no need for revealed religion  
and its opposite pole  
dogmatic orthodoxy  
which says all Truth has been already revealed  
and no further Truth can be revealed.**

**It has been to the followers of scientific materialism  
that I have made the attempt  
to prove mathematically  
that Jesus was the Christ  
and that the Bible was a reliable source of prophecy.**

**While the mathematical proof that Jesus was the Christ  
was a difficult emotional challenge to the atheist and agnostic  
the next mathematical proofs from the Bible  
will be an equally difficult emotional challenge  
to any of a dogmatic orthodox religious inclination  
who have managed to hold on to this point.**

**Because whereas before  
we used mathematical proofs  
to show from the Jewish Old Testament Scriptures  
that those Scriptures contained prophecies about the Christian Religion  
we are now going to use the Christian Gospel  
to show with **EVEN GREATER MATHEMATICAL SURETY**  
that the New Testament contains prophecies about other religions  
such as the Moslem and the Baha'i.**

**There are many marvelous prophecies in the Book of Revelation,  
but they are mostly concealed from Christians  
who give fantastic superstitious interpretations about them.  
The Book of Revelation contains prophecies  
about things both past and future.  
It is through understanding its prophecies about things past  
that we can have confidence about its prophecies of things future.**



### **In my next email**

**I shall get into the mathematical proofs  
and while I shall not spend a lot of time  
dealing with the prophecies themselves  
other than showing the mathematical key to them  
my dear saintly wife has asked that I at least share with you  
a typical interpretation of one of those Scriptures.**

**Many a Christian has opened the Book of Revelation  
to find Marvelous Prophecies and Exhortations  
directed to several small and insignificant congregations  
in the vicinity of Israel.**

### **The Churches Addressed**

**were not those actual specific congregations,  
but the church names were used in the Prophecies  
as type designators or markers  
for whom to the Messages were actually addressed.  
Each of these tiny little congregations were but symbols  
for the Religions of the World.  
Each one being used as a Symbol for one of the  
World's Major Religions.**

**This is why they were so Important as to be addressed  
in this Summary Book of Christian Revelation.  
What was actually being addressed was  
each of the World's Major Religions.**

### **The Seven Religions were:**

- 1. Sabaenism:**  
**Southwest Arabia and later Ethiopia-**  
**Revelator unknown. 4000 - 5000 B.C.**
- 2. Hinduism:**  
**India -**  
**Krishna. 2000 - 3000 B.C.**
- 3. Judaism:**  
**Egypt -**  
**Moses. 1250 B.C.**
- 4. Zoroastrianism:**  
**Persia -**  
**Zoroaster. 900 - 1000 B.C.**

**5. Buddhism:**

**India -**

**Buddha - 500 - 530 B.C.**

**6. Christianity:**

**Palestine -**

**Christ. 26 A.D.**

**7. Moslem:**

**Arabia -**

**Mohammed. 622 A.D.**

**While a study of each of the ancient religions would be interesting and I might be able to make it interesting to some of you since I have a degree in Comparative Religions it is far beyond the limits of this presentation.**

**Nevertheless, it was not beyond the view of the Bible. And it was to each of these Religions that the Book of Revelation was addressed.**

**Rev: 1:4**

**" John to the seven churches which are in Asia ----"**

**The messages are not addressed to the Churches (Religions) in the order (above) of their appearance, but one who has studied the religions can determine which Church is which by the nature of the Message delivered unto it.**

**The references to things like Seven Stars being in the Hand (or Crown) of the Messenger or the Seven Golden Candle Sticks are symbolic and again refer to the Seven Religions being in the Hand and Kingdom of the Lord, and that He walks among them. One might note also that it is the Angel of Each Church that is addressed.**

**Rev. 2:1 Ephesus**

**Rev. 2:8 Smyrna**

**Rev. 2:12 Pergamos**

**Rev. 2:18 Thyatira**  
**Rev. 3:1 Sardis**  
**Rev. 3:7 Philadelphia**  
**Rev. 3:8 Laodiceans**

**Each Church (Religion) is generally praised for some aspect of its behavior and chastised for some other aspect. And thus it is with any open minded student of comparative religion that usually we can find some strong beneficial point in each religion along with some characteristic weakness in its followers.**

**I am not as much a student of the Book of Revelation as my dear wife.**

**(She does not like for me to refer to her as saintly, but I tell her that since everyone else does also, how can I deny it. But let me tell you also, it is not always easy living with a saint.)**

**My wife has deeply studied the book, has taken courses with numbers of churches, maintains 3 ring binders on the subject, and a library of reference books.**

**She would have me tell you much more, than this little bit, but that is not my intention here, and it is only in deference to her that I have told you so much as I have.**

**Next time, now, I can return to the mathematical proofs.**

**Peace and love,  
Bruce Beach  
DawnSayer@webpal.org**

**MENU: [HOME](#) » [Reconstruction](#) » [Recovery](#) » [Renewal](#) » [Most Clear Proof - Dir](#)**

# POP27 - First Step

If you have some suggestions or comments you would like to pass on to me about these pages you may do so at: [DawnSayer@webpal.org](mailto:DawnSayer@webpal.org)

In the previous emails  
I have presented a paradigm  
that states that ALL the Revealed Religions  
(Major Religions with a culture, etc.)  
have come from God.

We now turn to mathematical proof  
in the Bible  
regarding one of them.  
Specifically the Moslem Faith.

First we need to gather the numbers.  
So far as I am aware  
after many years of study on the subject -  
the following are the only locations in the Bible  
that have the following numbers.

## "Scriptures"

DAN	8:14	1844 A.D. from our previous proof regarding Christ)
	7:25	time, times, and div. of time
	9:27	midst of week
	12:7	time, times, & half
Luke	4:25	three years and six months
REV	11:2	42 months
	:3	1260 days
	:9	3 1/2 days

:11	3 1/2 days
12:6	1260 days
:14	time, times, & half
13:5	42 months

**The First Step is to  
bring the numbers  
to a common denominator**

- **time, times, & div. of time and**
- **time, times, and a half, and**
- **the midst of the week (one half of seven days)**

**are all equal to**

**3 and 1/2**

**Let us consider the first of these :**

**time is**

**1**

**times is plural and therefore in this case**

**2**

**dividing of time, or dividing of one is**

**1/2**

**therefore -----**

**3 and 1/2 total**

**likewise:**

**time = 1**

**times = 2**

**a half= 1/2**

-----

**3 and 1/2 total**

**"Scriptures"**

DAN      8:14      1844 A.D. from our previous proof regarding Christ)

7:25 3 1/2

9:27 3 1/2

12:7 3 1/2

Luke 4:25 three years and six months

REV 11:2 42 months

:3 1260 days

:9 3 1/2 days

:11 3 1/2 days

12:6 1260 days

:14 3 1/2

13:5 42 months

**I will pause here so that you can look at this  
and see if you see how the rest come to the  
common denominator.**

**The answer -  
next email.**

**Peace and love,  
Bruce  
DawnSayer@webpal.org**

**MENU: [HOME](#) » [Reconstruction](#) » [Recovery](#) » [Renewal](#) » [Most Clear Proof - Dir](#)**

---

---

# POP28 - Next Steps

If you have some suggestions or comments you would like to pass on to me about these pages you may do so at: [DawnSayer@webpal.org](mailto:DawnSayer@webpal.org)

---

**Continuing with our mathematical proof from the Bible that the Book of Revelation talks about religions other than the Christian.**

**We had thus far brought the following scriptures to this much of a common denominator.**

## "Scriptures"

DAN	8:14	1844 A.D. from our previous proof regarding Christ)
	7:25	3 1/2
	9:27	3 1/2
	12:7	3 1/2
Luke	4:25	three years and six months
REV	11:2	42 months
	:3	1260 days
	:9	3 1/2 days
	:11	3 1/2 days
	12:6	1260 days
	:14	3 1/2
	13:5	42 months

**Second Step**  
**bringing the numbers**  
**to a common denominator**

**( 3 1/2) prophetic times or years**  
**are equal to 42 months**  
**that is to say:**

**3 years of 12 months = 36 months**  
**plus a half year of 6 months**  
**brings the total to ----->42 months**

**Making the substitution in our above table**  
**we get the following:**

**"Scriptures"**

DAN	8:14	1844 A.D. from our previous proof regarding Christ)
	7:25	42 months
	9:27	42 months
	12:7	42 months
Luke	4:25	42 months
REV	11:2	42 months
	:3	1260 days
	:9	42 months
	:11	42 months
	12:6	1260 days
	:14	42 months
	13:5	42 months

**Third Step**  
**bringing the numbers**  
**to a common denominator**



**42 months is equal to 1260 days (years)  
because a biblical month  
(as per an earlier proof)  
contains 30 days and**

**42 months multiplied by  
30 times**

**----  
1260 days (years).**

**Now making the substitutions  
we arrive at:**

**"Scriptures"**

DAN	8:14	1844 A.D. from our previous proof regarding Christ)
	7:25	1260 days (years)
	9:27	1260 days (years)
	12:7	1260 days (years)
Luke	4:25	1260 days (years)
REV	11:2	1260 days (years)
	:3	1260 days (years)
	:9	1260 days (years)
	:11	1260 days (years)
	12:6	1260 days (years)
	:14	1260 days (years)
	13:5	1260 days (years)

**This in itself, was pretty astounding to me  
when I first saw it.**

**To think that all these scriptures  
were saying the same thing!**

**That all these reduce to 1844  
will be the subject of the next email.**

Peace and love,  
Bruce  
DawnSayer@webpal.org

**MENU: [HOME](#) » [Reconstruction](#) » [Recovery](#) » [Renewal](#) » [Most Clear Proof - Dir](#)**

---

---

# POP29 - Final Step

If you have some suggestions or comments you would like to pass on to me about these pages you may do so at: [DawnSayer@webpal.org](mailto:DawnSayer@webpal.org)

In the previous email e  
we arrived at:

## "Scriptures"

DAN	8:14	1844 A.D. from our previous proof regarding Christ)
	7:25	1260 days (years)
	9:27	1260 days (years)
	12:7	1260 days (years)
Luke	4:25	1260 days (years)
REV	11:2	1260 days (years)
	:3	1260 days (years)
	:9	1260 days (years)
	:11	1260 days (years)
	12:6	1260 days (years)
	:14	1260 days (years)
	13:5	1260 days (years)

**The explanation of how to convert these all to 1844 is found at the start of Revelation Chapter Eleven which is the start of most of the series.**

**Rev. 11:1-2**

*"And there was given me a reed like unto a rod:  
and the angel stood, saying,  
Rise and measure the temple of God,  
and the altar,  
and them that worship therein.*

*But the court which is without the temple  
leave out,  
and measure it not;  
for it is given unto the Gentiles:  
and the holy city shall they tread under foot  
forty and two months.*

-----  
**Now the question is  
who were the Gentiles that occupied  
the area outside the Temple.**

**Answer:  
They were the Moslems.**

**So we are not to use the Christian measure  
in measuring this forty and two months  
but rather the Moslem measure.**

**We have seen how 42 months  
(and ALL the other scriptures)  
reduce to 1260.**

**Previously, I have given you the following general rule  
for finding a date of commencement any Mohammedan year.  
This has a maximum error of a day;**

**multiply 970,224 by the Mohammedan year,  
point off six decimal places  
and add 621.5774.**

**The whole number will be the year A.D.,  
and the decimal multiplied by 365  
will give the day of the year.**

**Here is the math.  
Be SURE to check it through for yourself.**

**It will then be meaningful to you.  
If you are not sufficiently interested  
to check the math  
then you are not sufficiently interested  
in the answer for it to make any difference.**

**970224**

**1260**

-----

**58213440**

**1940448**

**970224**

-----

**1222.482240**

**621.5774**

-----

**1844.059640**

**!!! 1844 !!!**

**And what happened in 1844?**

**Two things of significance.**

**1. There was the Edict of Toleration.**

**The above Scripture pointed out -  
the holy city shall they tread under foot  
forty and two months.**

**After Jesus came as the Messiah of the Jews,  
the Jews were scattered and  
not permitted to enter the Holy Land.**

**This bothered the Jews greatly  
because their scripture in Isaiah had said  
that He would gather them  
"as a mother hen gathers her chicks".**

**But He said,  
"I would have gathered -  
but ye would not gather".**

**So they were dispersed,  
and not allowed to return,**

**but now in 1844 there was given the Edict of Toleration.**

**Here is some historical evidence  
that came to me just this week,  
from another researcher.**

*"During the 1970's I was researching parts of the Baha'i Faith and, out of curiosity, wrote about the Edict of Toleration to the PUBLIC RECORD OFFICE in London. The following is the reply I received.*

*"A translation of the edict, an acknowledgement from Stratford Canning to the Sublime Porte, and an accompanying letter from Canning, dated 23 March 1844, is in Foreign Office, Turkey, FO78/555/No.49. there are several other letters from Canning in the same volume on the question of the religious intolerance of the Turks. The draft of a letter from the Foreign Office, dated 16 January 1844, which made plain the attitude of the British Government and which provided the direct impetus for the negotiations leading eventually to the issue of the edict, is in FO78/552/No.4."*

**-you can obtain copies of the English language  
documents that refer to it from the Public Record Office in London.**

**-----**  
**H.G.Guinness, in his book, "Light for the Last Days" (probably published around the turn of the century) wrote "the decree [Edict of Toleration] was published in the 1260th year of the [Muslim] calendar. It is dated March 21st 1844. This date is the first of Nisan in the Jewish year, and is exactly 23 centuries [2300 years] from the 1st Nisan, BC457, the day on which Ezra states that he left Babylon in compliance with the decree given in the seventh year of the reign of Artaxerxes."**

**-----**  
**So there we have it ----->**

### **"Scriptures"**

DAN	8:14	1844 A.D. from our previous proof regarding Christ
	7:25	1844 A.D.
	9:27	1844 A.D.

12:7 1844 A.D.

Luke 4:25 1844 A.D.

REV 11:2 1844 A.D.

:3 1844 A.D.

:9 1844 A.D.

:11 1844 A.D.

12:6 1844 A.D.

:14 1844 A.D.

13:5 1844 A.D.

**I shall discuss the significance of all this  
in my next email  
which will be my final email in the POP series.**

**Peace and love,  
Bruce  
DawnSayer@webpal.org**

**MENU: [HOME](#) » [Reconstruction](#) » [Recovery](#) » [Renewal](#) » [Most Clear Proof - Dir](#)**

---

---

# POP30 - The Final Analysis

If you have some suggestions or comments you would like to pass on to me about these pages you may do so at: [DawnSayer@webpal.org](mailto:DawnSayer@webpal.org)

---

**This is a summary discussion of the POP Series.**

**We set off with the idea to discover whether or not prophecy was truly possible, and we examined a number of prophetic claims.**

**Next we investigated the nature of proof, saying that there are ONLY Four Paths to Truth, and that each is fallible.**

**We then applied the Four Paths in a Mathematical Proof of Bible Prophecy showing that Jesus was the Christ.**

**On the same basis we then began to examine the following 12 Scriptures**

## "Scriptures"

DAN	8:14	1844 A.D. from our previous proof regarding Christ)
	7:25	time, times, and div. of time
	9:27	midst of week
	12:7	time, times, & half
Luke	4:25	three years and six months
REV	11:2	42 months
	:3	1260 days



:9	3 1/2 days
:11	3 1/2 days
12:6	1260 days
:14	time, times, & half
13:5	42 months

**And reduced them all down to the following:**

### **"Scriptures"**

DAN	8:14	1844 A.D. from our previous proof regarding Christ
	7:25	1844 A.D.
	9:27	1844 A.D.
	12:7	1844 A.D.
Luke	4:25	1844 A.D.
REV	11:2	1844 A.D.
	:3	1844 A.D.
	:9	1844 A.D.
	:11	1844 A.D.
	12:6	1844 A.D.
	:14	1844 A.D.
	13:5	1844 A.D.

**The calendar that we used to make this reduction was the Moslem Calendar and was a part of the evidence for our hypothesis that the Bible contains prophecies about other religions.**

**We then asked what significant thing happened in 1844**

**and our answer was - two things:**

- 1. The edict of toleration  
that in fulfillment of Jewish Prophecy  
permitted the return of the Jews to Israel.  
and**
- 2. The Return of Christ  
as prophesized and expected  
in the Great Expectation of 1844.**

**(Others, such as the Mormons, would add to this list  
things like the martyrdom of Joseph Smith.)**

**In regard to the return of Christ I explained that  
over 10 million people world-wide  
(mostly from their Scriptures - other than Christian)  
now recognize Baha'u'llah as the Return of Christ,  
and have accepted a new paradigm about  
themselves and this planet in relationship  
to the Universe, Space, Time, and to what is called  
a Manifestation of God.**

**The following is a chart that I have made  
of Prophecies and dates  
from the Bible.**

### **Chart of Prophetic Dates and Sources**

#### **Bible Moslem**

**1844 1260  
(Quran 40:7)  
(Quran 32:4)**

- (1) Dan 8:14**
- (2) 7:25**
- (3) 9:27**
- (4) 12:7**
- (5) Rev 11:2**
- (6) :3**
- (7) :9**
- (8) :11**

**(9) 12:6**

**(10) :14**

**(11) 13:5**

**(2) (12) 1863 1290 Dan 12:11**

**(3) (13) 1963 1335 Dan 12:12**

**(4) (14) 2063 2520 Dan 4:16 360**

**-457 B.C. :23 x7**

**-----**

**2063 2520**

**(5) (15) 1914 1844**

**+70 Dan 9:2**

**----- Jer 25:11**

**1914 :12**

**29:10**

**Isa 23:15**

**:17**

**While I have listed the key  
Scriptures, prophecies and dates  
I will not be going on to discuss them.**

**To actually understand the references  
(in the Book of Revelation)  
to the Moslem dates  
one has to be acquainted with the Moslem Religion  
and Moslem history.**

**Suffice to say,  
the references both  
in the Book of Revelation  
and SURPRISINGLY found with the SAME DATE  
in the Koran  
both refer to the Return of Christ.  
(It surprises many Christians to learn  
that the Moslems are looking for  
and expecting the Return of Christ.)  
However, just as the Jews failed to recognize Jesus,  
and the Christians failed to recognize Mohammed,  
so have the Moslems failed to recognize**

**the Bab and Baha'u'llah.**

**If you had been a Jew 2,000 years ago  
and had been shown then  
(which the Christians were NOT able to do -  
but which can be shown now -  
because the Books have been opened)  
the mathematical proofs from the Old Testament  
about Jesus  
then you should have been willing to examine  
the Gospel of Jesus  
and to find out what Jesus had said.**

**Today, you have been shown from the Bible  
the mathematical proofs about Baha'u'llah  
and you should now be willing to seek out and study  
the Teachings of Baha'u'llah.**

**The claim is that  
He is the Manifestation to this Day and Age.  
That He has brought the solution  
to mankind's problems  
and has told us in prophecy the nature of our destiny.**

**But all this  
you will only discover by studying His own Writings.  
To try to dispute about Him  
based upon one's present understanding about the Bible,  
would be the same as a Jew  
refusing to read the Gospel of Christ  
and continuing to dispute about Him  
on the basis of the Old Testament.**

**To accept all this  
(even to the point of being willing to examine His Writings)  
of course requires a MAJOR, MAJOR paradigm shift  
on the part of a Fundamentalist Christian.**

**I know that it is hard.  
Here is just a partial list of the ideas  
that a Fundamentalist will think are FANTASTIC  
and completely UNBELIEVABLE.**

**1. That the world -  
contrary to the Creationist point of view  
wasn't created just a few thousand years ago.**

**I realize that the evidence wasn't there  
for almost 1500 years - three quarters of the duration  
of the development of Christian Theology.**

**Even as recently as when Columbus discovered America,  
the sailors that were with him were concerned  
that the world was flat  
and believed that the sun went around the earth.  
It has only been in the last couple of centuries  
(a mere ten percent of the time of Christian Theology)  
that we have had telescopes to show us  
anything approaching the concepts of galaxies  
such as we have formed using telescopes  
like those on Palomar and Hubble.**

**Archaeology and the study of paleontology  
along with discovery and acceptance  
by most people of the existence of dinosaurs  
just had not occurred.  
That the Universe is NOT  
SPACE CENTERED  
or TIME CENTERED  
about the earth and man  
was just totally inconceivable  
to a Bible Believing Christian on the Street  
during most of the time of Christianity.**

**HOWEVER, THE POINT HAS BEEN  
THAT THE BIBLE WAS NOT WRONG  
about Creation  
but simply that it must be understood  
in a GREATER MORE INCLUSIVE SPIRITUAL SENSE  
and that the explanations given in it  
were those suitable for the people  
to whom it was revealed -  
at their level of understanding at that time.**

**2. As shocking a paradigm shift**

**as I have asked the Fundamentalist Christian  
to make about the non-centeredness of his world  
in Space and Time**

**I have asked him to make a MUCH MORE DIFFICULT  
paradigm shift about the non-centeredness  
of HIS RELIGION  
in relationship to the CREATOR  
of this IMMENSE Universe we have described.**

**In regards to just this one planet -  
we have examined that there have been  
GREAT Numbers of People  
and cultures on this one little planet that have had  
religious guidance other than the Christian one.  
Moreover, we have looked at evidence,  
that just as the Bible when not taken Literally  
but when taken in a Spiritual Sense  
is correct in its Creation Accounts  
so also does it contain evidence about OTHER Religions.  
That the Old Testament had promised  
that ALL the nations of the earth  
would be blessed by the seed of Abraham's THREE wives  
but the Old Testament only tells  
the history of the descendant's of one (Sarah).**

**We saw that the Old Testament  
gives with MATHEMATICAL ACCURACY  
prophecy of the both the first coming of Jesus  
and of His Return in 1844.**

**The Jews of course did not accept Jesus,  
although His followers, the Christians,  
accepted all the Prophets of the Old Testament  
(but not the laws of religious practice -  
sacrifice, circumcision, Sabbath day, kosher foods, etc.)  
of the Jews.**

**However, neither did the Christians accept Mohammed  
although there are in the Bible  
TEN TIMES  
the number of MATHEMATICAL PROOFS (the 1260 dates)  
about HIM  
and the return of Christ in 1844**

**based on the Moslem Calendar.  
Even though the Moslems accepted all the Old Testament,  
and the New Testament  
(although again not the religious laws  
such as baptism and others such as we mentioned above)  
and all the Prophets AND Jesus  
as explained in the Koran.**

**And once again, the Moslems had the 1844 prophecies,  
(in their dates on their calendar)  
in the Koran  
and were well expecting the Return of Christ  
but they also failed to accept Him  
at His Return in 1844,  
and they persecuted the Bab and Baha'u'llah.**

**3. As difficult as are the first two paradigm shifts  
for a Fundamentalist Christian  
the THIRD about the NATURE of the MANIFESTATION -  
about the VERY CONCEPT of what is meant by a  
MANIFESTATION of God  
is often just totally incomprehensible to them.  
In their eyes it destroys Jesus.  
For them He was the Center of Creation -  
a one time event  
on this one planet  
2,000 years ago  
around which the whole Universe revolves.**

**That this could be TRUE,  
not in the small literal sense that they say,  
but in a MUCH GREATER SPIRITUAL SENSE  
is to them - just non-meaningful.  
But just as Jesus did not come to destroy the Law,  
but to fulfill it,  
neither did Baha'u'llah come to destroy Jesus,  
but rather to fulfill His prophecies.  
To unite the world and the religions.  
To bring Peace and the Kingdom of Heaven on Earth.**

**4. A FOURTH paradigm shift  
is necessary for the Fundamentalist.  
It is central to being able to understand those above.**

**This regards the very nature of Truth itself.  
This regards about how to understand the Bible -  
not in an absolute literal sense -  
but in a higher spiritual sense.**

**I have suggested that the CREATOR has to be  
so much more EVEN MORE IMMENSE  
(I am avoiding the word Infinite  
which is more completely incomprehensible)  
and to have existed so much LONGER than this earth  
(again I am avoiding the term ETERNAL  
for the same reasons)  
that He is simply unknowable to us  
in an ABSOLUTE sense.  
For this reason, as Scientists today understand,  
our knowledge of just the Creation  
leave alone the Creator  
is RELATIVE and limited to us  
by what I have described as the  
Fallible Four Paths to Truth.**

**It is in this sense -  
that as we come to know more about  
the Creator's Creation  
that we gain an EVER EXPANDING sense  
of how IMMENSE it is  
(billions of galaxies  
in the visible universe of the astronomer  
and beyond that through the black holes  
to we don't know where and on from that  
to Infinity  
of which we have no concept of the meaning  
and the Spiritual World which is the basis of it all.)**

**It is in this sense -  
that as we come to know more about  
the Creator's Creation  
that we gain an EVER EXPANDING sense  
of how old it is  
(billions of years long -  
again into the black holes  
where light, and space and time cease to exist,  
and the concepts become unmeaningful**



**as we gaze at the thought of Eternity  
about which we can have no concept).**

**It is in this sense -  
that as we come to know more about  
the Creator's Creation  
that we gain an EVER EXPANDING sense  
of the purpose of it all  
that has been increasingly explained to us  
in OUR SHORT HISTORY OF TIME  
by the Manifestations of God  
as they have raised us to increasing social consciousness  
and social organizations of  
the family, the extended family, the tribe,  
the city state, the nation  
and now on towards one unified world  
with a world government,  
so that there can be an ever progressing  
peaceful and advancing civilization  
to support individuals in their journey  
towards spiritual enlightenment.**

-----  
**There is so much more that I long to share -  
about the nature of the soul,  
the nature of life after death,  
the purpose of life on this planet,  
the future of mankind on this planet,  
and many many other issues  
but all those things are to be found  
in the Writings by the Prophet to this Day and Age -  
Baha'u'llah.**

**My poor and inadequate words  
do not have the power  
to reach and penetrate the soul  
with the Spirit of Truth  
as does His.**

**My purpose has simply been to point  
towards that source  
so that you can discover the Truth  
from the Source of Truth  
for yourself.**

**Those who cannot make the 4 paradigm shifts  
will continue to say  
that they believe in**

**Rapture**

**(their ascending up into the clouds)**

**Resurrection**

**(the graves opening and the dead coming forth)**

**Return of Christ**

**(from the clouds above  
with nail prints in his hands)**

**Creation**

**in the last few thousand years.**

**Centeredness**

**of this planet in the Universe.**

**Vicarious redemption of sins**

**by the suffering of another**

**and dozens of other things  
because they have FAITH,  
and that since I don't believe what they believe  
(in the way they believe it -  
because I do believe in the accuracy of the Scriptures)  
that I have been deceived by a false prophet  
and that I am doomed.**

**The fundamentalist ideas have been around for centuries.  
They are deeply ingrained in the culture  
and are passed on from generation.**

**One has almost gotten them  
along with the air that they breath.  
But paradigm shifts do occur,  
and the ones that I am describing  
are occurring.  
How long it will take,  
decades or centuries, I don't know,  
for them to become universal.  
But because they are NEARER the Absolute Truth,  
these paradigms, and others more advanced,  
will eventually replace the present ones  
in the collective consciousness of mankind.**

**If you are willing to examine them  
with an open heart  
and can look at their Source  
and the Spiritual Source of Truth  
for this Day and Age -  
the Writings of Baha'u'llah -  
you will be one of the lights of the age,  
helping to lead mankind out of the present  
relative morass of vain imaginations and superstition  
towards greater enlightenment.**

**I hope that you will be a contributor  
to the effort.**

**Peace and love,  
Bruce  
DawnSayer@webpal.org**

**MENU: [HOME](#) » [Reconstruction](#) » [Recovery](#) » [Renewal](#) » [Most Clear Proof - Dir](#)**

---

---

# The Seven Churches

If you have some suggestions or comments you would like to pass on to me about these pages you may do so at: [DawnSayer@webpal.org](mailto:DawnSayer@webpal.org)

---

## **Prolog:**

**For most readers -  
this will be a very, very strange explanation -  
about some verses from the beginning of the  
The Book of Revelation.**

**The idea that Book of Revelation is about  
Religions other than Christianity-  
will just not be acceptable to many Christians.  
Yet - that is the explanation presented here.**

**The Book of Revelation  
is addressed to Seven Churches.  
The churches named are what we call archtypes.  
That is to say -  
it is not really to the seven  
historically insignificant locations named  
but rather those names are stand-ins for the real subjects.**

**Oftentimes, the true significance of Scripture  
is far beyond the expectations  
of the members of the religion who claim ownership  
of that Scripture.**

**Thus it is -  
that the Messiah expected and promised  
in the Jewish Scripture  
was the Messiah and Lord  
for what was far beyond  
what was then probably less than 2 million persons**

who considered themselves "The Chosen People".

Likewise, the Message and Meaning behind the Book of Revelation is much greater than that attributed to it by Christians in general.

This is an introduction to that expanded concept.

## Introduction

The Book of Revelation, in the Bible, was a spiritual message revealed by Jesus Christ through St. John the Divine in about 96 AD, sixty three years after Jesus' ascension. John was on the island of Patmos and is believed to have been nearly 90 years old at the time.

The Book of Revelation is a deeply mystical writing and in order to comprehend the dramatic concepts within it, one must be willing to examine it with spiritual eyes and an openness to inquire if there is a deeper meaning than the literal meaning of the words that one sees on the surface.

The prophetic message in the Book of Revelation is about the destiny of seven churches. These are referred to as seven candlesticks and each one has the name of a town that was in John's teaching circuit and which still exists in what is now west Turkey and is somewhat north of what we now call Palestine and Israel.

## Revelation -verses 1:10-17 (Introductory Verses)

*1:10 I was in the Spirit on the Lord's day, and heard behind me a great voice, as of a trumpet,*

*1:11 Saying, I am Alpha and Omega, the first and the last: and, What thou seest, write in a book, and send it unto the seven churches which are in Asia; unto Ephesus, and unto Smyrna, and unto Pergamos, and unto Thyatira, and unto Sardis, and unto Philadelphia, and unto Laodicea.*

*1:12 And I turned to see the voice that spake with me. And being turned, I saw seven golden candlesticks;*

*1:13 And in the midst of the seven candlesticks one like unto the Son of man, clothed with a garment down to the foot, and girt about the paps with a golden girdle.*

*1:14 His head and his hairs were white like wool, as white as snow; and his eyes were as a flame of fire;*

*1:15 And his feet like unto fine brass, as if they burned in a furnace; and his voice as the sound of many waters.*

*1:16 And he had in his right hand seven stars: and out of his mouth went a sharp twoedged sword: and his countenance was as the sun shineth in his strength.*

*1:17 And when I saw him, I fell at his feet as dead. And he laid his right hand upon me, saying unto me, Fear not; I am the first and the last:*

**The central concept being presented here is that the towns and their names represented spiritual "archetypes" of what the prophecy was really about - which is the churches, or rather, major religions of the world.**

**The little towns themselves, while historical and geographic realities, have fallen into obscurity, but the Prophetic Message about the state of the Seven Churches, The Seven Golden Candlesticks, that is to say the Seven World Religions, in the "Last Days" has come to have GREAT significance.**

-----  
**The first of the seven churches was the Sabean - here called the Church of Ephesus.**

*2:1 Unto the angel of the church of Ephesus write; These things saith he that holdeth the seven stars in his right hand, who walketh in the midst of the seven golden candlesticks;*

*2:2 I know thy works, and thy labour, and thy patience, and how thou canst not bear them which are evil: and thou hast tried them which say they are apostles, and are not, and hast found them liars:*

**This is the most ancient of the churches. It is religion as found in the remmanents of Ancient Tribes of the Earth. Hence the commendation of its Patience.**

**This church is so ancient (4000-5000 BC) that we don't really know the name of its Revelator, but symbolicaly we contribute it to Adam. Baha'u'llah says there were a "thousand Adams", but much of what is written here is symbolism and we won't dwell upon it.**

*2:3 And hast borne, and hast patience, and for my name's sake hast laboured, and hast not fainted.*

**Each of the Churches receives a COMMENDATION  
and a CONDEMNATION.**

**This was the commendation of this church.**

*2:4 Nevertheless I have somewhat against thee, because thou hast left thy first love.*

**And here is the condemnation.**

*2:5 Remember therefore from whence thou art fallen, and repent, and do the first works; or else I will come unto thee quickly, and will remove thy candlestick out of his place, except thou repent.*

**Which may be why  
we really know so little  
about this church.**

*2:6 But this thou hast, that thou hatest the deeds of the Nicolaitanes, which I also hate.*

**The Nicolaitanes were a group  
that had risen against religion.  
It is to be noted that God hates the deeds  
of the Nicolaitanes -  
and NOT the people.**

*2:7 He that hath an ear, let him hear what the Spirit saith unto the churches; To him that overcometh will I give to eat of the tree of life, which is in the midst of the paradise of God.*

**Each of the churches  
will receive such a call to enlightenment.**

**The Tree of Life  
in the midst of the Paradise of God -  
is called the Divine Lote Tree.**

**It is said to be the point beyond which there is no passing.**

**Symbolically it is the Manifestation of God.**

**Meaning that one can go no further in Paradise  
or know more of God -**

**than what is revealed by the Manifestation.**

**The blessing here**

**is that those who are open and receptive -  
to what the Holy Spirit says to ALL the churches  
will recognize the next Manifestation of God.**

**I realize that I am going a bit far**

**in delving into such mystical meanings -  
so I will restrain myself on such points from here out.**

-----

**The second of the seven churches  
was the Hindu -  
here called the Church in Ephesus.  
The Revelator of this church was Krishna (2000-3000 B.C.)**

*2:8 And unto the angel of the church in Smyrna write; These things saith the first and the last, which was dead, and is alive;*

**The First and the Last.  
The Alpha and Omega.  
He which was and ever shall be.**

**In the concept of Progressive Revelation -  
all the Revelators are the one and the same.  
Jesus said -  
"Before Abraham - I am."  
The Jews of course disputed with Him about that.**

**Here is a similar quote from Baha'u'llah.**

*XLVII. O Jews! If ye be intent on crucifying once again Jesus, the Spirit of God, put Me to death, for He hath once more, in My person, been made manifest unto you. Deal with Me as ye wish, for I have vowed to lay down My life in the path of God. I will fear no one, though the powers of earth and heaven be leagued against Me. Followers of the Gospel! If ye cherish the desire to slay Muhammad, the Apostle of God, seize Me and put an end to My life, for I am He, and My Self is His Self. Do unto Me as ye like, for the deepest longing of Mine heart is to attain the presence of My Best-Beloved in His Kingdom of Glory. Such is the Divine decree, if ye know it. Followers of Muhammad! If it be your wish to riddle with your shafts the breast of Him Who hath caused His Book the Bayan to be sent down unto you, lay hands on Me and persecute Me, for I am His Well-Beloved, the revelation of His own Self, though My name be not His name. I have come in the shadows of the clouds of glory, and am invested by God with invincible sovereignty. He, verily, is the Truth, the Knower of things unseen. I, verily, anticipate from you the treatment ye have accorded unto Him that came before Me. To this all things, verily, witness, if ye be of those who hearken. O people of the Bayan! If ye have resolved to shed the blood of Him Whose coming the Bab hath proclaimed, Whose advent Muhammad hath prophesied, and Whose Revelation Jesus Christ Himself hath announced, behold Me standing, ready and defenseless, before you. Deal with Me after your own desires.*

**(Baha'u'llah, Gleanings from the Writings of Baha'u'llah, p. 101)**



**This one quote from the Baha'i Writings  
pretty much sums up what this is all about -  
that each of the Revelators of the Seven Churches  
are all the One and the Same.**

**In reality not only they -  
but the Manifestations  
wherever they appear  
throughout the Universe and All time.  
That is the reason that there is none other Name (identity - not vocal sound)  
under heaven by which men are saved.  
It is by the Manifestation - God made Manifest -  
who appears through all eternity and all infinity.  
Again - I may almost be going too far.**

*2:9 I know thy works, and tribulation, and poverty, (but thou art rich) and I know the blasphemy of them which say they are Jews, and are not, but are the synagogue of Satan.*

**One must remember that while this is about the Hindus,  
at the time it was written  
it was to the Christians  
and thus recognizes their dealing with the Jews at the time.**

*2:10 Fear none of those things which thou shalt suffer: behold, the devil shall cast some of you into prison, that ye may be tried; and ye shall have tribulation ten days: be thou faithful unto death, and I will give thee a crown of life.*

**I could make commentary on each verse -  
but you will probably think already  
what I will be writing to be overly long -  
so I will restrain myself.**

*2:11 He that hath an ear, let him hear what the Spirit saith unto the churches; He that overcometh shall not be hurt of the second death.*

**The message to each of the Churches ends with a similar promise. I will not mention this again.**

-----  
**The third of the seven churches  
was the Jewish -**

here called the Church in Pergamos.  
Coincidentally, each of these Greek names  
has a spiritually significant meaning -  
but I will not go into such detail.  
The Revelator of this church was Moses (1250 B.C.)

*2:12 And to the angel of the church in Pergamos write; These things saith he which hath the sharp sword with two edges;*

*2:13 I know thy works, and where thou dwellest, even where Satan's seat is: and thou holdest fast my name, and hast not denied my faith, even in those days wherein Antipas was my faithful martyr, who was slain among you, where Satan dwelleth.*

*2:14 But I have a few things against thee, because thou hast there them that hold the doctrine of Balaam, who taught Balac to cast a stumblingblock before the children of Israel, to eat things sacrificed unto idols, and to commit fornication.*

You can see here  
that this is addressed  
directly to the Jews -  
"the children of Israel".

*2:15 So hast thou also them that hold the doctrine of the Nicolaitanes, which thing I hate.*

Amazingly, today even in Israel -  
the far larger majority of the Jews  
say in public opinion polls -  
that they are "not religious".

*2:16 Repent; or else I will come unto thee quickly, and will fight against them with the sword of my mouth.*

*2:17 He that hath an ear, let him hear what the Spirit saith unto the churches; To him that overcometh will I give to eat of the hidden manna, and will give him a white stone, and in the stone a new name written, which no man knoweth saving he that receiveth it.*

The "new name" is of course the name of the New Manifestation -  
which of course no one recognizeth  
except those who do "receive it".  
All these things have spiritual significance -  
such as the "hidden manna".  
Just too much to go into.

-----  
**The fourth of the seven churches  
was the Parsee/Zoroastrian -  
here called the Church in Thyatira.**

**The Revelator of this church was Zoroaster (900-1000 B.C.)**

**This church is not very well known about  
among most Christians**

**(who in fact know very little about any of the others  
except to usually express their prejudices about them.)**

**This religion does appear in the Bible -  
when the Magji came following the star  
and looking for the Christ child.**

**Those wise men from the East were Zoroastrians  
who as told in the Bible had in their religion the prophecies  
about the coming Manifestation (Jesus).**

*2:18 And unto the angel of the church in Thyatira write; These things saith the Son of God, who hath his eyes like unto a flame of fire, and his feet are like fine brass;*

**The emphasis is on fire here  
because they are sometimes considered to be  
"fire worshippers".**

*2:19 I know thy works, and charity, and service, and faith, and thy patience, and thy works; and the last to be more than the first.*

**The commendation.**

*2:20 Notwithstanding I have a few things against thee, because thou sufferest that woman Jezebel, which calleth herself a prophetess, to teach and to seduce my servants to commit fornication, and to eat things sacrificed unto idols.*

**The condemnation.**

*2:21 And I gave her space to repent of her fornication; and she repented not.*

*2:22 Behold, I will cast her into a bed, and them that commit adultery with her into great tribulation, except they repent of their deeds.*

*2:23 And I will kill her children with death; and all the churches shall know that I am he which*

*searcheth the reins and hearts: and I will give unto every one of you according to your works.*

**One has to get into historical matters  
to explain many of the verses.**

*2:24 But unto you I say, and unto the rest in Thyatira, as many as have not this doctrine, and which have not known the depths of Satan, as they speak; I will put upon you none other burden.*

*2:25 But that which ye have already hold fast till I come.*

*2:26 And he that overcometh, and keepeth my works unto the end, to him will I give power over the nations:*

*2:27 And he shall rule them with a rod of iron; as the vessels of a potter shall they be broken to shivers: even as I received of my Father.*

*2:28 And I will give him the morning star.*

**The study of stars,  
and astrology  
had great significance  
among the Zoroastrians.**

**The allusion to the Morning Star -  
and the reference to the search of the Wise Men in the Gospel -  
has a connection.**

*2:29 He that hath an ear, let him hear what the Spirit saith unto the churches.*

-----

**The fifth of the seven churches  
was/is the Buddhist -  
here called the Church in Sardis.  
The Revelator of this church was Gotama Buddha (500 B.C.)**

*3:1 And unto the angel of the church in Sardis write; These things saith he that hath the seven Spirits of God, and the seven stars; I know thy works, that thou hast a name that thou livest, and art dead.*

**Saying again -  
that He has ALL the Seven Spirits of God -  
or all the Seven Churches.  
The verses altogether**

**are a theme about Progressive Revelation.**

**One of the amazing things about these Scriptures is that they describe the order in which these religions appeared on the earth - as well as the nature of each one of them.**

**This is of course astounding to those who have an inclination to see - but to those who are fixed in their dogmas they will simply close their eyes and ears and see nothing of this in it.**

*3:2 Be watchful, and strengthen the things which remain, that are ready to die: for I have not found thy works perfect before God.*

*3:3 Remember therefore how thou hast received and heard, and hold fast, and repent. If therefore thou shalt not watch, I will come on thee as a thief, and thou shalt not know what hour I will come upon thee.*

*3:4 Thou hast a few names even in Sardis which have not defiled their garments; and they shall walk with me in white: for they are worthy.*

*3:5 He that overcometh, the same shall be clothed in white raiment; and I will not blot out his name out of the book of life, but I will confess his name before my Father, and before his angels.*

*3:6 He that hath an ear, let him hear what the Spirit saith unto the churches.*

-----  
**The sixth of the seven churches was/is the Christian - here called the Church in Philadelphia.**

**The Revelator of this church was of course Jesus Christ (26 A.D.) I will make mention of the significance of the Greek name for this one name since it is known to Christians.**

**It means brotherly - and it is common for Christian to refer to their Christian brothers and sisters. Also the city of Philadelphia in the US has the title the City of Brotherly Love.**

*3:7 And to the angel of the church in Philadelphia write; These things saith he that is holy, he that is true, he that hath the key of David, he that openeth, and no man shutteth; and shutteth, and no man openeth;*

**Christians will of course see many references to Christ in this verse.**

*3:8 I know thy works: behold, I have set before thee an open door, and no man can shut it: for thou hast a little strength, and hast kept my word, and hast not denied my name.*

*3:9 Behold, I will make them of the synagogue of Satan, which say they are Jews, and are not, but do lie; behold, I will make them to come and worship before thy feet, and to know that I have loved thee.*

*3:10 Because thou hast kept the word of my patience, I also will keep thee from the hour of temptation, which shall come upon all the world, to try them that dwell upon the earth.*

*3:11 Behold, I come quickly: hold that fast which thou hast, that no man take thy crown.*

*3:12 Him that overcometh will I make a pillar in the temple of my God, and he shall go no more out: and I will write upon him the name of my God, and the name of the city of my God, which is new Jerusalem, which cometh down out of heaven from my God: and I will write upon him my new name.*

**The new name, as before,  
is of course the name of the new religion.**

**There are many promises and symbolisms here -  
but our purpose has been only to show the general theme -  
that these Scriptures are about Seven Major Religions of the World -  
which have all come from God.**

*3:13 He that hath an ear, let him hear what the Spirit saith unto the churches.*

**To say more -  
would be to start preaching. :)**

-----

**The seventh of the seven churches  
was/is the Moslem/Islam -  
here called the Church of the Ladicieans.  
The Revelator of this church was Muhammad (622 A.D.)**

**It is amazing to the Christians**

**(and of course rejected by them)  
that the Bible holds prophecies about Muhammad.  
The Moslems see MANY, MANY prophecies in the Bible  
about Muhammad.  
But this is nothing new.  
The Christians see many, many prophecies  
in the Old Testament -  
about Jesus -  
which the Jews of course do not see.**

**And of course -  
there are many prophecies  
in ALL the Religions and Books of God -  
including the Koran -  
about the End Times  
(The Beginning of the Age of Fulfillment)  
and the coming of the Messiah to the whole of the world  
which the followers of those religions do not see  
except as the Return of their own Prophet.**

*3:14 And unto the angel of the church of the Laodiceans write; These things saith the Amen, the faithful and true witness, the beginning of the creation of God;*

*3:15 I know thy works, that thou art neither cold nor hot: I would thou wert cold or hot.*

*3:16 So then because thou art lukewarm, and neither cold nor hot, I will spue thee out of my mouth.*

*3:17 Because thou sayest, I am rich, and increased with goods, and have need of nothing; and knowest not that thou art wretched, and miserable, and poor, and blind, and naked:*

*3:18 I counsel thee to buy of me gold tried in the fire, that thou mayest be rich; and white raiment, that thou mayest be clothed, and that the shame of thy nakedness do not appear; and anoint thine eyes with eyesalve, that thou mayest see.*

*3:19 As many as I love, I rebuke and chasten: be zealous therefore, and repent.*

*3:20 Behold, I stand at the door, and knock: if any man hear my voice, and open the door, I will come in to him, and will sup with him, and he with me.*

*3:21 To him that overcometh will I grant to sit with me in my throne, even as I also overcame, and am set down with my Father in his throne.*

*3:22 He that hath an ear, let him hear what the Spirit saith unto the churches.*

-----

**I have not gone into the meaning  
of many of the verses.  
But enough -  
indeed probably too much.**

**The theme is the Progressive Revelation of God  
and it all points towards  
the Manifestation of this Day and Age.**

**They that have eye to see  
and an ear to hear -  
will be joyed to see the bounty  
that God has revealed in the Books of Old -  
and will be eager to receive  
the Message unto the New Age.**

**But many will not see or hear the Message.  
Indeed many people look at the Bible  
and see only the carbon black of ink  
pressed upon the celulose of paper -  
and say that they see NOTHING of the Spirit  
in it.**

**How joyful to write to those  
who are attuned to the Spirit,  
and I delight in their writing to me at:**

**Bruce  
DawnSayer@webpal.org**

**Progressive Revelation - Nine Divinely Revealed Religions**

<b>Number</b>	<b>Date</b>	<b>Religion</b>	<b>Prophet</b>	<b>Book</b>	<b>Rev. Verses Church Name</b>



1	5000 B.C.	Sabean	"Adams"	Oral	Rev. 2:1-7 Sabean
2	3000 B.C.	Hindu	Krishna	Vedas	Rev. 2:8-11 Ephesus
3	1250 B.C.	Jewish	Moses	Torah	Rev. 2:12-17 Pergamos
4	1000 B.C.	Parsee/Zoroastrian	Zoroaster	Ivesta	Rev. 2:18-29 Thyatira
5	500 B.C.	Buddhist	Gotama	Tripitaka	Rev. 3:1-6 Sardis
6	26 A.D.	Christian	Jesus	Gospel	Rev. 3:7-13 Philadelphia
7	622 A.D.	Islam/Moslem	Muhammad	Koran	Rev. 3:14-22 Ladicieans
8	1844 A.D.	Babi	Bab	Bayan	Other Chapters
9	1863 A.D.	Baha'i	Baha'u'llah	Aqdas	Other Chapters

Each Prophet/Manifestation/Revelator

Starts a new Calendar

Brings a new Book

Teaches His followers to love God

Teaches His followers to love his fellow man

Reinforces the former spiritual teachings

Brings new spiritual teachings

Brings social teachings suitable for that Day and Age

Tells His followers to watch for the NEXT Prophet - that is - His Return

**MENU:** [HOME](#) » [Reconstruction](#) » [Recovery](#) » [Renewal](#)

**MENU:** [HOME](#) » [Reconstruction](#) » [Recovery](#) » [Renewal](#) » [Survival](#)

# The Ocean of Scriptures

If you have some suggestions or comments you would like to pass on to me about these pages you may do so at: [DawnSayer@webpal.org](mailto:DawnSayer@webpal.org)

---

## *Prolog:*

**This essay assumes  
that you have downloaded -**

**[Ocean.](#)**

**If not -  
then you need to pause here and do so -  
because that is what this essay discusses.**

**Ocean is an electronic library  
that is completely FREE  
and while over the last 15 years  
I have used over a half dozen electronic libraries  
costing many hundreds of dollars  
this one GREATLY surpasses all the others in performance.**

**Every few weeks or every couple of months -  
WHILE ON LINE  
you want to go to the "Resources" pull down window  
on the bar on the top of your Ocean screen  
and make sure that you have  
(1) the latest program version  
and  
(2) the updates to the bookshelf.**

**I just (May 2002) did this -  
and note that I now have 963 books on the bookshelf.  
It is always growing,  
but it takes up surprisingly little space**

**on your hard disk  
for something so Momentous and POWERFUL.**

**You will undoubtedly have much fun with Ocean in  
searching the Bible and other Christian books  
as well as the Islam works.  
However, I have written this essay  
for the purpose  
of introducing one to The Baha'i Writings.**

### ***Using the System:***

**While one may search the entire library  
for a reference  
it takes a bit longer  
and often gives one way too much to look through.**

**As you start using the system  
as you may well already have -  
it gives you a tutorial on how to use it.  
VERY simple.  
Just put search words in - in any order  
or put in quotes  
exact combinations and phrases that you want.**

**Usually it takes very few words to find what you want -  
but sometimes you need to add additional words  
to reduce the quantity of quotes it brings up.  
This is particularly true as one becomes familiar  
with Baha'i quotes -  
and wishes to locate the source of a particular quote.**

### ***Authoritative versus Commentary:***

**Note particularly -  
that the Baha'i Library  
is divided into TWO categories -  
*AUTHORITATIVE* Baha'i and  
Baha'i Studies (or what I have called "*commentary*").**

**You may find it interesting to delve right into  
the *AUTHORITATIVE* Baha'i**

**and I will try to explain what is there -  
but, if you are new to Baha'i,  
I am going to recommend that you first  
gain some information from some sources  
located in the Baha'i Studies section of the library.**

**Let me, however, tell you -  
as marvelous as all this is,  
it is by no means the only source on Baha'i  
and in due time I hope you will find other sources -  
some of which you may find equally astonishing.**

**There are published almost daily  
from a variety of Baha'i National Publishing Trusts  
and numerous independent Baha'i Publishers  
new books about Baha'i.  
Years ago - I used to read every new book that came out -  
but now I can't even keep up with the titles.**

**There are also many web pages -  
web discussion groups,  
sites by various Baha'i Communities  
and the Official momentous Baha'i sites.  
But, not to worry about any of that for the moment.**

### ***The Authoritative Works:***

**First, you need to get a structure  
to comprehend what it is that you have downloaded.  
To do that we need to briefly outline  
the history of the Baha'i Faith.  
In doing this you will see that the Books  
under AUTHORITATIVE Baha'i  
follow that outline.**

**You will quickly become acquainted -  
with just who the AUTHORITATIVE Sources are -  
but at the moment we will more or less just list them,  
and hopefully later you will on your own  
fill in the details.**

### ***The Authoritative CENTRAL FIGURES:***

**The Baha'i Faith began in 1844  
with the Declaration of**

## **The Bab**

**the First Central Figure of the Baha'i Faith.**

**The most authentic and extensive source for that history  
is in "The Dawn Breakers"  
a massive tome  
which I do not recommend that you start with.**

**(A much simplified "readers digest version"  
is in Baha'i Studies under the title -  
"Release the Sun".**

**Perhaps an early book - but not necessarily  
the first book to read.**

**After the martyrdom of the Bab  
the second CENTRAL Figure of the Baha'i Faith was**

## **Baha'u'llah.**

**Baha'u'llah is said to have written over 100 Books.  
The Persian word for book is "Kitabi" so we get books like  
Kitabi-Aqdas (His "Book of Laws") -  
Kitabi-Igan (The "Book of Certitude") -  
etc.**

**Many of His Writings are also called "Tablets" -  
for example -**

**"The Tablet of Ahmad" (actually a prayer in this case).**

**His last and summary work is called -**

**"The Epistle to the Son of the Wolf",**

**and His most mystical Writing**

**is the "Seven Valleys"**

**and**

**"The Four Valleys".**

**I had been a Baha'i about seven years before I read these latter -  
and at that time I said -**

**"I have understood/liked/appreciated everything that I have read  
until now -**

**but I get absolutely nothing out of these."**

**Years later I would come to say -**

**"If there was nothing else but these in the Baha'i Faith - it would be enough." :)**

**You might enjoy reading the first and second of the Seven Valleys - which are the Valley of Search and the Valley of Love. But not necessarily the first thing that you do.**

**There are a number of compendiums of Baha'i Writings such as the book called - "Gleanings" - and Baha'u'llah often quotes from Himself - and all the subsequent writers quote from Him - so you will often find the same quote in many, many places.**

**The Third (and last) Central Figure of the Baha'i Faith is**

## **Abdu'l-baha**

**the son of Baha'u'llah who was called by Baha'u'llah "The Mystery of God" and named by Baha'u'llah as the Center of His Covenant - The Perfect Exemplar of His Faith, the ONLY Interpreter of His Word. Abdul means "servant" - so Abdu'l-baha means the Servant of Baha'u'llah.**

**Abdu'l-baha, like the Bab and Baha'u'llah, wrote many Tablets. Early on - one of the most interesting things to do - is to read down through the Table of Contents of "Some Answered Questions" where He deals with many, many different issues.**

**Abdu'l-baha appointed His grandson-**

## **Shoggi Effendi**

**to succeed Him - with the title of Guardian of the Faith. Effendi means "sir" - so in effect his title is "Sir Shoggi".**

**Shoggi Effendi was educated at Oxford -  
and writes, in a very scholarly Oxfordian style,  
momentous works explaining about the future of the Faith.**

### ***Additonal AUTHORITATIVE Sources:***

**After Shoggi Effendi (an AUTHORATIVE source although not a Central Figure)  
there was the Trusteeship of the Custodians -  
until the**

#### **Universal House of Justice**

**(also Authoritative sources)  
was established in 1963.  
Writings of some of the Hands  
will be found in Baha'i Studies  
but these, while highly respected,  
are not AUTHORITATIVE Sources.**

**The UHJ (Universal House of Justice), however,  
as just stated, is an authoritative source -  
and so its publications are under that category of search.  
For example - they write an annual "**Ridvan Message**".  
Ridvan is a particular time on the Baha'i Calendar -  
but not to worry about such details for the moment.**

**I will mention one particular book  
under AUTHORITATIVE compilations  
(there are many) -  
but if you go to the Authoritative list -  
look under compilations -  
and then look under "**Lights of Guidance**"  
and then read the Table of Contents of that Book  
you will again find a long list of Information  
on many Baha'i subjects.  
This is just a note for the future -  
because of course -  
you cannot do everything at once.**

### ***The Commentary Works:***

**Now turning to the Baha'i Studies -  
Numbers of the Hands are listed there**

(along with other names)  
- some of whom write VERY scholarly works -  
but there are three Hands -  
whose attention that I will direct you to first.

First there is Ruhiyyih Khanum -  
or known as Amatu'l-baha  
who was the wife of Shoggi Effendi.  
She wrote a wonderful book  
about the Guardian called  
**"The Priceless Pearl"** -  
and later re-wrote it  
and called it **"The Guardian"**.  
But this book would be a ways down your reading list.

Hand of the Cause William (Bill) Sears -  
was a great favorite among Baha'i's  
for his humour and writing style.  
His **"Thief in the Night"** -  
is an entertaining explanation  
of what Abdu'l-baha called **"The Most Clear Proof"** -  
but there are many much more scholarly works  
on this subject  
that are not on the electronic bookshelf.  
Bill Sears also wrote **"Release the Sun"** -  
the history of the Babi era that I mentioned before.

And finally -  
there is J.E. Esslemont -  
who wrote  
**"The New Era"**  
and while this is an "old" book about the Faith  
it is where I would suggest that you begin -  
because it gives such a COMPLETE overview.  
It is almost like a college text book  
(and indeed has been used as such)  
but it is not difficult to read.

Of course, you may just wish to search out  
answers to questions  
using Ocean.



**If you wish to query me about what you are reading -  
all you have to do is give me the search words  
that you used -  
and I can duplicate here  
what it is that you are looking at.**

**It is very easy with Ocean  
to mail a quote.  
All you have to do  
is highlight the text  
copy it -  
and paste it into your email.**

**So, now you should have a source  
for any question that you may ask.  
Please ask for any clarification,  
or help that I can give you -  
and let me know what you are finding in the Ocean.**

**It is a joy to me  
to respond to you on anything you ask.**

**Bruce  
DawnSayer@webpal.org**

## **The Writings Currently in Ocean**

<b>Authoritative Baha'i</b>			
<b>Date</b>	<b>Writer</b>	<b>Station</b>	<b>Sample Books</b>
<b>1844-1850 A.D.</b>	<b>The Bab</b>	<b>Prophet/Manifestation Central Figure</b>	<b>(The Bayan) in Selections from Writings of the Bab</b>
<b>1852-1892 A.D.</b>	<b>Baha'u'llah</b>	<b>Prophet/Manifestation Central Figure</b>	<b>Aqdas Gleanings Igan Epistle to to the Son of the Wolf</b>

1892-1921	Abdu'l-baha	Centre of Covenant Central Figure	<b>Some Answered Questions</b>
1921-1957	Shoggi Effendi	Guardian	<b>God Passes By</b>
1957-1963		Custodians	
1963-forward	Universal House of Justice	UHJ	<b>Messages</b>

## Baha'i Studies (Commentary)

Writer	Sample Title	About this work
William Sears	Thief in the Night	An entertaining story that covers "The Most Great Proof" of why Baha'u'llah is the Return of Christ
Dr. J.E. Esslemont	Baha'u'llah and the New Era	A thorough explanation about the Baha'i Faith, historically, it beliefs and customs and so forth.
William Sears	Release the Sun	An entertaining presentation of the early beginnings of the Baha'i Faith
Ruhiyyih Khanum	The Priceless Pearl	The story of her life with the Guardian by the wife of the Guardian.
George Townsend	The Heart of the Gospel	A book about the Baha'i Faith by a Christian Minister
George Townsend	Christ and Baha'u'llah	A book about Baha'u'llah by a Christian Minister
Howard Colby Ives	Portals to Freedom	A book about his Baha'i experience
Lady Blomfield	The Chosen Highway	The experience of an early believer.

The above are just some of the books in the Ocean bookshelf that I would recommend to read first. Some of the other books in the bookshelf are perhaps more scholarly, if not more inspirational. There are also many, many other books that one might find to their particular interest through a Baha'i Publishing House, or at a Baha'i bookstore. For example, I have on my bookshelf a half dozen books dealing with Baha'i economics because that is a particular subject that interests me. Someone else may have many books dealing with a subject like life after death or explanations of scripture.

**MENU: [HOME](#) » [Reconstruction](#) » [Recovery](#) » [Renewal](#) » [Survival](#)**



# Prayer

---

## Table of Contents:

### [Prolog: Some Thoughts on Prayer and Meditation](#)

The author's personal experience about prayer.

### [Ahmad: A Special Tablet.](#)

Shoggi Effendi said: "...the Tablet of Ahmad, have been invested by Baha'u'llah with a special potency and significance, and should therefore be accepted as such and be recited by the believers with unquestioning faith and confidence, that through them they may enter into a much closer communion with God, and identify themselves more fully with His laws and precepts." (Compilations, Baha'i Prayers, p. 208)

### [Perspicuous Verses: of Baha'u'llah](#)

Baha'u'llah says in the verses:

"Blessed art thou,  
who hast fixed thy gaze upon Me,  
for this Tablet which hath been sent down for thee -  
a Tablet which causeth the souls of men to soar.

Commit it to memory,  
and recite it.  
By My Life!  
It is a door to the mercy of thy Lord.  
Well is it with him that reciteth it  
at even tide and at dawn.

### [Chant: of Abdu'l-baha](#)

*I had heard the recording a number of decades ago-  
and then again at the Baha'i World Congress in New York City in 1992  
where I became acquainted with Harjot Sidu and Vido Ighani*

*who provided me with the translation that I first published here,  
my not being aware of any other.*

*I have now received from Bob Haugen a translation that appeared in The Baha'i World, 1936-1938,  
Volume 7, page 421. The above now largely follows that translation.*

Click here to return to the  
top of this  
[Table of Contents](#)

---

## Some Thoughts on Prayer and Meditation

These are simply some random thoughts on the subject of prayer and meditation. There are numbers of Baha'i books on the subject and it is not my intention to recap anything printed there.

There are few Baha'i books on the "method" of meditation and although I have taught the subject for several decades I am not prepared to formally make a presentation at this time. There are numerous methods, and Baha'is are free to choose such as is suitable to them, but they are REQUIRED by Baha'u'llah to meditate.

For many years I have had in abeyance a project to correlate the ancient Aphorisms of Pantanjali (one of the best known guides in Hindu literature on the subject of meditation) to statements on the subject in the Baha'i Teachings. In this regards there is a surprising wealth of material, in the Baha'i Writings, as how to sit, focus one's mind, and other such disciplines. To this end, I have made notes of comparison with several versions of Pantanjali translations, including a literal one, (since I do not read Sanskrit) but with Shoghi Effendi's proscription of teaching meditation in Summer Schools, I have not given a high priority to the project.

There is considerable confusion in the minds of many people about the distinctions between prayer and meditation. Recitation, Intonation and Chanting are important and will undoubtedly play a much more prominent role in Baha'i culture in the future. All of us pray, or should pray, but in the Western world - few of us chant. Chanting is to prayer like singing is to talking. Even someone, such as myself, whom everyone announces to be tone (or at least tune) deaf, can but wonder at the capacity of a trained opera singer to overwhelm the combined efforts of an entire church congregation. I have heard beautiful chanting of Baha'i prayers in English, but it is a rarity. A mere cultural quirk because there is nothing specific about the Persian or Arabic languages that makes chanting only possible in those languages.

Also in the Western world, few people meditate. It is more difficult to describe the relationship of meditation to prayer. It is a capability of the human spirit on up the ladder from concentration and contemplation. It passes beyond the murmuring of sound and symbol although we can be led into the ecstasy of it by revealed meditations. As an analogy, let me say that while we all use math and numbers to some extent we can but vaguely guess at the capacities of theoretical mathematicians. There are many other examples of the distinctions between the accomplishments of the trained versus the untrained in areas such as acrobatics, ice skating, dance, sports and other fields of endeavor. What then would lead one to think that all people can pray or meditate equally well without training when few have even stopped to ponder the distinctions between concentration, contemplation and meditation.

Undeniably, quality of prayer is affected by, among other things, purity of heart. But this is a chicken and egg matter. One leads to the other. No matter how inadequate one feels - they must begin to pray. Indeed, prayer may well (and most surely will) reveal to them even much greater inadequacies than they ever imagined. Still it remains the only path to salvation, no matter the type of one's soul, and whatever paths of Truth they trod (matters which I deal with in the POP series).

Many in the Western World are in non-praying societies and the practice and habit of prayer will be very strange to them. Some new Baha'i's find the requirement of even a daily obligatory prayer requiring a discipline that they are not used to. The further discovery that Baha'i's are supposed to also pray both in the morning and evening and to repeat 95 times the Greatest Name (a step towards meditation) is best left to their progressive spiritual development.

Some like myself, (and I share this with you, only so that you may know the variety of Baha'i life) after decades fall into a pattern of almost perpetual prayer. Indeed, I would say that the goal is to have one's every thought focused on Baha'u'llah. To have one's every motivation to be the motivation of Baha'u'llah. Prayer is the path.

Oftentimes in life, tests and difficulties are the motivation to pray. A prayer often learned early on by new Baha'i's and Baha'i children is the Bab's Remover of Difficulties. That too, some come to a convention or practice of repeating nine, nineteen or ninety-five times, in times of exceptional challenge. A personal choice of mine was to repeat the Tablet of Ahmad nineteen times daily. Indeed, for many years, in addition to the Fast prayers, I would say it nineteen times each day for the nineteen days of the Fast. Each one must find their own discipline and it is well to remember that Baha'u'llah CAUTIONS about being given to long prayers.

It is amazing, in a lifetime, how the prayers will add up. How easy and joyful it becomes. That indeed, the most joyful hours of the day become those spent in prayer and meditation. As one progresses along the path of prayer they come to learn that Baha'u'llah has recommended a number for special situations and occasions. I won't go into those now, but one will eventually come to the Perspicuous Verses, which Baha'u'llah recommends (does not require) that one say every "eventide" and "morn". Add to these Abdu'l-baha's Daily Regional Prayers for teaching, and suggested daily prayers for one's loved ones, and one can have a very full prayer schedule. However, to say daily the short noonday prayer sometime

between noon and sunset, along with the 95 repetitions of The Greatest Name (for this some use a rosary) and to say with absolute sincerity The Greatest Name in the morn and evening, fulfills the requirement of God. God does not need our prayers. We pray to benefit ourselves, not God.

A simple repetition of the Greatest Name ninety-five times a day, will add up in a half century of devotion to the Faith, of one having said it over fifteen million times. In actuality, one who is that devoted will find themselves saying it many more times a day than that, and the lifetime multiple will be much greater. A simple saying of the Tablet of Ahmad, *at least* once a day for the last 30 years of their life will result in their having said it over ten thousand times. Those who recite it that regularly ("withhold not thyself therefrom") will again find that they have actually recited it much more often, and consequently many more times than that.

Yes, over the years, the prayers add up, and as Baha'u'llah says - think not that they do not have effect. We are more blessed by our own, and other's prayers, than we can imagine. Today, we live in a non-praying world, and this presentation will seem very strange to many people, but in the future when Baha'i's gather daily in their communities for prayers and the meaning of meditation becomes better understood, then it will become more meaningful and, indeed, commonplace.

Click here to return to the  
top of this  
[Table of Contents](#)

**MENU: [HOME](#) » [Reconstruction](#) » [Recovery](#) » [Renewal](#) » [Survival](#)**

---

---

## TABLET OF AHMAD

**He is the King, the All-Knowing, the Wise!**

**Lo, the Nightingale of Paradise singeth upon the twigs of the Tree of Eternity, with holy and sweet melodies, proclaiming to the sincere ones the glad tidings of the nearness of God, calling the believers in the Divine Unity to the court of the Presence of the Generous One, informing the severed ones of the message which hath been revealed by God, the King, the Glorious, the Peerless, guiding the lovers to the seat of sanctity and to this resplendent Beauty.**

**Verily this is that Most Great Beauty, foretold in the Books of the Messengers, through Whom truth shall be distinguished from error and the wisdom of every command shall be tested. Verily He is the Tree of Life that bringeth forth the fruits of God, the Exalted, the Powerful, the Great.**

**O Ahmad! Bear thou witness that verily He is God and there is no God but Him, the King, the Protector, the Incomparable, the Omnipotent. And that the One Whom He hath sent forth by the name of Ali was the true One from God, to Whose commands we are all conforming.**

**Say: O people be obedient to the ordinances of God, which have been enjoined in the Bayan by the Glorious, the Wise One. Verily He is the King of the Messengers and His Book is the Mother Book did ye but know.**

**Thus doth the Nightingale utter His call unto you from this prison. He hath but to deliver this clear message. Whosoever desireth, let him turn aside from this counsel and whosoever desireth let him choose the path to his Lord.**

**O people, if ye deny these verses, by what proof have ye believed in God? Produce it, O assemblage of false ones.**

**Nay, by the One in Whose hand is my soul, they are not, and never shall be able to do this, even should they combine to assist one another.**

**O Ahmad! Forget not My bounties while I am absent. Remember My days during thy days, and My distress and banishment in this remote prison. And be thou so steadfast in My love that thy heart shall not waver, even if the swords of the enemies rain blows upon thee and all the heavens and the earth arise against thee.**



**Be thou as a flame of fire to My enemies and a river of life eternal to My loved ones, and be not of those who doubt.**

**And if thou art overtaken by affliction in My path, or degradation for My sake, be not thou troubled thereby.**

**Rely upon God, thy God and the Lord of thy fathers. For the people are wandering in the paths of delusion, bereft of discernment to see God with their own eyes, or hear His Melody with their own ears. Thus have We found them, as thou also dost witness.**

**Thus have their superstitions become veils between them and their own hearts and kept them from the path of God, the Exalted, the Great.**

**Be thou assured in thyself that verily, he who turns away from this Beauty hath also turned away from the Messengers of the past and showeth pride towards God from all eternity to all eternity.**

**Learn well this Tablet, O Ahmad. Chant it during thy days and withhold not thyself therefrom. For verily, God hath ordained for the one who chants it, the reward of a hundred martyrs and a service in both worlds. These favors have We bestowed upon thee as a bounty on Our part and a mercy from Our presence, that thou mayest be of those who are grateful.**

**By God! Should one who is in affliction or grief read this Tablet with absolute sincerity, God will dispel his sadness, solve his difficulties and remove his afflictions. Verily, He is the Merciful, the Compassionate.**

**Praise be to God, the Lord of all the worlds.**

**- Baha'u'llah**

**MENU: [HOME](#) » [Reconstruction](#) » [Recovery](#) » [Renewal](#) » [Prayers Directory](#)**

## The Perspicuous Verses

Among others, these perspicuous verses have,  
in answer to certain individuals,  
been sent down from the Kingdom of Divine knowledge:

'O thou who hast set thy face towards the splendors of My Countenance!

Vague fancies have encompassed the dwellers of the earth  
and debarred them from turning towards the Horizon of Certitude,  
and its brightness, and its manifestations, and its lights.

Vain imaginings have withheld them from Him Who is the Self-Subsisting.  
They speak as prompted by their own caprices, and understand not.

Among them are those who have said:

*"Have the verses been sent down?"*

**Say:**

**"Yea, by Him Who is the Lord of the heavens!"**

*"Hath the Hour come?"*

**"Nay, more;**

**it hath passed,**

**by Him Who is the Revealer of clear tokens!**

**Verily, the Inevitable is come,  
and He the True One,  
hath appeared with proof and testimony.**

**The Plain is disclosed,  
and mankind is sore vexed and fearful.**

**Earthquakes have broken loose,  
and the tribes have lamented, for fear of God,**

**the Lord of Strength, the All-Compelling."**

**Say:**

**"The stunning trumpet-blast hath been loudly raised,  
and the Day is God's, the One, the Unconstrained."**

*"Hath the Catastrophe come to pass?"*

**Say:**

**"Yea by the Lord of Lords!"**

*"Is the Resurrection come?"*

**"Nay, more;**

**He Who is the Self-Subsisting hath appeared  
with the Kingdom of His signs."**

*"Seest thou men laid low?"*

**"Yea by my Lord, the Exalted the Most High!"**

*"Have the tree stumps been uprooted?"*

**"Yea, more;**

**the mountains have been scattered in dust;  
by Him the Lord of attributes!**

**They say:**

*"Where is Paradise, and where is Hell?"*

**Say:**

**"The one is reunion with Me;  
the other thine own self,  
O thou who dost associate a partner with God and doubttest."**

**They say:**

*"We see not the Balance."*

**Say:**

**"Surely, by my Lord, the God of Mercy!  
None can see it except such as are endued with insight."**

*"Have the stars fallen?"*

**Say:**

**"Yea, when He Who is the Self-Subsisting  
dwelt in the Land of Mystery.  
Take heed, ye who are endued with discernment!"**

**All the signs appeared when We drew forth the Hand of Power  
from the bosom of majesty and might.  
Verily, the Crier hath cried out,  
when the promised time came,  
and they that have recognized the splendors of Sinai  
have swooned away in the wilderness of hesitation,  
before the awful majesty of the Lord,  
the Lord of creation.**

**The trumpet asketh:**

*"Hath the Bugle been sounded?"*

**Say:**

**"Yea, by the King of Revelation!  
when He mounted the throne of His Name,  
the All-Merciful."**

**Darkness hath been chased away  
by the dawning-light of the mercy of thy Lord,  
the Source of all light.**

**The breeze of the All-Merciful hath wafted,  
and the souls have been quickened  
in the tombs of their bodies.**

**Thus hath the decree been fulfilled by God,  
the Mighty, the Beneficent.**

**They that have gone astray have said:**

*"When were the heavens cleft asunder?"*

**Say:**

**"While ye lay in the graves of waywardness and error."**

**Among the heedless is he who rubbeth his eyes,  
and looketh to right and to the left.**

**Say:**

**"Blinded art thou.  
No refuge hast thou to flee to."**

**And among them is he who saith:**

*"Have men been gathered together?"*

**Say:**

**"Yea, by My Lord!  
whilst thou didst lie in the cradle of idle fancies."**

**And among them is he who saith:**

*"Hath the Book been sent down  
through the power of the true Faith?"*

**Say:**

**"The true Faith itself is astounded.  
Fear ye, O ye men of understanding heart!"**

**And among them is he who saith:**

*"Have I been assembled with others, blind?"*

**Say:**

**"Yea, by Him that rideth upon the clouds!"**

**Paradise is decked with mystic roses,  
and hell hath been made to blaze with the fire of the impious.**

**Say:**

**"The light hath shone forth from the horizon of Revelation,  
and the whole earth hath been illumined  
at the coming of Him Who is the Lord of the Day of the Covenant!"**

**The doubters have perished,  
whilst he that turned,  
guided by the light of assurance,  
unto the Dayspring of Certitude hath prospered.**

**Blessed art thou,  
who hast fixed thy gaze upon Me,  
for this Tablet which hath been sent down for thee -  
a Tablet which causeth the souls of men to soar.**

**Commit it to memory,  
and recite it.  
By My Life!  
It is a door to the mercy of thy Lord.  
Well is it with him that reciteth it  
at even tide and at dawn.**

**We, verily, hear thy praise of this Cause,  
through which the mountain of knowledge was crushed,  
and men's feet have slipped.**

**My glory be upon thee  
and upon whosoever hath turned unto the Almighty,  
the All-Bounteous.**

**The Tablet is ended, but the theme is unexhausted.  
Be patient, for thy Lord is Patient.**

**- Baha'u'llah**

**MENU: [HOME](#) » [Reconstruction](#) » [Recovery](#) » [Renewal](#) » [Prayers Directory](#)**

# **Translation of Voice Recording of Chant by 'Abdu'l-Bahá**

**Praise be to God that we are present in this radiant meeting and turning toward the Kingdom of Abha. That which we behold is due to the Grace and Bounty of the Blessed Perfection.**

**We are atoms and He is the Sun of Reality.**

**We are drops and He is The Greatest Ocean.**

**Though we are poor, yet the Treasury of the Kingdom is full of overflowings.**

**Though we are weak yet the confirmation of the Supreme Concourse is abundant.**

**Though we are helpless yet our refuge and shelter is (in) His Holiness Baha'u'llah.**

**Praise be to God!**

**His traces are evident!**

**Praise be to God!**

**His lights are radiating!**

**Praise be to God!**

**His ocean is full of waves!**

**Praise be to God!**

**His radiance is intense!**

**Praise be to God!**

**His bestowals are abundant!**

**Praise be to God!**

**His favours are manifest!**

**Glad-tidings! glad-tidings!**

**The Morn of Guidance hath dawned!**

**Glad-tidings! glad-tidings!**

**The Sun of Reality hath shone forth!**

**Glad-tidings! glad-tidings!**

**The Breeze of Favour hath wafted!**

**Glad-tidings! glad-tidings!**

**The rain drops of the Cloud of Bounty have showered!**

**Glad-tidings! glad-tidings!**

**The hearts are all in the utmost purity!**

**Glad-tidings! glad-tidings!**

**The Sun of the Supreme Horizon hath radiated to all the world with boundless  
effulgence!**

**Glad-tidings! glad-tidings!**

**It is the Splendor of His Highness Baha'u'llah!**

**Glad-tidings! glad-tidings!**

**Zion is dancing!**

**Glad-tidings! glad-tidings!**

**The Kingdom of God is full of exhilaration and commotion.**





# Stars

[DawnSayer@webpal.org](mailto:DawnSayer@webpal.org)

---

## Table of Contents:

### [Prolog: Stars and Prophecy](#)

Astrology is based mostly upon superstition. But is there any role of the stars in regards to prophecy? Some thoughts on that point.

### [Millenium Star: A Heavenly Message for Today.](#)

Everyone has heard of the Star of Bethlehem but there is another ancient prophecy reflected in the flag of almost every Moslem country. It represents a sign and symbol fulfilled in this day by science. People everywhere on the earth can look up and see the sign of the New Age.

### [Conjunction: Coincidence or destiny!](#)

Astounding phenomenon have appeared in the night skies. Are they coincidence or destiny? Either should give one pause to ponder... And the possibility of still further may await regarding the Southern Cross.

### [UFO: Are they real?](#)

The author shares some personal experiences.

[Click here to return to the top of this Table of Contents](#)

---

## Star Thoughts

We all look up at the heavens in astonishment

and wonder what our relationship is to them.

Some feel the stars affect our daily lives -  
and indeed the phases of the moon  
appear to effect not only the tides  
but other affairs of human lives -  
such as the number of births  
in large city hospitals.

Certainly other heavenly effects  
such as sun cycles  
and their effect upon weather  
and radio transmissions are apparant.

In the aggregate  
there does seem to be a correlation  
between personalities and sun signs  
and the Chinese cycles of birth years  
appears to have some substance.

But the speculations of astrologers  
are simply superstition  
that have no more significance  
(and no less)  
than that of reading tea leaves,  
or entrails,  
or consulting a Ouiji Board.

I say no less,  
because astrological prediction  
is not something that can be left  
to the mathematical calculation of computers.  
It depends upon "psychic" interpretation  
and like all psychic phenomena  
has an explanation within human reality  
(more often human unreality)  
that it is detrimental to deal with.

Click here to return to the  
top of this  
[Table of Contents](#)

**MENU:** [HOME](#) » [Reconstruction](#) » [Recovery](#) » [Renewal](#) » [Survival](#)

---

---

# Prophetic Stars of Heaven

**"And I will shew wonders in heaven above"**

(King James Bible, Acts 2:19 )

If you have some suggestions or comments you would like to pass on to me about these pages you may do so at: [DawnSayer@webpal.org](mailto:DawnSayer@webpal.org)

---

## The Sesquicentenary (150th Year Anniversary) of the Revelation of Baha'u'llah

### *Prolog:*

**In 1852**

**(150 years ago this year - 2002)**

**there sat in Siyah-Chal the Black Dungeon of Tihran**

**Baha'u'llah**

**with His feet in stocks**

**and about his neck an enormous chain**

**of unbearable weight.**

**He was imprisoned there from August 1852 to December 1852**

**before being exiled to the Most Great Prison in Acca.**

### *The Story:*

**The Black Dungeon was really little more**

**than an unlit sewer**

**in which were chained together thieves, robbers and highwaymen,**

**awaiting their execution.**

**It was without bathing or toilet facilities**

**creating a horrible stench**

**that repulsed those sent to remove anyone from there.**

*Remember My days during thy days,  
and My distress and banishment in this remote prison.  
(Baha'u'llah, Compilations, Baha'i Prayers, p. 210)*

**The Bab too  
had been a prisoner.**

*Praise be unto Him  
Who at this very moment  
perceiveth in this remote prison  
the goal of My desire.*

*He is the One Who beareth witness unto Me at all times and beholdeth Me ere the inception of 'after  
Hin'.<sup>[1]</sup>*

**[1 The numerical value of the letters of the word Hin is 68.  
The year 1268 A.H. (1851-1852 A.D.)  
is the year preceding the birth of the Baha'i Revelation.]  
(Above selection from: The Bab, Selections from the Writings of the Bab, p. 18)**

**And so it was  
that in the YEAR NINE -  
which Moslem Year began in October 1852 A.D.  
(1269 A.H. the year 'after Hin')  
that Baha'u'llah while in the Black Dungeon  
sometime between October and December 1852 A.D.  
received:**

***The Revelation:***

*"I was asleep on My couch:  
the breaths of My Lord the Merciful passed over Me  
and awakened Me from sleep:  
to this bear witness the denizens [of the realms]  
of His Power and His Kingdom,  
and the dwellers in the cities of His Glory,  
and Himself, the True.*

*I am not impatient of calamities in His way,  
nor of afflictions for His love  
and at His good pleasure.*

*God hath made affliction as a morning shower  
to this green pasture,  
and as a match for His lamp  
whereby earth and heaven are illumined.*

(quoted by Abdu'l-Baha, A Traveller's Narrative, p. 77)

"The Couch" is thought of as a symbolic reference to what Baha'u'llah refers to elsewhere as "the tomb of the body". Far was he from having the comfort and luxury of a sofa. These were terrible times of martyrdom and suffering for the Faith.

The same month that year that saw the imprisonment of Baha'u'llah also saw the martyrdom of Tahirih (Qurratu'l-Ayn) "at the height of her beauty and power" (William Sears, Release the Sun, p. 120)

The Dispensation of the Bab ended when Baha'u'llah experienced the intimation of His mission in the Siyah-Chal, the subterranean dungeon in Tihiran in which He was imprisoned between August and December 1852.

(The Universal House of Justice, Messages 1963 to 1986, p. 739)

The intimation of His Revelation to Baha'u'llah in the Siyah-Chal of Tihiran, in October 1852, marks the birth of His Prophetic Mission and hence the commencement of the one thousand years or more that must elapse before the appearance of the next Manifestation of God.

(The Kitab-i-Aqdas, p. 196)

### *Signs in the Heavens:*

Such momentous happenings were symbolized by happenings in the very heavens above.

*"...I see a strange, a unique conjunction in the stars.  
It has never occurred before.*

*It proves that a momentous event is about to take place..."*  
(quoted by Abdu'l-Baha, Memorials of the Faithful, p. 110)

Biela's comet disappeared in 1846. It returned in August, 1852.

**This was the very month and year in which Baha'u'llah was cast into an underground prison in Teheran. It was the beginning of the forty years of his Mission which ended in Israel in 1892 with his death; the forty years foretold by Micah during which God would show to the Messiah 'wonderful things'.  
(William Sears, Thief in the Night)**

**The Americana record of this astronomical event states:  
"Late in August, 1852, the larger portion again came into view; and three weeks later the smaller one, now much fainter than its former companion was seen about 1,500,000 miles in the lead." Sir James Jeans confirms this: "Six years later [1852], when the comet's orbit again brought it near to the sun, two pieces were observed to be one and a half million miles apart." ...Following this twin-appearance, Sir James Jeans states, "neither of them has been seen in cometary form, but the place where they ought to be is occupied by a swarm of millions of meteors, known as the Andromedid meteors. Occasionally these meet the earth in its orbit, and make a grand meteoric display." The two comets were no longer separate comets, but were mingled in one great shower of light, just as the Faith of the Bab and Baha'u'llah are not separate but one in the light which they shed upon the earth.  
(William Sears, Release the Sun, p. 218)**

***'Have the stars fallen?'*  
*Say: 'Yea, when He Who is the Self-Subsisting*  
*dwelt in the Land of Mystery (Adrianople).*  
*Take heed, ye who are endued with discernment!'*  
*All the signs appeared*  
*when We drew forth the Hand of Power*  
*from the bosom of majesty and might.*  
(Baha'u'llah, Epistle to the Son of the Wolf, p. 132)**

**It is said in Scripture and Tradition that at the time of the birth or announcement of every Messenger of God, a star or a sign appears in the heavens. Nimrod was warned of the star that told of the coming of Abraham. The soothsayers warned Pharaoh of the star in the heavens that foretold the coming of Moses. The Magi informed Herod of the new star that guided them to the throne of the "spiritual king," Jesus. The same legend is told of Buddha, Zoroaster, Muhammad and Krishna. What were the signs in the heavens during the appearance of the Bab and Baha'u'llah? The holy Scriptures of all faiths had spoken of**



**Twin-Revelations that would appear at the "time of the end." Now that the Bab and Baha'u'llah had appeared, fulfilling these prophecies, what were the signs in the heavens? Signs, not for one, but for two Messengers of God, Who would appear almost simultaneously? Some of us know the story of the great comet of 1843 which foreshadowed the coming of the Bab. Sir James Jeans, late British astronomer and mathematician, stated in his book *Through Space and Time*, "oddly enough, many of the most conspicuous appearances of comets seem to have coincided with, or perhaps just anticipated, important events in history. (William Sears, *Release the Sun*, p. 217)**

*With regard to the spiritual influence of stars,  
though this influence of stars in the human world may appear strange,  
still, if you reflect deeply upon this subject,  
you will not be so much surprised at it.*

**(Abdu'l-Baha, *Some Answered Questions*, p. 245)**

## ***Heavenly Events in 2002:***

**In this Sesquicentenary Year of the Revelation of Baha'u'llah marvelous events are once again happening in the heavens.**

**Five planets, Jupiter, Mars, Saturn, Mercury and Venus assembled in a rare alignment during Ridvan this year. Such an astounding display won't be repeated for a century. It was an amazing thing for us to observe as we returned home from the Convention Report on eve of the 5th Day of Ridvan.**

**The five-planet array is a "standout" of the 21st Century, says Robert C. Victor, an astronomer who volunteers at the Abrams Planetarium of Michigan State University and has specialized in predicting and observing unusual configurations of the planets for nearly four decades.**

**Victor said there will be only three other chances in the coming 100 years to see five planets so tightly grouped, in September 2040, July 2060, and November 2100.**

**"BUT the groupings of 2040 and 2100 will have some of the planets barely above the horizon as darkness is falling, so viewers will likely have to resort to using binoculars," Victor said. "None of these three groupings will be as accessible to casual skywatchers as (was) the ... spectacular gathering in late April and early May."**

***And there shall be signs in the sun,***

**and in the moon, and in the stars;  
and upon the earth distress of nations,  
with perplexity; the sea and the waves roaring;**

**Men's hearts failing them for fear,  
and for looking after those things which are coming on the earth:  
for the powers of heaven shall be shaken.**

**(King James Bible, Luke 21:25-26)**

**While momentous events may be heralded in the heavens  
let no one confuse this recognition,  
of the relationship of all things -  
and the appreciation of the mysteries  
that exist in the heavens and nature,  
with the superstitions of Astrology.**

**"Concerning your question  
as to the influence of the stars and planets  
on the life of a believer;  
such ideas should be entirely dissociated from the Teachings.  
(Compilations, Lights of Guidance)**

***O handmaid of God!  
The stars in the sky do not exert any spiritual influence on this world of dust;  
but all the members and parts of the universe  
are very strongly linked together in that limitless space,  
and this connection produceth a reciprocity of material effects.  
(Abdu'l-Baha, Selections from the Writings of Abdu'l-Baha, p. 160)***

**"Astronomy is a science, astrology does not come under the same category, but we should be patient with people who believe in it, and gradually wean them away from reliance on such things."**

**(Compilations, Lights of Guidance, p. 516)  
(From a letter written on behalf of Shoghi Effendi,  
dated December 24, 1941, to an individual believer, Ibid., p. 10)**

**"We should attach no importance to astrology or horoscopes. No exact science is involved, though sometimes some truth seems involved, but the percentage is small."**

**(Compilations, Lights of Guidance, p. 516)  
(From a letter written on behalf of Shoghi Effendi,  
dated January 15, 1951 to an individual believer, Ibid., p. 18)**

**"...it is absolutely essential that the teachings should not be confused with the obscure ideas related to numerology and astrology and the like. Individuals interested in them are free to believe in and credit such ideas and to make any inferences and deductions they desire from them, but under no circumstances are they expected to identify them with the principles and teachings of the Cause. We must at this stage preserve the purity and sanctity of the Baha'i teachings.  
(Compilations, Lights of Guidance, p. 516)**

---

**and then there is**

**[The Millennium Star](#)**

**And in the Future  
the Sign of the Southern Cross  
but that is a story for a future time.**

**MENU: [HOME](#) » [Reconstruction](#) » [Recovery](#) » [Renewal](#) » [Star Directory](#)**

---

---

# **My UFO Experience**

**by Bruce Beach**

**If you have some suggestions or comments you would like to pass on to me about these pages you may do so at: [DawnSayer@webpal.org](mailto:DawnSayer@webpal.org)**

---

**I was a USAF control tower operator in the 1950's at Dobbins Air Force Base near Atlanta Georgia.**

**This air base was one of five in the US that was an authorized stop for top secret aircraft and as such one had to have special security clearance to work at the base.**

**Many strange aircraft such as Flying Wings, the Black Bird, and others, visited our base. They were usually parked under special guard - some distance away on the tarmac.**

**We also had so many UFO sightings that the tower was equipped with a special 3-D camera (something very unusual in those days) to take pictures of them - and there was a special form maintained in the tower that all operators on duty had to fill out - when a sighting took place.**

**I will tell you about my own sighting experiences at that tower and later at another one,**

**but first I wish to make mention of four other prior acquaintances that I had with the subject.**

**I have told these following stories in lectures to a number of astronomical societies (usually with accompanying slides) and have presented them to a number of UFO investigators.**

**In those days - UFO sightings were a very hot subject, and my native Kansas was a particularly active location, perhaps fittingly, because Wichita is called the Air Capitol of the World, with its many aircraft design and manufacturing plants.**

**My first experience was when at age fifteen I attended a lecture by a UFO abductee (I have known a great many - and will also tell you about some of them). He attributed the UFOs to five apertures in the earth and reported unusual capabilities of their operators such as the ability to levitate.**

**About that time a Kansan reported that he had been traveling down one of our empty Kansas highways when he spotted some aliens on one side of the road and a spacecraft on the other.**

**The aliens scurried back across the road to the spacecraft and he tried to stop**

**but hit and killed one of them.**

**He took the body to the University of Kansas where it was autopsied and found to have human-like blood.**

**The body was about three feet tall**

**and appeared to be that of wizened old male with pink skin.**

**It was dressed in a silk like garment.**

**The autopsy is well documented at the university.**

**Another report of the same time came from a very reliable source.**

**This from a retired pharmacist and his wife who were flying overseas**

**and he shot the pictures out the airliner's window.**

**There is no way that such a substantial and reliable citizen would have faked the pictures or had the technology to do so.**

**The film was developed at the Kodak laboratory and it was then that the UFO was seen.**

**The pharmacist had not noticed it when taking the footage.**

**The film was shown to have been absolutely untampered with.**

**Finally, during my air traffic control training**

**I had to take training in radar.**

**There the instructors explained about an incidence that had occurred with the same type of equipment in the pacific.**

**These specialists have as much confidence in their equipment as I do in my own eyes.**

**UFOs would appear on their screens when there were no aircraft in the area.**

**These would sometimes stand stationary and at other times move along courses at speeds that were not possible for any known aircraft.**

**They would also make course changes at an angle - and altitude changes that were impossible for any known aircraft.**

**A great amount of effort was made investigating the phenomena with numbers of top experts flown in from the states.**

**None of the above experiences were my own but you can imagine my eagerness and interest about the subject especially with so many items appearing almost daily in the press and given the hushed and excited talk among my fellow operators in the tower when they would come off duty having had to have filled out a sighting form - although they were forbidden to share the sighting details.**

**I bemoaned my deprivation - and at that early age of eighteen was already quite inclined to be given to speculation about both scientific and mystical matters. I had completed a couple of years of college and was in my third year - my Air Force duties being arranged so that I could attend the University of Georgia full-time.**

**During one of my many metaphysical discourses in the Base Operations the chief dispatcher spoke up and said -**

**"Well, if you really want to see a UFO there will be some here Saturday night."**

**"What? How can you know that? They are totally unpredictable. I don't believe it."**

**"Oh, yes - they will be here."**

**"How? Why? How? Why?", I insisted.**

**Finally, he said,**

**"Well, if you must know,  
I am a Rosicrucian and I meditated -  
and that is the message that I got."**

**Now - I was doubly doubtful,  
but I agreed to come.**

**He was going to be on duty that night -  
and we were to arrive before sunset.**

**Numbers of others heard about my discussion with him  
and about 20 of us gathered on the lawn  
between the control tower and the Base Operations Building.  
Some came equipped with telescope and binoculars.**

**We also brought watermelon  
and much discussion between myself and the Rosicrucian.  
(I suspect that you can imagine myself in such discussion -  
now over 50 years ago.**

**One person later told me later that he hadn't even known  
that it was possible to think thoughts like that.)**

**Dusk came and the mosquitoes came out.  
I suggested that we take the discussion inside.  
About an hour after total darkness  
the squawk box from the tower blared -**

**"We have UFO's out here."**

**"Are there any planes in the area?"**

**"Yes, two JUGs (fighter trainers)**



**from the Naval Air Station."**

**"Well, send them after them!"**

**(Established SOP (Standard Operating Procedure)  
at this tower.)**

**From the first bleep of the squawk box  
the screen door of the operations shack had flown open  
and a crush of airmen had poured out onto the lawn.**

**"Where?"**

**"There!"**

**"I see them."**

**Through the open doors and windows  
we could hear over the squawk box  
the discussions taking place between the tower  
and the pursuit planes.**

**"Yes, tower, I see them - will pursue".**

**There was a battle going on to access the telescope.  
A voice from the tower -**

**"Turn on the GCA -  
(the Ground Controlled Approach radar).**

**"It will take 30 minutes to warm it up".**

**"Go look at the weather radar".**

**I was too low in the pecking order  
to have any hope of looking through the telescope  
or one of the sets of binoculars -  
but from the tower to the Base Operations Office**

there was a wire stretching down (for the squawk box).  
This I lined up on the largest of the three UFOs  
and could see that it was starting to move.

There were three in view.  
One larger and the other two smaller or further away.  
They had the appearance of a bright orange light -  
about the same as one sees on oil well flares -  
if you are familiar with those.  
One the diameter of a quarter - the other a nickel and a dime.

Their presence had been there for three or four minutes,  
but now they began to fade  
and from the pursuit plane we could hear -

"Tower- they have disappeared."

"R-roger. We don't see them any longer, either.  
Return to your pattern."

I, and my audience, :)  
returned to the operations building  
and the dispatcher and I continued our discussion  
for another hour or so.  
End of this event -  
but they get more exciting.

Now, for a daytime sighting.  
(These stories are usually accompanied by photos -  
and I guess I could scan and put them here -  
well, maybe someday -  
but I feel guilty about taking so much time  
to write this - as it is.)

**This next event happened on an exceptionally beautiful Saturday.**

**Usually, I worked the mid-night shift so that I could attend school - but I was also required to pull weekend day shifts.**

**The ANG (Air National Guard) pilots had to get in so many flying hours each month in order to maintain their ratings.**

**The weather being exceptionally beautiful - this is the day they all decided to fly. The field had never been so busy.**

**Three control tower operators on duty already - and I was a spare - with no position available at the console.**

**Sort of there on punishment for not pulling regular shifts.**

**So I had to sit perched on the slanted ladder (that went up to the roof) behind the radio receivers.**

**Excellent view - but borrrring.**

**No duty except to watch.**

**Down on the tarmac every old C-45 in the place was cranking its engines.**

**(If I hadn't had to work -**

**I would have flown with one of them.**

**I have all sorts of stories about flights in different kinds of planes, crashes and other exciting events,**

**but I can always tell more than people can bear to hear. That comes from being a raconteur.)**

**The old C-45s were OLD.  
And their radios didn't work very well.**

**"Tawr ths 4#%euc"  
"Say again aircraft."  
"#%^ tAWR thiz AF 47.^\*\*"  
"Aircraft you are garbled -  
wiggle your flaps and we will use the light gun."  
"@#\$@%%"**

**While all this was taking place the three controllers  
would all move over by the speaker  
and sort of bend their ears down to it to try to understand it.  
And I would sit on my perch -  
sometimes giving an advisory -**

**"Plane at base" (the last turn before final)  
"Plane entering on downwind"**

**A couple of miles from the field  
and running parallel to it  
was a large power line  
running through a swath cut in the trees.  
About once a week a small plane would fly down the power line  
to check it.**

**As I was watching I could see the plane  
which was at too great a distance for me to make mention  
but then it did something unusual -  
it turned back away from the tower  
and then back toward the power line  
and I thought -**

**"Aha! the pilot has spotted something that he is going to double check."**

**But then -  
instead of turning and following down the power line  
the plane continued on towards the field.**

**"Small plane entering on the downwind", I said.**

**A wave from the A controller, who did not even look up -  
from trying to understand the speaker with the other controllers.**

**Somehow, the plane was looking strange to me.  
In varying light and at varying angles  
one has to somehow to sometimes tilt their head  
to identify the aircraft silhouette  
and the type of aircraft they are observing.  
I couldn't see any wings.**

**I leaned forward  
and picked the binoculars off the radio console.  
Put them to my eyes -  
took them away -  
put them to my eyes again -  
and stood up on one rung of the ladder  
leaning out by holding onto another rung  
and pointing with the binoculars said,**

**"Get the camera -  
(which was sitting on the window sill  
beside the B operator position)  
we have a UFO out here."**

**Again - a wave from the operators.**

**"Look - its a UFO!"**

**At this point the UFO had come up and parked right in front of the tower window.**

**Traditional form saucer shape - bubble on top that appeared solid also without windows. Possible power ports at both ends.**

**The operators now turned and looked at me - rather than out the window.**

**"Where?"**

**"There!", pointing with the binoculars.**

**But as they turned - it left - at the speed of light to my right. They never saw it.**

**I had better luck the next time. It was a midnight shift and the shift chief was S/Sgt. Kelly. There were only ever two people on the night shift - myself and a shift chief.**

**Usually, I was the only one awake. They all loved to work with me because I would sit at the console doing my studies all night long - and they could sleep.**

**Kelly slept on the floor with his feet towards me - so that I could tap them if I heard the OD (Officer of the Day)**

**coming up the stairs.**

**Then he would just kind of sit up on the floor like he was adjusting the radios in the console that was between us and the stairway.**

**This night we had only one aircraft in the pattern - a PBY (Patrol Boat Navy - they can land on both land and water) over from the Atlanta Naval Air Station that was getting in a required number of TOL (Take Offs and Landings) (you want them to come out to an even matching number). They say the PBY takes off at 75 mph - flies at 75 mph - and lands at 75 mph. Not too terribly exciting but we did have one pilot that had flown with Doolittle - and we were always coaxing him to do a JATO - (Jet Assisted Take Off) in which the plane would fairly jump into the air.**

**Our base commander had made a ruling much to the pilots' chagrin that the planes had to fly the full length of our ten thousand foot runway before turning out. It made for a long time consuming flight for a PBY. Another thing about the PBYs was that the tower was supposed to visually check that their gear was down - because some of the Navy pilots would forget that we were a land base. Over on the land runway at the Naval Air Station they had a great big bill board that said - "WHEELS" -**

**but we didn't.**

**The PBY had lumbered into the air  
and was flapping down the runway  
and I was taking one last look around  
before I returned to my studies -  
when I noticed a light far off the end of the runway.**

**Hmmm. Strange.**

**Maybe the red light on the end of the Lockheed plant.  
Nope. Over to my right the Lockheed light is still there.  
Maybe something on the mountain.**

**Binoculars -**

**and scan down to the skyline.**

**Nope - it is above the skyline.**

**Big light - maybe Venus -**

**though that is not usually red -**

**and we are past midnight - way too late for Venus  
and wrong direction and not early enough  
for when it becomes the Morning Star.**

**Hmmm. Better study this.**

**Aircraft maybe.**

**Steady watch.**

**No motion.**

**No change in size - not approaching or retreating.**

**Possibly a helicopter standing steady -**

**but no aircraft advisories and highly unlikely.**

**Theodolite - but way too distance -**

**and again holding steady.**

**Besides no notification from weather that they were launching.**

**The PBY has now long turned out -**

**and is on downwind.**

**"Uh, Kelly,  
we have something strange here -**



**I think you had better look at it."**

**"What is it?"**

**"I don't know -  
I want you to look at it."**

**"Why?"**

**"Well, I think it may be a UFO."**

**"Knock it off, Beach"**

**"Kelly, take a look at this,"  
tapping his shoe with my boot.**

**"Grrrf. Knock it off, Beach"**

**"Kelly, look at this -"  
accompanied with a really solid kick!!**

**"Growllf -" and Kelly has sprung up.**

**"Beach, I am going to -"**

**"Look -" I say pointing with one hand -  
with the other still holding the binoculars  
to my eyes.**

**I have never taken them off the UFO  
the whole time that I have been talking to Kelly.**

**"What is that?"**

**"I don't know. A UFO."**

**"Where is the PBY?"**

**"On the downwind.  
Let me send it after it."**

**"No.  
What is that?"  
Kelly now has another set of binoculars  
trained on it.**

**"A UFO -  
lets send the PBY after it."**

**"We can't do that.  
What do you think that is?"**

**"A UFO."**

**At this point the PBY speaks up -**

**"Tower, this is PBY on downwind -  
gear down and locked,  
request permission to land."**

**"Negative PBY, check at base."**

**A long silence. The pilot is looking around -  
wondering what in the world? Finally, he says -  
hesitantly -**

**"R-roger tower, will check base."**

**"Kelly, let me send him after it -  
he will be glad to go  
and he doesn't have anything else to do.  
We are authorized to send pursuit planes."**

**"What do you think it is?"**

**"It is a UFO Kelly.  
C'mon Kelly - lets check it out."**

**All this time both Kelly and I have our binoculars  
on the UFO. I only take mine down to speak to the PBY.**

**"Tower, this is PBY at base -  
gear down and locked  
request permission to land."**

**"Come on Kelly -"**

**"Tower, this is PBY at base -  
gear down and locked  
REQUEST permission to land."**

**"Negative, PBY.  
Check at final."**

**A REALLY long silence.**

**"Roger tower."**

**"Come on Kelly -  
when he turns final  
he is going to be lined right up with it.**

**---**

**He can just go right ahead after it.  
Let me send him after it Kelly."**

**Silence from Kelly.**

**"Tower this is PBY.  
Turning on final -  
Gear down and locked.  
AM I cleared to land?"**

**"TOWER! This IS PBY.  
On final - AM I cleared to land?"**

**"Roger, PBY, your are cleared to land."**

**"THANK YOU, tower." (Pure ice in the voice).**

**Kelly finally speaks.**

**"Okay, you can ask him if he wants to go check it out".**

**"Alright!"  
I grab the mike.**

**"But you can't speak to him on final."  
(This was SOP)**

**"Arrrrrgh."**

**Wait, wait, wait.  
Watch UFO through the glasses.**

**(Kelly never takes his off it).**

**Glance back at the PBY.  
Wait, wait, wait.  
Watch UFO through the glasses.  
Glance back at the PBY.  
This one must have figured out how to fly at 30 mph.**

**Finally, the PBY touches down.**

**"PBX - continue landing roll for immediate take off.  
There is a UFO off the end of the runway -  
we would like for you to take a look at it."**

**"Roger Tower - PBX continuing landing roll  
for immediate take off."**

**"Tower - this is PBX  
we are airborne -  
where is the UFO."**

**"Directly ahead of you PBX."**

**Silence.**

**"Tower, this is PBX -  
we still do not see the UFO."**

**"It is directly ahead of you PBX."**

**Silence.**

**And then as Kelly and I watched  
the UFO faded away.**

**"Tower, this is PBX -  
we still do not see the UFO."**

**"Roger, PBX.  
It has disappeared.  
Check gear on downwind."**

**"Roger, Tower."**

**You can see why shift chiefs**

**don't like to send planes after UFOs -  
but it was nice to have SOMEONE seeing  
what I was seeing.**

**The next episode also occurred at night -  
but this time it was in perpetual 24 hour night  
in the Arctic.**

**Again, I was the only operator awake in the tower.  
Suddenly, there would be a light flash  
out of the corner of my eye.**

**I would jerk my head up from my studies,  
or turn around if I was standing up.**

**Gone - nothing.**

**We had no light beacons in the subdued lighting  
of this SAC base.**

**Sudden alerts would occur.**

**Doors at both ends of the hanger would roll up  
the fighter would fire up in the hanger -  
and be gone -  
straight down the runway -  
afterburner blazing as it hurled into the sky.**

**But usually nothing.**

**Just darkness and subdued lights about the base -  
except -**

**except --**

**I know I saw a light.**

**Ask others -**

**do they ever see it.**

**Nope.**

**Almost a pattern, I decide.**

**Hours to sit in the darkened tower.**

**Trying to stare out into the darkness  
with out blinking.**

**There it was.**

**Darkness.**

**And again.**

**Now I know the direction to look.**

**There.**

**Now.**

**Again.**

**And again, and again, again.**

**But then long periods in between.**

**Some strange phenomena.**

**But not the Northern Lights - we are too far north.**

**Days of study.**

**Finally, I know.**

**It is the water trucks,  
turning first one curve and then another  
up in the mountains  
below the skyline  
but their headlights faintly catch  
many miles away  
the snow cliffs on another mountain.**

**Light is phenomenal -  
and there are natural explanations  
for much of what we see.**

**The early autopsy at the University of Kansas  
had a natural explanation.**

**The creature had human like blood  
because it was a Rhesus monkey.**

**That is from where we get the term RH factor for blood.**

**The hoaxer had amputated its tail,**

**let it heal, shaved it,  
dressed it in silk,  
and killed it -  
before going to the university with his story.**

**The retired pharmacist  
was not a hoaxer.  
He actually shot the amateur movies.  
They weren't doctored.  
It took many hours of flying an identical aircraft -  
at different angles to the sun  
while shooting an identical camera  
from the seat in which he had been sitting -  
to get the light reflections from off the tail  
to again create a UFO on the film.**

**The military radar men  
were straight arrow also.  
They saw what they saw.  
But what they saw,  
it was shown after months of investigation -  
was a radio signal set off by a special code  
aircraft id-transmitter  
sent at a very high frequency  
by planes that were over the horizon  
and completely out of range of their radar.  
The signals somehow bounced off the ionosphere.**

**My Rosicrucian friend may also have been a jokester.  
In any case, I learned to duplicate what we saw that night.  
And have done it.  
An aluminum pie pan like you get with a bakery pie.  
Punch 20 one inch slits in the bottom of it with a sharp knife.  
Take a dozen or so short birthday cake candles.**



**Light them and stick them about the pan.  
Put the open end of a light plastic garment bag  
from the dry cleaners  
over the pie pan  
and scotch tape it to the pan  
so the pan sits evenly below the bag  
and air can be drawn in through the slots in the bottom of the pan.  
The bag will fill with the hot air.  
Release into a dark moonless night  
(in an area where it will not cause a fire when it descends -  
I have had them come down on people's house tops -  
THAT adds to the excitement!)**

**Now stand and point at the UFO.  
You can't tell if its hundreds of yards away -  
or miles away -  
as it glows eerily in the night sky.**

**Took me years to understand my daytime observation.  
Asked psychiatrists -  
(I became a psychiatric social worker  
and took graduate courses in psychoanalytic theory) -  
if we could review the event through hypnosis,  
but that is not possible -  
because just as with reviewing past lives under hypnosis -  
hypnosis IS suggestion -  
one will "see" whatever it is that they are "supposed" to see.**

**Finally, I decided it was a delusion.  
Not even an illusion -  
because with illusions -  
such as mirages or my lights in the Arctic,  
there is some physical base to the phenomena.  
However, I came to the conclusion**

**that if there had been something there -  
with all those hundreds of people at the airstrip that day -  
someone else would have seen something.  
Sometimes you really cannot believe your own eyes.**

**Most of my space abductee friends  
are also deluded.**

**Although, I have met two charlatans.**

**The fellow giving the lectures when I was about fifteen,  
knew that he was lying.**

**Another charlatan of my acquaintance  
may have been deluded at one time.**

**Met with him weekly at a space group luncheon.**

**His books sold many multiples of thousands.**

**Especially in Japan.**

**He would announce that he was going off  
on another space trip -**

**and we wouldn't see him for a few weeks,  
but then he would reappear with another book.**

**My Venusian friend is as honest  
as the day is long.**

**Very deep insights into many things.**

**How many of you have Venusian friends?**

**You may not believe that he is from Venus -  
and I may not -  
but he does.**

**And he travels there quite regularly on occasion.**

**Lots of traffic to Venus.**

**I have a number of friends who have gone there.**

**They are completely schizophrenic  
but it does not make the trip any less real for them.**

**Reality is often hard to determine.**

**In TRUTH - Reality is ALWAYS hard to determine.  
It is nice to have someone share the experience with you -  
as many did with myself and my Rosicrucian friend -  
or as Kelly and I did that night in the tower -  
(I still have no idea what THAT was about).  
But, shared mass delusion is not as uncommon  
as one might think.  
In fact, I would go so far as to say -  
that it is very common in almost all cultures.**

**I believe in flying saucers.  
Just not sure that I have ever seen one.  
I have seen the Roswell autopsy movie -  
(Boy, THAT was good!)  
but the evidence to me seems pretty certain  
that it was a fake.**

**There are many mysteries that I have seen  
in the pyramids and various places  
that I have traveled about the earth -  
that do seem to me to be significant evidence,  
but I feel far too many of my friends  
accept UFO ideas,  
Chemtrail ideas,  
Crop Circle ideas,  
NEO asteroid and planet ideas,  
and all sorts of CONSPIRACY ideas -  
without really sufficient evidence.**

**Some cultural ideas  
about resurrection, rapture, return -  
are so embedded that you do not dare challenge them  
with many individuals.**

**But I can tell you -  
that in the fifty years since my UFO experiences  
I have discovered  
that there are MUCH GREATER MYSTERIES  
and phenomena that YOU can come to understand  
if you are willing to go beyond the  
vague fancies and vain imaginings of most men.**

**Those are the TRUTHS that I seek to lead men into -  
and it is for that reason alone -  
that I take the time to write these long explanations.**

**Those that have already made up their minds  
about these many subjects that I have mentioned -  
will often just be angry that I appear to challenge  
their beliefs.**

**But, I can always hope  
that there will be some  
who truly seek the Truth  
and that will respond -**

**"Beach, if you can really point out the Path -  
then I want to hear about it."**

**It is for they -  
that I always wait and listen.**

**Peace and love,  
Bruce  
DawnSayer@webpal.org**

---

**To see my complete religion series, visit:**

<http://www.webpal.org/essays/religion/religion.htm>

**MENU:** [HOME](#) » [Reconstruction](#) » [Recovery](#) » [Renewal](#) » [Star Directory](#)

---

---