

AT MICROFICHE
REFERENCE
LIBRARY

A project of Volunteers in Asia

Handbook on the Prevention and Treatment of
Schistosomiasis

Published by:

John E. Fogarty International Center for
Advanced Study in the Health Sciences
Building 16A, Room 205
National Institute of Health
Bethesda, MD 20205 USA

Available from:

John E. Fogarty International Center for
Advanced Study in the Health Sciences
Building 16A, Room 205
National Institute of Health
Bethesda, MD 20205 USA

Reproduction of this microfiche document in any
form is subject to the same restrictions as those
of the original document.

SCHISTOSOMIASIS



U. S. DEPARTMENT OF HEALTH, EDUCATION, AND WELFARE
Public Health Service
National Institutes of Health

HANDBOOK ON THE PREVENTION AND TREATMENT
OF SCHISTOSOMIASIS
(A translation of a Chinese publication)

A Publication of the
Geographic Health Studies

John E. Fogarty International Center
for
Advanced Study in the Health Sciences

1977

U.S. DEPARTMENT OF HEALTH, EDUCATION, AND WELFARE
Public Health Service
National Institutes of Health

DHEW Publication No. (NIH) 77-1290

Other Publications of the
China Health Studies Project
Geographic Health Studies
John E. Fogarty International Center
for
Advanced Study in the Health Sciences

Medicine and Public Health in the People's Republic of China
Topics of Study Interest in Medicine and Public Health in the People's
Republic of China: Report of a Planning Meeting
A Bibliography of Chinese Sources on Medicine and Public Health in the
People's Republic of China: 1960-1970
Anticancer Agents Recently Developed in the People's Republic of China—
A Review
Prevention and Treatment of Common Eye Diseases*
Standard Surgical Techniques, Illustrated*
Neurology - Psychiatry*
China Medicine As We Saw It
Chinese Herbal Medicine
Respiratory Research in the People's Republic of China
An Economic Analysis of the Cooperative Medical Services in the People's
Republic of China

*Translations of Chinese documents, produced in very limited
quantities only.

The Government of the United States is reviewing on a continuing basis the national health activities of other countries in order to better serve the escalating medical requirements of the American people. Important elements of all health activities, of course, include biomedical research, medical education, health manpower, and health services. An analysis of these foreign health-related activities and programs may provide the U.S. Government health administrators with new insights in solving some of the complex problems relating to the improvement of health in the United States.

Taking into consideration the historical development of foreign medical systems, it is feasible that no single country or government may have the type of medical care or health system which will provide the completely adequate health assistance desired by our citizens. However, a study of the best features of foreign health systems ultimately may provide a better understanding of the perspective within which health exists in this country, although such a perspective must include improved comprehension of the political, economic, social, and other cultural aspects of society itself.

Such studies are part of the continuing work of the Fogarty International Center of the National Institutes of Health, established in 1968, and named in memory of the late Congressman John E. Fogarty of Rhode Island. This organization was envisioned by Mr. Fogarty and called for in his address to the Third National Conference on World Health in September 1963 as "a great international center for research in biology and medicine dedicated to international cooperation and collaboration in the interest of the health of mankind."

With Senator Lister Hill of Alabama, Congressman Fogarty charted the growth of the National Institutes of Health and the nation's medical research and education for nearly two decades as Chairman of the House of Representatives' Appropriations Subcommittee on the Departments of Labor, and Health, Education, and Welfare.

The many-faceted operations of the Fogarty Center have grown and flourished in collaboration with other American, foreign national, and international bodies and by means of bilateral agreements with the governments of several countries including France, Italy, Japan, and the U.S.S.R. The Center also has the effective and continuing cooperation of international organizations such as the World Health Organization and the Pan American Health Organization and engages in less formal exchanges involving scientists and physicians from the United States and abroad. Similarly, toward the production of new and valuable medical findings, it shares its resources with other elements of the National Institutes of Health and with the U.S. Public Health Service.

In addition to serving as the focus for the dissemination of scientific information emanating from abroad, the Center provides American and overseas scientists opportunities to deal with complex problems of vital concern in mankind's well-being. These opportunities and services are inherent in the Center's International Education Program, in its International Fellowship Program, and on the Visiting Program. Also being implemented is the Center's International Research Program that enables American health professionals

Many and varied health-related topics have been investigated by the Center's Scholars-in-Residence Program, by a continuing program of conferences and seminars, and by its five-year-old Geographic Health Studies Program. This latter enterprise, a series of studies designed to obtain and disseminate comparative knowledge of the health-care systems of other countries, is this publication's *raison d'être*.

This document, titled *Handbook on the Prevention and Treatment of Schistosomiasis*, was published by the Shanghai Municipal Institute for Prevention and Treatment of Schistosomiasis. It contains sections on methods of snail elimination, personal protection against snails, diagnostic measures, and treatment of schistosomiasis patients, as well as a section on schistosomiasis in farm animals. It is part of a series of translations of documents published in other countries on various aspects of health care. They were translated under arrangements with the Library of Congress, the Department of Commerce, or private firms. Many of

these documents have been addressed to specialized Chinese audiences and have been reproduced in limited quantities in this country. Some of the original documents contained irrelevant nonmedical or nonscientific material which has been deleted for the sake of brevity.

Inquiries about this and other publications of the Geographic Health Studies Program should be directed to Dr. Joseph R. Quinn, Head, Geographic Health Studies Program, Fogarty International Center.

Milo D. Leavitt, Jr., M.D.
Director
Fogarty International Center

Information contained in this publication in no way reflects the opinions of the Fogarty International Center, the National Institutes of Health, the Department of Health, Education, and Welfare, or any other agency of the Federal Government.

CONTENTS

	Page
CHAPTER 1. The Schistosome	1
CHAPTER 2. The Elimination of Snails	7
I. Snail Distribution, Activity, and Colonization	7
A. Snail Distribution	
B. Snail Activity and Colonization	
II. The Investigation of Snails	10
A. Methods of Snail Investigation	
B. Questions Regarding the Investigation of Snails	
III. Methods of Snail Elimination	12
A. Eliminating Snails in Rivers	
B. Eliminating Snails in Irrigation Canals	
C. Eliminating Snails in Rice Paddies	
D. Eliminating Snails in Fishponds	
E. Eliminating Snails in Marshland and Grassy River Banks	
F. Eliminating Snails in Complex Environments	
G. Eliminating Snails in Cities and Towns	
H. Eliminating Snails in Reeded Areas	
IV. Frequently Used Molluscicides	22
A. Sodium Pentachlorophenate	
B. Antischistosome-67	
C. Lime Nitrogen	
D. Industrial Wastes	

	Page
V. Some Problems of Snail Elimination in Areas with Water Networks	27
CHAPTER 3. The Proper Treatment of Manure	29
I. Safe Cesspools	29
A. Capacity of Cesspools	
B. Style of Cesspool	
C. Advantages of Cesspools	
II. Compost	38
A. Anaerobic Compost	
B. Aerobic Compost	
III. Chemical Treatment	41
A. Dipterex	
B. Ammonia Water	
C. Lime Nitrogen	
D. Wettable 666	
IV. Methods of Proper Treatment of Manure	42
V. Manure Treatment Regulations of the Fenyg-wei Commune, Chin Shan County, Shanghai Municipality	43
A. General	
B. Ideological Work	
C. Sanitation Members	
D. Manure Management	

		Page
CHAPTER	4. Safe Water Use and Personal Protection	45
I.	Safe Water Use	45
	A. Digging Wells	
	B. Separate Pools for Water Use	
	C. Drawing Water from Midstream	
II.	Personal Protection	58
	A. Avoid Contact with Infected Water	
	B. Prevent Penetration of the Cercariae	
CHAPTER	5. Methods of Diagnosis	61
I.	Stool Examination (Sedimentation Hatching Method)	61
	A. Preparations	
	B. Procedure	
	C. Morphology of Schistosome Ova and Cercariae	
	D. Precautions	
II.	Serum Oval Ring Sedimentation Test	69
	A. Ova Suspension	
	B. Serum	
	C. Test	

		Page
III.	Proctoscopy and Sigmoidoscopy and Biopsy	71
	A. Indications	
	B. Precautions and Procedures	
	C. Differentiation of Ova and its Clinical Significance	
CHAPTER	6. Treatment of Patients	75
I.	Pretreatment Preparations	75
II.	The Selection of Medications and Methods for Schistosomiasis Treatment	75
III.	Oral Medicines	80
	A. Antischistosome-846	
	B. Sodium Antimony Gallate (Antimony-273)	
	C. Furapromidum (F-30066)	
IV.	Potassium Antimony Tartrate (Tartar Emetic)	103
	A. Methods of Tartar Emetic Treatment	
	B. Precautions During Tartar Emetic Treatment; Prevention and Treatment of Toxic Reactions	
	C. Prevention and Treatment of Severe Cardiac Arrhythmia Caused by Tartar Emetic Toxicity	
	D. Prevention and Treatment of Tartar Emetic Toxic Hepatitis	
V.	Treatment of Several Frequently Encountered Concurrent Diseases of Schistosomiasis	126

	Page	
	<ul style="list-style-type: none"> A. Principles of Treatment B. Preliminary Suggestions in the Treatment of Several Concurrent Diseases of Schistosomiasis 	
VI.	<ul style="list-style-type: none"> Treatment of Acute Schistosomiasis 	131
	<ul style="list-style-type: none"> A. Main Clinical Manifestations B. Important Diagnostic Points C. Treatment 	
VII.	<ul style="list-style-type: none"> Treatment of Chronic Schistosomiasis 	134
	<ul style="list-style-type: none"> A. Clinical Manifestations B. Differential Diagnosis C. Methods of Treatment D. Treatment of Complications 	
VIII.	<ul style="list-style-type: none"> Methods of Surgical Treatment of Schistosomiasis 	143
	<ul style="list-style-type: none"> A. Splenectomy B. Bleeding of the Upper Alimentary Tract C. Colonic Pathological Changes in Schistosomiasis 	
IX.	<ul style="list-style-type: none"> Strengthen the Leadership Role in Treatment 	157
CHAPTER	<ul style="list-style-type: none"> 7. Prevention and Treatment of Schistosomiasis Among Farm Cattle 	159
	<ul style="list-style-type: none"> I. Methods of Prevention of Schistosomiasis Among Farm Cattle 	159
	<ul style="list-style-type: none"> II. Methods for Investigation of Schistosomiasis Among Farm Cattle 	159

	Page
A. Requirements for Sending Cattle Manure for Examination	
B. Manure-hatching Method	
III. Methods of Treatment of Schistosomiasis Among Farm Cattle	161
A. Health Examination Procedures	
B. Cattle Not to Be Treated	
IV. Drug Dosage and the Course of Treatment	164
A. Calculation of Body Weight	
B. Drug Dosage and Treatment Course	
C. Determination of Drug Dosage	
D. Requirements for Treatment	
V. Side Reactions and Their Treatment	169
A. Side Reactions of Tartar Emetic and Their Management	
B. Side Reactions of Antischistosome-846 and Their Management	
VI. Work After Conclusion of Treatment	172

THE SCHISTOSOME

The schistosome is a type of trematode that lodges in the portal veins or mesenteric veins of human beings or animals and feeds on blood. The spread of schistosomiasis is dependent on the five stages: the adult schistosome, the ovum, the miracidium, the snail, and the cercaria (Fig. 1).

The adult schistosome. Female and male schistosomes are depicted in Figure 2. The female is slender and long; the male, thick and short. They are generally of the caliber of a cotton string, about 1 cm long, with an oval suction plate on the head and a ventral suction plate on the abdomen. On the ventral surface in the male is a groove where the female and male frequently embrace to fertilize the ova. The life span of an adult schistosome may extend over 10 years.

The ovum. A female schistosome's reproductive cycle will produce about 1,000 ova. Some of the ova follow the bloodstream into the liver; others flow against the bloodstream to enter the intestinal wall. The toxin secreted by the miracidia in the ova may destroy the intestinal wall, thus allowing the ova to enter the intestinal canal and be excreted outside of the body with the feces. Generally after human beings and animals become infested with the cercariae, ova are found in the feces 1 month later (Fig. 3).

The miracidia. After the miracidia emerge from the ova, they frequently group together on the surface of the water (Fig. 4). If they are not able to enter the snail, they will die in 2 to 3 days.

The snail. The snail is an amphibian soft-body animal. It is the intermediate host of the schistosome. The shell of the snail has six to eight left-to-right spirals; outwardly there are transverse streaks. The length is about that of a rice grain. The shape is that of a small screw; that is why it is called the "screw snail" (Fig. 5). Each year a female snail can reproduce over 100 ova. The snail likes to habitate in the dark damp weeds of the banks of rivers and creeks. Decaying plants are its main food.

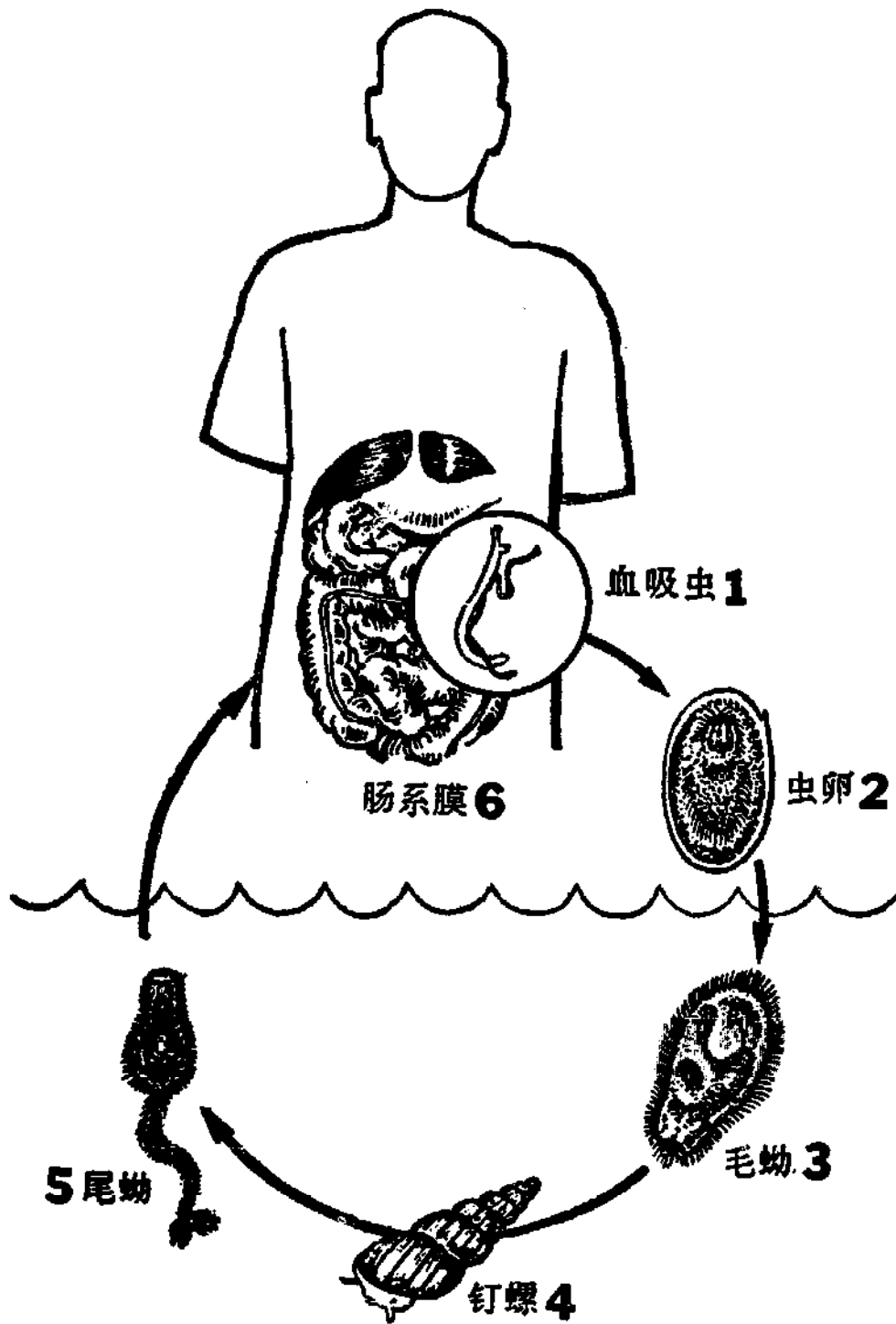

Figure 1. The spread of schistosomiasis.

- | | | |
|----------------|-------------|---------------|
| 1. Schistosome | 2. Ovum | 3. Miracidium |
| 4. Snail | 5. Cercaria | 6. Mesentery |

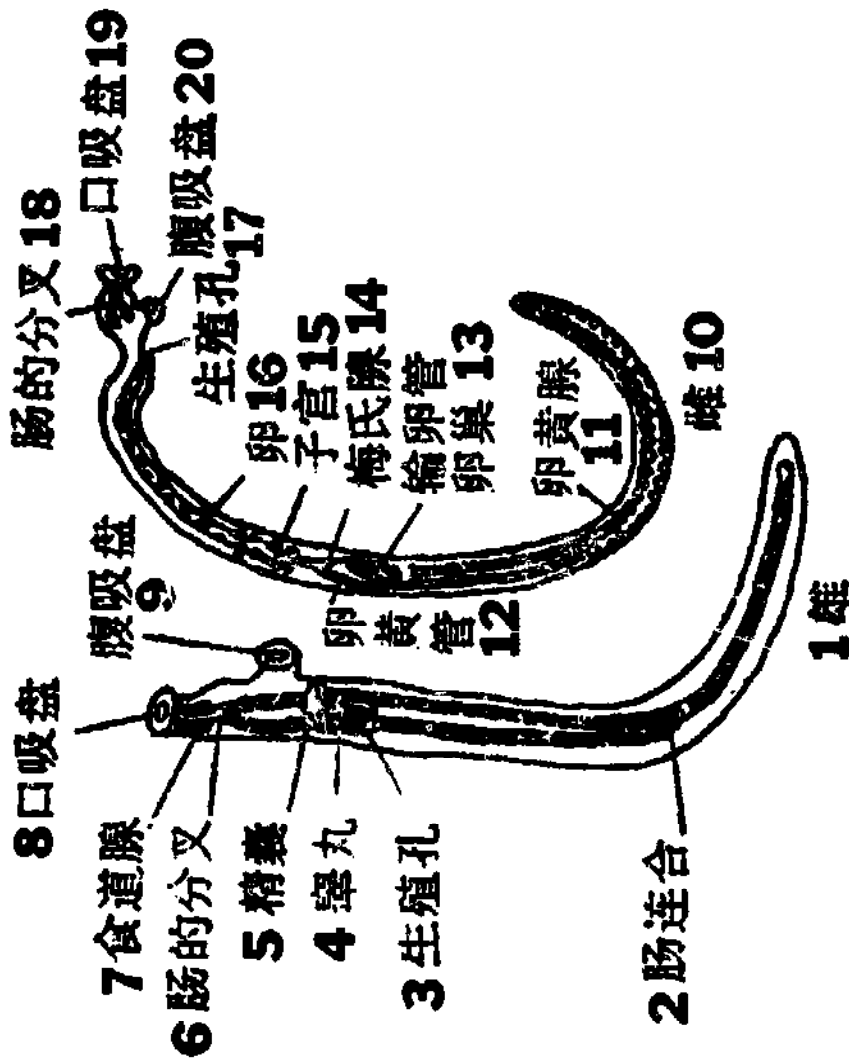

Figure 2. Morphology of adult schistosome.

- | | | | |
|----------------------------|-----------------------|------------------------|-----------------------------|
| 1. Male | 2. Intestine unites | 3. Genital aperture | 4. Testis |
| 5. Seminal vesicle | 6. Fork of intestine | 7. Esophageal gland | 8. Oral suction plate |
| 9. Abdominal suction plate | 10. Female | 11. Vitelline gland | 12. Vitelline duct |
| 13. Fallopian tube, ovary | 14. Mehlis gland | 15. Uterus | 16. Ovum |
| 17. Genital aperture | 18. Fork of intestine | 19. Oral suction plate | 20. Abdominal suction plate |

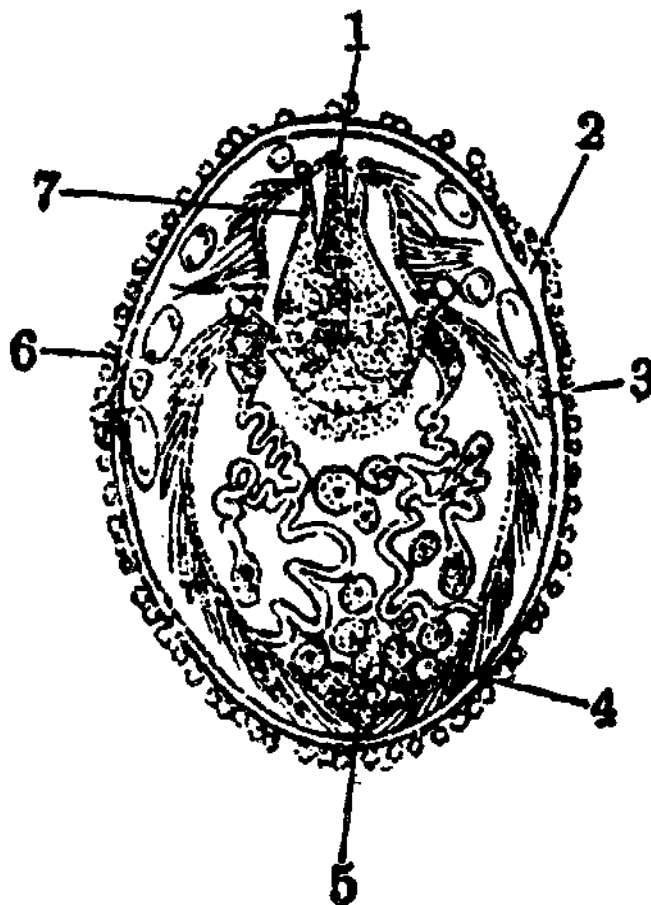

Figure 3. Structure of a schistosome ovum.

- | | |
|--|-------------------------------------|
| 1. Esophagus | 2. Side spicule |
| 3. Blood and tissue cells attached
to shell | 4. Cilia |
| 5. Hair-growing cells | 6. Flame cells and eliminating tube |
| 7. Head gland | |

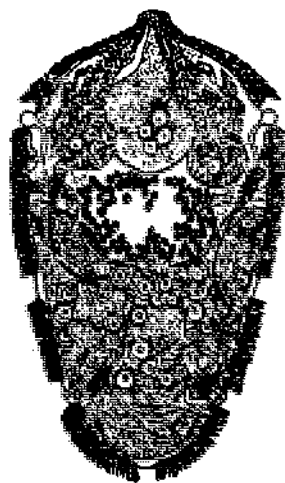

Figure 4. Internal structure of a schistosome miracidium.

The cercariae. A miracidium enters the snail and, after two generations of reproduction, tens of thousands of cercariae are produced (Fig. 6). The cercariae of the schistosome are forked-tail cercariae. They usually are grouped on the surface of the water edge.

The relationship of the five stages is: the schistosome reproduces ova in the human or animal bodies; the ova are excreted in the feces of the human beings and animals and when water is encountered, miracidia are hatched; the miracidia enter the snail and develop into cercariae; the cercariae leave the snail and roam in the water, find opportunity to penetrate human or animal bodies, and develop into adult schistosomes. This life cycle of the schistosome contains the essential requirements for the spread of schistosomiasis. Destruction of any stage of the cycle will prevent the spread of this disease.

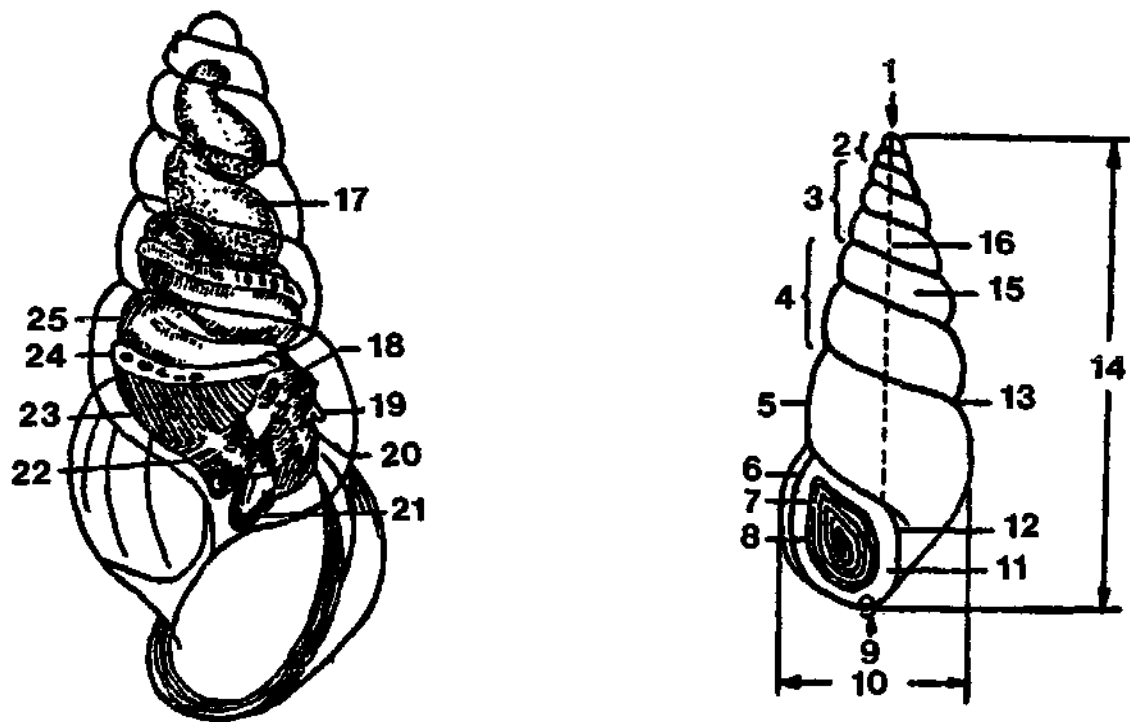

Figure 5. External appearance and position of the soft body of a snail.

- | | | |
|---------------------|---------------------|--------------------------|
| 1. Tip of shell | 2. Nuclear spiral | 3. Posterior body spiral |
| 4. Prebody spiral | 5. Body spiral | 6. Spine of lip |
| 7. Mouth of shell | 8. External lip | 9. Base of shell |
| 10. Width of shell | 11. Internal lip | 12. Umbilicus of shell |
| 13. Crease of shell | 14. Height of shell | 15. Spiral |
| 16. Axis of shell | 17. Liver | 18. Eye |
| 19. Tactile horn | 20. Mouth | 21. Foot |
| 22. External sheath | 23. Cheek | 24. Intestine |
| 25. Accessary gland | | |



Figure 6. Morphology of the schistosome cercarium.

THE ELIMINATION OF SNAILS

The snail is the only intermediate host of the schistosome. Elimination of the snail in an area will stop the spread of schistosomiasis and therefore is an important step in the eradication of schistosomiasis.

I. Snail Distribution, Activity, and Colonization

A. Snail Distribution

River snails. River snails are mainly distributed on the two banks 1 meter above or below water level. They are rarely found below that level. The snails are more densely populated nearer to the water level and less densely populated farther from the water level. Where the slope of the bank is greater, the less the area of population; the less the slope, the wider the distribution. In small rivers, small creeks, and dead-end creeks, the distribution is dense; in large rivers, large creeks, and tide-reaching creeks, the distribution is sparse. In rivers with slow-moving streams, full of weeds, and with rich soil, the snail population is dense and widely distributed; in rivers with fast-moving streams, poor soil, and barren banks, it is sparse. Snails may exist under water in all months of the year, but most of them stay above water level. Snails may exist in shallow soil levels. Except in bitter winter, most of the snails stay in the superficial layers.

Ditch and canal snails. The snails in irrigation ditches and electrical irrigation canals are mostly distributed in a line on the water level. Some snails also exist in the bed of the ditches and canals where they are more easily found during the end of autumn and beginning of spring when irrigation is at a standstill.

Field and mud bank snails. Snails in the rice fields are mostly limited to 1 to 2 meters near the irrigation gutters; some may be found 5 to 6 meters from the gutters. In fields and mud banks easily flooded by rivers, snails frequently are distributed in a flat area.

Lake pool snails. Generally, no snails live in stagnant pools. In lakes and pools infested with snails, there usually is a history of the lake or pool communicating with rivers and streams infested with snails. The distribution of snails in lakes and pools is the same as in rivers and streams.

Complex environment snails. In ordinary areas after a short period of treatment for snail elimination, the distribution of snails changes from linear and large flat areas to spotty and sectional areas. In most places snails cannot be found. Nevertheless, they still may be found in complex environments. At this time, elimination of snails in these complex environments frequently is the key to the complete elimination of snails in this whole area. Complex environments along riverbanks include wharves, bamboo gardens, brick and tile piles, tree roots, damp shadowy banks, banks built of stone, bamboo stalks, boat sheds, and fish storage areas; along ditches and canals they include cement tubes crossing rivers, dams, and cracks in stone mounds; and along fields and mud banks they include tombs, barns, cracks and holes in irrigation gutters, gutters to direct water into and out of fields, footprint indentations by cattle, and the space beneath rice roots and rice stems. Other such places are railroad gutters, highway gutters, troughs along dikes, and dead-end ditches close to the villages. During examination for the elimination of snails, attention should be paid to the many cut-off and isolated snail-infested areas or spots created by road building, ditch-digging, and pioneer farming and to those easily neglected holes of frogs, rats, crabs, and snakes.

Basically, the natural pattern of snail distribution is in the plains of water network areas, mainly on the longitudinal or transverse crossroads of rivers, irrigation ditches, and electric irrigation canals and the lakes, pools, low swamps, and banks that are connected with them (Fig. 7). The factors in this pattern of snail distribution may change and affect each other. Sometimes, because they are carried by humans in their daily work, snail-infested points may occur that are not connected with rivers or ditches.

B. Snail Activity and Colonization

Snail activity. In different seasons the activity of the snail and the increase or decrease of density in the superficial soil (i.e., snails in the deep

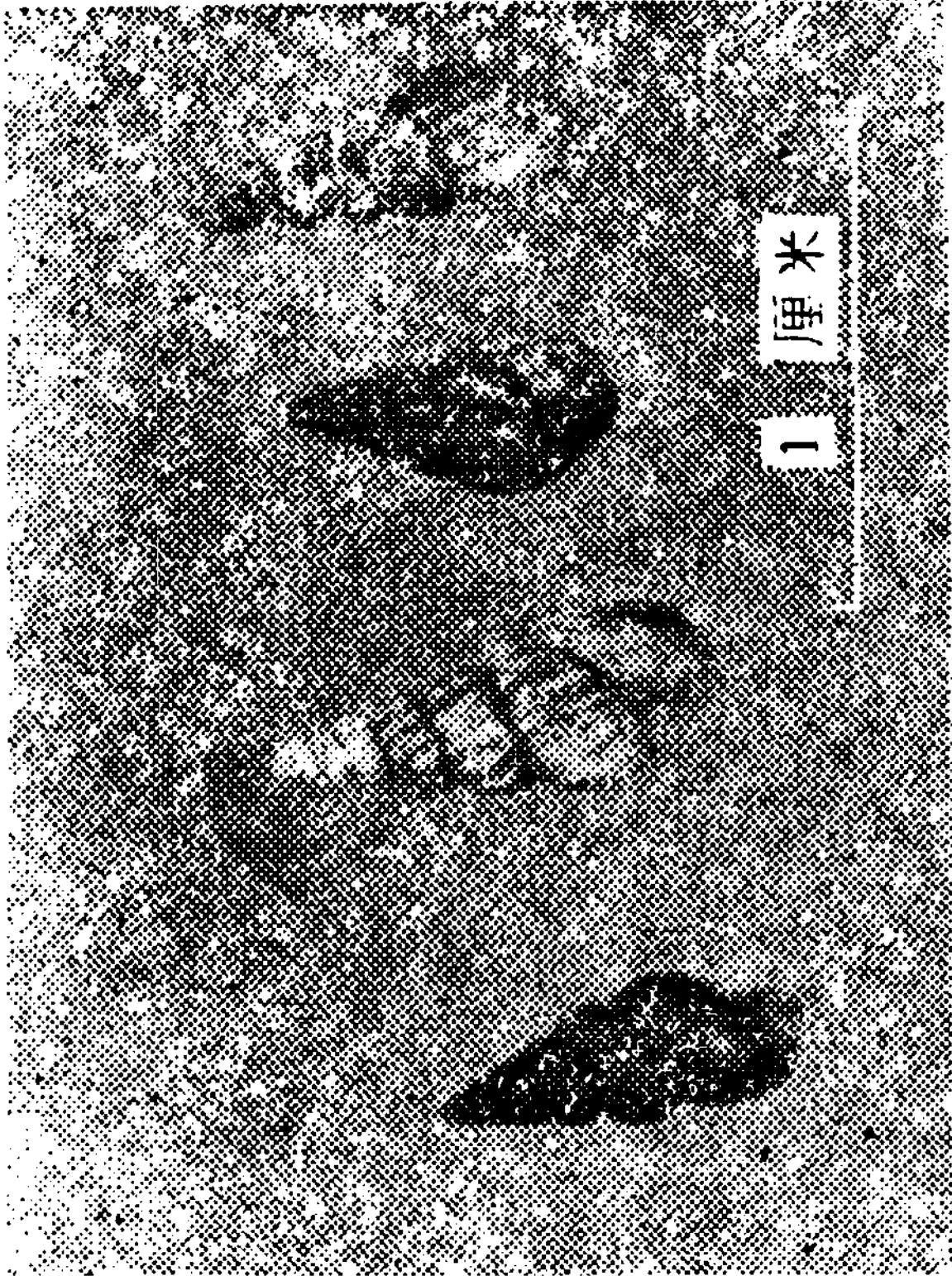

Figure 7. Snails in water network areas.

1. Cm

soil layer moving towards the superficial soil layer) vary according to the changes of weather. Activity of the snail is strongest in March, April, and May and again in September and October. It becomes weaker in June, July, and August and in November. Especially from December to February, very little activity occurs. During one year there are two seasonal increases of snail density along riverbanks; the peak in the first half year is in April and May and in the second half year in September and October. In spring and autumn the density of snails in the deep soil layer becomes less and is higher in the superficial soil layer, whereas in summer and winter the density of snails increases in the deep soil layer and becomes less in the superficial soil.

Snail colonization. The snail may copulate throughout the year but is most active during March, April, and May. The season for laying ova lasts from March to July, with the highest peak in May. The most frequent site for laying ova is damp, moist areas near water level. From these ova, young snails may be seen in April; most snails are seen in June. With suitable temperatures, it takes about 2 months from hatching to maturity. The life of a mature snail may last 1 to 2 years.

In summary, March, April, May, September, and October are the main months for snail activity, colonization, and growth. The snail appears in the superficial soil most often during these months that are therefore most suitable for investigation and the elimination of the snail.

II. The Investigation of Snails

The investigation of snails is the prelude to the elimination of snails. If the investigation is not clear, then the elimination will be incomplete. The requirements for the investigation of snails in water network areas are: following the water system; investigating snail-infested rivers and canals systematically; and checking fields, banks, or pools connected with the rivers and suspected of snail infestation. Also, the distribution of snails and their changes after elimination attempts must be examined in the different environments. During the end of winter and early spring, the grassy layer of soil on river banks should be peeled off. This procedure not

only will eliminate some snails and change the environment of snail colonization but also will facilitate the investigation of snails. Methods of investigation should include coordination with the conditions of farm production, self-investigation, mutual investigation, fixed-partnership investigation, and investigation by the entire population.

A. Methods of Snail Investigation

1. A section of a river in a primitive state and heavily infested with snails may be selected for special investigation. If the river is heavily infested with snails, then it may be considered as totally infested. Then the area of snail infestation may be calculated by use of the step measurement or rope measurement method. These methods are also applicable to other heavily infested environments.

2. In treating an area considered unlikely to contain snail infestation or when deciding whether an area is infested with snails, it is necessary to make thorough investigations. If snails are found, then the area and environment of snail infestation must be immediately recorded.

3. In areas where snail infestation has not been found for 2 to 3 years, in the spring and autumn of each year investigation still should be carried out two or three times. This procedure will consolidate the results of snail elimination.

4. Methods for calculating snail-infested areas are: on rivers, ditches and pools, 1 m of bank length is considered as 1 m^2 . If it is found that snail distribution is less than 10 per m^2 (even if only one snail is found), then it still is considered as 10 m^2 . Over 10 m^2 and less than 20 m^2 is considered as 20 m^2 . Using each 10 m^2 as a basic calculating unit, other calculations can be derived. If snails are found in one section of a ricefield, then the whole field is considered snail-infested (each mou is equivalent to 666 m^2). In snail-infested swamps and grassy banks, the actual snail distribution is used to calculate the infested area.

Furthermore, "equal distance basket placement method of investigation" may be used to carry out scientific research or evaluate the results of snail elimination. If a basket is placed at each 10 m or 20 m distance, the size of the basket is 1 Chinese ft². If snails are found in the basket, then all snails in the basket and the number of snail-containing baskets should be counted to calculate the average density of living snails. The number of snails reflects the snail density. The calculation formula is:

$$\text{Average density of living snails (no./ft}^2\text{)} = \frac{\text{Total no. of snails caught}}{\text{No. of baskets investigated}}$$

$$\text{Percentage of baskets with snails} = \frac{\text{No. of baskets with snails} \times 100}{\text{No. of baskets investigated}}$$

B. Questions Regarding the Investigation of Snails

Spring and autumn are the best seasons for the investigation of snails. When rivers and ditches are examined, attention should be paid to the water level. When rice paddy fields are examined for snails, the inlet and outlet ditches should be investigated first, then the field ditches and edges of the fields, and finally the center of the fields. In areas where elimination procedures have repeatedly been carried out, emphasis should be centered on complex environments for investigation. At the common border of two areas, investigations should overlap to avoid leaving blank spots. Records of snail investigation at all stages should be filed and kept by designated personnel. An example is shown in Table 1.

III. Methods of Snail Elimination

Depending on the distribution of snails in different terrains, on the snail activities in different seasons, on the change of conditions of snail infestation, and on the activities of farm production, snail elimination should be carried out by different methods with definite plans and procedures.

A. Eliminating Snails in Rivers

Rivers are the main breeding places of snails in water network areas. They are also important sources of snail infestation in irrigation canals

Table 1.--Sample Record Chart of Snail Investigation (suitable for rivers, ditches, pools, fields, banks)

Commune _____ Brigade _____ Production team					
Name	Area originally	Date of	1	2	Area now
	infested (ft ²)	<u>investigation</u>	Area now infested	Date of	Area now
			(ft ²)	<u>investigation</u>	infested (ft ²)
		Yr Mo Day			Yr Mo Day
Total					

and rice paddies. Therefore, elimination of river snails is the key to snail elimination in water network areas. There are many methods of river snail elimination. In areas where the distribution of snails is wide and dense and when supplies of chemicals are ample, combined snail elimination methods may be used. If the supply of chemicals is inadequate, then a ditch at the base of the bank can be dug and buried with soil or with a soil strip. In areas with sparse distribution and low density, the method of immersion and killing along the bank may be used. Whether the density of snail distribution is high or low, coordinating the recontouring of the land with the filling in of rivers to eliminate the snail or coordinating construction of water irrigation with opening rivers to eliminate the snail are all good methods that coordinate productivity with snail elimination.

1. Combined Methods of Snail Elimination

These methods include management of complex environments, killing by chemicals, paring the soil, and immersion, all of which are effective. Efforts should be made to eliminate all the snails above and below water level and in the inner and outer layers of the soil with one treatment. The methods carried out are as follows:

Management of complex environments. First thoroughly clean out such complex environments as tree roots, brick and tile piles, and water wharves where snails may easily hide; depending on the distribution of electric irrigation plants, build dams and drain the water, or utilize small tides during low tide to build dams and stop the flow. The standard for lowering the water level should be about 1 m below the highest level of the year. If the river is small or shallow, the lowering may be determined by the local condition.

Spreading chemicals. Spread sodium pentachlorophenate within an area 2 feet above the highest water level, using 20 g/m, i.e., 4 catties (1 catty=500 g) per 100 m.

Paring soil. Pare the soil 3 to 5 inches deep. Pare the area spreading with chemicals first; then pare from the top of the bank downward. Finally, sweep all the loose soil into the water. After paring, spread the holes and cracks with chemicals and then seal with soil.

Remove the dam and let in water. After thorough snail elimination, wait at least 5 days before removing the dam and allowing water to reenter. Thorough examinations must be made before removing the dam; if snails are found the dam should not be removed before they are eliminated. This method is best carried out from April to September to fully utilize the chemical effects on snail elimination.

2. Snail Elimination by Ditchdigging at Bed of River Bank and Soil Burying

This method of snail elimination is also called bilateral ditchdigging and soil burying. Generally it can be coordinated with dredging of riverbed soil as fertilizer. The method is as follows:

a. Build a dam and drain the water to lower the water level or utilize the winter dry season to expose the noninfested area of the base of the bank.

b. Dig a ditch on each of the two sides of the base of the bank in noninfested areas. The noninfested soil is piled on the side of the ditch near the center of the riverbed. The width and depth of the ditch (generally 1½ feet wide and 2 feet deep) should be able to accommodate the snail-infested soil pared from the riverbank.

c. Pare the soil 3 inches deep. First pare the heavily infested soil near the water level, and dump it into the ditch. Then pare the soil from the top of the riverbank into the ditch. Clean up the loose soil, and cover the whole ditch with noninfested soil lying on the center side of the ditch. A 5-inch layer of soil is used which is then pounded and hardened.

3. Snail Elimination by Making a Soil Strip

This method, also called "snail elimination strip" or "pulling a ditch head," is: utilize small tides and low tides, or build a dam to lower the water level. First dig a ditch in the noninfested area of the base of the riverbank. The noninfested soil removed is piled on the side of the ditch near the center of the river. This soil is built into a small dam to prevent infested soil from dropping into the river stream. The depth of the ditch should be sufficient to accommodate the snail-infested soil pared from the riverbank. The snail-infested soil is dumped into the ditch first. Then the soil of the riverbank is pared off layer by layer, dumped over the ditch, and spread 2 to 3 feet towards the center of the river. Thus a stepping strip is created, which should be at least half a foot above the highest water level. When there is not enough soil, noninfested soil from other places may be brought over for use, and the strip, pounded and hardened. In ordinary times the grass should be frequently cleared and cracks should be prevented; and if there is any collapse, the strip should be repaired in time.

The methods of ditchdigging at the bed of the riverbank, soil burying, and making a soil strip may be carried out in coordination with farm productivity and are not limited by the season.

4. Snail Elimination by Opening Rivers

First drain the rivers dry, and pare the snail-infested soil for 3 inches. It is best to use this soil to fill in adjacent little streams and ditches, in soil burying. This method can be coordinated with water conservation.

5. Snail Elimination Through Recontouring Land

Pare the soil infested with snails to the base of the riverbank; then cover the whole river with noninfested soil; pound and flatten out the soil. This method not only eliminates the snail, but also increases the cultivating land and does away with useless snail-infested rivers.

6. Snail Elimination by Immersion and Killing Along the Edge

Generally this method is suitable for such wide surface areas as ponds and pools where it is difficult to build dams to block the flow or to lower the water level. Spread sodium pentachlorophenate (100 g for each 10 m of riverbank) in the area within 1 foot above the water level. Pare the snail-infested soil (3 inches deep) from the bank into the water; then pare the soil from the top of the bank downward. Sweep the loose soil clean. This procedure will soak the snail-infested soil under the water along the bank. The results are better during the hot summer season. Spraying is an effective method of snail elimination for small infested areas that are not suitable for soil paring.

B. Eliminating Snails in Irrigation Canals

The snails in irrigating canals come from snail-infested rivers. Irrigating canals in turn are pathways for the spreading of snails to the rice paddies. Elimination of snails in the irrigating canals will consolidate the results of snail elimination in the rice paddies. Therefore, elimination of irrigating canal snails is an important link in the elimination of snails in water network areas. A thorough method of eliminating irrigating canal snails is to open new canals and fill in old ones. Use of chemicals to eliminate snails is also an effective method.

1. Open New Canals and Fill in Old Canals

In carrying out this project, first clear off the grass on the bank, and pare off the soil infested with snails on both banks of snail-infested canals into the bed of the canal. Sweep and clean the area. Following the water conservation plan, dig new irrigating canals nearby, and use the dug-up noninfested soil to fill in the old canal. Pound and flatten the soil. The distance between the old canal and the new canal must be at least 1 m to prevent contamination of the new canal should rain and water cause a collapse of the new canal bank.

2. Sodium Pentachlorophenate to Eliminate Snails

Using sodium pentachlorophenate (20 g for each m²), the snails will be killed in 3 days.

C. Eliminating Snails in Rice Paddies

The snails in rice paddies come from irrigation canals; but after they reach the rice paddies, they can multiply and produce incessantly in the paddies. Therefore, rice paddy snails are the direct sources from which farm workers become infected with schistosomiasis. They also affect the results of irrigation canal snail elimination. Generally rice paddy snails are widely distributed but are grouped chiefly in low marshy areas. If efforts are concentrated during the proper season and elimination procedures are energetically carried out, it is not difficult to eliminate the snail.

In the elimination of rice paddy snails, use of the chemical immersion killing method is most effective. The method is as follows:

Paring field ditches. Pare off the soil on the surface and edges of field ditches, and spread this snail-infested soil on the middle of the field.

Fill field with water. Cover the field with about 3 inches of water. Examine the area surrounding the rice paddy field beforehand, and block off possible leaks to fulfill the requirement that the soil must be covered with water for 3 days after using chemicals. If the water has leaked off within 24 hours after using chemicals, then the area must be reflooded and chemicals added.

Use of chemicals. For each mou of rice paddy field, use 2 catty 7 ounces of sodium pentachlorophenate, or a mixture of 1-3/8 ounces of antischistosome-67 with 6-7/8 ounces of sodium pentachlorophenate. Spread one-third of the chemical on the water surface of the field ditches, and spread the rest evenly on the field. After using sodium pentachlorophenate,

one must wait 2 days before planting rice sprouts. With the use of the antischistosome-67 and sodium pentachlorophenate mixture, planting of rice sprouts can be carried out immediately.

Examine leaks, and repair defects. Reexamination must be carried out after snail elimination. If snails are found, they must be taken care of quickly.

D. Eliminating Snails in Fishponds

Fishponds are frequently infested with snails. How to prevent the death of the fish during snail elimination is a problem that should receive attention.

Use the method of ditchdigging at the base of banks and burying the soil or the method of covered soil strip to eliminate snails. Combined methods of snail elimination may also be used after catching all the fish or turning all the fish into another pond for feeding. One month must elapse before a few fish are returned for a trial period; but if dead fish are seen, the water must be changed. If a few snails are found during reexamination, "staged and sectioned spraying with sodium pentachlorophenate method" may be used as a supplement. Each time the sprayed area should not exceed one-fifth of the total area of the fishpond bank.

E. Eliminating Snails in Marshland and Grassy River Banks

Snail elimination in this kind of area should be coordinated with farm productivity.

1. Recontouring the Land

Small ditches and marshland may be filled in during recontouring of land. In the first 2 years, it is best to cultivate dry land crops so as not to provide a new breeding environment for the snail.

2. Digging Fishponds to Eliminate the Snail

Use lime to divide the grassy riverbanks into sections, the size of the sections depending on the intended size of the fishponds. Between each piece leave an empty space (usually about 5 to 10 m) to build an embankment. In building the embankment, first dig up about 1 foot of the superficial snail-infested grassy soil and dump this soil in the middle of the intended embankment. Then dig into the intended fishpond layer by layer, piling this soil on top and on both sides of the embankment, pounding and hardening the surface. In paring the superficial soil, a spade must be used to lift up the whole block of soil. In transporting this soil, care must be taken not to drop any snails. Both sides of the embankment should be covered with 1 to 2 m of deep layer soil and the top covered with 1 m of deep layer soil. These layers should be pounded and hardened.

F. Eliminating Snails in Complex Environments

Complex environments are the original residence of the snail. They are also the most difficult areas in the investigation and elimination of snails. Elimination methods include:

1. Brick and Tile Piles

When bricks and tiles are not too numerous along riverbanks, simply pick them clear and proceed with snail elimination. When there are too many, it is best to use chemical immersion elimination. If chemical sprays are used, they must be used while the bricks and tiles are turned over. Another method is to combine chemicals and use river soil to seal and eliminate the snail.

2. Tree Roots and Bamboo Garden Bases

Tree roots and bamboo garden bases that may hide snails should be cleared. Smooth and healthy trees growing on riverbanks near the water level should be preserved. If the roots grow wild, they should be trimmed. If they are really useless and hinder the elimination of snails, then they should be removed together with the root.

3. Water Wharves and Bridge Buttresses

When the water level has lowered, water wharves should be thoroughly turned over and repaired, snail-infested soil should be removed, and cracks sealed with soil. In water wharves supported with wooden supports or where paring of soil may affect the safety of bridge buttresses, elimination of snails may be carried out by sealing with soil, chemical immersion elimination, or chemical sprays.

4. Stone Extension Banks and Brick Extension Banks

The holes and cracks in stone extension banks and brick extension banks may be fixed by sealing with soil. In fixing extension banks, emphasis must first be placed on complete elimination of snails before sealing off cracks. This procedure will prevent the snail from hiding in the extension bank and continuing to breed and cause trouble. Snail elimination may be carried out by chemical immersion, chemical spreading, or spraying.

G. Eliminating Snails in Cities and Towns

In suburbs and towns the environment can be very complex. Along riverbanks, many connecting extension banks, water bridges, and houses are frequently built with wooden poles and stone buttresses. Generally the water level may be raised and chemical immersion elimination used. The method is:

1. First investigate the high level of snail distribution on the riverbank. If snails are found on the land along the bank, they must be eliminated before carrying out this method of snail elimination.

2. Build a dam during high tide; the top of the dam must be above the highest snail distribution line.

3. Within the sphere of 1 m below the highest snail distribution line, spray sodium pentachlorophenate (10 g/m^2), thus preventing the snail from swimming above water level after flooding.

4. Introduce water into the river above the dam, raising the water level to 10 cm above the highest snail distribution line.

5. Evenly spread sodium pentachlorophenate, 15 g/m^3 (15:1,000,000), on the water surface close to the bank. In long rivers several boats should spread the chemicals in different sections so that the chemicals are only spread once in a short period of time. The chemical-containing river water should be used to sprinkle the edge of the bank several times.

6. Generally this chemical immersion elimination should be carried out for at least 7 days before the dam is opened to drain the water.

H. Eliminating Snails in Reeded Areas

The breeding environment of snails in reeded areas is the same as that in areas without reeds; therefore the methods of snail elimination are the same. However, from September to May of the next year is the time to carry out snail elimination (especially before reed sprouts come out). During this period snail elimination is less harmful to the reeds. In utilizing the 10 edges of reeded river banks to cultivate crops, the requirement of "thorough snail elimination first before cultivating the 10 edges" must be fulfilled, so as to avoid injuring the crops of the 10 edges.

IV. Frequently Used Molluscicides

Snail elimination drugs presently in use include sodium pentachlorophenate, antischistosome-67, lime nitrogen, and such industrial wastes as calcium carbide and chromate compounds. In snail elimination by chemicals, the higher the temperature the better the results. An introduction to the characteristics of these chemicals follows:

A. Sodium Pentachlorophenate

Sodium pentachlorophenate is a light brown, water-soluble, flaky or powdery chemical. It is irritating to human skin and mucosa. Exposure

to sunlight will disintegrate the chemical and render it less effective. It is a contact germicide that can kill adult snails, juvenile snails, snail ova, and the schistosome ova, miracidia, and cercariae.

1. Dosage of Sodium Pentachlorophenate

The dosage varies depending on the temperature and the method used. In warmer weather, the chemical concentration should be lower; in cold weather, the chemical concentration should be higher. The results of snail elimination are better when the temperature is above 20°C. When the immersion killing method is utilized, use 10 to 20 g/m³ of water according to the volume of the river, canal, or pond. When using this method along the bank edge, calculate the amount according to the length, using 10 g of chemical for every meter of snail-infested riverbank. The dosage for the spraying method is calculated according to the area, using 10 to 15 g/m². Since this chemical is highly toxic to fish, it generally should not be used in fishponds.

2. Precautions in Sodium Pentachlorophenate Snail Elimination

a. In administering the chemical, stay upwind, keep all body areas covered. Use a wooden stick to mix the chemical, not the hand. Do not let the chemical wet clothing or contact the skin.

b. If the skin or mucosa come into contact with sodium pentachlorophenate, immediately wash it off with clear water. Properly distribute and store sodium pentachlorophenate.

c. In using sodium pentachlorophenate, if members of the snail elimination team or the commune come into contact with the chemical and show signs of lassitude, extreme thirst, copious sweating, and high temperature, they should immediately be sent to the hospital for examination and treatment.

3. Clinical Manifestations of Sodium Pentachlorophenate Poisoning

a. After chemical contamination, symptoms of skin and mucosa irritation may be seen; the skin is slightly painful locally and exhibits red macules. A few days later there will be local desquamation, and after healing there will be no pigmentation. Chemicals blown into the eyes will cause stinging pain, lacrimation, and conjunctivitis. Inhalation causes irritation of the nasal cavity, sneezing, and irritating cough. These symptoms are frequently mild and should not cause the patient concern; but if they can be attended to quickly, poisoning may be prevented.

b. The main symptoms of acute poisoning are lassitude and fever which are not serious. The incubation period is generally several hours, after which the condition may show sudden changes. The main symptoms are:

Lassitude. This is the earliest symptom. The patient suddenly feels weakness of the whole body; the lower extremities feel particularly heavy. Whereas the patient had been able to perform heavy work, now he cannot even carry out light daily work and may even be bedridden. When the condition progresses, lassitude becomes more and more severe.

Profuse sweating. The patient may experience copious sweating. Night sweating is especially prominent, and the clothing and bedding may be entirely soaked wet. Symptoms of restlessness and thirst may also occur.

Fever. The body temperature may read around 38°C . If there is high fever, it indicates the condition has become serious.

Gastrointestinal system symptoms. In the early stage there is nausea and vomiting. Most patients have anorexia.

Increased heart rate and respiration. In serious cases mentality may be unclear. Pupils may be dilated and unequal, and react sluggishly to light. If proper treatment is not given in time, the condition will

rapidly deteriorate. There may be pulmonary edema, anorexia, dehydration, or acidosis, finally ending with exhaustion and death.

4. Treatment for Sodium Pentachlorophenate Poisoning

Because sodium pentachlorophenate is rapidly metabolized and excreted from the body, the prognosis is good if the condition does not deteriorate in 24 hours. Therefore in the treatment one must be confident and start proper procedures immediately. Those suspicious of poisoning or with early symptoms of poisoning should immediately stop contact with the chemical to prevent further deterioration of the condition. Skin contaminants can be washed off with soap and water. Ingestion should be lavaged with 5% sodium bicarbonate. This treatment is aimed mainly at lowering fever, replacing fluids, and maintaining electrolyte balance, especially in giving sodium salts. Physical methods of lowering body temperature include wrapping the body with wet sheets and using fans and icepacks. Drugs to lower body temperature include chlorpromazine (20 to 50 mg in 500 ml glucose, 5%) given intravenously (finish drip in 2 hours). Adenosine triphosphate (ATP) may be given to supply calories. Hydrocortisone may be used in seriously ill patients. Oxygen inhalation may be given, if necessary, to maintain respiratory and circulatory functions. Other measures include correction of acidosis and symptomatic and supportive treatments. Barbiturates are synergistic with this chemical and atropine will stop sweating, thus preventing heat dispersal. All are strictly contraindicated. After the acute stage, attention should be paid to protect the liver and kidneys.

B. Antischistosome-67

Antischistosome-67, a new type of snail elimination chemical, has been successfully produced. It contains chloronitroamide (50%) and is a brown paste-like material.

1. Utilization

Snail elimination is ideally effective when the temperature is above 20°C. The method is the same as for sodium pentachlorophenate. For

the immersion killing method, use 2 g/m³ of water (use the paste form for weight calculation, the same as below), and for the spraying method use 2 g/m². The death rate of the snail is highest in 10 days.

2. Safety

This chemical has no special odor and is not irritating to the skin. Within the dosage of snail elimination, it is safe for humans and animals, does not injure the crops, and is harmless to rice sprouts.

3. Precautions in the Use of Antischistosome-67

a. In using antischistosome-67 for immersion killing, the phenomenon of snails crawling upwards out of the water has to be taken into account. In each m³ of water, combine antischistosome-67 with sodium pentachlorophenate (because of the shallow water in rice paddies, this method is especially suitable) in 1:5 proportion to prevent the snail from climbing upwards.

b. It is highly toxic to fish; therefore it should not be used in fishponds. The rice paddy water that has been treated with antischistosome-67 also should not be used in fishponds.

c. After storing for some time, antischistosome-67 may show some precipitation. Therefore when this chemical is used, it should be thoroughly mixed.

C. Lime Nitrogen

Lime nitrogen is also called calcium cyanamide. It is a black powder, has a calcium carbide odor, and is alkaline. It is a chemical fertilizer, frequently used as a basic fertilizer, and is also a chemical capable of killing snails and snail ova.

Lime nitrogen is often used in the immersion method to kill rice paddy snails. To each mou of snail-infested rice paddy field with 4 inches (10 cm) depth of water, use 25 catties of lime nitrogen mixed with water and

sprinkle evenly into the field. At the same time pare the surrounding ditches smoothly on three surfaces, and then dump the snail-infested soil into the chemically treated field. When the temperature is above 20°C, immersion for 3 days will provide good snail elimination effects.

1. Precautions in the Use of Lime Nitrogen

a. After using the chemical, wait at least 3 days before planting rice sprouts. It should not be used in fields already growing crops.

b. Lime nitrogen can also poison and kill fish.

c. Lime nitrogen should not be stored for long. It should be stored in dry, sealed places.

d. Lime nitrogen has certain toxicity against humans. When the operator is poisoned, there may be symptoms of dizziness, tinnitus, chest constriction, vomiting, etc. If the skin comes into contact with this chemical, there may be localized dermatitis and cracking of the skin. Therefore protection must be stressed during its use.

D. Industrial Wastes

Industrial wastes such as calcium carbide and chromate-containing compounds can be used in snail elimination. Use 1 kg/m² and mix with water, and sprinkle evenly over the area.

V. Some Problems of Snail Elimination in Areas With Water Networks

Snail elimination must involve the coordination of extermination efforts by the population and the specialized teams. Because the distribution of the snail is very broad and the environment complex, a specialized full-time and part-time team must be organized. Snail elimination also must be coordinated with farm production and water conservation. During the off-seasons, massive snail elimination may be started in coordination with

recontouring of the land, collection of fertilizers, and repairing of irrigation canals. During the busy seasons of farming, the specialized team can carry out repeated investigations and extermination. At the same time, snail elimination must maintain high standards, and preventive measures should be carried out to prevent outside snails being brought into the area and causing recontamination. Close cooperation must be maintained between Hsien, commune, and brigade, to eliminate "dead corners." In areas where elimination is completed, reexamination should be carried out for several years.

THE PROPER TREATMENT OF MANURE

Proper treatment of manure is an important link in the elimination of schistosomiasis. Its purpose is to kill the schistosome ova and prevent manure from contaminating water sources. Proper treatment of manure can also kill and eliminate hookworm ova and prevent intestinal infectious diseases. It is also beneficial in farm production and in improving sanitation environments. At present three methods for the proper treatment of manure are: safe cesspools, compost, and chemicals to kill and eliminate ova.

I. Safe Cesspools

Safe cesspools are also called fermentation ova-sinking style cesspools. The three-pool and two-septa style pools are presently in use. This style utilizes the fact the specific gravity of ova (schistosome ova 1.20, hookworm ova 1.06, ascaris ova 1.14) is greater than that of the mixed manure and urine solution (1.02) and that ammonia is produced by fermentation when manure and urine are sealed tightly. Under a certain dilution of manure and urine and a rather stagnant condition, the ova sink down and are killed by the ammonia produced by fermentation.

A. Capacity of Cesspools

The first pool must have at least a 10-day manure-producing capacity (if it is a "double first pool," each section must have a minimal 5-day capacity). The second pool should have a 2-day manure-producing capacity; and the third pool, a 20-day manure-producing capacity. In areas where the use of fertilizer is more concentrated, the third pool may be made bigger. The following formula is used to calculate the capacity of the cesspool: the daily average manure-producing capacity per person (including manure, urine, and water to clean the nightstool) of 2 kg times the number of persons times the number of days, divided by 1,000, will be the capacity of the pool (volume).

$$\frac{2 \text{ kg} \times \text{no. persons}}{1,000} \times \text{no. of days} = \text{cesspool capacity (m}^3\text{)}$$

Example: A certain production team has 150 members; construction of a safe cesspool is needed. The capacity for the first pool should be:

$$\frac{2 \text{ kg} \times 150}{1,000} \times 10 \text{ days} = 3 \text{ m}^3$$

The second pool should be 1/5 of the first, or 0.6 m³; the third pool should be twice that of the first, or 6 m³.

An oblong shape is better for a cesspool, and it should not be too wide. This makes it easier to cover.

B. Style Of Cesspool

Three-pool and two-septa style. The function of this type of cesspool is "first retain, second sink, third safe." "First retain": the first pool will retain the manure sediment which contains most of the ova and make the manure sediment ferment and the ova sink downward; "second sink": the manure in the second pool is more diluted and moves slowly, and the ova continue to sink down; "third safe": the manure in the third pool has very few or no ova. Ideally the depth of the pool should be about 1.6 m, the width and length to be determined by the existing conditions. To facilitate construction, the distance of the septum between the first and second pools should not be less than 0.5 m. The hole should be made 40 cm upwards from the bottom of the pool (about one-fourth the depth of pool), and it should be 20 cm high and 30 cm wide. It is best to open several holes at the same level. The hole in the septum wall between the second and third pools may be created by omitting two pieces of bricks (about 10 cm) from the top, making this the pathway to the third pool. This pathway is only a short distance from the top, giving the third pool more capacity to store manure. Required material may be found in Table 2.

Double first-pool style. This type of cesspool divides the first and second pools of the three-pool, two-septa style into two parts and uses them alternately (Fig. 8). First use one part, fill with manure for about

Table 2.--Material Needed for Fermentation Ova-Sinking
Style Safe Cesspool (For Reference)

Used by no. of people	Capacity (M ³)			Construction of pool	Required Material					
	1st pool	2nd pool	3rd pool		8-5 brick (pc.)	Cement (bag)	Sand (ton)	Broken brick (M ³)	Steel rod (kg)	Tile tube (pc.)
Less than 100	2	tile tube	4	Brick	1,700	16	2.4	3.3	18	2
				Mixed cement	--	16	2.4	5.3	18	2
100-150	3	tile tube	6	Brick	2,200	20	3.0	4.9	26	2
				Mixed cement	--	20	3.0	7.4	26	2
150-200	4	tile tube	8	Brick	2,700	25	3.8	6.0	33	2
				Mixed cement	--	25	3.8	9.3	33	2
200-250	5	tile tube	10	Brick	3,200	30	4.5	7.5	41	2
				Mixed cement	--	30	4.5	11.3	41	2

Note: (1) The proportion of sand paste mixture needed to construct and paint the brick pool wall is 1:3 (cement:sand); the proportion for the construction of the pool top, pool bottom, and pool wall without brick is 1:3:5 (cement:sand:broken bricks).

(2) The length of the tile tube is 1 m; the internal diameter, 23-30 cm. If the length is insufficient, tiles and cement can be fixed at the opening of the tube.

(3) The diameter of the steel rod is 6 mm. Expenses may be lowered if bamboo tubes, useless iron sheets, or heavy copper wire are used as substitutes. Picking broken bricks for use costs nothing.

(4) Two kinds of cesspool construction are: "Brick construction"--the pool wall is built with bricks; "mixed cement construction"--the pool wall is built with cement mixture. There is no difference in the construction of the pool top and pool bottom since cement mixture is used for both. Construction expenses are lower in "mixed cement construction," but the construction process is more difficult.

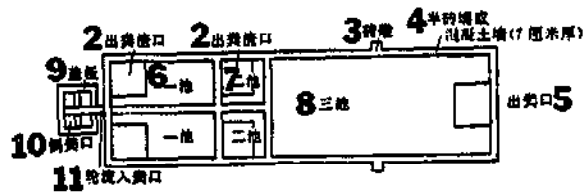

1 平面图

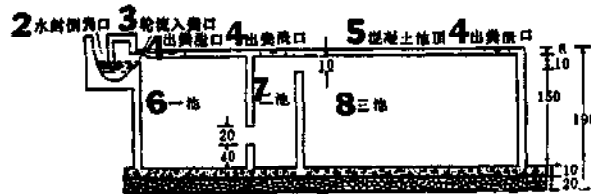

1 剖面图(二隔三池式)

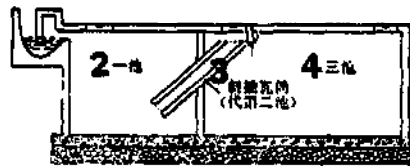

1

Figure 8. Fermentation ova-sinking style cesspool (double first pool style) (unit: cm).

- | | |
|--|--|
| 1. Plane figure | 2. Opening to remove manure sediment |
| 3. Brick stand | 4. Half brick wall or mixed cement wall (7 cm thick) |
| 5. Opening to release manure | 6. 1st pool |
| 7. 2nd pool | 8. 3rd pool |
| 9. Covering board | 10. Opening to pour in manure |
| 11. Alternate opening to pour in manure | |
| 1. Cross section (2-septum 3-pool style) | 2. Water-sealed opening to pour in manure |
| 3. Opening to alternate pouring in manure | 4. Opening to remove manure sediment |
| 5. Mixed cement pool top | 6. 1st pool |
| 7. 2nd pool | 8. 3rd pool |
| 1. Cross section (obliquely inserted tile tube style) | 2. 1st pool |
| 3. Obliquely inserted tile tube (take place of 2nd pool) | 4. 3rd pool |

2 months, then use the other part for the next 2 months. Thus alternating on fixed dates will give each part sealed storage of manure sediments for at least 2 months, not only killing schistosome ova but also hookworm ova. This style will eliminate the need for chemical treatment of the manure sediment.

Insert tile tube (barrel) style. In the second pool of the two-septa, three-pool style, use an obliquely inserted tile tube instead. The angle of the tube and the septum wall should be greater than 45° . This procedure not only can omit the process of cleaning the second pool, but also can save part of the construction material. If the manure is poured into the first pool stool by stool, even if the second pool has a capacity of less than 2 days' manure, it will still allow the ova to sink. If a large amount of manure is poured into the pool at one time, or if the pool is used by many people, then it is better to construct a two-septa, three-pool style cesspool. A latrine may be constructed on top of a safe cesspool (Fig. 9).

Others. When material is not available, in sparsely populated areas, accessible crocks may be utilized. According to the principle of "first retain, second sink, third safe," use three crocks to construct the ova-sinking style manure crocks (Fig. 10). The more crocks that are connected, the better the ova-sinking effect. The manure sediment in the first crock must be removed frequently, separately sealed to allow fermentation and ova killing, or treated with chemicals.

In towns where the population is quite dense, large, safe cesspools may also be constructed. Concentrate or separate the areas to manage the manure of public latrines and private stools (Fig. 11). Boatmen and fishermen must pour the manure into cesspools when coming to land. In rivers where comparatively more boats travel, there should be manure crocks, cesspools, or safe latrines on the banks especially for the boatmen to wash their stools and in which to pour their manure and urine. Special boats to periodically collect manure may also be organized. However, all these require the attention of designated personnel.

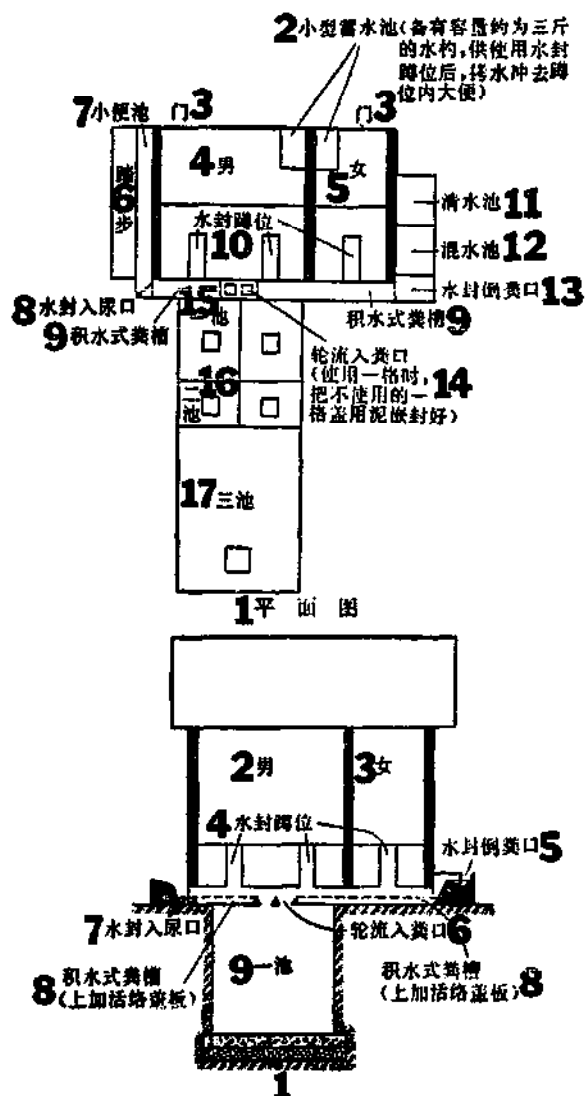
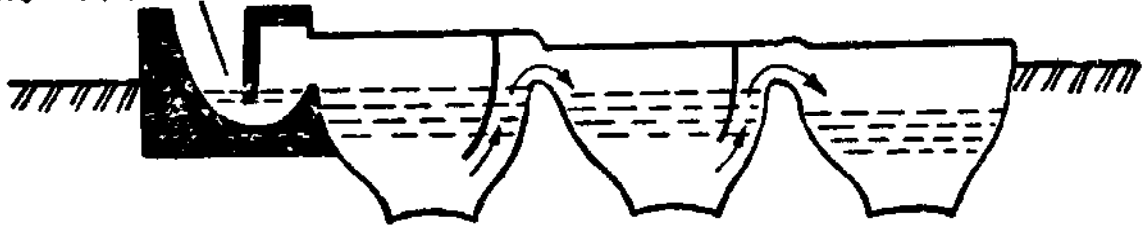

Figure 9. Diagram of safe cesspool and latrine.

1. Plane figure. 2. Small size water reservoir (with a three catty volume dipper, used to wash away manure after using water-sealed squatting seat). 3. Door. 4. Men. 5. Women. 6. Step. 7. Urinal. 8. Water-sealed urine entrance. 9. Water-sealed manure groove. 10. Water-sealed squatting seat. 11. Clear water pool. 12. Turbid water pool. 13. Water-sealed opening to pour manure. 14. Alternate opening for manure entrance (when one part is in use, seal the other unused part with mud). 15. 1st pool. 16. 2nd pool. 17. 3rd pool.

1. Cross section. 2. Men. 3. Women. 4. Water-sealed squatting seats. 5. Water-sealed opening to pour manure. 6. Alternate opening for manure entrance. 7. Water-sealed urine entrance. 8. Water-filled manure groove (with movable covered board). 9. Cesspool.

2 水封倒粪口



1 剖面图

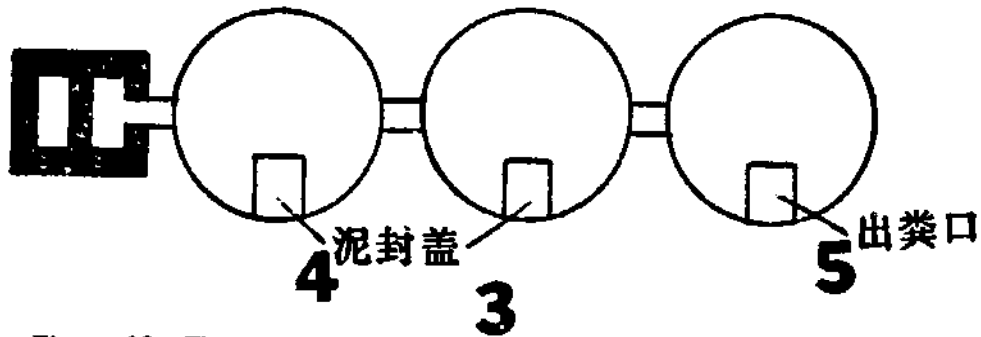

Figure 10. Three-crock five-section safe manure stored crock.

1. Cross section. 2. Water-sealed opening to pour manure. 3. Plane figure. 4. Mud-sealed cover. 5. Opening to remove manure.

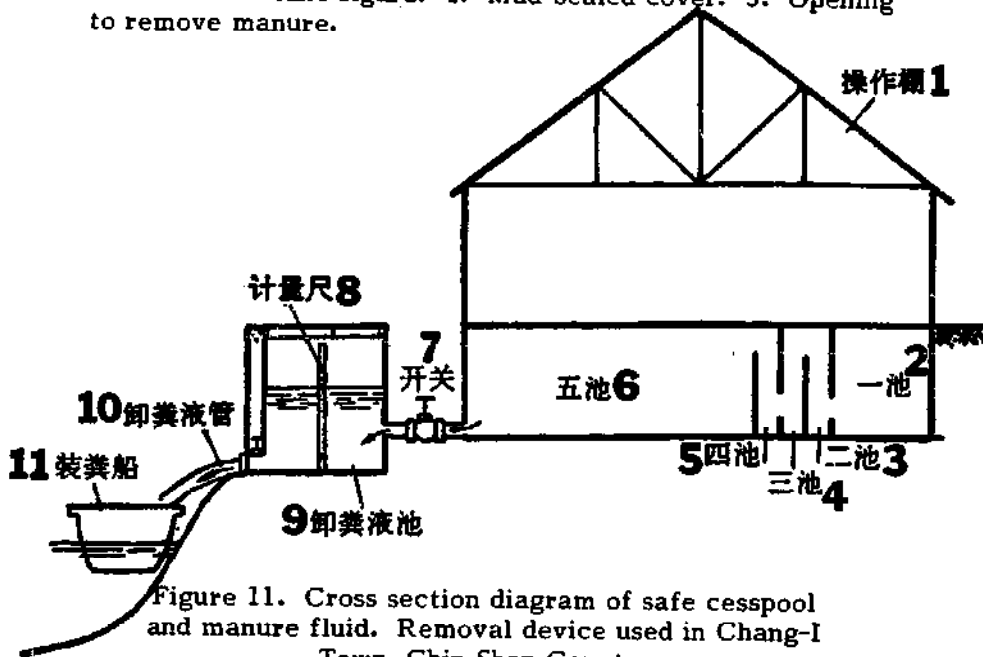

Figure 11. Cross section diagram of safe cesspool and manure fluid. Removal device used in Chang-I Town, Chin Shan County.

1. Work shed. 2. 1st pool. 3. 2nd pool. 4. 3rd pool. 5. 4th pool. 6. 5th pool. 7. Valve. 8. Calculating ruler. 9. Manure fluid removal pool. 10. Manure fluid removal tube. 11. Manure collecting boat.

Utilizing the water-sealed principle, a water-sealed opening for pouring in manure is constructed. It can prevent flies and foul odor and evaporation of ammonia, thus preserving the quality of the fertilizer. Using the same principle, a water-sealed opening for incoming urine and a water-sealed opening under the squatting seat may also be constructed (Fig. 12). After each defecation, use water (about 3 cattles) to wash the manure down. Then the manure will follow the water into the trough leading to the safe cesspool.

C. Advantages of Cesspools

A safe cesspool, if it is constructed according to standard and properly managed, not only will kill insect ova, improve environmental sanitation, and prevent growth of flies, but also will increase the quantity of fertilizer collected and improve the quality of fertilizers. The cesspool construction is solid and firm and may be used for a long time.

Ova elimination effect. The manure sediment in the first pool, after alternate periodic use according to regulation, will kill schistosome and hookworm ova. After passing through the fermentation and ova-sinking processes in the first and second pools, the ova in the manure fluid in the third pool will be decreased over 95%.

Fertilizer effectiveness. After the manure has been through fermentation, the organic matter is mostly decomposed. The ammonia nitrogen is maintained above 0.2% (in the open-air cesspool and in the manure crock, it is below 0.1%), representing an increase of fertilizer effectiveness. After practical use, the people evaluated the third pool by saying: "Looking at it one sees clear water, using it turns it to ammonia water." This kind of manure fluid is suitable for secondary fertilizing. The manure sediment after ova elimination by sealing is a good primary fertilizer.

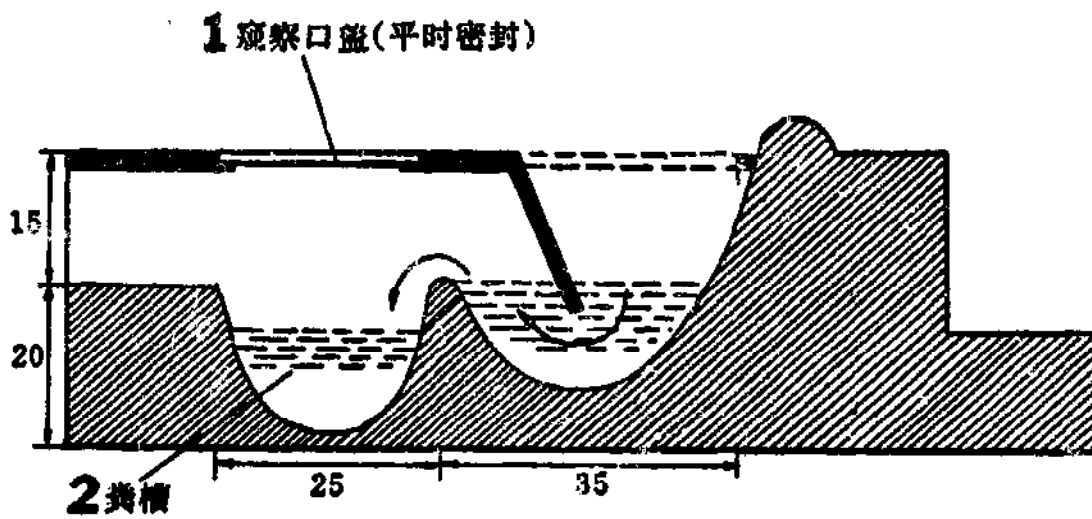

Figure 12. Diagram of water-sealed opening under squatting seat used in Chang Chin Commune, Ka-tine County (unit: cm).

1. Cover over observation opening (ordinarily sealed)
2. Manure groove

II. Compost

Mix human and animal manure, weedy grass, garbage, and used wine sediment into a pile, utilizing the heat (50°C to 70°C) produced by bacterial decomposition and fermentation to kill schistosome ova, hookworm ova, ascaris ova, pathogenic bacteria, fly pupae, and maggots. The time needed for compost is about 1 month in summer and 2 to 3 months in winter. The two common methods used are anaerobic and aerobic composts.

A. Anaerobic Compost

Thoroughly mix human and animal manure, weedy grass, and grain stalks of plants; pile them up; and seal tightly with wet mud. Well-piled composts will produce a temperature of around 65°C after 1 week. Anaerobic compost generally does not produce high temperature and does not fulfill the requirement-of ova elimination.

B. Aerobic Compost

Use garbage, weedy grass, and other material with human and animal manure at a 7:3 proportion. Thoroughly mix them (it is best to add some horse or swine manure which is likely to produce heat), and pile up. The bacteria that cause decomposition of organic matter are aerobic. Three principal methods of aeration generally are used.

1. Half-Pit Compost

Choose a site that is comparatively high and against the wind, avoiding direct sunlight in summer. Dig a pit about 1 m deep, with a large top and small bottom like a basin. The diameter of the base is 2 m. The muddy soil dug up is piled around the opening to a height of 70 cm. On the bottom and wall of the pit, dig a crossed groove with a width and depth of 20 cm. On the two opposing ends of the groove, dig two slanting grooves on the wall upwards from the bottom, reaching to the outside of the mud mound, 6 to 10 cm above the level of the land, thus preventing water and rain from entering. In making the pile, first tie the stalks of corn or sorghum or slender twigs into a fence shape and lay them over the crossed groove

of the base and slanting grooves of the wall to maintain communication of the crossed groove. Then pile in the compost layer by layer, until the pile protrudes out of the opening. Shape it into the form of a bun, and finally seal it on top with a 10 cm thickness of mud. This method of composting has a small exposed surface and can easily maintain its water and temperature; thus facilitating complete decomposition. The temperature can reach 70°C and be maintained for 5 to 6 days (Fig. 13).

2. "✱"Shape Aeration Compost

The principle is the same as described above. While piling up the compost, use heavy bamboo sticks to form "✱" shape. After sealing with mud, pull out the bamboo, leaving an aeration system.

3. "+" Shape Aeration Compost

On a circular base of about a 2 m diameter, dig a groove for water; in the middle dig a "+" shape mud groove, both grooves having a depth and width about 15 cm. In piling the compost, use corn stalks or small twigs to cross over the "+" shape groove; in the middle of the "+" groove, erect a heavy bamboo tube. After completing the compost, pull out the bamboo tube to allow aeration.

In making good composts, attention, particularly in the early stage, should be given to the proportion of the materials, water composition, and aeration. After making the compost, the temperature and moisture must be recorded daily. If the temperature increases daily, then there is no problem. Using a thermometer, take readings at several places on the pile. If a thermometer is not available, a wooden rod may be stuck into the pile; after 1 day remove it and observe the end of the rod. If the rod is damp and hot to the hand, the condition is normal. If it is dry and hot, then water or dilute human manure should be added to maintain a certain degree of dampness, which is necessary for bacteria colonization. At the same time the covering mud should not be too thin so that cold air cannot enter.

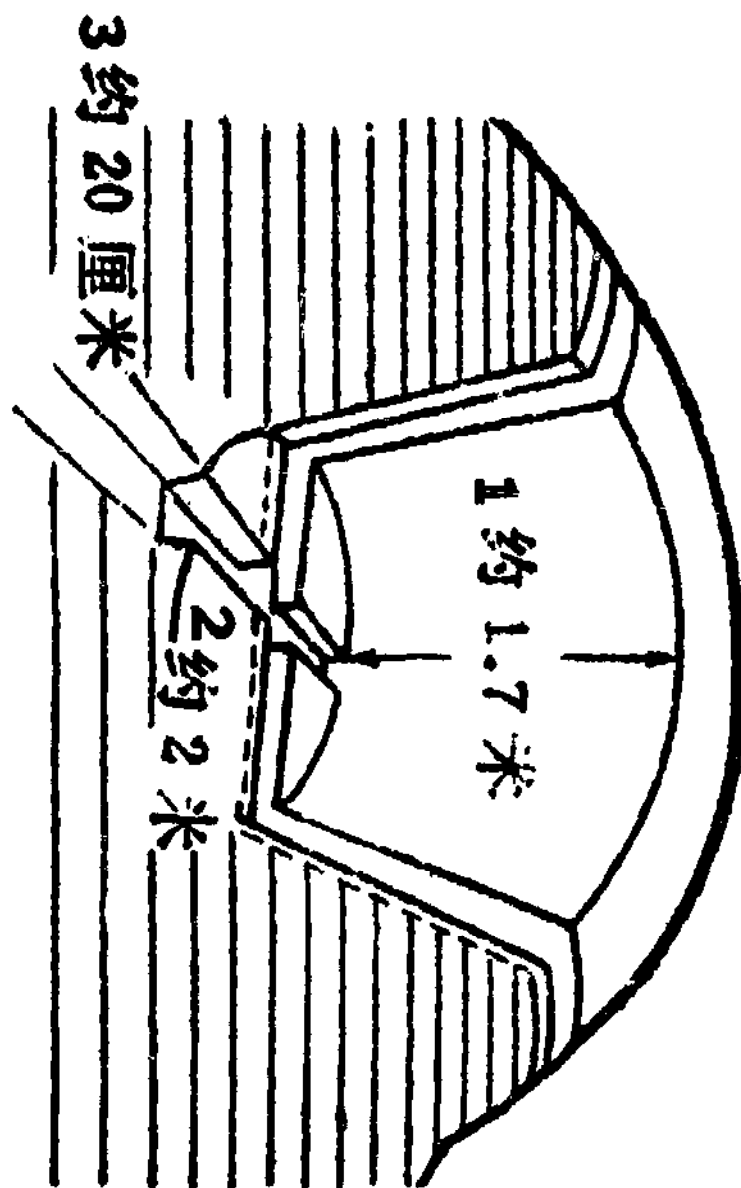

Figure 13. Cross section of half pit compost

1. About 1.7 m. 2. About 2 m. 3. About 20 cm.

III. Chemical Treatment

If a large quantity of manure is needed for fertilizer quickly, chemicals may be used in manure crocks or cesspools for fast action ova elimination. The chosen chemicals should not lower the fertilizer effectiveness. They should be inexpensive and harmless to the crops. Common chemicals in use are:

A. Dipterex (3911) (Phosphorus Compound)

According to the weight of the manure, add 3911 to make a proportion of 1:100,000--to 10,000 catties of manure fluid add 2 oz of 3911 (50%)--and stir thoroughly. With the temperature above 20°C, all schistosome ova will be killed within 24 hours. When the temperature is below 20°C, the time must be prolonged from 48 to 72 hours to be effective. To effectively kill hookworm ova, add 6 oz of 3911 (50%) to 100 catties of manure fluid. Due to the difference of concentration of 3911, when in use the actual effective concentration must be calculated.

B. Ammonia Water

Ammonia water containing 20% ammonia is a common fertilizer used in rice paddies. To each load (about 100 catties) of manure fluid, add 1 catty of ammonia water. With the temperature above 20°C, schistosome ova will be killed in 24 hours; with the temperature below 20°C, the time is prolonged to 2 days.

C. Lime Nitrogen

Lime nitrogen (calcium cyanamide) is a nitrogen-containing fertilizer. To each load of manure fluid add 2½ to 3 oz of this chemical. After stirring, this mixture can kill schistosome ova and hookworm rod-like larvae in the soil in 24 hours. If used as a fertilizer, it should be diluted with equal amounts of water. However, even at that concentration it may be harmful to the seeds or sprouts of cabbage and colza.

D. Wettable 666 (6%)

To each load of manure fluid, add 3 oz of wettable 666 powder (6%). After stirring the mixture, use as fertilizer immediately. It can kill over 90% of hookworm rod-like larvae in the soil. On the farms, during the highly infectious seasons for hookworm, this method of fertilization has significant advantages in the prevention of hookworm disease.

IV. Methods of Proper Treatment of Manure

Utilize the principle of "self-reliance and simplicity." Work in accordance with the environment, using local material and basic methods. In constructing safe cesspools, besides using bricks and cement, one can also use broken bricks, sand, and cement (commonly called "three-mixed soil"). Use door board or brick pieces as model plates; pour mixed cement over to make the pool walls. Before constructing the cesspool, choose the site according to the basic distribution of the houses of the production team. It must be on high land, far from wells, on a downward slant, but convenient for the inhabitants to go to the latrine and to empty their stools. Before construction, the size of the cesspool should be calculated according to the population. The style should be designed; material, ready; and experienced personnel, organized. Choose a comparatively good day for construction, and try to avoid rainy, cloudy days or freezing weather that may affect the setting of mixed cement. The quality must be guaranteed to prevent collapse or leakage. If water is found seeping from the pool bottom during digging, then a diverting well must be dug beside the pool and water drained day and night until the mixed cement poured into the bottom is already hardened.

Treatment of manure directly concerns the welfare of the group and the individual. Study and establish a reasonable system for all to follow. It should be strictly carried out and periodically examined, and experiences subsequently summarized, so that the work of manure treatment will be consolidated and improved.

In the work of a sanitation member, no matter the weather, the stool cleaning cannot be stopped for 1 day. A sanitation member frequently must maintain cleanliness of cesspools and latrines and periodically use chemicals to kill flies and maggots. Furthermore, attention must be paid to the maintainance and repair of cesspools and latrines.

V. Manure Treatment Regulations of the Feng-wei Commune, Chin Shan County, Shanghai Municipality

A. General

Elimination of schistosomiasis safeguards the health of the people. It is a widespread and difficult task. Leaders in all ranks must put anti-schistosomiasis work on the agenda and strengthen their role. Proper manure treatment to render manure safe is an important task in eliminating schistosomiasis and other diseases and improving the health level of the people. We must see that the leaders take this task seriously and that responsible personnel are designated.

B. Ideological Work

Leaders from the two ranks of the brigade and production teams must understand the significance of manure treatment and carry out plans and inspections so that the work of manure treatment will be constantly consolidated and improved. Educate commune members to become concerned with manure treatment, and every family should support this work. Call monthly meetings for sanitation members. Inspect and judge the work of manure treatment seasonally, exchange mutual experiences, and judge and select the outstanding sanitation members. Cadres should lead and be examples in carrying out manure treatment. Forbid pouring manure bought outside into the pool. Forbid use of manure in the first and second pools to guarantee that the manure is safe.

C. Sanitation Members

Select enthusiastic, conscientious, hard-working people who are from the poor and peasant classes to be sanitation members. Their appointments

should be discussed and approved by their peers. On principle, sanitation members are not changed at convenience. Their duties are to:

1. Be responsible in the management of manure. Distribute manure to commune members by tickets. The number of loads of manure used by the collective group should be recorded and reported to the accountant. Sanitation members using manure for their own lots should be recorded by the accountant; no tickets are needed.
2. Be responsible in pouring and cleaning stools. Clean the latrines once or twice daily; maintain cleanliness and sanitation.
3. Be responsible that manure is not used in the first and second pools; guarantee the fermentation, ova killing, and sedimentation of manure.
4. Be responsible in using chemicals in the cesspools and latrines to kill maggots.

D. Manure Management

The standard for issuing manure is calculated by the estimated crop production. An area of 100 catties of rice is entitled to 250 catties of manure (including stool-washing water).

The collective group uses 60% of the manure. Each load costs 0.50 yuan, is considered an investment by members, and recorded. Commune members use 40% and pay by tickets that are issued monthly. Tickets issued to commune members are good only for that month, and excess tickets are returned to the production team. Each load of manure is valued at 0.50 yuan and is considered an investment by that member. In treating the manure crocks of commune members, the crocks are evaluated by quality, priced, and turned over to the production team, and considered an investment by the member. In the first month of using safe cesspools, the 40% manure allotment to commune members is withheld and no tickets are issued. It is considered an investment.

SAFE WATER USE AND PERSONAL PROTECTION

Safe water use and personal protection are important measures in the prevention of infections of humans and animals by the schistosome cercaria. Safe water use and personal protection are concerned with the change of habit of the population in production and daily life. Therefore education must be conscientiously carried out to let people understand the important significance of safe water use and personal protection in the elimination of schistosomiasis and the safeguarding of health.

I. Safe Water Use

A. Digging Wells

Well water is filtered through layers of soil and its quality is comparatively good. Drinking well water can prevent the spread of infection by schistosome cercariae and intestinal tract diseases.

1. Selection of Well Site

Wells should be built at sites convenient for the people and conform to sanitary hygiene. Well sites should be on high land at some distance from rivers and creeks, paddy fields, and retained lands. No latrines, manure crocks, animal barns, or garbage piles should be nearby to avoid affecting the water quality. Wells should not be built in low marshland, in garbage banks, or land formerly used to dry salt. In areas where there are many rivers and pools, water sources are rich and are suitable for wells. On farms, a simple method to seek water sources is: in the evening use a few bowls or porcelain plates; cover them over at several places on the ground. Next morning turn them over for inspection. If there are water drops, it means that there is water underground; the more the number of water drops, the more the underground water. This condition is caused

by evaporated water seeping through soil layers and rising to the ground surface, forming a mist, and condensing into water drops under the low temperature of morning and evening.

2. Requirements for the Construction of Different Wells

Cement tile barrel well. First use stones, sand, and cement to make the well barrel over fixed molds; then dig the well and put these barrels in segment by segment to build the cement tile barrel well. Two kinds of cement tile barrels are waterproof and nonwaterproof. Therefore the proportion of construction materials is also different. The three upper sections are waterproof and are joined in a bugle fashion. The upper opening has an inner diameter of 51 cm; the lower opening has an inner diameter of 100 cm. The proportion of cement, sand, and stone is 1:3:5 (i.e., one part cement, three parts sand, five parts stones). From the fourth section downward, all sections are not waterproof; their inner diameter is 100 cm throughout. The proportion of materials is 1:1:5. Quantities of materials needed for well cover, well rim, and well baseboard may be found in Table 3 (Fig. 14, Fig. 15).

Pour the proportionally mixed material into the mold (smear a layer of lubricating oil before pouring so that it will come out easily); hammer it firm while pouring. Just before filling up, use a layer of cement and sand (one part cement, three parts sand) about 3 cm thick to cover the top, and make it smooth. After about 8 hours it can be taken out. Remove the inner layer first and then the outer (in bad weather the setting time should be lengthened). After it is removed, use wet grass bags to cover it. Then sprinkle water on it four to five times per day for 7 days. After 15 days, it is ready for use.

Instruments utilized in well digging are: one short-handled spade; one wooden or iron gourd; one piece long rope to haul mud; one bucket or other container to haul mud; one piece of thick rope, 6 in long; one long pole for carrying; three pieces of bamboo to make a triangular frame; and water-draining instruments. The procedure for digging a cement tile barrel well is detailed in Figure 16.

Table 3.--Material For Each Well Cover, Well Rim, and Well Baseboard¹

Name	Material Needed				Price (yuan)
	Cement (catty)	Sand (catty)	Stones ² (catty)	Steel rods ³ (catty)	
Well cover	6	12	8 (size of watermelon seeds)	1.2	1.00
Well railing	15	45	50 (2,4,6)	1.0	3.50
Well baseboard ⁴	25	80	70 (2,4,6)	3-4	3.50

¹For size of well cover, well rim, and well baseboard, refer to Figure 14. For well railing, wellcover styles, refer to Figure 15.

²Trade specifications of stones are given in parentheses.

³Discarded iron sheets, heavy wire, or bamboo tubes may be used instead of steel rods.

⁴Each well baseboard is made of two half circles.

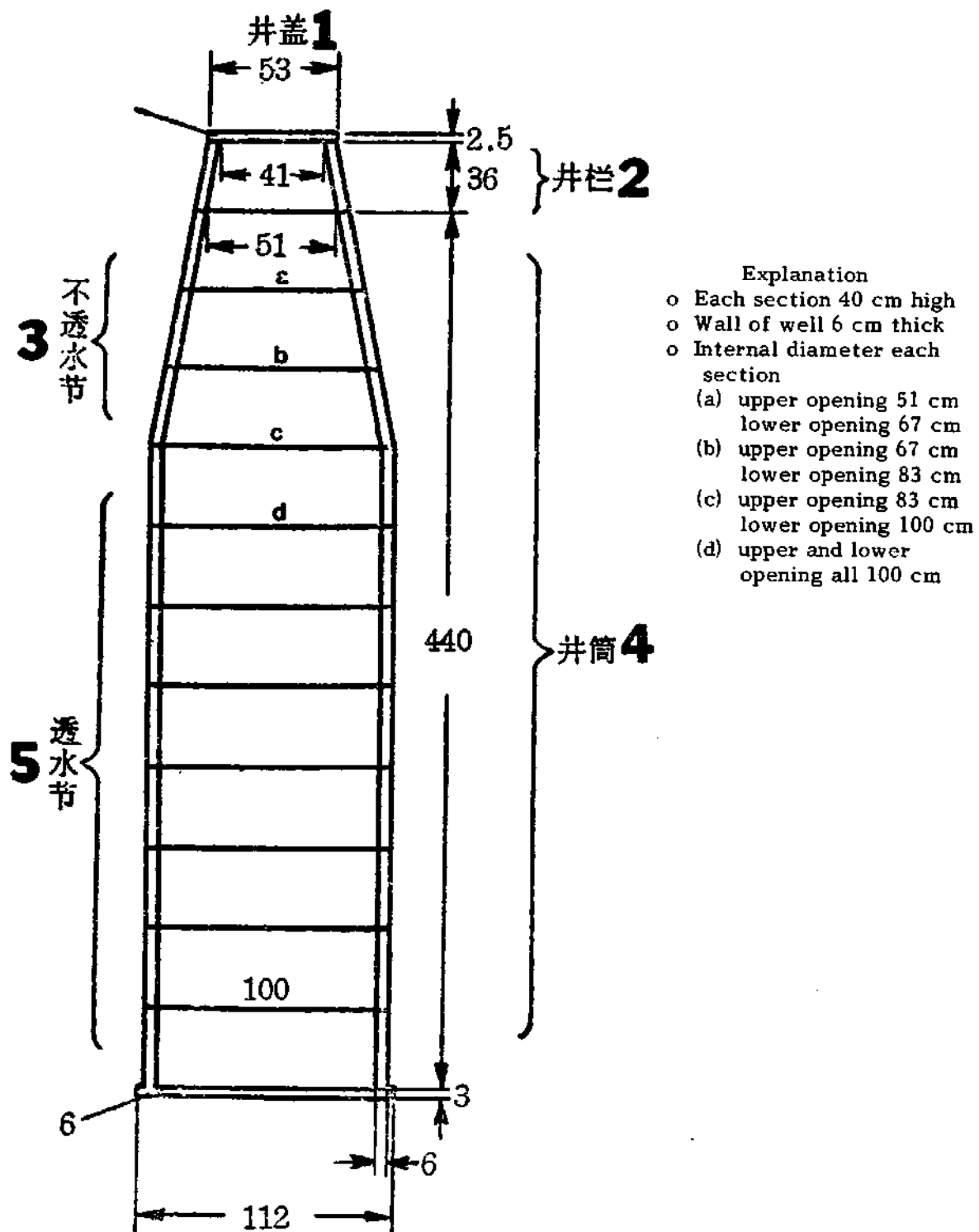

Figure 14. Simple drawing of cement tile barrel well.

1. Well cover. 2. Well railing. 3. Waterproof section.
4. Well barrel. 5. Water penetrable section.

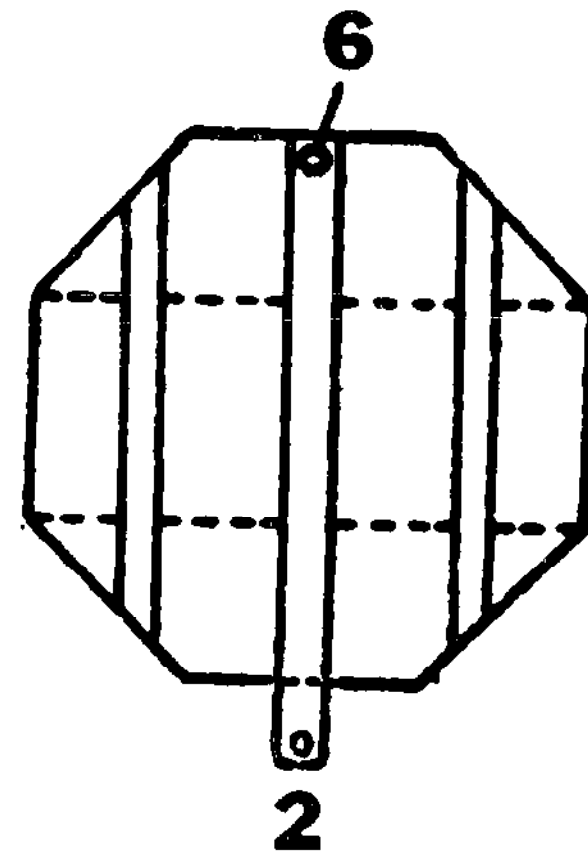
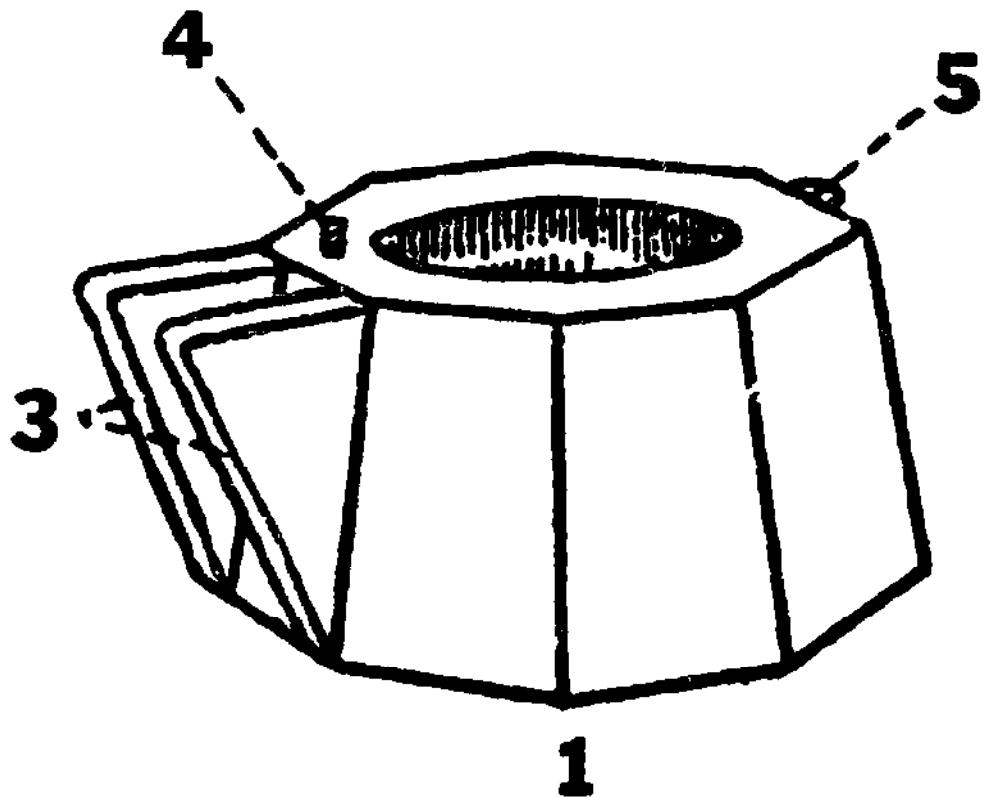

Figure 15. Diagram of well railing and well cover.

1. Well railing.
2. Well cover.
3. Cement crane for cover.
4. Previously imbedded iron rod.
5. Latch.
6. Prepared opening

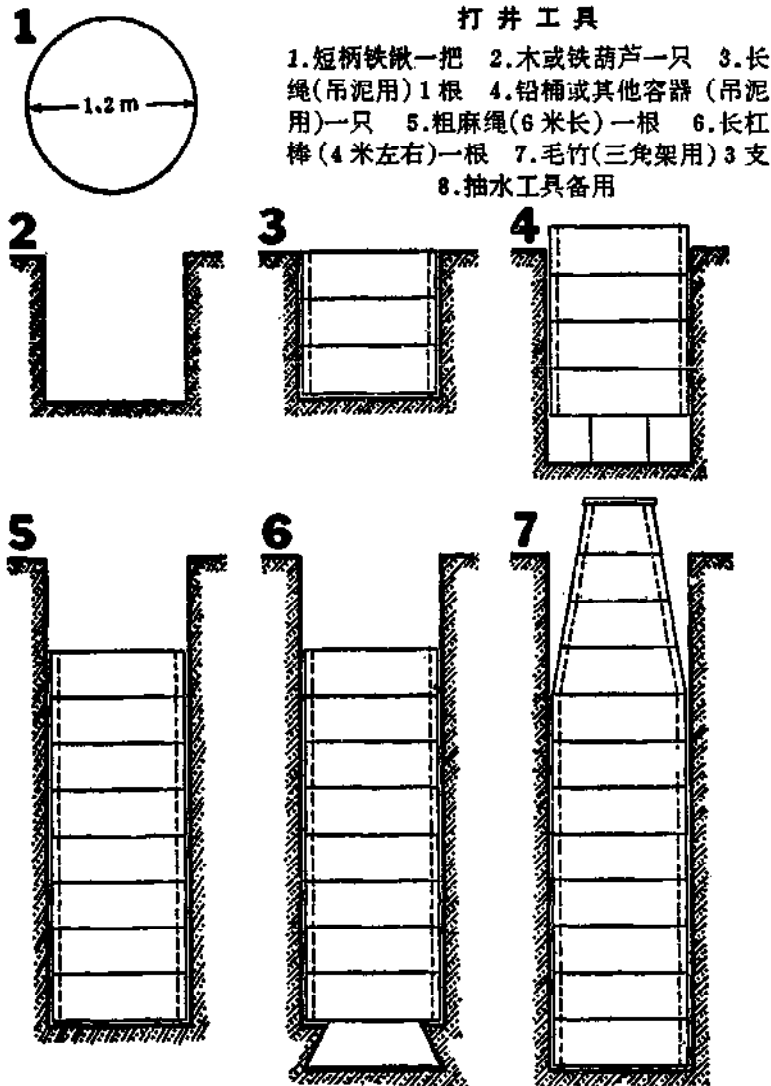

Figure 16. Diagram for procedure of digging cement tile barrel well.

- (1) On the site chosen, draw a circle 1.2 m in diameter;
- (2) Follow the drawn line and dig perpendicularly downward;
- (3) In the dug-out mud pool, lower three sections of nonwaterproof barrels;
- (4) One person should enter the well and dig out the earth from the center to the periphery. When the mud under the last section of the well wall is dug out, the barrel automatically sinks down. When the upper section sinks to slightly above ground level, put on another section;
- (5) After all the nonwaterproof sections have been lowered, digging must continue to allow the barrel to sink in for another two sections;
- (6) Prepare to place the well base. Dig a mud pool at the bottom of the well with a small upper opening and a large lower base, so as to place two half-circle well baseboards. Now dig out the mud below the barrel, so that the barrel will sink down and rest on the baseboard;
- (7) Finally put in the three waterproof sections and the well rim. After the filled-in mud has become hard, the well stand can be constructed.

Brick well. Ordinary bricks are usually used, but in some places wells are made with specially made well bricks (Fig. 17, Fig. 18). The size of the opening of a well must depend on the degree of soil looseness. When the soil is compact, the diameter of the opening may be smaller (6 to 9 ft); when the soil is loose, it may be bigger (9 to 10.5 ft). Digging every 3 ft, the digging may extend inward for 6 in; continue digging almost to the moving sand layer (e.g., in the Shanghai area it is usually 12 ft below ground level). When the mud and sand mixture cannot be dug up clearly or if water is seeping up, then the well baseboard should immediately be lowered and placed evenly and firmly. The well wall should be made round and smooth, using mud to fill in all around while it is being built. On the upper part of the well wall (4½ to 6 ft), it is best to use cement or lime and sand mixture to seal the cracks or smooth the wall. This procedure prevents dirty water from leaking in, thus making the water quality even better. After the well wall is completed, put the premade cement well railing over the well opening; wait until after several heavy rainfalls have hardened the surrounding loose soil; then build the well stand (first cover with 5 in of cement mixture; hammer it tight; then use cement to smooth over it). Connections between the well wall, well stand, and well railing must be sealed tight to avoid dirty water from seeping in.

Simplified cement tile barrel well. This method of construction basically is the same as that of the cement tile barrel well, but this type is made by digging a groove in the ground (Fig. 19). It is simple and easy to make, and the cost is cheap. The method is: (a) Select flat clear ground with firm soil (Fig. 20); (b) If a 90-cm-diameter well is planned, first draw a 90-cm-diameter circle on the ground; (c) Draw another circle 7 cm out from the first circle; (d) Dig up the soil between the two circles, making a groove that is 7 cm wide and 30 cm deep. This groove forms the bed for the tile barrel (also the model mold). After that each ring should be made smaller, each with an upper opening 5 cm smaller than the lower opening; (e) Make the number of barrels that are required; (f) Finally a chimney-shaped well is made.

The materials for this primitive cement mixture well are cement, sand, and broken bricks (slightly larger than broad beans). Add water to

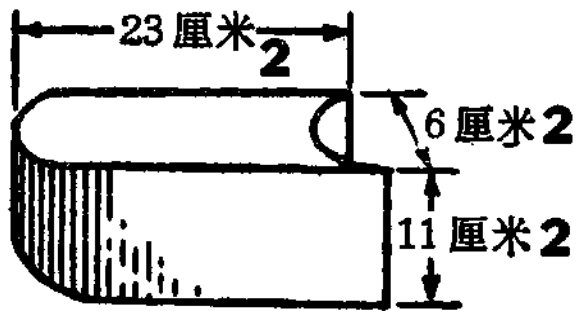

1 川沙县式井砖

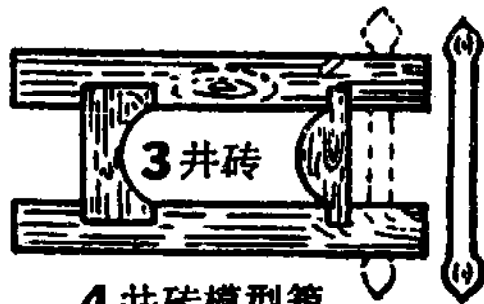

4 井砖模型箱

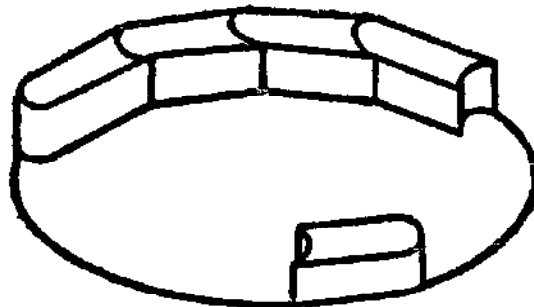

Figure 17. Diagram of connection of Ch'uan-Sha County model well bricks.

1. Ch'uan-sha County model well brick. 2. Cm.
3. Well brick. 4. Model box to make well brick

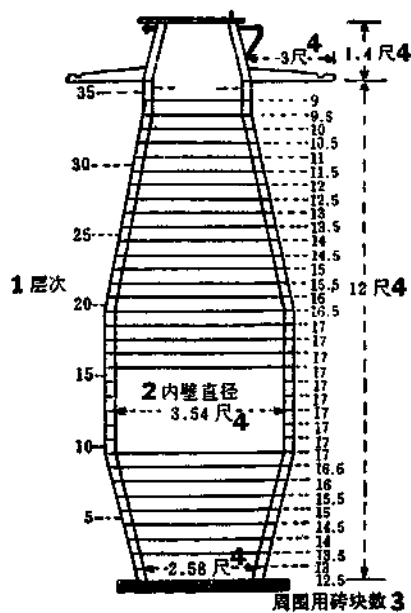

Figure 18. Layers of well built with well bricks.

1. Layer. 2. Diameter of inner wall. 3. No. of bricks used around. 4. Ft.

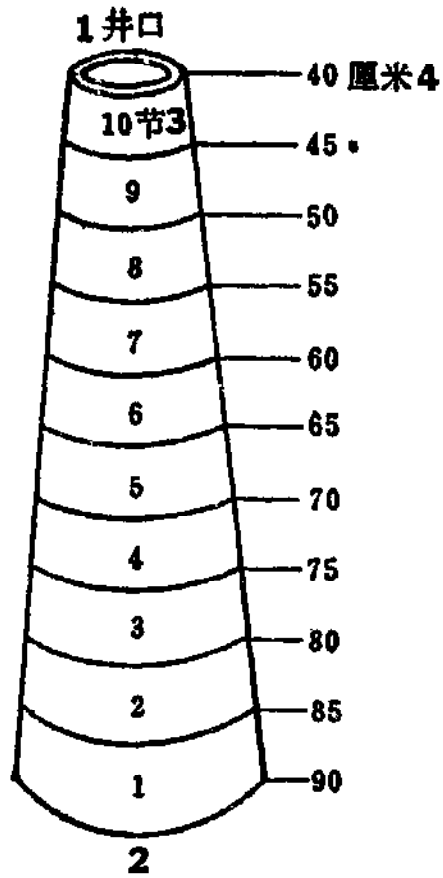

Figure 19. Setting of the tile barrels for a primitive cement well.

1. Well opening. 2. Well base. 3. Section. 4. Cm.

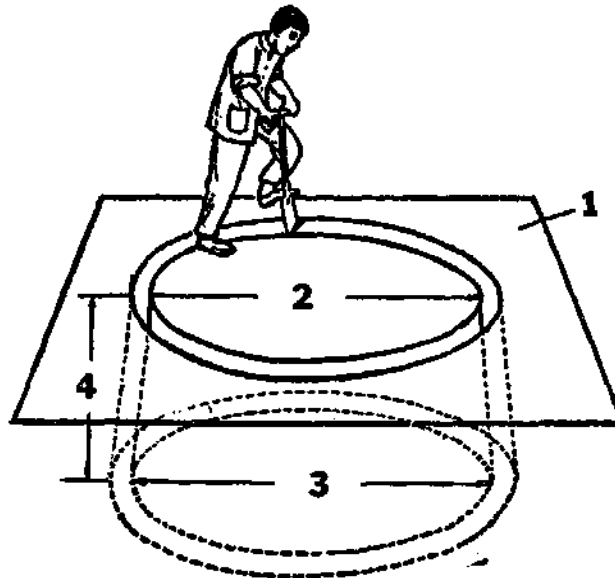

Figure 20. Diagram of digging soil to prepare the model bed of tile barrels.

1. Ground surface. 2. 80 cm. 3. 90 cm. 4. 30-50 cm.

these materials in 1:2:6 proportion, and mix well before pouring into the round bed. Wait about 10 days, and dig away the soil in the circle; then the tile barrel can be removed for use. The tile barrel for the lowest layer can be set on the ground at the planned well site. A person can squat inside of the barrel to work (but the inner diameter should not be less than 90 cm; otherwise it will be difficult to dig the soil), which is safer. The cement baseboard should be made into two or three sections, and some steel rods or bamboo tubes should be added. The base here should be set in the same way as the one in a tile barrel well.

Mud well. In areas without bricks or cement, mud wells can be constructed (Fig. 21). This method is: (a) First prepare three kinds of instruments: a long-blade spade connected with a 9- to 12-ft bamboo for digging soil, a mud dipper knitted with weedy rope, and a water bucket (Fig. 22); (b) In digging the soil, first use a 9-in rope as the radius, and draw a circle on the selected well site. Then dig the soil, removing the soil with the dipper. The mud along the well wall must be pared off to maintain a smooth surface. When much water collects, use the bucket to remove it, and then continue to dig; (c) The whole well should be dug into "drum shape." The diameter of the well opening should be 2 ft; the widest mid-portion, 3 ft; and the base of the well, 2.5 ft. This structure will not easily collapse; (d) The soil generally can be divided into three layers: yellow soil; greyish-brown soil; and green-purplish soil. This soil is comparatively firm. If white, powdery soil or sandy soil are encountered during digging, it means this soil is loose and will easily collapse, so another site should be chosen or another type of well constructed; (e) The usual well depth of about 9 ft will allow a water depth of 4.5 to 6 ft; but due to the differences of water level at different areas, the depth of the well should be determined by the actual conditions of the soil; (f) Stones are not used to cover the well base to facilitate cleaning; (g) A broken-bottom crock may be used to make the well railing; an old pan may be used as a well cover; (h) The water bucket should be hung on a bamboo stick about 10 ft long. Do not use rope, which may allow the bucket to knock against and damage the well wall. Specifications and material costs of several types of wells may be found in Table 4.

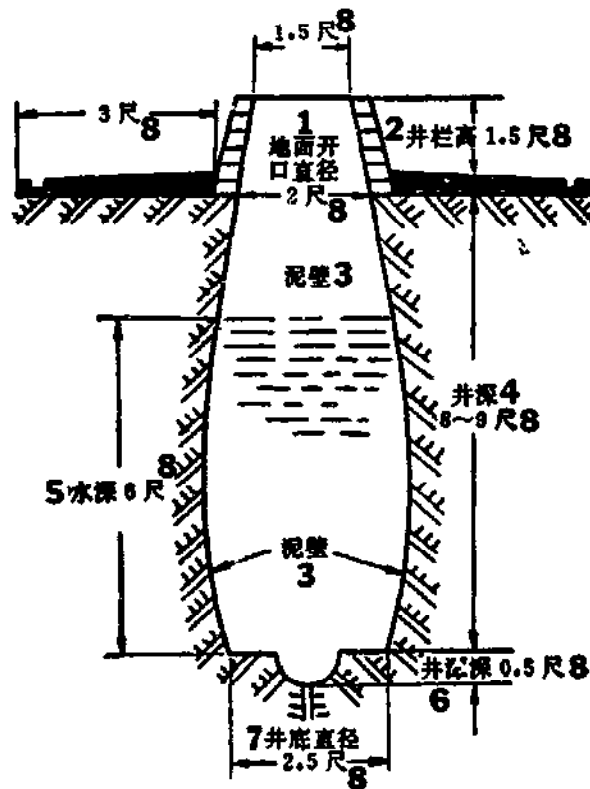

Figure 21. Cross section of mud well.

1. Well opening diameter at ground level.
2. Height of well railing.
3. Mud wall.
4. Depth of well.
5. Depth of water.
6. Depth of base pool.
7. Well base diameter
8. Ft.

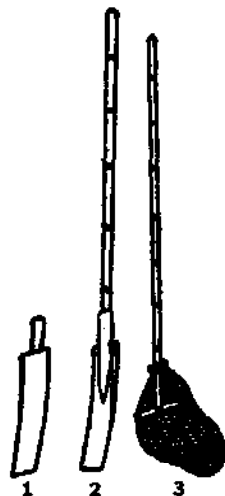

Figure 22. Instruments for digging mud well.

1. Dorsal view.
2. Frontal view.
3. Dipper.

3. Management of Wells

After construction of a well, first use well water to wash the well wall (except in a mud well); then drain the well dry. Wait until the well is refilled, and then add 2 g of bleaching powder to each load of water for sterilization. Wait 1 day before using the water. If salty water is found, drain the well dry several times. After the soil is filtered several times, the salty contents will decrease, and the salty taste will be diluted.

Wells must be properly dug, kept, and used. Fully mobilize the population, discuss the matter, and set up sanitation regulations. See that stools and dirty things are not washed around wells. A community water bucket should be used (it will be better if bamboo or iron sheet pumps can be installed). Assign designated personnel to manage and clean the well and to carry out routine well sterilization.

After sterilization for one-half hour, the water should contain a certain chlorine excess. Maintaining this chlorine excess will keep the bactericidal effect. If the chlorine excess is too high or not sufficient, the dosage of chemicals should be changed.

A common procedure for chlorine excess measurement is the methyl toluidine method. Collect 5 ml of sterilized water in a test tube, add 5 to 6 drops of methyl toluidine, and shake. A yellow color will appear. Compare this with standard tubes to determine the amount of chlorine excess. Methyl toluidine solution should be kept in colored bottles and should not be used if it has turned yellow or turbid.

B. Separate Pools for Water Use

Select convenient pools with no snails and with good quality water and clean environment for drinking, washing rice, and washing vegetables. Other pools may be used for washing clothes and animal drinking.

C. Drawing Water From Midstream

Use bamboo tubes or lead sheet to make water drawing pumps (Fig. 23). Draw water from midstream of a deep river for drinking because there usually are no cercariae in this water.

II. Personal Protection

A. Avoid Contact with Infected Water

In rivers, canals, and banks that are frequently passed because of production and daily livelihood and are possibly snail-infested, precautions should be taken. Roads should be repaired, communication embankments built, temporary bridges put up, and ditches dug to drain places that easily collect water. Unnecessary wading should be avoided. Fishermen, boatmen, and others must change their tools or methods, using tools instead of people for work in the water. Such methods as using long bamboos to collect river green fertilizer, net fishing, blockade fishing, or seduction fishing could take the place of man going into the water to catch fish and crabs.

B. Prevent Penetration of the Cercariae

In areas where snail density is comparatively high and entering the water will easily result in infection by the schistosome cercariae, precautions should be taken. If water must be entered because of production and livelihood, the following two preventive measures may be adopted.

1. Use of Preventive Tools

Clothing such as tung oil cloth shoes, long rubber boots, and plastic preventive trousers are effective. Dissolve antischistosome-67 (2 g in 100 ml of water), soak the clothes and trousers, sun dry, and wear. The protective effect may last for about 2 weeks.

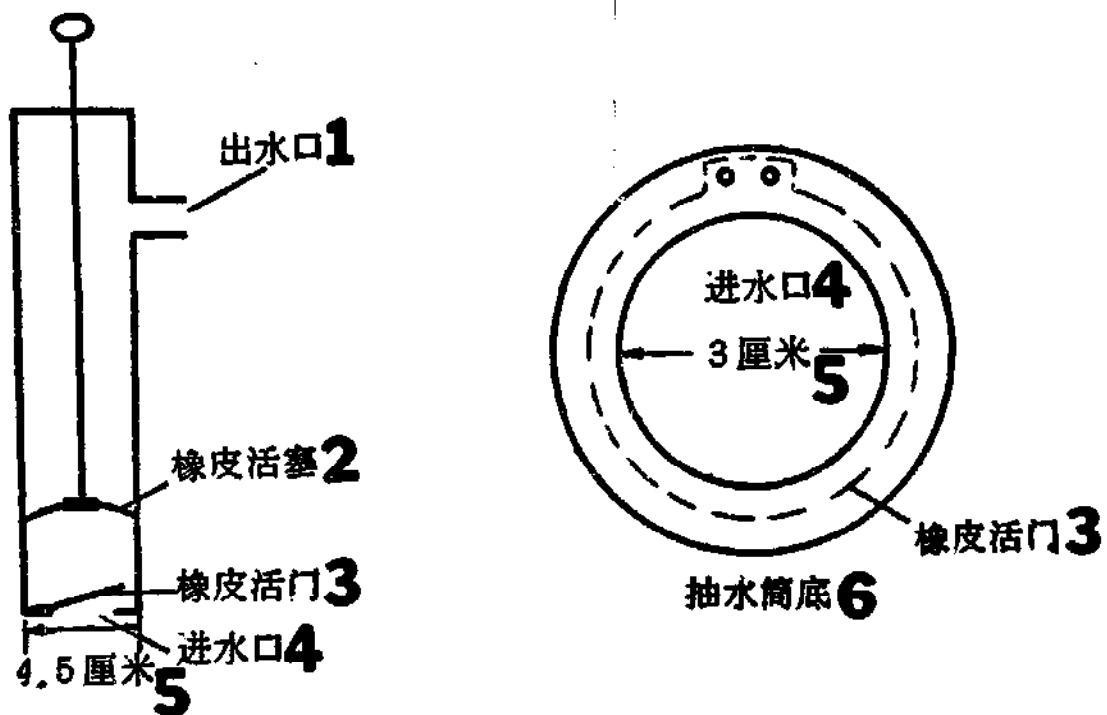

Figure 23. Diagram of water-drawing pumps.

1. Outlet for water. 2. Rubber piston. 3. Rubber valve. 4. Inlet for water. 5. Cm. 6. Base of water-drawing pump.

2. Smear and Rub Protective Chemicals

Smear and rub 15% linimentum dibutylis phthalatis. To prepare, use 1 ml of 25% sodium alkyl sulfonate (i.e., the ingredient of synthetic washing soap, or use 10% soap water as substitute), and dissolve in 84 ml of water. Then stir while slowly adding 15 ml of linimentum dibutylis phthalatis. After thorough mixing, the milk-like protective solution will be ready for use. All skin that comes in contact with infected water should be treated by smearing the chemical. The protective effect will be maintained for 4 hours. If immersion time exceeds the effective time, then the application must be repeated. If the milky suspension is an old preparation and shows sedimentation, it should be shaken well before use.

METHODS OF DIAGNOSIS

Thorough investigation of the sick patient is the prerequisite of treatment for schistosomiasis. Methods of diagnosis may be divided into: examination for the pathogen (stool proctoscope and sigmoidoscope examinations) and serum immunological diagnosis (oval ring test, etc.). At present on the farms, stool examination is the main method used. However, the diagnostic value of stool examination is poor in early mild infections, in patients with chronic cases but no longer in the area, and in newly infected cases. Limitations of the examination methods and the effect of hypertrophy of the mucosa of the patient may make diagnosis difficult. In these patients, clinical and rectal biopsy examinations and serum immunological tests should be used to help in the diagnosis.

I. Stool Examination (Sedimentation Hatching Method)

A. Preparations

To carry out the general survey of stool examination properly requires that the cadres, the poor, the peasant class, and laboratory personnel take part in intensive study. Every person should understand the important significance of examination for the disease for the elimination of schistosomiasis. At the same time each production team and brigade must designate a doctor or sanitation member to collect and send stool specimens. Detailed instructions should be given about the purpose and significance of stool collection and specific methods used to carry them out. Educate the people in preserving the stool specimen and collecting it in a proper container. It should not be scooped out of the stool or manure crock to avoid an inaccurate examination.

Using the production team as a unit, keep accurate laboratory registration charts. Distribute two copies--one to a sanitation member to collect stool specimens, and one to keep at the laboratory to register results. Three copies of a specimen chart should also be distributed. Waterproof blue ballpoint pens

may be used for copying. Carefully check for mistakes. It is best to establish one to two laboratories in each commune, so that instruments can be used collectively. Choose a location accessible to water sources, so that washing water is available. Each laboratory must be adequately equipped.

B. Procedure

1. Reception

Before accepting a specimen for examination, check the following five points: production team, number, name, whether quantity of stool is sufficient, and whether specimen chart is complete. If the stool quantity is less than 20 g (size of a Ping-Pong ball) or the stool is badly contaminated, it should be rejected and another specimen collected.

2. Opening Package

Carefully unwrap the package, and avoid keeping any paper pieces. Use a stick to transfer the stool onto a copper wire sieve or cloth, and paste the specimen chart on the measuring cup.

3. Form Paste

Use a paste-mixing stick to evenly stir all of the specimen on the copper wire sieve or cloth. A measuring cup filled with water or a teapot with water may be used to form the paste. In using the latter method, the amount of water added and the speed of the hand-stirring motion may vary according to the stool hardness.

4. Change of Water

After mixing paste in the measuring cup, remove the copper wire sieve or cloth and let stand for 30 minutes. Pour off the supernatant stool water and preserve the sediment (retain about 5 cm of the mixture at the bottom of the cup). Add clear water again, and continue to allow sedimentation. Subsequently, change water every 20 minutes until the supernatant becomes

clear. Generally about three changes are required. In pouring out the supernatant fluid, avoid interrupting the flow to prevent loss of the sediment.

5. Microscopic Examination

Use a long pipette to suck up the sediment in the bottom of the cup. Make a droplet smear on a covered slide, and examine under a microscope (50-100X). Usually make two smears, each having an area no smaller than two-thirds of the slide. They should not be too thick or too thin. Thoroughly examine the slide, and record the presence of schistosome or other parasite ova. If a batch shows positive specimens microscopically, the same batch should demonstrate positive hatchings.

6. Hatching

Pour the entire sediment of the measuring cup into a 250 ml Erlenmeyer flask, and add clear water to about 0.5 to 1 cm from the mouth of the flask. Fill to this height exactly. Put the flask into a 20°C to 30°C room for hatching. Observe the results two or three times. The time interval for observation depends on the room temperature. If the temperature is 30°C, the first observation should be made at 4 hours; the second, at 8 hours; and the third, at 12 hours. If the room temperature is 25°C, then observe every 6 hours. Generally when cercariae are seen in the positive hatching stage, the specimen under examination should be inspected. Findings of cercariae should be confirmed by two persons. In winter the observation should be carried out in the hatching room to avoid affecting the activities of the cercariae by low temperatures, thus missing the cercariae.

7. Washing

All instruments should be thoroughly cleaned to prevent contamination. Glassware should be washed three times and rinsed. The copper wire sieve (cloth) and mixing sticks should be separated from the glassware, brushed, and boiled to kill all ova. Washing water must be changed frequently. Glass slides should be boiled with alkali to remove the oil and then wiped dry, and pipettes must be sterilized.

8. Registration of Material

A designated person must keep stool examination results and see that they are registered in time, and progress noted in each unit. These people and their leaders must be notified of the names of those showing positive tests so that treatment can be begun in time.

C. Morphology of Schistosome Ova and Cercariae

A mature ovum is oval in shape, 74 to 106 by 55 to 80 microns in size, with a light yellow color. The oval shell is very thin and has a double wall. Although there is a small spicule on the upper part of the oval shell, frequently it is not easily seen because it may be obscured by dead tissue and dirty matter. Cercariae can be seen within the shell of the mature ova. Generally speaking, the ova are easily recognizable. Though immature or mutated ova are comparatively hard to recognize, they are a very small proportion of the stool. Further examination will reveal mature ova (Figs. 24 to 26).

Generally the cercaria is oblong, semitransparent, and greyish white and can be seen by the naked eye. The hatched cercariae usually gather around the flask neck, utilizing their cilia to actively swim in a slanting straight line. They seldom change their course if no obstruction is encountered. They are uniform in size; but when they degenerate, they become slightly elongated and frequently move in circles when they are approaching death. The nearer death they are, the slower their movements become, until they sink straight down to the flask bottom. Only a few rise again to the flask neck, and at this time it is very easy to mistake them for water bugs, so special attention must be paid. The time of survival of the cercariae after hatching depends on the temperature at hatching. Death occurs soon in a room with a high temperature. Generally, in temperatures suitable for hatching, most of the hatched cercariae can survive for over 24 hours. Under sunlight or neon light with a dark background, the cercariae can be seen easily. If necessary, use a magnifying glass, or a small mouth pipette may be used to suck out the fluid and drop on a slide for microscopic examination to distinguish the cercariae from water bugs.

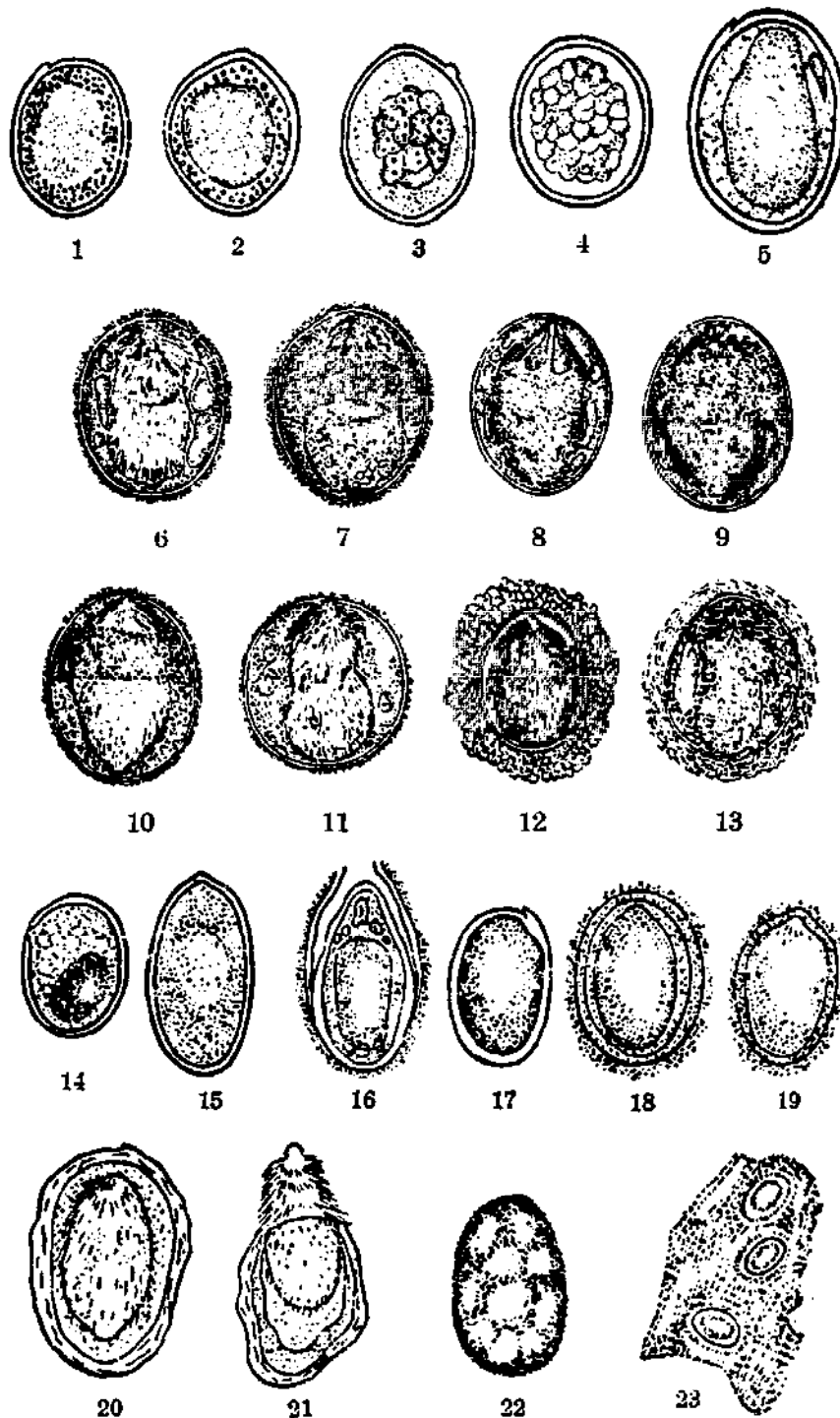

Figure 24. Morphology of schistosome ova.

1-5. Immature. 6-13. Mature. 14-19. Immature mutated. 20. Mature mutated. 21. Dead cercaria. 22. Entirely calcified. 23. Ova in intestinal mucosa.

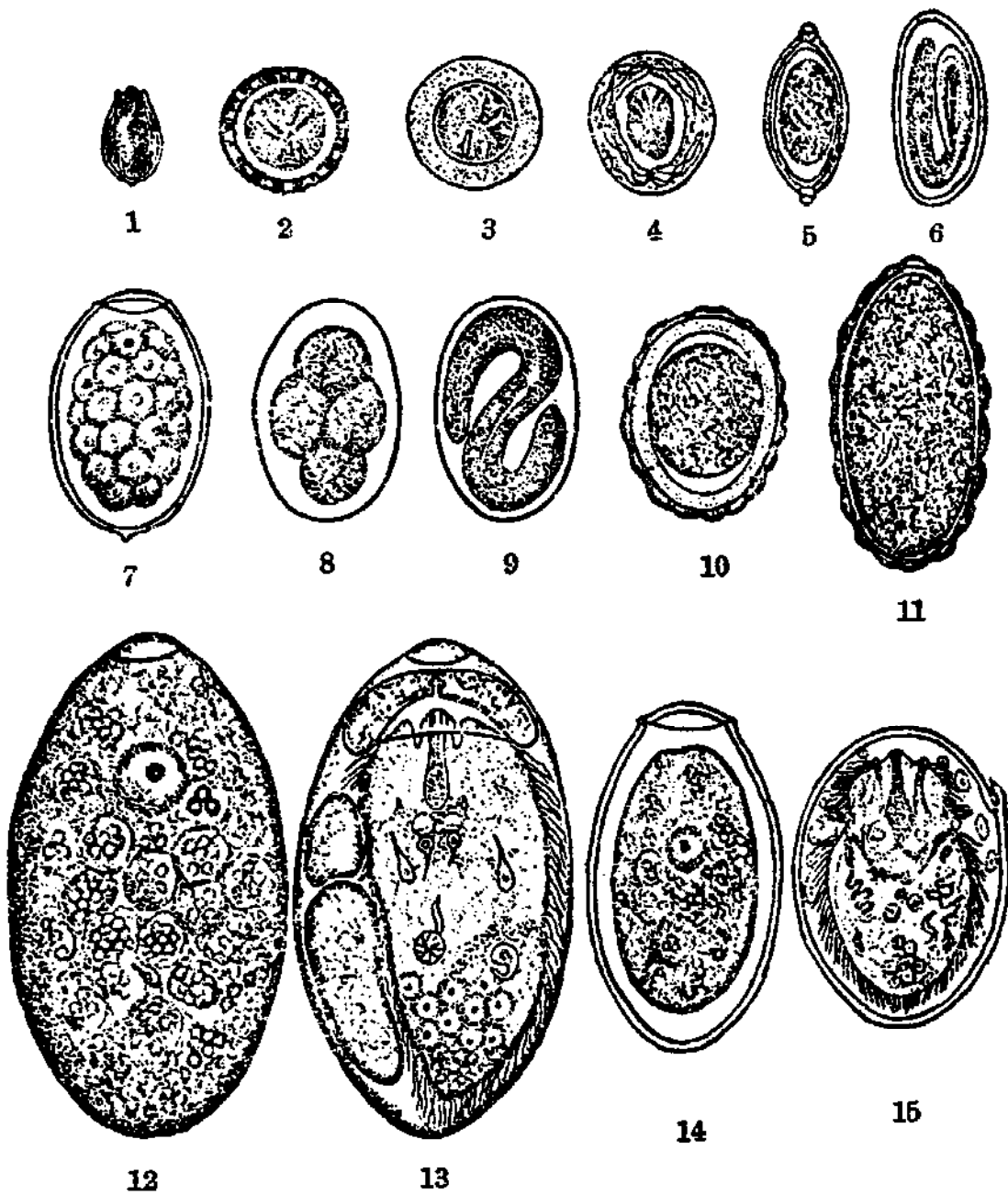

Figure 25. Various kinds of frequently seen parasite ova.

1. *Clonorchis sinensis*. 2. Tapeworm. 3. Tapeworm.
4. Short shell tapeworm. 5. Whip worm. 6. Thread worm.
7. Broad tapeworm. 8. Hookworm (immature).
9. Hookworm (mature). 10. *Ascaris* (fertilized).
11. *Ascaris* (unfertilized). 12. *Fasciolopsis* (immature).
13. *Fasciolopsis* (mature). 14. *Paragonimus Westermani*.
15. Schistosome.

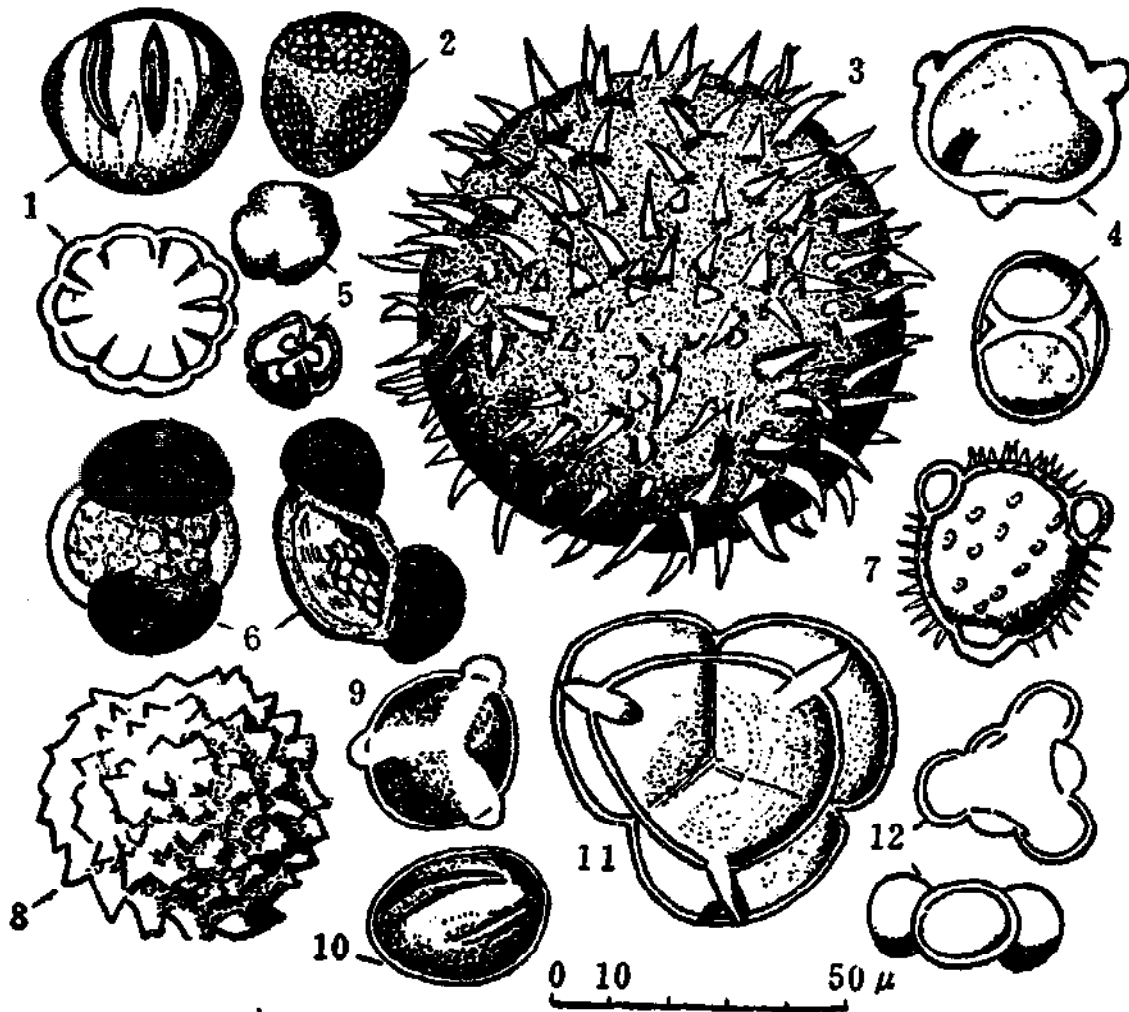

Figure 26. Several kinds of pollen that may be mistaken for parasite ova.

1. *Borage officinalis*, L.
2. *Lysimachia clethroides*.
3. Malvaceae.
4. *Ficus religiosa*.
5. *Papaver somniferum* (red poppy).
6. Pine.
7. *Aster tataricus*.
8. *Olaenlandia diffusa* (wild)
9. Violet.
10. Cauliflower.
11. *Rhododendron mettermichii*.
12. *Citissus scoporius*.

Water bugs are not uniform in size; some are dark green, greyish brown, or greyish white; and most do not refract light. Their movements are aimless, and some vibrate in a spiral fashion or move forward by rolling. They move suddenly forward and backward, floating about aimlessly, or circulating and not swimming in a straight line.

D. Precautions

1. Quality of Water

On the farms using river water or well water for hatching, attempts should be made to exterminate water bugs. When there are many water bugs, not only will they be confused with cercariae and cause mistakes, but also will slow down the observation speed and lower the work efficiency.

Elimination of water bugs. Use bleaching powder to kill water bugs; i.e., one level spoonful (about 0.4 g) of bleaching powder in 240 cattles of water. This method varies with the capacity of the water crock. Put the bleaching powder in a small basin, add water, and stir into a thin paste. Pour it into the crock, and stir evenly with a rod. After 30 minutes, the excess chlorine should be 0.7 to 1.0 ppm.

Dechlorination. Chlorinated water may be left overnight to allow it to naturally dechlorinate. Then it can be used. Another method is to add 1:400,000 sodium thiosulfate (in 240 cattles of water add 3 ml of sodium thiosulfate, a 10% solution). This water can be used 30 minutes later.

In areas with waterworks, tap water may be used; but if the chlorine excess is high, it may affect hatching of the cercariae. Therefore, if the chlorine excess is above 0.3 ppm, the water should also be dechlorinated (see method above).

If the river water is turbid, it may be treated with alum, but the concentration should not be too high. Generally it should be below 0.02% to 0.03%. The pH of water most suitable for hatching is 7.4 to 7.8 (weak alkalinity). A pH 6.8 to 7.6 range will not affect hatching. There is usually

no problem with the quality of the water used; but if the water source is close to chemical factories, attention should be paid to industrial waste water contamination. In such cases other rivers should be chosen to avoid affecting the results of hatching.

Salt concentration. The higher the concentration of sodium chloride in water, the more hatching will be suppressed. Generally, hatching can only occur in low salt concentration, not in areas along the seacoast where the salt concentration of water is high.

In summer if the room temperature is too high, 1.2% saltwater may be used instead of clear water to change solutions during sedimentation, using clear water for the last change. This procedure will avoid the hatching of cercariae too soon.

2. Effects of Stool Preservation

In practical work the stool must be fresh. Especially in summer it should not be kept for over 24 hours. Even in other seasons it should not be kept too long. In collecting stool specimens several procedures have to be followed before the specimen reaches the laboratory, so the stool may be old. At the same time, if specimens are held too long, the temperature may rise and fermentation occurs. In winter do not leave the stool outdoors overnight to freeze, or hatching will be affected.

3. Effects of Multiple Stool Examinations

The number of times a stool is examined and the positive reaction rate are in direct proportion. For general surveys in infectious areas, stools should be examined at least three times. Therefore the people must be fully mobilized to make sure there are three specimen examinations.

II. Serum Oval Ring Sedimentation Test

A positive serum oval ring sedimentation test produces a ribbon-shape or tapeworm-shape sediment around the ovum. The metabolites of the cercariae in a mature ovum combine with the homologous (specific) antibody

of the serum to produce a fluorescent ball shape. It is a highly accurate test. Laboratory reports show that species exhibit great specificity for the different stages of the life cycle and do not produce cross-reaction with other trematodes. The procedure is as follows:

A. Ova Suspension

1. Infect the domestic rabbit with about 2,000 cercariae. Dissect after 40 to 42 days.
2. Use the intravenous infusion method to collect the adult worm. Remove the liver, and use scissors to cut away the bile ducts and other connective tissues.
3. After microscopic slide examination proves that large amounts of schistosome ova are present, use normal saline to wash, and cut into pieces. Put into tissue-grinding machine, and fully grind into paste.
4. Add saline and filter through copper sieves with 40, 60, 80, 100, and 120 holes. After filtering grind once more.
5. Collect the filtrate into a 1000 ml conical measuring cup for sedimentation. Change the saline about every 30 minutes until the supernatant is entirely clear.
6. Pour the sediment into the pointed end of a centrifugal tube, and centrifuge two or three times until the sediment in the tube bottom becomes slightly yellow. This sediment contains pure ova.
7. Use normal saline to dilute the pure ova to a concentration of 100 to 200 ova/drop. This is the ova suspension. Preserve in the refrigerator at 4°C to 6°C. It may be used for 7 to 10 days.

B. Serum

Under semistarvation, withdraw 2 ml of blood from a vein or obtain blood from the capillaries of the earlobe. Separate the serum after clotting. Avoid hemolysis (slight hemolysis is not detrimental).

C. Test

1. Put a drop of the patient's serum on a clean slide. Do not use oil. Add a drop of ova suspension and immediately cover with a 24 X 24 mm cover slip. Use a cotton stick, and seal all edges with boiling pathological slide paraffin.

2. Put in a 37°C incubator for 48 hours, and then examine under a low-power microscope (100X). If necessary change to high power (400X).

3. Standard for positive reaction (Fig. 27). "+" surrounding the ovum are small amounts of spheroid sediments. They are even, colorless, fluorescent, and clearly different from other golden yellow remnants. "++" surrounding the ovum are process-like sediments. "+++" surrounding two-thirds of the ovum surface are sediments, showing different shapes such as false feet, chrysanthemum petals, or fungus branches. "++++" surrounding the ovum are various shapes of sediments mentioned above.

4. The positive results of the oval ring test are highest among acute infections (98% to 100%) and recent infections (100%). With patients who have been treated, no matter if they are cured or not, a positive reaction will be maintained for a certain time. Since the preparation of antigen is quite complicated, this method cannot be used widely. However, in people with clinical symptoms but repeated negative stool examinations, it still is valuable as a supplementary diagnostic test.

III. Proctoscopy or Sigmoidoscopy and Biopsy

A. Indications

Those patients with a history of contact with infected water and with symptoms and signs but repeated negative stool examinations should be

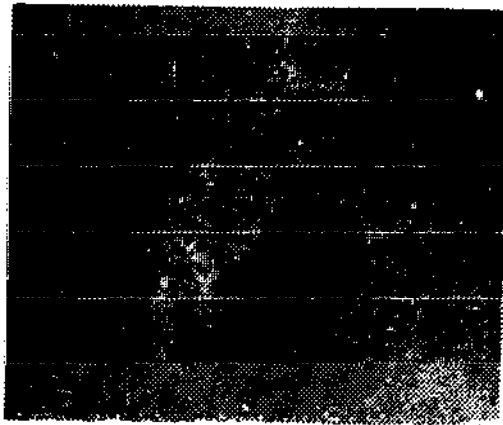

+

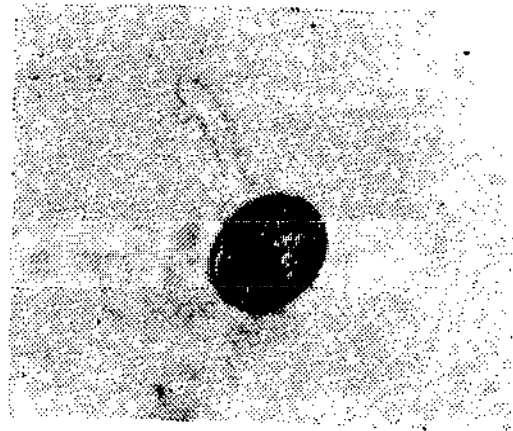

++

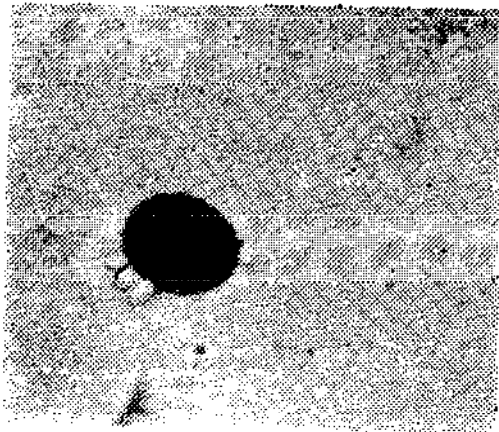

++

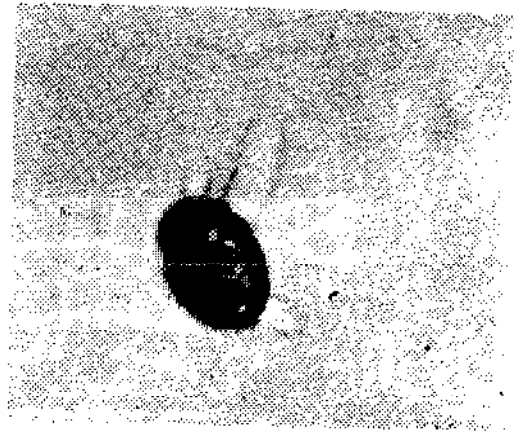

+++

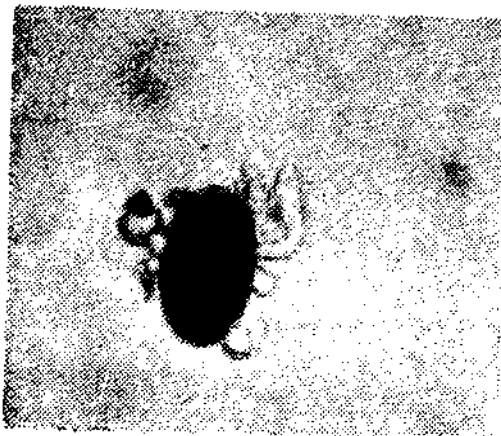

++

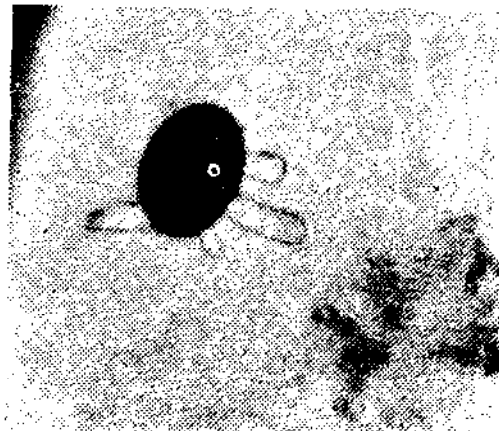

++++

Figure 27. Oval ring sedimentation test.

examined extensively. They may have a positive oval ring sedimentation test although a correct positive diagnosis of schistosomiasis was never made. Patients having a positive proctoscopic examination after being treated for over a year also should be examined carefully.

B. Precautions and Procedures

1. Examinations should be postponed for those with hemorrhagic diseases or liver function impairment with disturbed clotting mechanism, severe hemorrhoids and fissures, and extreme weakness.

2. Before proctoscopy, thorough bowel evacuation is sufficient. Before sigmoidoscopy, a suppository or saline-cleansing enema may be considered.

3. The patient is put in a knee-chest position or lies on the left side. Lubricate the scope with oil. Advise the patient to constrict the muscles surrounding the anus and expand the anal opening. Insert the scope into the anus for a few centimeters (after insertion advise the patient to relax). Remove the probe. Under the sigmoidoscope light, push the scope forward along the intestinal lumen and observe the condition of the mucosa.

4. If a biopsy is indicated, remove a piece of intestinal tissue about one-third the size of a rice grain on the dorsal surface of the intestine about 8 to 12 cm from the anal opening. Do not cut too deeply or tear the tissue.

5. The wound should be cauterized with silver nitrate (10%) or treated with bismuth subcarbonate powder, an antihemorrhage powder, to stop bleeding by pressure.

6. On the day after examination, the patient should rest. Avoid vigorous activities or forced defecation.

7. If abdominal pain, bloody stools, fever, or gaseous distension occur after examination, the patient should be observed to see if there are complications from intestinal perforation or hemorrhage.

C. Differentiation of Ova and Its Clinical Significance

Press the biopsy tissue with a cover slip on a slide into a thin sheet. First examine under a low-power microscope to look for ova. Then examine under high power to observe the construction of the cercariae in the ova to distinguish whether the ova are living or dead. The ova frequently observed in rectal biopsy tissue usually are of the following kinds:

Mature ova (living ova). These ova are oblong, light yellow, or yellowish brown. The shell is thin. The cercariae outline in the ova is clear.

Mutated ova. Generally the body is smaller than living ova; the shell, thickened; and the edges, uneven. If the ova are greyish yellow or dark yellow, the cercariae outline in the ova is clear or slightly smaller (grouped on one side). They are called recently mutated ova. If the cercariae in the ova have degenerated into a mass, show an unclear outline, have decayed into a remnant or net-like structure, or appear black or greyish white, they are called late-stage mutated ova.

Immature ova or ova shell. The body is smaller than living ova, and the shell is thin. No cercariae are in the ova, or only a few cell remnants can be seen. Some of them show degenerative changes.

If mature ova or recently mutated ova are seen, it means that living mature schistosomes are in the body and treatment of the disease must be carried out. If late-stage mutated ova or ova shells are seen, it does not necessarily mean there are living schistosomes in the body; no treatment is needed. If ova, no matter if living or mutated, are found in rectal biopsy tissue of those who have never been treated for the disease, it is best to begin a course of treatment.

TREATMENT OF PATIENTS

I. Pretreatment Preparations

Take the history, including symptoms of schistosomiasis (such as fever, purulent and bloody stools, hematemesis, ascites), appetite, and condition of work capacity, and whether there are various concurrent diseases such as hepatitis, nephritis, tuberculosis, as well as heart and neuropsychiatric diseases, or a family history of psychiatric diseases.

The physical examination should be very thorough and records kept of heart murmurs, heart rate, blood pressure, pulmonary rates, liver and spleen enlargement, ascites, jaundice, telangiectasia (venous dilation of the abdominal wall), edema of the lower extremities, etc.

Accurately measure, not estimate, the body weight. The patient should be naked and the weight accurately recorded.

After physical examination, complete records should be taken (Table 5, Table 6). Recommendations for treatment should be made, based on the patient's physical condition and age and whether there are associated diseases. With those in no condition for immediate treatment, explanations must be given. The complications should be treated actively and the patient prepared for schistosomiasis treatment.

II. The Selection of Medications and Methods for Schistosomiasis Treatment

With mild, chronic infections, oral drugs (antischistosome-846, antimony-273) or tartar emetic 3-day treatment may be used. With more severe infections showing symptoms, it is best to use the tartar emetic long-course treatment. In acute infection with fever, furapromidum may be given orally first. In patients with concurrent diseases, the selection of a drug

Table 5.--Schistosomiasis Treatment, History,
and Physical Examination Chart

No. _____

Name _____ Sex _____ Age _____ Occupation _____ Marital status _____
Family class _____ Labor capacity _____
Address _____ Commune (town, road) _____ Brigade (street, lane)
_____ Production team (No. _____)
Present illness: Fever, abdominal pain, diarrhea, dysentery, abdominal distension,
lassitude, hematemesis, melena, etc.: _____

Past history: Edema, palpitations, asthma, cough, hemoptysis, hematemesis or
melena, hepatic pain, jaundice, epilepsy, psychiatric diseases, neurological
disorders, stomach diseases, uterine prolapse, nephritis, tuberculosis, etc.

Personal and family history: Menstruation, menarche at _____ age; menstrual period
_____ days, with or without pain; pregnancy _____ months; breast-feeding
_____ months
History of treatment: Previous treatment _____ times, name of drug used _____, last
treatment _____ year _____ month.

Table 5 (continued)

Physical examination:

General: Development (good, poor), with or without secondary sex characteristics, nourishment (good, medium, poor), anemia (mild, medium, severe), edema (generalized, lower extremities, none), lymph nodes enlargement () _____
B.P. / _____ mm Hg, body wt _____ kg, temperature _____ °C

Lungs: _____

Heart: Heart dullness (enlarged _____ cm, none), murmurs (_____ area _____ degree _____ stage murmur, none), rate _____ times/min, rhythm _____

Abdomen: Appearance _____, shifting dullness (present or absent), abdominal veins showing or not _____ abdominal mass _____

Liver: Not palpable, _____ cm below costal margin, _____ cm below xiphoid process, surface (smooth, nodulated), firmness (firm, medium, soft), tenderness (none, slight, marked)

Spleen: Not palpable, _____ cm below costal margin, transverse diameter _____ cm over midline, firmness _____ tenderness _____

Pathological reflexes and others _____

Laboratory: Stool sedimentation hatching _____

Diagnosis: _____

Treatment suggestions _____

Signed by doctor _____

_____ year _____ month _____ day

Table 6.--Schistosomiasis Treatment Record Chart No. _____

Name _____ Sex _____ Age _____ Occupation _____ Family class _____ Wt _____ kg

Type of schistosomiasis: _____ (before treatment diarrhea,
dysentery, liver enlarged $\frac{1}{2}$ ": _____ cm, spleen enlarged _____ cm.)

Medication for treatment: _____ planned total dosage _____
course (days) _____

Time of treatment: Started _____ yr. _____ mo. _____ day. Finished _____
_____ mo. _____ day. Actual dosage used _____

Daily dosage: 1 _____ 2 _____ 3 _____ 4 _____ 5 _____ 6 _____ 7 _____ 8 _____
9 _____ 10 _____ 11 _____ 12 _____ 13 _____ 14 _____ 15 _____ 16 _____
17 _____ 18 _____ 19 _____ 20 _____ 21 _____ 22 _____ 23 _____ 24 _____

Table 6 (continued)

Symptoms	Before treatment	During treatment no.	Month/day	Time	Dosage	Cumulative dosage
Nausea						
Vomiting						
Anorexia						
Abdominal distention						
Diarrhea						
Abdominal pain						
Liver tenderness						
Dizziness						
Headache						
Vertigo						
Blurred vision						
Lassitude						
Joint Pains						
Insomnia						
Skin rashes						
Colored vision						
Muscle spasm						
Numbness/limbs						
Heart rate						
Heart rhythm						
Progress note:						
Summary of treatment:	Completed on schedule	temporary stop	times			
	completed with decreased dosage	stop treatment and reason				
Followups:	(included improvement of symptoms and signs, recovery of labor capacity, etc.					

should be based on the nature of the complication. Oral antischistosome-846 is safe for cardiovascular patients. In patients with neuropsychiatric diseases, tuberculosis, and chronic hepatitis in the recovery stage, small-dosage long-course tartar emetic treatment may be considered. Furthermore, to decrease drug reaction and improve treatment effects, the combined use of two drugs may be explored (Table 7).

After treatment with tartar emetic, antischistosome-846, or antimony-273, if reexamination shows that the patient is not cured, an interval of about 6 months is generally required if the same drug is to be used for another treatment.

III. Oral Medicines

A. Antischistosome-846 (Antischistosome Tablet and Powdered Milk)

1. Indicated for:

a. Patients with chronic schistosomiasis whose stool examinations are positive and whose general health is good. Patients with late schistosomiasis whose liver and spleen are enlarged, showing no marked tenderness, jaundice, or ascites and able to take part in ordinary labor.

b. Patients with acute schistosomiasis after improvement of their general conditions.

2. Contraindicated for:

a. The patient or close relative (covering two families, three generations) with a history of psychiatric disease.

b. Patients with history of epilepsy; neurosis (including hysteria, psychasthenia, and neurasthenia); internal ear dizziness (Meniere's syndrome); or frequent attacks of fainting, dizziness, or vertigo of unknown origin.

Table 6 (continued)

Symptoms	Before treatment	During treatment no.	Month/day	Time	Dosage	Cumulative dosage
Nausea						
Vomiting						
Anorexia						
Abdominal distention						
Diarrhea						
Abdominal pain						
Liver tenderness						
Dizziness						
Headache						
Vertigo						
Blurred vision						
Lassitude						
Joint Pains						
Insomnia						
Skin rashes						
Colored vision						
Muscle spasm						
Numbness/limbs						
Heart rate						
Heart rhythm						
Progress note:						
Summary of treatment:	Completed on schedule	_____	temporary stop	_____	times	
	completed with decreased dosage	_____	stop treatment and reason	_____		
Followups:	(included improvement of symptoms and signs, recovery of labor capacity, etc.					

c. Patients who have recovered from hepatitis within the past year or who are suspected of having hepatitis, cirrhosis of the liver, ascites, or jaundice. In acute hepatitis after a recovery of 6 months, a patient having normal liver function and labor capacity may be treated under strict observation.

d. In patients with added concurrent acute or chronic diseases that are not stabilized (fever, acute myocarditis, heart failure, acute stage of nephritis, severe anemia, etc.).

e. Hemorrhagic disease patients.

f. Women who are pregnant or who have been breast feeding for less than 1 year.

3. Dosage and Course

At present there are two forms of antischistosome-846: tablet and milk powder. The antischistosome tablet is white and is made by grinding the antischistosome-846 crystal powder into minute granules by the air-current grinding process and then pressing into tablet form. Each tablet contains 0.25 g of antischistosome-846. Antischistosome milk powder is made by adding a small amount of vegetable oil, sugar, and edible gelatin to antischistosome-846 crystal powder. After high speed emulsification, it is treated by the granulating membrane method to form a powder, which easily absorbs moisture. Each 100 g of antischistosome powder contains 21 g of antischistosome-846 and 6.72 ml of oil. Because its absorption is better than the tablet, the dosage is smaller and the course shorter. Drug reaction is basically the same as for the tablet.

The dosages and courses are:

a. Antischistosome tablet: 80 mg/kg/day; continue for 10 days; the highest total dosage, 40.0 g (Table 8).

b. Antischistosome milk powder: 50 mg/kg/day; continue for 7 days; the highest total dosage, 17.5 g (Table 9).

Table 7.--Dosage and Course Frequently Used for Various Drugs in the Treatment of Schistosomiasis

Name of drug	Drug form	Dosage	Method of Use	
			Course	Highest total dosage
Antischistosome-846¹				
Tablet	Oral (0.25 g)	80 mg/kg/day	10 days	40 g
Milk powder	Oral (0.21 g)	50 mg/kg/day	7 days	17.5 g
Antimony-273²				
	Medium-speed tab. oral	350 mg/kg	10 days	17.5 g
	(200 mg)	400 mg/kg	15 days	20.0 g
	Slow-melting tab. oral	500 mg/kg	10 days	25 g
	(200 mg)	600 mg/kg	15 days	30 g
Tartar emetic				
	Ampules (i.v.) ³	12 mg/kg	3 days	0.7 g (male)
	Each ampule			0.6 g (female)
	with 1% 10 ml equal to	24-25 mg/kg ⁴	20 days	1.4 g (male)
	0.1 g	22-24 mg/kg ⁵	22-24 days ⁶	1.25 g (female)
				1.2 g
Furapromidum⁷				
(F-30066)	Slow-dis- solving tab. oral (0.125 g)	60 mg (40-70/kg/day)	14 days ⁸	

Table 7 (continued)

¹Use indicated in: chronic schistosomiasis in good health; late schistosomiasis, liver and spleen enlarged with no marked tenderness, without jaundice or ascites, and able to take part in labor; acute schistosomiasis, after general condition improvement.

²Use indicated in: chronic schistosomiasis in fairly good condition; acute schistosomiasis after fever subsided and general condition improved; late schistosomiasis after general condition improvement (no history of ascites, hepatitis, hepatic function fair).

³Used indicated in: chronic schistosomiasis without apparent anemia or nutritional disturbances, without clear signs of liver cirrhosis, appetite and labor normal, general condition fair.

⁴Use indicated in: more severe infection or repeated treatment without cure; acute schistosomiasis after fever subsided, general condition good.

⁵Use indicated in: acute, chronic, or late repeated infections, after fever subsides but still in weak condition; late schistosomiasis (or after splenectomy) with subsided ascites, appetite and general condition improved, hepatic function good; chronic or late schistosomiasis in old age and weak patients with added diseases.

⁶Small-dosage long-course.

⁷Use indicated in: acute schistosomiasis or chronic schistosomiasis with reinfection and fever; late schistosomiasis with fever, if there is no jaundice, ascites, liver function fair, under strict observation.

⁸For reinfection may extend to 21 days.

Table 8. Antischistosome Tablet 10-Day Course Dosage Chart
 (calculating the 10-day total dosage of antischistosome-846
 on the basis of 0.8 g/kg, the average daily dose is
 0.08 g/kg) (0.25 g tablet)

Body wt (kg)	Total dosage		Daily dosage									
	g	Tablet	1	2	3	4	5	6	7	8	9	10
11	8.75	35	4	4	4	4	4	3	3	3	3	3
12	9.50	38	4	4	4	4	4	4	4	4	3	3
13	10.50	42	5	5	4	4	4	4	4	4	4	4
14	11.25	45	5	5	5	5	5	4	4	4	4	4
15	12.00	48	5	5	5	5	5	5	5	5	4	4
16	12.75	51	6	5	5	5	5	5	5	5	5	5
17	13.50	54	6	6	6	6	5	5	5	5	5	5
18	14.50	58	6	6	6	6	6	6	6	6	5	5
19	15.25	61	7	6	6	6	6	6	6	6	6	6
20	16.00	64	7	7	7	7	6	6	6	6	6	6
21	16.75	67	7	7	7	7	7	7	7	6	6	6
22	17.50	70	7	7	7	7	7	7	7	7	7	7
23	18.50	74	8	8	8	8	7	7	7	7	7	7
24	19.25	77	8	8	8	8	8	8	8	7	7	7
25	20.00	80	8	8	8	8	8	8	8	8	8	8
26	20.75	83	9	9	9	8	8	8	8	8	8	8
27	21.50	86	9	9	9	9	9	9	8	8	8	8
28	22.50	90	9	9	9	9	9	9	9	9	9	9
29	23.25	93	10	10	10	9	9	9	9	9	9	9
30	24.00	96	10	10	10	10	10	10	9	9	9	9
31	24.75	99	10	10	10	10	10	10	10	10	10	9
32	25.50	102	11	11	10	10	10	10	10	10	10	10
33	26.50	106	11	11	11	11	11	11	10	10	10	10
34	27.25	109	11	11	11	11	11	11	11	11	11	10
35	28.00	112	12	12	11	11	11	11	11	11	11	11
36	28.75	115	12	12	12	12	12	11	11	11	11	11
37	29.50	118	12	12	12	12	12	12	12	12	11	11
38	30.50	122	13	13	12	12	12	12	12	12	12	12
39	31.25	125	13	13	13	13	13	12	12	12	12	12
40	32.00	128	13	13	13	13	13	13	13	13	12	12
41	32.75	131	14	13	13	13	13	13	13	13	13	13
42	33.50	134	14	14	14	14	13	13	13	13	13	13
43	34.50	138	14	14	14	14	14	14	14	14	13	13
44	35.25	141	15	14	14	14	14	14	14	14	14	14
45	36.00	144	15	15	15	15	14	14	14	14	14	14
46	36.75	147	15	15	15	15	15	15	15	14	14	14
47	37.50	150	15	15	15	15	15	15	15	15	15	15
48	38.50	154	16	16	16	16	15	15	15	15	15	15
49	39.25	157	16	16	16	16	16	16	16	15	15	15
50	40.00	160	16	16	16	16	16	16	16	16	16	16

Table 9. Antischistosome Milk Powder 7-Day Course Dosage Chart
 (calculating the 7-day total dosage of antischistosome-846
 milk powder on the basis of 0.35 g/kg, the average daily
 dose is 0.05 g/kg)

Body wt	Total dosage (g) (846 basic material)	Daily dosage:			Body wt	Total dosage (g) (846 basic material)	Daily dosage:		
		g (846 basic mat)	g (wt of milk powder)	Conv into ml (milk powder)			g (846 basic mat)	g (wt of milk powder)	Conv into ml (milk powder)
11	3.85	0.55	2.62	6.5	31	10.85	1.55	7.38	18.5
12	4.20	0.60	2.88	7.0	32	11.20	1.60	7.62	19.0
13	4.55	0.65	3.09	8.0	33	11.55	1.65	7.86	20
14	4.90	0.70	3.33	8.5	34	11.90	1.70	8.10	20.5
15	5.25	0.75	3.57	9.0	35	12.15	1.75	8.34	21
16	5.60	0.80	3.81	9.5	36	12.50	1.80	8.58	21.5
17	5.95	0.85	4.05	10.0	37	12.85	1.85	8.81	22
18	6.30	0.90	4.28	11.0	38	13.30	1.90	9.05	23
19	6.65	0.95	4.52	11.5	39	13.65	1.95	9.29	23.5
20	7.00	1.00	4.76	12.0	40	14.00	2.00	9.52	24
21	7.35	1.05	5.00	12.5	41	14.35	2.05	9.76	24.5
22	7.70	1.10	5.24	13.0	42	14.70	2.10	10.0	25
23	8.05	1.15	5.48	14.0	43	15.05	2.15	10.20	26
24	8.40	1.20	5.71	14.5	44	15.40	2.20	10.44	26.5
25	8.75	1.25	5.95	15.0	45	15.75	2.25	10.68	27
26	9.10	1.30	6.20	15.5	46	16.10	2.30	10.92	27.5
27	9.45	1.35	6.44	16.0	47	16.45	2.35	11.16	28
28	9.80	1.40	6.68	17.0	48	16.80	2.40	11.40	29
29	10.15	1.45	6.92	17.5	49	17.15	2.45	11.64	29.5
30	10.50	1.50	7.14	18.0	50	17.50	2.50	11.9	30

Note: To facilitate dispensing, a measuring tube
 (or injection tube) may be used to calculate the dosage.
 For antischistosome-846 (2.5 g), pouring into the measuring
 tube is equivalent to about 30 ml.

(Body weight over 50 kg should be based on a 50 kg scale to calculate the dosage.)

4. Prevention and Treatment of Side Reactions

In carrying out antischistosome-846 treatment, one must not overlook the side effects. On the one hand antischistosome-846 can treat schistosomiasis, but on the other hand serious side reactions may affect the body. Therefore in carrying out treatment one must treat side reactions promptly. Whenever antischistosome-846 treatment is properly undertaken and side reactions are taken care of early, there is a marked decrease of patients with delayed reactions.

The side reactions of antischistosome occur mostly during the course of treatment. In a few patients they may continue after treatment or may be more severe because of added factors. Seldom do these reactions appear after the conclusion of treatment. Depending on the degree, side reactions may be divided into general classes: mild (patients show short and relatively mild reactions and can still take part in labor) or severe (patients exhibit severe symptoms, cannot work, and a few may even be bedridden). Additionally, with mental disturbances or rare reactions such as hemolytic anemia, the patients should be transferred early for treatment. In the management of the case, the patient must fully participate, especially in the few patients with severe or prolonged reactions.

a. Neuropsychiatric Aspects of Side Reactions

Dizziness. Treat at new acupuncture points (Ho-ku, Feng-chih Pe-hui, Yin-t'ang.)

Herb medicine: Mix *Eclipta alba*, 1 oz; *Lobelia radicans*, 1 oz; *Angelica anamala*, 3 dr (one daily dose). Make into concoction or syrup, and divide into two to three portions.

Others. Vitamin B₁, nicotinamide, and α -aminobutyric acid may all be used (use recommended dosage).

Headache. New acupuncture points (Ho-ku, Tai-yang, Pe-hui), or use analgesics.

Lassitude. New acupuncture points (Tsu-san-li, Ch'eng-san, San-yin-chiao) or the above herb prescription adding *Conioselinum univittatum*, 3 dr, and *Agrimonia pilosa*, 1 oz. Method of preparation and use same as above.

Sight. For blurred vision, poor adaptation to darkness, night blindness, use vitamin A and D pills, or add nicotinamide.

Insomnia. New acupuncture points (Nei-kuan, Shen-men, San-yin-chiao, Ho-ku, Pe-hui) or a form of alkali 681, etc.

b. Alimentary Tract Aspects of Side Reactions

Anorexia, abdominal distension. New acupuncture points (Tsu-san-li, Ch'eng-san, Nei-kuan, Chung-kuan), or the B vitamins.

Nausea, vomiting. New acupuncture points (Nei-kuan, Tsu-san-li, T'ien-t'u), belladonna, etc.

Abdominal pain. The cause should first be investigated. If complicated with bile duct ascariasis, medication should be stopped and antispasmodics used; then anthelmintics given. If there is gastric pain, probanthine, sodium bicarbonate, etc., may be used.

c. Other Side Effects

General side reactions also are treated symptomatically, such as by treating skin rashes with chlortrimeton, phenergan, etc.

5. Prevention and Management of Severe Side Reactions

a. Conscientiously carry out "two in time" and "three keys" control. "Two in time" means discover side reactions in time and carry out conscientious management in time. "Three keys" means: the key of proper

selection of patients before treatment—obtain detailed history, do thorough physical examination. Based on the indications for the use of antischistosome-846 and the patient's actual condition, carefully select patients for treatment; the key of close observation during treatment and management of side reactions—during treatment medical personnel must make frequent visits and closely observe patients, be fully informed about the patient's daily condition, and manage reactions in time; treatment followup is the third key.

After the conclusion of treatment, for a few days, some patients may continue to have side reactions which gradually become less severe or disappear. But in a few patients, due to tiredness, fever, mental trauma, drinking alcohol, or eating oily food, etc., the reaction may become more severe or prolonged. If controlled in time, these patients usually recover rather soon. Therefore, periodic followup within the first month of treatment completion is very important.

b. Properly arrange type of work and rest. To provide conditions for safe medication and reduce side reactions, during treatment the type of work should be rearranged (avoid working at high elevations or on the water) and suitable rest allowed. Generally light work may be done in the morning; rest in the afternoon after taking the drug. After completing a course of treatment, depending on the actual condition of the patient during medication, rest or only do light work for a few days.

c. Indications for discontinuation are: Severe fainting, lassitude, or dizziness that necessitates staying in bed; marked somnolence and severe insomnia, excitement, polyphrasia, unstable mental state, or slight but clearly present mental trauma; complications of fever and infection; severe anorexia (below one-third of normal appetite), nausea, or appearance of yellow sclera and darkened color of urine indicating symptoms of toxic hepatitis; generalized skin rash accompanied by fever; acute abdominal pain, such as complicating bile duct ascariasis; continuous false vision, colored vision, diplopia, and marked impairment of vision.

d. The use of Chinese herb medicine, in addition to symptomatic treatment, to treat side reactions should be advocated strongly and widely tried. The following prescriptions may be chosen:

i. With symptoms of dizziness and insomnia, causing general lassitude:

Valeriana officinalis, 3-6 dr; mix in 300 ml water; add sugar, 1 oz; take 50 ml three times daily.

Zizyphus vulgaris, 15-25 pieces; fry until fragrant and grind fine; add equal parts of sugar; take once every night.

Kadsura sinensis, 1½-3 dr; mix in 300 ml water; add sugar, 1 oz; take 150 ml each morning and night.

Eclipta alba, 1 oz; *Lobelia radicans*, 5 dr; oyster shell, 1 oz; *Conioselinum univittatum*, 3 dr; *Polygonum multiflorum*, 5 dr; *Ligustrum japonicum*, 5 dr; mix in 300 ml water; take 150 ml each morning and night.

Antischistosome No. 1: *Eclipta alba*, 1 oz; *Lobelia radicans*, 5 dr; *Angelica anamala*, 3 dr (1 day's dosage); make into concoction or syrup; divide into two or three portions to ingest.

Zizyphus vulgaris, 4-6 dr; *Anemarrhena asphodeloides*, 1.5-3 dr; *Conioselinum univittatum*, 1-1½ dr; *glycyrrhiza*, 1-1½ dr; make mixture with 300 ml water; take 150 ml each in morning and evening.

Glycyrrhiza, 3 dr; *Triticum sativum*, 1 oz; Jujube, 10 pieces; *Rehmannia glutinosa*, 4 dr; *Lilium japonicum*, 3 dr; *Salvia multiorrhiza* 4 dr; toasted seeds of *Zizyphus vulgaris*, 5 dr; *Polygonium multiflorum*, 1 oz; make into mixture with 300 ml water; take 150 ml each in morning and evening.

ii. With symptoms of dizziness and lassitude, causing other discomforts:

Agrimonia pilosa, 1-2 oz; *Eucommia ulmoides*, 1-2 oz; mix with 300 ml water; add sugar, 1 oz; take 150 ml each morning and evening.

Antischistosome No. 2: *Agrimonia pilosa*, 1 oz; *Eclipta alba*, 1 oz; *Lobelia radicans*, 1 oz; *Angelica anamala*, 3 dr; *Conioselinum unitatum*, 3 dr; method of preparation and medication same as for antischistosome No. 1.

Eclipta alba, 1 oz; *Radix rubide*, 1 oz; *Ligustrum japonicum*, 1 oz; *Enonymus japonicum*, 1 oz; make concoction with 300 ml water; add sugar, 1 oz; take 150 ml each morning and evening.

Salvia multiorrhiza, 4-5 dr; *Angelica sinensis*, 3-4 dr; Fresh *glycyrrhiza*, 3 dr; *Agrimonia pilosa*, 0.5-1 oz; Jujube, 5-10 pieces; mix with 300 ml water; take 150 ml each morning and evening.

Agrimonia pilosa, 1 oz; *Salvia multiorrhiza*, 4-5 dr; *Tribulus terrestris*, 4-5 dr; mix with 300 ml water; take 150 ml morning and evening.

iii. With symptoms of lassitude and anorexia, causing other discomforts:

Ingluvin, 1 oz ground fine; add suitable amount of sugar, and stir evenly; take 2 g three times a day (1 oz equal to 30 g).

Use one large toad; do a laparotomy and put *Amomum xanthioides*, 1 dr, in the abdomen; suture. Wrap with river mud; bake in fire till the mud turns red and cracks; remove the mud; take the toad, and grind into powder. Take 0.5 dr (about 15 g) two to three times daily. May use orange peel to make tea to drink with the powder.

Juglans regia, 2 pieces; yeast 5 dr; *Rhaphanus sativus*, 3 dr; malt 3-4 dr; mix with 300 ml water; take 100 ml three times per day.

Campanumaea pilosula, 3 dr; *Atractylodes lancea*, 3 dr; *Ingluvin*, 3 dr; *Poncirus*, 2 dr; *Cyperus rotundus*, processed 3 dr; *Curcuma*, 3 dr; *Salvia multiorrhiza*, 4 dr; *Corydalis ternata*, 4 dr; method of preparation and dosage same as above.

Pinellia tuberifera, 3 dr; *Pachyma cocos*, 3 dr; *Nelumbium speciosum*, 3 dr; bamboo shoots, 3 dr; orange peel, 1.5 dr; *Glycyrrhiza*, 1½-3 dr; method of preparation and dosage same as above.

iv. With symptoms of insomnia, palpitation, many dreams, and loss of memory:

Salvia multiorrhiza, 3-5 dr; *Polygala tenuifolia*, 2-3 dr; *Kadsura chinensis*, 1½-3 dr; juniper seeds, 3-5 dr; mix with 300 ml water; take 150 ml each morning and evening.

Valeriana officinalis, 3-6 dr; *Glycyrrhiza*, 2 dr; *Juncus effusus*, 3 bundles; mix with 300 ml water; add sugar, 1 oz; take 100 ml each night.

v. Mentally excited and hard to control (polyphrasia, etc.):

Triticum sativum, 1-2 oz; *Glycyrrhiza*, 1-3 dr; Jujube, 4-6 pieces; *Polygonum multiflorum*, 3-8 dr; mix with 300 ml water; take 100 ml three times per day.

Triticum sativum, 1 oz; *Glycyrrhiza*, 3 dr; Jujube, 10 pieces; *Polygala tenuifolia*, 3 dr; *Salvia multiorrhiza*, 3 dr; method of preparation and dosage same as above.

Agrimonia pilosa, 1 oz; *Salvia multiorrhiza*, 3-5 dr; *Tribulus terrestris*, 5 dr; *Ingluvin*, 3 dr; *Glycyrrhiza*, 3 dr; method of preparation and dosage same as above.

Powdered centipede, 0.3 dr; powdered scorpion, 0.3 dr; powder of *gastrodia elata*, 0.3 dr; stir evenly and take 0.3 dr three times per day.

To the above prescription, add bird beaks and snake meat, 0.3 dr; take 1 dr three times per day.

e. 681 (form of alkali) treatment may be used in patients with main symptoms of anorexia, insomnia, etc; 681, 1 to 2 g three times per day may be given; 10 to 20 days constitute a course of treatment. More than half of the cases will show markedly good effects. During medication there may be a burning sensation; a few may have diarrhea or borborygmi. May also use injections of 0.5 to 2.0 g in 500 ml glucose (50%) for intravenous drip once daily; continue for about 5 to 7 days.

f. Corticosteroids are used for patients with acute severe reactions (general weakness, lassitude, bedridden). During use, watch for infections or secondary infections. If necessary, antibiotics should be added. Use hydrocortisone, 100 mg added to 500 ml (5%) glucose for intravenous drip once daily; continuous use for about 5 days frequently is effective.

g. Calorie-synthesizing drugs may be used in patients with weakness, anorexia, lassitude, and liver function damage. Method of preparation: 500 ml glucose (10%); regular insulin, 8-12 units; ATP 20-40 mg; vitamin B₆, 100 mg; coenzyme A, 50 units; potassium chloride, 1.0 g; for intravenous drip once daily; 1 to 2 weeks constitute a course of treatment.

h. Insulin hypoglycemia treatment may be used for functional neurasthenia with main symptoms of anorexia, insomnia, and mental depression (not for organic diseases of the heart, liver, kidney, and endocrine organs) that did not improve with other methods of treatment. These patients should be hospitalized for treatment and observed by special responsible personnel. Every morning regular insulin is given intramuscularly, starting with small dosage (8 to 16 units), increasing daily until reaching the stage of hypoglycemia (hungry feeling, perspiration, tiredness, palpitation, dryness of mouth), usually about 40 units. Stop injections 2½ to 3 hours later. To stop medication, first give glucose water, then congee. If the patient has gone into a state of semiconsciousness, then medication may be stopped earlier. If there is difficulty in eating, then 20 ml glucose (50%) may be given intravenously; then give glucose and congee by mouth. A course usually lasts 20 to 30 days. In a few stubborn cases, the dosage may be

increased until the patient is semiconscious. During treatment there may be extrasystoles, or after treatment there may be secondary hypoglycemia. These should be treated quickly. Most patients will recover.

In combined treatment for multiple and complex symptoms, identify these symptoms, and use a combination of the above methods for treatment.

B. Sodium Antimony Gallate (Antimony-273)

Sodium antimony gallate (antimony-273) is a kind of oral antimony drug for the treatment of schistosomiasis.

1. Nature of Drug

Antimony-273 is the sodium salt of antimony gallate; the product is a milky yellow powder. The tablet presently in use is made by adding hard fatty acid powder to antimony-273. Two types are the delayed-dissolving tablet and the medium-speed tablet.

Each delayed-dissolving tablet weighs 0.4 and contains 200 mg antimony-273. It requires about 8 hours to release 95% of the main drug in artificial gastric secretion and artificial intestinal secretion.

Each medium-speed tablet weighs 0.3 g and contains 200 mg antimony-273. It requires about 6 hours to release over 95% of the main drug in artificial gastric secretion and artificial intestinal secretion.

Both types of tablets are slow-dissolving drugs. They are greyish white and hard, easily absorb moisture in the air, and show moldy spots. After exposure to heat, the quality becomes brittle. Therefore they should be stored in sealed containers and left at dry and cool places. If they are moldy or brittle, they should be discarded. In clinical observations both types of tablets were seen to be rejected in the stool, but most of the main drug in the tablet has already been released. The stool rejection of medium-speed tablets is much less than that of delayed-dissolving tablets. Besides,

there is also a type of "adaptation tablet"; each tablet weighs 0.12 g and contains 10 mg antimony-273 to provide the stimulating dosage of adaptation method.

2. Selection of Patients

Patients are selected in the way as those chosen for tartar emetic 3-day and 20-day treatment methods. Antimony-273 is used mainly for the treatment of chronic schistosomiasis. Its use may also be considered in acute schistosomiasis after subsidence of fever or in late schistosomiasis if there is no history of ascites, jaundice, or hepatitis and if the appetite and labor capacity are still fair. Patients must be carefully selected; special attention should be given to the condition of the heart, liver, and kidneys. When this drug is used, a medical facility should be established in the commune for treatment.

3. Course of Treatment and Dosage (Tables 10 to 13)

Delayed-dissolving tablet. In 10-day treatment course, the total dosage is calculated on a basis of 500 mg/kg body weight; in 15-day treatment course, it is calculated on a basis of 600 mg/kg body weight.

Medium-speed tablet. In 10-day treatment course, the total dosage is calculated on a basis of 350 mg/kg body weight; in 15-day treatment course, it is calculated on a basis of 400 mg/kg body weight.

All body weight over 50 kg is calculated as 50 kg. In considering the dosage and course of treatment, there should be flexibility according to the specific conditions. In winter, in children, and in patients who had no reactions during the latter part of the treatment course, increase of dosage may be considered; in summer and in old and weak patients, decrease of dosage may be considered. Increase or decrease of dosage is usually around 5% to 10%.

Table 10. Antimony-273 Delayed-Dissolving Tablet 10-Day Treatment Course and Dosage Table (total dosage 500 mg/kg body wt. Each tablet contains 200 mg antimony-273)

Body wt (kg)	Total dosage (g)	Total no. of tablets	Daily no. of tablets									
			1	2	3	4	5	6	7	8	9	10
20	10.0	50	5	7	6	6	5	5	4	4	4	4
21	10.5	53	5	7	7	6	6	5	5	4	4	4
22	11.0	55	5	7	7	7	6	5	5	5	4	4
23	11.5	58	5	8	7	7	7	6	5	5	4	4
24	12.0	60	5	8	8	7	7	6	5	5	5	4
25	12.5	63	5	9	8	8	7	6	5	5	5	5
26	13.0	65	5	9	9	8	8	6	5	5	5	5
27	13.5	68	5	9	9	9	8	7	6	5	5	5
28	14.0	70	5	10	9	9	8	7	6	6	5	5
29	14.5	73	6	10	9	9	9	8	6	6	5	5
30	15.0	75	6	10	10	9	9	8	7	6	5	5
31	15.5	78	6	10	10	10	9	9	8	6	5	5
32	16.0	80	6	10	10	10	10	9	8	6	6	5
33	16.5	83	6	11	10	10	10	10	8	6	6	6
34	17.0	85	6	11	11	10	10	10	8	7	6	6
35	17.5	88	6	11	11	11	11	10	9	7	6	6
36	18.0	90	6	11	12	11	11	11	9	7	6	6
37	18.5	93	6	11	12	12	12	11	10	7	6	6
38	19.0	95	7	11	12	12	12	11	10	8	6	6
39	19.5	98	7	11	12	12	12	12	11	8	7	6
40	20.0	100	7	11	13	12	12	12	11	8	7	7
41	20.5	103	7	11	13	13	13	12	11	9	7	7
42	21.0	105	7	11	14	13	13	12	11	9	8	7
43	21.5	108	7	11	14	13	13	13	12	10	8	7
44	22.0	110	7	11	14	14	13	13	12	10	9	7
45	22.5	113	7	11	14	14	14	13	13	11	9	7
46	23.0	115	7	11	14	14	14	14	13	11	10	7
47	23.5	118	7	11	15	14	14	14	13	12	10	8
48	24.0	120	7	11	15	15	14	14	14	12	10	8
49	24.5	123	7	11	15	15	15	14	14	13	11	8
50	25.0	125	7	11	15	15	15	15	14	13	12	8

Note: First day take drug three times: one tablet after breakfast; two tablets after lunch; the rest of daily dosage after supper. Thereafter the daily dosage may be taken in two to three divided doses.

Table 11. Antimony-273 Delayed-Dissolving Tablet 15-Day Treatment Course and Dosage Table (total dosage 600 mg/kg body wt, each tablet contains antimony-273 200 mg)

Body wt (kg)	Total dosage (g)	Total no. tabs.	Daily no. of tablets														
			1	2	3	4	5	6	7	8	9	10	11	12	13	14	15
20	12.0	60	5	5	5	5	5	4	4	4	4	4	3	3	3	3	3
21	12.6	63	5	6	5	5	5	5	4	4	4	4	4	3	3	3	3
22	13.2	66	5	6	6	5	5	5	5	4	4	4	4	4	3	3	3
23	13.8	69	5	6	6	6	5	5	5	5	4	4	4	4	4	3	3
24	14.4	72	5	6	6	6	6	5	5	5	5	4	4	4	4	4	3
25	15.0	75	5	7	6	6	6	5	5	5	5	5	4	4	4	4	4
26	15.6	78	5	7	7	6	6	6	5	5	5	5	5	4	4	4	4
27	16.2	81	5	7	7	7	6	6	6	6	5	5	5	4	4	4	4
28	16.8	84	5	7	7	7	7	6	6	6	6	5	5	5	4	4	4
29	17.4	87	6	8	7	7	7	6	6	6	6	5	5	5	5	4	4
30	18.0	90	6	8	8	7	7	7	6	6	6	6	5	5	5	4	4
31	18.6	93	6	8	8	8	7	7	7	6	6	6	5	5	5	5	4
32	19.2	96	6	8	8	8	8	7	7	7	6	6	6	5	5	5	4
33	19.8	99	6	9	8	8	8	7	7	7	6	6	6	6	5	5	5
34	20.4	102	6	9	9	8	8	8	7	7	7	6	6	6	5	5	5
35	21.0	105	6	9	9	9	8	8	8	8	7	6	6	6	5	5	5
36	21.6	108	6	10	9	9	9	8	8	8	7	7	6	6	5	5	5
37	22.2	111	6	10	10	9	9	9	8	8	7	7	7	6	5	5	5
38	22.8	114	7	10	10	10	9	9	8	8	7	7	7	6	6	5	5
39	23.4	117	7	10	10	10	10	9	9	8	7	7	7	6	6	6	5
40	24.0	120	7	11	10	10	10	9	9	9	7	7	7	6	6	6	6
41	24.6	123	7	11	11	10	10	10	9	9	8	7	7	6	6	6	6
42	25.2	126	7	11	11	11	10	10	10	9	8	7	7	7	6	6	6
43	25.8	129	7	12	11	11	11	10	10	9	9	7	7	7	6	6	6
44	26.4	132	7	12	12	11	11	11	10	9	9	7	7	7	7	6	6
45	27.0	135	7	12	12	12	11	11	11	9	9	8	7	7	7	6	6
46	27.6	138	7	12	12	12	12	11	11	10	9	8	7	7	7	7	6
47	28.2	141	7	13	12	12	12	12	11	10	9	8	7	7	7	7	7
48	28.8	144	7	13	13	12	12	12	12	10	10	8	7	7	7	7	7
49	29.4	147	7	13	13	13	12	12	12	11	10	8	8	7	7	7	7
50	30.0	150	7	13	13	13	13	12	12	11	11	9	8	7	7	7	7

Note: First day take drug three times: one tablet after breakfast; two tablets after lunch; the rest of daily dosage may be taken in two or three divided doses.

Table 12. Antimony-273 Medium-Speed Tablet 10-Day Treatment Course and Dosage Table (total dosage 350 mg/kg body wt. Each tablet contains 200 mg antimony-273)

Body wt (kg)	Total dosage (g)	Total no. of tablets	Daily no. of tablets										
			1	2	3	4	5	6	7	8	9	10	
20	7.0	35	3	5	5	4	4	4	4	3	3	2	2
21	7.4	37	3	5	5	5	4	4	4	3	3	3	2
22	7.7	39	3	5	5	5	5	5	4	3	3	3	3
23	8.0	40	3	6	5	5	5	5	4	3	3	3	3
24	8.4	42	3	6	6	5	5	5	5	3	3	3	3
25	8.8	44	3	6	6	6	6	5	5	4	3	3	3
26	9.1	46	3	6	6	6	6	6	5	4	4	3	3
27	9.4	47	3	6	6	6	6	6	6	4	4	3	3
28	9.8	49	3	7	6	6	6	6	6	5	4	3	3
29	10.2	51	3	7	7	6	6	6	6	5	4	4	3
30	10.5	53	3	7	7	7	7	6	6	5	5	4	3
31	10.8	54	3	7	7	7	7	7	6	5	5	4	3
32	11.2	56	3	8	7	7	7	7	6	5	5	4	4
33	11.6	58	3	8	8	7	7	7	6	5	5	5	4
34	11.9	60	3	9	8	8	8	7	6	5	5	5	4
35	12.2	61	3	9	8	8	8	7	6	5	5	5	5
36	12.6	63	3	9	9	8	8	7	6	6	5	5	5
37	13.0	65	3	9	9	9	9	7	6	6	6	5	5
38	13.3	67	3	10	10	9	9	7	6	6	6	5	5
39	13.6	68	3	10	10	10	10	7	6	6	6	5	5
40	14.0	70	3	10	10	10	10	8	7	6	6	5	5
41	14.4	72	3	10	11	10	10	8	7	6	6	6	5
42	14.7	74	3	10	11	10	10	9	8	6	6	6	5
43	15.0	75	3	10	11	10	10	9	8	7	6	6	5
44	15.4	77	3	10	11	11	11	9	8	7	7	6	5
45	15.8	79	3	10	11	11	11	10	8	7	7	6	6
46	16.1	81	3	10	12	11	11	10	8	8	7	6	6
47	16.4	82	3	10	12	11	11	11	8	8	7	6	6
48	16.8	84	3	10	12	12	12	11	9	8	7	6	6
49	17.2	86	3	10	12	12	12	12	9	8	7	7	6
50	17.5	88	3	10	12	12	12	12	10	8	8	7	6

Note: First day take drug three times; after breakfast take the adaptation tablet of the second dose; after lunch take one medium-speed tablet; after supper take two medium-speed tablets. Thereafter the daily dosage may be taken in two to three divided doses.

Table 13. Antimony-273 Medium-Speed Tablet 15-Day Treatment Course and Dosage Table (total dosage 400 mg/kg body wt. Each tablet contains antimony-273 200 mg)

Body wt (kg)	Total dosage (g)	Total no. tabs	Daily no. of tablets														
			1	2	3	4	5	6	7	8	9	10	11	12	13	14	15
20	8.0	40	3	4	4	4	3	3	3	2	2	2	2	2	2	2	
21	8.4	42	3	4	4	4	4	3	3	3	2	2	2	2	2	2	
22	8.8	44	3	4	4	4	4	4	3	3	3	2	2	2	2	2	
23	9.2	46	3	4	4	4	4	4	4	3	3	3	2	2	2	2	
24	9.6	48	3	4	4	4	4	4	4	4	3	3	3	2	2	2	
25	10.0	50	3	5	4	4	4	4	4	4	4	3	3	2	2	2	
26	10.4	52	3	5	5	4	4	4	4	4	4	3	3	3	2	2	
27	10.8	54	3	5	5	5	4	4	4	4	4	3	3	3	3	2	
28	11.2	56	3	5	5	5	5	4	4	4	4	4	3	3	3	2	
29	11.6	58	3	5	5	5	5	5	4	4	4	4	4	3	3	2	
30	12.0	60	3	5	5	5	5	5	5	4	4	4	4	3	3	3	
31	12.4	62	3	6	5	5	5	5	5	4	4	4	4	3	3	3	
32	12.8	64	3	6	6	5	5	5	5	5	4	4	4	3	3	3	
33	13.2	66	3	6	6	6	5	5	5	5	4	4	4	4	3	3	
34	13.6	68	3	6	6	6	6	5	5	5	4	4	4	4	4	3	
35	14.0	70	3	6	6	6	6	6	5	5	5	4	4	4	4	3	
36	14.4	72	3	6	6	6	6	6	6	5	5	5	4	4	4	3	
37	14.8	74	3	7	6	6	6	6	6	5	5	5	4	4	4	3	
38	15.2	76	3	7	7	6	6	6	6	5	5	5	4	4	4	4	
39	15.6	78	3	7	7	7	6	6	6	5	5	5	5	4	4	4	
40	16.0	80	3	8	7	7	7	6	6	5	5	5	5	4	4	4	
41	16.4	82	3	8	8	7	7	7	6	5	5	5	5	4	4	4	
42	16.8	84	3	8	8	7	7	7	7	6	5	5	5	4	4	4	
43	17.2	86	3	8	8	8	7	7	7	6	5	5	5	5	4	4	
44	17.6	88	3	8	8	8	8	7	7	7	5	5	5	5	4	4	
45	18.0	90	3	8	8	8	8	8	7	7	6	5	5	5	4	4	
46	18.4	92	3	9	8	8	8	8	7	7	6	5	5	5	5	4	
47	18.8	94	3	9	9	8	8	8	8	7	6	5	5	5	5	4	
48	19.2	96	3	9	9	8	8	8	8	8	6	6	5	5	5	4	
49	19.6	98	3	9	9	9	8	8	8	8	6	6	6	5	5	4	
50	20.0	100	3	9	9	9	9	8	8	8	6	6	6	5	5	4	

Note: First day take drug three times; after breakfast take the second dose of the adaptation tablet; after lunch take one medium-speed tablet; after supper take two medium-speed tablets. Thereafter the daily dosage may be taken in two to three divided doses.

Medication. The tablets may be ingested daily in two to three divided doses, taken with warm water 2 hours after meals. When the tablets are taken twice daily, they usually are taken after breakfast and after supper. On principle, one or two more tablets may be taken after supper. "Adaptation method" is used at the beginning of treatment; i.e., first take a very small amount of "stimulation dosage" (use adaptation tablets); then gradually increase, taking medium-speed tablets or delayed-dissolving tablets, so that the gastrointestinal tract can adapt gradually to antimony-273. This method will cause fewer gastrointestinal reactions than if the total dosage is given all at once.

In using delayed-dissolving tablets for treatment, usually adaptation tablets are given once: 20 mg just before bedtime (3 hours after supper) the night before treatment is begun. In using medium-speed tablets adaptation tablets are given twice: once just before bedtime (3 hours after supper), 20 mg, and once the next morning 3 hours after breakfast, 40 mg. Adaptation tablets should be taken with an empty stomach; only a small amount of water (1 tablespoon) may be used to wash them down. No water or food should be taken within 1½ hours, so that the drug can reach a certain concentration necessary to stimulate the gastrointestinal tract, accomplishing the purpose of adaptation. In children it is better to give adaptation tablets three times in doses of 10, 20, and 40 mg. After taking adaptation tablets, the medium-speed tablets or delayed-dissolving tablets should be gradually increased with each medication starting with one tablet, but the speed of increase should not exceed the order of 1, 2, 4 tablets. At this time the amount of water taken is not limited. The daily dosage should be flexibly managed based on the reaction of the patient. With more severe reactions, the daily dosage should be decreased or the drug stopped for observation.

4. Prevention and Management of Reactions

a. After taking antimony-273, the antimony content in the liver is rather high; therefore during the course of treatment, changes in the liver should be watched for. In a few patients, after taking the drug there may be a slight degree of liver enlargement and tenderness; the SGPT (sodium glutamate-pyruvate transaminase) becomes elevated. If the general condition is good, if there is no markedly decreased appetite, and if

the liver enlargement and tenderness do not gradually increase in severity, then the drug may be continued under strict observations. If there are also nausea, vomiting, markedly decreased appetite, and general lassitude, and if liver enlargement and tenderness continue to increase in severity, especially with the appearance of jaundice and toxic hepatitis, then the drug should immediately be discontinued, and active measures be taken for management (refer to section on antimony toxic hepatitis).

b. Antimony-273 is to a degree also toxic to the heart; it may cause cardiac arrhythmia, tachycardia, or bradycardia. If poorly managed, it also could cause a disturbed heart rate, including Adam-Stokes syndrome. The prevention and management are the same as for the disturbed heart rate caused by tartar emetic. During treatment the electrographic changes include flattening of T-wave, or in a few cases, inversion of T-wave. These changes will disappear after cessation of the drug.

c. Other reactions are same as tartar emetic.

5. Precautions During Treatment.

a. During the course of treatment, medical personnel must make close observations and careful examinations. The patient must also be persuaded to report his feelings and condition accurately and cooperate closely with the medical personnel to help in conquering the disease.

b. During the course of treatment, frequent attention should be given to liver enlargement and tenderness. Examinations should be made two to three times. If the patient himself notices abdominal distension, marked decrease of appetite, lassitude, or pain over the liver area, then he must be examined quickly, and active measures instituted.

c. During the period of medication and within 7 days of conclusion do not take wine, do not eat large amounts of fatty food (such as fat meat), and do not take part in heavy labor or work on a high elevation or on water.

d. Other precautions are the same as for 20-day tartar emetic treatment.

6. Followup.

Elimination of antimony-273 is rather slow. Even when medication is concluded, there is still in the body a comparatively large amount of the drug which still has certain effects on the body. If care is not taken, there still may be cardiac or hepatic toxic reactions. Medical personnel and the patient must watch for such reactions. A complete physical examination must be given at the conclusion of medication, and rest for 2 to 3 days at the treatment center should be advised. Within 1 to 2 days after patients return home, medical personnel should make home visits. If reactions or abnormal conditions are found during examination, they should be taken care of immediately. Within 7 days of cessation of medication, there should be no heavy labor, and attention should be paid to rest and nutrition so that early recovery may take place.

C. Furapromidum (F30066)

Clinical use for many years has proven that furapromidum is markedly effective in patients with acute schistosomiasis or chronic recent schistosomiasis with reinfection and fever. Usually after the drug is taken for 5 to 7 days, the temperature will drop below 38°C ; after 10 days it usually will be normal. With the lowering of temperature, general symptoms such as diarrhea and night sweating will also be markedly improved. The improvement of these symptoms establishes good conditions for worm destruction and treatment.

1. Indications

Mainly indicated for patients with acute schistosomiasis with fever or chronic reinfections with fever. In recent schistosomiasis with fever, if there is no jaundice or ascites and the liver function is fair, it may be taken under strict observations.

2. Dosage and Treatment Course

The daily oral dosage is calculated on a basis of 60 mg (40 to 70 mg) per kg of body weight; in adults, 2 to 4 g per day divided into four doses.

To decrease alimentary tract reactions, adaptation dosage may be given in the early stages, such as 1 g for the first day (0.25, four times a day); 2 g for the second day (0.5, four times a day); increase to 3 g (0.75, four times a day) on the third day if there is no severe abdominal pain, diarrhea, etc. The course of treatment is 2 weeks; in severe infections it may be extended to 3 weeks.

3. Side Reactions and Management

This drug has a low toxicity, and the recommended dosage does not appear to cause damage to the heart or liver. The main reactions are nausea, vomiting, abdominal pain, diarrhea, and paroxysmal muscular spasm. Presently used are intestinal melting delayed-dissolving tablets (each tablet 0.125 g). Vomiting is very rare. Tincture of belladonna or tincture of camphor compound may be given for abdominal pain and diarrhea; after 3 to 5 days the symptoms will decrease. Calcium tablets or sedatives may be given for muscular spasms. In patients with hepatitis, liver cirrhosis, or recent schistosomiasis with marked impairment of liver function who take the drug, there may be neuropsychiatric disturbances, manifested by loss of memory, excitement, and polyphrasia. Abnormal behavior, mania, and somnolence accompanied by hyperreactive tendon reflexes or tremor of the extremities may occur. In a small number of patients with acute schistosomiasis who are in poor general condition, the above reactions may also occur. If mental abnormality occurs, the drug should be stopped; and intravenous glucose or glucose in saline with sodium glutamate may be given. Sedatives may be given to patients with mania. Most of the symptoms will quickly abate and disappear without consequence.

4. Contraindications

The drug should not be given to patients with a history of peptic ulcer bleeding, psychotic diseases, nephritis and liver cirrhosis with previous jaundice, ascites, or impaired liver function.

5. Precautions

This drug is rapidly destroyed in the body, the blood level is low, and the usual dosage is not satisfactory as an anthelmintic. After the patient's symptoms have markedly improved and the temperature approaches normal, antimony drugs or antischistosome-846 should be used as anthelmintics for treatment.

IV. Potassium Antimony Tartrate (Tartar Emetic)

Properly selected treatment objectives, basing suitable dosage and treatment course on the patient's physical condition and age, constitute an important measure in successful treatment with tartar emetic.

A. Methods of Tartar Emetic Treatment

1. Three-day Treatment

Tartar emetic 3-day treatment is a method created by the people themselves. It affects production comparatively little; is to a certain degree effective; and is fast, good, and inexpensive in the elimination of schistosomiasis. Reactions are generally severe in 3-day treatment. We must strictly observe and manage patients' reactions. This method may be used to treat the following patients:

a. Those with chronic schistosomiasis who are in fair general health without marked anemia or nutritional disturbances.

b. Patients without history of jaundice, hepatitis, hematemesis, or ascites; without signs of hepatic cirrhosis (such as enlarged spleen, telangiectasia, gynecomastia, edema of lower extremities, etc.); without cardiovascular diseases, nephritis, or other associated severe diseases; and with normal appetite and ability to work.

c. Women who are not menstruating.

d. Women who have breast fed for over 10 months and who are physically in good condition.

The dosage and treatment course is shown in Table 14. The total dosage is calculated on the basis of 12 mg/kg body weight. This dosage is divided into six to seven injections, one injection in the morning and one in the afternoon. Each injection should not exceed 0.1 g (10 ml 1% tartar emetic). The highest total dosage is 0.7 g given over 3 to 4 days. The interval between morning and afternoon injections should not be less than 5 hours. After injection, 2 hours of rest in bed are mandatory. In older, physically weak, and female patients, if the body weight is above 50 kg, the total dosage should be calculated on the basis of 50 kg; and the total dosage may be divided into seven injections.

Long-course Treatment

Experience of many years proves that long-course treatment has the advantage of giving comparatively good results with less severe reactions. Tartar emetic long-course treatment or tartar emetic small-dose, long-course treatment may be used to treat many poor and peasant class persons who are heavily infected or are physically weak and cannot take the short-course tartar emetic treatment but who urgently need it. But it should be noted that the long-course treatment is of extensive duration, the total dosage large, and therefore complications such as disturbed heart rate and toxic hepatitis not less severe than in 3-day treatment. Medical personnel must be able to discover reactions early and give immediate treatment.

Tartar emetic 20-day treatment is mainly indicated for severe infections (such as marked liver and spleen enlargement, poor development or granuloma of the colon, etc.), in young people or in children with chronic, recent schistosomiasis (without history of hepatitis, ascites, hematemesis). The treatment may also be used in patients with chronic schistosomiasis who were not cured after repeated treatments and those with acute schistosomiasis who had fever lowered with furapromidum, if their general health is good.

Table 14. Tartar Emetic Dosage Distribution Table in
3-Day Treatment for Chronic Schistosomiasis

Body wt (kg)	Total dosage (ml) (1% sol)	Injection No.						
		1	2	3	4	5	6	7
		No. ml per dose (1% sol)						
15	18	3	3	3	3	3	3	
16	19	3	4	3	3	3	3	
17	20	3	4	4	3	3	3	
18	21	3	4	4	4	3	3	
19	23	4	4	4	4	4	3	
20	24	4	4	4	4	4	4	
21	25	4	5	4	4	4	4	
22	26	4	5	5	4	4	4	
23	27	4	5	5	5	4	4	
24	29	5	5	5	5	5	4	
25	30	5	5	5	5	5	5	
26	31	5	6	5	5	5	5	
27	32	5	6	5	5	5	5	
28	33	5	6	6	6	5	5	
29	35	6	6	6	6	6	5	
30	36	6	6	6	6	6	6	
31	37	6	7	6	6	6	6	
32	38	6	7	7	6	6	6	
33	39	6	7	7	7	6	6	
34	41	7	7	7	7	7	6	
35	42	7	7	7	7	7	7	
36	43	7	8	7	7	7	7	
37	44	7	8	8	7	7	7	
38	45	7	8	8	8	7	7	
39	47	8	8	8	8	8	7	
40	48	8	8	8	8	8	8	
41	49	8	9	8	8	8	8	
42	50	8	9	9	8	8	8	
43	52	9	9	9	9	8	8	
44	53	9	9	9	9	9	8	
45	54	9	9	9	9	9	9	
46	55	9	10	9	9	9	9	
47	56	9	10	10	9	9	9	
48	58	10	10	10	10	9	9	
49	59	10	10	10	10	10	9	
50	60	10	10	10	10	10	10	
51	61	10	10	10	10	10	6	5
52	62	10	10	10	10	10	7	5
53	64	10	10	10	10	10	8	6
54	65	10	10	10	10	10	10	5
55	66	10	10	10	10	10	10	6
56	67	10	10	10	10	10	10	7
57	68	10	10	10	10	10	10	8
58	69	10	10	10	10	10	10	9
59	70	10	10	10	10	10	10	10
60	70	10	10	10	10	10	10	10

Small-dosage, tartar emetic long-course treatment is mainly indicated in the following:

a. Patients with acute schistosomiasis or chronic recent schistosomiasis with a history of reinfection, after fever is controlled by furapromidum or prednisone, and the physical state is still weak.

b. Those with chronic schistosomiasis after ascites has subsided or after splenectomy, if the appetite and general condition have improved and the liver function is fair.

c. Those in old age, weak, and poor physical condition.

d. Those with associated diseases after treatment of the disease and control of symptoms, if the general condition has already improved (refer to section on treatment of associated diseases).

e. Women 6-months pregnant, with no pregnancy complications. In women who have breast fed for 10 months and who are in good physical condition, treatment can usually be given. If arrangements can be made for the breast-fed baby and rest can be guaranteed, treatment may be given sooner.

Dosage and treatment course for the 20-day treatment (Table 15, Table 16) are calculated on a basis of 25 mg/kg of body weight, one injection per day (refer to dosage distribution table), total dosage not to exceed 1.4 g. In young healthy women and men in a weaker general condition or in patients with chronic schistosomiasis, calculate dosage on the basis of 24 mg/kg of body weight, the total dosage not to exceed 1.25 g.

When small-dosage, long-course tartar emetic treatment is used, depending on the general condition of the patient, severity of the associated diseases, age, and sex, calculate the total dosage on a basis of 22 to 24 mg/kg of body weight. If necessary the course may be prolonged to 22 to 24 days. Evenly divide the dosage, with the total dosage not exceeding 1.2 g. A "two ends larger and middle smaller" method of dosage distribution

Table 15. Tartar Emetic Dosage Distribution Table
in 20-Day Treatment (25 mg/kg body wt)

Body wt (kg)	Total dosage(ml) (1% sol)	Injection no.																			
		1	2	3	4	5	6	7	8	9	10	11	12	13	14	15	16	17	18	19	20
		No. ml per dose (1% sol)																			
20	50	3	3	3	3	3	3	3	3	3	3	2	2	2	2	2	2	2	2	2	2
21	53	4	4	3	3	3	3	3	3	2	2	2	2	2	2	2	2	2	3	3	3
22	55	4	4	4	3	3	3	3	3	3	2	2	2	2	2	2	2	2	3	3	3
23	58	4	4	4	4	4	3	3	3	3	2	2	2	2	2	2	2	3	3	3	3
24	60	4	4	4	4	4	4	3	3	3	2	2	2	2	2	2	3	3	3	3	3
25	63	4	4	4	4	4	4	4	4	3	2	2	2	2	2	3	3	3	3	3	3
26	65	4	4	4	4	4	4	4	3	3	2	2	3	3	3	3	3	3	3	3	3
27	68	4	4	4	4	4	4	4	4	4	3	3	3	3	3	3	3	3	3	3	3
28	70	4	5	4	4	4	4	4	4	4	3	3	3	3	3	3	3	3	3	3	3
29	73	5	5	4	4	4	4	4	4	4	3	3	3	3	3	3	3	3	3	4	4
30	75	5	5	5	4	4	4	4	4	4	3	3	3	3	3	3	3	3	4	4	4
31	78	5	5	5	5	4	4	4	4	4	4	3	3	3	3	3	3	4	4	4	4
32	80	5	5	5	5	5	4	4	4	4	4	3	3	3	3	3	4	4	4	4	4
33	83	5	5	5	5	5	5	5	4	4	4	3	3	3	3	4	4	4	4	4	4
34	85	5	6	5	5	5	5	5	5	4	3	3	3	3	4	4	4	4	4	4	4
35	88	6	6	6	5	5	5	5	5	5	3	3	3	3	4	4	4	4	4	4	4
36	90	6	6	6	6	5	5	5	5	5	3	3	3	4	4	4	4	4	4	4	4
37	93	6	6	6	6	6	5	5	5	4	4	4	4	4	4	4	4	4	4	4	4
38	95	6	6	6	6	6	5	5	5	5	4	4	4	4	4	4	4	4	4	4	5
39	98	6	6	6	6	6	6	5	5	5	4	4	4	4	4	4	4	4	5	5	5
40	100	6	6	6	6	6	6	5	5	5	4	4	4	4	4	4	5	5	5	5	5
41	103	6	6	6	6	6	6	5	5	5	4	4	4	5	5	5	5	5	5	5	5
42	105	7	7	6	6	6	6	5	5	5	4	4	4	5	5	5	5	5	5	5	5
43	108	7	7	7	6	6	6	6	5	5	4	4	5	5	5	5	5	5	5	5	5
44	110	7	7	7	6	6	6	6	6	6	4	4	5	5	5	5	5	5	5	5	5
45	113	7	7	7	7	6	6	6	6	6	5	5	5	5	5	5	5	5	5	5	5
46	115	7	7	7	7	7	6	6	6	6	5	5	5	5	5	5	5	5	5	5	6
47	118	7	7	7	7	7	7	6	6	6	5	5	5	5	5	5	5	5	6	6	6
48	120	7	7	7	7	7	7	6	6	6	5	5	5	5	5	5	6	6	6	6	6
49	123	7	7	7	7	7	7	7	7	6	6	5	5	5	5	6	6	6	6	6	6
50	125	7	7	7	7	7	7	7	7	6	6	5	5	5	6	6	6	6	6	6	6
51	128	7	7	7	7	7	7	7	7	6	5	6	6	6	6	6	6	6	6	6	6
52	130	8	8	7	7	7	7	7	7	6	5	6	6	6	6	6	6	6	6	6	6
53	133	8	8	8	8	7	7	7	7	7	6	6	6	6	6	6	6	6	6	6	6
54	135	8	8	8	8	8	7	7	7	7	6	6	6	6	6	6	6	6	6	6	7
55	138	8	8	8	8	8	8	8	7	7	7	6	6	6	6	6	6	6	6	6	7
56	140	8	8	8	8	8	8	8	8	7	7	7	6	6	6	6	6	6	6	6	7

Table 16. Tartar Emetic Dosage Distribution Table
in 20-Day Treatment (24 mg/kg body wt)

Body wt (kg)	Total dosage (ml) (1% sol)	Injection no.																			
		1	2	3	4	5	6	7	8	9	10	11	12	13	14	15	16	17	18	19	20
		No. ml per dose (1% sol)																			
30	72	5	5	4	4	4	4	4	4	4	4	3	3	3	3	3	3	3	3	3	3
31	74	5	5	5	4	4	4	4	4	4	3	3	3	3	3	3	3	3	3	4	4
32	77	5	5	5	5	4	4	4	4	4	3	3	3	3	3	3	3	4	4	4	4
33	79	5	5	5	5	5	4	4	4	4	4	3	3	3	3	3	3	4	4	4	4
34	82	5	5	5	5	5	5	5	4	4	4	3	3	3	3	3	4	4	4	4	4
35	84	5	5	5	5	5	5	5	5	4	4	3	3	3	3	4	4	4	4	4	4
36	86	5	5	5	5	5	5	5	5	5	4	4	3	3	3	4	4	4	4	4	4
37	89	6	6	6	5	5	5	5	5	5	4	3	3	3	4	4	4	4	4	4	4
38	91	6	6	6	6	5	5	5	5	5	3	3	4	4	4	4	4	4	4	4	4
39	94	6	6	6	6	5	5	5	5	5	4	4	4	4	4	4	4	4	4	4	5
40	96	6	6	6	6	6	5	5	5	5	5	4	4	4	4	4	4	4	4	4	5
41	98	6	6	6	6	6	6	5	5	5	4	4	4	4	4	4	4	4	5	5	5
42	101	6	6	6	6	6	6	5	5	5	5	4	4	4	4	4	5	5	5	5	5
43	103	6	6	6	6	6	6	5	5	5	4	4	4	5	5	5	5	5	5	5	5
44	106	6	6	6	6	6	6	6	6	6	5	4	4	4	5	5	5	5	5	5	5
45	108	6	6	6	6	6	6	6	6	6	6	4	4	5	5	5	5	5	5	5	5
46	110	6	6	6	6	6	6	6	6	6	6	5	5	5	5	5	5	5	5	5	5
47	113	7	6	6	6	6	6	6	6	6	6	5	5	5	5	5	5	5	5	6	6
48	115	7	7	7	6	6	6	6	6	6	6	5	5	5	5	5	5	5	5	6	6
49	118	7	7	7	6	6	6	6	6	6	6	5	5	5	5	5	6	6	6	6	6
50	120	7	7	7	7	7	6	6	6	6	6	5	5	5	5	5	6	6	6	6	6
51	122	7	7	7	7	7	6	6	6	6	6	5	5	5	6	6	6	6	6	6	6
52	125	7	7	7	7	7	7	6	6	6	6	5	6	6	6	6	6	6	6	6	6
53	127	7	7	7	7	7	7	7	6	6	6	6	6	6	6	6	6	6	6	6	6
54	130	8	8	7	7	7	7	7	7	6	6	6	6	6	6	6	6	6	6	6	6

in long-course treatment may be used; i.e., the 1st to 9th injections and the 16th to 20th injections may be slightly larger, and the 10th to 15th injections slightly smaller, so as to decrease alimentary tract reactions. But on principle the difference between the larger and smaller dosages should not exceed 1 to 2 ml. In small-dosage, long-course treatment, because of the weakness of the patients who may not tolerate drug reactions, the doses may be evenly divided; or the doses of the 1st to 10th injections may be slightly larger and the doses after the 11th injection slightly smaller. It is safer not to exceed 6 ml per injection in the male and 5 ml in the female.

B. Precautions During Tartar Emetic Treatment; Prevention and Treatment of Toxic Reactions

1. Precautions

a. Take body temperature once in the morning and afternoon (before injections). The temperature should be taken more frequently if there has been fever.

b. Before injection, detailed inquiries should be made about reactions and amount of food taken; attention should be paid to general subjective symptoms, mental state, thoughts, and mood; examinations should be made of the heart rate and rhythm, the sclera, change of liver size, and possible tenderness.

c. Before use, the ampules should be inspected for sedimentations or change of quality. If the broken ampule has been open too long, it should not be used.

d. In 3-day treatment, the first injection especially should be given slowly, to avoid spastic coughing that could increase fear in the patient.

e. Before each injection, the name of the patient and the dosage should be checked. After injection, proper records must be kept.

f. In long-course treatment, body weight should be checked during the middle stage of treatment and the total tartar emetic dosage corrected according to the change of weight.

g. If menstruation occurs during the late stage of treatment, injections may be stopped for 1 to 2 days.

h. After completion of treatment the patient should rest and be observed for 2 to 3 days before discharge. Those with severe reactions should continue to be hospitalized for observations. Rest should be taken after discharge from the hospital, and work gradually resumed.

2. Prevention and Treatment of Tartar Emetic Toxic Reactions

Experience has proved that if medical personnel have sympathy for and understand the patients, pay attention to the patients' rest, and are able to discover reactions in time, then severe tartar emetic reactions (arrhythmia, toxic hepatitis) can be prevented entirely. To prevent severe cardiac or hepatic toxic reactions, general reactions must first be taken care of, for the severity of reactions may mutually interchange; and if general reactions are not taken care of immediately, they frequently become severe. If severe reactions are taken care of in time and properly, they may turn into milder conditions.

3. General Reactions of Tartar Emetic and Treatment

a. Gastrointestinal reactions (nausea, vomiting, and anorexia) in 3-day treatment usually appear after the 4th or 5th injections; in 20-day treatment, after the 7th day and become more severe on the 9th to 14th days. If they are not treated immediately, they frequently become important factors leading to cardiac arrhythmia. Acupuncture of Tsu-san-li, Chung-kuan, or Nei-kuan may be performed; or oral atropine or belladonna and sedatives (librium, sodium phenobarbital, chlorpromazine) may be given. If these are ineffective, then atropine (0.5 mg i.m.) should be given. In patients with persistent vomiting, mental depression, and inability to take food, the tartar emetic should be discontinued and the patient observed.

Intravenous glucose or intravenous drip of 5% glucose in saline should be given. In patients with persistent vomiting accompanied by yellow sclera, enlarged liver, and liver tenderness, indications of toxic hepatitis, tartar emetic treatment should be discontinued, and powerful treatment given (see section on toxic hepatitis).

b. Cough is frequently seen during the first injection of 3-day treatment. In severe cases, there may be vomiting and mental strain. Decreasing the speed of injection can avoid or lessen the symptoms.

c. Auscultation of the heart should be carried out for 1 minute before injection to avoid tachycardia or bradycardia. If the heart rate increases to more than 100 beats per minute or decreases to below 45 beats per minute (reference should be made to age and rate before injection), discontinuing the drug should be considered. In the former case, give oral sedatives; in the latter, give atropine 0.3 to 0.6 mg, two to three times per day.

d. Appearance of extrasystoles during treatment is frequently a forerunner of cardiac arrhythmia; tartar emetic should be temporarily suspended. With frequent extrasystoles, atropine (0.5 mg) and sodium phenobarbital (0.1 g i.m.) should be given immediately, and further developments should be closely watched. If extrasystoles become less frequent, then oral atropine and sedatives may be given. If there are no changes, then atropine (0.5 mg i.m.) should be considered once every 3 to 4 hours; fluids should be administered; and tartar emetic treatment should be discontinued.

e. Fainting occurs in a very small number of patients in the early stage of treatment during injection of tartar emetic, along with sudden paleness, cold skin with sweating, bradycardia, and lowering of blood pressure. These symptoms are mostly seen in patients who are under a mental strain, afraid, or tired. The injection immediately should be stopped, the patient allowed to lie flat, and atropine (0.5 mg) and glucose given intravenously. All patients will quickly recover. After that the patient should be counseled, and further injections should be given with the patient

lying down. If fainting occurs during the late stage of treatment, the treatment should be discontinued.

f. Any cause of fever may increase the toxic reaction of tartar emetic. Therefore in patients with fever (above 37.5°C), tartar emetic injection must be temporarily suspended and the causes of fever quickly found and treated. If the fever is too high (above 39°C), it should be lowered with physiotherapy or medicine, and tartar emetic treatment discontinued. If the fever is accompanied by generalized skin rashes, such antihistaminic drugs as benedryl hydrochloride, phenergan, etc., may be given. With fever, and skin rashes accompanied by angioneurotic edema, oral prednisone (5-10 mg) may be given three times daily, and tartar emetic treatment temporarily suspended. When low-grade fever without special symptoms has subsided for 1 day, continuation of treatment may be considered.

g. Severe dizziness, thoracic constriction, fear and uneasiness, and spasms in wrists and feet are frequently observed during hot summer. Acupuncture of Nei-kuan, sodium phenobarbital (0.1 g i.m.), and intravenous drips of glucose in saline may be given; attention should be paid to electrolyte disturbances.

h. Other reactions including dizziness, headache, and soreness of joints may be treated symptomatically, such as by using new acupuncture methods, sedatives, and analgesics. With herpes zoster, gentian violet may be used locally and the lesion protected to prevent infection.

i. Leakage of tartar emetic may cause severe local pain and necrosis. Therefore, before injection the blood vessel should be fully exposed and prepared. If the patient complains of pain during injection, the injection should immediately be stopped and examinations made to see if the needle is in the vessel. If there is leakage, 10 ml of normal saline should be injected locally to dilute the drug, and Chinese herb medicine or 95% alcohol wet dressings applied. Acupuncture or 1% procaine local block also may be used. If redness, swelling, and suppuration occur, local hot wet dressings may be applied. Injection of pancreatin added to procaine into the pus cavity may help absorption.

j. In treatment, Chinese medicine may be used for local application. Take 2 drams of fresh glycyrrhiza ground into powder, stir into paste with hot water, put on gauze for local application, and fix with adhesives. After about 30 minutes, the pain may gradually decrease or disappear.

k. Another treatment is to use acupuncture points of Tien-ying (most painful spot), Ch'u-chih, Ho-ku. Keep the needle in place for 15 to 30 minutes (needles may be removed after pain disappears).

C. Prevention and Treatment of Severe Cardiac Arrhythmia Caused by Tartar Emetic Toxicity

When tartar emetic toxic arrhythmia occurs, it comes on very acutely. If medical personnel are not alert, materials not ready, and emergency treatment not in time, results may be serious. Therefore medical personnel must be fully aware of the symptoms to prevent and manage severe cardiac arrhythmia that may occur at any time.

1. Clinical Manifestations

Severe cardiac arrhythmia occurs chiefly during the late stage of treatment or within 48 hours after completion of treatment. The clinical manifestations are acute onset, paleness, fainting, spastic convulsions of the limbs, cessation of breathing, and cyanosis (the so-called Adam-Stokes syndrome). At the same time, auscultation of the heart shows cardiac arrhythmia (frequent extrasystoles, ventricular tachycardia), or weakening or disappearance of heart sounds (ventricular flutter and fibrillation). Even if all these symptoms and signs do not occur at the same time patients should be treated for severe toxic arrhythmia. Sometimes when medical personnel reach the scene, the cardiac rhythm may have returned to normal, but this condition should not rule out severe tartar emetic toxic arrhythmia. If diagnosed incorrectly as hysteria, epilepsy, or general fainting, the medical team may not give proper emergency treatment.

2. Preventive Measures

Prevention has always been a key principle in carrying out medical work. To eliminate severe toxic reactions, one must grasp the following two rules:

a. Before starting treatment, a thorough study of the condition should be made and a complete physical examination performed, so that the patient's condition is thoroughly understood and a suitable schedule of dosage and course planned.

b. During treatment, closely watch the occurrence and development of reactions; analyze and compare them daily; discover possible early hints of severe toxicity; and give treatment immediately. Attention should be paid to the appearance of various predisposing factors such as elevation of body temperature (complications of infection or physical factors in hot weather); comparatively severe alimentary tract reactions (frequent nausea, vomiting, and anorexia with resultant dehydration, decreased urine, and electrolyte imbalance); mental trauma or insufficient rest during the course of treatment. The rate of severe cardiac arrhythmia is much higher in females than males; this fact should be considered in the estimation of tartar emetic reactions.

For patients who had more severe reactions that may develop into severe cardiac arrhythmia and require suspension of tartar emetic injections, complete discontinuation of injections must be insisted upon. Atropine and glucose are not detoxication drugs for tartar emetic; therefore using atropine and glucose in order to continue tartar emetic injections frequently causes serious consequences. This point must be emphasized.

3. Method of Emergency Treatment

For patients who have developed severe cardiac arrhythmia, emergency treatment should be carried out on the spot. They should be separated from ordinary patients; avoid moving them if possible, and transfer the other patients so that emergency treatment can be efficiently carried

out. At the same time the mental state of other patients should be attended to in order to eliminate unnecessary worries on their part.

In the course of emergency treatment, medical personnel constantly must observe and control the changes of condition and predisposing factors in the course of the disease; look for, analyze, and solve contraindications. Flexible and changeable strategies and techniques must be used, and combined treatment measures should be adopted.

a. Atropine is comparatively safe in treating arrhythmia and is effective in most cases. It should be used first. It can remove the vagus effect on the heart, thus increasing the heart rate and controlling ventricular ectopic rhythm. When severe cardiac arrhythmia has occurred, 2.0 mg atropine should be administered intravenously; at the same time 1.0 mg should be given subcutaneously or intramuscularly to raise the heart rate to 100 to 200 beats per minute. In 30 minutes, give 1.0 mg intramuscularly. If there are no further attacks, based on the heart rate and rhythm, 1.0 mg may be given intramuscularly or subcutaneously every 1 to 3 hours. If there are no attacks after 48 hours, then the dosage may be decreased or the drugs stopped. The dosage of atropine should be flexible depending on the disease condition; generally it should be sufficient to maintain redness of the skin and a heart rate of about 100 to 120 beats per minute with a regular rhythm. If paleness, slowing of the heart rate, and arrhythmia reappear, 1 to 2 mg intravenously should be repeated. Generally atropine given intramuscularly or subcutaneously can maintain an increased heart rate for a longer period; intravenous injections usually can only maintain an increased rate for 20 to 60 minutes. Therefore it is better to use the maintenance dose by intramuscular or subcutaneous injections. After repeated use of atropine, there may be side reactions such as unrest, hallucinations, and even mania. These conditions should be controlled with intramuscular injections of sodium amytal, sodium phenobarbital, or chlorpromazine dilantin compounds. If the heart rate cannot be increased and cardiac arrhythmia continues to appear after the use of a certain amount of atropine, then the use of isoproterenol should be considered.

b. Isoproterenol can stimulate the sinoauricular node and auriculoventricular node and markedly increase the heart rate, thus controlling ventricular ectopic rhythm. The usual dosage is 0.5 to 1.0 mg added to 5% to 10% glucose solution (or glucose in saline) (500 ml) for slow intravenous drip (start with a few drops per minute and gradually increase) to raise the heart rate to 100 to 120 per minute and maintain a regular rhythm.

Precautions in the use of isoproterenol are:

i. During intravenous drip a person should be assigned to make close observations, record the heart rate and rhythm every 5 to 10 minutes, readjust the speed of the drip according to the heart rate and rhythm, carefully regulate the drip, and prevent the needle from slipping out of the vein.

ii. If there are still extrasystoles, the drops may be suitably increased to increase the heart rate to about 130 times per minute. If the rate still cannot be controlled, then predisposing causes (such as low potassium, fever, acidosis, mental excitement, etc.) should be carefully looked for and measures taken to quickly eliminate them. If the electrocardiogram indicates that it is a supraventricular cardiac arrhythmia, then isoproterenol may be discontinued and atropine still be used or other antiarrhythmia drugs added for use.

iii. After the arrhythmia has been under control for 24 hours, the speed of the drip may be gradually decreased until the heart rate approaches the normal level for 2 to 3 hours and the rhythm maintained regularly; then the drip may be discontinued.

iv. While isoproterenol increases the heart rate, at the same time it increases the force of myocardial contraction, myocardial energy consumption, and the burden on the heart. If the heart rate is increased too fast and for too long, there may be myocardial damage. Attention should be paid especially to older patients.

v. Possibly due to dilatation of renal vessels, this drug may cause polyuria and interfere with potassium ion reabsorption. A long period of drip infusion frequently causes low blood potassium. Consideration should be given to potassium replacement.

vi. This drug should not be dispensed with alkali drugs.

c. Other drugs that lower myocardial response can be prescribed under close observation if the arrhythmia still cannot be controlled after the use of atropine or isoproterenol. However, if there is conduction block or bradycardia, they are contraindicated or should be used with caution.

i. Dilantin can decrease the speed of conduction between myocardial fibers, can eliminate ectopic rhythm, and is frequently effective in controlling ventricular or supraventricular ectopic pulsation. The dosage is calculated on a basis of 3 to 5 mg/kg of body weight. In adults use 3 to 5 ml dilantin (5%) diluted with 20 ml of distilled water and slowly inject intravenously, completing the injection in 6 to 12 minutes. When effective, the heart rhythm returns to normal within 10 minutes after injection. Attention should be called to the fact that too fast an injection may cause cardiac and respiratory suppressions. If cardiac arrhythmia recurs, the above dosage may be repeated once more. The total dose in 1 day should not exceed 1.0 g.

ii. Lidocaine (Xylocaine) can decrease myocardial excitability and the speed of conduction and prolong the refractory period, thus suppressing ectopic rhythms. The dosage is 1 to 2 mg/kg of body weight, added to 20 ml glucose (5%) and slowly given intravenously. If it is effective, it can be repeated once in 20 minutes or be added to glucose (5%) for intravenous drip, giving 1 to 2 mg/minute. Within proper dosage, this drug will not cause a drop of blood pressure or suppression of cardiac function. It has a sedative action, so the dosage of sedatives and chlorpromazine drugs should be decreased.

iii. Preliminary clinical use shows bromobenzyl amide to be effective in ventricular extrasystoles, ventricular tachycardia, and ventricular fibrillation. The dosage is 3 to 5 mg/kg of body weight diluted

in 20 ml glucose (5%), taking about 10 minutes to slowly inject intravenously. It can be repeated once every 6 to 8 hours, not more three times a day. It also can be maintained with intramuscular injections (dilution not needed). With ventricular extrasystoles, 100 mg may be taken orally three times a day. Side reactions include temporary blood pressure elevation, nausea, and vomiting. If these symptoms occur, attention should be paid to hypostatic hypotension.

Experiences with the use of lidocaine and bromobenzyl amide are not numerous, so they should be used with care under close observation to record the results.

4. First Aid for Cardiac Arrest

Clinically if cardiac arrest (disappearance of pulse and heart sounds) occurs, minutes or seconds should not be wasted before giving extrathoracic cardiac massage. At the same time administer 0.5 mg isoproterenol intravenously (if an isoproterenol intravenous drip is being given, then the speed of the drip should be increased or 0.25 mg be added to the infusion) and 2 mg atropine.

A method of cardiac massage is as follows: Lower the head of the patient; insert a board under the shoulders and back (if it is a board bed, then a board need not be inserted). The medical attendant stands on either side of the patient, placing the overlapped hands over the lower part of the sternum, and steadily, speedily, and forcefully presses perpendicularly downwards, pushing the sternum down for about 3 to 4 cm. This motion is carried out about 60 to 80 times per minute. After pressing down each time, lift the wrists up quickly, so that the chest can fully expand. Another medical attendant may feel for the femoral pulse. If the cardiac massage is effective, the femoral pulse will be felt. If there is suppression of respiration, artificial respiration (mouth-to-mouth breathing) should be simultaneously carried out and oxygen inhalation given. For each four to five times of cardiac massage, the lungs should be blown into once. Cardiac massage and artificial respiration should be alternated (i.e., when air is blown into the patient's lungs, do not press on the chest). Simultaneous with artificial respiration, 5 mg lobelin or 1.5 g cytisine may be given

intravenously. If the patient does not respond immediately, give 0.5 mg of isoproterenol intravenously and continue cardiac massage. If still ineffective, 0.5 mg isoproterenol may again be given intravenously or intracardially; at the same time give 10 ml calcium chloride (5%) and 40 ml (1 M) sodium lactate intravenously. After the heart beat returns, continue to give isoproterenol intravenous drips.

Over the whole course of cardiac arrest, extrathoracic massage and mouth-to-mouth artificial respiration should be carried on without disruption. Cardiac massage should not be interrupted while carrying out other measures. Except when it happens for a very short time, cardiac arrest (complete arrest or ventricular fibrillation) will cause tissue anoxia and metabolic acidosis. In those with a comparatively long period of arrest or with repeated attacks, sodium bicarbonate should be given to correct acidosis (the first time give 100 ml sodium bicarbonate (5%) in a intravenous drip or 40 ml (1 M) sodium lactate through intravenous injection). The dosage of sodium bicarbonate should be increased in those with repeated attacks and prolonged cardiac arrest.

In patients with prolonged cardiac arrest and repeated attacks, if there are signs of cerebral edema such as deepening of unconsciousness, irregular breathing, and increased intracranial pressure, then dehydration treatment should be used.

5. Sedatives and Chlorpromazine Drugs

Sedatives and chlorpromazine drugs may calm the central nervous system, lower the tension of the vegetative nervous system, decrease external irritations that disturb the patient, and may possibly lower the excitability of the myocardium. They also can control such toxic reactions of atropine as mental excitement and mania (while using sedatives, attempts should be made simultaneously to search for the internal and external factors causing the unrest, and measures be taken to eliminate them). Frequently used sedatives are:

a. Amobarbital (amytal) (0.25 g) given intramuscularly once every 4 to 6 hours. Effective time is rather short.

b. Sodium phenobarbital (0.1 g) given intramuscularly once every 6 to 8 hours. Action is comparatively slow; effective time, comparatively long.

c. Chlorpromazine and promethazine (Wintermin and phenergan) (25 mg) each given intramuscularly once every 4 to 6 hours. When used for intravenous drips, attention should be paid to possible fall of blood pressure.

d. Dilantin (methidin) and promethazine (25 to 50 mg each) given intramuscularly. The action is fast; and the effective period, long. These drugs may be considered when other drugs cannot bring sedation but are contraindicated in old age and anoxia and in patients with signs of respiratory failure.

To rapidly calm a patient who is maniacal and restless, the following drugs may be used: 3 to 5 ml paraldehyde intramuscularly; 12.5 to 25 mg chlorpromazine diluted with 10 ml of distilled water to be given slowly intravenously; or 0.1 to 0.2 mg sodium amytal diluted in glucose solution to be given slowly intravenously. Both paraldehyde and sodium amytal given intravenously may cause suppression of respiration; they should not be used in patients with pulmonary and bronchial diseases or in older patients.

The main purpose of using sedatives and chlorpromazine drugs is to quiet the patient, but not too much. The injections should be given once every 3 to 4 hours based on the need (the dosage and time interval for medication varies with different patients and is determined by existing conditions). Several drugs may be used alternatively but should not be used simultaneously to avoid causing serious results such as suppression of respiration.

6. Supportive Treatment

a. Replacement of Fluid and Correction of Acidosis

Infusion of fluids can promote tartar emetic excretion, maintain fluid and electrolyte balance, supply nutrition, and relieve general toxic reactions; it also allows drugs to be given quickly intravenously. The daily infusion may include a total of 2000 to 3000 ml of glucose (5%) in normal saline, glucose solution (5%), or compound sodium chloride solution with a small amount of glucose solution (10%). If the urine is voluminous and renal function is normal, 4 to 6 g of potassium chloride should be added (if there is potassium deficiency the dosage may be increased depending on other conditions to about twice the amount). Hypertonic glucose and corticosteroids should be limited to avoid causing hypocalcemia. If acidosis is present sodium bicarbonate (5%) or sodium lactate (1 M) intravenous drip may be administered.

b. Quick-energy Medicine and Inosine

These substances can promote sugar metabolism and utilization, provide energy, and are beneficial in myocardial function recovery. They may be added to the infusion fluid, one to two times per day. In addition, vitamin B₁ and B compound may be given intramuscularly.

Prescription for quick-energy compounds:

10% glucose	500 ml
Regular insulin	8 U
Potassium chloride	1.0 g
Vitamin B ₆	50-100 mg
Adenosine triphosphate	20-40 mg
Coenzyme A	50 U
Hydrocortisone	25 mg

Administer 300 to 400 mg of inosine, intravenously, 1 to 2 times daily.

c. Oxygen

Oxygen inhalation should be provided when the heart has been arrested for a long period, with anoxia and cyanosis present.

7. Tartar Emetic Detoxication and Excretion

Sodium dimercaptosuccinate can promote tartar emetic excretion and is useful in preventing further damage to the heart. If severe toxic cardiac arrhythmia occurs soon after tartar emetic injection, its use may be considered. At first 2 g intravenously may be given slowly. Then give 1 g every 4 hours; this procedure may be repeated three to four times. This drug is in powder form. Before use it is dissolved in distilled water, normal saline, or 5% glucose solution and made into 5% to 10% solution, which is given slowly intravenously for 10 to 15 minutes. Rapid injection may cause dizziness, headache, and nausea. Other side reactions are skin rashes, lassitude, soreness of the limbs, etc. This drug is not very stable; it should not be heated; the solution should be freshly prepared. After dissolving it should be colorless or pink; if it is muddy yellow or turbid, it should not be used.

8. Predisposing Factors

Patients with repeated attacks of cardiac arrhythmia are frequently affected by many predisposing factors, which should be investigated and eliminated.

a. Fever is an important factor predisposing to cardiac arrhythmia. Antibiotics should be given if infection is present. High fever should be treated concomitantly by physical or pharmaceutical means to cause the body temperature to fall rapidly..

b. If repeated attacks of cardiac arrhythmia occur even after using drugs to combat arrhythmia, then the possibility of hypokalemia should be considered, and rapid correction accordingly carried out. If conditions permit, an electrocardiogram may be made to help in the diagnosis.

c. Other predisposing factors are: metabolic acidosis; nausea and vomiting; pharyngeal secretions causing obstruction; excitement and mania, or urinary retention caused by atropine; or external irritations such as catheterization, insertion of stomach tube, injection of irritating drugs, too frequent family visits, strong light, irritating noises, etc. These conditions should be corrected immediately. During overexcitement and mania, sedatives or chlorpromazine drugs should be increased. A retention catheter may be used in the case of urinary retention.

9. Observation and Nursing Care

An emergency treatment unit should be organized to take care of patients with severe toxic cardiac arrhythmia caused by tartar emetic treatment. The unit is responsible for nursing care and observation; a unit must be on post at all times, and properly carry out instructions during change of shift. The room should be kept quiet, all external stimulations should be avoided, and the family visits should be limited. In carrying out emergency treatment, medical personnel must be enthusiastic but calm, and their work must be intense but orderly. They must constantly discuss and analyze the situation. Various emergency treatment procedures must be instituted quickly, so that all procedures can be carried out simultaneously in good order. Close attention must be paid to the course of the condition, and to the examination of the heart rate and heart rhythm; various records must be kept. Listen to the heart frequently. Record in detail the fluid intake and output and the amount of electrolytes and calories supplied. Maintain free flow in one or two veins, so that life-saving drugs may be given under emergency conditions. Maintain oral, ocular, and nasal hygiene to prevent complicating infections. If the patient can eat, he should be given easily digested food in small quantities and frequently. Mentally clear patients should be encouraged to combat disease confidently.

During emergency treatment for these patients, adrenalin, digitalis, caffeine, and other drugs that may cause cardiac arrhythmia should be used with care.

Generally after the heart rhythm has been normal for 72 hours, special nursing care is not needed, but the patient still should be observed closely. The patient may be discharged only after his general condition has completely recovered for 10 days. Patients with repeated attacks should be hospitalized longer, and close followups carried out after discharge.

D. Prevention and Treatment of Tartar Emetic Toxic Hepatitis

1. Clinical Manifestations

Toxic hepatitis usually occurs during the late stage of treatment. The patient suffers from severe persistent nausea and vomiting, marked anorexia, lassitude, and yellow sclera. One or two days before the appearance of jaundice, chills, fever, and headache may be present. Physical examination may show hepatic enlargement or marked tenderness. If the above symptoms and signs are present even without jaundice, the case should be treated as toxic hepatitis. Severely affected patients may show increased jaundice, ascites, hepatic atrophy, generalized bleeding, delusion, coma, etc., which are signs of hepatic cellular failure.

2. Prevention

The occurrence of severe toxic hepatic damage due to tartar emetic usually occurs in patients with previous hepatic disease or poor hepatic function, or it may occur during tartar emetic treatment when severe alimentary tract reactions have taken place but injections not discontinued in time. It may also occur when the treatment course and dosage were not properly calculated, and the liver could not tolerate the treatment. Therefore to prevent severe reactions, the following precautions must be taken:

a. Before treatment, selection of treatment objectives must be conscientiously performed and treatment courses and drug dosage properly calculated. In selection of treatment objectives, attention should be paid to whether in the past or present there were symptoms of hepatitis such as jaundice, lassitude, anorexia, abdominal distension, nausea, edema,

fever, etc., or signs such as yellow sclera, telangiectasia, enlargement and tenderness of the liver and spleen, distended veins of the abdominal wall, ascites, edema, etc.

b. During treatment the patient must be watched for the appearance of severe or continuous nausea, vomiting, and marked anorexia; if these symptoms occur, discontinue injections, observe the patient, and institute active treatment.

3. Treatment Methods

If toxic hepatitis occurs, medical personnel must investigate and analyze changes of disease conditions and adopt a combination of treatment methods.

a. Immediately stop tartar emetic treatment.

b. If there is nausea and vomiting and medicine cannot be taken orally, then 1000 to 2000 ml of glucose solution (10%) should be given intravenously each day (appropriate amounts of potassium salt should be given). At the same time large amounts of compound vitamin B and vitamin C should also be administered. With severe vomiting and anorexia, glucose solution and compound sodium chloride solution alternately may be given intravenously.

c. If the condition is serious, with high fever and severe jaundice, corticosteroids such as hydrocortisone, dexamethasone, prednisone, etc., may be added. The dosage for prednisone is 20 to 60 mg per day orally for about 1 week. Hydrocortisone, 100 to 200 mg, may be given daily for intravenous drip. If necessary, quick-energy compounds or inosine may be added intravenously and vitamin B₁ intramuscularly.

Broad spectrum antibiotics (tetracycline, neomycin) can suppress intestinal bacteria and decrease the toxic effect of bacteria on the liver. They may also be beneficial in lowering the blood ammonia.

If there are indications of hepatic coma such as delusion, flapping tremor, hyperreactive tendon reflex, and amnesia, besides the above treatment the protein intake should be decreased; and 23 g sodium glutamate, 2 to 3 g α -aminobutyricum, or 20 g agrininum hydrochloride added to glucose solution (10%) for intravenous drip. Ammonium compounds are contraindicated, and sedatives should be carefully chosen. When bleeding tendencies are present, small amounts and frequent transfusions of fresh blood may be given with vitamin K and coagulants such as benzoicum, 6-aminocaproicum, etc.

d. When sodium dimercaptosuccinate combines with tartar emetic, excretion of tartar emetic is promoted, decreasing the damage of the liver. Use of this drug may be considered if toxic hepatitis occurs during the course of tartar emetic treatment or shortly after. Refer to the treatment of arrhythmia for method of administration.

V. Treatment of Several Frequently Encountered Concurrent Diseases of Schistosomiasis

A. Principles of Treatment

Concurrent diseases refer to the various acute or chronic diseases that are encountered simultaneously with schistosomiasis. Generally the chronic diseases most frequently encountered are neurasthenia, cardiac diseases, asthma, hepatitis, nephritis, arthritis, etc. Due to the double effects of schistosomiasis and the associated diseases, patients frequently are physically weak, do not tolerate drugs well, and can easily have toxic reactions during treatment. Therefore one must always remember: "Concrete analysis of concrete conditions" and adopt "Adaptable and changeable strategy and tactics."

1. Selection of Time for Treatment

Treatment should not be considered during acute concurrent diseases or during acute attacks of chronic concurrent diseases. Treatment should be given only after recovery or after the disease is under control.

2. Selection of Drug for Treatment

Selection of antischistosome drugs should be based on the nature of the associated disease. If diseases are neuropsychiatric, antimony drugs (including antimony-273) should be the treatment of choice. If the diseases are cardiovascular, antischistosome-846 should be the principle drug. In using tartar emetic, generally the small-dosage long-course method should be used, the dosage and course based on the body weight, sex, age, physical state, and condition of the concurrent disease. In patients in weak general condition, a course of recuperation and symptomatic treatment should be instituted; and treatment of schistosomiasis given after improvement.

B. Preliminary Suggestions in the Treatment of Several Concurrent Diseases Of Schistosomiasis

1. Neurological Diseases

Neurasthenia, delayed reaction to antischistosome-846, internal ear dizziness. In these diseases, tartar emetic 20-day treatment or small-dosage long-course treatment may be used. During treatment medical personnel should show more concern about the patients, have close heart-to-heart talks with them, and increase their confidence in overcoming their diseases.

Epilepsy and cerebral type of schistosomiasis. First give antiepilepsy treatment with such drugs as dilantin. When there are no attacks, tartar emetic 20-day treatment or small-dosage long-course treatment may be used. During treatment continue to give antiepilepsy drugs, and observe closely. Distinction must be made between epilepsy attacks and Adam-Stokes syndrome caused by tartar emetic.

Psychiatric diseases. Tartar emetic treatment may be given during an interval of no attacks. Long-course or short-course treatments may be chosen according to the existing condition of the patient. During treatment, the patient should be closely supervised.

2. Cardiovascular System

Hypertension. After treatment with hypotensive drugs and blood pressure maintained within 150/100 mm Hg, patient may be given tartar emetic 20-day treatment, small-dosage long-course treatment, and antischistosome-846. During treatment continue to use hypotensive drugs, and note any changes of blood pressure and in the heart. In hypertension complicated with cardiac diseases, if the condition has been stabilized, antischistosome-846 treatment may be considered. The patients with complications of renal and cerebral vascular disease should not be treated for the time being.

Abnormal cardiac rhythm. The most common symptom is extrasystole. These patients should be treated mainly with antischistosome-846. If there are no organic heart diseases and the extrasystoles are not frequent, tartar emetic long-course treatment may be considered. During treatment, dilantin or sedatives may be given orally, and close observations made of change of cardiac rhythm.

Organic heart diseases. With patients with rheumatic and congenital heart diseases, antischistosome-846 should be the main drug for treatment. When abnormal rhythm, active rheumatism, and myocarditis are not present and with good disease stabilization, tartar emetic small-dosage long-course treatment may also be considered. With cardiac failure, active rheumatism, or myocarditis, treatment should be postponed.

3. Respiratory System

Chronic bronchitis, bronchial asthma, pulmonary edema. If there have been no recent attacks or the symptoms are controlled after treatment, then tartar emetic 20-day treatment or small-dosage long-course

treatment may be used. Antischistosome-846 treatment may also be chosen. During treatment, attention should be paid to keep the patients warm and to prevent secondary respiratory infections. Patients with complications of marked insufficiency of cardiopulmonary functions and who have palpitation, dyspnea, and cyanosis after light work should be treated energetically. Treatment of schistosomiasis should be considered only after the symptoms have improved.

Pulmonary tuberculosis. In tuberculous patients without symptoms and in remission, (absorption stage and calcified stage), tartar emetic 20-day treatment may be used. At the same time, antituberculosis treatment should continue. Treatment should be postponed if pulmonary tuberculosis is active with overt symptoms or exudative pleurisy. In tuberculous patients it is better not to use antischistosome-846.

4. Alimentary System

Gastric pain and peptic ulcer. Active manifestations should be controlled by diet and treated symptomatically. Tartar emetic or antischistosome-846 treatment may be given after control of symptoms. During treatment any change of the disease condition should be noted, and proper treatment given immediately. Patients with a hemorrhage or perforation history within 6 months should have their treatment postponed.

Hepatitis. Patients with a definite history of hepatitis, but without symptoms and signs and with normal liver function for over a year, may be treated with tartar emetic small-dosage long-course method. Small-dosage long-course treatment may be considered in a patient with a history of acute hepatitis, but whose disease was mild and short, who is without symptoms and signs and with normal liver functions for 6 months, and who is young, strong, and takes part in heavy labor.

Bile duct ascariasis, cholecystitis, gallstones. If there are no attacks of these diseases, tartar emetic or antischistosome-846 treatment may be considered. To a patient with a history of bile duct ascariasis and whose stool examination reveals ascaris infestation, anthelmintics should be given before schistosomiasis treatment.

5. Urological System

Nephritis. Treatment should be postponed in acute nephritis. In patients with chronic nephritis without active symptoms, normal renal function and good general condition, tartar emetic small-dosage long-course treatment may be considered. During treatment frequent routine urinary examinations should be made and any change of the condition noted.

Urinary tract infection. With disappearance of symptoms, normal urinary routine, and good renal functions, tartar emetic 20-day treatment or small-dosage long-course treatment may be given.

6. Others

Arthritic pain, arthritis. When such conditions are stabilized, tartar emetic or antischistosome-846 treatment may be used. During treatment any existing conditions should be dealt with symptomatically.

Anemia. On the farm a frequent cause of anemia is hookworm disease. First, anthelmintics should be given, nutritious foods supplied, and iron taken orally. Treatment with tartar emetic or antischistosome-846 may be carried out after improvement of symptoms.

Acute infections. Schistosomiasis should not be treated during attacks of upper respiratory tract infection, pneumonia, dysentery, malaria, epidemic meningitis, typhoid fever, and other feverish diseases. Wait until these diseases are under control and the patients have recovered; then tartar emetic or antischistosome-846 treatment may be given.

In treating schistosomiasis patients with concurrent diseases, the patient's general condition should be the key to a treatment plan. General safety must be considered—on the one hand, the schistosomiasis should be treated; on the other hand attention should be paid to treatment of the other disease and improvement of the patient's general health. Therefore during treatment, medical personnel must serve the poor and peasant class wholeheartedly, enter the wards frequently, pay attention to the

patients, and examine and observe them closely. If the concurrent disease shows signs of further development, becomes more severe, or leads to acute attacks, then antischistosome treatment must be temporarily suspended or discontinued, and appropriate treatment be given immediately.

VI. Treatment of Acute Schistosomiasis

Acute schistosomiasis is seen mostly among inhabitants of noncontaminated areas who come into contact with infected water for the first time. It may also occur in patients with chronic schistosomiasis who become reinfected with a large number of schistosome cercariae. Clinically the severe symptoms and signs of high fever, enlarged liver, etc., are a combined result of the toxin of adult worms and ova and mechanical irritation that cause tissue damage and are also due to the lack of immunity. The incubation period for acute schistosomiasis is usually about 40 days. When symptoms of the acute stage occur, they usually correspond to the stage when the schistosomes are mature and laying ova in the portal system. The pathological basis for symptoms and signs is the formation of ova emboli abscesses in the organs.

A. Main Clinical Manifestations

Fever. Intermittent fever is most common and remittent fever next. Occasionally there may be continued or irregular fever.

Gastrointestinal tract. There may be abdominal distension, abdominal pain, diarrhea, and watery stools. In a few patients the stool may contain purulent bloody mucus.

Enlarged liver and spleen. Most patients have enlarged livers, more marked on the left lobe. The consistency is soft. There may be different degrees of tenderness and percussion pain. Some of the patients may have a slightly enlarged spleen. There may also be slight tenderness.

Others. In severely affected patients there may be paleness and loss of weight; in a few there may be edema and ascites.

Blood Picture. The most significant peripheral blood change is an increase of eosinophiles, usually between 15% and 30%; some may exceed 50%. In seriously ill patients if the eosinophiles are decreased, the resistance is very low.

Change of hepatic function. Serum globulin may show various degrees of elevation. The SGPT may be slightly elevated, but most are within normal limits.

B. Important Diagnostic Points

Contact. History of contact with infected water during the infectious season (especially in those who used to live in noninfectious areas).

Symptoms. Fever, enlarged liver, tenderness.

Blood picture. Percentage of eosinophiles markedly increased.

Positive stool hatching. Positive reaction of serum oval ring sedimentation test occurs rather early and may be used for early diagnosis.

Acute schistosomiasis should be distinguished from malaria, typhoid fever, liver abscess, septicemia, tuberculosis, etc.

C. Treatment

The principles of treatment for acute schistosomiasis are:

Improvement of symptoms. First control high fever and toxemia, and then improve the symptoms and general condition.

Treatment of pathogen. After improvement of general condition, select drugs to treat the pathogens, to accomplish the objective of a complete cure.

1. Mild Form of Acute Schistosomiasis

With low fever, no apparent toxemia, a short duration, and good general condition, furapromidum (F30066) should first be used. After a treatment regimen and when the body temperature has become normal, the stool hatching should turn negative. If not, use antischistosome-846 or tartar emetic small-dosage long-course treatment. Close observations must be carried out during the treatment.

2. Moderate Form of Acute Schistosomiasis

Moderate or high fevers, symptoms of general toxemia, poor general health, and liver enlargement with tenderness will be present. Generally furapromidum should be used first to lower the fever. If the patient cannot tolerate furapromidum, then the following may be done:

a. First use corticosteroids to lower the fever and alleviate the symptoms. Commonly used corticosteroids are ACTH, hydrocortisone, or prednisone. They are all effective. After the temperature is lowered and the symptoms are improved, then corticosteroids may be gradually decreased and furapromidum substituted. Corticosteroids should not be used for too long, and attention should be paid to secondary infections.

b. If low-grade fever persists after furapromidum is used, then aspirin or butazolidin may be added to lower the fever. In using antipyretics, attention should be paid to avoid excessive sweating leading to exhaustion. In using butazolidin, attention should be paid to the appearance of edema. After the body temperature returns to normal and there is general improvement, antischistosome-846 or tartar emetic small-dosage long-course treatment may be used to treat the pathogen.

3. Severe Form of Acute Schistosomiasis

Symptoms are high fever, with severe toxemia; marked wasting, anemia, malnutrition; or jaundice, ascites, etc. Active supportive measures such as maintaining adequate calories, fluids, electrolytes, and vitamins and blood transfusions should be taken. With high fever, hydrocortisone may be given daily intravenously. After improvement, oral furapromidum or prednisone may be given. After attaining normal body temperature and general recovery, antischistosome-846 or tartar emetic small-dosage long-course treatment may be used to treat the pathogen.

VII. The Treatment of Chronic Schistosomiasis

Chronic schistosomiasis mostly affects the poor and the peasants who have severe infections of long duration and are on the verge of losing their ability to work. Because of the complexity of the disease, medical personnel must use all means to analyze the disease and adopt a combined program of Chinese herb medicine, Chinese and Western medicine, and internal medicine and surgery.

A. Clinical Manifestations

Due to a difference in the duration of the disease and possible complications, the clinical manifestations of late schistosomiasis are not uniform. During the early stages, the patient may note enlargement, abdominal distension, soreness, weakness of loins and thighs, and a decreased ability to work. Some patients may also have diarrhea, purulent bloody stools, fever, etc. Frequent signs are enlargement of the liver (mainly of the left lobe), spleen, and visible veins on the abdominal wall. The enlarged spleen may reach the level of the umbilicus or below it. Frequently there are indentations; the consistency is hard and the surface, smooth (huge spleen type). In the late stage of the disease symptoms are anemia, ascites, hematemesis, and pain over the spleen (ascites type). In children frequently the symptoms are severe disturbance of growth and development (dwarfism type). Laboratory findings frequently show decrease of white blood cells (WBC) and platelets (hypersplenism) and change of liver function.

B. Differential Diagnosis

Chronic schistosomiasis is easily confused with necrotic or portal cirrhosis. The differences are: abdominal distension, lassitude, and anorexia are not as marked as in the other cirrhoses; the degree of splenic enlargement is more marked; telangiectasis, hepatic palm, and gynecomastia are rarely seen; liver damage is comparatively mild; SGPT is usually normal; serum albumin is frequently above 2.5 g percent. The disease may last from several years to more than 10 years, and a certain degree of labor capacity can be maintained.

Chronic schistosomiasis should be differentiated from carcinoma of the liver, tuberculous peritonitis, ovarian cysts, etc.

C. Methods of Treatment

Treatment of pathogen. Early treatment of the pathogen should be strived for in chronic schistosomiasis. Patients with huge spleens or dwarfism can usually stand tartar emetic long-course treatment. In patients with weak constitutions, hematemesis, and ascites, combined Chinese and Western medicine should be used to eliminate ascites. Surgery may be indicated to remove the spleen; and after general improvement, tartar emetic small-dosage long-course treatment may be given.

Symptomatic treatment. Ascites is a manifestation of hepatic cirrhosis and decompensation of liver function. Treatment should aim at improving the general condition, eliminating infections and complications, and maintaining the liver function. Intermittent use of diuretics to promote elimination of sodium and water is only one means of improving the symptoms.

1. Treatment with Chinese Medicine

The ascites of chronic schistosomiasis is similar to the "dropsy disease" described in Chinese medical literature before the Tang and Song dynasties. Through centuries of practice, it has been proved that

Chinese medicine has a certain degree of effectiveness. In addition, the source of medicine is abundant, and it can be obtained locally.

If ascites is properly diagnosed and classified, treatment can be effective. Clinically the disease may be divided into five types.

In the most common type although ascites is marked, the general condition is fair; mental state and appetite are good; there is no increase of urine; urine is clear and dilute; no marked abdominal distention is felt; edema of lower extremities is slight or nonexistent; tongue is slightly coated and white; and there is no change in pulse.

Treatment allows normal function of the spleen and kidney. Use some simple diuretic prescriptions or Chinese herb medicine.

Simple prescriptions and Chinese herb medicine are: plantago major, Lobelia radicans, Desmodium styracifolium, gourd, or mole cricket powder, etc. If there is no marked improvement after medication for half a month, change to ascites No. 1 prescription or ascites No. 2 prescription. "Wu-ling-san" is a patent powder medication; "Wei-ling-t'ang" is a stomach tonic brew (see appendix for listing of constituents contained in patent drugs).

In Yang hsu type of ascites (positive exhaustion), the patient appears pale or yellowish with edema, is tired and chilly, has cold limbs, and has watery or loose stools; the tongue is pale or thickened with the edge showing teeth marks and coated white but watery; the pulse is slightly weak or slow.

The purpose of the treatment is to warm "yang" and clear water. Use "Fu-kuli li-chung wan," a patent medicine pill containing aconitum and cinnamon that is used to restore constitutional balance (see appendix); "chin-kuli shen-chi wan," a patent medicine pill with kidney/energy restoring properties; "Wu-ling-san"; etc.

The ascites symptoms of the Yin hsu type (negative exhaustion) are: sloppy appearance; red cheeks and internal heat; dry mouth and throat;

hot palms and soles; easily excitable; constipated; scanty and red urine; poor intake and feeling of distension; shiny red tongue with little or scaly coating; thready and fast pulse.

The purpose of the treatment is to support "yin" and overcome exhaustion. Use Angelica sinensis blood tonic pill, "Ho-ch'e ta-tsu wan," a tonic pill; etc. (see appendix).

In the depressed fever type of ascites, the patient appears ashen; is mentally depressed; has dry mouth and bitter taste; has a restless fever and is thirsty; bleeds from gums and nose; has poor appetite, has tight and shiny abdominal skin; shows marked abdominal distension; has cloudy, yellow or red urine; has coarse or oily tongue coating; and has fleeting and fast pulse.

Treatment aims are to clear the fever and detoxify and clean the liver. Use Wan's bezoar "heart-clearing" pill to clear the fever and for detoxication; use "Hsiao-yu san" to clean the liver; use compound of powdered artemesia and "szu-ling" and artemesia brew for jaundice (see appendix).

The patient with exhaustion type has dried-up appearance, high cheeks and sunken eyes, muscle wasting, faulty nails, and scanty hair. He is very thin and looks like a skeleton; his appetite is normal or decreased; he is slow to answer questions; he has little bladder control; his tongue is shiny like a mirror or dried up; and his pulse is thready and weak or bounding and slow. There is also disappearance of body flesh.

The purpose of treatment is to improve respiration and blood. Use "Shih-ch'uan ta-pu wan," a 10-constituent tonic pill; "Pu-chung I-ch'i wan," a visceral tonic and energy-restoring pill; Hsiang-sha lu-chun wan," a patent compound; etc. (see appendix).

In patients with various types of ascites, the above simple diuretic prescriptions or Chinese herb medicines may be alternately used or added. Prescriptions that cause diarrhea to eliminate water, due to severe

gastrointestinal reactions, are only effective the first or second time given. At present they are rarely used.

2. Combined Treatment with Chinese and Western Medicine

a. Treatment Methods

Any patient who has received Chinese herb medicine for $\frac{1}{2}$ to $1\frac{1}{2}$ months or one or two regimens of Western diuretics without clear or effective results should be given a combination of Chinese and Western medicine immediately. Chinese medicines are used to support the normal and correct the abnormal functions, and Western diuretics are added. Increased excretion of water and sodium usually can be accomplished. Chinese medicine should be taken continually for a long period of time (refer to dialectic treatment) and Western diuretics should be given at an interval of every 7 to 14 days (refer to Western diuretics treatment).

b. Classification and Identification of the Disease (Dialectics)

In the common type, use of the Chinese herb medicine alone can usually cure the ascites. The prognosis is comparatively good. The Yang hgu type is usually complicated by hookworm disease or has a history of hemorrhage. With a history of hemorrhage, "warm" type of Chinese herb medicine should be used with care. During treatment if "San-ferg fa-wu wan," a patent medicine (see appendix), or iron are given simultaneously to improve the anemia, the ascites will usually subside. The prognosis is also good.

The Yin hsu and depressed fever types are usually complicated with postnecrotic or portal cirrhosis or other infections; liver function is poor. In the Yin hsu type, the ascites is more persistent; the course, comparatively long. In the depressed fever type, the condition is serious, development is fast, and the prognosis is poor. Western diuretics should be used with care. If Chinese medicine is used to support the "yin" and give replacements for exhaustion, wait until "yin" has improved; or give prescriptions to clear the fever, detoxify the toxin, and clean the liver; wait until the

depressed liver function has improved; then use Western diuretics. This method produces better results. Otherwise the treatment not only is ineffective, but may even induce hepatic coma.

In patients with exhaustion type, the presence of other malignant diseases should be ruled out; and combined Chinese and Western medicine treatment, adopted. Use Western medicine to help the liver; use Chinese medicine to help respiration and blood; give diuretics depending on the condition. These methods will cure the ascites.

APPENDIX: Prescription References

- a. *Plantago major*: Whole herb, dry 1 oz; fresh 3 oz; mixture.
- b. *Kochia scoparia*: Whole herb, dry 1 oz; mixture.
- c. *Lobelia radicans*: Whole herb, dry 1oz; fresh 3 oz; mixture.
- d. *Desmodium styracifoliam*: Whole herb, dry 1 oz; fresh, 3 oz; mixture.
- e. *Lycopus lucidus*, *Cucurbitacea*: Each 5 oz; mixture.
- f. Powdered mole cricket: Remove head, legs, wings; bake until brown and grind into powder; 2 dr per day divided into three doses; take with water.
- g. "Wu-ling san": Consists of *Atractylodes lancea*, *Pachyma cocos*, *Grifola umbellata*, *Alisma plantago*, cinnamon sticks.
- h. Ascites No. 1 prescription: *Kochia scoparia*, 5 dr; *Lycopus lucidus*, 3 dr; *Paeonia rubra*, 3 dr; *Plantago major* (wrapped), 5 dr; *Semen areca*, 3 dr; *Aralia papyrifera*, 5 dr; *Cynanchum cordatum*, 5 dr; peel of Chinese waxgourd *Benincasa hispida*, 1 oz; *Aristolochia debillis*, 1 dr; toasted *Poncirus trifoliata*, 1 dr; *Hemerocallis flava*, 2 dr; *Demodium styracifolium*, 1 oz; *Cucurbitaceae* 1 oz; *Pachyma cocos* peel, 3 dr; *Calamus* root, 2 dr;

Capsella bursa, 1 oz; *Akebia quinata*, 3 dr; *glycyrrhiza*, 0.5 dr; *Phaseolus angularis*, 1 oz.

i. Ascites No. 2 prescription: *Euphorbia helioscopia*, 5 dr; *Ardisia japonica*, 1 oz; *Elephantopus scaber*, 5 dr; *Campanumaea pilosula*, 1 oz; *Glechoma hederaceae*, 1 oz; *Hypericum japoicum*, 1 oz; *Pyrrhosia lingual*, 1 oz; *Lobelia radicans*, 1 oz; *Ajuga decumbens*, 1 oz; *Agrimonia pilosa*, 1 oz.

j. Cinnamon-Aconitum tonic pill: *Campanumaea pilosula*, *glycyrrhiza*, *Atractylodes lancea*, *Zingiber officinale*, *Aconitum fischeri*, *Cortex cinnamoni*.

k. Kidney/energy Pill: processed *Rehmannia glutinosa*, *Dioscorea japonica*, *Cornus officinalis*, bark of peony root, *Pachyma cocos*, *Alisma plantago*, *Aconitum fischeri*, *Cortex cinnamoni*.

l. *Angelica sinensis* blood-building pill: *Angelica sinensis*, *Astragalus hiroshimanus*, Horse glue, *Paeonia alba*, *Rehmannia glutinosa*, bark of peony root, *Atractylodes lancea*, *Pachyma cocos*, *Cyprus longus*, *Euonymus japonicus*.

m. "Ho-che ta-tso wan" (*Polygonum bistorta* compound pill): *Polygonum bistorta*, *Phellodendron*, *Achyranthes bidentata*, *Euonymus japonicus*, *Ophinopogon japonicus*, *Asparagus lucidus*, *Campanumaea pilosula*, Tortoise shell, *Pachyma cocos*, processed *Rehmannia glutinosa*.

n. Wan's bezoar heart-clearing pill: Bezoar, *Fructus gadeniae*, *Scutellaria baicalensis*, *Radix coptidis*, *Curcuma longa*, *Cinnabar*.

o. "Hsiao-yao san" relaxant compound: *Angelica sinensis*, *Paeonia alba*, *Atractylodes lancea*, *Pachyma cocos*, *Bupleurum falcatum*, *Folia mentha*, *glycyrrhiza*, *Zingiber officinale*.

p. *Artemesia* compound: *Artemesia*, *Atractylodes lancea*, *Pachyma cocos*, *Grifola umbellata*, *Aslisma plantago*.

q. *Artemesia brew*: *Artemesia*, *Fructus gardeniae*, rhubarb.

r. Ten-precious-ingredient pill: *Campanumaea pilosula*, *Atractylodes lancea*, *Pachyma cocos*, glycyrrhiza, *Rehmannia glutinosa*, *Angelica sinensis*, *Paeonia alba*, *Conioselinum univittatum*, *Astragalus hiroshimanus*, *Cortex cinnamomi*.

s. "Pu-chung I-chi'i wan": viscera Tonic and energy-restoring pill: *Campanumaea pilosula*, *Atractylodes lancea*, glycyrrhiza, *Aralia edulis*, *Astragalus hiroshimanus*, orange peel, *Cimicifuga foetida*, *Bupleurum falcatum*, fresh *Zingiber officinale*, Jujube.

t. "Hsiang-sha lu-chum wan" pill: *Campanumaea pilosula*, *Atractylodes lancea*, *Pachyma cocos*, *Pinellia tuberifera*, orange peel, *Amomum xanthioides*, *Aucklandin costus*, glycyrrhiza.

u. Stomach tonic: *Atractylis ovata*, *Magnolia hypoleuca*, orange peel, *Atractylodes lancea*, *Pachyma cocos*, *Grifola umbellata*, *Alisma plantago*, cinnamon sticks.

v. "San-feng Fa-mu wan": *Atractylodes japonica*, yeast, processed alum.

During treatment use prepared medicine and pills; take 1 to 2 dr twice daily; dissolve pills in boiling water or other mixtures to ingest.

3. Supportive Treatment

This treatment includes bedrest, a salt-free diet, better nutrition, such vitamins as compound vitamin B and C. For protection of the liver, use such drugs as glucose, vitamin B₁₂, proheparin, glucorone, inosine, etc., to promote metabolism. With jaundice and low-grade fever but no complications of infection, a short course of prednisone (20 to 30 mg/day) may be given. With complications of infection or concurrent diseases (such as septicemia, primary peritonitis, urinary tract infections, and other foci of pathological changes), antibiotics should be used vigorously to control infection. After general improvement and control of infection,

the ascites can frequently be stabilized, and the use of diuretics will be highly effective.

4. Treatment with Diuretics

Whether diuretics will be effective depends on the degree of improvement of liver function. In the ordinary patient with a short-term, moderate ascites and no complications, simple use of dihydrochlorothiazide will be effective. In patients with a longer course and marked ascites, the combined use of drugs such as triamterene or aldactone that suppress distal renal tubule actions or neutralize ketoaldehyde actions are effective. With jaundice, complicating infections and fever, cachexia, worsened liver function, and progressive ascites, the effects of diuretics are usually poor. The use of diuretics may also induce hepatic coma, so they should be used with care.

Three times per day 50 mg dihydrochlorothiazide may be given orally or 100 mg twice daily. The medicine should be taken with 1 g potassium chloride (10%) three or four times per day. Each course should last 4 to 5 days, with an interval of 1 to 2 weeks. If the effects are not marked, further supportive treatment should be given and the intervals prolonged.

In combination medication, triamterene 50 mg three times per day or 100 mg twice daily or fine granules of aldactone (40 mg) twice daily may be given first. Then on the 2nd or 3rd day, add dihydrochlorothiazide and potassium chloride. The regimen is same as above.

The action of ethacrynic acid is faster than dihydrochlorothiazide, but it also more easily causes hypokalemia. The dosage is 25 mg three times daily. Potassium chloride (3 to 4 g) daily should be added. Each course lasts 3 to 5 days. It may also be used in combination with triamterene or aldactone. During treatment changes in the disease condition should be observed.

5. Operation and Indications for Portal Decompression

Refer to surgical treatment.

D. Treatment of Complications

1. Upper alimentary tract bleeding usually is due to rupture of varicose veins of the esophagus or fundus of the stomach. In most cases hematemesis and melena occur. Treatment includes nothing by mouth, absolute bed rest, transfusions, fluid replacements, intramuscular vitamin K, 20 units pitressin (or pituitrin) added to 200 ml glucose (5%) for intravenous drip. If there is excessive bleeding or repeated hematemesis, a three-tube balloon may be used for plugging, blood transfusions given, and benzoicum (0.2 g) or 6-aminocaproicum (2 to 4 g) used intravenously. If these are not effective, then surgery should be considered.

2. Hepatic coma may be induced by the use of diuretics, upper alimentary tract bleeding, complications of infections, and paracentesis. Therefore one should actively prevent and eliminate predisposing causes. With the appearance of prodromal hepatic coma symptoms, one must quickly correct the electrolyte imbalance, lower the blood ammonia, give intravenous potassium chloride and sodium or potassium glutamate. Make sure the liver is not damaged. (For treatment refer to section on tartar emetic toxic hepatitis.)

VIII. Methods of Surgical Treatment for Schistosomiasis

Schistosomiasis hepatic cirrhosis results in portal hypertension, leading to a huge spleen and rupture of esophageal and gastric fundus varicose veins causing bleeding and ascites. Seriously ill patients must be treated quickly and their hepatic function improved, so as to eliminate portal hypertension. At present surgical procedures are used mainly to decrease the portal hypertension. They may also help eliminate ascites, treat and prevent rupture of esophageal and gastric fundus veins and bleeding, and relieve hypersplenism. Operative procedures include splenectomy, diversion operations, disruption of gastric coronary veins, etc.

A. Splenectomy

Splenectomy will relieve hypersplenism. It also has certain degrees of effectiveness in relieving hematemesis and ascites.

1. Preoperative Examination and Preparation

History. Besides a general history, special attention should be given to a history of schistosomiasis, hepatitis, hematemesis or melena, jaundice, and ascites.

Physical examination. Besides a general examination, the size of the liver and the spleen should be carefully noted. Observe the tenderness, firmness, degree of mobility of the spleen, whether there is ascites, and the condition of distended abdominal wall veins. Rectal examination should be performed to see if there are hemorrhoids, masses, or stricture.

Laboratory examinations. Depending on the available conditions of the area and on the requirements for the patient, the following laboratory examinations may be made.

- a. Routine blood. Red blood cells (RBC), WBC, differential, Hb, platelets, bleeding, and coagulation times.
- b. Prothrombin time.
- c. Serum protein (albumin and globulin).
- d. Liver function tests: thymol turbidity test, thymol flocculation test, cephalin cholesterol flocculation test, zinc turbidity test, SGPT, and sodium glutamate-oxaloacetate transaminase (SGOT).
- e. Total bilirubin, 1 minute bilirubin
- f. Routine stool and urine. Stool-hatching test.

- g. Serum oval ring sedimentation test.
- h. Fluoroscopy of the chest and barium meal study of the esophagus.
- i. Splenoportal venography (helpful in diagnosis and selection of operative procedure).

Preoperative preparations. Supply vitamins K, B, and C, if needed. Generally blood transfusions are not necessary for anemic patients.

2. Indications for Operation

- a. Spleen enlargement exceeding second degree.
- b. Enlarged spleen with marked hypersplenism (WBC below $4,000/\text{mm}^3$, platelets below $80,000/\text{mm}^3$).
- c. Ascites disappeared or stabilized after treatment with combined Chinese and Western medicine (discontinue all diuretics and observe for 2 weeks. No change of urine volume, body weight, or abdominal circumference should be seen).

3. Contraindications for Operation

- a. Jaundice (total bilirubin above 1.5 mg/100 ml).
- b. Prothrombin time, 40% below normal value.
- c. SGPT and SGOT markedly elevated.
- d. Progressive ascites.

The general condition of patients of (a) and (b) above should be considered when choosing the operative method.

4. Operative Method

Anesthesia. Generally extradural anesthesia is used. If the chest should be entered or in a few complicated cases, endotracheal anesthesia may be used.

Choice of incision. An abdominal incision may be used in all huge spleens and adherent spleens. Generally a left upper rectus splitting incision or a left subcostal oblique incision may be used. With widespread adhesions, a thoracoabdominal incision may be used.

Main procedures of operation. After entering the abdomen, explore the extent of adhesions between the spleen and surrounding organs, observe the condition of the liver. If necessary measure the portal pressure. Sever the gastrosplenic ligament and colosplenic ligament, explore the porta and pedicle of the spleen. Divide the spleno-renal ligament or adhesions, and remove the spleen from the incision. Use three long, curved artery clamps to clamp on the splenic pedicle. Sever the splenic pedicle between the first two clamps at the porta. Use heavy ligatures to double ligate and suture ligate the splenic pedicle. Try to ligate the splenic artery and veins separately. Conscientiously examine for bleeding points; then close the abdomen in layers.

5. Precautions During Operation

Splenectomy for extensive adhesions. Attempt to tackle the splenic pedicle first; it is best to first ligate the splenic artery or perform a retrograde splenectomy, so as to avoid massive bleeding during separation of adhesions. When there are widespread dense adhesions between the spleen and the posterolateral peritoneum or diaphragm, with adequate blood transfusions and preparations for hemostasis, the spleen may be rapidly removed subcapsularly by blunt dissection. This procedure will decrease injury to collateral circulation and avoid massive bleeding. In addition, it will be easier to stop bleeding on the wound surface.

Coagulation mechanism. Poor liver function and marked hypersplenism will affect the coagulation mechanism, leading to widespread oozing of the wound surface that is very difficult to control. Surgeons use suture ligation, electrical cauterization, or coffee spoon cauterization to stop bleeding from small areas of point oozing. Locally 504 aerosol may be used; No. 25 hemostatic powder is also effective. With wide surface massive oozing, after treating the main bleeding points, the wound may be packed with iodoform gauze tapes with pressure. Then systemic hemostatic drugs may be given profusely. Lives can frequently be saved under such measures. Frequently used drugs are benzoic acid, 6-aminocaproic acid, and appropriate amount of ichthyol protamine; fibrinogen also can be used. In giving blood transfusions, fresh blood should be used.

Splenic pedicle. In handling the splenic pedicle, avoid injury to the tail of the pancreas, thus preventing leakage of pancreatic juice and increasing the rate of subphrenic infections.

Utilization of splenic blood. The results of several years' experience proved that autotransfusion of splenic blood did not cause any bad reactions. Transfusion to others with the same blood type also did not cause untoward effects. This kind of transfusion can save expenses and can also solve the difficulty of blood source. When a large number of splenectomies are carried out on farms, the patients may be organized for surgery according to their blood type, so that splenic blood can be fully utilized.

6. Postoperative Care

Postoperative bleeding and subphrenic abscesses will greatly affect the recovery of the patients. Therefore, medical personnel must strictly enforce sterilization and aseptic techniques during the operation and conscientiously and carefully carry out the operative procedure. Besides the usual postoperative management for major abdominal surgery, note the following two points:

Postoperative internal bleeding. Postoperative internal bleeding is mainly due to poor general conditions; wide oozing surface of adhesions; disturbance of coagulation mechanism; or a collateral vessel missed during operation. Bleeding usually occurs within 12 hours after the operation. It may also occur within 3 days, but this is less common. Close observation should be carried out after operation; the blood pressure and pulse should frequently be checked. With the appearance of bleeding, close observations should be made and blood replacement given in time. Once there is deterioration, laparotomy should be immediately performed to stop bleeding.

Postoperative infection. Subphrenic abscess occurs mainly because there was a lack of aseptic technique or sterilization during the operation. Usually it occurs about 1 week after operation. The most common pathogens are *Staphylococcus aureus* or *Bacillus coli*. The general diagnosis for abscess follows:

- a. Unrelenting high fever, soreness of left shoulder, marked tenderness of left costophrenic angle, anorexia, and poor mental state.
- b. Laboratory findings of an increase of WBC and neutrophils.
- c. Fluoroscopic findings of left phrenic reaction or effusion, elevation of left diaphragm and limitation of movement, increased distance between the stomach and the diaphragm, increased density of the local shadow, and sometimes increased fluid levels.

Supersonic examination and localization are accurate procedures. They also estimate the amount of fluid. Diagnostic aspiration and bacterial culture and drug sensitivity tests can be utilized.

In treating the abscess, if the toxicity is not severe and the septicemia not serious, local irrigation of the abscess may be performed and suitable antibiotics injected into it. If the infection is serious, toxicity severe, and the abscess cavity large, then early drainage should be performed. Sectioning the 11th rib to accomplish extraperitoneal drainage

is safer and allows drainage. After the occurrence of subphrenic abscess immediately search for the cause, and take appropriate measures to prevent spread of infection.

B. Bleeding of the Upper Alimentary Tract

Rupture of esophageal and gastric fundus varicose veins with severe bleeding is a frequently encountered and most serious complication of portal hypertension. If treatment is given in time and properly, most bleeding can be stopped and the patients saved. Medical treatment to stop bleeding should be attempted first. If it is ineffective, then surgical treatment should be considered.

Medical treatment is usually suitable for patients who have slight bleeding or if bleeding has practically stopped at time of visit.

1. General Treatment

- a. Nothing by mouth. Bedrest.
- b. Blood transfusions, fluid replacements (it should be noted that excessive blood and plasma transfusions may elevate portal pressure).
- c. Use of antihemorrhage drugs, vitamins K_1 and K_3 , benzoicum, 6-aminocaproicum.
- d. Use of pituitrin. 20 units added to 200 ml of glucose (5%) for intravenous drip, infused within 30 minutes. If necessary may be repeated once in 4 hours.
- e. Oral antihemorrhage powder. At present several are in use, such as No. 3, 8, 10, 202, and thromboplastin.

2. Plugging With Triple Tube and Double Sac

- a. If the blood pressure cannot be maintained at or near normal or hematemesis and melena cannot be controlled after the above

treatment, then plugging with a triple tube and double sac or a remodeled Miller-Abbott double tube and single sac (more suitable for children) should be used. Before using this method, examination should be made of the volume of the air sacs and for any leakage. To relieve the suffering of the patient during placing of the tube, the throat may be sprayed with dicaine and an injection of phenergan (25 to 50 mg) be given. The air sacs should be lubricated with oil.

b. First aspirate the two air sacs until there is no air. Pass the tube through the nostril into the esophagus and stomach for 55 cm. The stomach sac is now in the gastric cavity. Inject 200 to 250 ml of air into the sac, and pull the tube out until there is a feeling of resistance. Now the sac is already plugged against the cardia. Use adhesive tape to fix the tube on the skin outside of the nostril. Inject about 150 ml of air into the proximal esophageal sac. Usually pressure is not immediately applied to the esophagus. After the stomach tube is pressed against the cardia, observations should be made to see if there is still hematemesis. If fresh blood is still thrown up, it proves that there is a rupture of esophageal varices, and pressure must be applied to the esophagus. Otherwise, it is only bleeding from a rupture of gastric fundus varices. This method differentiates bleeding from the gastric fundus or from the esophagus.

c. Aspirate the blood in the stomach from the tube to determine the rapidity of bleeding, if pressure is effective, and whether an operation is required. The aspiration tube may be used to aspirate and to supply nutrition.

d. If pressure is effective, generally it is continued for 48 to 72 hours. Applying pressure for too long may cause mucosal maceration and necrosis. During removal of the tube, the air sacs must first be emptied and retained for a few minutes. Make the patient take some lubricating oil orally, and then slowly pull out the tube to avoid trauma that may again cause bleeding.

e. During the use of triple tube-double sac pressure method, close observation must be made to avoid rupture of the air sacs; slipping out

of the tube can result in suffocation, or a loosening of the adhesive tape can result in the loss of function of air sac pressure.

3. Surgical Operative Methods

Diversion operations. Anastomosis of a branch of the portal vein system to a branch of the inferior vena cava system should lower the portal pressure, thus decreasing the alimentary tract bleeding and recurrence of ascites. The following contraindications should be noted:

- a. Marked cachexia.
- b. Jaundice (or bilirubin above 1.5 mg/100 ml).
- c. Prothrombin time 40% below normal.
- d. Elevation of SGPT, SGOT.
- e. Progressive ascites.
- f. Old age.

Selection of diversion procedures. Splenorenal anastomosis has certain effects in lowering pressure. Postoperative diversion encephalopathy rarely occurs, so it should be the first choice.

- a. Some precautions in splenorenal shunt should be taken. When the effects of simple splenorenal anastomosis to lower the pressure are not evident, excision of the gastric coronary veins may be performed simultaneously. When the calibers of the splenic vein and renal vein are not equal or the splenic vein is too short, then side-to-side anastomosis of the veins may be performed.

b. Anastomosis of the superior mesenteric vein to the inferior vena cava may be used. The choice of procedure depends on the actual conditions of the patients and the operator's experience. The more ideal procedure is a side-to-side anastomosis, but tension is a frequent cause of failure. Artificial vessels or autogenous vessels may be used for bridge diversion, but the rate of thrombosis is high. Sectioning of the inferior vena cava and performing end-to-side anastomosis to the superior mesenteric vein will frequently result in lower limb edema. For these reasons they cannot be used routinely.

c. Portacaval shunt also is available. Although its effect of lowering pressure and in treating upper alimentary tract bleeding is good, the rate of encephalopathy complication is very high. This problem limits the development of this operation. We advocate the use of this procedure when the above methods cannot be used. The anastomosis opening should be less than 1.5 cm to decrease the occurrence of portasomatic encephalopathy.

Interruption operations. The retrograde flow of the portal blood to the esophageal azygos vein system is interrupted for the purpose of treatment and prevention of bleeding from rupture of the esophageal and gastric fundus varices.

a. The excision of gastric coronary veins may be performed simultaneously with splenorenal shunt, interrupting direct communication of the portal vein with the esophageal veins. It will direct the blood flow to the gastric coronary veins and to the esophageal veins and then to the splenorenal anastomosis. Performing gastric coronary vein excision simultaneously with splenectomy causes interruption of the blood flow of the short gastric vein and gastric coronary vein systems. Thus it has certain effects in the treatment and prevention of recurrent bleeding. Postoperative barium meal examinations of the esophagus show improvement or entire disappearance of most of the varices verifying this point.

b. Excision of vessels surrounding the stomach may be used. Make a left upper rectus or midline incision. On the greater curvature

side, ligate the short gastric and left gastroepiploic arteries and veins; sever and ligate vessels on the posterior gastric wall coming from the pancreas; on the lesser curvature sever and ligate the vessels from the pylorus to the cardia (left gastric artery and its branches); sever and ligate the vessels around the abdominal esophagus; if the subphrenic veins are dilated, they are also ligated. This operation is simple and safe, is somewhat effective in upper alimentary tract bleeding, and may immediately solve the problem of or prevent bleeding. It is especially suitable for bleeding patients who are critically ill, in poor general condition, and not suitable for diversion operations.

c. Circular incision of the gastric seromuscular layers and submucosal ligation of vessels may be performed. About 5 cm from the cardia, make a circular incision of the seromuscular layers using No. 0 ligatures to ligate the submucosal vessels. This procedure is performed simultaneously during splenectomy. In patients with upper alimentary tract bleeding who already have had the spleen removed, this operation is performed with excision of vessels surrounding the stomach.

d. Ligation of gastric fundus veins gives poor short-term and long-term effects, but it can stop bleeding by direct ligation. It is only used in certain emergency cases.

e. Direct excision of bleeding part may be performed. Partial excision of gastric fundus or esophagus directly removes the bleeding part, has no complication of diversion encephalopathy, and is a comparatively good method. But it is an extensive operation, and some patients cannot tolerate it. There are also reports of excision of the gastric fundus simultaneously with splenectomy in the treatment of upper alimentary tract bleeding, with fairly satisfactory results.

Hepatic function compensation. Based on the condition of hepatic function compensation, we can divide upper alimentary tract bleeding into two types.

One type shows poor hepatic function compensation, manifested by marked ascites, marked jaundice, hepatic coma, or prodromal symptoms

of hepatic coma. In this case, we perform transabdominal ligation of gastric fundus veins but retain the spleen to avoid losing the chance of a diversion procedure. In patients who already have had the spleen removed, excision of vessels surrounding the stomach plus circular incision of the gastric seromuscular layers and submucosal ligation of vessels may be performed.

Another type has with good hepatic function compensation, no jaundice, and no ascites. In this case, perform emergency splenectomy plus splenorenal shunt or splenectomy plus excision of surrounding vessels of the stomach. In patients who have had a splenectomy, perform ligation of surrounding vessels of the stomach plus circular incision of gastric seromuscular layers and submucosal ligation of vessels. Otherwise perform emergency superior mesentery vein and inferior vena cava anastomosis or portacaval anastomosis; based on the experience of different hospitals, the selection of an operation for postsplenectomy bleeding may be between diversion operations or excision of gastric fundus and partial excision of gastric fundus and esophagus.

At present these two operative methods are comparatively effective in upper alimentary tract bleeding. These methods should be used in the young with no marked disturbance of hepatic or renal functions. In the management of upper alimentary tract bleeding, no matter what procedure is chosen, the following measures should be taken in all cases to prevent the occurrence of hepatic coma.

- a. Give neomycin 0.5 g every 4 hours orally or through a stomach tube.
- b. Give 30 to 40 ml magnesium sulfate (50%) one to two times daily orally or through a stomach tube.
- c. Saline enema daily.
- d. Use deammoniating drugs such as potassium (sodium) glutamate 23 g intravenous drip, once daily; or use arginine acid 10 to 20 g, or α -aminobutyric acid 2 to 4 g.

C. Colonic Pathological Changes in Schistosomiasis

Schistosomiasis colonic granuloma is also a frequently encountered complication. It should be treated carefully because the rate of malignant change is very high. Diagnosis is made chiefly by gastrointestinal X-ray examinations and exploration during splenectomy. Digital rectal examination should be made routinely. The pathology is found mainly in the sigmoid colon and rectum, next in frequency in the descending colon and transverse colon. It is rare in the ascending colon. When there are strictures or malignant changes, surgery is necessary.

During the operation it is best to perform a frozen section examination. If it is confirmed to be schistosomiasis granuloma without malignancy, then local excision of the mass to relieve the stricture will be sufficient. If there are malignant changes, then it is treated as carcinoma of the colon. Occurrence of multiple granuloma in the mesentery or base of the mesentery does not cause intestinal tract symptoms. Operative excision is difficult, and further observations are needed to detect any malignant changes. Carcinoma of the colon is treated as follows:

1. Preoperative Preparation

a. Low-residue full diet, followed by semiliquid diet starting 3 days before operation, and a liquid diet 1 day before operation.

b. One week before operation start sodium glutamate 2 g every 6 hours; 3 days before operation change to or add neomycin 1.0 g or streptomycin 0.5 g, four times daily.

c. Three days before operation give vitamin K₃ injection.

d. Three days before operation take liquid paraffin, 20 to 30 ml, every evening.

e. Three days before operation give enema every night. The night before operation give cleansing enema. Two hours before operation give low-saline enema, and retain an anal tube.

f. The morning of operation insert stomach tube and catheter.

g. Preoperatively correct anemia, hypoproteinemia, and dehydration; and supply vitamins B and C.

2. Surgical Treatment of Carcinoma of the Colon

The types of surgery may be divided into an operation for acute intestinal obstruction, a palliative operation, and a radical operation.

Operation for acute intestinal obstruction. For right colon carcinoma, perform a cecostomy, ileostomy, or ileotransverse colostomy. For transverse colon carcinoma, perform a cecostomy. For descending colon and sigmoid colon carcinoma, perform a transverse colostomy.

Palliative operation. This procedure is performed when a radical operation for carcinoma of the colon is not possible. For right colon carcinoma, perform ileotransverse or ileosigmoidal side-to-side anastomosis. For left colon carcinoma, perform a transverse colon and sigmoid colon side-to-side anastomosis. For sigmoidal carcinoma perform a transverse colostomy or upper descending colostomy.

Radical operation. The position of the carcinoma and the presence of strictures, adhesions, or inflammation determine the choice of various operations. In carcinoma of any position on the colon, if there are no strictures, adhesions, or inflammation, a one-stage excision should be attempted. When carcinoma of the colon is accompanied by stricture, adhesions, and inflammation, the lumen above the stricture is markedly dilated and the wall becomes thin. Below the stricture the wall is edematous. When there are widespread adhesions, separation becomes difficult; with local inflammation and possible abscess formation, there is the danger of perforation. All these are contraindications to one-stage resection, and two-stage operations should be performed.

3. Operative Methods for Carcinoma of Different Parts of the Colon

Depending on to the different positions, any of the following five methods may be used:

Carcinoma of the cecum, ascending colon, and hepatic flexure. The operative method for carcinoma of the cecum, ascending colon, and hepatic flexure is the same: a right hemicolectomy.

Carcinoma of the transverse colon. Perform transverse colectomy. Because the whole length of the transverse colon is supplied by the midcolic artery, a total transverse colectomy must be performed for carcinoma of any part of the transverse colon. To determine the viability of both ends of the intestine before anastomosis is very important. To allow the anastomosis to be made without tension, it is frequently necessary to mobilize the right and left flexures of the colon.

Carcinoma of the left flexure of colon, descending colon, and sigmoid colon. Perform a left hemicolectomy for all.

Carcinoma of the junction of the sigmoid colon and rectum. Transabdominal one-stage resection and anastomosis are possible. If the position of the mass is very low, it is safer to perform a preventive colostomy first and then resect the carcinoma.

Carcinoma of the rectum. The following three methods are used: abdominal-perineal resection of the rectum (Mile's operation); Dixon's operation; and Bacon's operation.

IX. Strengthen The Leadership Role in Treatment

Treatment of patients is an important link in the elimination of schistosomiasis. It is also important in protecting work capacity and guaranteeing increased farm production.

Enthusiastically train local doctors, and establish a treatment team with these doctors as the backbones. The brigade health clinic, commune health clinic, and Hsien people's hospital should consider treatment of schistosomiasis patients as a major duty. Under the prerequisite of safety and effectiveness, adopt the system of establishing treatment centers at the commune or brigade. Dispense drugs to the household, so the people can receive treatment conveniently. Early and chronic cases also should be treated. Organize emergency treatment units, make rounds and give instructions, be responsible for consultations and management of patients with severe reactions. Draw on experiences, and raise the standard of treatment.

Chapter 7

PREVENTION AND TREATMENT OF SCHISTOSOMIASIS
AMONG FARM CATTLE

Prevention and treatment of schistosomiasis among farm cattle not only keep the cattle healthy and is advantageous for production, but is also an important measure in eliminating schistosomiasis.

I. Methods of Prevention of Schistosomiasis
Among Farm Cattle

A combination of measures is needed for the prevention of schistosomiasis among farm cattle. Besides actively treating cattle, there must also be control of manure, control of water, elimination of snails, and prevention of migration of sick cattle.

Control of manure. Prevention should coordinate farm production methods, local fertilizer-collecting methods, and proper control of cattle manure.

Control of water. In schistosomiasis epidemic areas, the water used by farm cattle must be from water sources with no snails or in pools where the snail has been eliminated. Use designated pools for water.

Prevention of movement of sick cattle. Any cattle sick with schistosomiasis must be treated locally and be sold or sent out of the locality only after treatment and cure. In infected areas, farm cattle should be kept in areas with no snails.

II. Methods for Investigation of Schistosomiasis
Among Farm Cattle

General investigations must be carried out conscientiously and thoroughly. General investigation for schistosomiasis among farm cattle must be performed in cooperation with health departments, learning from each

other and working together, thus saving equipment, material, manpower, and time and accomplishing the objective.

A. Requirements for Sending Cattle Manure for Examination

Send cattle manure for examination. Designate a reliable, punctual person. Collect the proper quality and quantity of manure and have it examined three times.

Pack and transport cattle manure. Obtain 2 to 3 oz of manure daily (not less than the size of a duck's egg). The instruments for obtaining the manure should not be mixed. There should be no leakage or seeping through of the package. Paper packages may be used, but not paper used for wrapping farm chemicals or chemical fertilizer. During transport avoid sunshine or drenching rain.

Complete records. Completion of the card must be done in consultation with the person who feeds the farm cattle. The cattle, the manure, and the card must all be checked and be in proper order. Red ink should not be used to fill in the card.

Investigation and registration. Establish a complete system of investigation and registration of farm cattle schistosomiasis.

B. Manure-hatching Method

At present the manure-hatching method is still the main method for manure examination. Each specimen should be examined three times. In carrying out general examination in lightly infected areas, uncontaminated cattle manure may be used for contrast to help in the diagnosis. Basically, the procedure of hatching sick cattle's manure is the same as in human manure examination. The differences are:

1. In completing the card, include the type of cattle, sex, age of cattle, and name of the keeper. If possible special characteristics of the cattle should be recorded to help in identifying the cattle.

2. The volume of manure should not be less than 100 g.
3. The manure sieve should be bigger. Sieve holes should be 40 holes/in² (Fig. 28).
4. Thoroughly wash and stir the manure evenly. Each manure specimen requires 1 to 3 minutes.
5. Time intervals for water change for sedimentation are 30, 15, 10, and 10 minutes. If the supernatant fluid remains turbid, the number of water exchanges may be increased. In summer with a temperature above 20°C, 1.2% saline must be used to wash the manure.
6. In winter, at intervals of 2, 4, and 6 hours after hatching, observe each specimen; in summer, observe 1, 2, and 5 hours after hatching. Because of the large bulk of cattle manure and the low ova density, observation must be carried out carefully. Each hatching bottle should be observed for 2 to 3 minutes.

III. Methods of Treatment of Schistosomiasis Among Farm Cattle

To accomplish the treatment of schistosomiasis successfully one must depend on the poor and the peasants, local veterinarians, and cattlemen.

A. Health Examination Procedures

If farm cattle are found to be infected with schistosomiasis, they should first be given a health examination. Then based on the conditions and the standard of treatment, decide if the cattle should be treated, treatment be delayed, or treatment not given at all.

1. Main Items of the Health Examination

- a. Obtain a detailed history of the sick cattle, their habits, and feeding and management conditions.

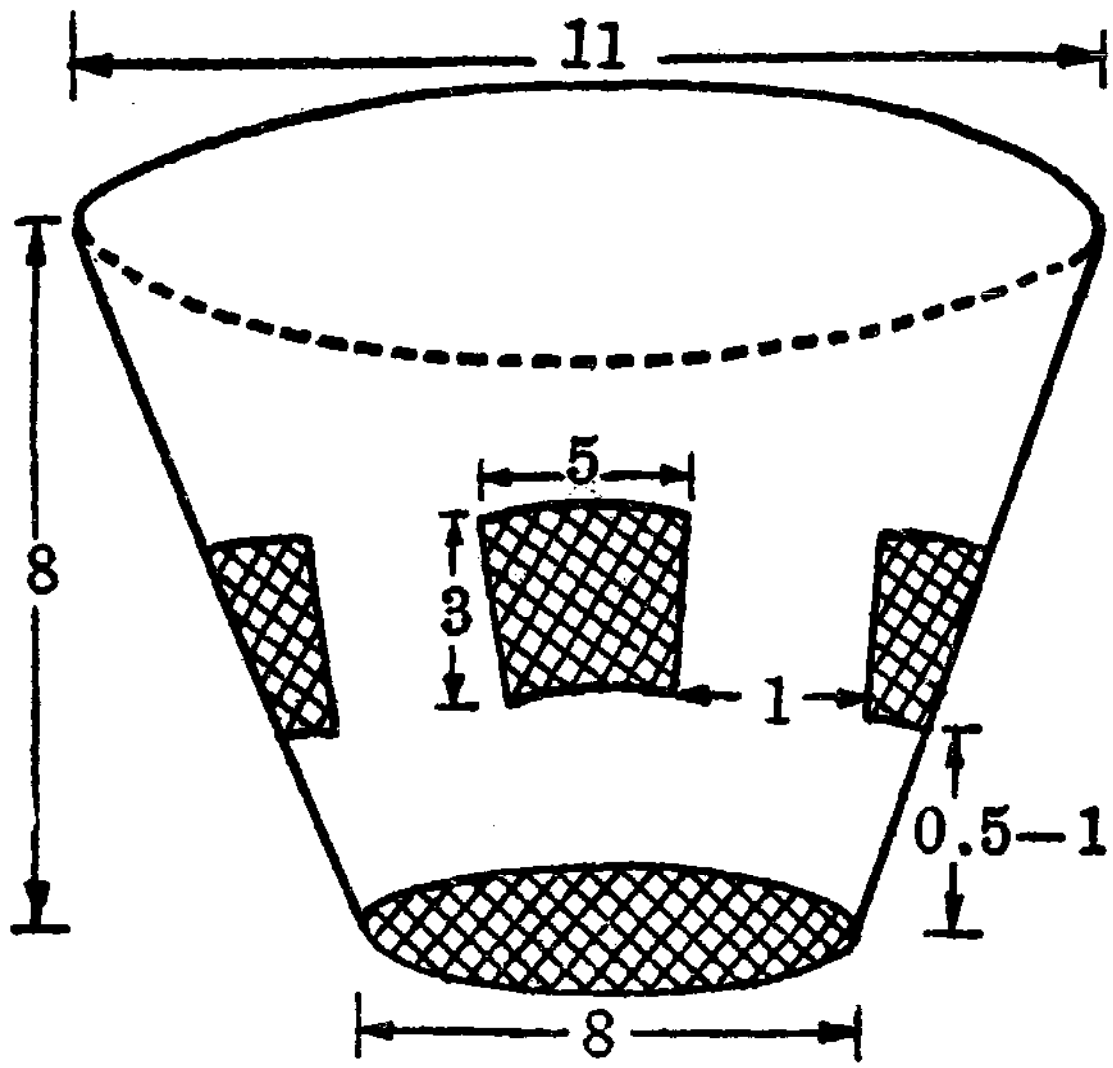

Figure 28. Manure sieve (unit:cm; 40 sieve holes/in).

b. A systemic examination should be given to each cow. The chief items are: body temperature, respiration, heart rate, heart rhythm, peristalsis of rumen, rumination, mental state, appetite, visible mucosa, and condition of nutrition. Note if there is limping.

c. If necessary perform routine blood and urine examinations and other diagnostic tests.

d. In a cow the sexual behavior, pregnancy, and nursing conditions should be recorded.

2. Normal Physiological Standards of Farm Cattle

a. Body temperature: yellow cattle 37.5°C to 39°C ; buffalo 37°C to 38°C . Heart rate: yellow cattle, 40 to 80 beats/min; buffalo, 40 to 60 beats/min.

b. Respiration: 10 to 20 times/min.

c. Rumen peristalsis: 2 to 5 times/2 min.

d. Blood: RBC 5 to 7 million; WBC 5,000 to 9,000; Hb above 5 g; bilirubin within 0.001 to 0.03 g.

e. Urine: Protein, sugar, ketone bodies, urobilinogen, hemoglobin; all negative.

3. Reasons for Delayed Treatment

a. Past the first trimester of pregnancy and within the first 3 months of lactation.

b. Cow in heat.

c. Nutrition below 50% of normal values.

d. Abnormal blood or urine.

e. Presence of acute or chronic diseases..

B. Cattle Not to Be Treated

Old and crippled cattle that have lost their ability to work and those with serious diseases that failed to respond after treatment should not be treated.

IV. Drug Dosage and the Course of Treatment

A. Calculation of Body Weight

For accurate measurement, the cattle must stand up straight on a flat ground and with proper posture. Find the measure points and precisely measure the length. The diagonal body length extends from the tip of the shoulder to the ischial bone. Both sides should be measured and an average value obtained. To measure the chest circumference, record the length of one circle surrounding the chest at a point on the posterior angle of the shoulder bone. During measurement the tape measure must be pulled tight (Fig.29).

B. Drug Dosage and Treatment Course (Table 17)

Drug dosage should be carefully controlled. In the Shanghai area, the dosage for yellow cattle is calculated at a 350 kg maximum weight; and that for buffalo, at 450 kg.

C. Determination of Drug Dosage

Generally during treatment, reactions among yellow cattle are more severe than in buffalo, more severe in spring or winter than in autumn, more severe in old cattle than in younger, and usually mild in calves. Therefore the season, the treatment objective, and the treatment method must be considered and analyzed; veterinarians, keepers, and leaders must

Table 17.—Drug Dosage and Treatment Course

Name of drug	Actual dose		Treatment		
	of drug	Daily dose	course	Method	Total dosage
Antischistosome-846 oil solvent (20%)	0.2 g/ml	80-90 mg/kg	10 days	oral	800-900 mg/kg
Antischistosome-846 oil solvent (20%)	0.2 g/ml	35-40 mg/kg	5 days	i. m.	175-200 mg/kg
Antischistosome-846 tablet	0.25 g per tab.	100 mg/kg	10 days	oral	1000 mg/kg
Antischistosome-846 milk powder ¹	0.21 g/g	—	—	oral	—
Tartar emetic ²	0.01-0.03 g/ml	2 mg/kg	3 days	i. v.	—
Antimony-273	—	2 mg/kg	5-6 days	i. m.	10-12 mg/kg

¹ May give trial course with slightly lower total of oral "846" oil solvent dose.

² Total dose for yellow cattle not exceeding 1.7 g, for buffalo 2.2 g, daily total dose not exceeding 0.5 g; rest of dose inject on 4th and 5th day.

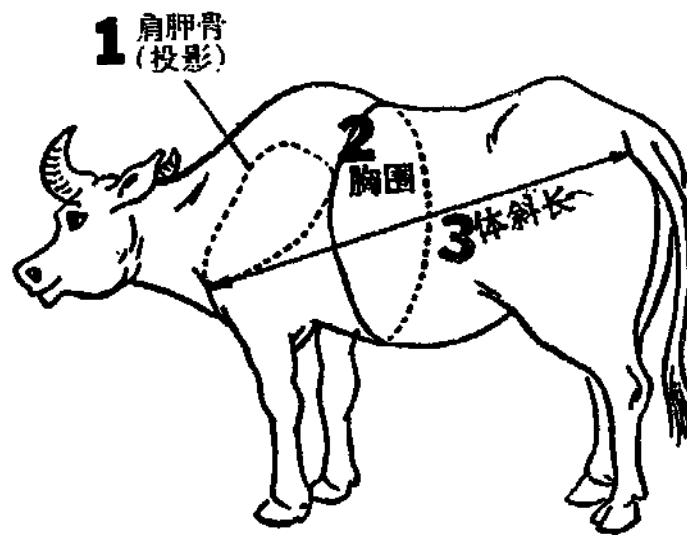

Figure 29. Tape ruler measurement of parts of cattle body.

1. Shoulder bone (outline)
2. Chest circumference
3. Diagonal body length

Note: Calculation of body weight should be made when stomach is empty. The method of calculation is as follows:

$$\text{Yellow cattle body wt (kg)} = \frac{(\text{chest circumference})^2 \times \text{diagonal body length (cm)}}{10,800}$$

$$\text{Buffalo body wt (kg)} = \frac{(\text{chest circumference})^2 \times \text{diagonal body length (cm)}}{12,700}$$

work together to determine the drug dosage for each sick animal. This point is important for proper treatment and to decrease reactions.

D. Requirements for Treatment

1. Antischistosome-846 treatment should be administered by local veterinarians in separate tablet packages sent to each location. With antimony drug treatment, leaders should adopt small concentration points, divide into groups, and treat the different stages of the disease.

2. Consolidate the on-duty system of veterinarians and keepers; discover and prevent side reactions early. Any change of disease conditions calls for early consultation and early treatment.

3. Strictly adhere to the rules of medical procedures. One must be able to: safely protect and plan (especially with antimony treatment); accurately calculate drug dosage and secondary drugs (note the quality of drug, number, and the method of preparation); follow strict asepsis during injection; pay attention to safety in giving drugs.

4. The treatment record card (Table 18) and registration must be kept conscientiously.

5. Medical treatment for sick cattle consists of 30% treatment and 70% nursing care. Nursing care must be stressed to decrease reactions and help the sick cattle to early recovery.

6. Conduct study classes for the schistosome veterinarian personnel; raise the sense of responsibility in nursing care; note closely the changes in drinking habits and appetite, mental state, urine, and feces. This measure is important in the early prevention of side reactions.

a. One week before starting treatment, the sick cattle should stop or decrease working; bulls should stop studding.

b. On-duty system must be strengthened during the course of treatment (night duties should be assigned during antimony treatment). Nursing

Table 18.--Schistosomiasis Treatment Record for
Commune Farm Cattle

Brigade: Production team: Name of recordkeeper:

No.: Cattle: Sex: Age: Special signs:

Nutrition: Covering hair: Pregnancy:

Chest circumference: Oblique body length:

Estimated wt: Actual wt or wt for medication:

Drug for treatment: Total dose: mg Daily dose: mg

Conc. of drug: Administration routine: Course:

Treatment record:

No. medication	Date	Dose	No. medication	Date	Dose
1			6		
2			7		
3			8		
4			9		
5			10		

Before treatment End of treatment 3 mo. after treatment

Manure examination:

Date	No. Result	Date	No. Result	Date	No. Result
1		1		1	
2		2		2	
3		3		3	

History:

Examination before treatment:

Examination during treatment and management of reactions:

care should be conscientious. During treatment with antischistosome-846 and antimony, the sick cattle should drink a lot of water. In winter warm water should be given. The barn should be kept clean and dry, with much straw on the ground; the cattle should be kept quiet. In summer cattle should be kept cool, and in winter warm. During the course of antimony treatment, it is best for buffaloes not to go into creeks, bulls and cows should be in separate barns, bad-tempered cattle should be kept solitary, injections should be stopped, and treatment should be postponed in cows in heat.

c. After treatment perform a health examination once more before taking the cattle back to the production team. After return to the team, nursing care should be continued; note any side reactions, and give early treatment. After treatment the sick cattle should not work for 20 to 30 days; then the labor capacity is gradually increased.

V. Side Reactions and Their Treatment

A. Side Reactions of Tartar Emetic and Their Management

1. Local Reaction

Slight swelling does not require treatment. If the swelling is more severe, cold or hot compresses may be used to eliminate swelling. With severe pain, cold compresses or procaine hydrochloride (0.5%) local block may be used. In addition, a solution of glycyrrhiza powder (20% suspension) also may be used locally.

2. General Reaction

a. Treatment may be continued if the body temperature elevation is less than 1°C and there are no other reactions. If the body temperature is elevated 1°C to 2°C continuously for 24 hours, then discontinuation of injection may be considered. Adequate drinking water also must be supplied; if necessary, normal saline enema may be given.

b. In serious muscular convulsions and general tremor, injections should be discontinued, and the following drugs be chosen for use:

Sodium phenobarbital, 0.5-1 g i.m.

25% magnesium sulfate 50-100 ml i.m. or i.v.

10% hypertonic saline 100 ml i.v.

50% glucose solution 200-300 ml i.v.

If symptoms of skin rash or urticaria occur during treatment, one may use antihistaminic drugs, such as benadryl (0.5 mg/kg of body weight) intramuscularly or 3 to 5 ml atropine sulfate solution (5%) intramuscularly or subcutaneously.

c. Cardiac reactions are encountered most frequently and are the most serious reactions of tartar emetic treatment. Generally when the heart rate is above 100/min or over 20 beats more than before treatment, then injections should be discontinued, and 10 to 30 mg atropine sulfate should be given intramuscularly or subcutaneously. If necessary, repeat once after 4 hours. If extrasystoles occur and continue for a long time together with arrhythmia, injections should be discontinued. Either 5% atropine sulfate solution, 3 to 5 ml, subcutaneously or intramuscularly; 10 mg atropine sulfate added to 100 ml glucose solution (20%) intravenously; or sodium phenobarbital and other sedatives may be given in this case.

If a sick animal suddenly drops to the ground with symptoms of hyperextension, severe convulsions, muscular spasms, peripheral coldness, arrhythmia or weakness of cardiac sound, irregular pulse expansion, and difficult breathing, first aid must be given in the form of 3 to 5 ml atropine sulfate solution (5%); 200 ml glucose solution (20%) intravenously once; 1000 to 200 ml glucose (5%) intravenously.

In sick cattle under tartar emetic treatment, such cardiac stimulants as adrenalin, caffeine, coramine, and digitalis are contraindicated.

In the use of atropine sulfate, its side reactions should be carefully watched for; if the pupils become dilated, then it should be discontinued.

If the rumen becomes dilated with gas, the following measures should be taken: massage the left abdomen, or use 15 g ichthyol and 500 ml warm water for ingestion; if severe, a needle with stylet may be used to aspirate the rumen, and 100 to 500 ml saponated cresol (1%) injected through the needle to stop fermentation.

B. Side Reactions of Antischistosome-846 and Their Management

1. General Alimentary Tract Reaction

This reaction is manifested by decreased peristalsis of the rumen, anorexia, constipation or loose stools. The following drugs may be used:

30 ml tincture of rhei, 30 ml tincture of gentian, 10 ml tincture of nux vomica, taken orally once for 2 to 3 days.

5 g ichthyol, add 500 ml water, take orally.

30-50 g charcoal powder (or tablet) once orally.

300-500 g magnesium sulfate, add 1000 ml or more water, take orally once.

100-200 ml sodium chloride (10%) i.v.

50-80 g artificial salt, take orally once.

2. Liver Toxemia

Liver toxemia is manifested by yellow tinge of visible mucosa, mental depression, indigestion, diarrhea, foul-smelling stools, cessation of feeding, distension of rumen. Choose from the following prescriptions:

5% glucose in normal saline, 1000-2000 ml, i.v.

25% hypertonic glucose solution, 100-200 ml, i.v.

Compound vitamin B and vitamin C 1-2 g or 2-3 mg/kg of body weight i.v.

3. Symptoms of Excitement

When such symptoms occur, chlorpromazine (2-3 mg/kg of body weight i.m.) may be used.

4. Elevation of Body Temperature

Use antibiotics and sulfonamides.

VI. Work after Conclusion of Treatment

After completion of treatment, close followups must be planned to investigate changes of general health, working capacity, and reproductive ability after treatment, in order to determine the final effect of treatment. Three months after treatment, use manure-hatching method to reexamine the effect of treatment, and observe whether the manure has turned negative for the test.