

Communication Wiring Color Codes

Cat 5 & 5e Network

Color Codes for RJ-45 Ethernet Plug

Eight-conductor data cable (Cat 3 or Cat 5) contains 4 pairs of wires. Each pair consists of a solid color wire and a white and color striped wire. Each of the pairs are twisted together. To maintain reliability on Ethernet, you should not untwist them any more than necessary (about 1/4 inch).

The pairs designated for 10BaseT Ethernet are orange and green. The other two pairs, brown and blue, are unused. The connections shown are specifically for an RJ45 plug. The wall jack may be wired in a different sequence because the wires may be crossed inside the jack. The jack should either come with a wiring diagram or at least designate pin numbers that you can match up to the color code below.

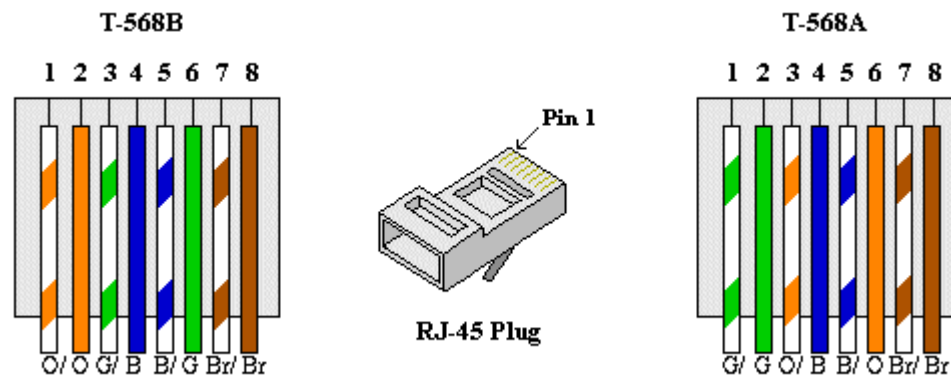

There are two wiring standards for these cables, called T-568A and T-568B. They differ only in pin assignments, not in uses of the various colors. The illustration above shows both standards. With the T-568B specification the orange and green pairs are located on pins 1, 2 and 3, 6 respectively. **The T-568A specification reverses the orange and green connections, so that the blue and orange pairs are on the center 4 pins, which makes it more compatible with the telco voice connections.**

T-568A is supposed to be the standard for new installations, and T-568B is the alternative. However, most off-the-shelf data equipment and cables seem to be wired to T568B.

Pin Number Designations

Here are the pin number designations for both standards:

T-568B

Pin	Color	Pair	Description
-----	-------	------	-------------

1	white/orange	2	TxData +
2	orange	2	TxData -
3	white/green	3	RecvData +
4	blue	1	Unused



5	white/blue	1	Unused
6	green	3	RecvData -
7	white/brown	4	Unused
8	brown	4	Unused

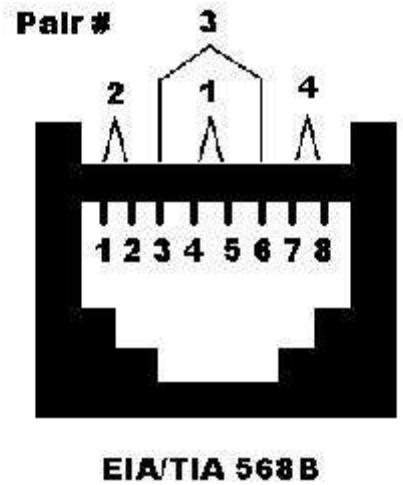

T-568A

Pin Color Pair Description

1	white/green	3	RecvData +
2	green	3	RecvData -
3	white/orange	2	TxData +
4	blue	1	Unused
5	white/blue	1	Unused
6	orange	2	TxData -
7	white/brown	4	Unused
8	brown	4	Unused

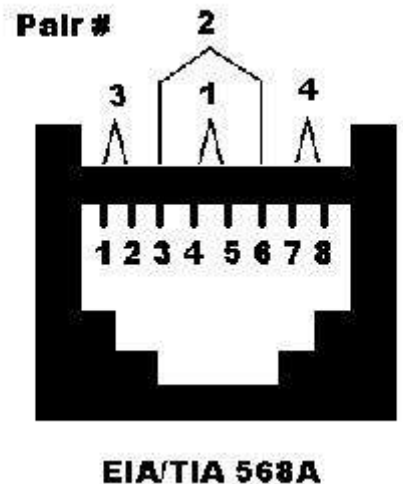

Note: Odd pin numbers are always the striped wires..

Straight-Through vs Cross-Over

In general, the patch cords that you use with your Ethernet connections are "straight-through", which means that pin 1 of the plug on one end is connected to pin 1 of the plug on the other end (for either standard). The only time you cross connections in 10BaseT is when you connect two Ethernet devices directly together without a hub or connect two hubs together. Then you need a "cross-over" patch cable, which crosses the transmit and receive pairs. An easy way remember how to make a cross-over cable is to wire one end with the T-568A standard and the other with the T-568B standard.

Termination

UTP cables are terminated with standard connectors, jacks and punchdowns. The jack/plug is often referred to as a "RJ-45", but that's a telco designation for the "modular 8 pin connector" terminated with a USOC pinout used for telephones. The male connector on the end of a patchcord is called a "plug" and the receptacle on the wall outlet is a "jack."

In LANs, as spec'ed by 568, there are two possible pinouts, called T568A and T568B, that differ only in which color coded pairs are connected - pair 2 and 3 are reversed. Either work equally well, as long as you don't mix them! If you always use only one version, you're OK, but if you mix A and B in a cable run, you will get crossed pairs!

The cable pairs are color coded as

Pair 1 is white-blue/blue,
Pair 2 white-orange/orange,
Pair 3 is white-green/green
Pair 4 is white-brown/brown.

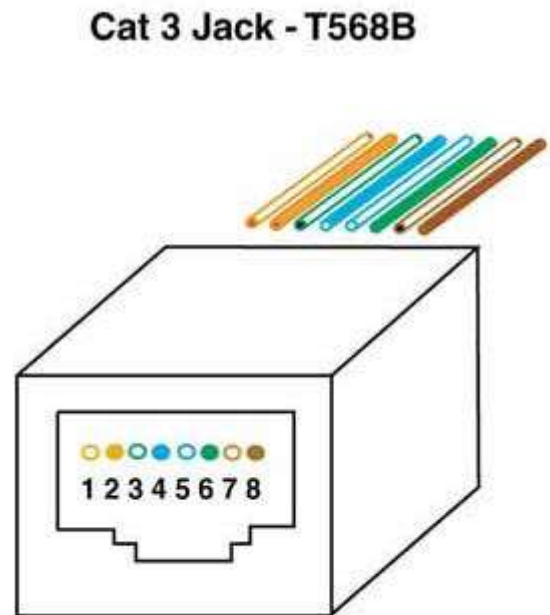
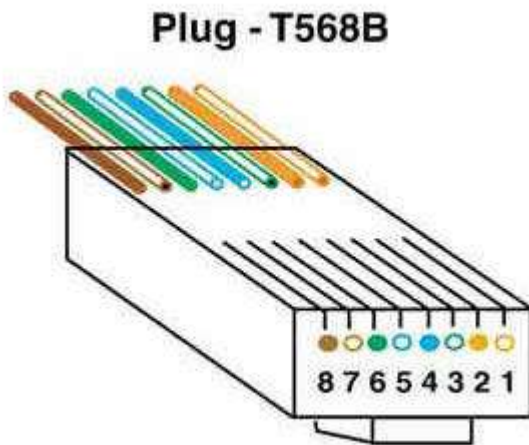
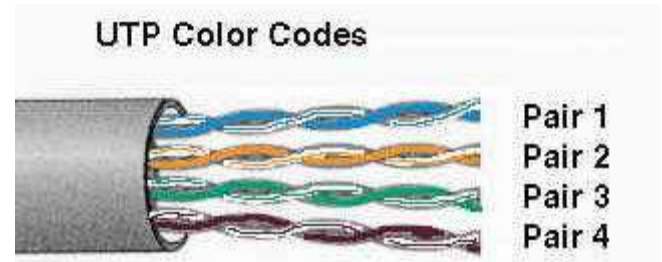

Jacks usually have punchdowns on the back or can be terminated without punchdowns using special manufacturer's tools or even a cover for the connector. Again, you **MUST** keep the twists as close to the receptacle as possible to minimize crosstalk.

Note that Cat 3 jacks and all plugs are going to use these color codes. However, Cat 5 jacks have internal connections that continue the twists as close to the pins in the jacks as possible. Thus the pinout on the back of the jacks will not usually follow these layouts! Always follow the color codes on the back of the jacks to insure proper connections!

Crossover Cables:

Normal cables that connect a PC/NIC card to a hub are wired straight through. That is pin 1 is connected to pin 1, pin 2 to pin 2, etc. However, if you are simply connecting two PCs together without a hub, you need to use a crossover cable made by reversing pair 2 and 3 in the cable, the two pairs used for transmission by Ethernet. The easy way to make a crossover cable is to make one end to T568A color coding and the other end to T568B. Then the pairs will be reversed.

Punchdowns:

Punchdowns come in 4 varieties: 110, 66, Bix and Krone. Most popular for LANs is the 110 (on the left), for telcos it's the 66 (on the right), and the Bix and Krone are rare (price, proprietary designs, etc.)

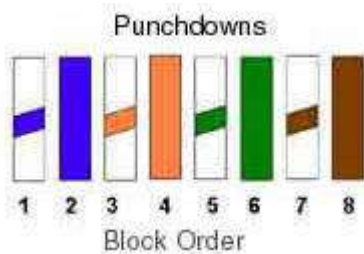
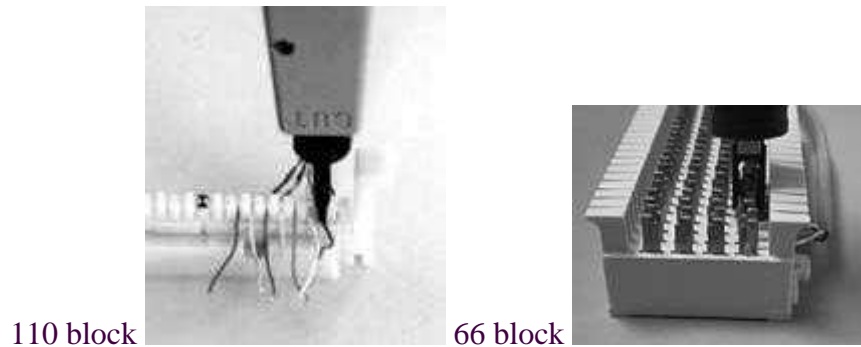

Color Codes For Punchdowns:

Punchdowns of all types are always made with the pairs in order with the white/stripe wire first, then the colored wire, Pair 1 (w/blue-blue), Pair 2 (w/orange-orange), Pair 3 (w/green-green), Pair 4 (w/brown-brown). (*This color code is remembered by **BLOG** - **BL**ue**O**range**G**reen and **br**own)*)

[Back to Design](#)